

# ALTO-SHAAM®

## Cook & Hold Oven Electronic Control



**Model:**

**300-TH/III**

**500-TH/III**

**750-TH/III**

**1000-TH/III**

**1200-TH/III**



1200-TH/III

1000-TH/III

750-TH/III



500-TH/III

300-TH/III

- **INSTALLATION**
- **OPERATION**
- **MAINTENANCE**

**HALO HEAT®**

**24•7**  
Your Service Hotline  
1-800-558-8744

W164 N9221 Water Street • P.O. Box 450 • Menomonee Falls, Wisconsin 53052-0450 USA  
PHONE: 262.251.3800 • 800.558.8744 USA/CANADA FAX: 262.251.7067 • 800.329.8744 U.S.A. ONLY  
www.alto-shaam.com

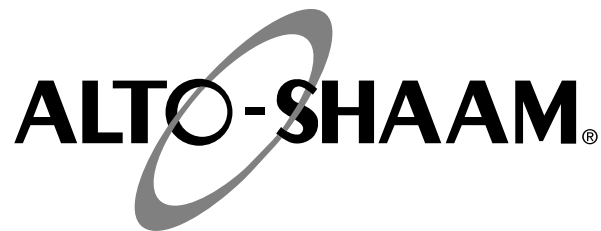

Delivery .....	1
Unpacking .....	1
Safety Procedures and Precautions .....	2

**Installation**

Installation Requirements .....	3
Clearance Requirements .....	3
Dimension Drawings, weights & capacities .....	4-8
Options and Accessories .....	9
Stacking Configurations .....	10
Leveling .....	11
Restraint Requirements - Mobile Equipment .....	11
Drip Tray Installation .....	12
Electrical Specifications .....	13-14

**Operating Instructions**

User Safety Information .....	15
Start-up Operation .....	15
Audible Signals .....	15
Control Features .....	16
Operating Features & Functions .....	17-18
Cook/Hold Instructions .....	19
To Cook/Hold Using Preset Menu Keys .....	19
Programming a Preset .....	20
Erasing a Preset .....	20
User Options .....	21
HACCP .....	22
General Holding Guidelines .....	23

**Care and Cleaning**

Protecting Stainless Steel Surfaces .....	24
Cleaning Agents .....	24
Cleaning Materials .....	24
Equipment Care .....	25
Clean Daily .....	26
Clean the Door Vents .....	26
Check Overall Condition of Oven .....	26
Daily Prong Cleaning .....	26

**Sanitation**

Sanitation/Food Safety .....	27
Internal Food Product Temperatures .....	27

**Service**

Trouble Shooting - Error Codes .....	28
Trouble Shooting Electrical Components .....	29
Exterior Service View & Parts .....	30-35
Electronic Components View & Parts .....	36-37
HACCP Data Logger Service Parts (option) .....	37
Cable Heating Kits .....	38

**Wire Diagrams**

Always refer to the wire diagram(s) included with the unit for most current version.

**Warranty**

Transportation Damage and Claims .....	Back Cover
Limited Warranty .....	Back Cover

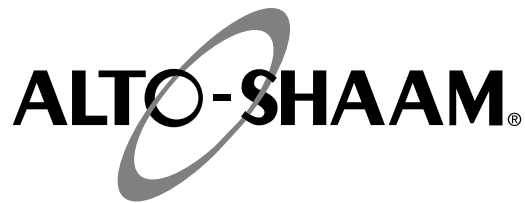

## DELIVERY

This Alto-Shaam appliance has been thoroughly tested and inspected to ensure only the highest quality unit is provided. Upon receipt, check for any possible shipping damage and report it at once to the delivering carrier. *See Transportation Damage and Claims section located in this manual.*

This appliance, complete with unattached items and accessories, may have been delivered in one or more packages. Check to ensure that all standard items and options have been received with each model as ordered.

Save all the information and instructions packed with the appliance. Complete and return the warranty card to the factory as soon as possible to ensure prompt service in the event of a warranty parts and labor claim.

This manual must be read and understood by all people using or installing the equipment model. Contact the Alto-Shaam Tech Team Service Department if you have any questions concerning installation, operation, or maintenance.

**NOTE:** All claims for warranty must include the full model number and serial number of the unit.

## UNPACKING

1. Carefully remove the appliance from the carton or crate.

**NOTE:** Do not discard the carton and other packaging material until you have inspected the unit for hidden damage and tested it for proper operation.

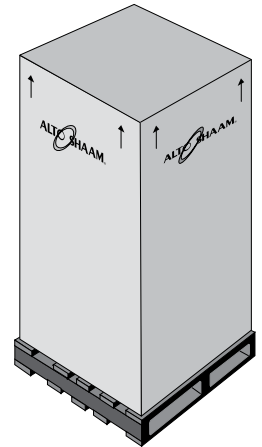

2. Read all instructions in this manual carefully before initiating the installation of this appliance.

**DO NOT DISCARD THIS MANUAL.**

This manual is considered to be part of the appliance and is to be provided to the owner or manager of the business or to the person responsible for training operators. *Additional manuals are available from the Alto-Shaam Tech Team Service Department.*

3. Remove all protective plastic film, packaging materials, and accessories from the appliance before connecting electrical power. Store any accessories in a convenient place for future use.

## SAFETY PROCEDURES AND PRECAUTIONS

Knowledge of proper procedures is essential to the safe operation of electrically and/or gas energized equipment. In accordance with generally accepted product safety labeling guidelines for potential hazards, the following signal words and symbols may be used throughout this manual.

### DANGER



Used to indicate the presence of a hazard that **WILL** cause severe personal injury, death, or substantial property damage if the warning included with this symbol is ignored.

### WARNING



Used to indicate the presence of a hazard that **CAN** cause personal injury, possible death, or major property damage if the warning included with this symbol is ignored.

### CAUTION



Used to indicate the presence of a hazard that can or will cause minor or moderate personal injury or property damage if the warning included with this symbol is ignored.

### CAUTION

Used to indicate the presence of a hazard that can or will cause minor personal injury, property damage, or a potential unsafe practice if the warning included with this symbol is ignored.

**NOTE:** Used to notify personnel of installation, operation, or maintenance information that is important but not hazard related.

1. This appliance is intended to cook, hold or process foods for the purpose of human consumption. No other use for this appliance is authorized or recommended.
2. This appliance is intended for use in commercial establishments where all operators are familiar with the purpose, limitations, and associated hazards of this appliance. Operating instructions and warnings must be read and understood by all operators and users.
3. Any troubleshooting guides, component views, and parts lists included in this manual are for general reference only and are intended for use by qualified technical personnel.
4. This manual should be considered a permanent part of this appliance. This manual and all supplied instructions, diagrams, schematics, parts lists, notices, and labels must remain with the appliance if the item is sold or moved to another location.

### NOTE

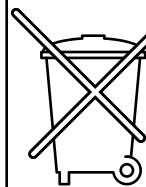

For equipment delivered for use in any location regulated by the following directive:

**DO NOT DISPOSE OF ELECTRICAL OR ELECTRONIC EQUIPMENT WITH OTHER MUNICIPAL WASTE.**

# INSTALLATION

## DANGER



IMPROPER INSTALLATION, ALTERATION, ADJUSTMENT, SERVICE, OR MAINTENANCE COULD RESULT IN SEVERE INJURY, DEATH, OR CAUSE PROPERTY DAMAGE.

READ THE INSTALLATION, OPERATING AND MAINTENANCE INSTRUCTIONS THOROUGHLY BEFORE INSTALLING OR SERVICING THIS EQUIPMENT.

## CAUTION



METAL PARTS OF THIS EQUIPMENT BECOME EXTREMELY HOT WHEN IN OPERATION. TO AVOID BURNS, ALWAYS USE HAND PROTECTION WHEN OPERATING THIS APPLIANCE.

## CAUTION



TO PREVENT PERSONAL INJURY, USE CAUTION WHEN MOVING OR LEVELING THIS APPLIANCE.



## DANGER



DO NOT store or use gasoline or other flammable vapors or liquids in the vicinity of this or any other appliance.

## SITE INSTALLATION

The Alto-Shaam cook and hold oven must be installed in a location that will permit the oven to function for its intended purpose and to allow adequate clearance for ventilation, proper cleaning, and maintenance access.

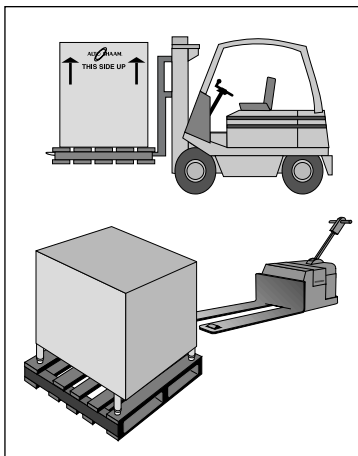

Emissions testing conducted by Underwriters Laboratories, Inc.® was found to be in compliance with the applicable requirements of NFPA96: 2004 Edition, Par. 4.1.1.2. U.L emissions sampling of grease laden vapor resulted in a total of 0.55 milligrams per cubic meter with no visible smoke and is considered representative of all oven models in the line. Based on these results, hood installation and/or outside venting should not be a requirement in most areas. Verify local codes for locations where more restrictive codes are applicable.

1. The oven must be installed on a stable and level surface.
2. **DO NOT** install this appliance in any area where it may be affected by any adverse conditions such as steam, grease, dripping water, high temperatures, or any other severely adverse conditions.
3. **DO NOT** store or use any flammable liquids or allow flammable vapors in the vicinity of this oven or any other appliance.
4. This appliance must be kept free and clear of any combustible materials.
5. This appliance must be kept free and clear of any obstructions blocking access for maintenance or service.

### CLEARANCE REQUIREMENTS

18" (457mm) minimum clearance at the back from heat producing equipment. To protect the electronic control, maintain sufficient side clearance to prevent the control area from reaching any temperature at or above 140°F (60°C).

## NOTE

If the appliance has been unplugged for an extended period of time, the Real Time Clock may require recharging. Turn main breaker to the unit off for 10 seconds and then restore power. For more information, see Error Code E-60 in the Troubleshooting section of this manual.

# INSTALLATION

## SITE INSTALLATION

### 300-TH/III

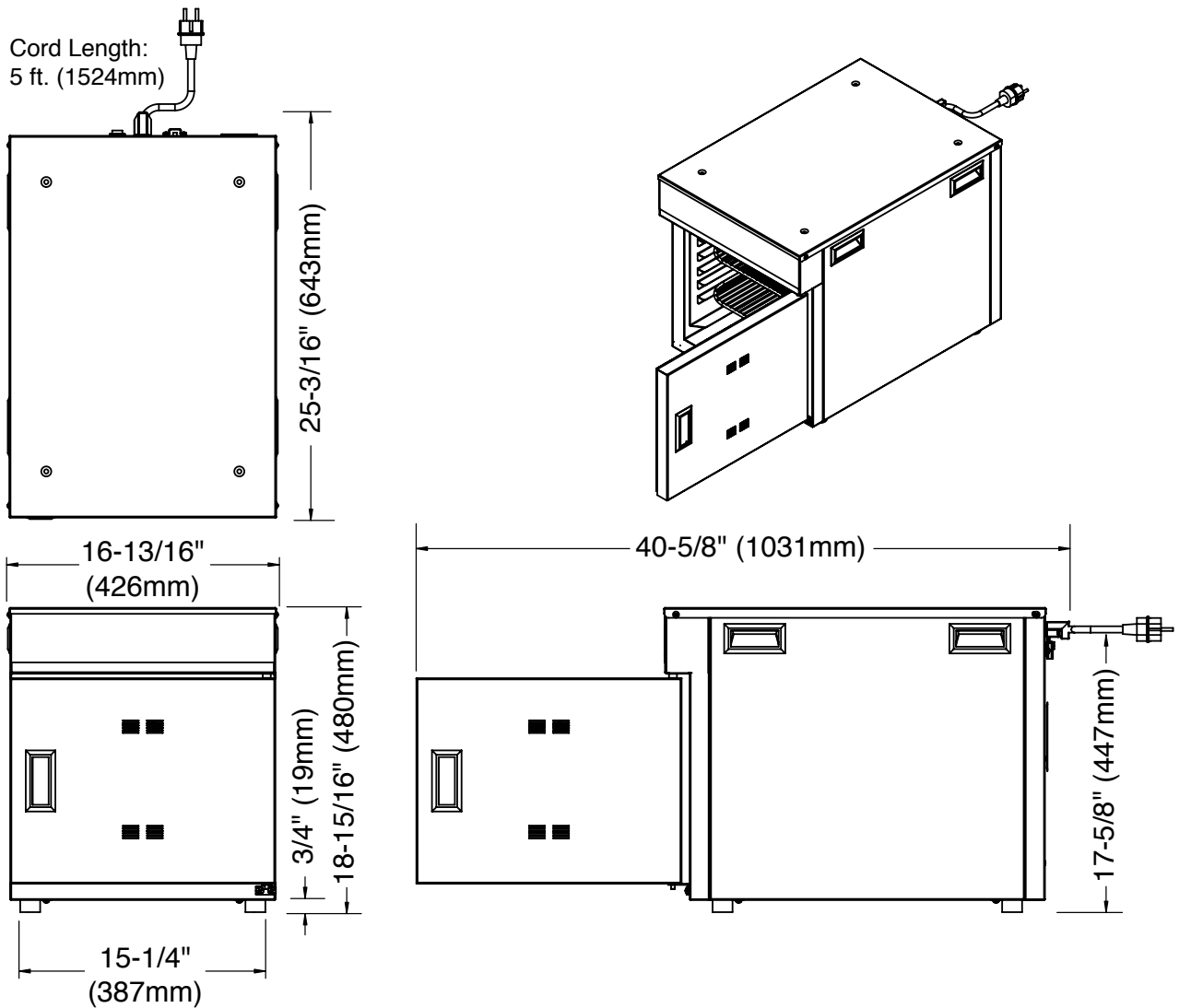

WEIGHT	PRODUCT CAPACITY
<p>NET: 69 lb (31 kg)</p> <p>SHIP: CONTACT FACTORY</p>	<p>36 lb (16 kg) MAXIMUM</p> <p>VOLUME MAXIMUM: 22.5 QUARTS (28,5 LITERS)</p>

# INSTALLATION

## SITE INSTALLATION

### 500-TH/III

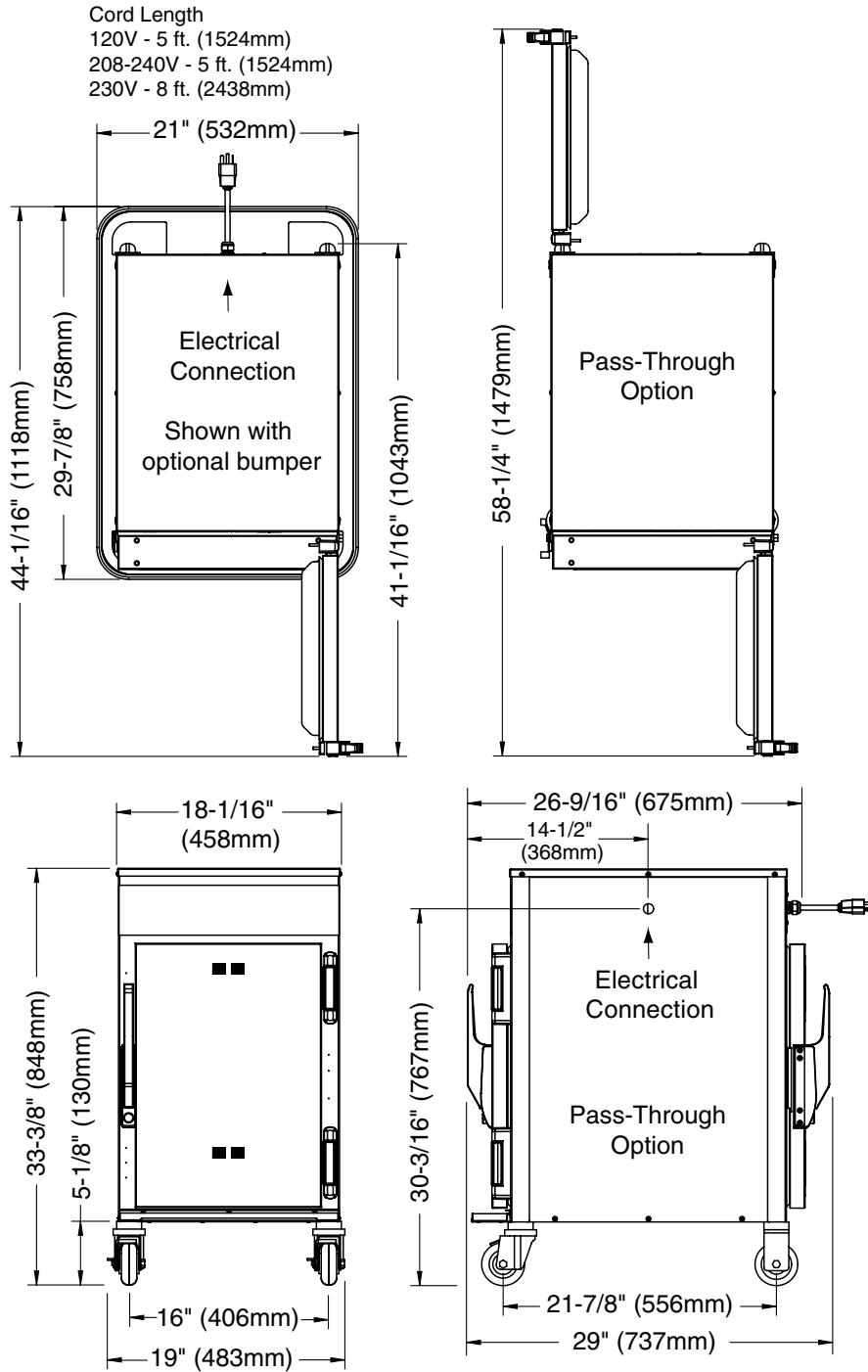

\*31-11/16" (804mm) - with optional 2-1/2" casters

\*35-5/16" (897mm) - with optional 5" casters

\*33-7/8" (860mm) - with optional 6" legs

WEIGHT	PRODUCT/PAN CAPACITY
NET: 140 lb (64 kg)	40 lb (18 kg) MAXIMUM
SHIP: 180 lb (82 kg)	VOLUME MAXIMUM: 30 QUARTS (38 LITERS)

# INSTALLATION

## SITE INSTALLATION

### 750-TH/III

Cord Length  
208-240V - 5 ft. (1524mm)  
230V - 8 ft. (2438mm)

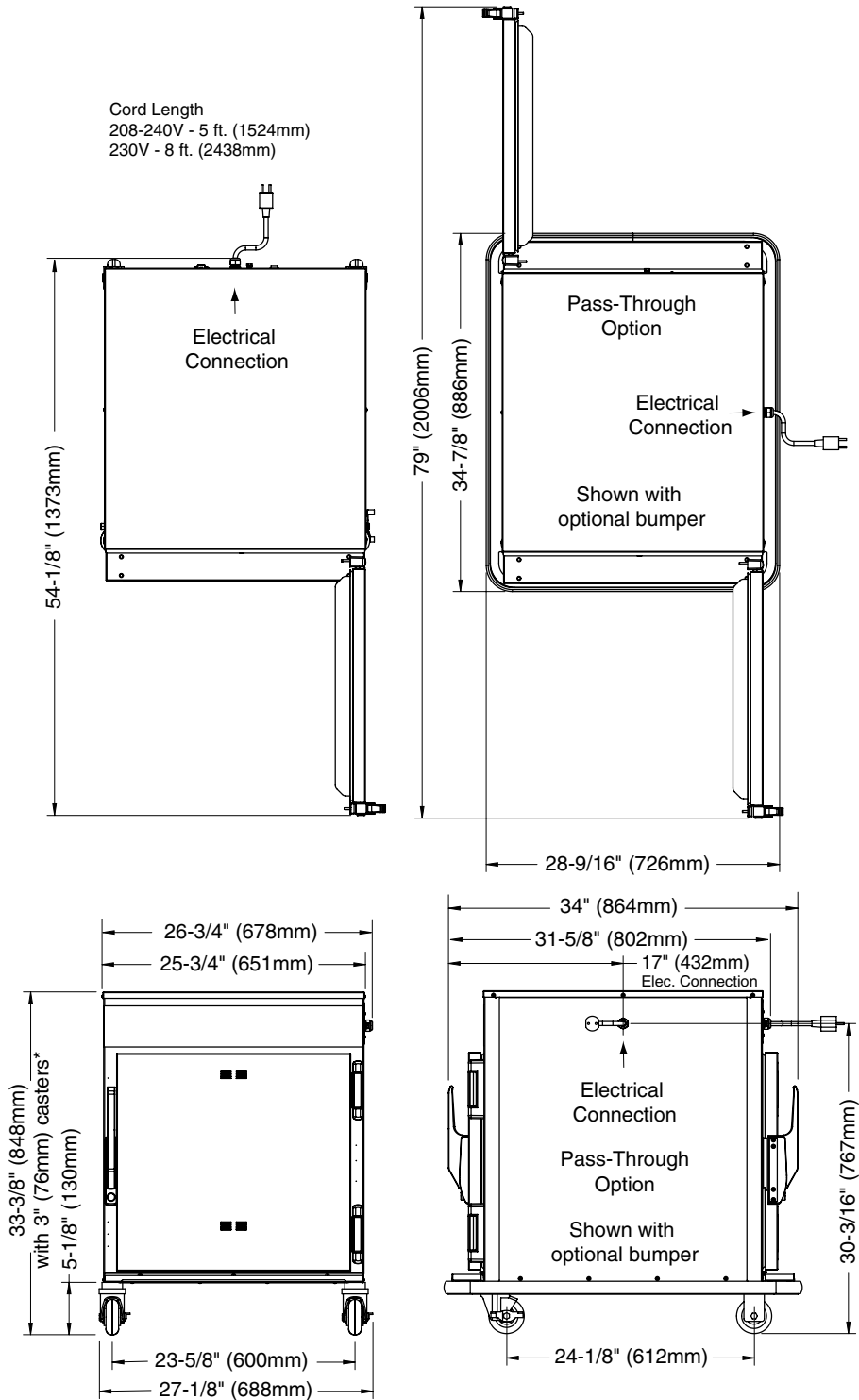

- \*32-1/2" (826mm) - with optional 2-1/2" casters
- \*35-1/4" (894mm) - with optional 5" casters
- \*33-3/4" (857mm) - with optional 6" legs

WEIGHT	PRODUCT\PAN CAPACITY
NET: 192 lb (87 kg) EST.	100 lb (45 kg) MAXIMUM
SHIP: 260 lb (118 kg)	VOLUME MAXIMUM: 75 QUARTS (95 LITERS)



# INSTALLATION

## SITE INSTALLATION

### 1000-TH/III

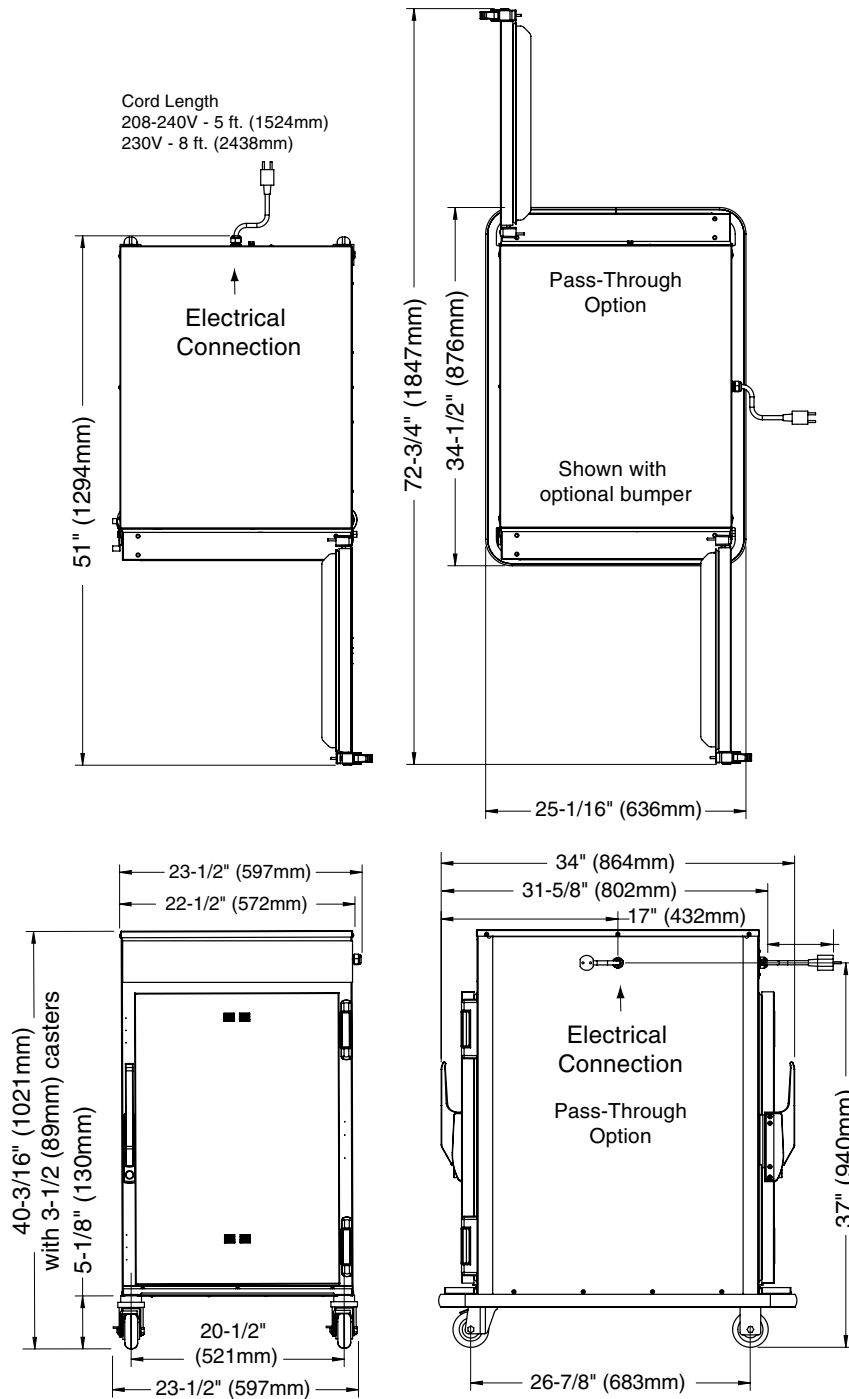

Cord Length  
208-240V - 5 ft. (1524mm)  
230V - 8 ft. (2438mm)

- \*38-5/8" (981mm) - with optional 2-1/2" casters
- \*42" (1067mm) - with optional 5" casters
- \*41-7/8" (1063mm) - with optional 6" legs

WEIGHT	PRODUCT\PAN CAPACITY
NET: 230 lb (104 kg) EST.	120 lb (54 kg) MAXIMUM
SHIP: 275 lb (125 kg)	VOLUME MAXIMUM: 60 QUARTS (76 LITERS)

# INSTALLATION

## SITE INSTALLATION

### 1200-TH/III

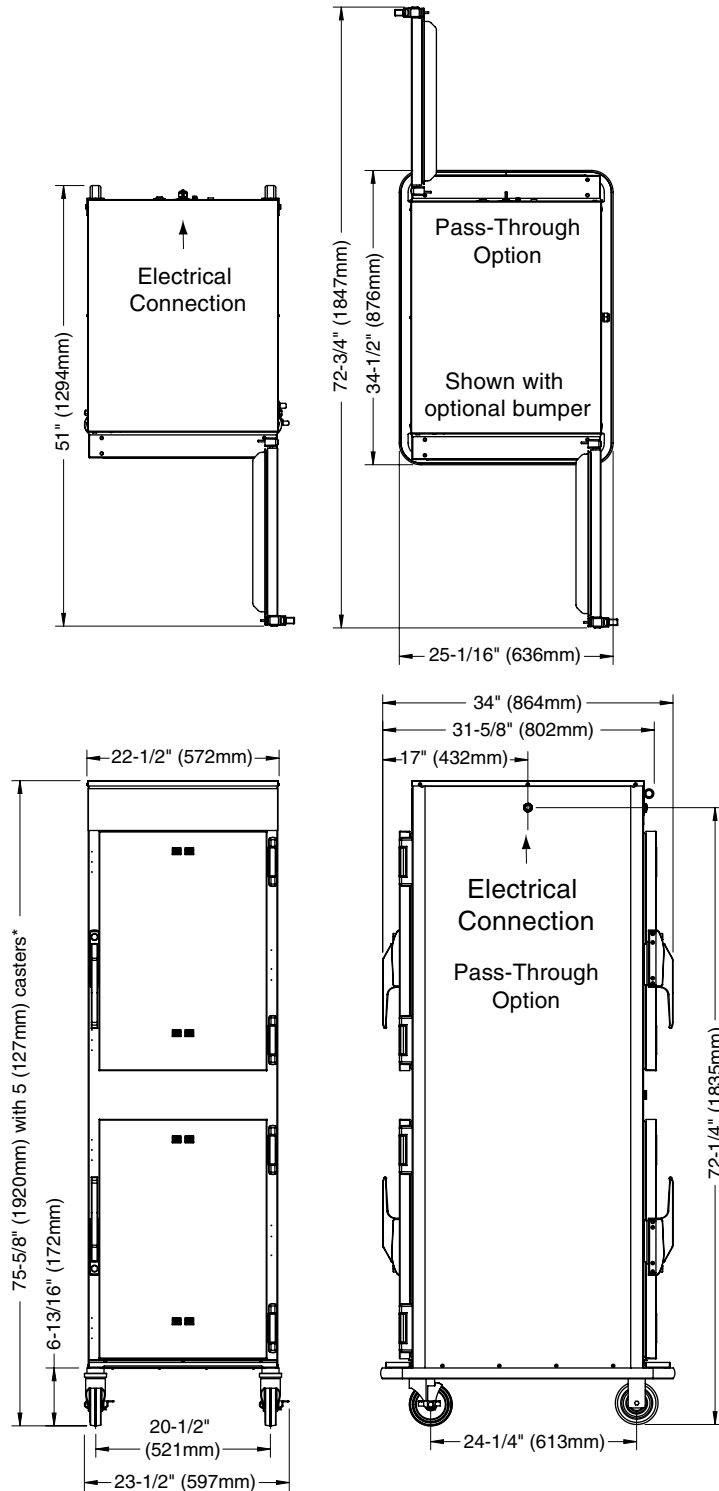

\*73-7/8" (1877mm) - with optional 3-1/2" casters  
 \*74-11/16" (1897mm) - with optional 6" legs

WEIGHT	PRODUCT\PAN CAPACITY (PER COMPARTMENT)
NET: 402 lb (182 kg) EST.	120 lb (54 kg) MAXIMUM
SHIP: 432 lb (196 kg)	VOLUME MAXIMUM: 60 QUARTS (76 LITERS)

# INSTALLATION

OPTIONS AND ACCESSORIES	300-TH/III	500-TH/III	750-TH/III	1000-TH/III	1200-TH/III
Bumper, Full Perimeter (NOT AVAILABLE WITH 2-1/2" CASTERS)	—	5011161	5010371	5009767	5009767
Carving Holder PRIME RIB STEAMSHIP (CAFETERIA) ROUND	HL-2635	HL-2635 4459	HL-2635 4459	HL-2635 4459	HL-2635 4459
Casters - 2 RIGID, 2 SWIVEL W/BRAKE 5" (127mm) 3-1/2" (89mm) 3" (76mm) 2-1/2" (64mm)	— — 5015323 —	5004862 STANDARD — 5008022	5004862 STANDARD — 5008022	5004862 STANDARD — 5008022	5004862 STANDARD — —
Door Lock with Key	—	LK-22567	LK-22567	LK-22567	LK-22567
Drip Pan WITH DRAIN WITHOUT DRAIN EXTRA DEEP	— — PN-2122	14813 11898 —	14831 11906 —	5005616 11906 15929	5005616 11906 15929
HACCP Data Logger (FACTORY INSTALLED)	5015563	5015563	5015563	5015563	5015563
Legs, 6" (152mm), Stemmed (SET OF FOUR)	—	5011149	5011149	5011149	5011149
Pan Grid, Wire - 18" x 26" PAN INSERT	—	—	PN-2115	PN-2115	PN-2115
Security Panel with key lock	—	5013939	5013936	5013934	5013934
Shelves FLAT WIRE, REACH-IN FLAT WIRE, PASS-THROUGH RIB RACK	SH-2107 — —	SH-2326 — —	SH-2324 SH-2327 SH-2743	SH-2325 SH-2346 SH-29474	SH-2325 SH-2346 SH-29474
Stacking Hardware	—	5004864	5004864	5004864	—

# INSTALLATION

## STACKING INSTRUCTIONS

- 1) If the two appliances were shipped together from the factory, the top unit will have the casters already removed. A stacking kit will be included with the shipment.**

If casters need to be removed: lay the unit on its back, and remove the set screw on each caster. Pull the casters out of the unit.

- 2) While appliance is laid on its back, insert one stacking post in each of the four corners of the upper unit. Secure the stacking posts using one screw and two flat washers that come with the stacking kit.**

**Note:** The flange on the stacking posts must face the outside of the unit.

- 3) Remove the four top mounting screws from the lower unit. Place the upper appliance, which has the stacking posts installed, on top of the bottom unit. Center the top unit from front to back. Re-install the four screws through the flange of the four stacking posts.**

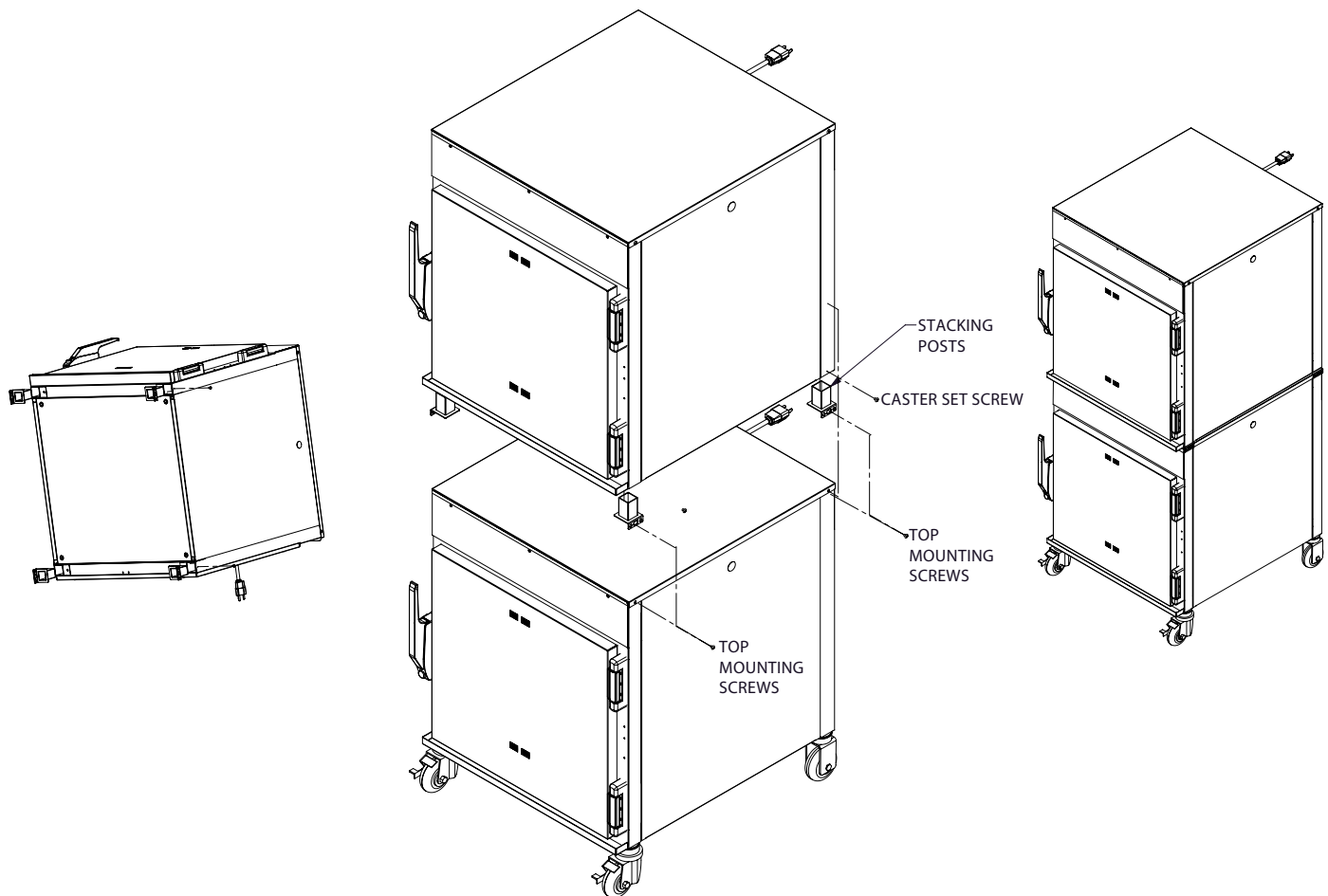

### Stacking Configurations

Model	Can be stacked with
300-TH/III	300-TH/III or 300-S No Stacking Hardware needed. Align dimples at top and bottom of units. It is recommended that the legs be removed from the top unit before stacking.
500-TH/III	500-TH/III, 500-TH-II or 500-S
750-TH/III	750-TH/III, 750-TH-II, 750-S, 767-SK or 767-SK/III
1000-TH/III	1000-TH/III, 1000-SK/III, 1000-SK/II or 1000-S

# INSTALLATION

## SITE INSTALLATION

A number of adjustments are associated with initial installation and start-up. It is important that these adjustments be conducted by a qualified service technician. Installation and start-up adjustments are the responsibility of the dealer or user. These adjustments include but are not limited to thermostat calibration, door adjustment, leveling, electrical hook-up and installation of optional casters or legs.

### LEVELING

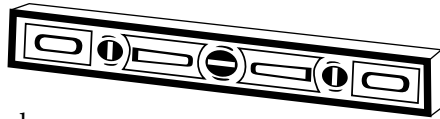

Level the oven from side-to-side and front-to-back with the use of a spirit level. For ovens installed with casters, it is important that the installation surface be level due to the probability of frequent oven repositioning.

We recommend checking the level of the oven periodically to make certain the floor has not shifted nor the oven moved.

**NOTE:** Failure to properly level this oven can cause improper function and will result in the uneven baking with products consisting of semi-liquid batter.

## RESTRAINT REQUIREMENTS —MOBILE EQUIPMENT

 <b>WARNING</b>	
	<b>RISK OF ELECTRIC SHOCK.</b> Appliance must be secured to building structure.

Any appliance that is not furnished with a power supply cord but that includes a set of casters must be installed with a tether. Adequate means must be provided to limit the movement of this appliance without depending on or transmitting stress to the electrical conduit. The following requirements apply:

1. Maximum height of casters is 6" (152mm).
2. Two of the casters must be the locking type.
3. Such mobile appliances or appliances on mobile stands must be installed with the use of a flexible connector secured to the building structure.

A mounting connector for a restraining device is located on the upper back flange of the appliance. A flexible connector is not supplied by nor is it available from the factory.

# INSTALLATION

## SITE INSTALLATION

### DRIP TRAY INSTALLATION INSTRUCTIONS - 500, 750, 1000, 1200

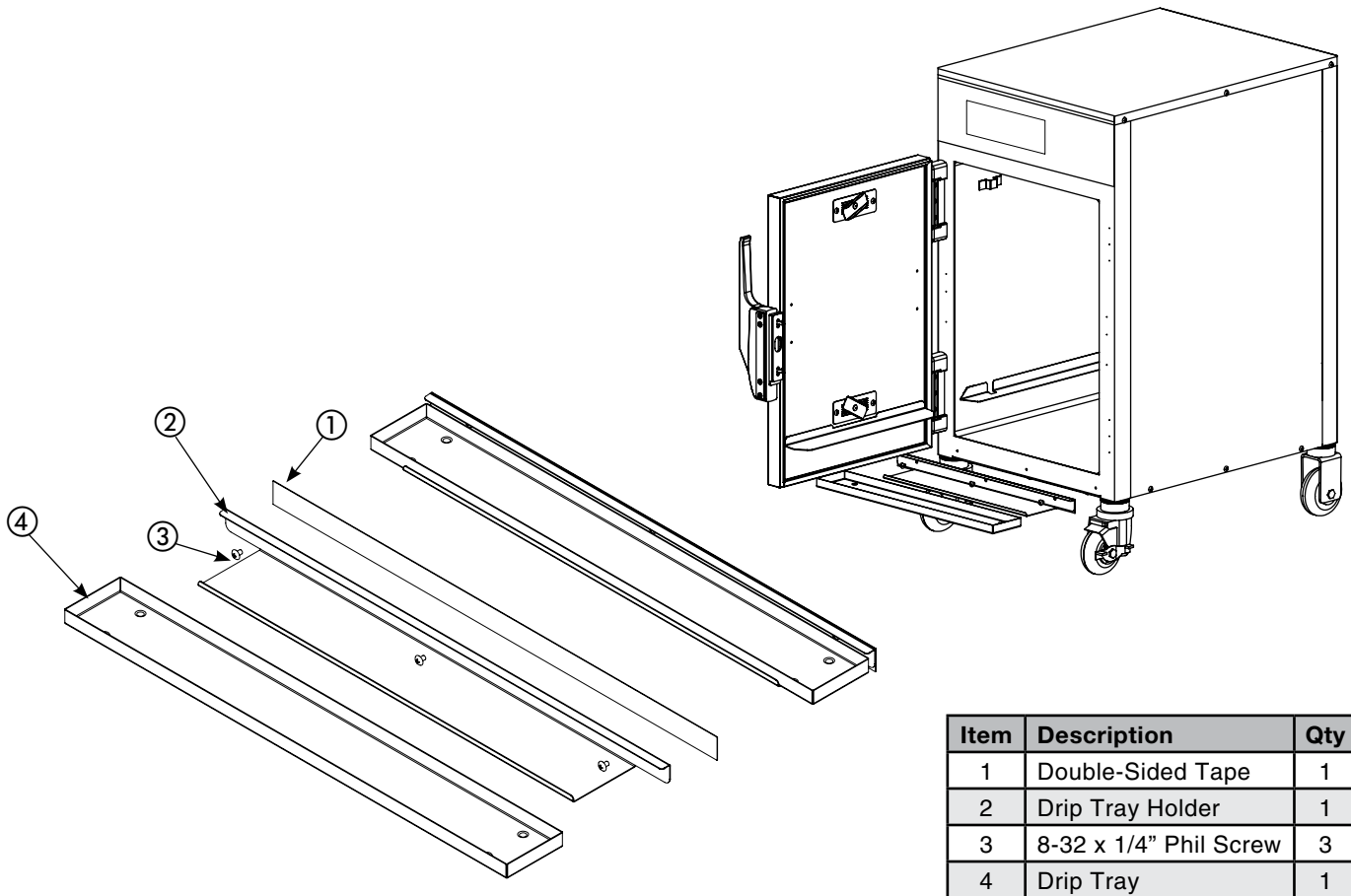

1. Poke holes through double-sided tape ① which is attached to the back of drip tray holder ②.
2. Remove backing on double-sided tape ①.
3. Put screws ③ through holes and attach drip tray holder ② to unit.
4. Optional, but strongly recommended - apply a line of food-grade silicone caulk along top edge of drip tray holder ② to seal.
5. Place drip tray ④ in drip tray holder ②.



## WARNING



**FAILURE TO PROPERLY INSTALL THE DRIP TRAY CAN OR WILL CAUSE MAJOR EQUIPMENT DAMAGE AND WILL RESULT IN A LEAKAGE HAZARD THAT CAN CAUSE PERSONAL INJURY.**



# INSTALLATION



## ELECTRICAL CONNECTION

The appliance must be installed by a qualified service technician. The oven must be properly grounded in accordance with the National Electrical Code and applicable local codes.

Plug the unit into a properly grounded receptacle ONLY, positioning the unit so that the plug is easily accessible in case of an emergency. Arcing will occur when connecting or disconnecting the unit unless all controls are in the "OFF" position.

Proper receptacle or outlet configuration or permanent wiring for this unit must be installed by a licensed electrician in accordance with applicable local electrical codes.

<b>DANGER</b>	
	<b>To avoid electrical shock, this appliance MUST be adequately grounded in accordance with local electrical codes or, in the absence of local codes, with the current edition of the National Electrical Code ANSI/NFPA No. 70. In Canada, all electrical connections are to be made in accordance with CSA C22.1, Canadian Electrical Code Part 1 or local codes.</b>
	

<b>DANGER</b>	
	<b>ENSURE POWER SOURCE MATCHES VOLTAGE IDENTIFIED ON APPLIANCE RATING TAG.</b>
	

### REGARDING INTERNATIONAL STANDARD UNITS:

If the unit is not equipped with flexible cord and plug, an all-pole country approved disconnection device which has a contact separation of at least 3mm in all poles must be incorporated in the fixed wiring for disconnection. When using a cord without a plug, the green/yellow conductor shall be connected to the terminal which is marked with the ground symbol. If a plug is used, the socket outlet must be easily accessible. If the power cord needs replacement, use a similar one obtained from the distributor.

**For CE approved units:** To prevent an electrical shock hazard between the appliance and other appliances or metal parts in close vicinity, an equalization-bonding stud is provided. An equalization bonding lead must be connected to this stud and the other appliances / metal parts to provide sufficient protection against potential difference. The terminal is marked with the following symbol.





### Hard wired models:

Hard wired models must be equipped with a country certified external allpole disconnection switch with sufficient contact separation.



If a power cord is used for the connection of the product an oil resistant cord like H05RN or H07RN or equivalent must be used.



**NOTE:** Where local codes and CE regulatory requirements apply, appliances must be connected to an electrical circuit that is protected by an external GFCI outlet.

<b>DANGER</b>	
	<b>APPLIANCES WITH NO CORD PROVIDED BY FACTORY MUST BE EQUIPPED WITH A CORD OF SUFFICIENT LENGTH TO PERMIT THE APPLIANCE TO BE MOVED FOR CLEANING.</b>
	<b>ELECTRICAL CONNECTIONS MUST BE MADE BY A QUALIFIED SERVICE TECHNICIAN IN ACCORDANCE WITH APPLICABLE ELECTRICAL CODES.</b>

# INSTALLATION

## ELECTRICAL

<b>300-TH/III</b>						
VOLTAGE	PHASE	CYCLE/HZ	AMPS	kW		CORD & PLUG
120	1	60	6.7	.80		NEMA 5-15P 15A-125V PLUG
230	1	50/60	2.7	.62		CEE 7/7 220-230V PLUG

<b>500-TH/III</b>						
VOLTAGE	PHASE	CYCLE/HZ	AMPS	kW		CORD & PLUG
120	1	60	16.0	1.9		NEMA 5-20P 20A-125V PLUG
208	1	60	11.2	2.7		CORD,
240	1	60	12.5	3.0		NO PLUG
230	1	50/60	12.0	2.8		CEE 7/7 220-230V PLUG

<b>750-TH/III</b>						
VOLTAGE	PHASE	CYCLE/HZ	AMPS	kW		CORD & PLUG
208	1	60	14.0	2.9		CORD,
240	1	60	16.0	3.9		NO PLUG
230	1	50/60	12.2	2.8		CEE 7/7 220-230V PLUG

<b>1000-TH/III</b>						
VOLTAGE	PHASE	CYCLE/HZ	AMPS	kW		CORD & PLUG
208	1	60	14.0	2.9		CORD,
240	1	60	16.0	3.9		NO PLUG
230	1	50/60	12.2	2.8		CEE 7/7 220-230V PLUG

<b>1200-TH/III</b>						
VOLTAGE	PHASE	CYCLE/HZ	AMPS	kW		CORD & PLUG
208	1	60	29.0	6.1		NO CORD
240	1	60	33.3	8.0		OR PLUG
230	1	50/60	28.7	6.6		NO CORD OR PLUG

<b>1200-TH/III - UK ONLY</b>						
VOLTAGE	PHASE	CYCLE/HZ	AMPS	kW		CORD & PLUG
230	1	50/60	21.5	4.9		NO CORD OR PLUG

Wire diagrams are located inside the bonnet of the unit.



# OPERATION

## USER SAFETY INFORMATION

### CAUTION



**METAL PARTS OF THIS EQUIPMENT BECOME EXTREMELY HOT WHEN IN OPERATION. TO AVOID BURNS, ALWAYS USE HAND PROTECTION WHEN OPERATING THIS APPLIANCE.**

The Alto-Shaam cook and hold oven is intended for use in commercial establishments by qualified operating personnel where all operators are familiar with the purpose, limitations, and associated hazards of this appliance. Operating instructions and warnings must be read and understood by all operators and users.

## START-UP OPERATION

### BEFORE INITIAL USE:

Interior oven surfaces must be heated to remove surface oils and the accompanying odor produced during the first use of the oven.

1. Wipe all wire shelves, side racks and the full oven interior with a clean, damp cloth. Install the oven side racks, oven shelves, and external drip tray. Shelves are installed with the curved edge toward the back of the oven. Insert the drip pan on the interior bottom surface of the oven.
2. • Close the oven doors  
• Press and release control ON/OFF key.  
• Press the COOK key.  
• Press the up and down arrows to set the cooking temperature to 300°F (149°C).
3. • Press the TIME key.  
• Press the up and down arrows to set the cooking time to approximately 2 hours.  
• Allow the oven to cycle for approximately 2 hours or until no odor is detected.

### DANGER



**AT NO TIME SHOULD THE INTERIOR OR EXTERIOR BE STEAM CLEANED, HOSED DOWN, OR FLOODED WITH WATER OR LIQUID SOLUTION OF ANY KIND. DO NOT USE WATER JET TO CLEAN.**



**SEVERE DAMAGE OR ELECTRICAL HAZARD COULD RESULT.**

**WARRANTY BECOMES VOID IF APPLIANCE IS FLOODED**



### DANGER



**DISCONNECT UNIT FROM POWER SOURCE BEFORE CLEANING OR SERVICING.**

## AUDIBLE SIGNALS

*OVEN BEEPING* indicates a response, mode changes, and error conditions.

*One brief beep* - response to a key being pressed.

*Two brief beeps* - informative beep that indicates that something has been changed, such as the user entering a volume change, entering a temperature scale change, etc.

*Three brief beeps* - indicates the oven is done preheating, the probe has exceeded set-point in cold smoking, the door has been open too long, or the control is unlocked.

*Four brief beeps* - indicates an error. Refer to the Trouble Shooting section of this manual.



# OPERATION

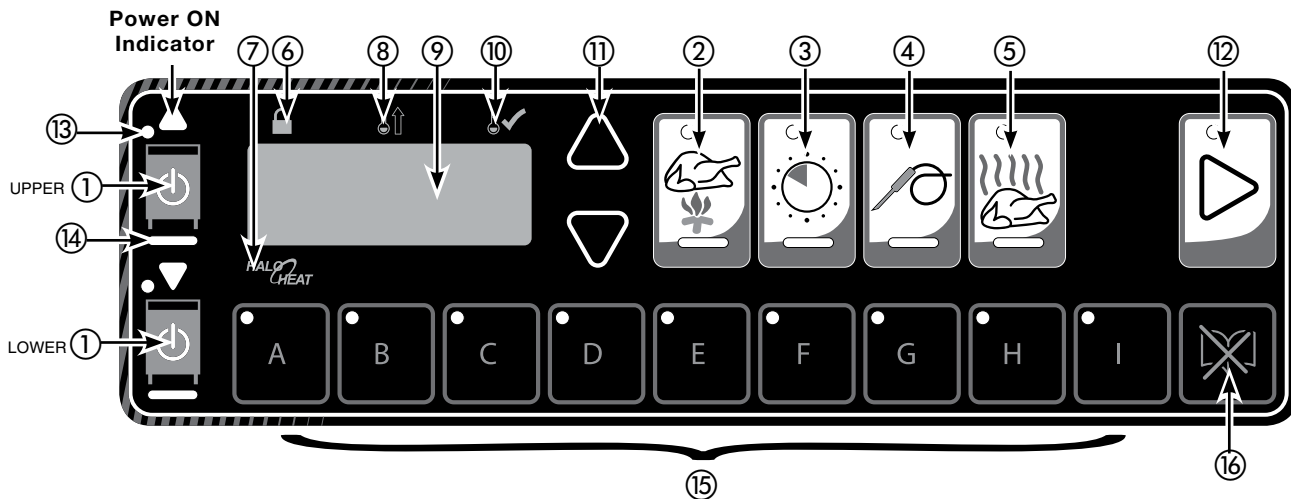

## CONTROL FEATURES

### 1. On/Off Key

The on/off control system key operates the functions of the control panel. If there is any power loss during operation, the on/off indicator light will flash. To clear, push key and release.

### 2. Cook Key — Temperature range 200° to 325°F (93° to 162°C)

Used to select cooking mode and to review the cook temperature setting.

### 3. Time Key — Maximum time 24 hours

Used to select cook time and to review set time.

### 4. Probe Key — Temperature range 50° to 195°F (10° to 91°C)

Used to select internal product probe temperature mode and to review probe temperature setting.

### 5. Hold Key — Temperature range 60° to 205°F (15° to 96°C)

Used to select food holding mode and to review set holding temperature.

### 6. Lock Indicator

When illuminated, this symbol indicates settings used in the cooking sequence are locked and cannot be changed.

### 7. Halo Heat Indicator

When the oven is preheating, the Halo Heat indicator will illuminate during preheating and remain steady until the oven reaches the set cooking temperature. When the temperature has stabilized, the indicator will illuminate periodically as the oven calls for heat.

### 8. Oven Preheat Light

Illuminates until the oven is preheated or in ready mode.

### 9. LED Display

Indicates interior oven air temperature, internal product probe temperature, time, or when used in conjunction with other keys, will review original cooking, holding and probe temperature settings. The display will also indicate various programming and diagnostic information.

### 10. Ready Indicator Light

Illuminates when the oven has finished preheating.

### 11. Up and Down Arrows

Used to increase or decrease set time, including cooking, holding and probe temperature settings.

### 12. Start Key

Used to initiate a selected mode sequence when *pressed and released*. You may stop any mode of operation by *pressing and holding* the Start Key until you hear a 2 second beep.

### 13. Green Indicator Lights

Located within each function key, the green light functions as an operator prompt indicating additional operator action is required and also identifies current mode of operation.

### 14. Amber Indicator Lights

Located below the Cook, Time, Probe and Hold Keys, these indicators will illuminate to identify the current mode of operation and allows the operator to identify the information currently shown in the LED display.

### 15. Preset Program Keys

Provides memory storage and operation of up to eight operator set cooking programs for specific products (A thru H). I enables locking abilities.

### 16. Cancel Key

Used to erase a program from memory storage.

## IMPORTANT

**Do not use the oven if the controls are not properly functioning. Refer to the Troubleshooting Guide located in this manual or call an authorized service technician.**

# OPERATION

## OPERATING FEATURES & FUNCTIONS

---

### To stop an operation at any time :

Press and hold the **START** Key until the control beeps for two seconds, indicating the operation has been cancelled. The oven will remain in a power-on state.

---

### To turn oven control panel off:

Press and hold the **ON/OFF** Key until the oven beeps. The **ON/OFF** indicator light will go out.

---

### Door open indicator:

Display will flash "door" and a triple beep will alert the user. Press **ON/OFF** key to acknowledge error and disable triple beep.

---

### Arrow Keys:

**Cook, Hold and Probe** Temperature, and the **Time** setting can be adjusted by pressing the **Arrow** keys. Pressing and releasing the **Arrow** key will change settings in increments of one. To change a setting more rapidly, press and hold the **Arrow** key. Once the setting reaches a number divisible by 10, it will begin to increase in increments of 10.

---

### Green and Amber Indicators:

Each program key includes a green light which indicates a requirement for additional programming by the operator or the current operational state of the oven.

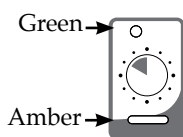

The **COOK**, **TIME**, **PROBE**, and **HOLD** keys include an amber indicator light to identify the information being displayed.

---

### Power Fail Detect:

If the power were to fail for any reason while heating, the control will retain, in memory, the programmed operating conditions. When power is restored, the control will resume operating from the point where it was interrupted and the **ON/OFF** indicator light will flash, indicating that such an event did occur. The operator can acknowledge the power failure by pressing the **ON/OFF** key. Pressing the key will display the amount of time that the power has been off. The control will stop counting the amount of time the power has been off when it has been off for more than 24 hours.

**NOTE:** *If such an event has occurred, it is strongly recommended that you ensure the food is safe for consumption according to local health regulations.*

---

### To set date and time:

All oven cavities must be turned OFF.

**To set Year** - press and hold "A" Key for three seconds. Press UP/Down Arrow Key to set Year.

**To set Time (HH:mm)** - press and hold "B" Key for three seconds. Press UP/Down Arrow Key to set Time.

**To set month and day (MM.dd)** = press "C" Key for three seconds. Press UP/Down Arrow Key to set Month and Day.

# OPERATION

## OPERATING FEATURES & FUNCTIONS

---

### Display High/Low Probe Temperatures:

To observe the recorded maximum or minimum probe temperature when cooking by probe, press the following keys while the probe remains in the product:

**Highest Temperature:** Press PROBE Key and UP ARROW Key at same time.

**Lowest Temperature:** Press PROBE Key and DOWN ARROW Key at same time.

---

### Probe Usage:

When the oven probe remains inserted in the probe bracket, the LED temperature display will indicate the ambient air temperature inside the oven. To use the probe for cooking remove it from the bracket and wipe the full length of the metal probe with a disposable alcohol pad to clean and sanitize before using.

Only the tip of the probe senses the internal product temperature; therefore, it is important the tip be placed correctly in the product for internal temperature accuracy. Push the probe tip halfway into the product, positioning the tip at the center of the food mass. When inserting the probe into solid foods such as meat roast or poultry breasts, push the probe in from a straight downward position or in from the side to the center position. If placing into a semi-liquid or liquid product, the probe cable must be secured to keep the probe positioned properly. Do not let the probe tip touch the edges, bottom or side of a container. Tape the probe cable to the lip or edge of the container.

**NOTE:** When cooking by probe, insert the probe into the raw product after the oven has been preheated.

**WAIT ONE FULL MINUTE** to allow the probe temperature to decrease to the internal temperature of the product. Press the start button to begin the cooking process after this probe temperature adjustment period. A false probe reading of the internal product temperature will cause the oven to default to a holding temperature.

---

### Probe Calibration:

1. To verify product probe calibration, place the probe in a glass of ice water.
  2. After allowing the temperature to settle, press the probe key for five (5) seconds. Compare reading against 32°F (0°C).
  3. If calibration is required, the unit must be in the power up hold mode. From the off state turn the unit on. The unit will begin to operate in the power up hold mode, press the probe key for eight (8) seconds until the unit beeps twice and a temperature is displayed. Adjust the probe offset temperature by pressing the up or down arrows to increase or decrease the temperature. Repeat step 2 to verify.
  4. Repeat steps 1 and 2 to verify the probe calibration as necessary.
- 



### Sous Vide Cooking:



With the oven in a preheat mode, press and hold the probe button. After 5 seconds, it will display "SouS" if in sous-vide mode, or "rE9" if in a regular probe mode. If changes are desired, continue holding the probe button for an addition three seconds which will toggle the option.



# OPERATION



## Cook/Hold Instructions

 *Press and release control ON/OFF key.* The oven will beep for one second and power to the unit will be indicated by an illuminated green indicator light located in the upper left corner of the ON/OFF key. The oven will begin operating in the hold mode. The amber HOLD indicator will be illuminated and the last set hold temperature will be displayed.

   *To set Cook temperature* — Press COOK Key. Oven preheat indicator will illuminate and the last set cooking temperature is displayed. To change the cook temperature, press the UP or DOWN ARROW Keys.



   *If cooking by time* — press the TIME Key. The green TIME indicator will illuminate and the last set cooking time will be displayed. To change the set time, press the UP or DOWN ARROW Key. The display will alternate between the set temperature and the elapsed time.

   *If cooking by probe* — press the PROBE Key. The green PROBE indicator will illuminate and the last set internal product temperature will be displayed. To change the set temperature, press the UP or DOWN ARROW Key. The display will alternate between the set temperature, the elapsed time, and the probe temperature.

   *To set Hold temperature* — Press the HOLD Key. The green cook indicator light will remain illuminated. To change the hold temperature, press the UP or DOWN ARROW Key. The display will alternate between the set hold temperature and the amount of time the product has been in the hold mode. Oven will remain in the HOLD mode until the ON/OFF key is pressed.

 *Press START key to begin cooking cycle.*

## To Cook/Hold using Preset Menu Keys

  *Press Desired PRESET Key (A through H).* PRESET Keys with stored cooking programs will have green indicator illuminated. The oven will automatically enter preheat mode. Oven will beep periodically when it has reached a preheat ready state, and both the Ready and Start indicator lights will flash. To program a preset menu key, see **Programming a Preset** in this manual.

 *Press START key to begin cooking cycle.*

## CAUTION

TO MAINTAIN SAFE TEMPERATURE LEVELS, COLD FOOD FOR RETHERMALIZATION OR REHEATING MUST NEVER BE ADDED TO THE OVEN WHILE HOT FOODS ARE BEING HELD.

# OPERATION

## Programming a Preset



Select the product to be programmed and begin programming with the oven control power OFF.

*Press and release control ON/OFF key.* The oven will beep for one second and power to the unit will be indicated by an illuminated green indicator light located in the upper left corner of the ON/OFF key. The oven will begin operating in the hold mode. The amber HOLD indicator will be illuminated and the last set hold temperature will be displayed.

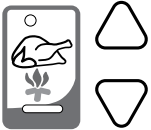

*To set Cook temperature* — Press COOK Key. Oven preheat indicator will illuminate and the last set cooking temperature is displayed. To change the cook temperature, press the UP or DOWN ARROW Keys.

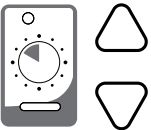

*If cooking by time* — press the TIME Key. The green TIME indicator will illuminate and the last set cooking time will be displayed. To change the set time, press the UP or DOWN ARROW Key. The display will alternate between the set temperature and the elapsed time.

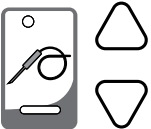

*If cooking by probe* — press the PROBE Key. The green PROBE indicator will illuminate and the last set internal product temperature will be displayed. To change the set temperature, press the UP or DOWN ARROW Key. The display will alternate between the set temperature, the elapsed time, and the probe temperature.

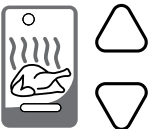

*To set Hold temperature* — Press the HOLD Key. The green cook indicator light will remain illuminated. To change the hold temperature, press the UP or DOWN ARROW Key. The display will alternate between the set hold temperature and the amount of time the product has been in the hold mode. Oven will remain in the HOLD mode until the ON/OFF key is pressed.



Select a letter code for the product programmed by the previous steps. Press and hold the selected PRESET key for two seconds. When the preset has been saved, you will hear a one second beep and the preset light will illuminate.



**Note:** Only one preset can be programmed at a time. If programming an additional preset is desired, the unit must be started and stopped either by cycling the power to the cavity or by pressing the START/STOP key. The last PRESET Key used will be the oven cooking run sequence for the next product to be programmed. Settings can be manually changed for the next product and an alternate pre-programmed letter key selected.

## Erasing a Preset

To erase a program, the oven must be in either the power-up hold mode or in the preheat mode. The oven cannot be running a PRESET Menu program.

When the oven is in the power-up hold mode or in the preheat mode, press and hold the CANCEL Key and then the appropriate letter PRESET Key to be erased for two seconds. When the preset has been erased the oven will beep for one second.

**IMPORTANT - After programming a specific product into memory in a programmable preset key, it is very important to make a written permanent record of the product and the program letter assigned. Menu card (PE-23384) is provided for this purpose.**

# OPERATION

## USER OPTIONS

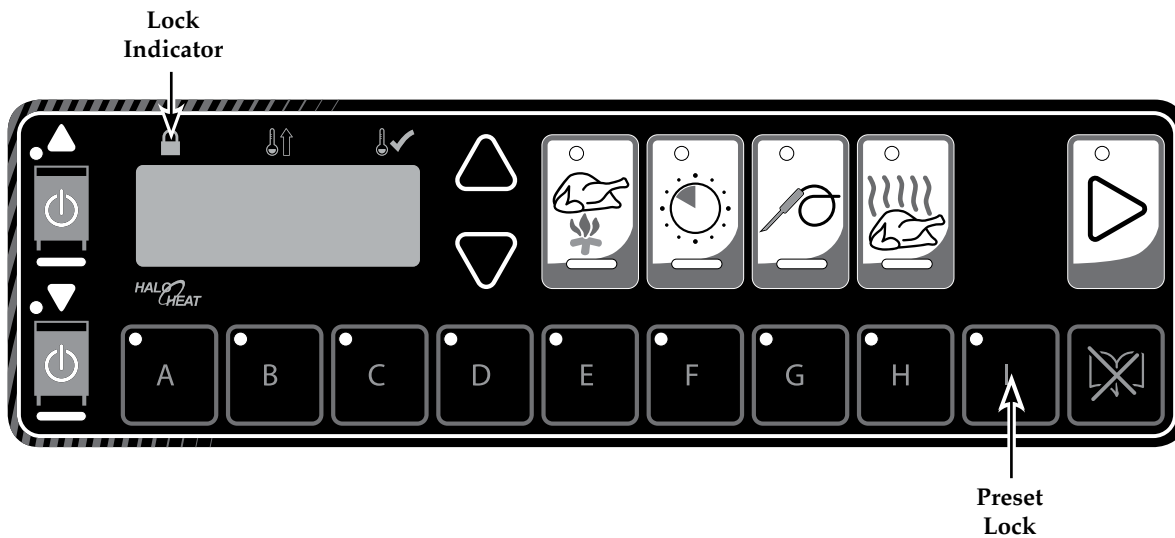

### PRESET Keys Lock and Unlock

PRESET Keys A through H can be locked in order to prevent storing, altering or erasing a program.

To lock the PRESET Keys, press and hold the "I" Key until the oven beeps. Release the "I" key. The green indicator on the "I" key will illuminate. Oven PRESET Keys A through H are now locked.

*Note:* Only the oven PRESET keys A through H are affected by this lock-out in order to also allow the oven to be used with the unprogrammed Cook, Probe, or Hold modes.

To unlock the PRESET Keys, press and hold the CANCEL Key along with the "I" Key for two seconds until the "I" key light no longer illuminates. Release all keys. The oven preset keys are now unlocked.

### Fahrenheit or Celsius Selection

With the control in the *off mode*, **press and hold** the UP ARROW Key until the display shows the current selection. Press the up or down buttons to toggle between the two options. After each change the button must be released. The display must clear before the procedure can be repeated.



### Control Panel Lock and Unlock

The control panel can be locked at any time in order to prevent inadvertent or accidental setting changes.

To lock the control panel, **press and hold** the UP ARROW Key and then press the ON/OFF Key. You will hear a brief beep and the panel lock indicator will illuminate. Release all keys. The oven's control panel is now locked.



*Note:* The control panel is now fully locked with the exception of the ON/OFF Key and ARROW keys. You will be unable to turn the oven control off at this point.

To unlock the control panel, **press and hold** the DOWN ARROW Key and then press the ON/OFF Key. You will hear three beeps and the panel lock indicator will extinguish. Release all keys. The panel is now unlocked and ready for normal use.

### Beeper Volume Selection

With the control in *the off mode*, **press and hold** the DOWN ARROW Key until the display shows one of the 4 volume levels (0 being OFF or the lowest, and 3 being the highest). After each change, the button must be released and the display must clear before the procedure can be repeated to select a different volume level. Turn the unit ON and then OFF again to store the desired set point.



# OPERATION

## HACCP

### HACCP Documentation, Data Logger - Optional

This oven meets the requirements of established HACCP criteria by providing automated sampling, record keeping, set-point validation, recipe used, dates and time. This data is retained for the last 30 days. This information can be viewed on screen or downloaded to a USB drive and then copied to your computer. The file format is a comma-separated variable (\*.csv), that is easily opened using a spreadsheet package.

#### To download the data collected:

1. All oven cavities must be turned OFF.
2. It is recommended that a completely empty USB flash drive is used. Remove the cap of the USB port located on the right side of the control panel and insert the USB flash drive. Display will show "Usb". If display does not show "Usb", try again with another flash drive device or call Alto-Shaam Service.
3. Press and hold the START Key until display shows "≡ XYZ". The number at the far right is the percentage of the download completed. The START Key indicator light will flash while the download is in process. When display shows "≡ 100", the download is complete.
4. Remove the USB flash drive and replace the cap on the USB port. When the USB is removed, the oven will beep for 1-second, acknowledging the removal.

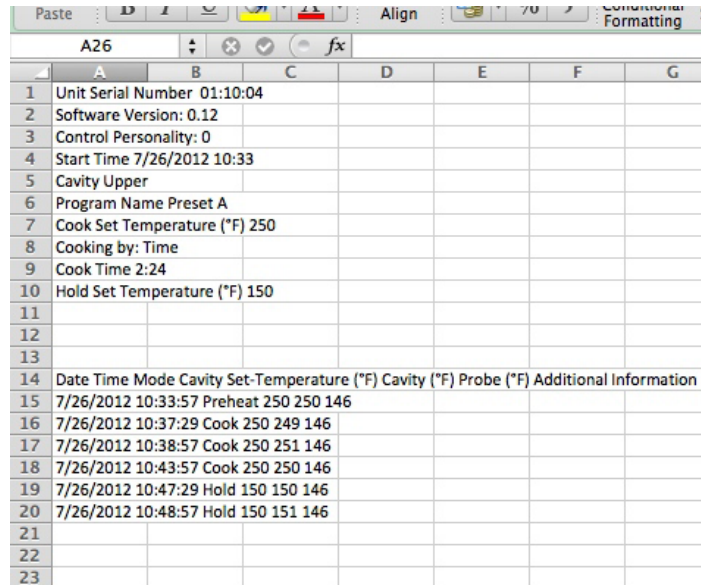

	A	B	C	D	E	F	G
1	Unit Serial Number	01:10:04					
2	Software Version:	0.12					
3	Control Personality:	0					
4	Start Time	7/26/2012 10:33					
5	Cavity Upper						
6	Program Name	Preset A					
7	Cook Set Temperature (°F)	250	250	146			
8	Cooking by:	Time					
9	Cook Time	2:24					
10	Hold Set Temperature (°F)	150					
11							
12							
13							
14	Date Time Mode Cavity Set-Temperature (°F) Cavity (°F) Probe (°F) Additional Information						
15	7/26/2012 10:33:57	Preheat	250	250	146		
16	7/26/2012 10:37:29	Cook	250	249	146		
17	7/26/2012 10:38:57	Cook	250	251	146		
18	7/26/2012 10:43:57	Cook	250	250	146		
19	7/26/2012 10:47:29	Hold	150	150	146		
20	7/26/2012 10:48:57	Hold	150	151	146		
21							
22							
23							

HACCP Data Sample

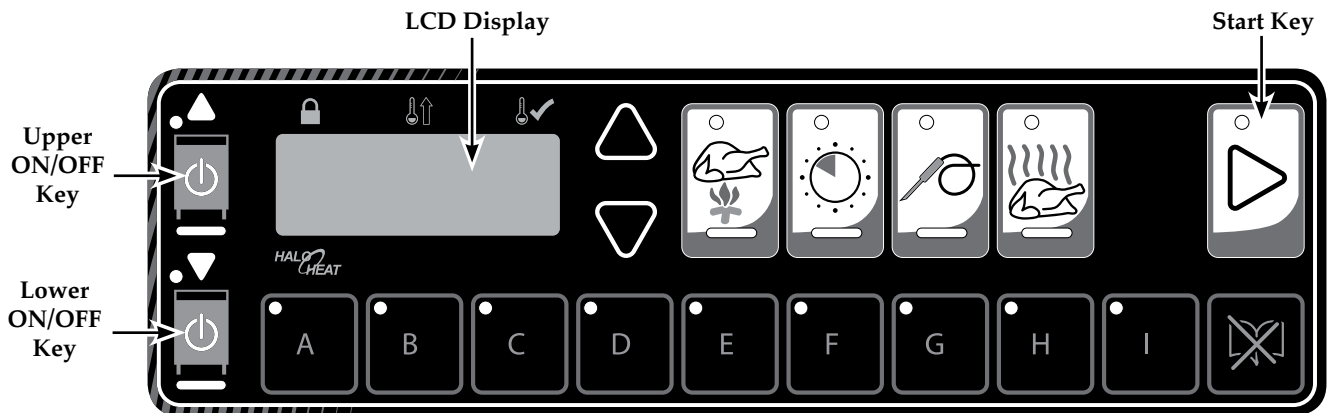



# OPERATION

## GENERAL HOLDING GUIDELINES

Chefs, cooks and other specialized food service personnel employ varied methods of cooking. Proper holding temperatures for a specific food product must be based on the moisture content of the product, product density, volume, and proper serving temperatures. Safe holding temperatures must also be correlated with palatability in determining the length of holding time for a specific product.

Halo Heat maintains the maximum amount of product moisture content without the addition of water, water vapor, or steam. Maintaining maximum natural product moisture preserves the natural flavor of the product and provides a more genuine taste. In addition to product moisture retention, the gentle properties of Halo Heat maintain a consistent temperature throughout the cabinet without the necessity of a heat distribution fan, thereby preventing further moisture loss due to evaporation or dehydration.

When product is removed from a high temperature cooking environment for immediate transfer into equipment with the lower temperature required for hot food holding, condensation can form on the outside of the product and on the inside of plastic containers used in self-service applications. Allowing the product to release the initial steam and heat produced by high temperature cooking can alleviate this condition. To preserve the safety and quality of freshly cooked foods, however, a maximum of 1 to 2 minutes must be the only time period allowed for the initial heat to be released from the product.

Most Halo Heat Holding Equipment is provided with a thermostat control between 60° and 200°F (16° to 93°C). If the unit is equipped with vents, close the vents for moist holding and open the vents for crisp holding.

HOLDING TEMPERATURE RANGE		
MEAT	FAHRENHEIT	CELSIUS
BEEF ROAST — Rare	130°F	54°C
BEEF ROAST — Med/Well Done	155°F	68°C
BEEF BRISKET	160° — 175°F	71° — 79°C
CORN BEEF	160° — 175°F	71° — 79°C
PASTRAMI	160° — 175°F	71° — 79°C
PRIME RIB — Rare	130°F	54°C
STEAKS — Broiled/Fried	140° — 160°F	60° — 71°C
RIBS — Beef or Pork	160°F	71°C
VEAL	160° — 175°F	71° — 79°C
HAM	160° — 175°F	71° — 79°C
PORK	160° — 175°F	71° — 79°C
LAMB	160° — 175°F	71° — 79°C
POULTRY		
CHICKEN — Fried/Baked	160° — 175°F	71° — 79°C
DUCK	160° — 175°F	71° — 79°C
TURKEY	160° — 175°F	71° — 79°C
GENERAL	160° — 175°F	71° — 79°C
FISH/SEAFOOD		
FISH — Baked/Fried	160° — 175°F	71° — 79°C
LOBSTER	160° — 175°F	71° — 79°C
SHRIMP — Fried	160° — 175°F	71° — 79°C
BAKED GOODS		
BREADS/ROLLS	120° — 140°F	49° — 60°C
MISCELLANEOUS		
CASSEROLES	160° — 175°F	71° — 79°C
DOUGH — Proofing	80° — 100°F	27° — 38°C
EGGS — Fried	150° — 160°F	66° — 71°C
FROZEN ENTREES	160° — 175°F	71° — 79°C
HORS D'OEUVRES	160° — 180°F	71° — 82°C
PASTA	160° — 180°F	71° — 82°C
PIZZA	160° — 180°F	71° — 82°C
POTATOES	180°F	82°C
PLATED MEALS	140° — 165°F	60° — 74°C
SAUCES	140° — 200°F	60° — 93°C
SOUP	140° — 200°F	60° — 93°C
VEGETABLES	160° — 175°F	71° — 79°C
<b>THE HOLDING TEMPERATURES LISTED ARE SUGGESTED GUIDELINES ONLY. ALL FOOD HOLDING SHOULD BE BASED ON INTERNAL PRODUCT TEMPERATURES. ALWAYS FOLLOW LOCAL HEALTH (HYGIENE) REGULATIONS FOR ALL INTERNAL TEMPERATURE REQUIREMENTS.</b>		

# CARE AND CLEANING

## PROTECTING STAINLESS STEEL SURFACES



It is important to guard against corrosion in the care of stainless steel surfaces. Harsh, corrosive, or inappropriate chemicals can completely destroy the protective surface layer of stainless steel. Abrasive pads, steel wool, or metal implements will abrade surfaces causing damage to this protective coating and will eventually result in areas of corrosion. Even water, particularly hard water that contains high to moderate concentrations of chloride, will cause oxidation and pitting that result in rust and corrosion. In addition, many acidic foods spilled and left to remain on metal surfaces are contributing factors that will corrode surfaces.

Proper cleaning agents, materials, and methods are vital to maintaining the appearance and life of this appliance. Spilled foods should be removed and the area wiped as soon as possible but at the very least, a minimum of once a day. Always thoroughly rinse surfaces after using a cleaning agent and wipe standing water as quickly as possible after rinsing.

	<b>DANGER</b>
	<b>DISCONNECT UNIT FROM POWER SOURCE BEFORE CLEANING OR SERVICING.</b>

## CLEANING AGENTS

Use non-abrasive cleaning products designed for use on stainless steel surfaces. Cleaning agents must be chloride-free compounds and must not contain quaternary salts. Never use hydrochloric acid (muriatic acid) on stainless steel surfaces. Always use the proper cleaning agent at the manufacturer's recommended strength. Contact your local cleaning supplier for product recommendations.

## CLEANING MATERIALS

The cleaning function can usually be accomplished with the proper cleaning agent and a soft, clean cloth. When more aggressive methods must be employed, use a non-abrasive scouring pad on difficult areas and make certain to scrub with the visible grain of surface metal to avoid surface scratches. Never use wire brushes, metal scouring pads, or scrapers to remove food residue.

<b>CAUTION</b>	
	<b>TO PROTECT STAINLESS STEEL SURFACES, COMPLETELY AVOID THE USE OF ABRASIVE CLEANING COMPOUNDS, CHLORIDE BASED CLEANERS, OR CLEANERS CONTAINING QUATERNARY SALTS. NEVER USE HYDROCHLORIC ACID (MURIATIC ACID) ON STAINLESS STEEL. NEVER USE WIRE BRUSHES, METAL SCOURING PADS OR SCRAPERS.</b>

# CARE AND CLEANING

## EQUIPMENT CARE

Under normal circumstances, this oven should provide you with long and trouble free service. There is no preventative maintenance required, however, the following Equipment Care Guide will maximize the potential life and trouble free operation of this oven.



The cleanliness and appearance of this equipment will contribute considerably to operating efficiency and savory, appetizing food. Good equipment that is kept clean works better and lasts longer.

## CLEAN DAILY

1. Disconnect unit from power source, and let cool.
2. Remove all detachable items such as wire shelves, side racks, and drip pans. Clean these items separately.
3. Wipe the interior metal surfaces of the oven with a paper towel to remove loose food debris.
4. Clean the interior metal surfaces of the cabinet with a damp clean cloth or sponge and any good commercial detergent.



**NOTE:** Avoid the use of abrasive cleaning compounds, chloride based cleaners, or cleaners containing quaternary salts. Never use hydrochloric acid (muriatic acid) on stainless steel.

5. Spray heavily soiled areas with a water soluble degreaser and let stand for 10 minutes, then remove soil with a plastic scouring pad.
6. Wipe control panel, door vents, door handles, and door gaskets thoroughly since these areas harbor food debris.
7. Rinse surfaces by wiping with sponge and clean warm water.

8. Remove excess water with sponge and wipe dry with a clean cloth or air dry. Leave doors open until interior is completely dry. Replace side racks and shelves.
9. Wipe door gaskets and control panel dry with a clean, soft cloth.
10. Interior can be wiped with a sanitizing solution after cleaning and rinsing. This solution must be approved for use on stainless steel food contact surfaces.
11. To help maintain the protective film coating on polished stainless steel, clean the exterior of the cabinet with a cleaner recommended for stainless steel surfaces. Spray the cleaning agent on a clean cloth and wipe with the grain of the stainless steel.
12. Clean any glass with a window cleaner.

Always follow appropriate state or local health (hygiene) regulations regarding all applicable cleaning and sanitation requirements for equipment.

## DANGER



**AT NO TIME SHOULD THE INTERIOR OR EXTERIOR BE STEAM CLEANED, HOSED DOWN, OR FLOODED WITH WATER OR LIQUID SOLUTION OF ANY KIND. DO NOT USE WATER JET TO CLEAN.**



**SEVERE DAMAGE OR ELECTRICAL HAZARD COULD RESULT. WARRANTY BECOMES VOID IF APPLIANCE IS FLOODED**



## DANGER



**DISCONNECT UNIT FROM POWER SOURCE BEFORE CLEANING OR SERVICING.**

# CARE AND CLEANING

## CLEAN THE DOOR VENTS

Door vents need to be inspected and cleaned as required.

## CLEAN THE PROBES DAILY

Remove all food soil from probes. Wipe entire probe and cable assembly with warm detergent solution and a clean cloth. Remove detergent by wiping each probe and cable with clean rinse water and a cloth.

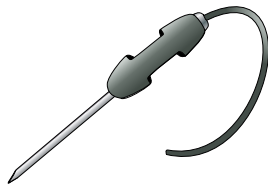

Wipe probes, and probe brackets with disposable alcohol pad or sanitizing solution recommended for food contact surfaces. Allow probe and cable to air dry in probe holding bracket.

## CHECK THE COOLING FAN IN THE OVEN CONTROL AREA

While the oven is warm, check that the cooling fan in the oven control area is functioning. The fan is located at the back of the unit, toward the top.

## CHECK OVERALL CONDITION OF OVEN ONCE A MONTH

Check the oven once a month for physical damage and loose screws. Correct any problems before they begin to interfere with the operation of the oven.

## DO NOT USE OVEN IF CONTROLS ARE NOT PROPERLY FUNCTIONING

Refer to the Trouble Shooting Guide located in this manual or call an authorized service technician.



	
<b>DANGER</b>	
	<b>DISCONNECT UNIT FROM POWER SOURCE BEFORE CLEANING OR SERVICING.</b>

## DAILY PRONG CLEANING

To ensure accurate internal product temperature readings the prongs on the removable probe must be cleaned daily.

1. Remove all food debris from prongs at the end of each production shift. Wipe the entire prong casing, and between each prong with a clean cloth and warm detergent solution.
2. Remove detergent by wiping with a cloth and clean rinse water.
3. Allow prongs to air dry before replacing detachable probe.



<b>DANGER</b>	
	<b>AT NO TIME SHOULD THE INTERIOR OR EXTERIOR BE STEAM CLEANED, HOSED DOWN, OR FLOODED WITH WATER OR LIQUID SOLUTION OF ANY KIND. DO NOT USE WATER JET TO CLEAN.</b>
	<b>SEVERE DAMAGE OR ELECTRICAL HAZARD COULD RESULT.</b> <b>WARRANTY BECOMES VOID IF APPLIANCE IS FLOODED</b>

# SANITATION

Food flavor and aroma are usually so closely related that it is difficult, if not impossible, to separate them. There is also an important, inseparable relationship between cleanliness and food flavor. Cleanliness, top operating efficiency, and appearance of equipment contribute considerably to savory, appetizing foods. Good equipment that is kept clean, works better and lasts longer.

Most food imparts its own particular aroma and many foods also absorb existing odors. Unfortunately, during this absorption there is not distinction between GOOD and BAD odors. The majority of objectionable flavors and odors troubling food service operations are caused by bacteria growth. Sourness, rancidity, mustiness, stale or other OFF flavors are usually the result of germ activity.

The easiest way to insure full, natural food flavor is through comprehensive cleanliness. This means good control of both visible soil (dirt) and invisible soil (germs). A thorough approach to sanitation will provide essential cleanliness. It will assure an attractive appearance of equipment, along with maximum efficiency and utility. More importantly, a good sanitation program provides one of the key elements in the prevention of food-borne illnesses.

A controlled holding environment for prepared foods is just one of the important factors involved in the prevention of food-borne illnesses. Temperature monitoring and control during receiving, storage, preparation, and the service of foods are of equal importance.

The most accurate method of measuring safe temperatures of both hot and cold foods is by internal product temperature. A quality thermometer is an effective tool for this purpose, and should be routinely used on all products that require holding at a specific temperature.

A comprehensive sanitation program should focus on the training of staff in basic sanitation procedures. This includes personal hygiene, proper handling of raw foods, cooking to a safe internal product temperature, and the routine monitoring of internal temperatures from receiving through service.

Most food-borne illnesses can be prevented through proper temperature control and a comprehensive program of sanitation. Both these factors are important to build quality service as the foundation of customer satisfaction. Safe food handling practices to prevent food-borne illness is of critical importance to the health and safety of your customers.

HACCP, an acronym for Hazard Analysis (at) Critical Control Points, is a quality control program of operating procedures to assure food integrity, quality, and safety. Taking steps necessary to augment food safety practices is both cost effective and relatively simple. While HACCP guidelines go far beyond the scope of this manual, additional information is available by contacting:

**CENTER FOR FOOD SAFETY AND APPLIED  
NUTRITION FOOD AND DRUG ADMINISTRATION  
1-888-SAFEFOOD**

INTERNAL FOOD PRODUCT TEMPERATURES		
<b>HOT FOODS</b>		
DANGER ZONE	40° TO 140°F	(4° TO 60°C)
CRITICAL ZONE	70° TO 120°F	(21° TO 49°C)
SAFE ZONE	140° TO 165°F	(60° TO 74°C)
<b>COLD FOODS</b>		
DANGER ZONE	ABOVE 40°F	(ABOVE 4°C)
SAFE ZONE	36° TO 40°F	(2° TO 4°C)
<b>FROZEN FOODS</b>		
DANGER ZONE	ABOVE 32°F	(ABOVE 0°C)
CRITICAL ZONE	0° TO 32°F	(-18° TO 0°C)
SAFE ZONE	0°F or below	(-18°C or below)

# SERVICE

## TROUBLESHOOTING

Code	Description	Possible Cause
E-10	<b>Cavity air sensor shorted</b>	Cavity air sensor reading < 5°F. Verify sensor integrity. See sensor test instructions below.
E-11	<b>Cavity air sensor open</b>	Cavity air sensor reading > 517°F. Verify sensor integrity. See sensor test instructions below.
E-20	<b>Product probe is shorted</b> <i>Oven will cook in time only</i>	Product probe reading < 5°F. Verify sensor integrity. See sensor test instructions below.
E-21	<b>Product probe is open</b> <i>Oven will cook in time only</i>	Product Probe reading > 517°F. Verify sensor integrity. See sensor test instructions below.
E-30	<b>Under temperature</b>	Unit has not reached (set-point - 25°F) for more than 90 minutes.
E-31	<b>Over temperature</b>	Unit has been higher than 25°F above the maximum cavity set-point for more than 2 minutes. <b>Note:</b> Holding Cabinets with this error code are more than 145°F higher than the maximum set-point.
E-50	<b>Temp. measurement error</b>	Contact factory.
E-51	<b>Temp. measurement error</b>	Contact factory.
E-60	<b>Real time clock error</b>	Data set to factory default. Ensure that date and time are correct if applicable.
E-61	<b>Real time clock error</b>	Contact factory.
E-64	<b>Clock is not oscillating</b>	Contact factory.
E-70	<b>Configuration connector error (DIP switch)</b>	Refer to wiring diagram for the particular model and ensure dip switches on the control match the settings called out on the WD. If the dip switch settings are correct according to the print replace the control.
E-78	<b>Voltage low</b>	Voltage below 90 VAC on a 125 VAC unit, or below 190 VAC on a 208-240 VAC unit. Correct voltage.
E-79	<b>Voltage high</b>	Voltage over 135 VAC on a 125 VAC unit, or over 250 VAC on a 208-240 VAC unit. Correct voltage.
E-80	<b>EEPROM Error</b>	Ensure that all temperatures and times are properly set. Contact factory if problem persists.
E-81	<b>EEPROM Error</b>	Contact factory.
E-82	<b>EEPROM Error</b>	Contact factory.
E-83	<b>EEPROM Error</b>	Contact factory.
E-85	<b>EEPROM Error</b>	All timers, if previously on, are now off. Possible bad EEPROM.
E-86	<b>EEPROM Error</b>	Stored HACCP memory corrupted. HACCP Address reset to 1. Possible bad EEPROM. Contact factory if problem persists.
E-87	<b>EEPROM Error</b>	Stored offsets corrupted. Offsets reset to 0. Control may need a recalibration. Possible bad EEPROM. Contact factory if problem persists.
E-88	<b>EEPROM Error</b>	All timer set-points are reset to 1 minute. Timers, if previously on, are now off. Possible bad EEPROM.
E-90	<b>Button stuck</b>	A button has been held down for >60 seconds. Adjust control. Error will reset when the problem has been resolved.
E-dS	<b>Datakey error</b>	Datakey digital signature incompatible. Cycle power, and install compatible Datakey if error persists.
E-dT	<b>Datakey error</b>	Datakey incompatible with control. Install compatible Datakey.
E-dU	<b>Datakey unplugged</b>	Install Datakey and cycle power to control to clear error.
dLto	<b>Datalogger has timed out</b>	Cycle power. Contact factory if error persists.
dLSD	<b>Micro SD card not plugged in</b>	Plug in SD card and cycle power. Contact factory if error persists.

*Note: If in doubt, always cycle the power to the control and contact factory if the problem persists.*

### To test probe and air sensor:

Test probe and air sensor by placing sensor in ice water bath and using an ohmmeter set on the ohm scale. The reading should be 100 ohms resistance. If it is more than 2 ohms higher or lower, sensor needs to be replaced.

# SERVICE

This section is provided for the assistance of qualified technicians only and is not intended for use by untrained or unauthorized service personnel. If your Alto-Shaam® unit is not operating properly, check the following before calling your Authorized Alto-Shaam Service Agent:

- Check main power circuit breaker to the unit and verify that the circuit breaker on the back of the unit is turned on, if applicable.

*Do not attempt to repair or service the unit beyond this point. Contact Alto-Shaam for the nearest authorized service agent. Repairs made by any other service agents without prior authorization by Alto-Shaam® will void the warranty on the unit.*

## TROUBLE SHOOTING INTERNAL ELECTRICAL COMPONENTS

### A. No power. Display will not light.

1. Verify that power is available at the outlet or junction box.
2. Verify that the circuit breaker switch on the back of the unit is turned on.
3. Verify that the power cord is not open. Check continuity with a VOM meter.
4. If the problem persists, call a qualified Alto-Shaam service technician at 1-800-558-8744.

### B. Display is lit but unit is not heating.

Check to verify that the high limit switch located at the rear of the unit top has not been tripped. If it has been tripped, reset by pressing in the hi-limit reset button at the rear of the oven.

After resetting, the cause of the high limit trip must be corrected. If the high limit switch will not reset, the high limit switch is defective and must be replaced. *This is a safety device and must not be bypassed or removed from the circuit.*



### C. To test air sensor:

Test air sensor by placing sensor in ice water bath and using an ohmmeter set on the ohm scale. The reading should be 100 ohms resistance. If it is more than 2 ohms higher or lower, sensor needs to be replaced.

### D. To test probe sensor:

Test food probe by placing in ice water bath and using an ohmmeter set on the ohm scale. The reading should be 100 ohms resistance.

	<b>DANGER</b>
	<b>DISCONNECT UNIT FROM POWER SOURCE BEFORE CLEANING OR SERVICING.</b>

<b>CAUTION</b>
THIS SECTION IS PROVIDED FOR THE ASSISTANCE OF QUALIFIED SERVICE TECHNICIANS ONLY AND IS NOT INTENDED FOR USE BY UNTRAINED OR UNAUTHORIZED SERVICE PERSONNEL.

<b>NOTE</b>
If the appliance has been unplugged for an extended period of time, the Real Time Clock may require recharging. Turn main breaker to the unit off for 10 seconds and then restore power. For more information, see Error Code E-60 in the Troubleshooting section of this manual.

	<b>DANGER</b>
	<b>LOCK-OUT OR POST BREAKER PANEL UNTIL SERVICE WORK HAS BEEN COMPLETED.</b>

# SERVICE

## EXTERIOR VIEW - 300-TH/III

**A**

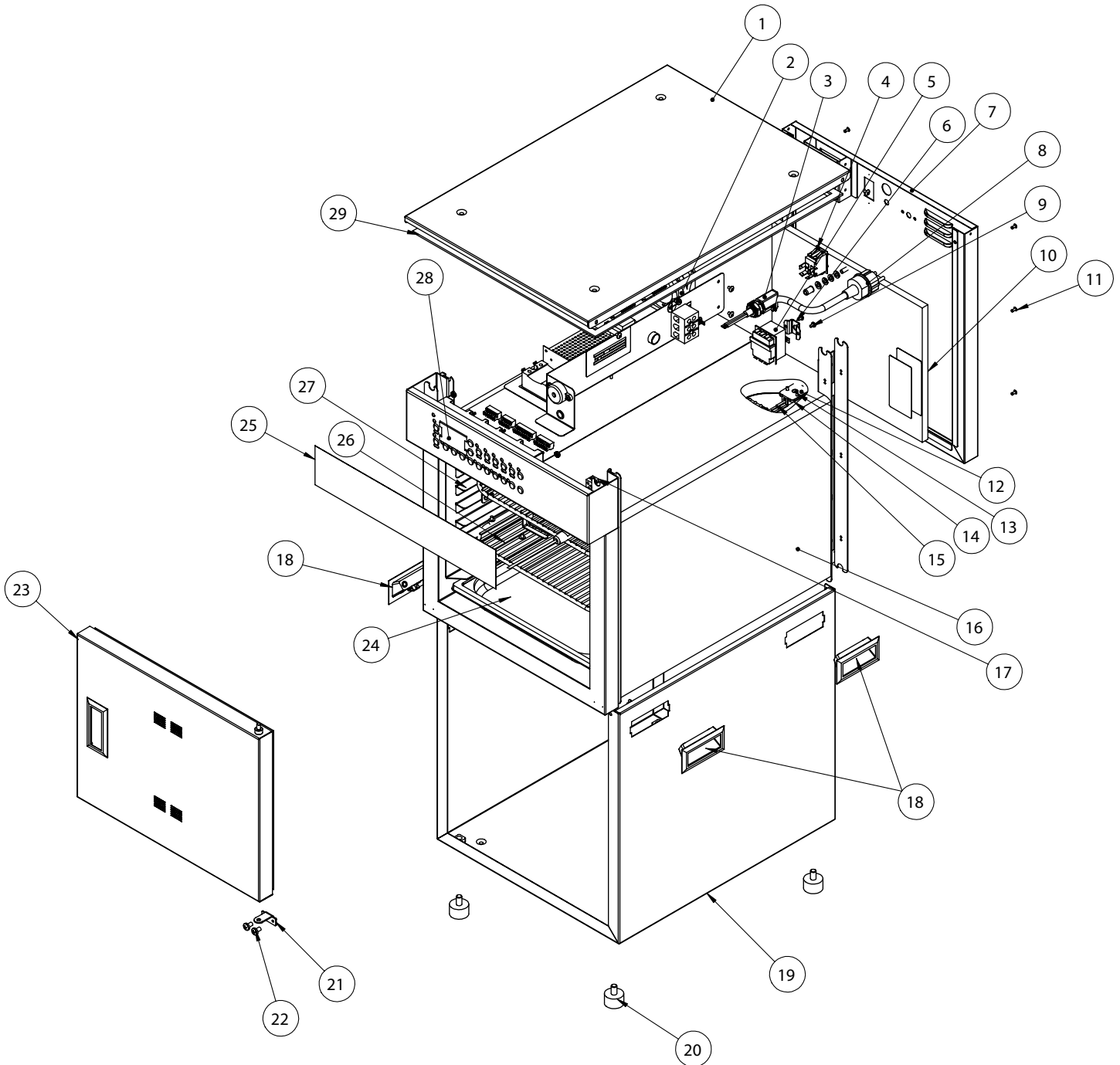

Part numbers and drawings are subject to change without notice.



# SERVICE

## EXTERIOR SERVICE VIEW - 300-TH/III **A**

ITEM	DESCRIPTION	PART NO.	QTY
1	BONNET TOP COVER	1012831	1
2	FAN BOX, 120V	FA-3973	1
	FAN BOX, 230V	FA-34524	1
3	BUSHING, STRAIGHT, STRAIN RELIEF, 230V	BU-34898	1
	BUSHING, STRAIGHT, STRAIN RELIEF, 120V	BU-3964	1
4	SWITCH, ROCKER, 125-277V, 20A	SW-34769	1
5	HI-LIMIT THERMOSTAT	TT-33476	1
6	HI-LIMIT PROTECTION COVER	1003936	1
7	REAR TRIM	5014525	1
8	CORDSET, 230V	CD-3922	1
	CORDSET, 120V	CD-3232	1
9	SCREWS, M4-0.7 X 6MM PHIL	SC-22271	2
10	INSULATION	IN-2003	1
11	RIVET, BLIND, #44, S/S	RI-2100	16
12	GUARD SENSOR	1493	1
13	SCREW, 6-32 X 1/2, NC PHIL, FLAT	SC-2254	2
14	BLOCK, SENSOR	BK-29605	1
15	SENSOR	SN-33541	1
16	INSULATION	IN-22364	1
17	PRODUCT PROBE	15892R	1
18	HANDLE, PULL, RECESSED	HD-28789	4
19	OUTER CASING SPOT	5014538	1
20	FEET, 3-1/2" (89mm) RIGID	FE-29203	4
21	HINGE PLATE, BOTTOM	1012999	1
22	SCREW, M6 X 1.0 X 10 PAN	SC-27078	2
23	DOOR ASSEMBLY	5014458	1
	DOOR GASKET	GS-35092	1
24	DRIP PAN	PN-2122	1
25	PANEL, OVERLAY	PE-35086	1
26	SHELF, WIRE	SH-2107	2
27	SIDE RACK	1012872	2
28	CONTROL	CC-34194	1
29	GASKET, ADHESIVE, .125X.375 [lin ft]	GS-23622	1
30*	PROBE WIRE HOLDER	13239	1
31*	NUT, THREADED INSERT, M6	NU-22770	1
32*	NUT, 8-32 UNC FEPS ZP	NU-26526	4
33*	SCREW, 8-32 X 2 SLOT PAN HEAD 18-8 S/S	SC-23154	2
34*	SCREW, HHCS M6 X 20, W/NO MARKING	SC-22924	1
35*	SCREW, 8-32 X 1/4" TRH PHH	SC-2459	12
36*	FOIL PAD HEATER, 230V	EL-29740	1
	FOIL PAD HEATER, 120V	EL-35173	1

\* NOT SHOWN

# SERVICE

## EXTERIOR SERVICE VIEW - 500, 750, 1000-TH/III **(B)**

500-TH/III Shown

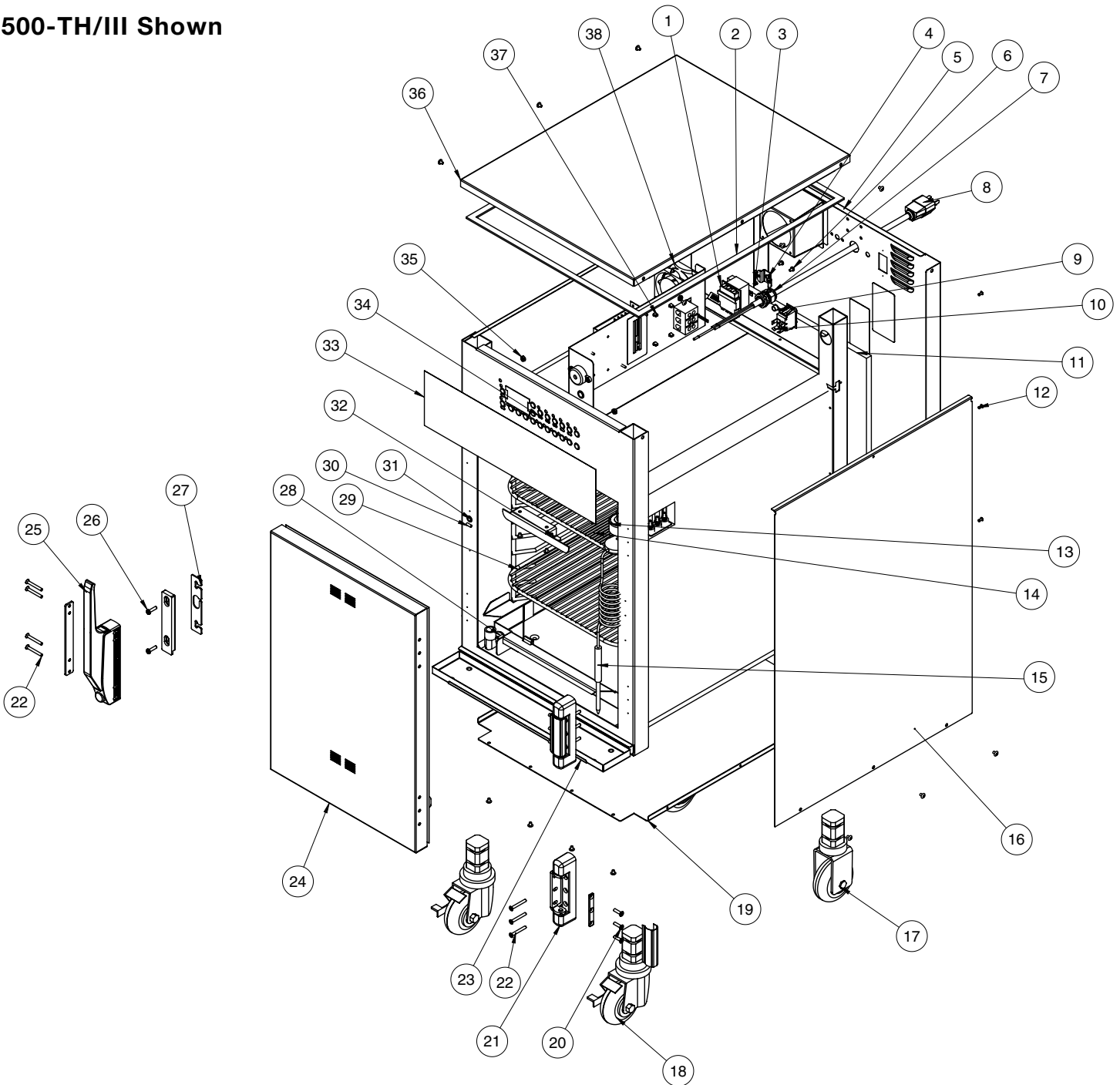

Part numbers and drawings are subject to change without notice.

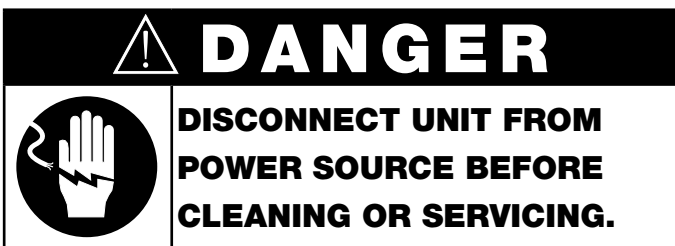

# SERVICE

## EXTERIOR SERVICE VIEW - SINGLE COMPARTMENT B

ITEM	DESCRIPTION	MODEL >		500-TH/III		750-TH/III		1000-TH/III	
		PART NO.	QTY	PART NO.	QTY	PART NO.	QTY		
1	THERMOSTAT, HI LIMIT	TT-33476	1	TT-33476	1	TT-33476	1		
2	GASKET ADHESIVE 0.125 X 0.375 [LIN FT]	GS-23622	1	GS-23622	1	GS-23622	1		
3	PLUG, DOME,,187" HOLE	PG-28439	4	PG-28439	4	PG-28439	4		
4	HIGH LIMIT PROTECTION COVER	1003936	1	1003936	1	1003936	1		
5	REAR TRIM, SPOT	5014004	1	5014081	1	5014172	1		
6	SCREW, M4-0.7 X 6mm PHIL	SC-22271	2	SC-22271	2	SC-22271	2		
7	BUSHING, STRAIN RELIEF	BU-3964	1	BU-3964	1	BU-3964	1		
8	CORDSET, 120V, 5FT. (1524mm)	CD-3397	1	—	—	—	—		
	CORDSET, 208-240V, 5FT. (1524mm)	CD-3607	1	CD-3607	1	CD-3607	1		
	CORDSET, 230V, 8FT. (2438mm)	CD-3922	1	CD-3922	1	CD-3922	1		
9	PLUG, 3/8" HOLE	PG-25574	1	PG-25574	1	PG-25574	1		
10	SWITCH,ROCKER, 125-277V, 20A	SW-34769	1	SW-34769	1	SW-34769	1		
11	INSULATION	IN-2003	1	IN-2003	1	IN-2003	1		
12	RIVET, BLIND, #44 STAINLESS	RI-2100	6	RI-2100	6	RI-2100	6		
13	PROBE RECEPTACLE	PR-34705	1	PR-34705	1	PR-34705	1		
14	SHELF, STAINLESS STEEL	SH-2326	2	SH-2324	3	SH-2325	3		
15	PROBE, PRODUCT	PR-34298	1	PR-34298	1	PR-34298	1		
16	PANEL, SIDE	5015081	2	5015083	2	5015088	2		
17	CASTER, 3-1/2" (89mm) RIGID	CS-25674	2	CS-25674	2	CS-25674	2		
18	CASTER, 3-1/2" (89mm) SWIVEL W/ BRAKE	CS-25675	2	CS-25675	2	CS-25675	2		
19	BOTTOM PANEL	1010774	1	1010394	1	1009941	1		
20	SCREW, 10-32 X 3/4", NF PHIL	SC-2072	6	SC-2072	6	SC-2072	6		
21	HINGE	HG-22338	1	HG-22338	1	HG-22338	1		
22	SCREW,10-32X1-1/2", NF, PHIL	SC-2073	10	SC-2073	10	SC-2073	10		
23	DRIP TRAY KIT	5010736	1	5010391	1	5009716	1		
	- DRIP TRAY HOLDER	1010782	1	1010584	1	1010188	1		
	- DRIP TRAY	1010783	1	1010585	1	1010189	1		
24	DOOR ASSEMBLY, SLAB, RH	5010828	1	5010946	1	5010081	1		
	*DOOR ASSEMBLY, WINDOW, RH	5010830	1	5010948	1	5010082	1		
	*DOOR ASSEMBLY, SLAB, LH	5010824	1	5010947	1	5010071	1		
	*DOOR ASSEMBLY, WINDOW, LH	5010829	1	5010949	1	5010076	1		
	*DOOR GASKET	GS-22950	1	GS-22951	1	GS-22952	1		
25	HANDLE, OFFSET MAG. LATCH	HD-27080	1	HD-27080	1	HD-27080	1		
26	SCREW, 3/4" PAN HD	SC-2071	2	SC-2071	2	SC-2071	2		
27	SHIM, HANDLE	13947	1	13947	1	13947	1		
28	DRIP PAN WELD	14813	1	14831	1	5005616	1		
29	SIDE RACK, CHROME	SR-28403	2	SR-28405	2	SR-2266	2		
	PAN SLIDES, 230V ONLY	1010880	2	1010813	2	—	—		
30	SWITCH, DOOR	SW-33559	1	SW-33559	1	SW-33559	1		
31	BUSHING, 3/8" BLACK HOLE	BU-3419	1	BU-3419	1	BU-3419	1		
32	PROBE WIRE HOLDER	13239	1	13239	1	13239	1		
33	PANEL OVERLAY	PE-26710	1	PE-26839	1	PE-26713	1		
34	CONTROL	CC-34194	1	CC-34194	1	CC-34194	1		
35	NUT, #8-32 UNC KEPS ZP	NU-26526	4	NU-26526	4	NU-26526	4		
36	TOP COVER	1011946	1	1011872	1	1011534	1		
37	SCREW, 8-32 X 2 SLOT PAN HEAD 18-8 S.S.	SC-23154	2	SC-23154	2	SC-23154	2		
38	FAN, BOX, 115V, 34CFM, 120V	FA-3973	1	FA-3973	1	FA-3973	1		
	FAN, BOX, 208-240V, 230V	FA-34524	1	FA-34524	1	FA-34524	1		
39*	SENSOR GUARD	1493	1	1493	1	1493	1		
40*	PROBE COVER	5009712	1	5009712	1	5009712	1		
41*	SENSOR MOUNTING BLOCK	BK-29605	1	BK-29605	1	BK-29605	1		
42*	SCREW, 6-32 X 1/2", NC PHIL, FLAT	SC-2254	2	SC-2254	2	SC-2254	2		
43*	SCREW, 8-32 X 1/4" PHIL	SC-2459	18	SC-2459	20	SC-2459	26		
44*	SCREW, 8-32 X 1/2" PHIL S/S	SC-2425	6	SC-2425	6	SC-2425	6		
45*	SENSOR, OVEN TEMPERATURE	SN-33541	1	SN-33541	1	SN-33541	1		
46*	WASHER, FLAT, M6 DIN 125	WS-22297	2	WS-22297	2	WS-22297	2		
47*	WASHER, M6 SPLIT LOCK S/S 18-8	WS-22302	2	WS-22302	2	WS-22302	2		

\* NOT SHOWN

# SERVICE

## EXTERIOR SERVICE VIEW - DOUBLE COMPARTMENT **C**

1200-TH/III

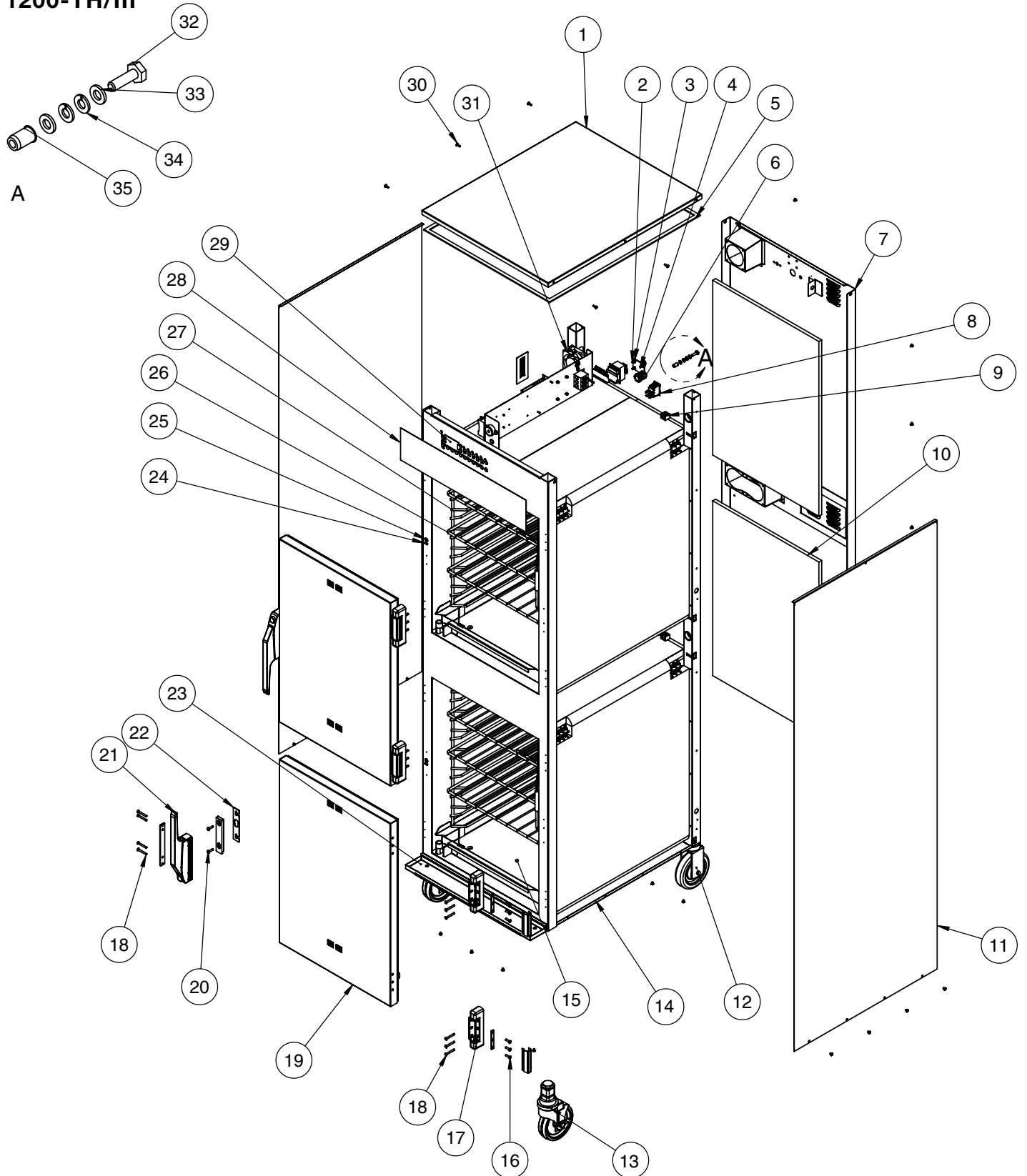

Part numbers and drawings are subject to change without notice.

# SERVICE

## EXTERIOR SERVICE VIEW - 1200-TH/III C

ITEM	DESCRIPTION	PART NO.	QTY	ITEM	DESCRIPTION	PART NO.	QTY
1	TOP COVER	1011534	1	24	SWITCH, REED	SW-33559	2
2	SCREW, 10-32 X 1/2, NF PHIL, FLAT	SC-23670	4	25	BUSHING, 3/8" BLACK HOLE	BU-3419	1
3	NUT, 10-32 UNF HEX MS, 18-8 SST	NU-2215	4	26	SHELF, STAINLESS STEEL	SH-2325	6
4	BRACKET, TETHER	BT-26884	1	27	SIDE RACK, CHROME	SR-2266	4
5	GASKET ADHESIVE 0.125 X 0.375	GS-23622	1	28	PANEL OVERLAY	PE-26714	1
6	BUSHING, STRAIN RELIEF	BU-3964	1	29	CONTROL	CC-34194	1
7	REAR TRIM, SPOT	5014268	1	30	SCREW, 8-32 X 1/2" PHIL SCREW	SC-2425	6
8	SWITCH,ROCKER,125-277V, 20A	SW-34769	1	31	FAN, BOX, 230V	FA-34524	2
9	SENSOR MOUNTING BLOCK	BK-29605	1	32	SCREW, HHCS, M6 X 20	SC-22924	1
10	INSULATION	IN-2003	2	33	WASHER, FLAT, M6 DIN 125	WS-22297	2
11	PANEL, SIDE	5015105	2	34	WASHER, M6 SPLIT LOCK S/S 18-8	WS-22302	2
12	CASTER, 3-1/2" (89mm) RIGID	CS-24874	2	35	NUT, THREADED INSERT	NU-22770	1
13	CASTER, 3-1/2" (89mm) SWIVEL W/ BRAKE	CS-24875	2	36*	SENSOR GUARD	1493	1
14	BOTTOM PANEL	1009941	1	37*	PROBE WIRE HOLDER	13239	1
15	DRIP PAN WELD	5005616	2	38*	HIGH LIMIT PROTECTION COVER	1003936	1
16	SCREW,10-32 X 3/4", NF PHIL	SC-2072	12	39*	PROBE COVER	5009712	1
17	HINGE	HG-22338	2	40*	TERMINAL BLOCK	BK-33546	2
	HINGE COVER	CV-22171	4	41*	BUSHING, 1-1/8" SNAP BUSHING	BU-3378	8
18	SCREW,10-32X1-1/2", NF, PHIL	SC-2073	20	42*	NUT, #8-32 UNC KEPS ZP	NU-26526	4
19	DOOR ASSEMBLY, RH	5010081	2	43*	PROBE, PRODUCT	PR-34298	1
	*DOOR ASSEMBLY, WIDOW, RH	5010082	2	44*	PROBE RECEPTACLE, 2200MM WIRE	PR-34704	1
	*DOOR ASSEMBLY, LH	5010071	2	45*	PROBE RECEPTACLE, 600MM WIRE	PR-34705	1
	*DOOR ASSEMBLY, WINDOW, LH	5010076	2	46*	SCREW, M4-0.7 X 6 MM PHIL	SC-22271	4
	*DOOR GASKET	GS-22952	2	47*	SCREW, 6-32 X 1/2", NC PHIL, FLAT	SC-2254	4
20	SCREW, 3/4" PAN HD	SC-2071	4	48*	8-32 X 2 SLOT PAN HEAD 18-8 S.S.	SC-23154	4
21	HANDLE, OFFSET MAG. LATCH	HD-27080	2	49*	SCREW, 8-32 X 1/4" PHIL	SC-2459	22
22	SHIM, HANDLE	13947	1	50*	SENSOR, OVEN TEMPERATURE	SN-33541	2
23	DRIP TRAY KIT	5009716	1	51*	THERMOSTAT, HI LIMIT	TT-33476	2
	- DRIP TRAY HOLDER	1010188	1				
	- DRIP TRAY	1010189	1				

\* NOT SHOWN

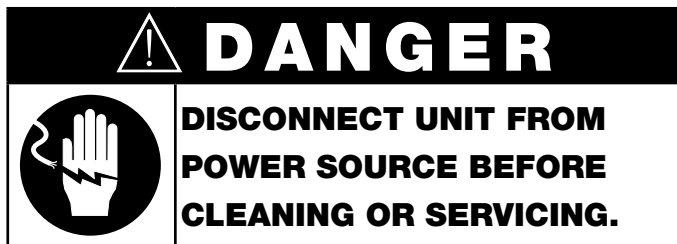

# SERVICE

## ELECTRONIC COMPONENTS - 300-TH/III

230V Shown

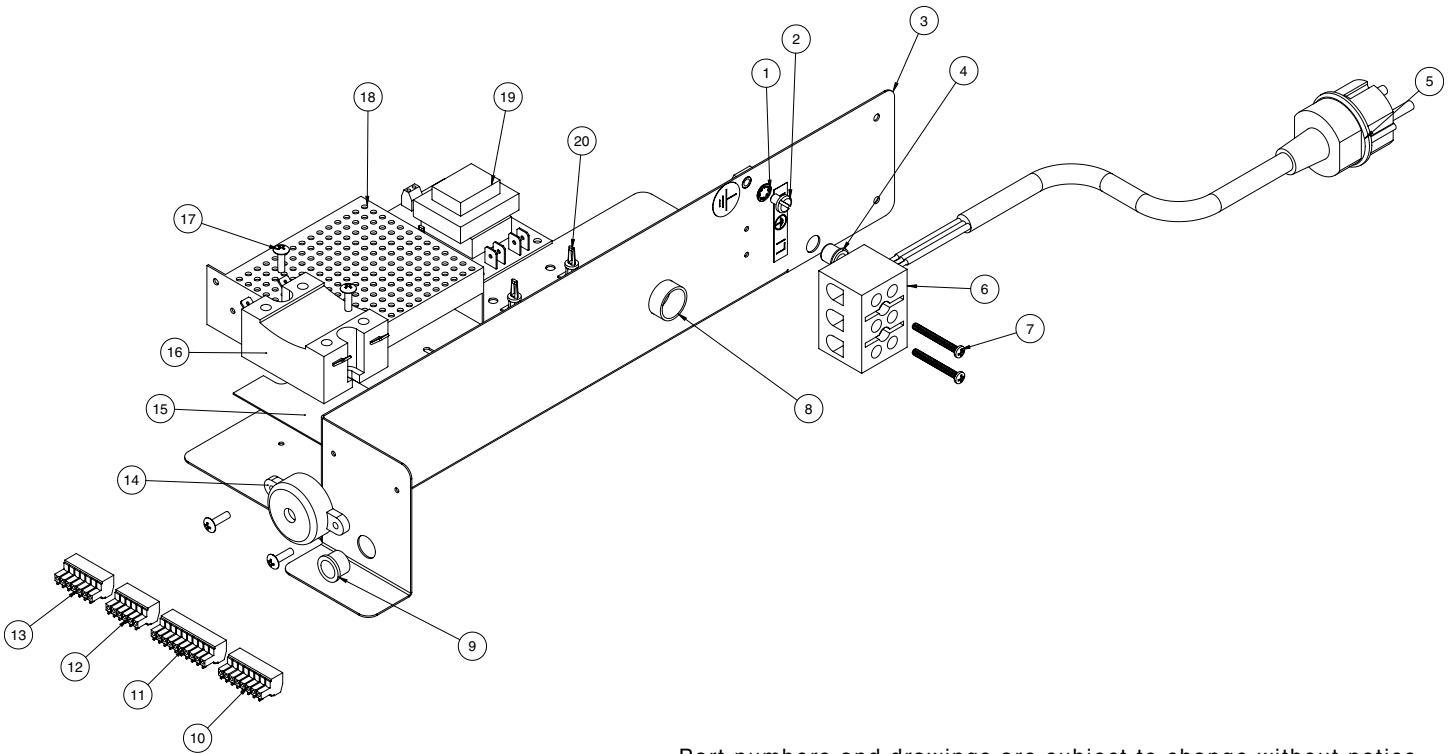

Part numbers and drawings are subject to change without notice.

ITEM	DESCRIPTION	PART NO.	QTY	ITEM	DESCRIPTION	PART NO.	QTY
1	WASHER, STAR LOCK	WS-2467	1	11	CONNECTOR, 10 PIN	CR-33717	1
2	SCREW, 10-32 X 1/4" PAN HD GROUND	SC-2190	1	12	CONNECTOR, 7 PIN	CR-33762	1
3	ELECTRIC CHASSIS, SPOT	5014530	1	13	CONNECTOR, 8 PIN	CR-33761	1
4	BUSHING, 3/8" BLACK HOLE	BU-3419	1	14	BEEPER	BP-3567	1
5	CORDSET - 230V, 8FT. (2438mm)	CD-3922	1	15	HEATSINK	HE-33926	1
	CORDSET - 120V, 5FT. (1524mm)	CD-3397	1	16	RELAY	RL-33829	1
6	T-BLOCK	BK-3019	1	17	SCREW, 6-32 X 1/2" NC PHIL TRUSS	SC-2472	6
7	SCREW, 6-32 X 1-1/4" ROUND HD	SC-2365	2	18	BOARD, POWER SUPPLY	BA-33554	1
8	BUSHING, HOLE, 3/4"	BU-3008		19	BOARD, VOLTAGE MONITOR	BA-33764	1
9	BUSHING, HOLE, 1/2"	BU-3006	1	20	SPACER, LOCK MOUNT	SP-33832	4
10	CONNECTOR, 6 PIN	CR-33719	1				

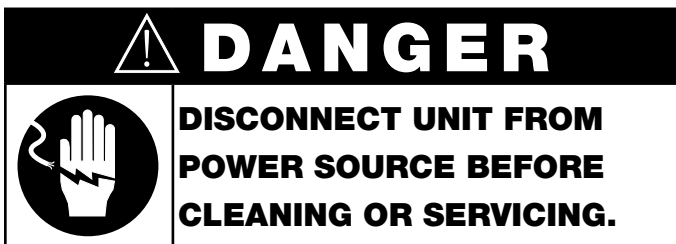

# SERVICE

## ELECTRONIC COMPONENTS - 500, 750, 1000, 1200-TH/III 230V Shown

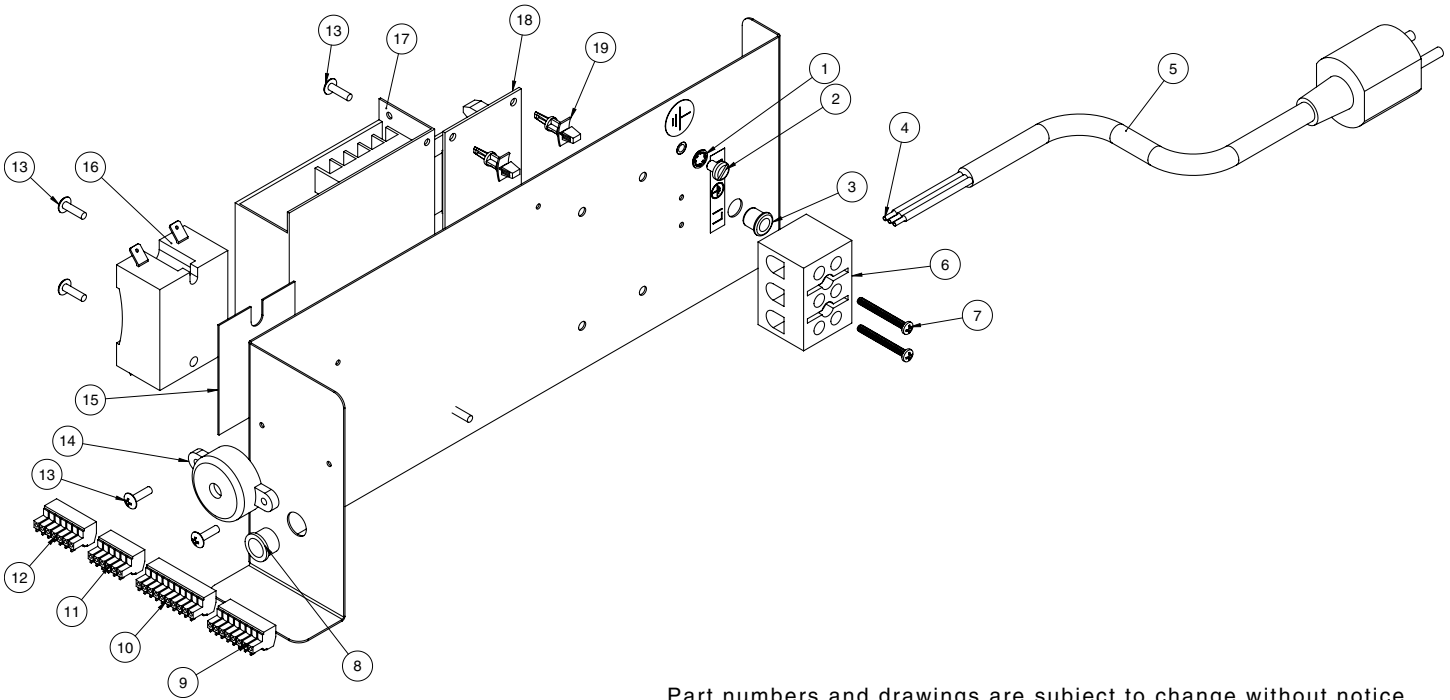

Part numbers and drawings are subject to change without notice.

ITEM	DESCRIPTION	PART NO.	QTY	ITEM	DESCRIPTION	PART NO.	QTY
1	STAR LOCK WASHER	WS-2467	1	11	CONNECTOR, 7 PIN	CR-33762	1
2	SCREW, 10-32 X 1/4" PAN HD GROUND	SC-2190	1	12	CONNECTOR, 8 PIN	CR-33761	1
3	BUSHING, 3/8" BLACK HOLE	BU-3419	1	13	SCREW, 6-32 X 1/2" NC PHIL TRUSS	SC-2472	6
4	CONNECTOR, #16 FERRULE - 230V	CR-34828	3	14	BEEPER	BP-3567	1
5*	CORDSET - 230V, 8FT. (2438mm)	CD-3922	1	15	HEATSINK	HE-33926	1**
	CORDSET - 120V, 5FT. (1524mm)	CD-3397	1	16	RELAY	RL-33829	1**
6	T-BLOCK	BK-3019	1	17	BOARD, POWER SUPPLY	BA-33554	1
7	SCREW, 6-32 X 1-1/4" ROUND HD	SC-2365	2	18	BOARD, VOLTAGE MONITOR	BA-33764	1
8	BUSHING, 1/2" HOLE	BU-3006	1	19	SPACER, LOCK MOUNT	SP-33832	4
9	CONNECTOR, 6 PIN	CR-33719	1	20*	CONNECTOR, 9 PIN, 1200-TH/III ONLY	CR-33718	1
10	CONNECTOR, 10 PIN	CR-33717	1				

\*\*PER COMPARTMENT \* NOT SHOWN

### HACCP DATA LOGGER (OPTION)

ITEM	DESCRIPTION	QTY
5015562	HACCP DATA LOGGER, RETRO-FIT KIT	1
CC-35050	— HACCP DATA LOGGER*	1
5014750	HACCP PACKAGE WITH USB PORT	1
CB-34893	— CAP, WATERPROOF USB SHIELDED	1
CB-34894	— CABLE USB WATERPROOF SHIELDED	1

\* CC-35050 may be ordered as a separate item for units that already have the Data Logger Kit installed.

# SERVICE

## CABLE HEATING KITS

<b>CABLE HEATING KIT &gt;</b> (ONE KIT REQUIRED PER CAVITY)		<b>#4880</b> (500)	<b>#4881</b> (750, 1000, 1200)	<b>#4880</b> UK ONLY (1200) 4900W
<b>ITEM</b>	<b>DESCRIPTION</b>	<b>QTY</b>	<b>QTY</b>	<b>QTY</b>
CB-3045	CABLE HEATING ELEMENT	134 FT.	210 FT.	134 FT.
CR-3226	RING CONNECTOR	4	12	4
IN-3488	INSULATION CORNER	1 FT.	1 FT.	1 FT.
BU-3105	SHOULDER BUSHING	4	12	4
BU-3106	CUP BUSHING	4	12	4
ST-2439	STUD	4	12	4
NU-2215	HEX NUT	8	24	8
SL-3063	INSULATING SLEEVE	4	12	4
TA-3540	ELECTRICAL TAPE	1 ROLL	1 ROLL	1 ROLL

## DANGER

**DISCONNECT UNIT FROM  
POWER SOURCE BEFORE  
CLEANING OR SERVICING.**

## DANGER

**LOCK-OUT OR POST  
BREAKER PANEL UNTIL  
SERVICE WORK HAS  
BEEN COMPLETED.**



- J5 Connections are as follows:  
 1-8 = Single Cavity  
 1-7 = ReTerm  
 1-6 = Snoker  
 1-5 = Disable Probe (Prison Mode)  
 1-4 = Disable Voltage Monitor  
 1-3 = Not used  
 1-2 = Not used

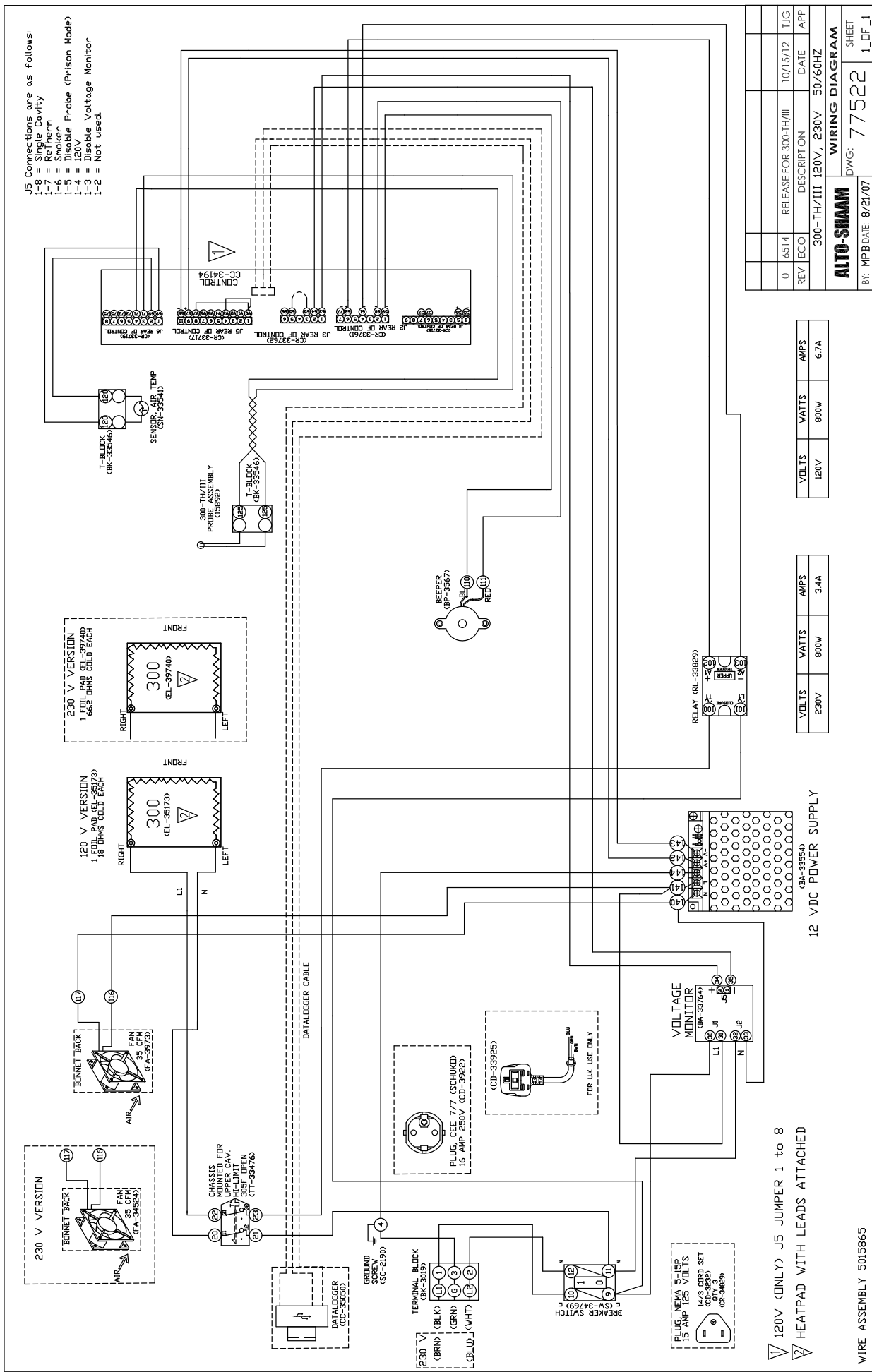

REV	ECCO	DESCRIPTION	DATE	APP
0	6514	RELEASE FOR 300-TH/III	10/15/12	TJG
<b>ALTO-SHAAM</b>				
DWG: 77522				
BY: MPB DATE: 8/21/07				

VOLTS	WATTS	AMPS
120V	800W	6.7A

VOLTS	WATTS	AMPS
230V	800W	3.4A

- 120V (ONLY) J5 JUMPER 1 to 8
- HEATPAD WITH LEADS ATTACHED

WIRE ASSEMBLY 5015865

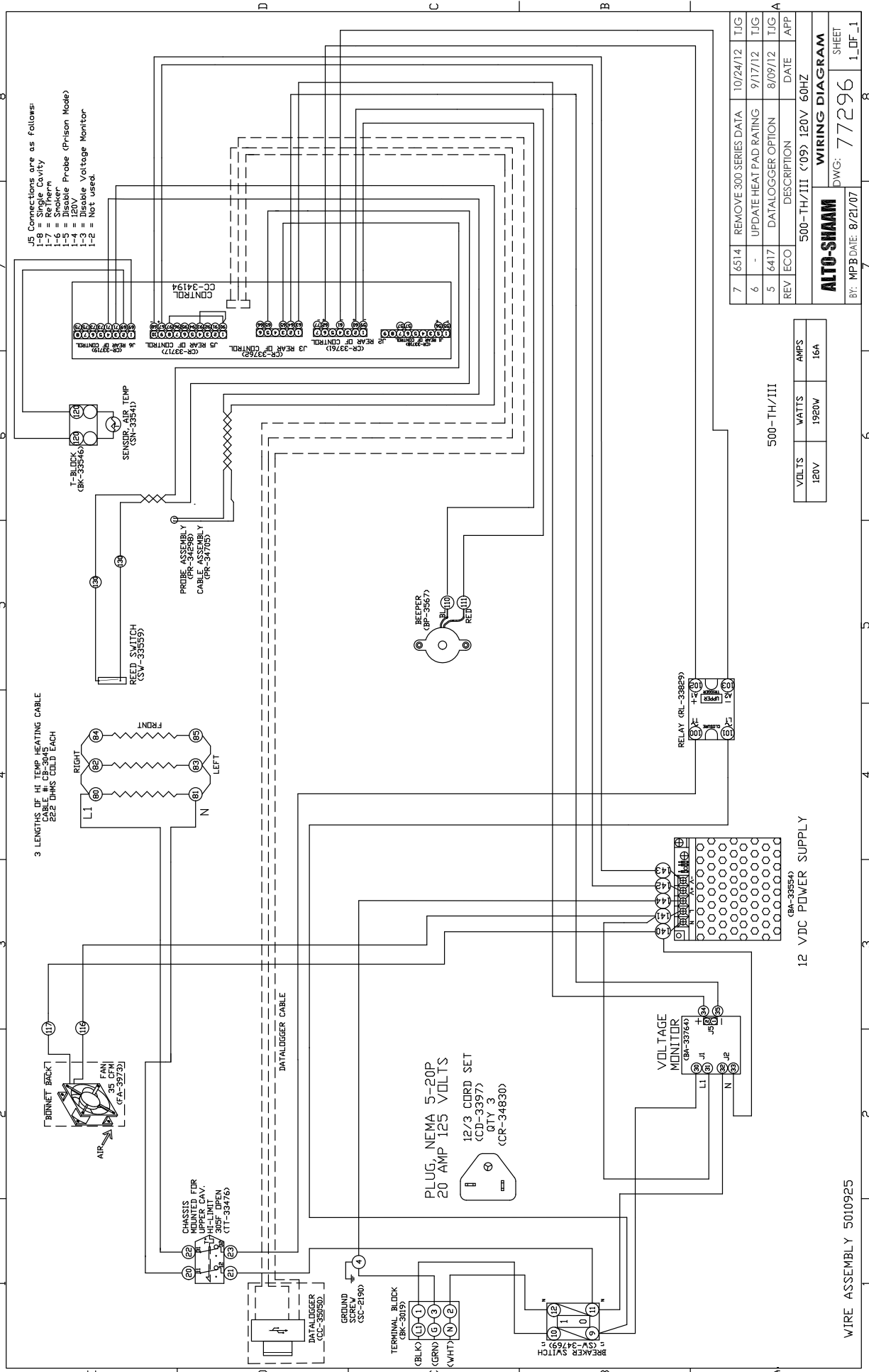

WIRE ASSEMBLY 5010925

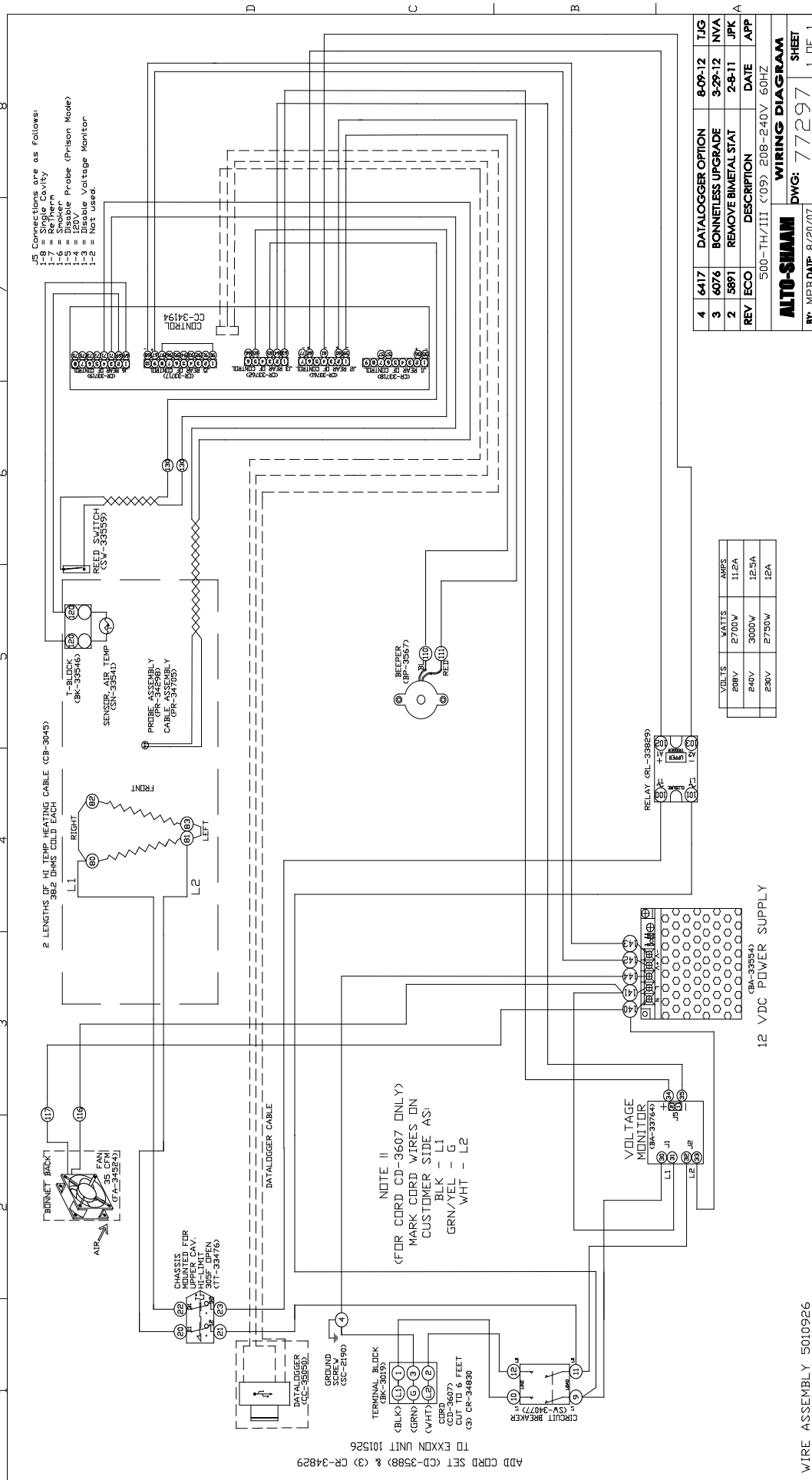

REV	ECO	DESCRIPTION	DATE	APP
4	6417	DATALOGGER OPTION	8-09-12	TJG
3	6076	BONNETLESS UPGRADE	3-29-12	NVA
2	5891	REMOVE BIMETAL STAT	2-8-11	JPK
1				

500-TH/III (09) 208-240V 60HZ

<b>ALTO-SUMAM</b>	
BY: MPB	DATE: 8/20/07
DWG: 77297	SHEET 1_DF_1





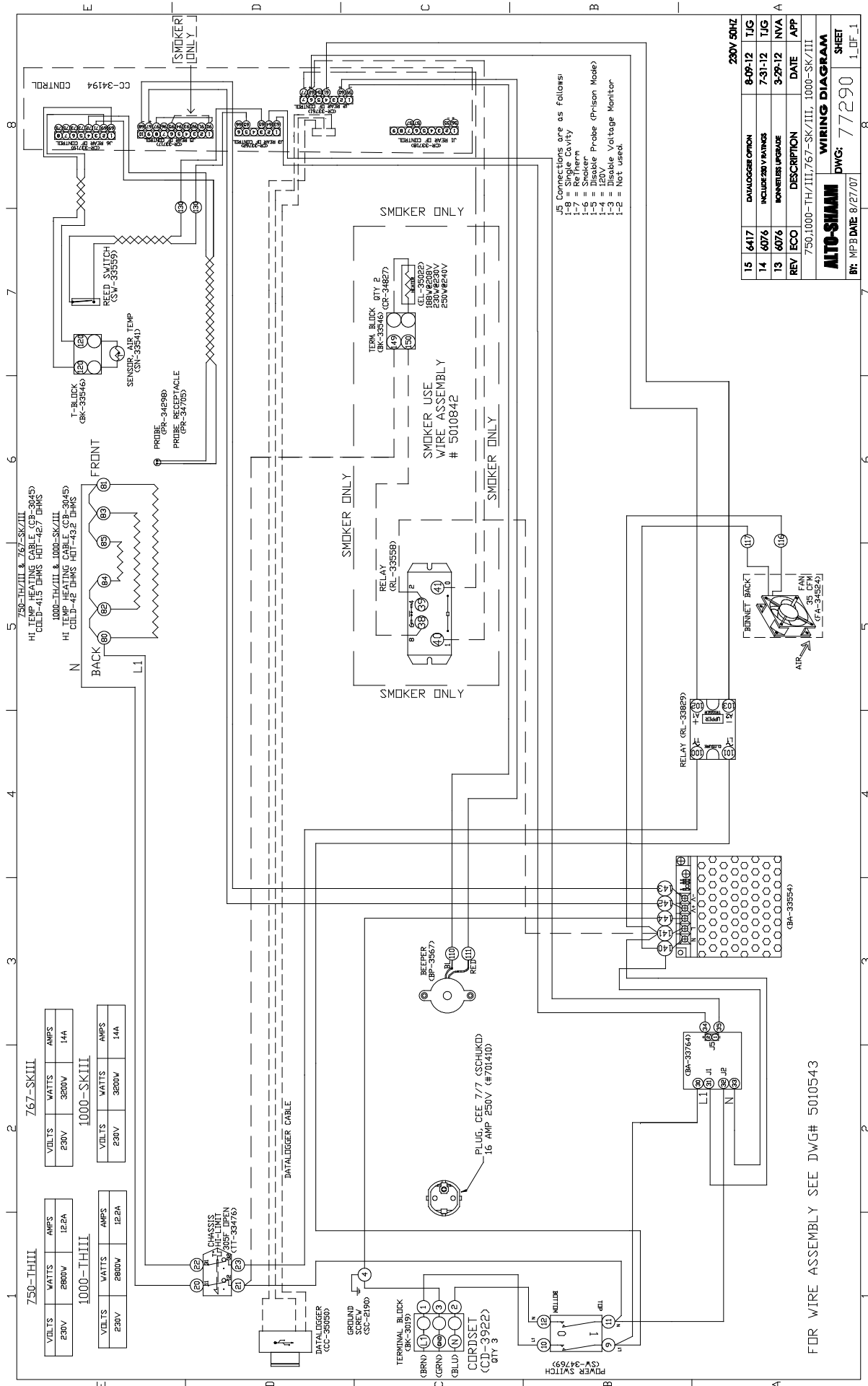

FOR WIRE ASSEMBLY SEE DWG# 5010543

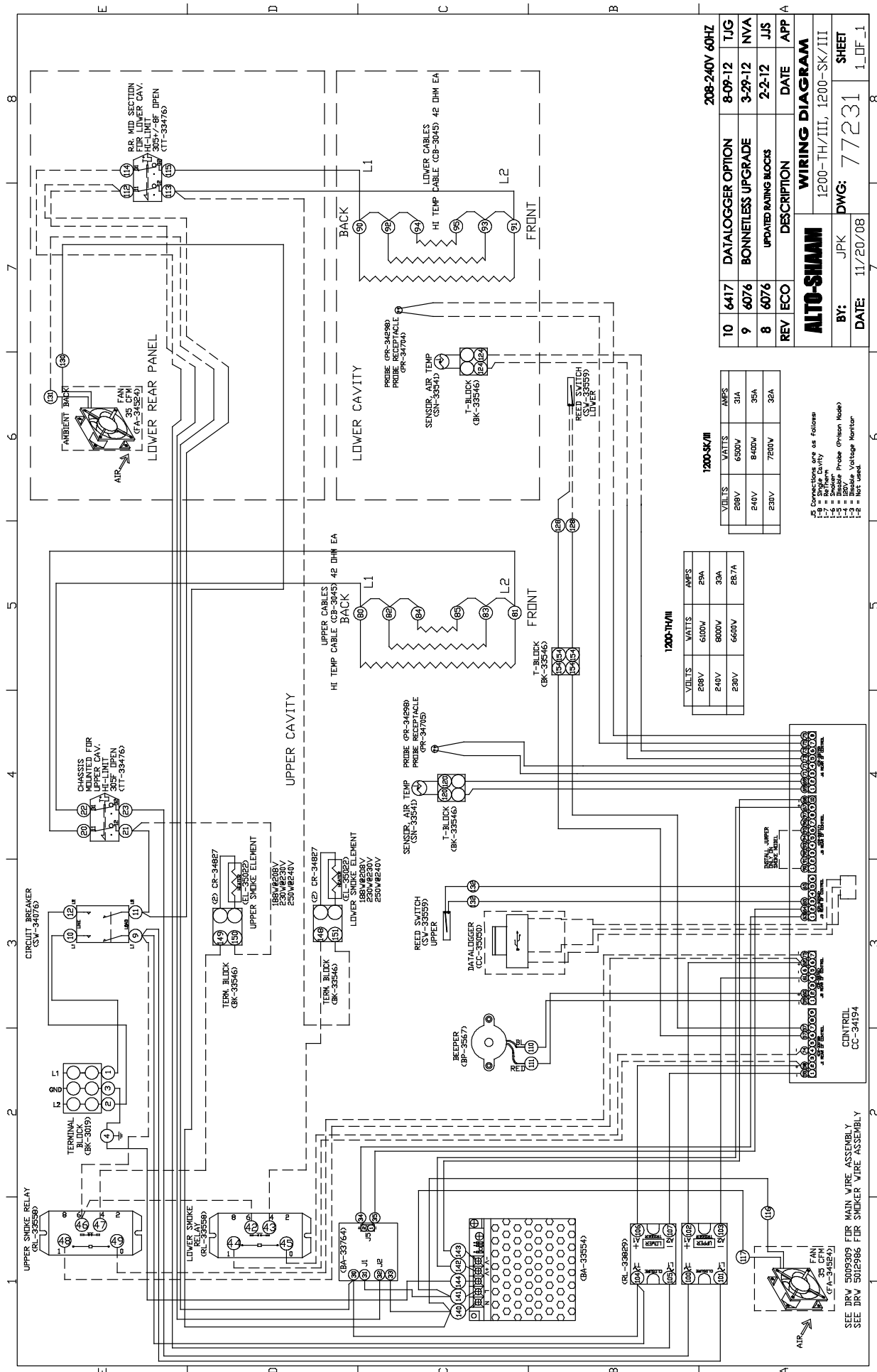

REV	ECO	DESCRIPTION	DATE	APP
10	6417	DATALOGGER OPTION	8-09-12	TJG
9	6076	BONNETLESS UPGRADE	3-29-12	NVA
8	6076	UPDATED RATING BLOCKS	2-2-12	JJS

1200-SK/III	
VOLTS	AMPS
208V	31A
240V	35A
230V	32A

1200-TH/III	
VOLTS	AMPS
208V	29A
240V	33A
230V	28.7A

208-240V 60HZ	
VOLTS	AMPS
208V	31A
240V	35A
230V	32A

**ALTO-SHAM**  
 BY: JPK  
 DATE: 11/20/08

**WIRING DIAGRAM**  
 1200-TH/III, 1200-SK/III  
 DWG: 77231  
 SHEET 1 OF 1

Connections are as follows:  
 1-9 = Single Cavity  
 1-6 = 200mm  
 1-5 = 250mm  
 1-3 = 300mm  
 1-2 = 350mm  
 1-1 = 400mm  
 1-0 = 450mm

SEE DRW 501998 FOR MAIN WIRE ASSEMBLY  
 SEE DRW 502598 FOR SNIKER WIRE ASSEMBLY

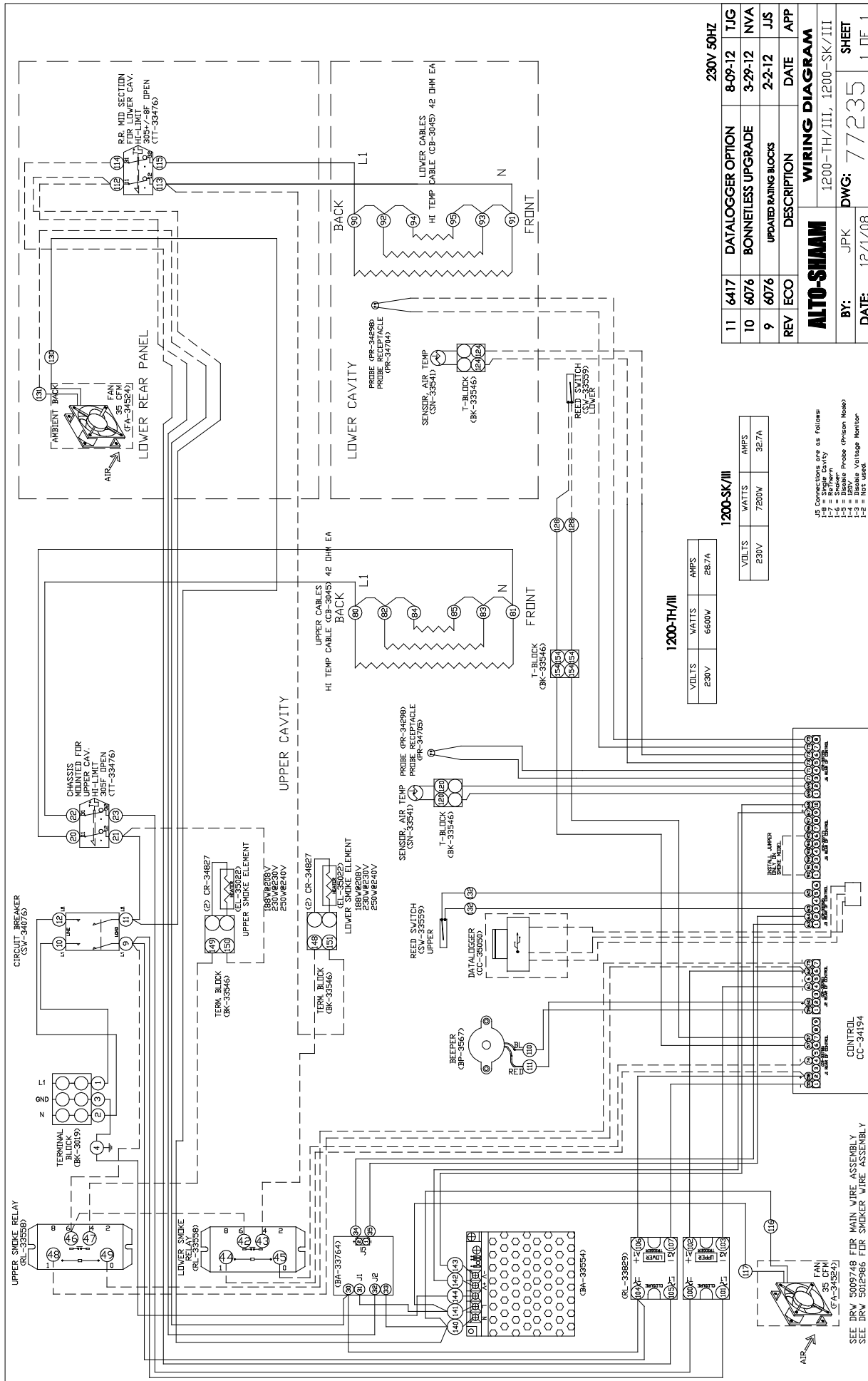

11	6417	DATALOGGER OPTION	8-09-12	TJG
10	6076	BONNETLESS UPGRADE	3-29-12	NVA
9	6076	UPDATED RATING BLOCKS	2-2-12	JJS
REV	ECO	DESCRIPTION	DATE	APP

**230V 50HZ**

<b>1200-SK/III</b>	
VOLTS	230V
WATTS	7200W
AMPS	32.7A

<b>1200-TH/III</b>	
VOLTS	230V
WATTS	6600W
AMPS	28.7A

JS Connections are as follows:  
 1-7 = In Power Cavity  
 1-8 = Beeper Probe (Pinch Mode)  
 1-9 = 230V Voltage Monitor  
 1-2 = Not used

SEE DRW 5009748 FOR MAIN WIRE ASSEMBLY  
 SEE DRW 5012986 FOR SMOKE WIRE ASSEMBLY

**ALTO-SHAM**  
 BY: JPK  
 DATE: 12/1/08

WIRING DIAGRAM  
 1200-TH/III, 1200-SK/III

DWG: 77235  
 SHEET 1\_OF\_1





# TRANSPORTATION DAMAGE and CLAIMS



All Alto-Shaam equipment is sold F.O.B. shipping point, and when accepted by the carrier, such shipments become the property of the consignee.

Should damage occur in shipment, it is a matter between the carrier and the consignee. In such cases, the carrier is assumed to be responsible for the safe delivery of the merchandise, unless negligence can be established on the part of the shipper.

1. Make an immediate inspection while the equipment is still in the truck or immediately after it is moved to the receiving area. Do not wait until after the material is moved to a storage area.
2. Do not sign a delivery receipt or a freight bill until you have made a proper count and inspection of all merchandise received.
3. Note all damage to packages directly on the carrier's delivery receipt.
4. Make certain the driver signs this receipt. If he refuses to sign, make a notation of this refusal on the receipt.
5. If the driver refuses to allow inspection, write the following on the delivery receipt:  
*Driver refuses to allow inspection of containers for visible damage.*
6. Telephone the carrier's office immediately upon finding damage, and request an inspection. Mail a written confirmation of the time, date, and the person called.
7. Save any packages and packing material for further inspection by the carrier.
8. Promptly file a written claim with the carrier and attach copies of all supporting paperwork.

We will continue our policy of assisting our customers in collecting claims which have been properly filed and actively pursued. We cannot, however, file any damage claims for you, assume the responsibility of any claims, or accept deductions in payment for such claims.

## LIMITED WARRANTY

Alto-Shaam, Inc. warrants to the original purchaser only that any original part that is found to be defective in material or workmanship will, at Alto-Shaam's option, subject to provisions hereinafter stated, be replaced with a new or rebuilt part.

### The original parts warranty period is as follows:

For the refrigeration compressor on Alto-Shaam Quickchillers™, five (5) years from the date of installation of appliance.

For the heating element on Halo Heat® cooking and holding ovens, as long as the original purchaser owns the oven. This excludes holding only equipment.

For all other original parts, one (1) year from the date of installation of appliance or fifteen (15) months from the shipping date, whichever occurs first.

The labor warranty period is one (1) year from the date of installation or fifteen (15) months from the shipping date, whichever occurs first.

Alto-Shaam will bear normal labor charges performed during standard business hours, excluding overtime, holiday rates or any additional fees.

To be valid, a warranty claim must be asserted during the applicable warranty period. This warranty is not transferable.

### THIS WARRANTY DOES NOT APPLY TO:

1. Calibration.
2. Replacement of light bulbs, door gaskets, and/or the replacement of glass due to damage of any kind.
3. Equipment damage caused by accident, shipping, improper installation or alteration.
4. Equipment used under conditions of abuse, misuse, carelessness or abnormal conditions, including but not limited to, equipment subjected to harsh or inappropriate chemicals, including but not limited to, compounds containing chloride or quaternary salts, poor water quality, or equipment with missing or altered serial numbers.
5. Damage incurred as a direct result of poor water quality, inadequate maintenance of steam generators and/or surfaces affected by water quality. Water quality and required maintenance of steam generating equipment is the responsibility of the owner/operator.
6. Damage caused by use of any cleaning agent other than Alto-Shaam's Combitherm® Cleaner, including but not limited to damage due to chlorine or other harmful chemicals. **Use of Alto-Shaam's Combitherm® Cleaner on Combitherm® ovens is highly recommended.**
7. Any losses or damage resulting from malfunction, including loss of product, food product, revenue, or consequential or incidental damages of any kind.
8. Equipment modified in any manner from original model, substitution of parts other than factory authorized parts, removal of any parts including legs, or addition of any parts.

This warranty is exclusive and is in lieu of all other warranties, express or implied, including the implied warranties of merchantability and fitness for a particular purpose. In no event shall Alto-Shaam be liable for loss of use, loss of revenue or profit, or loss of product, or for any indirect, special, incidental, or consequential damages. No person except an officer of Alto-Shaam, Inc. is authorized to modify this warranty or to incur on behalf of Alto-Shaam any other obligation or liability in connection with Alto-Shaam equipment.



Effective November 1, 2012

RECORD THE MODEL AND SERIAL NUMBER OF THE APPLIANCE FOR EASY REFERENCE.

ALWAYS REFER TO BOTH MODEL AND SERIAL NUMBER IN ANY CONTACT WITH ALTO-SHAAM REGARDING THIS APPLIANCE.

Model: \_\_\_\_\_ Date Installed: \_\_\_\_\_  
Voltage: \_\_\_\_\_ Purchased From: \_\_\_\_\_  
Serial Number: \_\_\_\_\_

W164 N9221 Water Street • P.O. Box 450 • Menomonee Falls, Wisconsin 53052-0450 • U.S.A.

PHONE: 262.251.3800 • 800.558-8744 USA/CANADA FAX: 262.251.7067 • 800.329.8744 U.S.A. ONLY

www.alto-shaam.com

PRINTED IN U.S.A.

## Free Manuals Download Website

<http://myh66.com>

<http://usermanuals.us>

<http://www.somanuals.com>

<http://www.4manuals.cc>

<http://www.manual-lib.com>

<http://www.404manual.com>

<http://www.luxmanual.com>

<http://aubethermostatmanual.com>

Golf course search by state

<http://golfingnear.com>

Email search by domain

<http://emailbydomain.com>

Auto manuals search

<http://auto.somanuals.com>

TV manuals search

<http://tv.somanuals.com>