

i MultiMix8USB

MIXER AND AUDIO RECORDING WORKSTATION WITH UNIVERSAL DOCK FOR iPod

Reference Manual

ALESIS

This page intentionally left blank



Table Of Contents



Introduction.....	3
Welcome!.....	3
About the iMultiMix 8 USB.....	4
iMultiMix 8 USB Key Features.....	4
How to Use This Manual.....	5
A Few Words for Beginners.....	6
Chapter 1: Getting Started.....	7
Hooking up the iMultiMix 8 USB.....	7
Using Proper Cables.....	8
Setting Levels.....	8
Chapter Two: A Tour of the MultiMix.....	9
Patchbay.....	9
Mic Inputs (Channels 1 – 4).....	9
Line Inputs (Channels 1 – 4).....	9
Line Inputs (Channels 5 – 8).....	10
PHONE Jack.....	10
AUX RETURNS.....	10
AUX SENDS.....	10
2-TRACK.....	10
MAIN MIX OUT.....	10
CTRL RM OUT.....	10
Channel Strips.....	11
Level Control.....	11
PAN or BAL.....	11
PEAK LED.....	11
Aux.....	11
EQ.....	12
Master Section.....	12
Main Mix.....	12
 / 2TK / iPod To Mix.....	12
 / 2TK / iPod To Ctrl Room.....	12
Mix To Ctrl Room.....	12
HDPH / CTRL RM.....	13
AUX RETURN A LEVEL.....	13
EFFECTS / AUX RET B LEVEL.....	13
LED Meters.....	13
POWER Indicator.....	13
+48V Indicator.....	13
iPod Section.....	14
iPod Playback Level.....	14
Backlight.....	14
LED Meters.....	14
iPod Record Level.....	14
Limiter.....	14
iPod control buttons.....	14
Jog Wheel.....	14

Table Of Contents

Rear of the Mixer	15
Power Input.....	15
Power Supply Unit.....	15
Power On.....	15
Phantom On.....	15
USB port.....	15
Chapter Three: Digital Effects	
Processor	17
Effects Section Components	17
Program Selection Knob	17
LED Display.....	17
CLIP Indicator	17
SIG Indicator	17
Effect Descriptions	17
HALL	17
ROOM	17
PLATE	17
CHAMBER.....	17
CHORUS.....	18
FLANGE.....	18
DELAY	18
PITCH.....	18
MULTI & MULTI 2.....	18
Chapter Four: Applications	19
Simple Recording Setup	19
Recording to iPod	19
Simple Live Setup	20
Using Additional External Audio Sources	20
Using the Multimix USB with a Computer	20
Sending and Receiving Audio Data.....	21
Precautions when using the USB connection.....	21
Connection instructions for Windows (XP, 2000, ME, and 98 Second Edition)	21
Connection instructions for Macintosh (OS X only).....	21
Chapter Five: Troubleshooting	23
Chapter Six: Specifications	27
Chapter Seven: Block Diagram	29
Glossary	31
Warranty/Contact Alesis	33
Alesis Limited Warranty.....	33
Alesis Contact Information.....	34

Introduction

Welcome!

Thank you for making the Alesis iMultiMix 8 USB a part of your studio. Since 1984, we've been designing and building creative tools for the audio community. We believe in our products, because we've heard the results that creative people like you have achieved with them. One of Alesis' goals is to make high-quality studio equipment available to everyone, and this Reference Manual is an important part of that. After all, there's no point in making equipment with all kinds of capabilities if no one explains how to use them. So, we try to write our manuals as carefully as we build our products.

The goal of this manual is to get you the information you need as quickly as possible, with a minimum of hassle. We hope we've achieved that. If not, please drop us an email and give us your suggestions on how we could improve future editions of this manual.

We hope your investment will bring you many years of creative enjoyment and help you achieve your musical goals.

Sincerely,
The people of Alesis

*For more effective service
and product update notices,
please register your
iMultiMix 8 USB online at:
[http://www.alesis.com/
index.php?registration](http://www.alesis.com/index.php?registration)*

About the iMultiMix 8 USB

The iMultiMix 8 USB mixer is the latest in the large family of Alesis audio mixers. We've come a long way since the 1622 mixer we first built in 1989. Since that time audio technology has grown in leaps and bounds, pushing up quality and driving down prices. Only a few years ago, you wouldn't have been able to buy a mixer this powerful for such an affordable price. Just take a look at the key features listed below, and you'll see that you have just made an incredible addition to your home studio or live setup.

The iMultiMix 8 USB gives you just about everything you need to create polished, professional-sounding mixes. When designing this unit, our goal was to give you as much control over your mixes as possible without requiring a wealth of extra equipment. That's why we added tools like the digital effects processor and the mic preamps. Not to mention the built-in iPod® dock for recording and playing back directly from your iPod. And with a multitude of ways in which to connect other equipment and instruments, the iMultiMix 8 USB offers endless possibilities.

iMultiMix 8 USB Key Features

- **4 microphone/line inputs with up to 50dB of preamp gain** – gives a boost to microphones and instruments with weak levels.
- **Switchable guitar inputs on channels 1 & 2** – these high-impedance inputs are specifically designed for electric guitars and basses.
- **2 stereo line inputs** – great for line-level instruments
- **Integrated iPod dock** – allows you to record your mix directly to your iPod.
- **iPod Limiter** – ensures that your iPod recordings are always clean, crisp and never distorted.
- **Internal digital effects processor with 100 preset effects and an easy-to-read display** – includes a variety of reverbs, delays, choruses, flanges, a pitch transposer and combinations of these.
- **3-band EQ per channel** – a potent tool for sonically shaping each channel to get that perfect mix.
- **1 pre-fader aux send per channel** – gives you control over the level of the pre-fader signal being routed to an external device.
- **1 post-fader aux send/effects send per channel** – a control for the signal being routed to another external device or to the onboard effects processor.
- **Control room output level** – provides control over the separate control room output
- **2-track send and return** – lets you mix your audio to tape or other media and to add a tape deck or CD player to the mix.
- **Stereo USB input and output** – routes the main output and the 2-track return through the USB port in crystal-clean, 16-bit, 44.1 kHz stereo digital audio. Use the Multimix USB as a high-quality soundcard for recording and playback with Windows and Macintosh computers.
- **External power supply**

® iPod is a registered trademark of Apple Computer, Inc., registered in the U.S.A. and other countries.

How to Use This Manual

This manual is divided into the following sections describing the various functions and applications for the iMultiMix 8 USB. While it's a good idea to read through the entire manual once carefully, those having general knowledge about mixing should use the table of contents to look up specific functions.

Chapter 1: Getting Started shows you how to include the iMultiMix 8 USB in your audio setup for recording and live applications. We've included a hookup diagram, guidelines for which cables to use and the vital steps you must take to set levels properly.

Chapter 2: A Tour of the iMultiMix describes the iMultiMix 8 USB piece by piece. This chapter also features diagrams of the mixer to help you find each component as you read about it.

Chapter 3: Digital Effects Processor explains the effects provided by the on-board digital effects processor. If you want to know what a certain effect will do to your sound before you select it, this is where you should look.

Chapter 4: Applications outlines a number of scenarios in which you can use the iMultiMix 8 USB, including some tips on what goes where when you're hooking everything up.

Chapter 5: Troubleshooting can give you a hand if you're experiencing problems with your mixer. You'll find that most issues can be resolved simply and quickly with the push of a button.

Chapter 6: Specifications and Chapter 7: Block Diagram are full of technical information for the more advanced users.

And at the end of this manual you'll see a glossary of common mixing-related terms and a page about the iMultiMix 8 USB's warranty.

Helpful tips and advice are highlighted in a shaded box like this.

When something important appears in the manual, an exclamation mark (like the one shown at left) will appear with some explanatory text. This symbol indicates that this information is vital when operating the iMultiMix 8 USB.

A Few Words for Beginners

We realize that some of you who have purchased the iMultiMix 8 USB are fairly new to the art of mixing, and we've written this manual with that in mind. We also designed the iMultiMix 8 USB to be both powerful and easy enough to use that even a beginner can quickly pick up the basics.

Many mixer manuals—and manuals for just about any electronic instrument for that matter—are full of complicated terminology and incomplete instructions that presume a lot of experience on the part of the reader. We try to avoid that with this manual. True enough, you will find all the technical lingo and specifications you can handle in here, but we do our best to make this accessible to you.

Beginners will find several elements of this manual especially useful. Keep your eye out for the tips found in the gray boxes on the right side of the page. Be sure to check out the hookup diagrams on page 7, which will give you some ideas on how to fit the mixer into your audio setup after you've taken a tour of the mixer in Chapter 2. And if you come across any terms that you haven't seen before, the glossary probably can help you out.

One of the most important things you'll do before you begin a mixing session is to set the levels. Be sure to refer to the instructions on page 16.

1 Getting Started

Hooking up the iMultiMix 8 USB

This diagram will help you get the iMultiMix 8 USB hooked up and ready to go. The equipment you use depends on personal preference and on whether you're performing live or recording. For example, you'll see below that the MAIN MIX OUT can be routed to a recording device for recording, or to a PA system for live performance.

Be sure to follow the guidelines for which cables to use (further down this page) and the procedure for setting levels (on the next page) before you begin mixing.

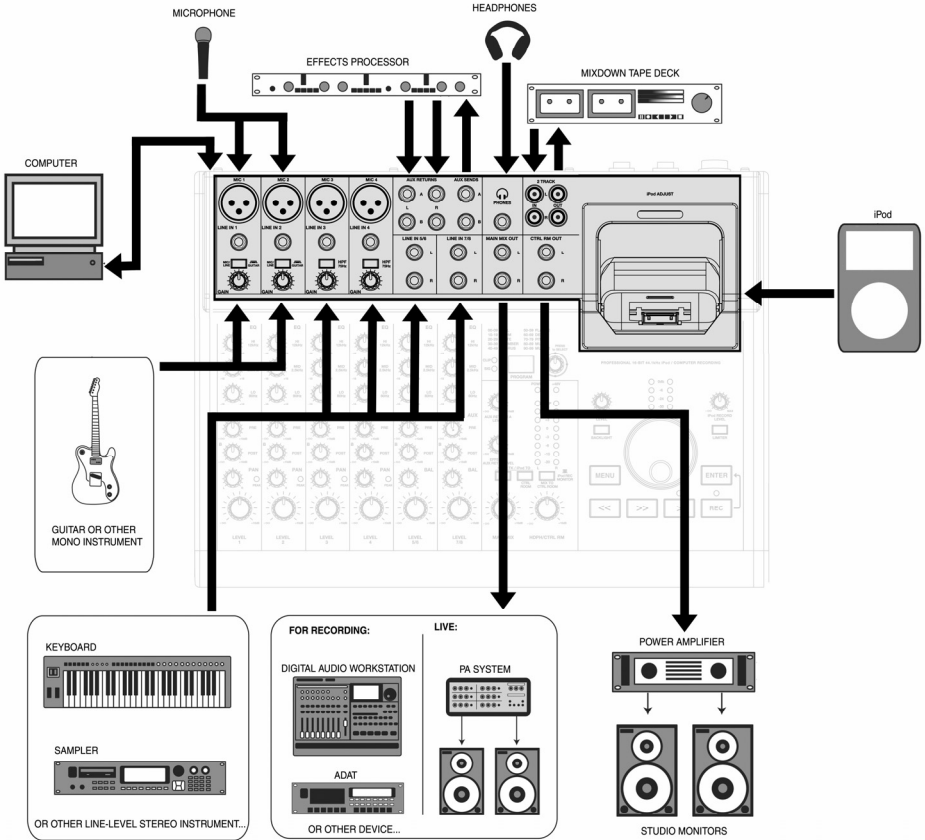

Using Proper Cables

When connecting instruments and other equipment to the iMultiMix, it's important that you use the appropriate types of cables. Here are some simple but important guidelines:

- For the mic inputs, use XLR cables.
- For the line inputs and all other 1/4" connections, use 1/4" mono TRS cables.
- Use stereo RCA cables for the 2-track in and out.
- Use a USB cable to connect the USB port to a computer. Do not use a USB hub, as hubs can introduce timing glitches in USB communication.

Setting Levels

Before you can begin mixing different audio sources with your iMultiMix, you must set the level for each channel you're using. This helps to prevent distortion and clipping. The idea is to get the strongest signal possible without clipping. Here's how:

1. Turn the channel level control to the 12:00 position.
2. Turn the AUX SEND and GAIN controls all the way down, and turn the EQ knobs to the center detent (you'll feel a click).
3. Connect the source of the signal to the channel's input.
4. Play the instrument at a normal level and adjust the channel's gain slowly until the PEAK LED lights.
5. Slowly reduce the channel's gain until the PEAK LED no longer lights when you play.
6. If you need to apply EQ, do so and check the PEAK LED to make sure it still does not light as you play.

2 A Tour of the iMultiMix USB

In this chapter, you'll learn all about the iMultiMix's components (except for the digital effects processor, which is explained in the next chapter). Please refer to the diagrams as you read each section to see which components we're talking about.

Patchbay

At the rear portion of the top of the iMultiMix 8 USB, you'll find the patchbay. This is where you plug in instruments, signal processors, multitrack recorders and other devices. In the following paragraphs, we tell you all about the inputs, outputs, switches and knobs you see in this section of the mixer.

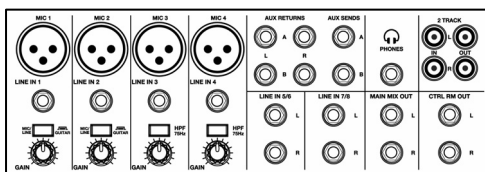

Mic Inputs (Channels 1 – 4)

The iMultiMix uses standard XLR-type mic inputs. These provide +48V phantom power that you can turn on and off with the Phantom On switch located on the rear of the mixer. You probably will have to turn on the phantom power when you're using most condenser mics, as these usually require the extra voltage (unless the mic has its own power source, such as a battery). Dynamic mics don't require phantom power and are unaffected when the power is on.

These high-quality mic inputs also feature up to 50dB of preamp gain that you can adjust with the Gain knob.

Another useful feature of mic inputs 3 & 4 is a high-pass filter (HPF) that can be turned on and off with the HPF switch. When you activate this switch, all frequencies below 75Hz are cut from the signal. This is useful for mic or line signals that don't have much bottom end, such as vocals, snares, cymbals and electric guitar. You'll want to leave this inactivated for instruments like basses and kick drums.

Line Inputs (Channels 1 – 4)

The line inputs, marked LINE IN, are balanced 1/4" jacks that offer the same 50dB of preamp gain and the high-pass filter provided by the mic inputs (however, phantom power does not apply to line inputs). These inputs accept line-level instruments such as keyboards and drum machines. If you find that your instrument has a weak line signal, just plug it into channels 1 – 4 and crank it up with the Gain knob.

You will also notice that channels 1 & 2 feature a Mic/Line | Guitar switch. These two inputs can be used as switchable high-impedance inputs, specifically designed for plugging electric guitars and basses directly into the mixer.

Although chances are your microphones will work fine with these mic inputs, we recommend that you do some checking up on the type of microphone you're using, especially if it's one of the older vintage models. Verify that your microphone requires phantom power and make sure its output is low impedance, balanced and floating.

*Always connect your microphones **before** activating phantom power. Microphones tend to be very sensitive, and the sudden power surge can do permanent damage to the mic's circuitry. It's also a good idea to lower mixer levels before you activate phantom power.*

Line Inputs (Channels 5 – 8)

Unlike channels 1 – 4, the line inputs on channels 5 – 8 are stereo inputs that have left and right inputs. If you're using one of these channels as a mono input, plug your instrument into the left input. Channels 5 – 8 don't have the extra gain found on channels 1 – 4 because most line-level instruments don't require the extra boost. MIDI and other electronic instruments will work especially well on these channels. These inputs are also good for connecting CD players, tape decks or line-level turntables, as these audio sources don't require extra gain.

PHONE Jack

The headphone jack accepts 1/4" jacks. If your headphones are 1/8", you can find a 1/8" to 1/4" adapter in most electronics stores.

AUX RETURNS

These are the 1/4" jacks where you connect the outputs of an external effects processor or other audio source. Each aux return gives you 15dB of gain that can be controlled by the AUX RET A and EFFECTS / AUX RET B LEVEL knobs in the mixer's output section.

If you are using an effects device with only a mono output, plug it into the left return of STEREO AUX RETURN. It will appear in the center of the stereo spectrum, and not to the left.

AUX SENDS

And these are the 1/4" jacks where you connect the lines that are going into the input of an external effects processor. The aux sends give you 10dB of gain that can be controlled in the AUX section of each channel input.

2-TRACK

The 2-TRACK IN and OUT jacks are standard RCA jacks. You'll use the OUTs for mixing to a tape deck or other recorder. With the INs you can bring in a signal, which can be monitored and even added to the main mix via the 2TK TO MIX switch in the master section of the mixer.

MAIN MIX OUT

These 1/4" jacks are where the signal on the main mix bus leaves the mixer. From there you can send it to a recorder or a PA system. The level of this signal is controlled by the MAIN MIX level control.

CTRL RM OUT

You can use these 1/4" jacks to send the control room signal to the input of the amplifier driving your monitors or headphones. This output usually carries the main mix. However, if you engage the 2TK TO CTRL ROOM switch, the CTRL RM OUT will carry the signal present at the 2-TRACK inputs.

Channel Strips

The eight channel strips are virtually identical to each other, with the only difference being that channels 1 – 4 are mono and channels 5 – 8 are stereo. Each channel strip contains the following components.

Level Control

The level control knob controls how much of the signal from the mic or line inputs is sent to the channel. To adjust the level, simply turn the knob to the desired level. In the leftmost position, levels are cut completely, and in the rightmost position you get an additional 10dB of gain.

PAN or BAL

This control—labeled PAN on the mono channels and BAL on the stereo channels—lets you assign the channel to a particular spot within the stereo spectrum. If you turn this knob to the left, you can hear the signal move to the left, and if you turn it to the right...you get the picture. The pan controls do this by adjusting the amount of the signal being sent to the left main mix bus versus the right main mix bus. The balance controls do it by controlling the relative balance of the left and right channel signals being sent to the left and right main mix buses.

PEAK LED

This indicator lets you know when the channel's signal is clipping. This light plays an important role in setting channel levels by helping you know when to reduce the channel's gain.

Aux

Here you'll find knobs that control the levels of aux sends A and B. AUX A is pre-fader, which means that the AUX A send is affected only by the EQ and HPF settings. A pre-fader send is usually used for cue sends (for example, sending a signal to headphones while recording, for which you may not want the fader to alter the channel's level).

AUX B is post-fader, which means that the AUX B send is affected by the fader (or level control knob in this instance), EQ and HPF settings. A post-fader send is generally used for sending the signal to an external effects device (so that the fader controls the signal level). Like AUX A, AUX B can be used for routing signals to external devices. And when you are using the onboard effects processor, AUX B is used to control the level of the channel's signal being routed to the processor.

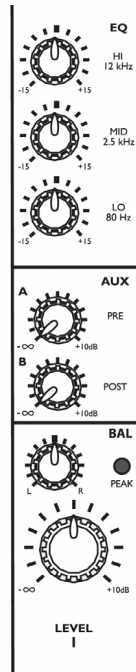

Channel Strip

EQ

The iMultiMix gives you three bands of EQ per channel. Using these knobs, you can tailor the channel's signal by boosting some frequencies and cutting others. The LO and HI controls are shelving controls with fixed frequencies of 75 Hz and 12 kHz respectively. The MID control has a peaking response fixed at 2.5 kHz.

“Shelving” means that the mixer boosts or cuts all frequencies past the specified frequency. “Peaking” means that frequencies above and below the specified frequency fall off, forming a peak in a graphical representation.

Master Section

The Master Section is the heart of the mixer, where the channel inputs and aux returns all are mixed together and routed in various ways.

Main Mix

The signals from all channels and aux sends are sent to the main mix. The MAIN MIX level control is the one you'll use to control the overall level of those combined signals. This knob affects the levels of the signals sent to the MAIN MIX OUT and the 2-TRACK OUT. In its leftmost position the signal is cut off completely, and in the rightmost position you get an additional 10dB of gain.

/ 2TK / iPod To Mix

When you press this switch, the signals coming in from your computer through the USB connection, an external source through the 2-TRACK IN, or an iPod attached to the dock get blended and routed to the MAIN MIX, joining whichever other signals are already part of the main mix. Used this way, this channel effectively becomes another stereo channel (but without all the extras like pan, EQ, etc.).

/ 2TK / iPod To Ctrl Room

When you engage this switch, the signals coming in from the USB connection, the 2-TRACK IN jacks, or a docked iPod are blended and routed to the headphones and to the control room output. This level is controlled by the HDPH / CTRL ROOM level control and cancels out any signal from the main mix.

Mix To Ctrl Room

In DOWN position, routes the Main Mix to the HDPH / CTRL RM outputs. In UP position, routes the iPod Rec Monitor signal to the HDPH / CTRL RM outputs. Generally speaking, the iPod Rec Monitor bus is the same as your Main Mix, except that it also includes the Limiter, if the LIMITER switch beneath the iPod dock is engaged.

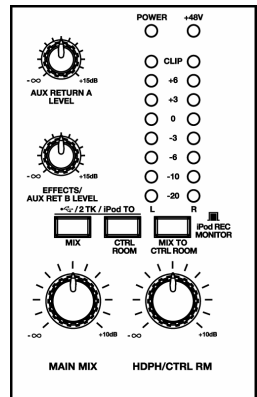

The iMultiMix features a Limiter, which prevents the audio signal from clipping and distorting before entering your iPod. Sometimes it's possible that the Limiter is working too hard and may result in an unpleasant "pumping" sound while it is engaged. The iPod Rec Monitor is useful when you want to hear exactly how the mix will sound before recording to your iPod, in case the Limiter is causing unwanted artifacts.

HDPH / CTRL RM

The HDPH / CTRL RM knob controls the level of the signal being sent to the CTRL RM OUT and the PHONES output. The level of this signal is represented by the LED meters. The “CTRL RM” in the name of this knob refers to the fact that it controls the signal that typically is sent to the control room monitors of a studio, where someone—usually an engineer—is working the mixer. However, don't be intimidated if you're using this mixer in your bedroom, which probably isn't equipped with a control room. In this scenario, you can use headphones or connect the CTRL RM OUT to your speakers.

AUX RETURN A LEVEL

This is the level control for the signal returning to the mixer via AUX RETURN A.

EFFECTS / AUX RET B LEVEL

If you are using one of the iMultiMix 8 USB's internal effects, this knob controls the effect level. If AUX SEND B is connected to an external device, this knob controls the level for AUX RETURN B.

LED Meters

These are the two rows of yellow, green and red lights you see in the master section of the mixer. The LED meters allow you to view the signal level of the main mix, 2-TRACK IN, or your iPod depending on which signals are being routed to the control room mix.

POWER Indicator

When this LED is lit up, that means the POWER ON switch on the rear of the mixer has been activated.

+48V Indicator

When this one is lit up, that means the PHANTOM ON switch on the rear of the mixer has been activated and is supplying +48V phantom power to all XLR mic inputs.

iPod Section

The iPod section contains the controls for your iPod. With the iMultiMix you can not only play content from your iPod, but you can also record your mix directly to it. Please note that not all iPod models are compatible for playback and recording from the iMultiMix – check the compatibility chart on page 20 for more information.

iPod Playback Level

This knob controls the audio playback level of your iPod.

Backlight

Pressing this button turns your iPod's backlight on for 30 seconds, if it is off.

LED Meters

These meters monitor the level of the input signal sent to your iPod. This is the signal that your iPod will record. The meters show the signal after the Limiter, if it has been engaged.

iPod Record Level

This knob adjusts the gain of the input signal sent to your iPod. Aim to adjust this control such that the level going to the iPod (as shown on the iPod LED meters) is consistently yellow (or higher if you don't mind some intermittent distortion). This will allow for maximum recording resolution with a minimum of distortion or unpleasant Limiter artifacts.

Limiter

This button engages the stereo Limiter. Since there is no way to adjust the level of your mix once it has been recorded to your iPod, it is important that the recording is loud, but still clear and undistorted, before entering your iPod. The Limiter feature prevents the audio signal sent to your iPod from clipping, thereby allowing you to boost up the recording level without worrying too much about distortion. However, it is still possible to overdrive the Limiter circuit with too hot of a signal, resulting in an unpleasant “pumping” sound or, at the extreme, distorted recording. It is important that you avoid this by listening to the iPod Rec Monitor signal and adjusting the iPod RECORD LEVEL knob so the recording is loud, yet still retains a good dynamic range.

iPod control buttons

These buttons are used for your iPod's navigation controls. They work just the same as they do on your iPod. You will notice that there is an additional control here which does not appear on your iPod – the REC MODE button. When you press this button, your iPod will enter the recording menu. To begin recording, press the ENTER button while in the recording menu. The red LED above the REC MODE button will illuminate while recording.

Jog Wheel

The jog wheel works as your iPod's touchwheel control.

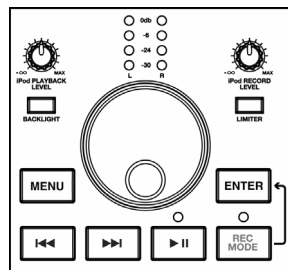

The recording feature will record the stereo audio signal from the Main Mix directly to your iPod.

While it's connected to the iMultiMix, your iPod will charge automatically except when it is recording. By default, charging is disabled during recording. This is because charging while recording may introduce low level noise into your recordings.

If your battery is getting low while recording, or if you plan to record very long sessions, press and hold |<< and >>| for about one second while recording to toggle charging on. Press and hold |<< and >>| again to disable charging at any time while recording.

If you listen carefully to your recordings made with 5th generation video iPods, you may hear some low-level chirping sounds. These sounds are made by the iPod's spinning hard drive. These sounds mostly exist outside of the audio spectrum of your hearing.

Flash-based iPod Nanos do not exhibit this noise.

Rear of the Mixer

Here's what you'll find at the rear of the mixer.



Rear

Power Input

Here's where you plug in your mixer's external power supply. You should always connect your power supply to the mixer *before* you plug the power supply into an electrical outlet.

Power Supply Unit

This unit provides 18.5 VAC at 1000 mA, more than enough to keep your iMultiMix 8 USB running smoothly. As with nearly all power supply units, this one tends to get warm when left on for a while. This is perfectly normal.

Power On

Another easy one. Switch this one on and your mixer has power. Switch it off and it doesn't. Make sure that all master output knobs are turned all the way down when powering your mixer up or down.

Phantom On

This switch activates and deactivates the phantom power described in "Mic Inputs (Channels 1 – 4)," page 9. This switch controls phantom power for all four mic inputs.

USB port

This port allows you to connect the Multimix to a computer for 2-way, 16-bit stereo digital audio communication.

*The POWER INPUT is built to accept **only** the power supply unit provided with your iMultiMix 8 USB, or an AC power supply that has the same specs. Others probably will not work.*

*As we said earlier, it's very important that you plug in your microphones and mute your system **before** you turn on phantom power.*

2 A Tour of the iMultiMix USB

This page intentionally left blank.

3 Digital Effects Processor

Onboard your iMultiMix 8 USB™ is a powerful effects unit that has 100 preset programs. We offer a few tips on where to use these, but don't limit yourself to our suggestions. We recommend that you experiment with these effects to get a good feel for how they can improve your mixes.

Effects Section Components

Program Selection Knob

You can use this knob to assign one of 100 effect programs to your mix. Turning the knob to the right increments the program number, and turning it to the left decrements the program number. You can control the level of the effect for each channel via the channel's AUX B knob. You must PRESS the effect knob to activate the selected effect.

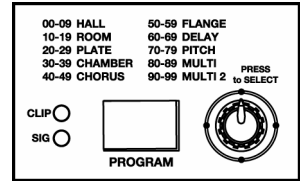

LED Display

This display shows you the number of the current program.

CLIP Indicator

When lit, this LED tells you that there is a signal clip at the internal effects input. This means that you should reduce the signal via the EFFECTS / AUX RET B LEVEL control.

SIG Indicator

When lit, this LED indicates that the effects processor is receiving a signal.

You cannot use the AUX B RETURN and the on-board effects at the same time.

Effect Descriptions

HALL

This type of reverb simulates the ambience of a grand concert hall.

ROOM

This type of reverb reproduces the more intimate ambience of natural room acoustics.

PLATE

These are simulations of metal plate reverbs, as used on classic recordings from the '70s and '80s.

CHAMBER

These are simulations of the reverb created by artificial echo chambers, as used on classic recordings of the '50s and '60s.

CHORUS

These create the effect of multiple voices (or instruments) sounding at once from a single input.

FLANGE

These create a sweeping, swooshing sound effect that you will probably recognize.

DELAY

These effects are based on a discreet repetition or echo of the input.

PITCH

These effects transpose the pitch of the input signal and blend the effect signal with the original to create harmonies.

MULTI & MULTI 2

These are combinations of two or more of the above effects.

4 Applications

Your iMultiMix 8 USB can be used in a wide variety of ways in both live and recording applications. You have several options for bringing sound into and out of the board. And when it's brought in, you can route it to various parts of the mixer for certain desired effects, or even send it to an external processor or tape deck and back. To give you some ideas for different mixing scenarios, here are descriptions of a few common applications for the iMultiMix 8 USB.

Simple Recording Setup

In this setup, you connect your instruments and microphones to the mono and stereo channels, making sure to properly set the level of each channel. To record directly from the mixer to a tape deck or other device, connect the device via the 2-TRACK OUT jack. To record to a multitrack recorder, connect the MAIN MIX OUT to the recorder's inputs.

You can select one on-board effect and control its level with the AUX B knob for each channel. Or you can use an external effects processor by sending a signal to the external unit via the AUX SEND A and returning it via AUX RETURN A.

For monitoring you can connect the CTRL RM OUT jacks to a speaker or headphone amplifier, or just simply plug headphones into the PHONES jack.

Recording to iPod

The iMultiMix allows you to record your mix directly to an iPod. This means that anything routed to your Main Mix, such as instruments, microphones, and even audio from your computer can be recorded and played back instantly from your iPod. Note that the iPod will record your Main Mix as a stereo file so it is important to get your levels right before recording. To ensure that your recording is clean and pristine, here are some suggestions:

- Take some time to balance out the levels of your sources.
- Use the built-in Limiter feature, ensuring that your recording does not clip or distort. However, be careful when using the Limiter – if you are pushing your levels too hard, the Limiter can cause unwanted audio artifacts. There is a fine line between a good, loud recording, and a recording which is overly limited, resulting in poor dynamic range and clarity.
- Periodically, check how the recording will sound by switching the MIX TO CTRL RM button to the UP position (iPod REC MONITOR).

Your recordings will be stored as "voice memo" files on your iPod.

*Once you have finished recording a "memo," it will be placed in **Main Menu > Music > Playlists > Voice Memos**.*

*After you connect to your computer and transmit the voice memos, they can be located in **Main Menu > Music > Playlists > Voice Memos**.*

The iPod REC MONITOR signal includes the Limiter, if it has been engaged.

It is also important to understand that not all iPods are created equal and different models have different capabilities. Please refer to the following compatibility table to check whether your iPod is recording-compatible.

iPod Model	Playback	Record
iPod		
5th generation	✓	✓
3rd and 4th generation*	✓	✗
1st and 2nd generation	✗	✗
iPod nano		
2nd generation	✓	✓
1st generation	✓	✗
iPod shuffle	✗	✗
iPod mini	✓	✗

* Transport control only

Simple Live Setup

This is similar to the recording setup. In a live setup, you most likely will connect the MAIN MIX OUT to a PA system amplifier and the CTRL RM OUT to a headphone amplifier for monitoring purposes. Try connecting an external effects processor to the iMultiMix's send and receive. Your headphones will allow you to audition a channel before you bring it into the mix, making sure the levels are OK before the audience hears it.

Using Additional External Audio Sources

The iMultiMix 8 USB gives you 8 audio inputs in all. If you want to bring external audio sources into a recording or live mix, you can do it in several different ways. Using the 2-TRACK IN, you can add a tape deck, ADAT, CD player or other source to the mix. The 2-TRACK IN also can be used to entertain the audience with a CD as the band is setting up for a live show. The AUX RETURNS can be used as additional audio inputs when you are not using them for effects.

Using the Multimix USB with a Computer

Your Alesis Multimix mixer comes with a Full Speed USB port which you can connect to a computer. This USB connection allows you to send CD-quality (stereo, 16-bit, 44.1 kHz) audio between the computer and your Multimix mixer.

This feature allows you to use the Multimix USB as a highly flexible external soundcard. Use the computer's built in audio

*Out of the box, your iPod is formatted to work with a Mac, rather than a Windows computer. If you want to transfer your recordings to a Windows computer, connect your iPod to your Windows computer and allow iTunes to format it **BEFORE** you record for the first time.*

If you record to your iPod before you ever connect it to iTunes, your recordings will be stored in Mac's HFS format. They will only be readable by plugging your iPod into a Mac, not a Windows computer.

Note that, if you reformat your iPod for the Windows or Mac platform, you may lose any recordings prior to this.

recorder—or use dedicated Digital Audio Workstation software—to record and play back CD-quality audio within your computer.

A 2-meter USB cable is included. If you need to connect the Multimix across a longer distance, we recommend that you purchase a longer USB cable, as using hubs and other extenders with USB audio often causes glitches and other problems.

Sending and Receiving Audio Data

The USB port sends the Multimix's MAIN OUT/TAPE OUT left and right signals to the computer.

The USB port receives a stereo audio stream from the computer and assigns it to the TAPE IN left and right channels of your Multimix mixer. Note that, if a device is connected to the Multimix's TAPE IN inputs, the signal from this device is merged with the signal from the computer.

Precautions when using the USB connection

To ensure that the Multimix is recognized correctly by your computer, always turn the Multimix on a few seconds before inserting the USB cable into the computer. When powering up both your computer and the Multimix, turn on the Multimix first and the computer second. When powering down your computer and the Multimix, turn off the computer first. Wait to turn off the Multimix until the computer has shut down.

Connection instructions for Windows (XP, 2000, ME, and 98 Second Edition)

Upon first sensing the Multimix's USB input, Windows XP and Windows 2000 automatically recognize the Multimix and proceed to install "USB audio codec" drivers. Windows ME and Windows 98 Second Edition may require you to insert your Windows disc, after which the drivers should load correctly. [verify this]

After the Multimix has been recognized and its drivers have been installed, open the Control Panel. Select Sounds and Audio Devices (or Multimedia), go to the Audio tab, and select the "USB audio codec" as your default sound recording and sound playback device.

Connection instructions for Macintosh (OS X only)

After plugging in the Multimix, select "USB Audio CODEC" in the Sound area of System Preferences. No other action is required.

The Multimix USB is not designed for use with Mac OS9 and below.

This page intentionally left blank.

5 Troubleshooting

If you're having problems operating the iMultiMix 8 USB, this troubleshooting index will help you correct them.

Symptoms	Cause	Solution
No sound from the mixer.	Mixer is not plugged in or turned on.	Plug in mixer and turn it on.
	Channel levels are too low.	Turn up channel levels.
	Control room level is turned down	Turn up control room level.
	The appropriate signal hasn't been assigned to the control room out.	In the master section of the mixer, be sure the right switch is selected.
	Cable is not plugged into output jack.	Check outputs to make sure cables are plugged in securely.
	Headphones are not plugged into PHONE jack.	Plug headphones into PHONE jack.
	Monitor or headphone amplifier is turned off or down.	Turn amplifier on or up.
Audio signal is distorted.	Bad cable.	Check all cables; substitute cables with known good ones.
	Channel level is too high.	Set channel levels using the procedure on page 8.
	Channel input is too high.	Turn down your instrument to a normal volume and then set channel levels using procedure on page 8.
	AUX RET level is too high.	Lower the level of AUX RET A or B in the master section of the mixer.
My iPod recording is distorted.	MAIN MIX level is too high.	Turn down the MAIN MIX level control in the master section of the mixer.
	Limiter is not engaged.	Press the LIMITER button to engage this feature – it will prevent your recording from clipping and distorting.
	Limiter is working too hard.	If your levels are too hot, the Limiter can still produce unwanted artifacts and distortion. Turn down the iPod REC LEVEL and use the iPod REC MONITOR to hear how the mix will sound.

5 Troubleshooting

Audio signal carries an unwanted hum.

Too much low-level noise in the mix.

Engage the channel's high-pass filter by pressing the HPF switch.

Interference from appliances such as air conditioners.

Engage the channel's high-pass filter by pressing the HPF switch.

Not using TRS cables.

Make sure you are using 1/4" TRS cables.

Microphone level is too low.

Phantom power is not turned on.

Turn on phantom power using the switch on the rear panel of the mixer.

Microphone is damaged.

Test the microphone on other audio devices. If you detect damage, contact the manufacturer or dealer.

No or low sound from a channel.

Channel level is too low.

Turn up channel level.

Instrument volume is too low.

Turn up the instrument's volume control. If problem persists, check the instrument by plugging headphones into the instrument's phone jack.

Gain is too low.

Adjust the channel's GAIN control.

Internal effects aren't working.

Effects level is too low.

Turn up the level using the EFFECTS / AUX RET B LEVEL control in the master section of the mixer.

An effect hasn't been selected.

Press the EFFECTS knob on the desired effect and make sure the SIG indicator is lit.

I cannot record with my iPod.

iPod model not compatible for recording.

See compatibility chart on page 20 for information on compatible iPods.

I cannot play music from my iPod.

iPod model not compatible for playback.

See compatibility chart on page 20 for information on compatible iPods.

My iPod will not charge while recording.

Charging while recording is disabled.

Charging while recording may introduce low level noise into your recording and is, by default, disabled. You can enable charging by pressing |<< and >>| together for one second while recording. Press the buttons again to disable.

External effects aren't working.

Effects processor is not plugged in or turned on.

Make sure unit is plugged in and turned on.

Aux outputs of mixer aren't connected to inputs of processor or processor's outputs aren't connected to mixer's inputs.

Make sure the mixer's aux outputs are connected to the processor's inputs and that the processor's outputs are connected to the mixer's aux inputs.

Mixer's effects return signal is too low.

Turn up the output of the effects processor or turn up the mixer's AUX RET A LEVEL or EFFECTS / AUX RET B LEVEL in the master section.

LED meters not working.

Nothing is routed to the HDPH/CTRL RM output.

Press the desired MIX or 2 TK To Mix button.

Computer does not see the Multimix.

USB connection must be established.

Unplug the USB cable and turn off the Multimix. Turn the Multimix back on and plug the cable back in. If this does not work, leave the Multimix on, turn off the computer (do not use "restart" but instead actually turn off the computer) and then turn it on again.

Computer sees the Multimix USB, but no sound is received and/or transmitted.

Multimix USB is not set as primary sound device.

In the computer's Control Panel, go to the Sounds/Multimedia area. In the Audio section, set the default sound recording and playback devices to "USB audio codec."

USB audio has crackling or glitches, or audio plays/records at incorrect pitch.

USB hub may be in use.

If you are using a USB hub, disconnect the Multimix from it and connect the mixer to the computer directly instead.

Computer configuration may be incompatible with USB audio.

Certain USB chipsets have design limitations or IRQ assignment restrictions that must be resolved before audio can work correctly on them. See your USB chipset documentation for further information if required.

No power.

Incorrect or defective power supply.

Replace with correct power supply (only use Alesis-recommended AC output power supply).

This page intentionally left blank

6 Specifications

For the more technical-minded, here are some detailed specifications for the iMultiMix's operating levels.

Input Channels

Mic In Sensitivity Range:	-60dBu to -10dBu nominal, +5dBu maximum
Line In Sensitivity Range:	-40dBu to +10dBu nominal, +25dBu maximum
Mic/Line Gain Range:	+10 to +60dB

Equalization

High-Pass Filter:	75Hz, 18dB/octave
High Shelving:	12kHz, +/- 15dB
Mid Bandpass/Band Reject:	2.5 kHz, +/- 15dB
Low Shelving:	80Hz, +/- 15dB

Aux Sends

Aux Send A & B Gain Range: $-\infty$ to +10dB

Aux Returns

Aux Return A Gain Range:	$-\infty$ to +15dB
Effects Level/	
Aux Return B Gain Range:	$-\infty$ to +15dB

Channel Levels

Channel Level Gain Range: $-\infty$ to +10dB

Master Levels

Main Mix, Ctrl Room Gain Range: $-\infty$ to +10dB

1/4" Inputs

Stereo Aux Return Level: +4dBu nominal, +20dBu maximum

RCA Inputs

Tape In Level: -10dBV nominal, +5dBV maximum

1/4" Outputs

Main Mix, Ctrl Room, Ext Aux Send Level: +4dBu nominal, +20dBu maximum

Headphone Output: 75 ohm output impedance
>105mW into 75 ohms, >40mW into 600ohms

RCA Outputs

Tape Out Level: -10dBV nominal, +5dBV maximum

All measurements done over a 22Hz – 22kHz range with a 1kHz sine wave at +18dBu (-1dBFS) input. Impedances are measured at 1kHz.

This page intentionally left blank

7 Block Diagram

ALESIS 8-CHANNEL ANALOG MIXER

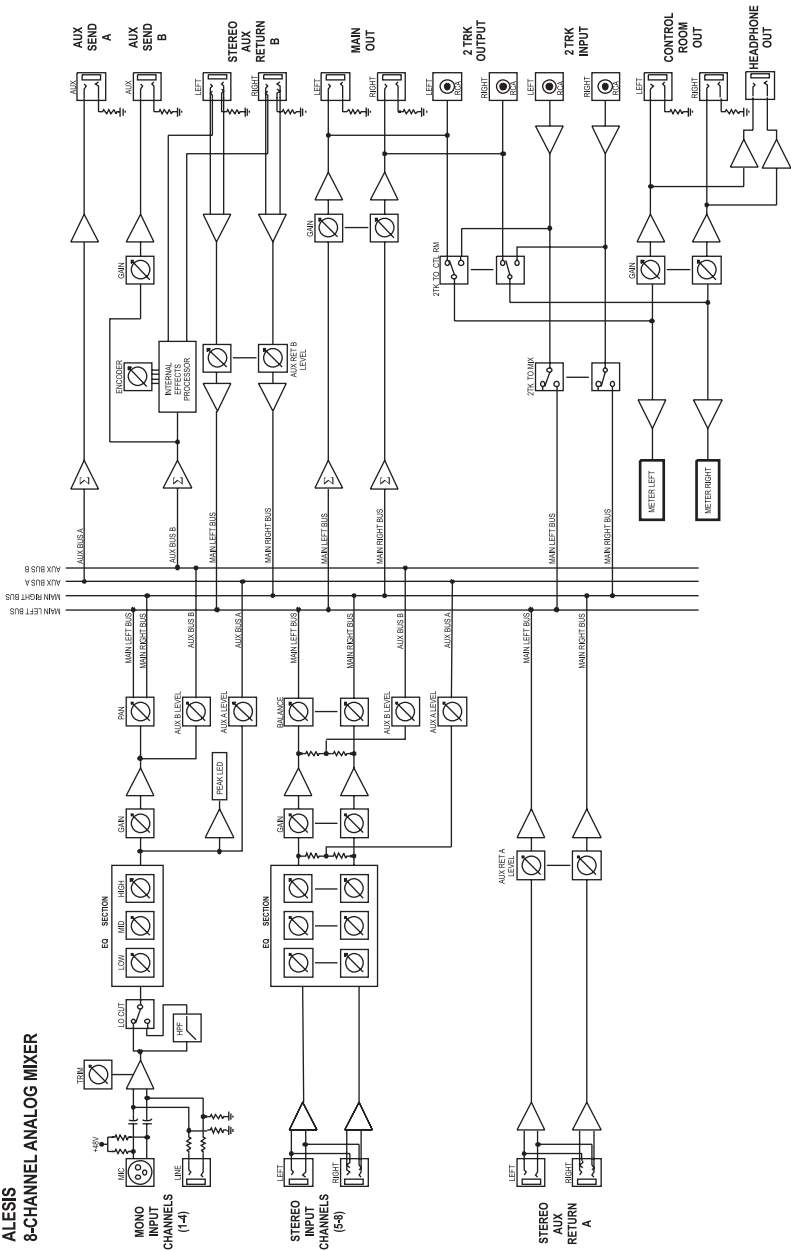

7 Block Diagram

This page intentionally left blank

Glossary

Here are the definitions to some terms you'll probably encounter while using your iMultiMix 8 USB.

Term	Definition
aux (auxiliary)	An additional set of outputs and inputs found on many mixers. These allow the addition of external effects and other audio sources.
balance	A control that lets you control the position of sound in a stereo signal by altering the relative levels of the left and right channels.
bus	The electrical component that carries signals from multiple sources to a single destination such as an amplifier.
channel	A path through which an audio signal flows.
channel strip	A section of a mixer on which reside controls like a fader, EQ and pan for manipulating the signal of an input channel.
clipping	The cutting of an audio signal caused by a level that is too great for a mixer circuit to handle.
codec	Compression/decompression algorithm. Different CODECs are used by different digital audio devices and file formats.
condenser microphone	A type of high-quality microphone that produces a weak signal, usually requiring an external power source like the ones provided by your iMultiMix 8 USB's XLR mic inputs.
dB (decibel)	A common unit of measure for audio.
detent	A point of resistance in the path that a mixer knob or fader travels. Detents are used to mark important settings. As you turn the knob or slide the fader, you'll feel it "click" into the detent.
dry	Term used to describe an audio signal free of effects. The opposite of "wet."
dynamic microphone	A common type of microphone that does not require external power. Dynamic microphones are generally cheaper than condenser microphones.
effects processor	A unit whose purpose is to provide effects for audio signals. Some common effects include reverb, chorus, flange and delay. Effects processors come in many shapes and sizes, from small pedals up to rectangular rackmount units.
EQ (equalizer)	The part of your mixer (or other device) that manipulates an audio signal by lowering the level of some frequencies and increasing the levels of others. EQ is used to fine-tune a signal's highs and lows.

Glossary

gain	The measure of extra amplification applied to an audio signal. Channels 1 – 4 on your iMultiMix 8 USB have gain controls, which are useful for boosting mic and line signals.
level	The amount of power driving an audio signal. The most common names given to levels of varying voltage are, from lowest to highest, microphone level, instrument level and line level.
master section	The section of a mixer where the main mix is controlled.
mic preamp	An amplifier that boosts a microphone-level signal up to line level.
mixer	A device whose purpose is to combine and output a number of audio signals, allowing various types of signal manipulation.
mono (monaural)	Refers to an audio signal that has only one channel. The opposite of stereo.
pan	A control that lets you position a mono signal within the stereo spectrum by altering the level of the signal being sent to the left channel as opposed to the right.
phantom power	A way of providing power to condenser microphones. Called “phantom” because the power isn’t apparent to dynamic microphones when you connect them to an input that provides phantom power.
post-fader	Describes an aux send that sends a signal that already has passed through the channel fader.
pre-fader	Describes an aux send that sends a signal that has not passed through the channel fader.
return	A line input whose function is to carry back to the mixer an audio signal that has been sent from the mixer. Usually used in the application of effects.
send	A line output whose function is to send a signal from the mixer to an external device, usually an effects processor.
stereo	Refers to an audio signal that has two channels.
unity gain	Refers to the setting of an audio channel at which the signal leaves the channel at the same level at which it entered.
wet	An audio signal that has had effects or other manipulations applied. The opposite of “dry.”

Warranty / Contact

Alesis Limited Warranty

ALESIS CORPORATION ("ALESIS") warrants this product to be free of defects in material and workmanship for a period of one (1) year for parts and for a period of one (1) year for labor from the date of original retail purchase. This warranty is enforceable only by the original retail purchaser and cannot be transferred or assigned. For the most effective service, the purchaser should register the purchase on the ALESIS website at <http://www.alesis.com/support/warranty.htm>.

During the warranty period ALESIS shall, at its sole and absolute option, either repair or replace free of charge any product that proves to be defective on inspection by ALESIS or its authorized service representative. In all cases disputes concerning this warranty shall be resolved as prescribed by law.

To obtain warranty service, the purchaser must first call or write ALESIS at the address and telephone number available on the Alesis Website to obtain a Return Authorization Number and instructions concerning where to return the unit for service. All inquiries must be accompanied by a description of the problem. All authorized returns must be sent to ALESIS or an authorized ALESIS repair facility postage prepaid, insured and properly packaged. Proof of purchase must be presented in the form of a bill of sale, canceled check or some other positive proof that the product is within the warranty period. ALESIS reserves the right to update any unit returned for repair. ALESIS reserves the right to change or improve design of the product at any time without prior notice.

This warranty does not cover claims for damage due to abuse, neglect, alteration or attempted repair by unauthorized personnel, and is limited to failures arising during normal use that are due to defects in material or workmanship in the product.

THE ABOVE WARRANTIES ARE IN LIEU OF ANY OTHER WARRANTIES OR REPRESENTATIONS WHETHER EXPRESS OR IMPLIED OR OTHERWISE, WITH RESPECT TO THE PRODUCT, AND SPECIFICALLY EXCLUDE ANY IMPLIED WARRANTIES OF FITNESS FOR A PARTICULAR PURPOSE OR MERCHANTABILITY OR OTHER IMPLIED WARRANTIES. Some states do not allow limitations on how long an implied warranty lasts, so the above limitation may not apply to you. IN NO EVENT WILL ALESIS BE LIABLE FOR INCIDENTAL, CONSEQUENTIAL, INDIRECT OR OTHER DAMAGES RESULTING FROM THE BREACH OF ANY EXPRESS OR IMPLIED WARRANTY, INCLUDING, AMONG OTHER THINGS, DAMAGE TO PROPERTY, DAMAGE BASED ON INCONVENIENCE OR ON LOSS OF USE OF THE PRODUCT, AND, TO THE EXTENT PERMITTED BY LAW, DAMAGES FOR PERSONAL INJURY. Some states do not allow the exclusion or limitation of incidental or consequential damages, so the above limitation or exclusion may not apply to you.

THIS CONTRACT SHALL BE GOVERNED BY THE INTERNAL LAWS OF THE STATE OF CALIFORNIA WITHOUT REFERENCE TO CONFLICTS OF LAWS. This warranty gives you specific legal rights, and you may also have other rights required by law which vary from state to state.

This warranty only applies to products sold to purchasers in the United States of America or Canada. The terms of this warranty and any obligations of Alesis under this warranty shall apply only within the country of sale. Without limiting the foregoing, repairs under this warranty shall be made only by a duly authorized Alesis service representative in the country of sale. For warranty information in all other countries please refer to your local distributor.

For more effective service and product update notices, please register your iMultiMix 8 USB online at:

<http://www.alesis.com/support/warranty.htm>

Alesis Contact Information

Alesis, LLC
Los Angeles, CA USA

E-mail: support@alesis.com
Web site: <http://www.alesis.com>

iMultiMix 8 USB Reference Manual
Revision 1.0 by Edwin Erdmann, Fred Morgenstern, Stephan Vankov

Copyright 2007, Alesis, LLC. All rights reserved.
Reproduction in whole or in part is prohibited. "iMultiMix 8 USB"
is a trademark of Alesis, LLC. Specifications subject to change
without notice.

7-51-0237-C
7/06/2007

7-51-0237-C

Free Manuals Download Website

<http://myh66.com>

<http://usermanuals.us>

<http://www.somanuals.com>

<http://www.4manuals.cc>

<http://www.manual-lib.com>

<http://www.404manual.com>

<http://www.luxmanual.com>

<http://aubethermostatmanual.com>

Golf course search by state

<http://golfingnear.com>

Email search by domain

<http://emailbydomain.com>

Auto manuals search

<http://auto.somanuals.com>

TV manuals search

<http://tv.somanuals.com>