

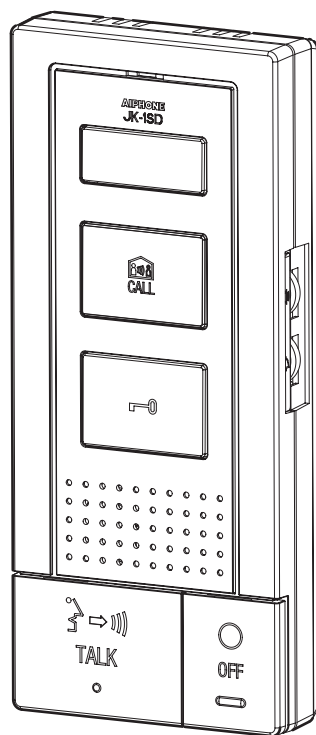

JK-1SD

**AUDIO ONLY SUB MASTER STATION
 POSTE SECONDAIRE AUDIO
 APARATO PRINCIPAL ANEXO AUDIO SOLAMENTE
 PARLOFOON-BIJPOST
 POSTAZIONE PRINCIPALE SECONDARIA CON SOLO AUDIO**



JK-1SD

*AUDIO ONLY SUB MASTER STATION
 POSTE SECONDAIRE AUDIO
 APARATO PRINCIPAL ANEXO AUDIO
 SOLAMENTE
 PARLOFOON-BIJPOST
 POSTAZIONE PRINCIPALE SECONDARIA
 CON SOLO AUDIO*

**INSTALLATION & OPERATION MANUAL
 MANUEL D'INSTALLATION ET D'UTILISATION
 MANUAL DE INSTALACIÓN Y OPERACIÓN
 INSTALLATIE- EN BEDIENINGSHANDLEIDING
 MANUALE D'INSTALLAZIONE E USO**

PRECAUTIONS

- ⊘ General Prohibitions ⊘ Prohibition on Subjecting the Unit to Water ⊘ Prohibition to Dismantle the Unit ! General Precautions

⚠ WARNING

(Negligence could result in death or serious injury.)

- ⊘ 1. High voltage is present internally. Do not open the case. Electric shock could result.
- ⊘ 2. Do not dismantle or alter the unit. Fire or electric shock could result.
- ⊘ 3. Do not connect non-specified power sources to the +, - terminals. Also, do not install two power supplies in parallel to a single input. Fire or damage to the unit could result.
- ⊘ 4. Keep the unit away from water or any other liquid. Fire or electric shock could result.
- ⊘ 5. Do not put any metal or flammable material into the unit through the openings. Fire or electric shock could result.
- ⊘ 6. Do not use a power supply with a voltage other than the specified voltage. Fire or electric shock could result.
- ⊘ 7. Do not connect any terminal on the unit to an AC power line. Fire or electric shock could result.

⚠ CAUTION

(Negligence could result in injury to people or damage to property.)

- ⊘ 1. Do not install or make any wire terminations while power supply is plugged in. It can cause electrical shock or damage to the unit.
- ! 2. Before turning on power, make sure wires are not crossed or shorted. If not, fire or electric shock could result.
- ! 3. When mounting the unit on a wall, install the unit in a convenient location, but not where it could be jarred or bumped. Injury could result.
- ! 4. For power supply, use Aiphone power supply model or model specified for use with system. If non-specified product is used, fire or malfunction could result.
- ⊘ 5. Do not install the unit in any of the following locations. Fire, electric shock, or unit trouble could result.
 - * Places under direct sunlight or places near heating equipment that varies in temperature.
 - * Places subject to dust, oil, chemicals, etc.
 - * Places subject to moisture and humidity extremes, such as bathrooms, cellars, greenhouses, etc.
 - * Places where the temperature is quite low, such as inside a refrigerated area or in front of an air conditioner.
 - * Places subject to steam or smoke (near heating or cooking surfaces).
 - * Where noise generating devices such as dimmer switches or inverter electrical appliances are close by.
 - * Do not install the unit in locations subject to frequent vibration or impact.
- ⊘ 6. Do not put anything on the unit or cover the unit with cloth, etc. Fire or unit trouble could result.

General Precautions

1. Keep the unit more than 1 m away from radio or TV set.
2. This unit is for indoor use only. Do not use outdoors.
3. In areas where broadcasting station antennas are close by, the intercom system may be affected by radio frequency interference.
4. As for devices from other manufacturers (such as sensors, detectors, door releases) used with this system, comply with the specifications and warranty conditions from the manufacturer or vender.
5. Keep the intercom wires at least 30 cm (12") away from AC 100-240 V lines. Noise and malfunction could result.
6. If the unit is down or does not operate properly, unplug the power supply or turn off the JK-1MED, JK-1MD, and JK-1SD POWER switches.
7. The unit is for wall-mount use only. For desktop applications, use desk stand.
8. When wall-mounted, the top of the unit may darken. This does not indicate a malfunction.
9. The unit case may become warm with use, but this is not a unit malfunction.
10. If a cellular phone is used close by, the unit may malfunction.
11. Talk within 50 cm (20") or less from the unit. If you stand too far away, it may be difficult for the other person to hear the communication.
12. If there are loud noises around the unit (such as music playing or children crying), the sound may break up and be difficult to hear.
13. During communication, if you speak before the other person has finished talking, your voice may not be heard. Communication will proceed smoothly if you wait until the other person has finished before speaking.
14. Noise from the surrounding area may sometimes hinder natural communication, but this is not a malfunction.
15. This unit is not interchangeable with JA, JF, KB, and KC series units.

1 PACKAGE CONTENTS

JK-1SD



Mounting screws x 2



Wood mounting screws x 2



Installation & Operation manual

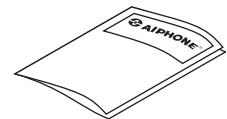

2 INSTALLATION

2-1 Mounting locations

The JK-1SD has switches on both sides. Allow at least 5 cm (2") of open space on either side. Allow at least 15 cm (6") of vertical open space from the center of the mounting bracket in order to mount the JK-1SD.

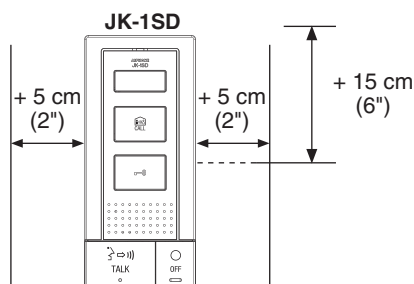

2-2 Wiring method, wiring distance

Wire the inside units from station-to-station (daisy-chained).

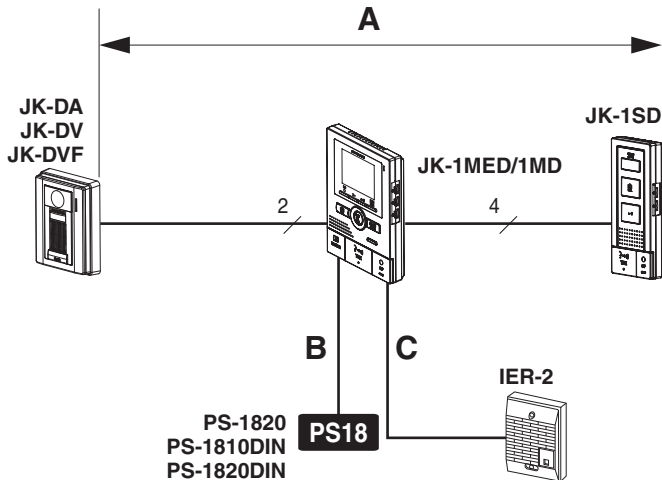

	Ø 0.65 mm	22 AWG	Ø 1.0 mm	18 AWG
A	50 m	165'	100 m	330'
B	5 m	16'	10 m	33'
C	75 m	245'	150 m	490'

2-3 Cable

1 Use PVC-coated cable with PE (polyethylene) insulation.



2 Never use individual conductors, twisted pair cable or coaxial cable.

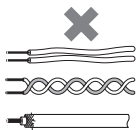

3 When using a cable with unused conductors, terminate both ends of the unused pair(s) with a 120 Ω resistor.

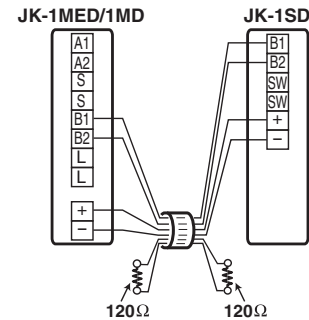

3 MOUNTING

Mounting on a gang box

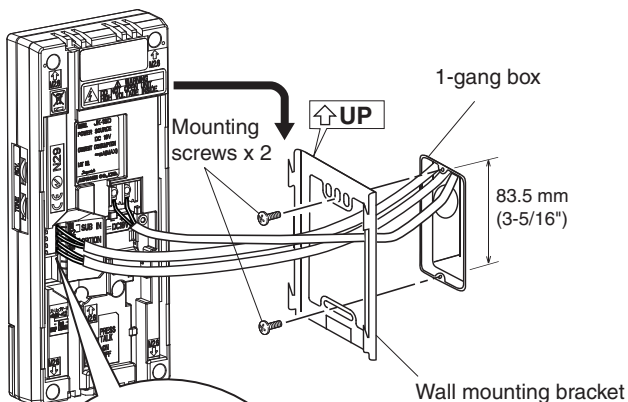

Surface wiring

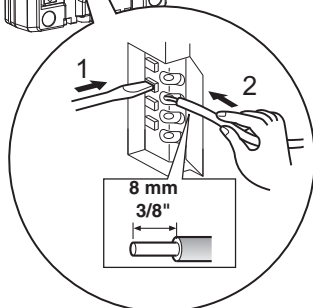
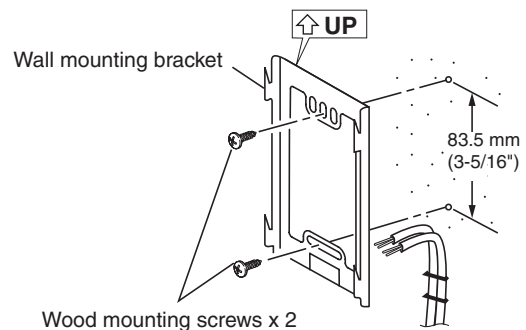

1. Press RELEASE button. (This is performed to release the lock or to securely insert wiring.)

2. Insert the cable into the terminal.

4 WIRING

JK-1MED/1MD Master monitor station

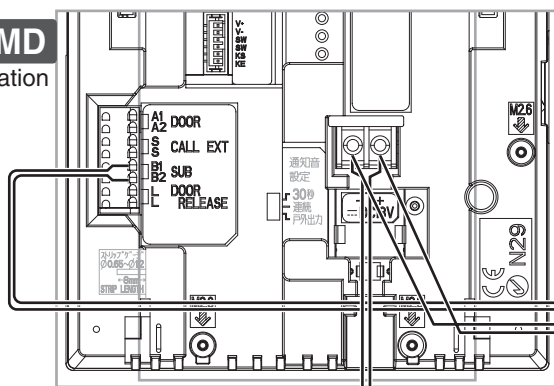

JK-1SD Audio only sub master station



Audio only sub master station

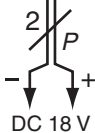
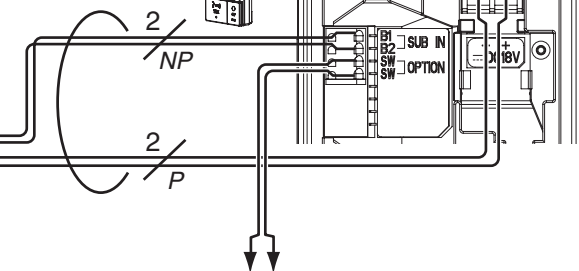

Power supply +, - (DC 18 V)

(To optional units)
(AC/DC 24 V, 1.6 A N/O dry closure contact)
(Minimum Contact : 100 mV DC, 0.1 mA)

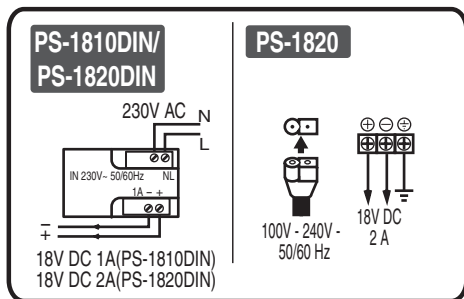

NP: Non-polarized
P: Polarized

5 NAMES

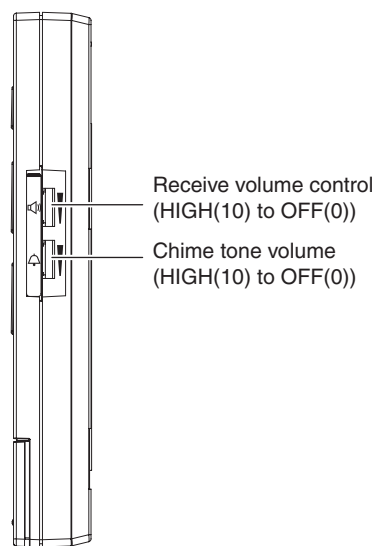
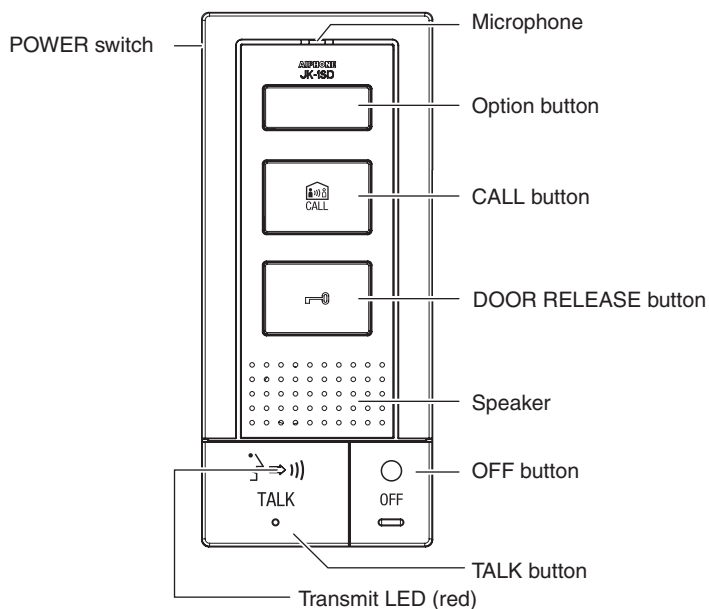

6 OPERATIONS

6-1 Answering a door call (HANDS-FREE mode, PTT mode)

1 Press CALL button.



2 The chime tone sounds and incoming audio will be heard.
• Audio turns off after approx. 45 seconds if not answered.

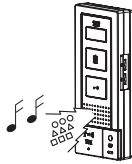

3 Press $\overset{\text{P}}{\text{T}}\text{TALK}$ button momentarily, and after the beep, communicate hands free.

Transmit LED (red) lights when you talk, and goes off as you listen to caller (or hear outside sounds).

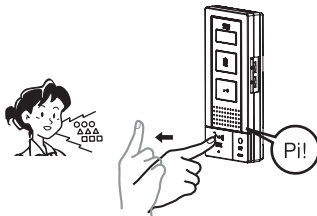

4 After finishing communication, pressing OFF button and communication will end after the beep.

NOTES:

- Communication ends automatically after the times listed below.
 - JK-1MED: Time set at master station (approximately 1 min., 2 min., 3 min., 5 min.)
 - JK-1MD: Approximately 1 min.
- The Transmit LED will light up and go out, but this is not a malfunction.

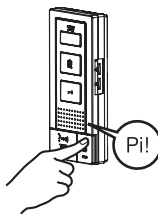

Instant voice call function

2 Even without answering, door area can be heard with audio (for approx. 45 seconds). Inside sound is not heard outside.

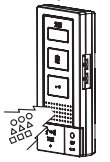
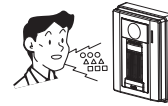

PTT mode

3 Press and hold the $\overset{\text{P}}{\text{T}}\text{TALK}$ button for 1 second or more. A beep sounds, and after approx. 1 second another beep sounds, PTT mode is entered. If $\overset{\text{P}}{\text{T}}\text{TALK}$ button is pressed briefly (less than 0.5 seconds), switching to press-to-talk is not performed.

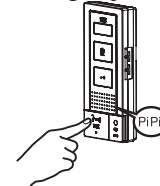

4 When communicating, keep $\overset{\text{P}}{\text{T}}\text{TALK}$ button pressed. To hear the caller's voice, release $\overset{\text{P}}{\text{T}}\text{TALK}$ button.

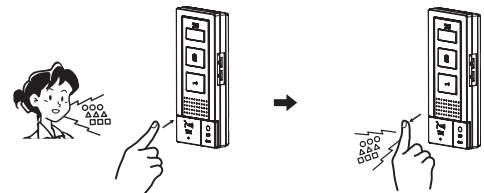

5 After finishing communication, pressing OFF button and communication will end after the beep.

NOTES: When press-to-talk is disabled by master monitor station, PTT mode cannot be used.

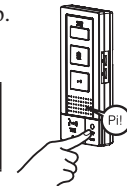

6-2 Activating door release

1 Press DOOR RELEASE button.



2 Open door while the release mechanism is activated.



6-3 Room-to-room communication

- 1 Press  CALL button to talk with the other person.
 - A call-in is sent to the master monitor station.
 - The reply of the other person is not heard.

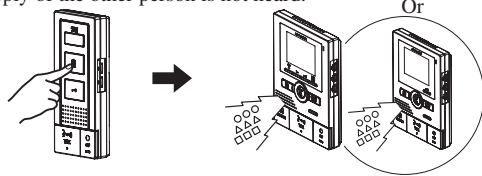

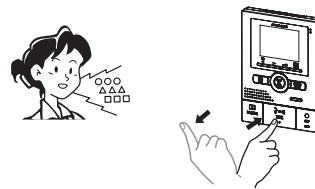

- 2 If the other person presses  TALK button, hands free communication is possible.



- 3 Press and release  OFF button to end communication.





NOTES:

1. Room-to-room communication ends automatically after approx. 10 minutes. To perform room-to-room communication again, repeat from the beginning.
2. If a call is received from the entrance during room-to-room communication, a chime tone sounds. Press  OFF button to end the room-to-room communication, and press  TALK button to switch to communication with the door station.

6-4 If optional units are installed

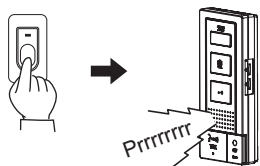
- 1 When a separately-installed sensor detects a malfunction or CALL button is pressed, the alarm sound occurs and the transmit LED (red) flashes.



- 2 Press  OFF button to stop the alarm sound.



- ⚠ 1. The alarm sounds aren't interlocked with chime tone volume. The alarm sounds at a level equivalent to 10 (HIGH) (fixed).
- ⚠ 2. The length of the alarm sound varies depending on the specifications of the connected monitor station.
- ⚠ 3. When connecting with JK-1MD, the alarm sound stops after 30 seconds and restoration occurs even if  OFF button is not pressed.

7 TECHNICAL PRECAUTIONS

- Operating temperature: 0 °C to 40 °C (+32 °F to +104 °F)
- Cleaning: Clean the units with a soft cloth dampened with a neutral household cleanser. Do not use any abrasive cleaner or cloth.
- If there is a system malfunction, turn the POWER switch at the master station OFF and back ON again. If this does not solve the problem, unplug the DC power supply and contact a qualified technician for service.

8 SPECIFICATIONS

- Power source: DC 18 V
- Current consumption: (Max.) 120 mA
- Calling: Chime, approx. 45 seconds
- Communication method: <HANDS-FREE mode> Hands-free: approx. 60 sec.
<PTT mode> Press-to-talk, release to listen: approx. 60 seconds
- Dimensions: 185 (H) x 80 (W) x 27 (D) (mm)
7-5/16 (H) x 3-1/8 (W) x 1-1/16 (D) (inches)
- Weight: Approx. 250 g (0.55 lbs.)

Warranty

English

Aiphone warrants that its products have no material or workmanship defects under normal use conditions for two years after delivery to the end user. Aiphone will perform repair or replacement free of charge if the product is defective and the warranty applies to the defect. Aiphone reserves unto itself the sole right to make the final decision whether there is a defect in materials and/or workmanship and whether or not the product is under warranty. This warranty shall not apply to any Aiphone product which has been subject to misuse, neglect, accident, or to use in violation of instructions furnished, nor extended to units which have been repaired or altered outside of the factory. This warranty does not cover batteries or damage caused by batteries used in connection with the unit. This warranty only includes carry-in repairs. Any repairs must be made at the shop or place designated in writing by Aiphone. Aiphone will not be responsible for any costs incurred during on-site service calls. Aiphone will not provide compensation for any loss or damage incurred by the breakdown or malfunction of its products during use, or for any consequent inconvenience or losses that may result.

Garantie

Français

Aiphone garantit que ce produit ne présente pas de défaut matériel ou de fabrication dans des conditions normales d'utilisation pendant les deux années suivant la livraison à l'utilisateur final. Aiphone en effectuera gratuitement la réparation ou le remplacement si le produit est défectueux et que la garantie s'applique pour le défaut. Aiphone se réserve le droit exclusif de décider s'il existe ou non un défaut de matière ou de fabrication et si l'appareil est ou non couvert par la garantie. Cette garantie ne s'applique pas à tout produit Aiphone qui a été l'objet d'une utilisation impropre, de négligence, d'un accident ou qui a été utilisé en dépit des instructions fournies; elle ne couvre pas non plus les appareils qui ont été réparés ou modifiés en dehors de l'usine. Cette garantie ne couvre pas les piles ni les dégâts infligés par les piles utilisées dans l'appareil. Cette garantie comprend uniquement les réparations en atelier. Toutes les réparations doivent être réalisées à l'atelier ou au site désigné par écrit par Aiphone. Aiphone décline toute responsabilité en cas de frais encourus pour les dépannages à domicile. Aiphone n'indemniserà pas le client en cas de pertes, de dommages ou de désagréments causés par une panne ou un dysfonctionnement d'un de ses produits.

Garantía

Español

Aiphone garantiza que sus productos no tienen defectos de material ni de mano de obra bajo condiciones de uso normal durante dos años tras su entrega al usuario final. Aiphone realizará la reparación o cambio libre de costo si el producto está defectuoso y la garantía se aplica al defecto. AIPHONE se reserva el derecho de tomar la decisión final de si hay o no defectos de material y/o de mano de obra, y de si el producto está o no cubierto por la garantía. Esta garantía no cubre ningún producto AIPHONE que haya sido mal utilizado, descuidado, accidentado, o empleado violando las instrucciones suministradas; la garantía tampoco se aplica a unidades que hayan sido reparadas o alteradas por personas fuera de la fábrica. Esta garantía no cubre las pilas ni los daños causados por pilas utilizadas asociadas a la unidad. Esta garantía sólo incluye reparaciones acarreadas por el cliente. Todas las reparaciones deben realizarse en el taller o lugar que Aiphone designe por escrito. Aiphone no se responsabilizará de los gastos generados durante llamadas de servicio. Aiphone no indemnizará por ninguna pérdida o daño en que se incurra debido a la avería o falla de sus productos durante su uso, ni por ningún inconveniente o pérdida que se produzca como consecuencia.

Garantie

Nederlands

Aiphone garandeert dat zijn producten onder normale gebruiksomstandigheden gedurende twee jaar na levering aan de eindgebruiker vrij zijn van materiaal- of fabricagefouten. Aiphone zal het product kosteloos herstellen of vervangen als het defect is en de garantie van toepassing is op het defect. Aiphone behoudt zich het recht voor om als enige definitief te bepalen of er al dan niet sprake is van een materiaal- en/of fabricagefout; en of het product nog onder garantie is. Deze garantie geldt niet voor een Aiphone-product dat is blootgesteld aan verkeerd gebruik, verwaarlozing, een ongeval of verkeerde bediening en evenmin voor toestellen die buiten de fabriek zijn hersteld of gewijzigd. Deze garantie geldt niet voor batterijen of schade veroorzaakt door batterijen die in het toestel zijn gebruikt. Deze garantie geldt uitsluitend voor herstellingen die worden ingeleverd en opgehaald door de klant. Alle herstellingen moeten worden uitgevoerd in de winkel of op de plaats die schriftelijk is aangeduid door Aiphone. Kosten die gepaard gaan met herstellingen ter plaatse kunnen niet worden verhaald op Aiphone. Er kan geen schadeloosstelling van Aiphone worden geëist voor enig verlies of schade als gevolg van een defect of storing tijdens het gebruik van zijn producten, of voor enig ongemak of verlies dat hieruit voortvloeit.

Garanzia

Italiano

La Aiphone garantisce che i suoi prodotti saranno privi di difetti nei materiali o nella lavorazione, in condizioni di utilizzo normali, per un periodo di due anni dalla consegna all'utente finale. La Aiphone eseguirà la riparazione o la sostituzione gratuita del prodotto qualora tale prodotto debba risultare difettoso e la garanzia sia applicabile al difetto rilevato. La Aiphone si riserva il diritto esclusivo di stabilire in via definitiva se sono presenti difetti nei materiali e/o nella lavorazione e se il prodotto è coperto dalla garanzia oppure no. La presente garanzia non è applicabile ad alcun prodotto Aiphone che sia stato sottoposto ad uso improprio, negligenza, incidente, o che sia stato utilizzato in violazione alle istruzioni fornite, né può essere estesa alle unità che sono state riparate o manomesse al di fuori della fabbrica. Questa garanzia non copre le batterie né i danni causati dalle batterie usate in connessione con l'unità. Questa garanzia copre solo le riparazioni del prodotto consegnato presso il punto designato. Le eventuali riparazioni devono essere eseguite presso l'officina o il luogo designato per iscritto dalla Aiphone. La Aiphone non potrà essere ritenuta responsabile di eventuali costi sostenuti in caso di chiamata per l'assistenza sul posto. La Aiphone non offrirà alcun compenso per gli eventuali danni o perdite subiti a causa della rottura o del guasto dei suoi prodotti durante l'uso, o per qualsiasi disagio o perdita conseguente che si dovesse verificare.

This device complies with Part 15 of the FCC Rules. Operation is subject to the following two conditions: (1) this device may not cause harmful interference, and (2) this device must accept any interference received, including interference that may cause undesired operation.



AIPHONE®

Providing Peace of Mind

<http://www.aiphone.com/>

AIPHONE CO., LTD., NAGOYA, JAPAN
AIPHONE CORPORATION, BELLEVUE, WA, USA
AIPHONE S.A.S., LISSES-EVRY, FRANCE

Printed in Thailand

Free Manuals Download Website

<http://myh66.com>

<http://usermanuals.us>

<http://www.somanuals.com>

<http://www.4manuals.cc>

<http://www.manual-lib.com>

<http://www.404manual.com>

<http://www.luxmanual.com>

<http://aubethermostatmanual.com>

Golf course search by state

<http://golfingnear.com>

Email search by domain

<http://emailbydomain.com>

Auto manuals search

<http://auto.somanuals.com>

TV manuals search

<http://tv.somanuals.com>