

## VY Series PanTilt VIDEO ENTRANCE CALL SYSTEM

Models: **VY-5EM** (5-call)  
**VY-10EM** (10-call)

### INSTALLATION & OPERATION MANUAL

#### CONTENTS

1 SYSTEM OUTLINE & COMPONENTS.....	1
2 NAMES & FEATURES .....	2
3 PRECAUTIONS ON INSTALLATION & WIRING .....	3
4 WIRING.....	4 ~ 10
5 MOUNTING .....	11 ~ 12
6 OPERATIONS on VY-EM AND MY .....	13 ~ 14
7 TECHNICAL PRECAUTIONS.....	15
8 SPECIFICATIONS.....	16

## 1 SYSTEM OUTLINE AND COMPONENTS

#### ■ System outline



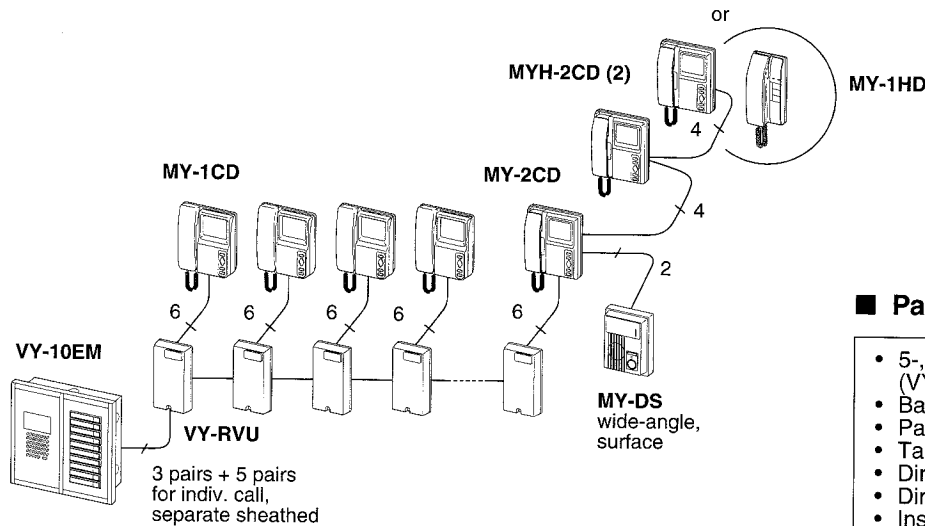

The VY-EM Series is a 5- or 10-call PanTilt entrance-call panels. Residential monitor MY-1CD or MY-2CD may be installed in conjunction with VY-RVU adaptors.

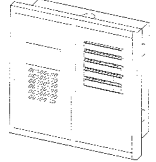
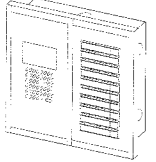
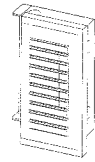

#### ■ Package contents

- 5-, 10-call entrance panel (VY-5EM, VY-10EM)
- Back box
- Packet of screws
- Tamper-proof screwdriver
- Directory card
- Directory opener
- Installation & Operation Manual

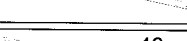
#### ■ Components available

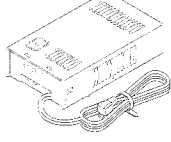
VY-5EM	VY-10EM	VY-10U	VYK-A20, 30, 40	VY-RVU	PS-24N
5-call entrance panel	10-call	10-call add-on	Junction bar, 20-call	Residential adaptor	Power supply
			 30-call  40-call 		

## ■ Components available

### • Residential monitor

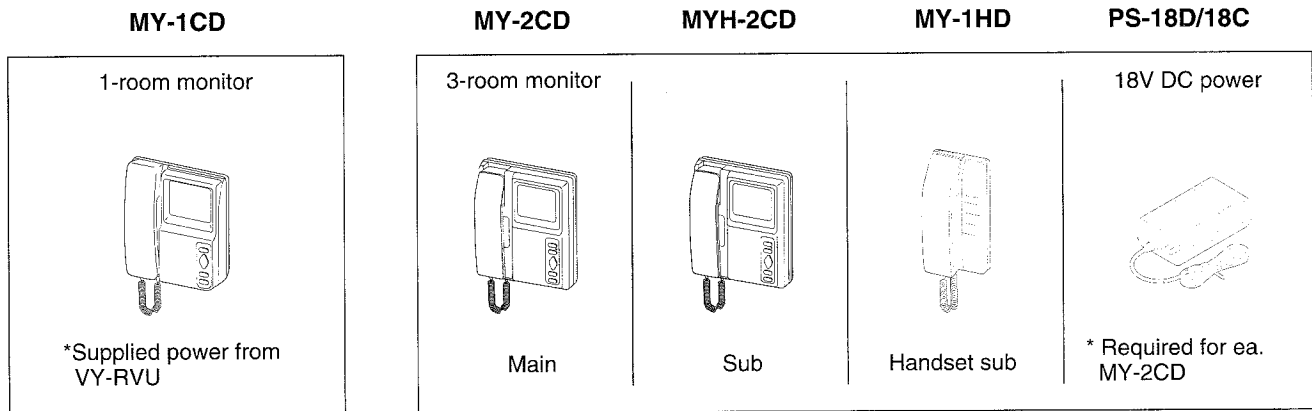

## 2 NAMES AND FEATURES

### VY-10EM

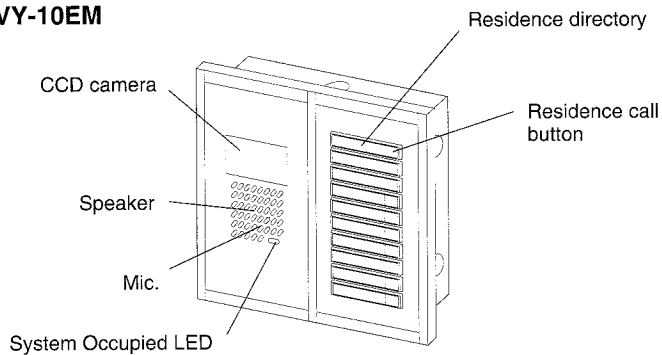

VY-EM consists of CCD camera / intercom & 5 or 10 direct call key entrance panels. One to three VY-10U add-on panels can be united with junction bar VYK-A20~40, and mounted on back boxes assembled.

Surface-mount box (B-VY10) is available for VY-5/10EM.

### ■ Features

- \* PanTilt Video Entrance-Call system, 5 to max. 40-call
- \* 1 to max. 3 video entries
- \* 3-pair trunkage, VY-RVU adaptor to adaptor and individual call wires separately jacketed
- \* Choice of MY-1CD single-room or MY-2CD 3-room monitor
- \* Communication secrecy, single-channel
- \* Door release system

### MY-1CD

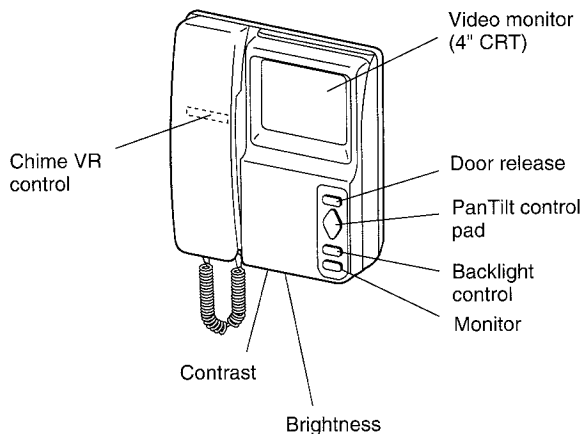

\* No separate power supply required

### MY-2CD

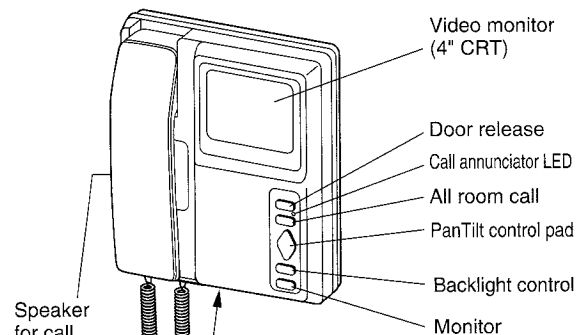

Five switches from left:  
\* Reset, SW1, contrast, brightness & call tone volume

★ See page 9 for SW1 setting.

\* Residential door station, PanTilt or wide-angle MY or IE/IF audio

\* Sub monitor(s) MYH-2CD or sub handset(s) MY-1HD

### 3 PRECAUTIONS ON INSTALLATION & WIRING

---

#### CAUTION

- ★ Do not connect any terminal on any unit to AC power lines to prevent fire or unit damage.
- ★ High voltage is present on the monitor unit inside. Do not open MY room monitor without first unplugging the power supply, to prevent electric shock.
- ★ Do not attempt to install or connect wires on VY-EM nor MY equipment while system's power supply is plugged in.
- ★ MY monitors and related equipment, except door station, are designed for indoor use only. Do not install outdoors.
- ★ Do not connect any other power supply than specified on +, – on VY-EM and MY monitor. Doing so can damage the equipment.

#### IMPORTANT

- ★ For system's installation, there is no need to disassemble the equipment. Do not open any VY-EM system components unless properly qualified.
- ★ Any other manufacturer's products installed with this system (door release, external signalling device, etc.) are not covered under Aiphone's warranty.
- ★ Do not mount VY and MY equipment in the following places, as it may cause the system to malfunction:
  - High or extreme cold temperature areas: under direct sunlight, near equipment that varies in temperature, in front of air-conditioner, inside a refrigerated area, etc.
  - Places subject to moisture or humidity extremes.
  - Places subject to environmental conditions, such as dust, oil, chemicals, etc.
- ★ VY/MY are an electrical devices, which must not be subjected to water, or any other liquid.
- ★ Weather conditions, such as lightning storms, may cause damage to VY-EM equipment. We recommend that power surge protection be installed as follows: (However, this does not guarantee that no damage will occur).

**• If the power supply has a GROUND terminal, take it to an earth ground.  
In this case, a separate surge arrester is not necessary.**

- Before actually installing the VY-EM & MY system, the contents on pages 4 ~ 12 must be thoroughly read and understood.

# 4 WIRING

## ■ Terminal block layout

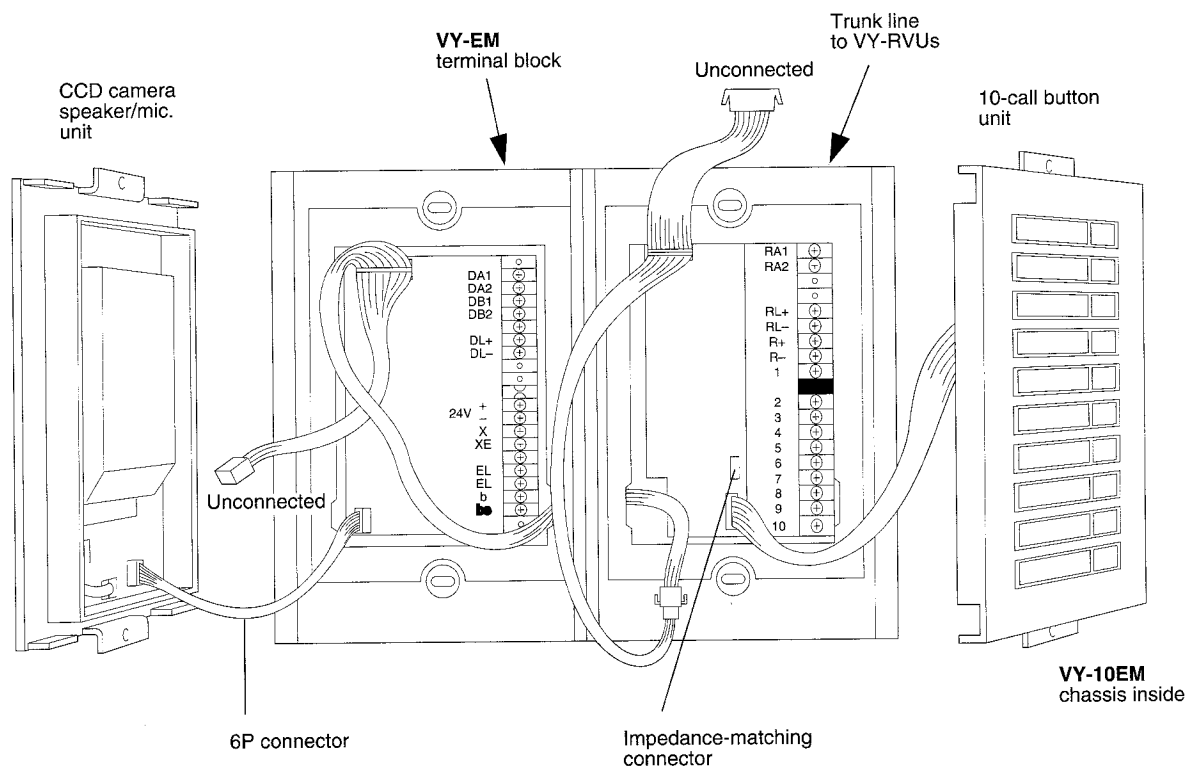

### ● For wiring to VY-EM entrance panels

<b>DA1</b>	,	<b>DA2</b>	:	Video signal
<b>DB1</b>	,	<b>DB2</b>	:	Video signal
<b>DL+</b>	,	<b>DL-</b>	:	Door release control (for 2~3 VY-EM's)
<b>+</b>	,	<b>-</b>	:	Power supply (DC24V)
<b>X</b>	,	<b>XE</b>	:	system control (for 2~3 VY-EM's)
<b>EL</b>	,	<b>EL</b>	:	Door release connection
<b>b</b>	,	<b>be</b>	:	Illumination/light control

### ● For wiring to residential VY-RVU's

<b>RA1</b>	,	<b>RA2</b>	:	Video signal
<b>RL+</b>	,	<b>RL-</b>	:	Door release control
<b>R+</b>	,	<b>R-</b>	:	Power supply
<b>1</b>	~	<b>10</b>	:	Individual calling, separately sheathed

★ VY-10U add-on panel has the same terminal block, allowing to run another trunk cable.

## ■ Laying out the system

- **Cable** Use twisted pair cable 1.0 ~ 1.2mm dia., 18 ~ 16AWG for trunkage line. If it contains extra pairs, those must be terminated with a 120 Ω resistor at both ends. As to individual call wires, use the same but separately jacketed twisted pair cable, in which unused pairs may remain unterminated

• **Trunkage**

VY-EM system may have one or multiple trunk cable run to VY-RVU residential adaptors, each trunk installing any number of VY-RVU's as required.

VY-10U has the same terminal block as on VY-EM, allowing to start another trunk cable run.

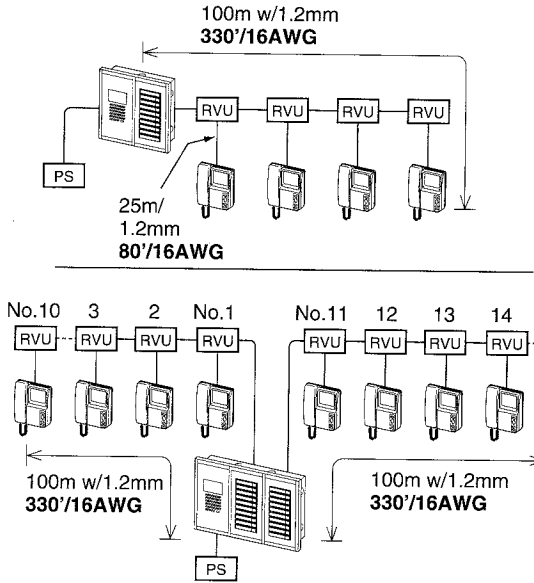

★ Run trunk line from the VY-EM which is installed nearest to VY-RVU's

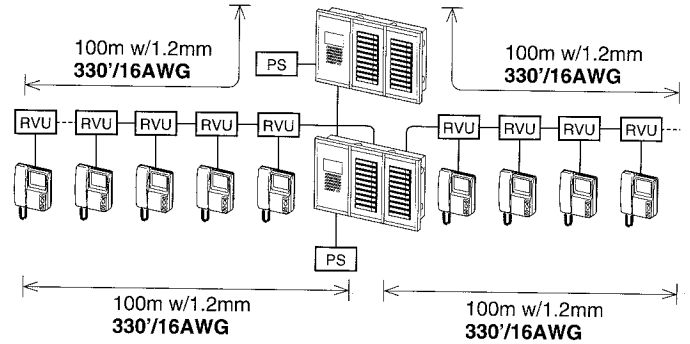

• **Impedance-matching on VY-EM/VY-10U**

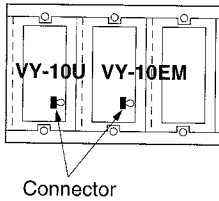

VY-EM & VY-10U add-on are equipped with terminating connector. When system has more than one VY-EM panels and with VY-10U, plug off at all those panels, except on the last VY-EM or VY-10U from which trunk cable is run.

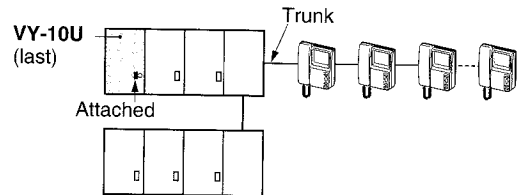
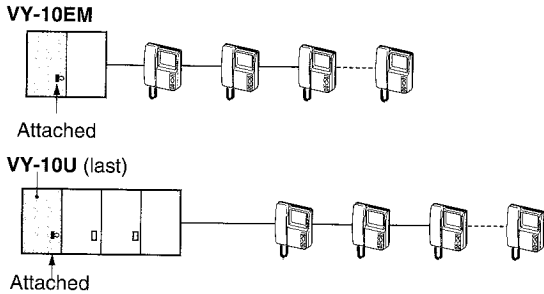

• **Impedance-matching on VY-RVU**

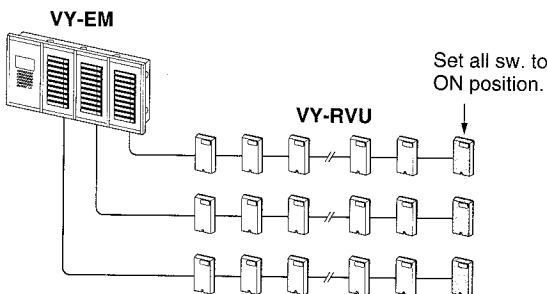

On the last VY-RVU adaptor on a trunk cable(s), set the 4 switches to all upper ON position.

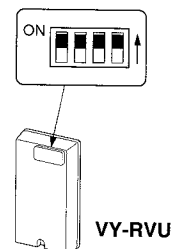

## ■ Wiring to door release (on each VY-EM)

VY-EM entrance call panel provides dry contact closure for door release.

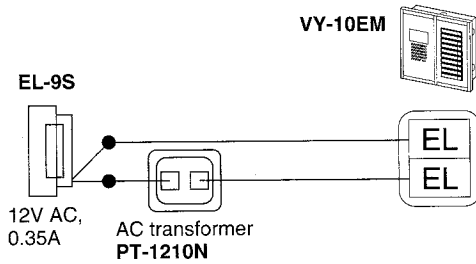

➔ Door release of other manufacture can be used in conjunction with Aiphone's MAW-B relay, powered by VY-EM's PS-24N.

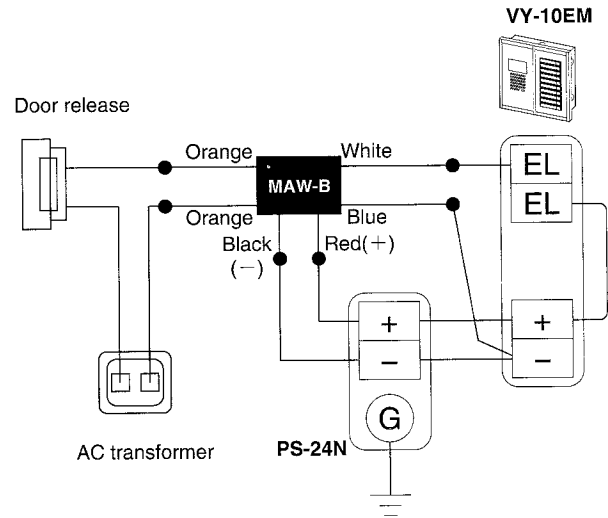

## ■ Lighting control at VY-EM entrance

VY-EM panel also provides dry contact closure for illuminating incandescent lamps for general lighting of less than 100W. It turns on when the VY-EM placed a call, activating the room monitor.

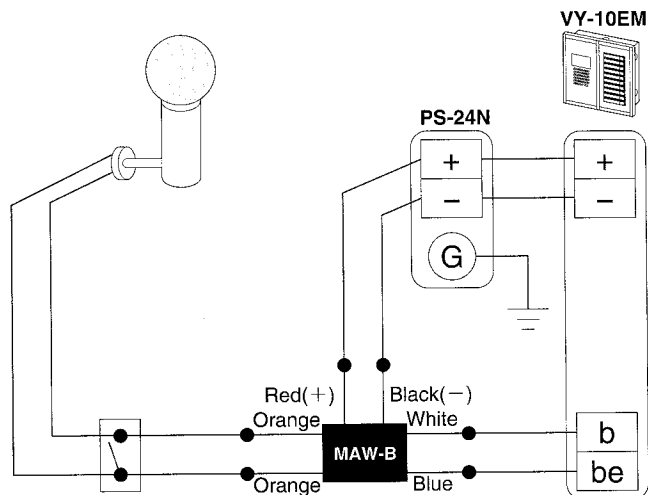

## ■ Trunkage wiring

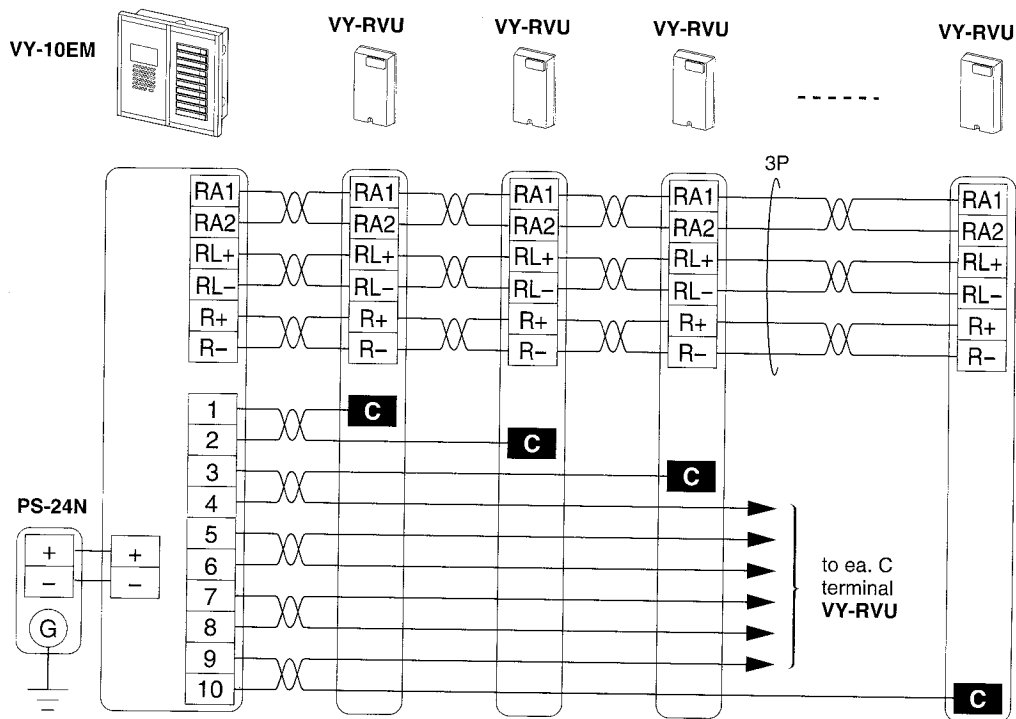
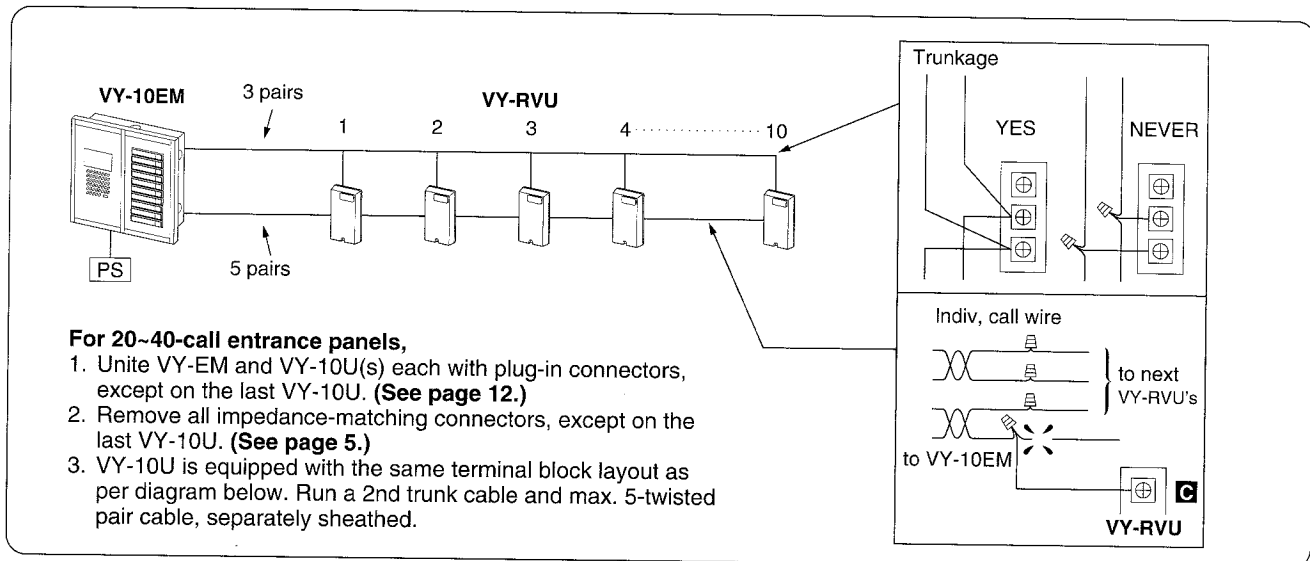

## ■ Wiring distance

\* VY-EM ~ Residential monitor (farthest)

Diam.	1.0mm	1.2mm
Distance	80m	100m
AWG	18AWG	16AWG
Distance	260'	330'

\* VY-EM ~ PS-24N

Diameter	1.2mm	1.6mm
Distance	10m	20m
AWG	16AWG	14AWG
Distance	35'	65'

- \* Run **3-twisted pair** cable to VY-RVU's without reconnections.
- \* As to direct-key 1 ~ 10-call wire, run max. 5-twisted pair, **separately sheathed**.
- \* Observe pairing terminals as shown above.
- ★ Secure 100m/φ1.0 (330'/18AWG) with reinforced wires on R+, R-.

## ■ VY-EM more than 100m (330') application

When VY-EM has distant installation of a VY-RVU area more than 100 ~ 300m (330' ~ 980') away, use an MYW-BA and a specified 1-pair video cable out of 3-pair trunk. A PS-24N is additionally required for the VY-RVU's.

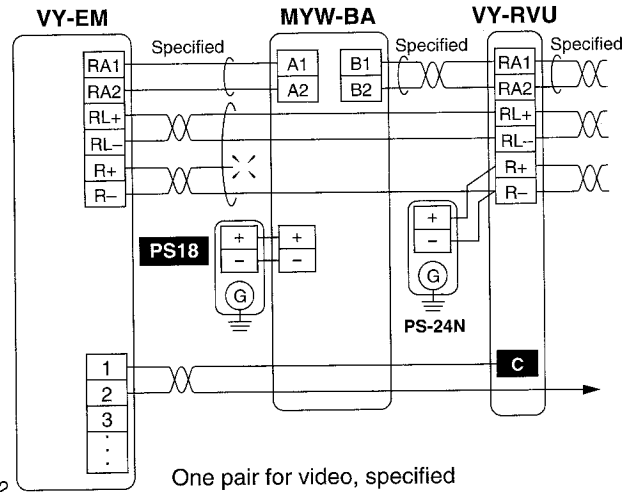
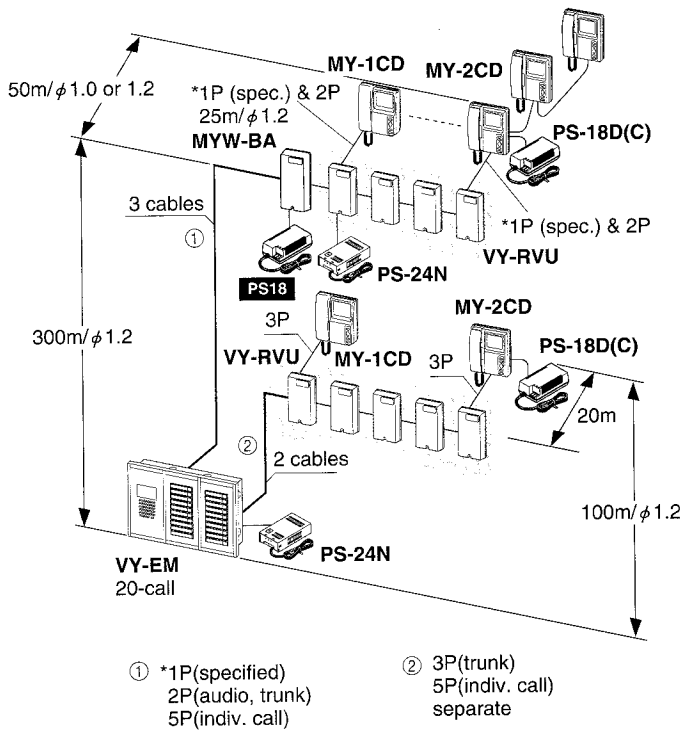

One pair for video, specified  
**West Penn D990** (in USA) or equivalent

- Impedance: 90ohm
- Permitted closed loop DC resistance: 9.9 ohm or less
- Non-PVC insulation  
plus 2 pairs (R+ unconnected), separately sheathed.

**PS-18** : PS-18YC or PS-18C.  
PS-18YD or PS-18D

## ■ Residential monitor MY-1CD

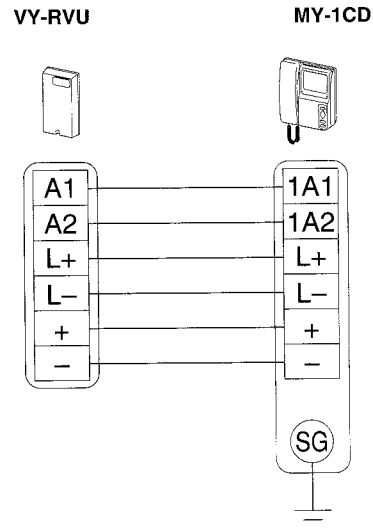
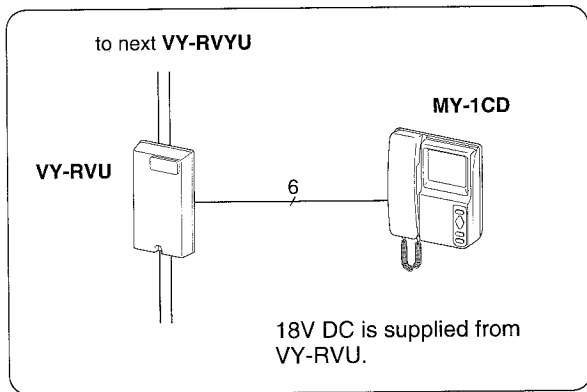

- \* Run 6-conductor cable, twisted or non-twisted to MY-1CD.
- \* Take SG terminal to earth, which may help to eliminate noise from +, - lines.

## ■ Wiring distance

\* VY-RVU ~ Residential monitor

Diameter	1.0mm	1.2mm
Distance	20m	25m
AWG	18AWG	16AWG
Distance	65'	80'

★ The distance is doubled with reinforced wires on +, -.



## ■ Residential monitor MY-2CD

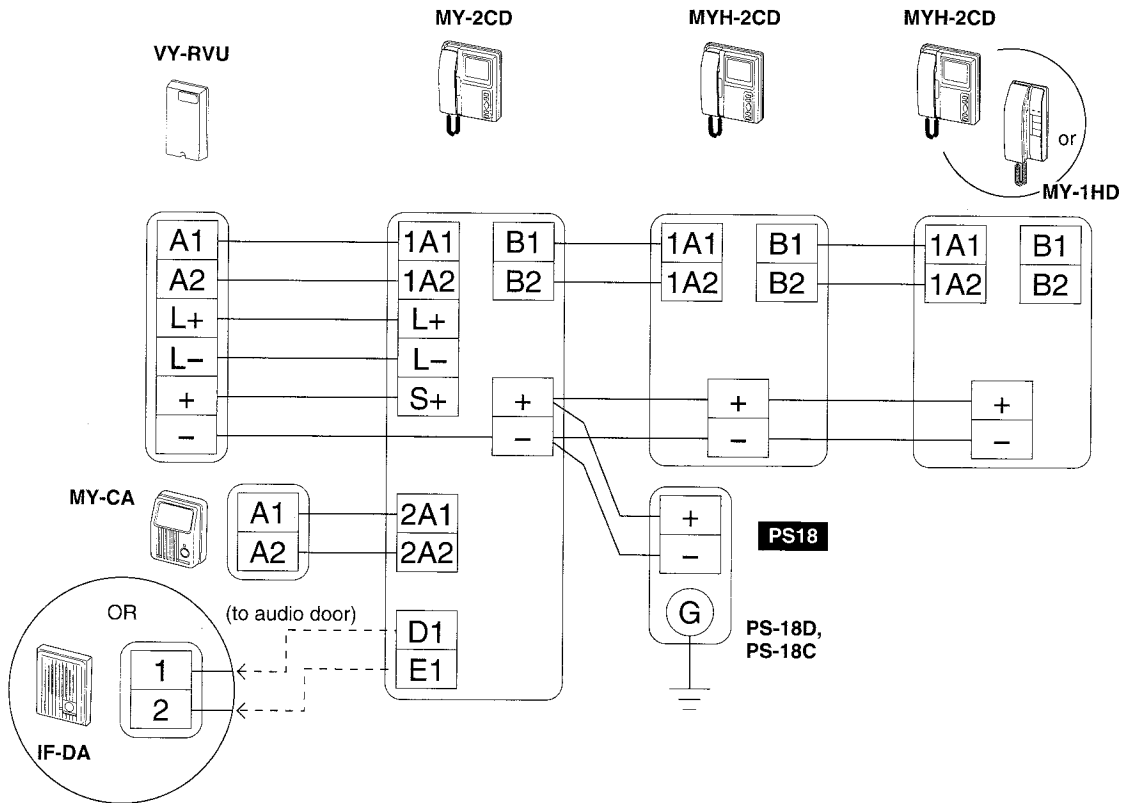
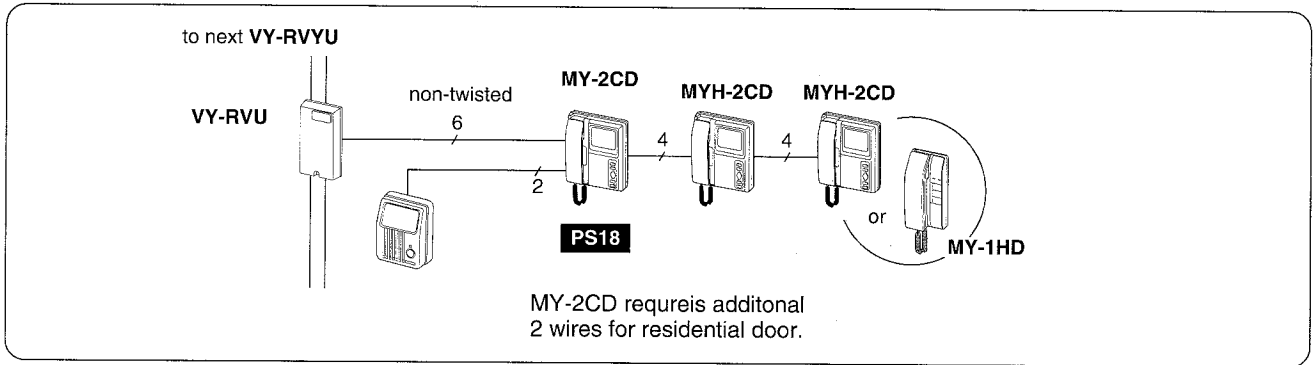

- \* Run 6 conductor cable twisted or non-twisted to MY-2CD.
- \* Residential door station can be either PanTilt, wide-angle or audio only.
- \* Take G terminal to earth on PS-18D (18C), which may help to eliminate noise from +, - lines.
- ★ **Connect A1, A2 on VY-RVU to 4-tone chime receive terminals 1A1, 1A2 on MY-2CD.**

## ■ SW1 setting

	MY-2CD	MYH-2CD or MY-1HD	MYH-2CD or MY-1HD
1 station	B	-	-
2 station	B	A	-
3 station	B (*)	B	A (**)

(\*) MY-2CD B : VY system.

(\*\*) MYH-2CD A : Terminated, B : high-impedance

## ■ Wiring distance

\* VY-RVU ~ Residential monitor

Diameter	1.0mm	1.2mm
Distance	20m	25m
AWG	18AWG	16AWG
Distance	65'	80'

★ The distance is doubled with reinforced wires on +, -.

## ■ 2 ~ 3 Entrance Call Panels

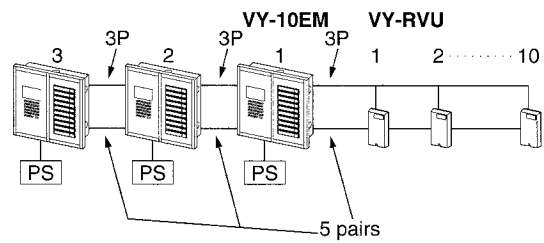
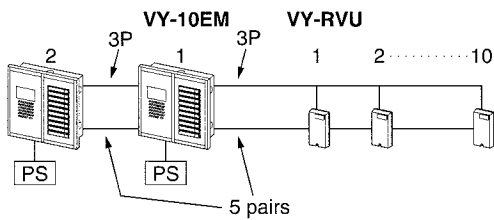

In either 2 or 3 VY-EM configuration, the wiring between VY-EM's can be accomplished with the same types of wires: 3 twisted pairs trunk, and separate jacketed indiv. call lines.

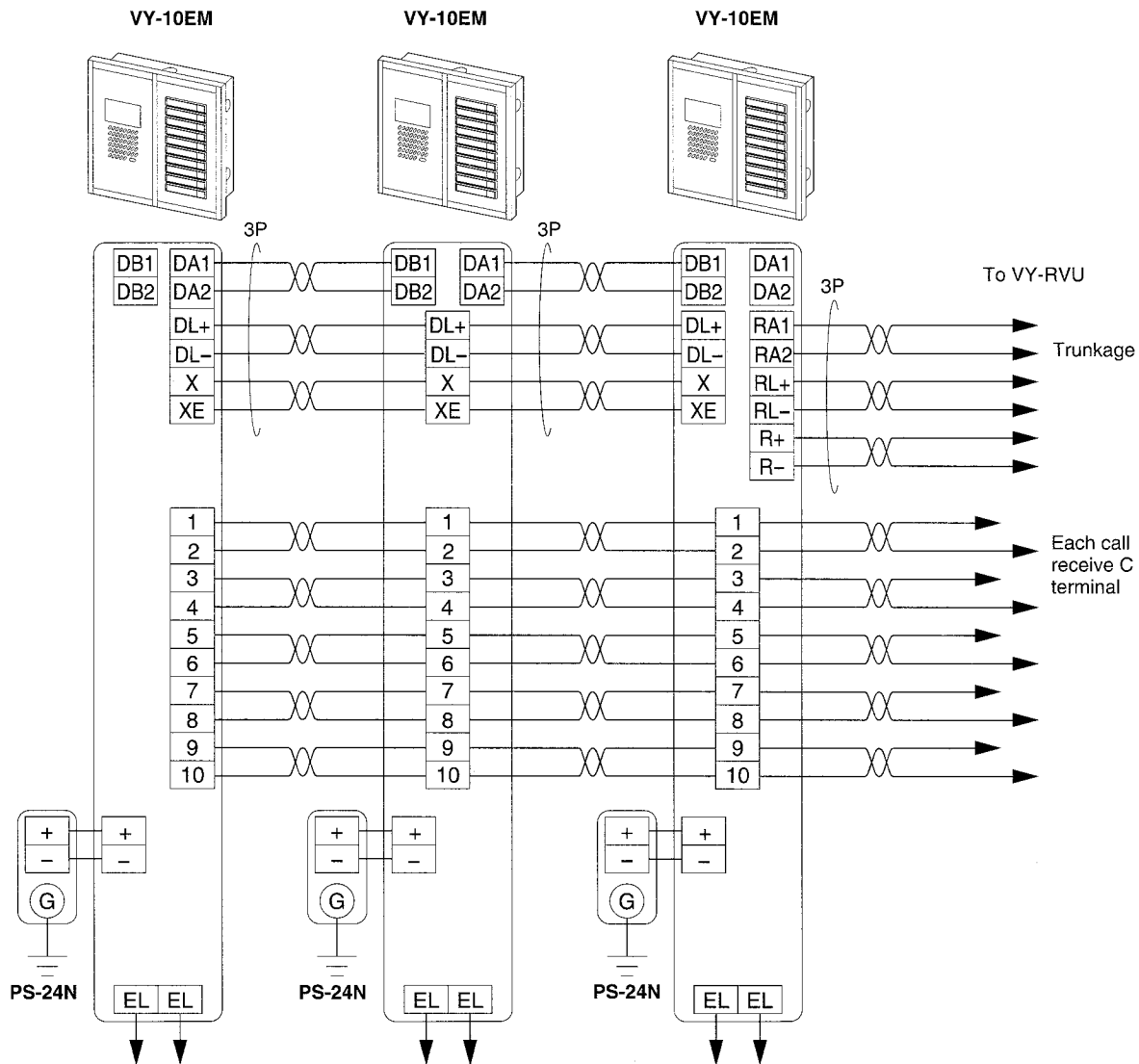

★ The distance between VY-EM(any) and farthest monitor MY-1CD or MY-2CD should not exceed 100m with 1.2mm dia. (330' w/16AWG).

# 5 MOUNTING

## ■ Mounting location

VY-EM entrance call panel employs CCD camera with infrared LEDs, and its performance can be affected with the environmental lighting conditions.

For best results, observe the followings:

1. Decide the height of camera, referring to the image viewing area, as shown right.
2. VY-EM panel does not face light-emitting sources or direct sunlight, coming directly into camera lens.
3. VY-EM panel, while holding weather-resistency, should not be exposed to direct rain, etc. (Protection with hood, etc. should be considered).

## ■ Mounting VY-5EM or VY-10EM panel

VY-EM consists of 3 components: front panels, chassis & back box. VY-EM panel flush-mounts on back box in the wall.

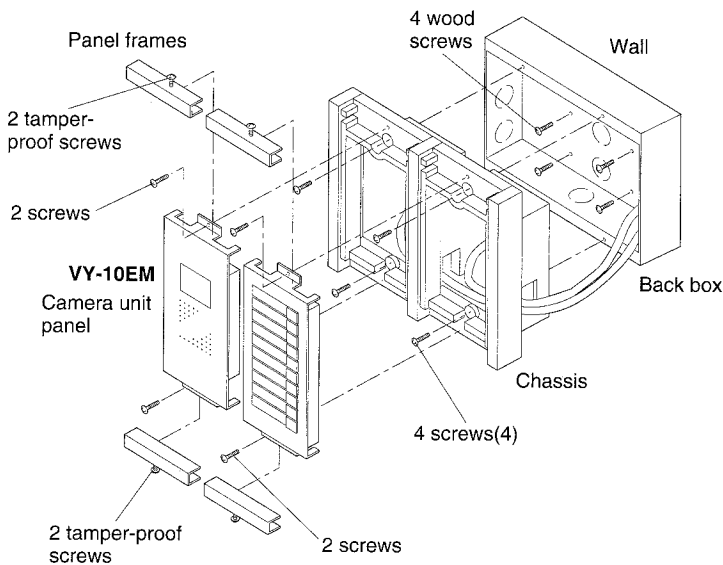

1. Disassemble 2 front panels, unscrewing 4 tamper screws on the panel frames.
2. Disconnect front panels, unplugging connectors from the chassis.
3. Mount the chassis on back box at 4 points. (screws are supplied)
4. Make wire terminations on the terminal block according to the wire color codes prearranged.
  - ★ Plug off matching connector on all middle call button panels.
5. Reconnect front panels, and remount to the chassis.

## ■ VY-RVU residential adaptor

VY-RVU can be mounted with 83.5mm, 3-5/16" guide. The adaptor operates with its housing getting warm, which is a normal occurrence.

- ★ When running intercom cables, maintain a distance of at least 2 feet (60cm) from any AC wiring, fluorescent lighting, and dimmer switches.

## ■ Pan/tilt viewing area shown by dotted line

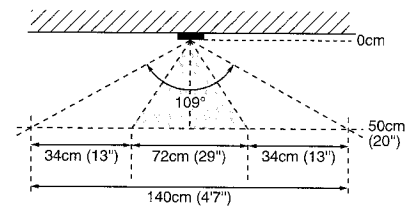
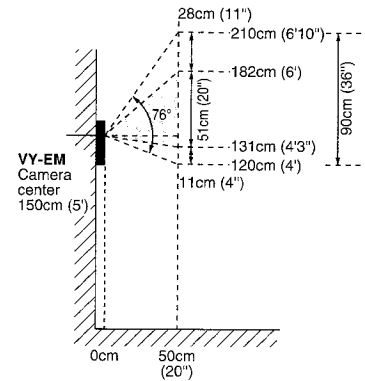

 Viewing area of camera remaining in still position.

Back box VY-5EM, VY-10EM is measured (H x W x D):  
 240 x 250 x 62 (mm)  
 9-7/16" x 9-7/8" x 2-7/16"

- ★ The hole should have a space of at least 3mm, 1/8" on both sides.

## ■ Assembling VY-10U (1 ~ 3) panels to VY-EM

VY-5EM or VY-10EM with VY-10U panel(s), are made up for 15 to max. 40-call entrance panel.

### Back box dimensions

VY station	High	Wide	Deep
VY-5EM, VY-10EM	240 mm 10 feet	250 mm 10 feet	62 mm 3 feet
VY-10EM + 1 VY-10U 20-call		390 mm 16 feet	
VY-10EM + 2 VY-10U 30-call		530 mm 21 feet	
VY-10EM + 3 VY-10U 40-call		670 mm 27 feet	

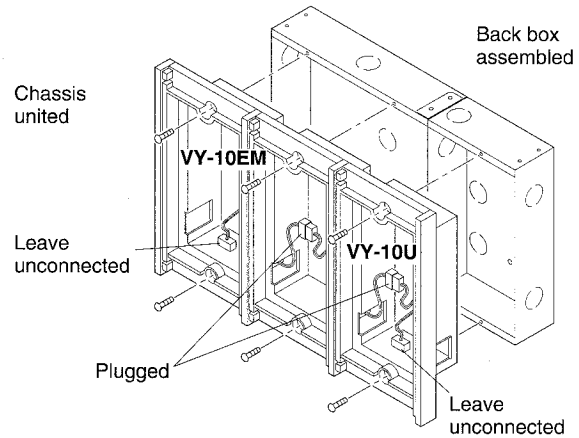

- Loosen screws (7) on back of VY-5/10EM chassis.
- Attach new junction bar (2) VYK-A20 ~ 40, aligning on the ditch.
- Fasten all screws, on VYK-A plate to unite.
- On back boxes, before assembly, knock out a hole on each facing side. Attach VY-10U box to VY-EM's with 2 screws top and bottom.
- Detach panel frames, using special screwdriver.
- Loosen panel-fixing screws (6 ~ 10) and disconnect VY-EM/VY-10U's to separate from chassis.
- Mount the chassis (assembled) to back box.
- Reconnect and mount VY-EM/VY-10U panels on the chassis.

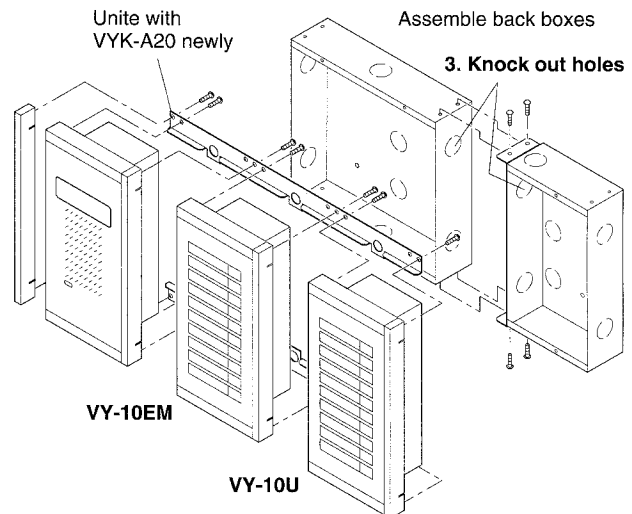
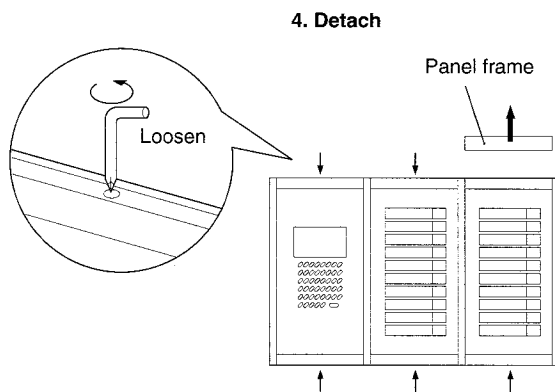
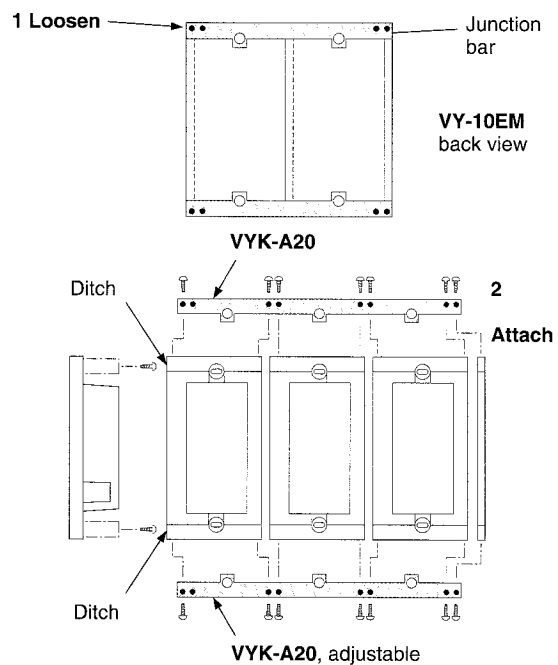

# 6 OPERATIONS on VY-EM and MY

## ■ On VY-EM entrance-call panel

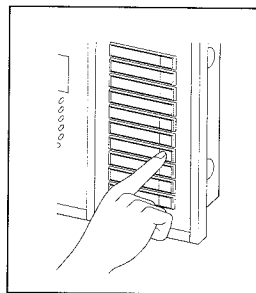

Momentarily press a residence call button.

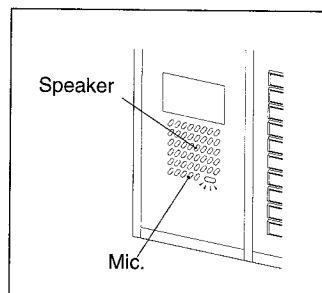

When a room station replies, speak to the mic, standing in front of panel (within 50cm, 20").

★ The channel to VY-EM can be resumed with 5-sec. time-out timer in any operation.

## ■ On MY-1CD residential monitor

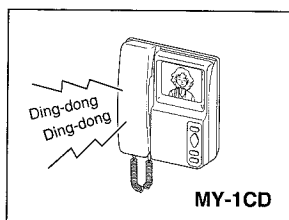

Chime, 4-tone is activated. Video monitor is turned on with image.

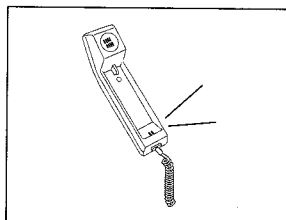

Pick up handset, and communicate.

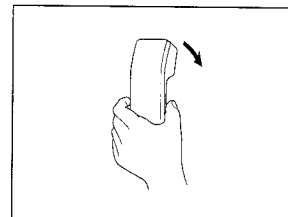

Hang up handset. The monitor is turned off.

## ■ On MY-2CD residential monitor

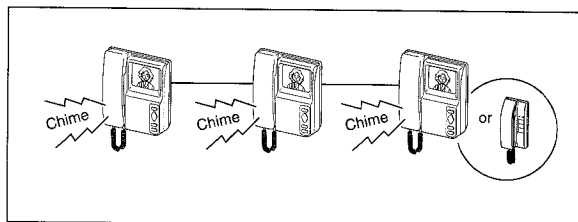

When call button is pressed, 4-tone chime sounds, and all monitors are turned on with image.

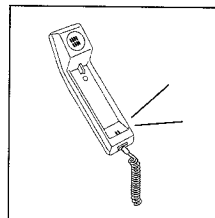

Pick up (any) handset, and communicate.

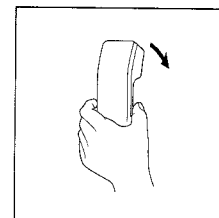

The monitor is turned off upon hanging up.

## ■ Pan/tilt viewing

While the image is alive on the monitor, operate pan-and-tilting the VY-EM camera pressing the edge of diamond-shaped pad.

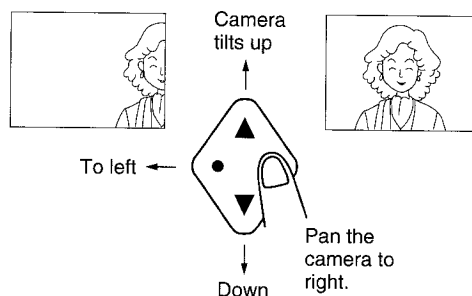

The VY-EM camera returns to initial position, after hanging up handset.

## ■ Image viewing area

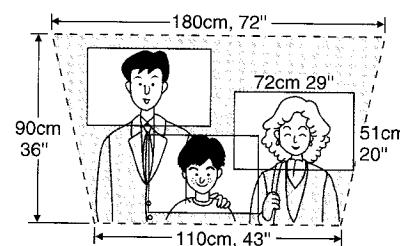

## MY-2CD system – Operates independently from VY-EM

### ■ Receiving a call from residential MY-CA

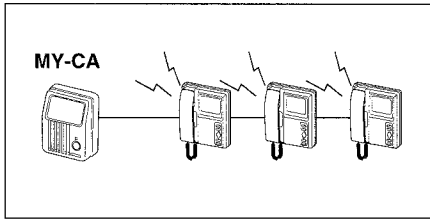

Chime sounds in 2-tone, activating all monitors with image.

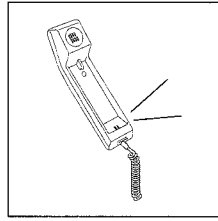

Pick up (any) handset, and communicate.

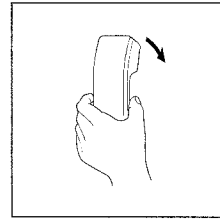

Hang up, and the monitor is turned off.

★ If the monitor is turned off, press Monitor button once to restore.

### ■ Pan/tilt monitoring of MY-CA

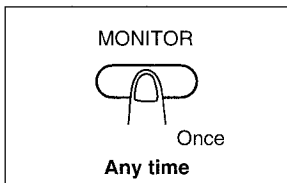

Press once Monitor button. Image of MY-CA comes on.

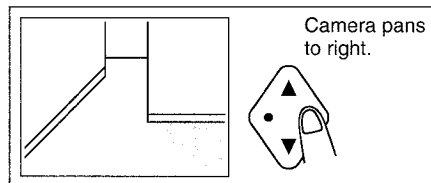

Pan-and-tilt the door camera.

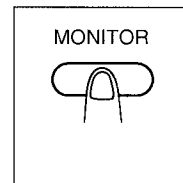

Press Monitor to turn off.

### ■ Receiving a call from VY-EM during communication

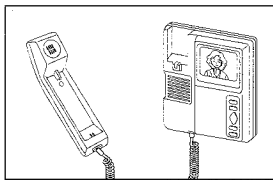

Monitor is turned on with chime tone.

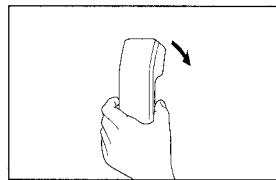

Hang up handset at both to conclude.

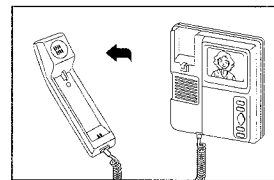

Repick up handset at answering station.

★ VY-EM call-in is held for approx. 10 seconds, while MY-2CD is communicating.

### ■ Adjustments

#### MY-1CD

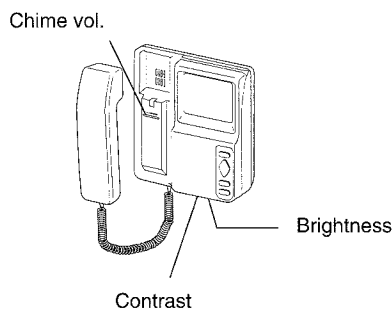

#### MY-2CD

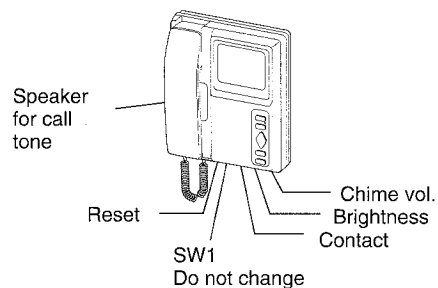

## 7 TECHNICAL PRECAUTIONS

- (System In-use LED) ★ When system has more than one VY-EM entrance-call panels, see, before use, the Occupied LED is not lit. It invalidates a call.
- (Incorrect calling) ★ When a call button of another suite, is pressed during communication, it disconnects the line present, and rings that station. On the VY-EM panel, see the Occupied LED goes off, and the initial suite station can be called again.
- (Video monitoring)
  - ★ MY-1CD or MY-2CD residential monitors are not capable of monitoring VY-EM. Only when called, pan-and-tilting VY camera is operable.
  - ★ On MY-2CD system only, MY-CA camera (and MY-DS wide-angle) can be activated for monitoring and pan/tilt scanning its entry.
- (Call-in timer) ★ 45 seconds for call-in from VY-EM (With 5 sec. time-out timer)
- (Communication timer) ★ 2-1/2 minutes for room-to-VY-EM (MY-CA) communication. (With 5 sec. time-out timer) To resume, press MONITOR button while communicating. Repick up if handset is placed.
- (Door release) ★ When key-marked button is held down, the white line may appear on the monitor, which is a temporal occurrence.

### ■ Terminating the unused pairs in trunk cable

- ★ Unused pairs in the trunk cable, must be terminated by a 120 ohm resistor at both ends for clearer video transmit lines.

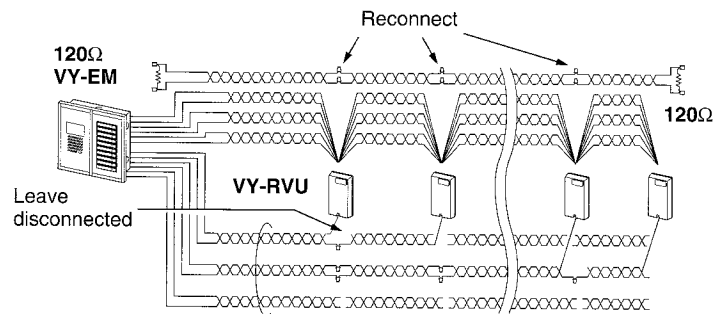

- (Operating temperature) ★ The VY-EM is rated to operate at temperatures between  $-10^{\circ}\text{C}$  and  $60^{\circ}\text{C}$  ( $14^{\circ}\text{F}$  and  $140^{\circ}\text{F}$ ). When the outside temperature lowers rapidly, the lens may fog up slightly, causing a blurry picture at the inside monitor. The ventilation openings will allow the moisture to evaporate, and the picture will return to normal.

### ■ Cleaning the VY-EM equipment

- ★ Clean VY-EM and MY-1CD/MY-2CD with a soft and dry cloth. When the soil is not easily cleaned, the cloth may be dampened with neutral household cleanser. Never use any abrasive cleaner or cloth.
- ★ Keep direct forceful rain or water away from the front of VY-EM, in spite that the units are designed

# 8 SPECIFICATIONS

## VY-EM

- \* **Power source** 24V DC. Install a PS-24N power supply at each VY-EM.
- \* **Current consumption:**

	VY-EM	2nd or 3rd VY	VY-10U
Max.	1.4A	0.19A	0.075A
Standby	0.15A	0.15A	0A

- \* **Station capacity** 1 ~ 3 **VY-EM** entrance call stations  
1 ~ 3 **VY-10U** add-on panels, 10-call  
5 ~ 40 **MY-1CD and/or MY-2CD** residential monitors
- \* **Camera unit** CCD camera, with infrared LEDs
- \* **Scanning line** 525 lines
- \* **Type of monitor** MY-1CD or MY-2CD w/PanTilt pad
- \* **Calling** Electronic chime, 4 or 2-tone (from resid. door)
- \* **Communication** Single-channel, non-open communication
- \* **Door release system** VY-EM has EL,EL dry-contact closure for door strike  
(Capacity: Max. AC 24V, 50mA. Max. DC 24V, 250mA).  
Activation by key-mark button on communicating MY monitor
- \* **Wiring & distance** **Use twisted pair cable for trunk**

		1.0mm	18AWG	1.2mm	16AWG
VY-EM to residence area (VY-RVU's)	3 pairs + 1 / resid.	80m	260'	100m	330'
Between VY-EM's	3 pairs + 1 / resid.	Within the specified distance			
VY-RVU to MY-1CD or MY-2CD	6 cond. (parallel)	20m	65'	25m	80'

★ See pages 5 ~ 11 wiring section for each system configuration. ★ The distance VY-RVU to monitor is doubled with reinforced wires on +, -.

- \* **Dimensions (H x W x D) & weight**

VY-5EM, VY-10EM	280 x 290 x 90.2 (mm). 11" x 11-1/2" x 3-3/4".	62 recessed. 2-1/2" recessed	2.0Kg. (4.41 lbs.)
VY-10U	280 x 140 x 90.2 (mm). 11" x 5-1/2" x 3-3/4".	62 recessed. 2-1/2" recessed	0.8Kg.(1.76 lbs.)
VY-RVU	140 x 74 x 42 (mm). 5-1/2" x 3" x 1-1/2".		0.25Kg.(0.60 lbs.)

This equipment has been tested and found to comply with the limits for a Class B digital device, pursuant to Part 15 of the FCC Rules. These limits are designed to provide reasonable protection against harmful interference in a residential installation. This equipment generates, uses, and can radiate radio frequency energy and, if not installed and used in accordance with the instructions, may cause harmful interference to radio communications. However, there is no guarantee that interference will not occur in a particular installation. If this equipment does cause harmful interference to radio or television reception, which can be determined by turning the equipment off and on, the user is encouraged to try to correct the interference by one or more of the following measures:

- Reorient or relocate the receiving antenna.
- Connect the equipment into an outlet on a circuit different from that to which the receiver is connected.
- Increase the separation between the equipment and receiver.
- Consult the dealer or an experienced radio/TV technician for help.

### WARRANTY

Aiphone warrants its products to be free from defects of material and workmanship under normal use and service for a period of two years after delivery to the ultimate user and will repair free of charge or replace at no charge, should it become defective upon which examination shall disclose to be defective and under warranty. Aiphone reserves unto itself the sole right to make the final decision whether there is a defect in materials and/or workmanship; and whether or not the product is within the warranty.

This warranty shall not apply to any Aiphone product which has been subject to misuse, neglect, accident, or to use in violation of instructions furnished, nor extended to units which have been repaired or altered outside of the factory. This warranty does not cover batteries or damage caused by batteries used in connection with the product.

This warranty covers bench repairs only, and any repairs must be made at the shop or place designated in writing by Aiphone. Aiphone will not be responsible for any costs incurred involving on site service calls.

Aiphone Co., Ltd., Nagoya, Japan  
Aiphone Corporation, Bellevue, WA, USA

VY-EM-I(E) 0595J





## Free Manuals Download Website

<http://myh66.com>

<http://usermanuals.us>

<http://www.somanuals.com>

<http://www.4manuals.cc>

<http://www.manual-lib.com>

<http://www.404manual.com>

<http://www.luxmanual.com>

<http://aubethermostatmanual.com>

Golf course search by state

<http://golfingnear.com>

Email search by domain

<http://emailbydomain.com>

Auto manuals search

<http://auto.somanuals.com>

TV manuals search

<http://tv.somanuals.com>