

# AIPHONE

## IS SERIES

Commercial & Security IP Video Intercom system

## IS-SOFT

PC Master Station

# OPERATION MANUAL

GETTING STARTED

USING THE PC MASTER STATION

APPENDIX

Thank you for selecting Aiphone for your communication and security needs. Please read this manual and the separate "SETTING MANUAL" carefully before setting and using the PC master station.

Please note that images and illustrations depicted in this manual may differ from the actual ones.

# CONTENTS

<b>INTRODUCTION</b> .....	<b>4</b>
<b>PRECAUTIONS</b> .....	<b>4</b>
General precautions .....	4
Notes on using this product .....	4
Notes on communication .....	4
Notices .....	4

## **GETTING STARTED** .....

**5**

<b>PART NAMES AND THEIR FUNCTIONS</b> .....	<b>5</b>
Main window .....	5
Volume control window.....	7
Dial keys window .....	7
Speed dial window.....	8
Play window .....	8

<b>OUTLINE OF OPERATIONS</b> .....	<b>9</b>
Communication.....	9
Transferring.....	9
Paging.....	10
Monitoring .....	10
Door release .....	10

## **USING THE PC MASTER STATION**... ..

**12**

<b>RECEIVING AND ANSWERING A CALL ON THE PC MASTER STATION</b> .....	<b>12</b>
Receiving a call.....	12
Answering a call .....	13
■ Communication in the hands-free mode .....	13
■ Communication in the press-to-talk mode .....	13
Viewing video images at a video door station.....	15
■ Switching Zoom/Wide.....	15

■ Pan & Tilt .....	15
■ Adjusting images .....	16

### **Transferring to another (PC) master station** .....

**17**

■ Communication transferring .....	17
■ Call transferring .....	17

### **Door release** .....

**18**

### **Using the PRIVACY function**.....

**18**

■ While receiving a call.....	18
■ To communicate with the caller .....	18

## **PERFORMING CALLING, MONITORING, PAGING AND CHIME PAGING ON THE PC MASTER STATION**.....

**19**

### **Searching for a station, zone or remote site** .....

**19**

Searching for a station, zone or remote site from the list.....	21
Searching for a station or zone by number using the dial keys .....	23
Searching for a station, zone or remote site from the placed call or received call list.....	24
Selecting a station, zone or remote site by using the speed dial buttons .....	24

### **Calling another station (direct voice call)** .....

**25**

### **Monitoring** .....

**26**

■ Monitoring.....	26
■ Scan-monitoring .....	26

### **Viewing video images at the target station** .....

**26**

### **Paging** .....

**27**

### **Chime paging** .....

**27**

## **RECORDING** .....

**28**

### **Auto recording**.....

**29**

### **Manual recording**.....

**29**

■ How to perform manual recording .....	29
---	----

**PLAY ..... 30**

**Playing recorded image  
(and/or sound)..... 30**

**Deleting a recorded file ..... 31**

**APPENDIX..... 32**

**TECHNICAL PRECAUTIONS ... 32**

**AVAILABLE CHARACTER  
LIST ..... 32**

**SPECIFICATIONS ..... 32**

**PREPARATION**

**Connecting a headset or handset to the PC**

To talk, listen, etc. by using the PC master station, connect a commercially available headset or handset to the PC on which the PC master station will run.



\* When a talk cannot be switched properly between you and the target side, adjust the microphone volume and/or speaker volume on the PC master station. If the adjustment is insufficient, also adjust volume on the headset or handset.

# INTRODUCTION

The IS system is a video security communication system especially designed for applications in facilities such as office buildings, factories, schools, hospitals, and prisons. This product is an application to be installed in a PC to use it as a PC master station in the IS system. The PC master station can be used almost as the same as other IP master stations adding some unique functions.

# PRECAUTIONS

## General precautions

1. For wiring, specify CAT5e straight cable.
2. Due to the environmental sound around the unit, it may hinder smooth communication, but this is not a malfunction.
3. The outline of video images displayed by video door station may differ from that of the actual person(s) or background, but this is not a malfunction.
4. Aiphone assumes no responsibility for corruption of saved information (such as changes to or deletion of saved information). Please be aware of this in advance.
5. Warm-color lighting shining on the door station may change the tint of the picture on the monitor.

## Notes on using this product

- Lip-sync is not performed for audio and video in the PC master station.
- Depending on the network environment and computer, it may not be useable.
- There are times when audio and video may be delayed in the PC master station due to encoding, decoding, or the network.
- Depending on the network environment or the computer's performance, operations may not be carried out normally, such as interrupted audio or video, and delayed frame rate decrease.
- When operating PC master station in succession, the operation may become invalid.
- The times for the system and the PC master station are not synchronized.
- We recommend a 100BASE-TX wired LAN network.

## Notes on communication

- When communicating via the PC master station, use a commercially available headset or commercially available handset to prevent feedback. When using a headset or handset, the call tone does not sound from the computer's speaker. Confirm the call by the headset (or handset) or the screen display.
- During communication, if you speak before the other person has finished talking, your voice may not come through clearly. Communication will proceed smoothly if you wait until the other person has finished before speaking.
- If there are loud noises (such as children crying, music playing, or strong winds) around the computer or the door station, the sound may break up and be difficult to hear.
- A hands-free (VOX) system has been implemented for communication. Even if you use a headset or handset with the PC master station, you cannot carry out simultaneous conversations. (Communication is not full duplex.)
- The talk and call tone volumes vary depending on the PC master station settings, computer settings, and headset or handset volume. Pay careful attention to the volume when monitoring or talking.

## Notices

- We will under no conditions be liable for damage that occurs due to failures in network equipment; failures due to internet providers and cell phone companies; failures such as disconnected lines and other losses in communication, which render it impossible to provide this service or in any way delay this service due to causes outside of our responsibility; or if an error or missing data occurs during transmission.
- We will under no conditions be liable for damage caused if a customer's password or transmitted information are leaked through bugging or unlawful computer access over Internet communication.
- We will under no conditions be liable for damage that occurs due to the inability to communicate due to malfunctions, problems, or operational errors in this product.
- We will under no conditions be liable for any damages or losses resulting from this product's contents or specifications.
- This manual was created by Aiphone Co., Ltd., all rights reserved. Copying a part of or this entire manual without prior permission from Aiphone Co., Ltd. is strictly forbidden.
- Please note that images depicted in this manual may differ from the actual images.
- Please note that this manual may be revised or changed without prior notice.
- Please note that product specifications may be changed for the sake of improvement without prior notice.
- Please be aware that it is the customer's responsibility to ensure that their computer is secure. We will under no conditions be liable for security failures.
- This system is not intended for life support or crime prevention. It is just a supplementary means of conveying information. Aiphone will under no conditions be liable for loss of life or property which occurs while the system is being operated.
- When the PC master station is initialized, all the registrations are returned to factory default settings. Follow the setup procedure for the PC master station again.

# GETTING STARTED

## PART NAMES AND THEIR FUNCTIONS

### NOTE:

Confirm the icon  on the task bar at the bottom-right of the PC screen is blue. If the icon is gray, the settings have not been made correctly. (→ "SETTING MANUAL")

### Main window

#### Video display area

Displays station type images and images from a video door station.

#### Status display icons

(Refer to the next page for details.)

#### Video x1, x2, x3 buttons

Change the size of the main window. \* "x3" may not appear depending on the PC.

#### Time and date display

Displays the time and date.

#### ADD/RMV (Add/Remove) button (→P. 21)

Adds or removes stations and/or zones in the list.

#### Close button

Closes the PC main window.

#### Minimize button

Minimizes the main window.

#### Message area

Displays the number(s) (or name(s)) of the selected station(s), zone(s) or remote site, and the station number of this PC master station.

#### List page no.

When the list of stations, zones and/or remote sites, or setting items consist of two or more pages, the current page no. is shown here.

#### List area

The list of the stations, zones and/or remote sites you searched for is shown here. Stations, zones and/or remote sites are displayed either by number and/or name depending on the setting in the Setting window.

#### BACK button

Returns to the previous status.

#### Volume control window button (→P. 7)

Opens the Volume control window.

#### Dial keys window button (→P. 21)

Opens the Dial keys window.

#### Speed dial window button (→P. 24)

Opens the Speed dial window.

#### SETTING button

Opens the Setting window. (Refer to the SETTING MANUAL for details.)

#### LIST button (→P. 20)

Click to display the registered stations, zones or remote sites in the list area.

#### OFF button (→P. 13)

Click to finish communication, monitoring or calling.

#### TALK button (→P. 13)

Click to answer a call or call the selected station.

#### (ZOOM/WIDE button) (→P. 15)

Switches the display mode between zoom and wide. (This button is also used for determining the selection.)

#### (Pan & Tilt control button) (→P. 15)

Moves the images on the video display area from right to left or up and down.

#### PRIVACY button (→P. 18)

Click so that the button lights up to turn on the privacy function.

#### TRANSFER button (→P. 17)

Click so that the button lights up to transfer a call to another master station, etc.

#### Record/Stop button (→P. 29)

Records the displayed image on the PC.

#### Play window button (→P. 30)

Opens the Play window.

#### Door release button (→P. 18)

Click so that the button lights up to unlock the door connected to the received door station.

#### ADJUST button (→P. 16)

Click so that the button lights up to adjust the image on the video display area when it is hard to see in the daytime or darkness.

#### MONITOR button (→P. 26)

Click to monitor the selected station or start scan-monitoring.



## Status display icons

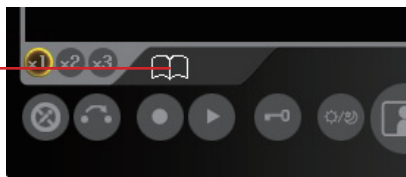

The following icons are displayed here depending on the status of the PC master station.

- \* The color of an icon changes according to the priority level.  
 Normal: green  
 Priority: yellow  
 Urgent: red

### List of the mainly-used icons

Icons	The status when the icon appears
	Appears while talking to the target station, being called from another (PC) master station, etc.
	Appears while being called.
	Appears when paging.
	Appears when the microphone volume is set to OFF, or the PRIVACY function is activated.
	Appears while transferring is suspended.
	Appears while receiving a call from a station transferred by another one. * This icon also appears on the station that performs transferring.
	Appears while searching for a station, zone or remote site.
	Appears while monitoring.
	Appears during scan-monitoring.
	Appears when an error message is displayed.
	Appears while performing chime paging.
	Shows it is a waiting time for shifting to the next performance, etc.

## Displaying call and/or (chime) paging record and reception record

Call and/or (chime) paging record and reception record can be displayed on the monitor for each up to 20 items.

- \* When no answer was returned to an incoming call from this PC master station, it is displayed in the reception record list. In the records, unanswered incoming calls are marked with ☆ (outlined in yellow) or ★.

- ★ : Unanswered calls that have not been confirmed on the list yet
- ☆ : Unanswered calls that have already been confirmed on the list

### NOTES:

- The calls that are not received at the PC master station are not recorded. (A PC master station cannot receive two or more calls at a time.)
- The record of unanswered incoming calls can also be automatically displayed by the setting in the Setting window. ( → “SETTING MANUAL”)
- The reception of chime is not recorded.
- A monitoring operation is not recorded. If monitoring is shifted to talking, it will be recorded.

### How to select items in the list area

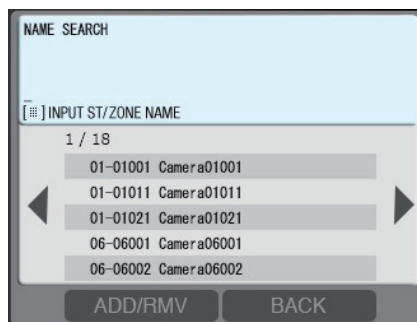

1. Highlight the desired item by clicking repeatedly, or pointing to it with the cursor.
2. Double-click the highlighted item with the cursor to go on to the next selection list.  
\* If there is no additional selection list, perform the corresponding action (calling, monitoring, paging, etc.).

This manual mainly describes operation methods by using . You can also use the cursor if you prefer.

## Volume control window

**Audio transmit level indicator**  
Shows the volume level of talking sound.

\* Adjust the volume so that the level does not reach the red zone of the indicator.

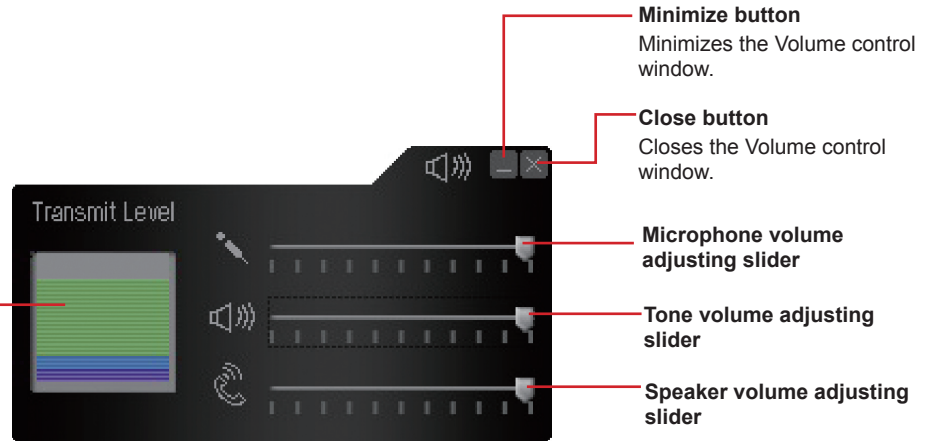

### NOTE:

Sudden rise of the tone volume and speaker volume may damage your eardrum(s). Be sure to lower the volume first, and then rise the volume little by little to adjust it.

## Dial keys window

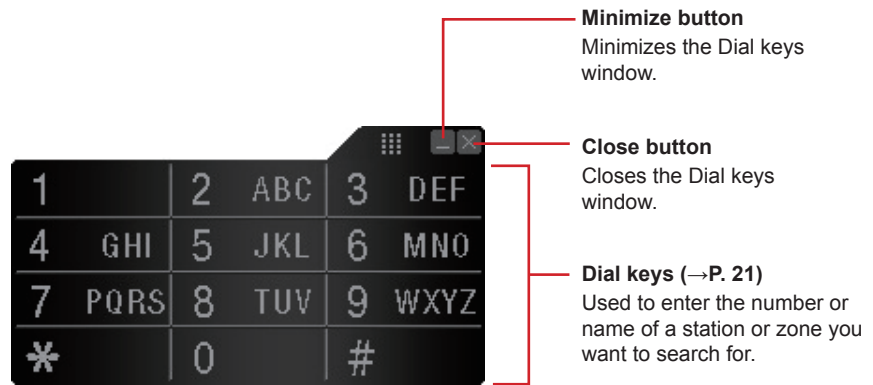

## Speed dial window

### Minimize button

Minimizes the Speed dial window.

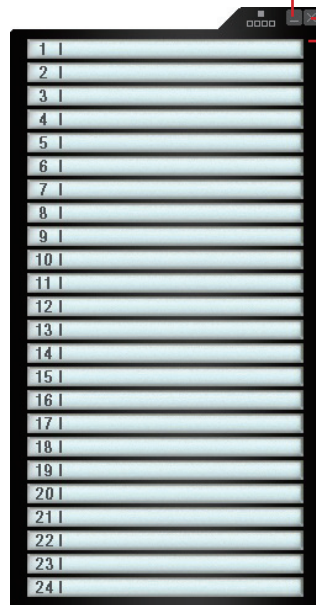

### Close button

Closes the Speed dial window.

### Speed dial buttons (→P. 24)

Register stations, zones and/or remote sites you call or select frequently to each of these buttons. You can select a station, zone or remote site simply by clicking the corresponding button.

## Play window

(→P. 30-31)

### Start Date selection tab (and calendar)

Designates the start date of the period of time to search for files recorded in the period.

### End Date selection tab (and calendar)

Designates the end date of the period of time.

### Station Select tab

Selects the target station type or remote site for searching for recorded files.

### Minimize button

Minimizes the Play window.

### Close button

Closes the Play window.

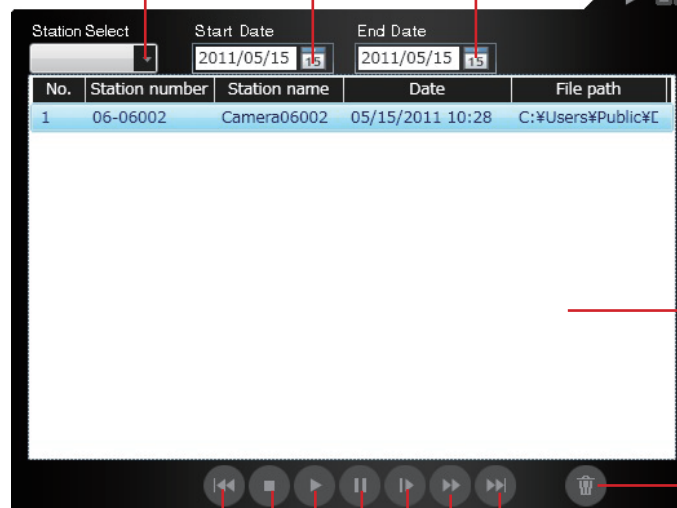

### File display area

Displays the recorded files here.

### Delete button

Deletes the selected file.

### Next file button

Displays the next files in the file display area.

### Fast forward button

Fast-forwards play.

### Slow button

Makes play in slow motion.

### Pause button

Temporarily stops play.

### Prior file button

Displays the previous files in the file display area.

### Stop button

Stops play.

### Play button

Plays a selected file.



# OUTLINE OF OPERATIONS

The following describes the outline of operations you can perform with a PC master station.

## Communication

- On a sub station (door station or room sub station), you can call up to 20 preset (PC) master stations in your site at the same time. Or you can call up to 19 (PC) master stations in your site and a remote site (up to 20 (PC) master stations at the remote site).
- On a PC master station, the communication method can be selected from the hands-free mode or the press-to-talk mode. (→P. 13)
- You can also communicate with a remote site (a pilot station registered in the site).

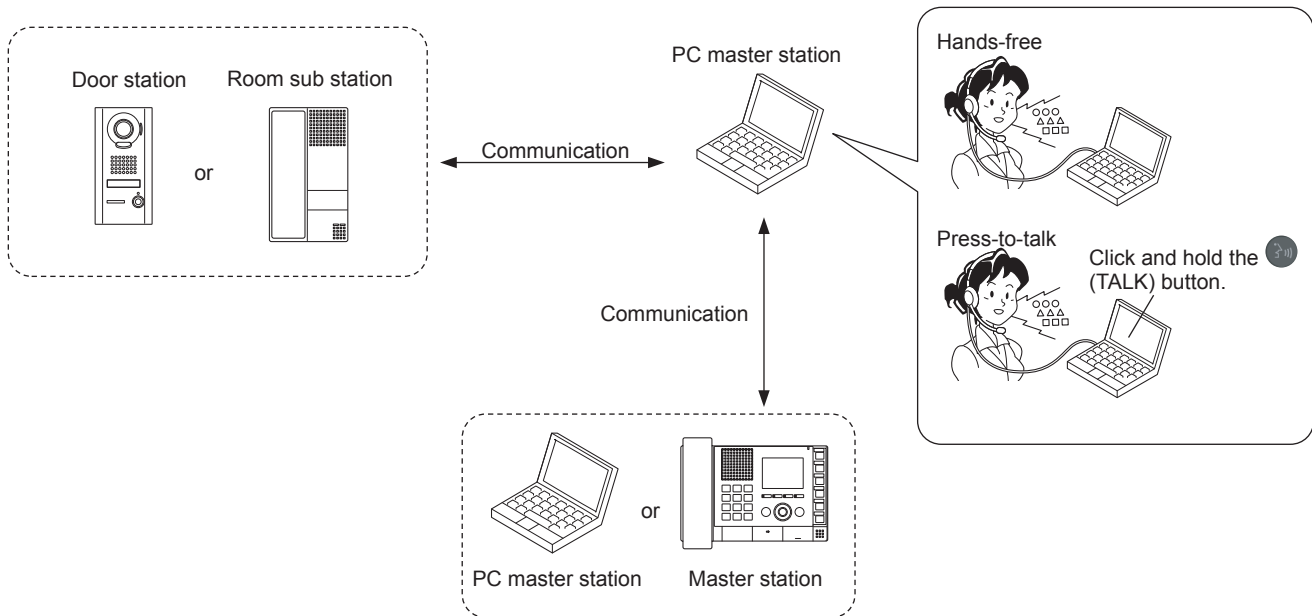

## Transferring

When communicating with a received call on a PC master station, you can transfer it to another (PC) master station in your site. (→P. 17)

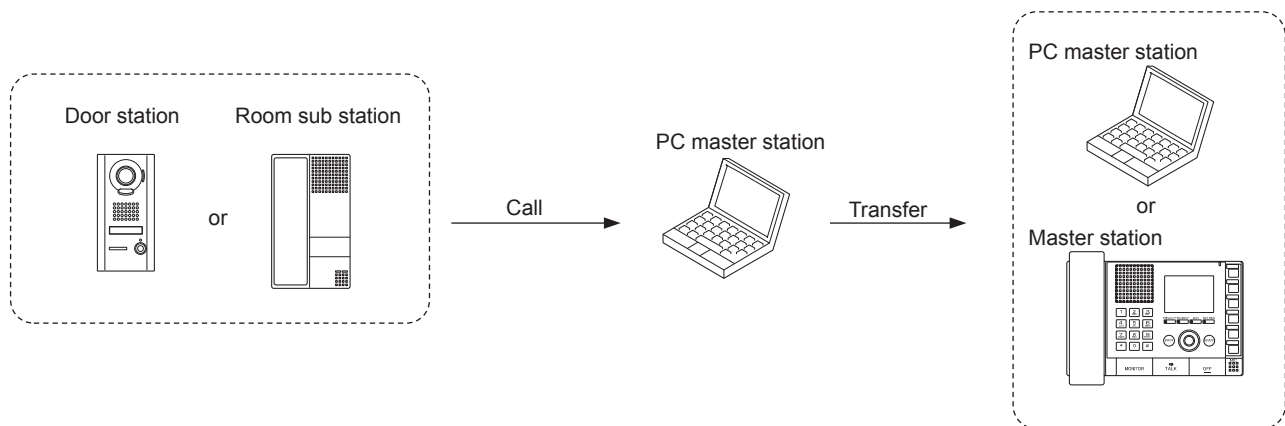

- \* You can also make a transfer setting for transferring calls to a designated (PC) master station automatically.
- \* For a call from another (PC) master station, you can transfer it only when you are communicating with it (not to the remote site).
- \* You can also transfer a call to a remote site. (However, you cannot transfer a call received from a remote site to another remote site.)

## Paging

On a PC master station, you can initiate paging or chime paging to the selected zone(s). All the stations previously registered to the zone(s) receive the paging or chime. (→P. 27)

- \* You can also call another (PC) master station or a sub station individually by direct voice call. The receiver can reply in the hands-free mode.
- \* You can also make paging or chime paging to the registered external speaker(s).
- \* You can also make paging or chime paging to a specified zone in a remote site when the site has chime sources. (When the site does not have a central control unit, the chime paging does not initiate.)

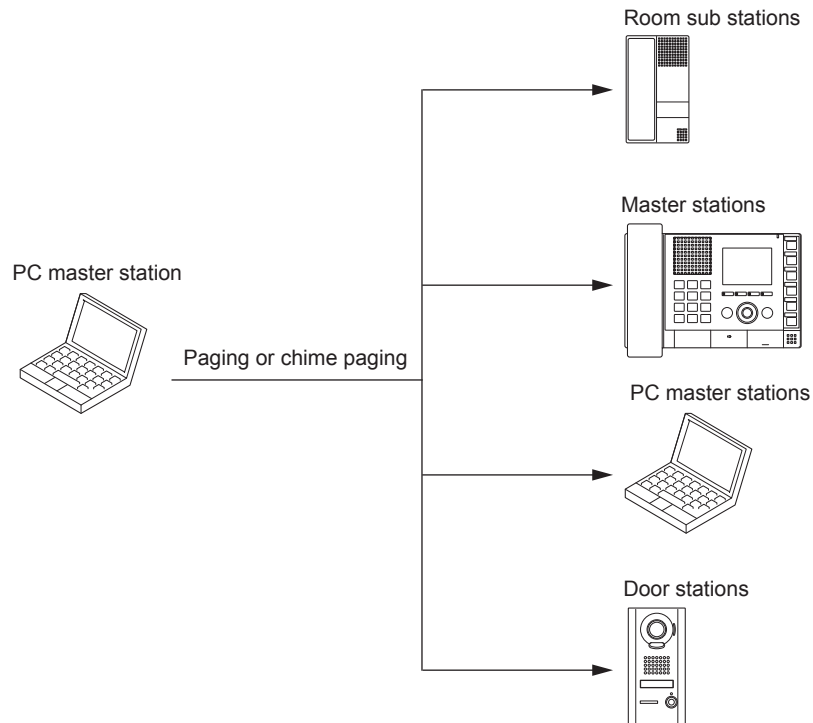

## Monitoring

On a (PC) master station, you can monitor a sub station in your site. You can also initiate the scan-monitoring (monitoring multiple preset stations sequentially). For an audio door station or room sub station, you can monitor sounds only. (→P. 26)

- \* You cannot monitor or scan-monitor a remote site.

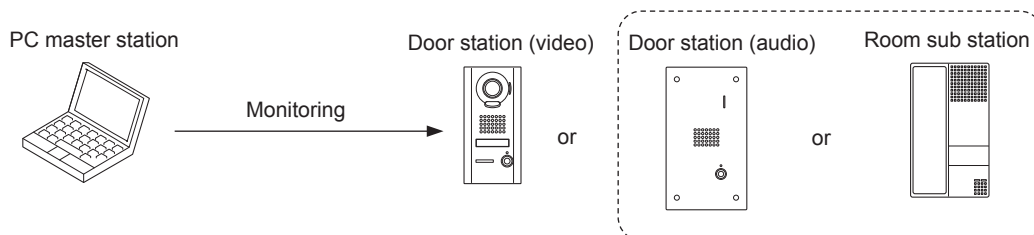

## Door release

On a PC master station, you can unlock the door associated with a sub station call in which a door release device is connected. (→P. 18)

\* You can also unlock the door (door release device) connected to a sub station in a remote site depending on the setting.

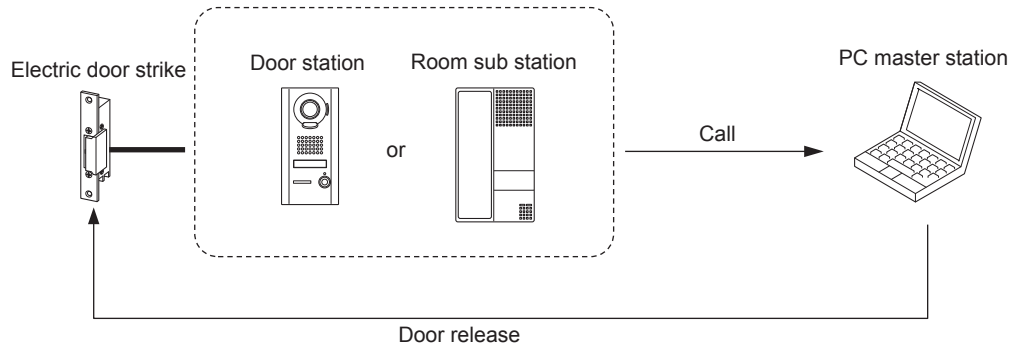

### NOTE:

If the door station does not have a camera, you cannot view the image of the visitor. Confirm the visitor securely.

# USING THE PC MASTER STATION

## RECEIVING AND ANSWERING A CALL ON THE PC MASTER STATION

The following describes the communication method using a PC master station.

- \* When receiving a call from a remote site, the operation methods are the same as described below, however it may take a longer time for some operations and their responses. For example, there may be a time difference between a call starting at a remote site and the call tone ringing on the target (PC) master station in your site.

### Receiving a call

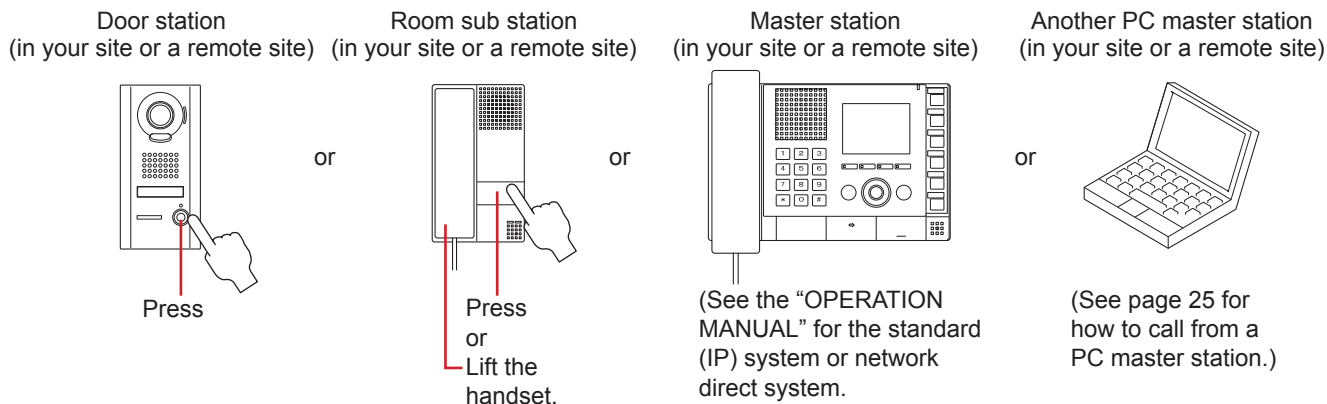

#### 1 The call tone rings, and the corresponding display appears.

- \* The call tone from a sub station differs from the setting in the Setting window. (→"SETTING MANUAL")

e.g.) When called from a video door station

The video image at the calling station is displayed following the symbol image.

- \* It may take long until a video image appears.

The station no. and station name are displayed.  
(For a remote site, the number and name of the site are displayed.  
The station name will not be displayed.)

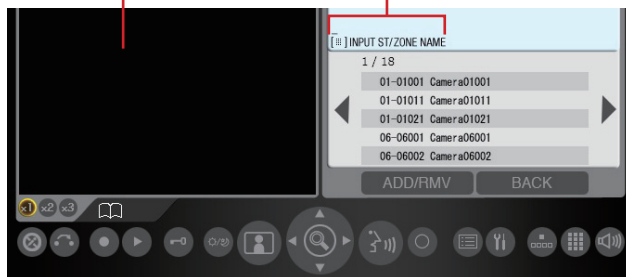

- \* When an audio door station, room sub station or another (PC) master station calls in, the station type image is displayed. (The image differs from the calling station type.) When called from a remote site, the remote site symbol image is displayed.
- \* An incoming call from a (PC) master station will be a direct voice call. (However, when the PRIVACY mode is set to "Privacy 2", you will be notified of an incoming call by the display information and call tone.)

#### NOTES:

- A PC master station cannot receive two or more calls at a time.
- A call or talk may not be possible when the communication path is fully occupied.
- Video images at the target video door station may not appear on the monitor when the video path is fully occupied even though a call or talk is possible.

## Answering a call

The maximum duration of communication is preset in the System setting. (It can be set to a maximum of 10 minutes.)

- 1 Answer the call in one of the following ways.

### ■ Communication in the hands-free mode

(Available when "Communication method" is set to "Hands-free" in the Setting window.)

<When called in from a sub station>

- 1) Click .



After a beep, you can communicate in the hands-free mode.

\*1: When talking: Lit  
When listening to the caller: Off

- 2) When you have finished the communication, click .  
Communication will end.

\* You can communicate in the press-to-talk mode by the following operation even when "Hands-free" is set (e.g., when it is noisy around you).

- Click and hold  for more than one second while communicating. (Beeps once.)

### <When you received a direct voice call from another (PC) master station>

You can talk back to it. If you click and hold  for more than one second, it changes to the press-to-talk mode. (Beeps once.)

### ■ Communication in the press-to-talk mode (Available when "Communication method" is set to "Press to talk" in the Setting window.)

<When called in from a sub station>

- 1) Click  momentarily.





After a beep, you can communicate in the press-to-talk mode.

- 2) Click and hold  to talk and release to listen to the caller.

(When talking)

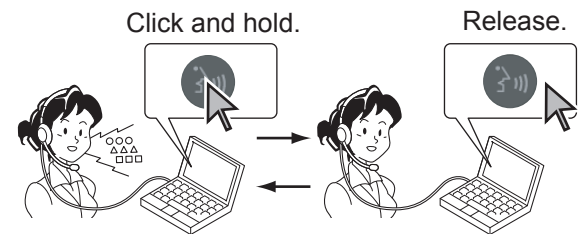
(When listening to the caller)



- 3) When you have finished the communication, click .

### <When you received a direct voice call from another (PC) master station>

Click and hold  to talk with and release to listen to the caller.

## About the priority

The order of priority for actions (communication, calling, paging, monitoring, etc.) is as follows, depending on the priority setting.

Priority	Setting	Action
1 (high)	[URGENT], [BROADCAST]* <sup>1</sup>	Communication, calling, paging, chime paging.
2	[PRIORITY]	
3	[NORMAL]	
4 (low)	-	Monitoring, scan-monitoring

\* Earlier call has priority over later call if the priority setting is the same.

\* Communication takes priority over calling. However, when a call with higher priority comes in, the communication will be forcibly stopped.

\*<sup>1</sup>: [BROADCAST]:  
This can be selected only when you perform paging. When [BROADCAST] is selected, you can perform paging while interrupting all the other communications of lower priority. In that case, no receiver can answer you. For IP units that are in communication, calling or being called when paging with [BROADCAST] is performed, they will turn into the standby mode after paging.

## Viewing video images at a video door station

You can view video images at the target station when receiving a call from or communicating with a video door station, or monitoring a video door station in your site. The video images can be adjusted as necessary by using the following functions on the PC master station.

### Switching Zoom/Wide

The display mode on the monitor can be switched between zoom and wide by each click of .

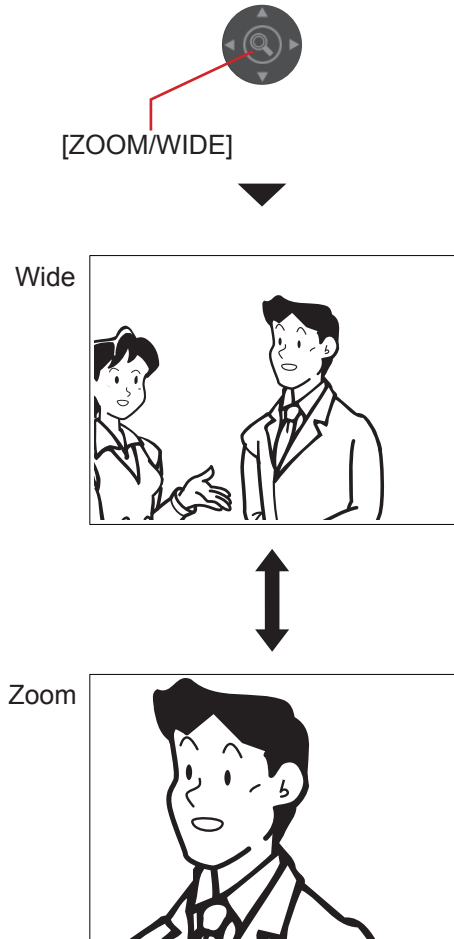

#### NOTES:

- The preset position of zoom image is set in the System setting on a PC.
- When the display mode switches from wide to zoom, the zoom image from the preset position is displayed.
- Depending on the properties of the video door station camera, the wide image may appear more distorted than the zoom image but this is not a malfunction.
- In the zoom mode, the image can be moved from right to left or up and down.

### Pan & Tilt

When a zoom image is displayed, clicking  moves the image as shown below.

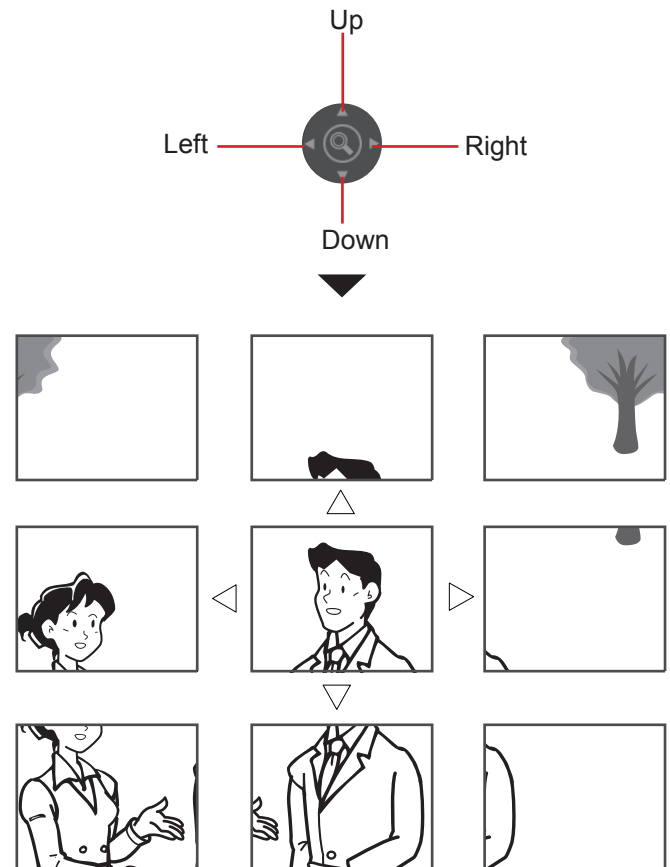

#### NOTES:

- The image range of the zoom mode and wide mode differs. The edge of wide image will not be displayed with the zoom mode.
- At night, the object image may be blurred and less-visible when moving the image from right to left or up and down because illumination to the object is reduced. The same applies to a moving object.

## ■ Adjusting images

If the image on the monitor is difficult to see, you can adjust the image.

- 1 Click  when the image is difficult to see.



Click.



The backlight or night sensitivity is automatically adjusted.

- \* The button stays lit during adjustment.
- \* The discrimination between day and night is performed automatically by the door station.
- \* The adjustment result may vary depending on the System setting on a PC.

<Day>



[Before adjustment]

<Night>



[Before adjustment]



[After adjustment]



[After adjustment]

## To restore the image before adjustment

Click  again.

The lighting of button turns off and the image before adjustment is restored.

### NOTE:

Clicking  at night may make visitors' faces easier to see, but may also make moving objects more difficult to see.



## Transferring to another (PC) master station

You can transfer a call received from a sub station to another (PC) master station while communicating with it (communication transferring), as well as setting calls to be automatically transferred in the "Setting window".

\* For a call from another (PC) master station, you can transfer it only when you are communicating with it. (However, you cannot transfer the communication to a remote site.)

### ■ Communication transferring

1 Receive a call and communicate with it. (→P. 12)

2 Click .

3 Click  to select the (PC) master station (in your site) to which you want to transfer the call (so that it is highlighted) from the list.

4 Press  or .

\* While transferring, a sound rings at the source station to indicate a transfer.

5 Click  to enable the communication between the station that called you and the transfer target station.

### ■ Call transferring

You can transfer a call to the designated (PC) master station (in your site or a remote site) or the telephone registered to the system automatically (without answering it) by the "Transfer" setting in the Setting window.

- \* This function is useful when you are absent or you cannot receive and answer a call.
- \* When transferring to a remote site, a (PC) master station in the site should have been registered as the pilot station of the site.
- \* A call from a sub station (except IS-IPDV and IS-IPDVF) can be transferred to telephone.

The following settings can be made in the Setting window. (Refer to the SETTING MANUAL for details.)

- ① Transferring a call to the designated (PC) master station or remote site automatically ([Transfer], [Transfer destination])
- ② Setting the delay time of triggering transferring after a call is received ([Transfer delay])
- ③ Setting a schedule for call transferring in the System setting on a PC ([Schedule transfer], [Scheduled destination])
- ④ Transferring a call to telephone automatically (when [Telephone transfer] is set to ON)
- ⑤ Transferring a call to telephone automatically in the period of time on the day of the week set in the System setting on a PC (when [Schedule tel transfer] is set to ON)

\* When both ① and ③ are set, ① takes priority.

#### NOTES:

- You can also make a transfer setting for calls at when you are absent. Make the setting in the Setting window. (→ "SETTING MANUAL")
- A call from a remote site can be transferred to a (PC) master station in your site, but not to another remote site.
- A call can be transferred to a remote site, but not to two or more remote sites.

## Door release

You can release the door while being called from, communicating with, or monitoring a sub station if a door release device is connected to the station.

Click  while being called from, communicating with, or monitoring the sub station.

The door is released for the time set in the System setting on a PC.

- \*  is lit while the door is released.
- \* If the set release time is "0", it can be released while the button is clicked and held.

### CAUTION:

Be sure to confirm the visitor securely before releasing the door if the sub station has no camera.

### NOTE:

This function is disabled during scan-monitoring. ( → P. 26)

## Using the PRIVACY function

The PRIVACY function of a PC master station prevents you from being heard by other (PC) master stations in your site or remote sites that call you.

### To activate the PRIVACY function

Set "Privacy" to "Privacy 1" or "Privacy 2" in the Setting window. If you will not use the PRIVACY function, set it to "OFF". (→"SETTING MANUAL")

- \* When set to "Privacy 1" or "Privacy 2", the PRIVACY  button lights up.

### ■ While receiving a call

#### • When the PRIVACY function is activated

The microphone of your PC master station is muted, so the sounds at your side are not heard by the caller.

#### • When the PRIVACY function is off

The microphone of your PC master station is enabled, so the sounds at your side are heard by the caller.

### ■ To communicate with the caller



#### • When the PRIVACY function is activated

Click , and the microphone is enabled. Then you can communicate with the caller.





#### • When the PRIVACY function is off

You can communicate with the caller without clicking .

- \* To mute the microphone temporarily:

Click and hold , and the microphone is muted. Release  to enable the microphone.

### The status of PC master station depending on the PRIVACY mode

PRIVACY mode	PRIVACY LED	When receiving a call from another (PC) master station in your site or remote site	When communicating with a sub station
1	Lit	<ul style="list-style-type: none"> <li>• The microphone is muted.</li> <li>• When you click  to answer the call, the microphone is enabled.</li> </ul>	<ul style="list-style-type: none"> <li>• Microphone is enabled.</li> <li>• The microphone is muted while clicking .</li> </ul>
2	Lit	<ul style="list-style-type: none"> <li>• The microphone is muted.</li> <li>• When you receive a call from a (PC) master station or remote site, the caller and you are notified by a tone that you are in the PRIVACY mode. When you click  to answer the call, the microphone is enabled.</li> </ul>	
OFF	Off	<ul style="list-style-type: none"> <li>• The microphone is enabled. Communication starts when a direct voice call arrives from a (PC) master station or remote site.</li> <li>• The microphone is muted while clicking .</li> </ul>	

### NOTE:

When "Communication method" is set to "Press to talk" in the Setting window, you do not have to activate the PRIVACY function.

# PERFORMING CALLING, MONITORING, PAGING AND CHIME PAGING ON THE PC MASTER STATION

The following describes how to operate the PC master station to perform calling, monitoring, paging and chime paging.

## Searching for a station, zone or remote site

Read this section before you perform calling, monitoring, paging or chime paging on a PC master station for the first time to learn how to search for stations, zones or remote sites. The search can be performed in the following search methods by using the search items, dial keys or speed dial buttons to suit your needs.

### Searching for a station, zone or remote site from the list (→P. 21)

Search items: **A**, **B**, **C**, **D**, **E**, **F** (**F** is for a remote site.)

### Searching for a station, zone or remote site from the placed call or received call list (→P. 24)

Search items: **G**, **H**

### Searching for a station or zone by number using the dial keys (→P. 23)

### Selecting a station, zone or remote site by using the speed dial buttons (→P. 24)

## Basic procedure for selecting the search items

The search items **A** – **H** can be selected from the standby mode or the SEARCH LIST.

\* The items **A** and **B** can be selected from both the standby mode and the SEARCH LIST.

\* A remote site can be selected by using the search item **F**, **G**, **H**, or the speeds dial buttons.

### [In the standby mode]

Press the corresponding button on  to select the target search item **A**, **B**, **G** or **H** shown below.



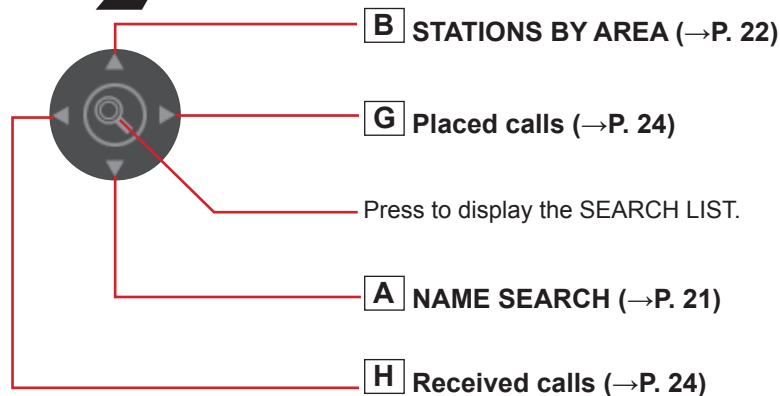

### Search items



## [In the SEARCH LIST]

The search items are shown in the SEARCH LIST.

- 1 Click  in the standby mode.  
The search items are shown in the list area.
- 2 Click  repeatedly to select the target search item **A** to **F** (so that it is highlighted).



SEARCH LIST (page 1/2)

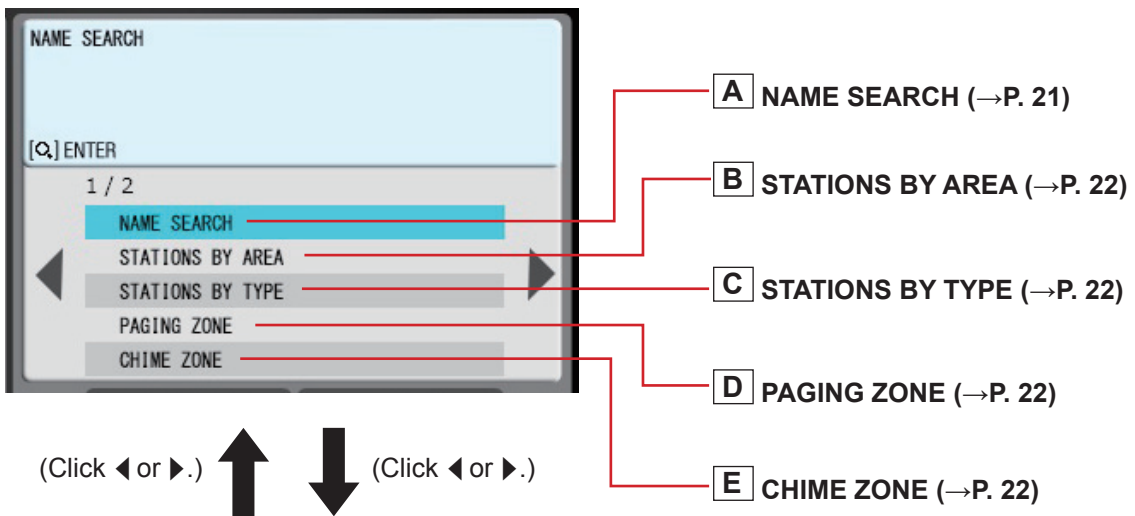

SEARCH LIST (page 2/2)



- 3 Click  to decide on the selected one.

## Searching for a station, zone or remote site from the list

### A Searching for a station or zone in your site by entering the name [NAME SEARCH]

- 1 Select [NAME SEARCH] either in the standby mode (→P. 19) or the SEARCH LIST. (→P. 20)
- 2 Click  to display the Dial keys window.



- 3 Enter a name by using the dial keys.



e.g.)  
When searching for "MASTER004";  
Click the dial keys as follows.

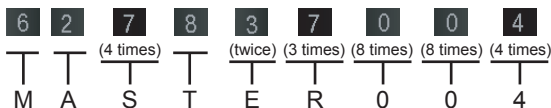

The entered characters are displayed here.

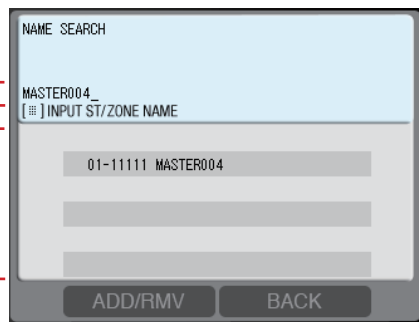

All the station and/or zone names that include the entered characters in your site are displayed in the list.

\* The search is narrowed down whenever a character is added.

#### NOTE:

You can also select a station from the list by using  after you select [NAME SEARCH] in step 1.



#### To delete the just entered character:

Click .





#### To enter the same characters or characters on the same dial key sequentially:

(e.g.: To enter "AB")

1. Enter "A". (Click the dial  key once.)
2. Click .





3. Enter "B". (Click the dial  key twice.)

- 4 Click  to select the target station or zone (so that it is highlighted) from the list.



\* You can select up to 5 stations and/or zones by clicking . (See below.)

- 5 Start calling (talking), monitoring or paging by following the procedure for the corresponding performance. (→P. 25-27)



#### To select two or more stations and/or zones from the list:

- 1) Click  with the target station or zone highlighted.  
The station or zone is checked.  
\* Click  again to clear the check.
- 2) Repeat step 1) to select more stations and/or zones.  
\* You can select up to 5 stations and/or zones. To select 5 stations and/or zones, after checking 4 stations and/or zones, select the 5th one so that it is highlighted. (The 5th station or zone is not checked.)  
\* You cannot select two or more remote sites.

**B Searching for a station in your site by designating an area [STATIONS BY AREA]**

- 1 Select [STATIONS BY AREA] either in the standby mode (→P. 19) or the SEARCH LIST. (→P. 20)
- 2 Click  to select the target area in your site from the list (so that it is highlighted), and then click  to select.  
All the stations in the area are displayed in the list.
- 3 Click  to select the target station (so that it is highlighted).  
\* You can select up to 5 stations. (→P. 21)
- 4 Start calling (talking), monitoring or paging by following the procedure for the corresponding performance. (→P. 25-27)

**C Searching for a station in your site by designating a station type [STATIONS BY TYPE]**

- 1 Select [STATIONS BY TYPE] from the SEARCH LIST. (→P. 20)  
All the station types are displayed in the list.
- 2 Click  to select the target station type from the list (so that it is highlighted), and then click  to select.  
All the stations of the selected type are displayed in the list.
- 3 Click  to select the target station in your site (so that it is highlighted).  
\* You can select up to 5 stations. (→P. 21)
- 4 Start calling (talking), monitoring or paging by following the procedure for the corresponding performance. (→P. 25-27)

**D Searching for a paging zone in your site from the list [PAGING ZONE]**

- 1 Select [PAGING ZONE] from the SEARCH LIST.  
All the registered paging zones are displayed in the list.
- 2 Click  to select the target zone (so that it is highlighted).  
\* You can select up to 5 zones. (→P. 21)
- 3 Start paging by following the procedure for paging. (→P. 27)

**E Searching for a chime zone in your site from the list [CHIME ZONE]**

- 1 Select [CHIME ZONE] from the SEARCH LIST.  
All the registered chime zones are displayed in the list.
- 2 Click  to select the target zone (so that it is highlighted).  
\* You can select up to 5 zones. (→P. 21)
- 3 Start chime paging by following the procedure for chime paging. (→P. 27)

**F** Searching for a remote site as the target of calling, paging or chime paging from the list [REMOTE SITE]

**1** Select [REMOTE SITE] from the SEARCH LIST.  
All the registered remote sites are displayed in the list.

**2** Click  to select the target site (so that it is highlighted).

\* After this step, you can call the pilot station of the target site with the "Normal" priority by clicking .  
For other calling operations such as selecting the priority, refer to P. 25.

**3** After clicking , select the performance you want to do from [CALL], [PAGING] and [CHIME] from the list (so that it is highlighted).

**4** Start calling, paging or chime paging by following the procedure for the corresponding performance. (→P. 25-27)

**NOTES:**

- Before you perform calling, paging or chime paging to a remote site, confirm what unit(s) in the site will receive and/or respond to your performance.
- You cannot select two or more remote sites.

Searching for a station or zone by number using the dial keys

**1** Click  to display the Dial keys window.

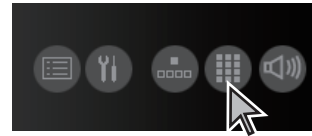

**2** Enter the number of the station or zone you want to search for by using the dial keys in the standby mode.



The entered numbers are displayed, and all the stations and/or zones that include the entered number are displayed in the list.

\* The search is narrowed down whenever a figure is added.

**3** Click  to select the target station and/or zone (so that it is highlighted).

\* You can select up to 5 stations and/or zones. (→P. 21)



**4** Start calling (talking), monitoring or paging by following the procedure for the corresponding performance. (→P. 25-27)

## Searching for a station, zone or remote site from the placed call or received call list



You can search for a station, zone or remote site from the most recent 20 items of the call and/or (chime) paging record or reception record.

\* The items are displayed in the list in chronological order.

### G Searching for a station, zone or remote site from the call and/or (chime) paging record list

- 1 Click  to display the placed call (and/or (chime) paging) record list in the list area. (→P. 19)  
Up to 20 items (target stations, zones or remote sites) of the most recent call and/or (chime) paging you performed are displayed in the list.
- 2 Click  to select the target station, zone or remote site (so that it is highlighted).
- 3 Start calling (talking), monitoring, paging or chime paging by following the procedure for the corresponding performance. (→P. 25-27)

### H Searching for a station or remote site from the reception record list

- 1 Click  to display the received call (and/or paging) record list in the list area. (→P. 19)  
Up to 20 items (stations or remote sites) of the most recent call and/or paging you received are displayed in the list.
- 2 Click  to select the target station or remote site (so that it is highlighted).
- 3 Start calling (talking) or monitoring by following the procedure for the corresponding performance. (→P. 25, 26)

## Selecting a station, zone or remote site by using the speed dial buttons

Select a station, zone or remote site registered to one of the speed dials (1 to 24) clicking by clicking the corresponding speed dial button.

- 1 Click  to display the Speed dial window.



- 2 Select a station, zone or remote site registered to one of the speed dials (1 to 24).

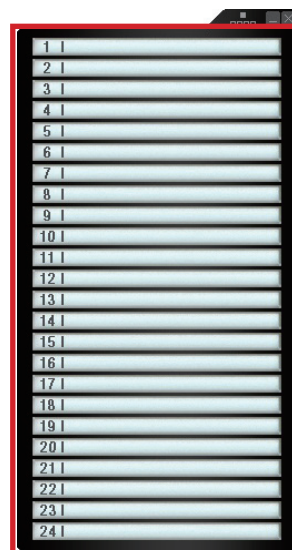

Speed dial buttons

- 3 Start calling (talking), monitoring, paging or chime paging by following the procedure for the corresponding performance. (→P. 25-27)



## Calling another station (direct voice call)

Follow the steps below to call a desired door station, room sub station or master station in your site, or remote site.

- 1 Search for and select the station or remote site you want to call (so that it is highlighted) in one of the search methods. (→P. 21-24)
  - \* If you call (the pilot station in) a remote site by searching for it from [REMOTE SITE] of SEARCH LIST, select the target site, and then select [CALL] (so that it is highlighted). (→P. 23)

### Refer to the on-screen instructions:



Be sure to make operations by checking the information on the upper part of the list area. The next operations you can perform are displayed.

e.g.)



[🔊] TALK ... You can start talking by clicking .  
 \* If you will not set the priority, it is set to "Normal".

[👤] MONI ... You can start monitoring by clicking .

[🔍] PR (or PRIORITY) ..... You can proceed to the priority setting mode by clicking .

- 2 To set the priority, click , and then click  to select the target priority (so that it is highlighted).

\* If you will not set the priority, skip this step and click . You can start calling (talking) with "Normal" priority.

- 3 Click  or  to start calling (talking).

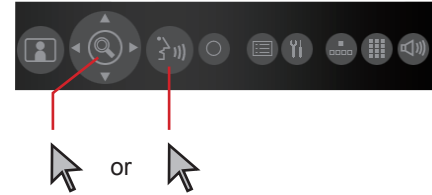

When a tone rings, your voice is heard at the target station and you can also hear sounds at the target station. (Direct voice call)

The receiver can answer the call without pressing any button or lifting the handset. (Talk back)

\* If the target station is a (PC) master station, the response of it differs from the PRIVACY mode setting on the target station. (See the table below.)

PRIVACY mode setting on the target master station	Response
OFF	Your voice is heard at the target station and you can also hear sounds at the target station.
1	Communication is enabled when the receiver makes an answering operation. Otherwise you can hear no sound from the target station.
2	When the target station receives your call, a tone notifies you that the target station is in the "Privacy 2" mode. Communication is enabled when the receiver makes an answering operation. Otherwise you can hear no sound from the target station. * You can adjust the volume of call tone by using the speaker volume adjusting slider in the volume control window.

- 4 Click  to finish communicating.

## Monitoring

You can monitor a sub station or multiple sub stations in your site sequentially (scan-monitoring) with a PC master station.

- \* When monitoring a video door station, you can view the image at the station and hear the sound. When monitoring an audio door station or room sub station, you can only hear the sound at the station.

### ■ Monitoring

- 1 Search for and select the sub station in your site you want to monitor (so that it is highlighted) in one of the search methods. (→P. 21-24)

#### NOTE:

You cannot monitor a (PC) master station and remote site.

- 2 Click  (when "[] MONI" is displayed).

You can hear the sound and if the station has a camera, you can also view the image.

- \*  appears in the area for a status display icon.

- 3 Click  to finish monitoring.

#### NOTES:

- If the selected station is being used (calling, communicating, being monitored, etc.), you cannot monitor the station.
- If you click  while monitoring, the communication mode starts with the station after a tone.
- During video monitoring, you can switch Zoom/Wide, make Pan & Tilt control and adjust images on the monitor. (→P. 15-16)

### To shift to scan-monitoring

Click  during monitoring.

- \* If the station being monitored is a preset one for scan-monitoring, the scan-monitoring starts from the subsequent station in the scan-monitoring order.
- \* If the station being monitored is not a preset one for scan-monitoring, the scan-monitoring starts from the first station in the scan-monitoring order.

## ■ Scan-monitoring

You can monitor the preset stations in your site (up to 20 door stations and/or room sub stations) sequentially, each for the set duration.

- \* The stations should be preset in the System setting on a PC.

- 1 Click  in the standby mode.

The stations set for scan-monitoring are monitored sequentially, each for the set duration.

- 2 Click  to stop scan-monitoring.

- \*  appears in the area for a status display icon during scan-monitoring.

### To monitor only the desired station continuously:

Click  when the target station is being monitored during scan-monitoring.

- \* Click  again to restart the scan-monitoring.

#### NOTES:

- Clicking  is invalid during scan-monitoring.
- If the PC master station receives a call during scan-monitoring, the scan-monitoring ends automatically.
- If one of the preset stations is being used (calling, communicating, being monitored, etc.) during the scan-monitoring, it will be skipped.
- During the scan-monitoring, the Zoom/Wide, Pan & Tilt, door release and image adjusting functions are disabled. (The camera is fixed in the Wide mode.)

## Viewing video images at the target station

When you are receiving a call from, communicating with a video door station, or monitoring a video door station in your site, you can view video images at the target station.

Use the following functions on the PC master station to control video images as you prefer. (→P. 15-16)

- Switching Zoom/Wide
- Pan & Tilt
- Adjusting images

#### NOTE:

Video images cannot be controlled during scan-monitoring.







## Paging

The system allows you to page (transmit an announcement) the selected zone(s) and/or station(s) simultaneously.

\* For paging a remote site, you can page the zone registered as the target in the site.

### NOTE:

If you use zones, register zones in the System setting on a PC in advance.

- 1 Search for and select the zone or a remote site you want to page (so that it is highlighted) in one of the search methods. (→P. 21-24)
  - \* You can select up to 5 zones and/or stations in your site for paging. (→P. 21)
  - \* For paging a zone in a remote site, you cannot select a zone. If you page (the pilot zone in) a remote site by searching for it from [REMOTE SITE] of SEARCH LIST, select the target site, and then select [PAGING] (so that it is highlighted). (→P. 23)
- 2 To set the priority (when “[Q] PRIORITY” is displayed), click , and then click  to select the target priority (so that it is highlighted).
  - \* If you will not set the priority, skip this step and click . You can start paging after a tone with “Normal” priority.
- 3 Click  or  (when “[PAGING] [Q] PAGE” is displayed).
- 4 After a tone rings, start paging.
- 5 A receiver can answer it and communicate with you by clicking , pressing **TALK** or lifting the handset, or pressing the external call button\*<sup>1</sup>.
  - \* When the priority is set to "BROADCAST", no receiver can answer the paging.  
The paging will be heard in priority to any other performances (of lower priority) including ongoing communications between stations. (→P. 14)
- 6 When you have finished paging, click .

\*1: Connected to a room sub station and the necessary setting should be made in the System setting on a PC. (Be careful not to press the call button on a room sub station by mistake.)









## Chime paging

The system allows you to make chime paging (transmit a chime) to all the stations in the designated zone(s) simultaneously.

\* For chime paging to a remote site, you can make chime paging to the zone registered as the target in the site, and cannot select a sound source.

### NOTE:

If you use zones, register zones in the System setting on a PC in advance.

- 1 Search for and select the zone you want to make chime paging (so that it is highlighted) in one of the search methods. (→P. 22, 24)
  - \* You can select up to 5 zones for chime paging. (→P. 21)
  - \* If you have selected the target zone (so that it is highlighted) by using a speed dial button, skip to step 4.
  - \* For chime paging to a zone in a remote site, you cannot select a zone. If you make chime paging to (the pilot zone in) a remote site by searching for it from [REMOTE SITE] of SEARCH LIST, select the target site, and then select [CHIME] (so that it is highlighted) (→P. 23) and then skip to step 4.
- 2 Click  or  (when “[CHIME] [Q] PLAY SOUND” is displayed).
- 3 Click  to select the sound source of chime from the list (so that it is highlighted).
- 4 To set the priority (when “[CHIME] CHIME [Q] PRIORITY” is displayed), click , and then click  to select the target priority (so that it is highlighted).
  - \* If you will not set the priority, skip this step and click . Chime paging begins with “Normal” priority.
- 5 Click  or  (when “[CHIME] [Q] CHIME” is displayed).  
Chime paging begins.

### Making chime paging automatically

You can also set chime page automatically in your site on a preset schedule in the System setting on a PC.

# RECORDING

The PC master station can record images and/or sounds from other stations automatically or manually.

\* The recording operation differs from the settings in the Setting window as listed below. Refer to the SETTING MANUAL for the recording settings, and change the settings as needed.

Picture Recording Mode	Setting		Description
	Auto Recording	Audio Recording	
Snapshot	ON (Auto Recording)	(Not available)	When there is a call from a video door station, only one snapshot of the first displayed image at the door is recorded automatically.
	OFF (Manual Recording)	(Not available)	When monitoring or talking with a video station during a call, you can manually record only one snapshot of the image at the door.
Video	ON (Auto Recording)	ON/OFF	When there is a call from a video door station, video recording at the door starts automatically. When [Audio Recording] is set to ON, the sound at the door is also recorded. * Audio recording begins after a talking begins. The call tone is not recorded. * Video recording stops when the call from or communication with the door station ends, and the PC master station returns to the standby mode.
	OFF (Manual Recording)	ON/OFF	When monitoring or talking with a video station during a call, you can make a video recording at the door manually. * You can continue recording even if you begin communicating while the recording of the monitoring image is in progress. * When the communication or the monitoring ends, video recording stops.

## NOTES:

- When “Video” is selected at [Picture Recording Mode] and [Audio Recording] is set ON in the Setting window (→“SETTING MANUAL”), the sounds from a sub station (door station or room sub station) or master station can also be recorded during the auto or manual recording.
- Recording can no longer be made if the total amount of recorded files exceeds the “Max. Recording Space” set in the Setting window. A balloon appears to show that “Max. Recording Space” is exceeded.



## Auto recording

When the call button is pressed at a video door station, a snapshot or video of the image at the door is recorded automatically.

When [Audio Recording] is set to ON:

- When called from a sub station, recording of the sounds at the station automatically starts when a communication is started.
- When called from a master station, recording of the sounds at the station starts immediately.

If you want to stop video recording, click .

\*  turns into .

### NOTE:

During recording, the square part in  is illuminated.

## Manual recording

You can record a snapshot or video of the image at the door (and sounds depending on the setting) manually in the following states.

- When called from a video door station
- When monitoring a video door station
- When communicating with a video door station

### ■ How to perform manual recording

#### Snapshot recording

Click  when called from, monitoring or communicating with a video door station.

### NOTE:

You cannot record sounds.

#### Video recording



\* You can also record sounds from a sub station or master station by this method depending on the setting.

**1** Click  when called from, monitoring or communicating with a video door station.

\*  turns into  during recording.

**2** Click  to stop video recording.

### NOTES:

- When you click  while recording during monitoring, recording continues until the set communication time has elapsed or until  is clicked.
- When communication starts while recording during monitoring, you can continue the recording. When the communication or monitoring ends, recording stops.
- During recording, the square part in  is illuminated.

# PLAY

You can play the recorded images with the PC master station.  
You can also delete any unnecessary recorded files.

## Playing recorded image (and/or sound)

- 1 Click  on the Main window.



The Play window opens and the list of recorded files is displayed.

- 2 When necessary, you can search for the target file(s) by designating the period of time and/or the target station type (by clicking ) to narrow down the search result.

Select the target station type.

\* Only the recorded files of the selected station type are searched for.

Designate the start date of the period of time to search for files recorded in the period.

Designate the end date of the period of time.

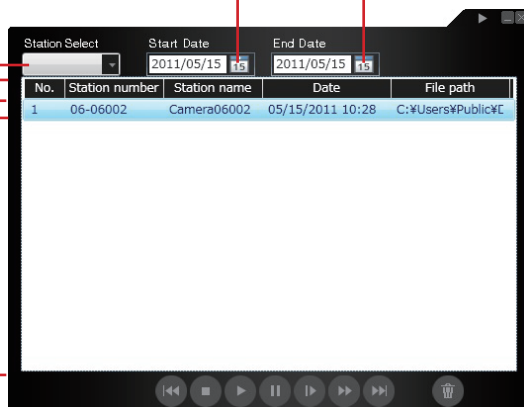

- A list of recorded files corresponding to the search conditions is displayed. The files that have not been played yet are shown in a different color.
- Dates in the recorded file list are also displayed.
- You can display the data in the recorded file list in order of station type, station name or date by clicking "Station number", "Station name" or "Date".

- 3 Select the target file by clicking it (so that it is highlighted.)

- 4 Click  on the Play window to start play.



[Play]

\* The snapshot or video is displayed on the Video display area. If audio has been recorded with the video, the audio is also played. (If the target station of the recorded file has no camera, only sounds will be played.)











\* You can perform various play operation if desired. See the next page for details.

### NOTES:

- If you click another recorded file during play, play stops.
- If a call from another station is received during play, play stops.
- Under normal play conditions, a snapshot image is usually displayed for 2 seconds.
- There may be a file to which images and/or sound are not recorded depending on the communication status at the recorded time.
- If a recording is made to an unanswered call and the recorded file has not been played yet,  on the Main window blinks.

## Play operation list

These operations can also be performed while paused or stopped.

Operation		Button	Remarks
To play in normal speed		 (Play)	-
To stop play		 (Stop)	-
To stop play temporarily		 (Pause)	<ul style="list-style-type: none"><li>• While paused, clicking  moves the recorded images by one frame whenever clicked.</li><li>• When the play of the final frame of a recorded file is paused, and you click  again, the first frame of the recorded file just below the current file is displayed.</li></ul>
To play in slow motion		 (Slow)	<ul style="list-style-type: none"><li>• The recorded file is played at about one quarter of the normal speed.</li><li>• If you click  during slow play, it returns to normal play speed. (No sound is output.)</li></ul>
To play at fast speed		 (Fast Forward)	<ul style="list-style-type: none"><li>• The recorded file is played at about four times the normal speed.</li><li>• If you click  during fast forward, it returns to normal play speed. (No sound is output.)</li></ul>
To skip to the beginning of the desired file (SKIP SEARCH)	To play from the beginning of file just below the current file	 (Next File)	-
	To play from the beginning of the current file	 (Prior File)	-

### When play has finished;

When play reaches the end of the recorded file, the file just below the recorded file is automatically played.

## Deleting a recorded file

You can delete any unnecessary recorded files.

- 1 Open the Play window.
- 2 Select a recorded file (so that it is highlighted).
- 3 Click .  
The selected recorded file is deleted.

# APPENDIX

## TECHNICAL PRECAUTIONS

- If you are experiencing difficulties in the use of the system, please check our web site at <http://www.aiphone.net/>.

## AVAILABLE CHARACTER LIST

The following are the characters that can be entered with each of the dial keys on the master station for station or zone names and numbers.

Some characters are available with a key and they are switched whenever the key is pressed.

Dial key	Characters and number that can be entered with a key									
	Number	Characters								
1	1	.	-	?	!	'	@	_	/	1
2 (ABC)	2	A	B	C	2					
3 (DEF)	3	D	E	F	3					
4 (GHI)	4	G	H	I	4					
5 (JKL)	5	J	K	L	5					
6 (MNO)	6	M	N	O	6					
7 (PQRS)	7	P	Q	R	S					
8 (TUV)	8	T	U	V	8					
9 (WXYZ)	9	W	X	Y	Z					
*										
0										
#										

## SPECIFICATIONS

Your PC must meet the following system requirements to use the IS-SOFT.

Also refer to the instruction manual supplied with your PC.

OS	Windows XP Home/Professional (SP3) (32bit) Windows Vista Ultimate/Home/Business/Enterprise (SP2) (32/64bit) Windows 7 Home Premium/Professional/Enterprise/Ultimate (32/64bit)	
PC system requirements	Processor	2 GHz or higher
	System memory (RAM)	1 GB RAM or higher
	Hard disk	10 MB or more (additional space is needed for recording)
	Sound card	8 bit full duplex, Direct Sound compatible
	Display	800 x 600 or higher (x 1) 1024 x 768 or higher (x 2) 1920 x 1200 or higher (x 3)
	Run-time	Microsoft (R).NET Framework 4.0 or later
	Network	10BASE-T/100BASE-TX Ethernet
Protocol	TCP/IPv4, UDP/IPv4, SIP, Others	
Network bandwidth	320k to 8Mbps	



- The application may not run, or may not operate correctly (such as freezes occurring) on a PC with specifications below the necessary requirements.
- Serious damage could be caused if an error occurs during door release.
- We recommend using a PC and DVD drive that exceed the basic system requirements.





**AIPHONE**®

*Providing Peace of Mind*

<http://www.aiphone.net/>

AIPHONE CO., LTD., NAGOYA, JAPAN  
AIPHONE CORPORATION, BELLEVUE, WA, USA  
AIPHONE S.A.S., LISSES-EVRY, FRANCE

## Free Manuals Download Website

<http://myh66.com>

<http://usermanuals.us>

<http://www.somanuals.com>

<http://www.4manuals.cc>

<http://www.manual-lib.com>

<http://www.404manual.com>

<http://www.luxmanual.com>

<http://aubethermostatmanual.com>

Golf course search by state

<http://golfingnear.com>

Email search by domain

<http://emailbydomain.com>

Auto manuals search

<http://auto.somanuals.com>

TV manuals search

<http://tv.somanuals.com>