

AIPHONE

IS SERIES

Commercial & Security IP Video Intercom system

Network Direct System

SETTING MANUAL

Thank you for selecting Aiphone for your communication and security needs. Please read this manual and the separate "OPERATION MANUAL" carefully before setting and using this system.

* Refer to the provided "INSTALLATION MANUAL" for complete information regarding this system.

IMPORTANT

Please read and understand the system setting procedures before beginning the setup process.

Please note that images and illustrations depicted in this manual may differ from the actual ones.

CONTENTS

ABOUT THIS MANUAL	3
PURPOSE OF THE SYSTEM SETTINGS	3
SETTING LIST	4
SYSTEM SETTING FLOW	8
Flow 1.....	9
Flow 2.....	10
Flow 3.....	11
Remote site connection settings	12
STARTING UP THE SYSTEM AND PREPARING FOR THE SETTINGS	13
System requirements for PC	13
Starting up the system	13
THE SYSTEM SETTING DETAILS	15
The basic setting procedure.....	15
Making network settings to each IP unit [Network setting: Individual].....	16
Making network settings for the whole system [Network setting: Common]	16
Setting the administrator ID and password [Administrator setting].....	17
Confirming the IP units connected to the system [IP unit search].....	17
Registering areas and remote sites [System setting – Area/Site registration] (Required).....	18
Registering zones [System setting – Zone registration]	18
Registering IP units [System setting – IP unit registration]	19
Registering stations [System setting – Registering stations] ..	20
Making detailed settings to stations [System setting – Advanced station settings].....	21
Basic setting procedure.....	21
Making detailed settings to door stations	21
Making detailed settings to master stations	22
Registering stations to zones [System setting – Zone setting].....	23
Registering daily transfer schedule [Transfer setting – Registering daily transfer schedule]	23
Setting transfer schedule [Transfer setting – Transfer schedule setting]	24
Setting the timer [Timer setting].....	25
Setting stations to receive calls and zones to receive paging from remote sites [Remote site pilot call setting]... ..	26
Video setting	27
Setting time and date [Time and date setting]	27
E-mail setting	28
Downloading/uploading setting data [Setting file].....	28
■ When downloading setting data onto the PC	28
■ When uploading setting data.....	28
Updating the system [Updating the system]	28
MAINTENANCE	29
Initializing the system [Initialization].....	29
Downloading system log [System log]	29
Updating the firmware [Firmware update].....	29
■ Downloading updated firmware data	29
Referring to the troubleshooting guide [Troubleshooting].....	29
Registering your system [Registration]	29
Setting Information Memo	30

ABOUT THIS MANUAL

The IS system provides various manuals to meet various system planning and work processes. Use the manuals necessary for your system.

Manual configurations

The following manuals are provided for a network direct system. Read all the manuals for installing, setting up, and using a network direct system, or provide the manuals to the persons working with the system.



INSTALLATION MANUAL (A booklet included with the IP master station (IS-IPMV))

Used for installing and connecting IP master stations and IP video door stations. (For an installer or serviceman)



SETTING MANUAL (This manual on the CD-ROM included with the IP master station (IS-IPMV))

This manual describes how to make the system settings and system maintenance. (For an installer or serviceman)

OPERATION MANUAL (An electronic manual on the CD-ROM included with the IP master station (IS-IPMV))

Information for using the system for calling, communicating, paging, monitoring, etc. (For users of the system)

Note the following:

- This manual describes how to make the system settings for a network direct system (without an IP control unit) only. For a standard (IP) system (including one or more IP control units), refer to the "SETTING MANUAL" for the standard (IP) system.
- Master stations and door stations that can be used in a network direct system are IP units (IS-IPMV, IS-IPDV, IS-IPDVF and IS-SOFT) only.
- PC master stations (IS-SOFT) can also be used in a network direct system. For setting a PC master stations (IS-SOFT), refer to the "SETTING MANUAL" for the PC master station (IS-SOFT).

PURPOSE OF THE SYSTEM SETTINGS

Configure the system settings based on how your system is planned to be used. System settings must be completed before the system will operate.

CAUTION:

Make the settings correctly. If the settings are not made correctly, the system will not function as planned.

SETTING LIST

The following is the list of system settings you can make via the web browser. **The titles or items in shaded cells are required.**

NOTES:

- The following list is a brief overview of the setting items available in the system settings on a PC. The descriptions, and the style and order of descriptions do not necessarily equate with the actual displays.
- The following list describes the setting contents required only for a network direct system. The actual setting windows of the web browser also includes contents not described in the list.
- Make a note of the setting results you have made by using the “Setting Information Memo” (→P. 30) etc. in case of unexpected data erasure, and keep it in a safe place not to lose it.

Title	Sub title	Item	Sub item	Setting range	Default
-	-	(Language)	-	English/French/German/Spanish/Dutch/Italian/Japanese	English
Network setting	Network setting: Individual	IP version	-	IPv4	IPv4
		Host unit setting	-	Host unit/Client unit	Client unit
			Host unit IP address (available when [Host unit setting] is set to “Client unit”)	-	(Enter the Host unit IP address.)
		System name (available when [Host unit setting] is set to “Host unit”)	-	Up to 24 alphanumeric characters	-
		(Select the network setting method.)	-	DHCP/Static IP Address	DHCP
		Static IP Address	Static IP Address (required when [Static IP Address] is selected)	0 – 255 (for each field)	192.168.0.40
			Subnet Mask (required when [Static IP Address] is selected)	0 – 255 (for each field)	255.255.255.0
			Default Gateway	0 – 255 (for each field)	-
			Primary DNS Server	0 – 255 (for each field)	-
			Secondary DNS Server	0 – 255 (for each field)	-
		MAC address	-	(Unmodifiable)	(Unmodifiable)
		Unit name	-	Up to 24 alphanumeric characters (except accent marks, umlaut marks, etc.)	-
		Web port	-	(Unmodifiable)	(Unmodifiable)
	Connection port	-	1024 - 65535	5060	
	Connection Password	-	Up to 16 alphanumeric characters	aiphone	
	Network setting: Common	UPnP	-	ON/OFF	ON
		Global IP address (available when [UPnP] is set OFF)	-	0 - 255 (for each field)	-
		Connection port: global	-	(Unmodifiable)	(Unmodifiable)
		Multicast address 1 - 5 (“Multicast address 3” is not available.)	-	239.0.0.0 - 239.255.255.255	1: 239.0.1.1 2: 239.0.1.2 4: 239.0.1.4 5: 239.0.1.5
		Audio/video port	-	1024 - 65535	50800 - 50813
Administrator setting		New administrator ID	-	Up to 16 alphanumeric characters	-
	Current Password	-	Up to 16 alphanumeric characters	- (aiphone)	
	New Password	-	Up to 16 alphanumeric characters	-	
	New Password (Re-type)	-	Up to 16 alphanumeric characters	-	
IP unit search	-	-	-	-	

Title	Sub title	Item	Sub item	Setting range	Default	
System setting	Area/Site registration	Area/Site Name	-	Up to 24 alphanumeric characters (for up to 99 areas including sites) * Up to 31 for sites	1 (for Area number 01)	
		Area/Site	-	Area/Site	Area	
		IP Address (sites only)	-	0 - 255 (for each field)	-	
		Port number (sites only)	-	1024 - 65535	-	
		Connection Password (sites only)	-	Up to 16 alphanumeric characters	-	
		Door release (sites only)	-	ON/OFF	ON	
	Zone registration	Zone name	-	Up to 24 alphanumeric characters (for up to 99 zones)	-	
	IP unit registration	Station type	-	IP video door station, IP master station, PC master station	-	
		MAC address	-	-	-	
		Unit name	-	Up to 24 alphanumeric characters	-	
		Port number	-	1024 - 65535	50900 - 50902	
	Registering stations	Area	-	(Area) 01 to 99	(Area) 01	
		Station number	-	001 to 999 0001 to 9999 00001 to 99999	-	
		Station name	-	Up to 24 alphanumeric characters	-	
		Station type	-	(Unmodifiable)	(Unmodifiable)	
	Advanced station settings	Video door station	Called stations	Call priority	Normal/Priority/Urgent	Normal
				Called stations	(Set up to 20 targets from the registered ones.)	-
			Other	Transmit volume boost at PTT	ON/OFF (ON: approx. +6dB up)	OFF
				Camera zoom image preset	0 (wide)/1/2/3/4/5/6/7/8/9 (zoom)	5 (Center)
				Call acknowledge tone on/off	ON/OFF	ON
				Backlight adjustment	Exposure +/Exposure -	Exposure +
		Master station	Stations to be scan monitored	(Select up to 20 sub stations from the registered ones.)	-	
			Other	Master station function: paging, chime, monitor, door release, and remote site call	ON/OFF	ON
		Zone setting	Zone number	-	(Select from the registered ones.)	-
			Stations	-	(Select from the list.)	-
	Transfer setting	Registering daily transfer schedule	Schedule number	-	DT1/DT2	DT1
			Schedule name	-	Up to 24 alphanumeric characters	-
Call transfer time			-	Hour: 0 to 23 Minute: 0 to 59 (Set to the Start time and End time individually.)	-	
Transfer schedule setting		Weekly schedule	(Repeat setting)	Every week/Every other week	Every week	
			Schedule start date	From the current day to 1 year ahead	-	
			Schedule end date	From the start day to 1 year ahead	-	
			(Transfer schedule)	None/DT1/DT2 (for each day of the week)	None	
		Individual schedule	(Date)	From the current day to 1 year ahead	-	
			Daily transfer schedule	(Select from the registered ones.)	None	
			Call transfer time	Hour: 0 to 23 Minute: 0 to 59 (Set to the Start time and End time individually.)	-	

Title	Sub title	Item	Sub item	Setting range	Default		
Timer setting		Call	Normal/Priority/Urgent	10 to 600 (sec.), 0 (Unlimited)	Normal: 30 (sec.) Priority: 90 (sec.) Urgent: 0 (Unlimited)		
		Communication	In Local (Not available)	30 to 600 (sec.) (Not used for network direct system)	60 (sec.)		
			Via IP	30 to 600 (sec.)	60 (sec.)		
			Telephone (Not available)	30 to 600 (sec.) (Not used for network direct system)	120 (sec.)		
		Paging	-	30 to 600 (sec.)	60 (sec.)		
		Monitor	-	10 to 600 (sec.)	60 (sec.)		
		Scan monitor: Switching	-	5 to 60 (sec.)	7 (sec.)		
		Contact output (Not available)	External sound source 1	10 to 300 (sec.)	30 (sec.)		
			External sound source 2	10 to 300 (sec.)	30 (sec.)		
Door release	-	0 to 300 (sec.), (0: Released while holding the Door release button pressed.)	10 (sec.)				
Remote site pilot call setting		Remote site master call	Normal/Priority/Urgent	(Select one from the registered stations in your site for each of "Normal", "Priority" and "Urgent".)	-		
		Remote site door call	Normal/Priority/Urgent	(Select up to 20 stations from the registered master stations in your site for each of "Normal", "Priority" and "Urgent".)	-		
		Remote site room sub call (available when the remote site is a standard (IP) system that includes room sub stations (IS-RS).)	Normal/Priority/Urgent	(Select up to 20 stations from the registered master stations in your site for each of "Normal", "Priority" and "Urgent".)	-		
		Remote site paging	Normal/Priority/Urgent/Broadcast	(Select one from the registered zones in your site for each of "Normal", "Priority", "Urgent" and "Broadcast".)	-		
Video setting		Frame Rate	-	1/2/5/7.5/10/15 (fps)	15 (fps)		
		Quality	-	Low, Middle, High, Excellent	Excellent		
Time and date setting		Set current time	Manual setting	Year: 2009 to 2099 Month: 1 to 12 Day: 1 to 31 Hour: 0 to 23 Minute: 0 to 59 Second: 0 to 59	(Internal time of the IP Host unit)		
			Synchronized with PC	-	-		
		NTP	Synchronized with NTP server	ON/OFF	OFF		
			NTP server* ¹	IP address or domain name	-		
			NTP port number* ¹	1 to 65535	123		
			(UTC time zone* ¹) Hour difference* ¹	-12 to +13 (h)	0		
			(UTC time zone* ¹) Minute difference* ¹	-45/-30/0/+30/+45 (m)	0		
			Synchronize interval	1 to 240 (h)	24 (h)		
		Daylight savings time	-	ON/OFF	OFF		
			Starts* ²	Month	JAN to DEC (M)	JAN	
				Day	(Week)	1st to 4th (W)/The last	1st
					(Day)	Sunday to Saturday	Sunday
				Hour	(Hour)	0 to 23 (h)	-
					(Minute)	0 to 59 (m)	-
			Ends* ²	Month	JAN to DEC (M)	JAN	
				Day	(Week)	1st to 4th (W)/The last	1st
					(Day)	Sunday to Saturday	Sunday
				Hour	(Hour)	0 to 23 (h)	-
					(Minute)	0 to 59 (m)	-
Hour difference* ²	0 to 12 (h)	1					
Minute difference* ²	0/30/45 (m)	0					

*¹: Available only when [Synchronized with NTP server] is set to ON.

*²: Available only when [Daylight savings time] is set to ON.

Title	Sub title	Item	Sub item	Setting range	Default	
E-mail setting	-	Email destination address	1/2/3	Up to 256 alphanumeric characters	-	
		Email source address	-	Up to 256 alphanumeric characters	-	
		SMTP authentication	SMTP server	-	Up to 256 alphanumeric characters	-
			SMTP server port	-	1 to 65535	465
			(Email) login ID	-	Up to 256 alphanumeric characters	-
			Password	-	Up to 64 alphanumeric characters	-
		Language selection	-	English/French/German/Spanish/Dutch/Italian/Japanese	English	
		Mailing event	Call: Normal	-	ON/OFF	OFF
			Call: Priority	-	ON/OFF	OFF
			Call: Urgent	-	ON/OFF	OFF
System start	-		ON/OFF	OFF		
Data communication error in the system	-		ON/OFF	OFF		
Setting file	Downloading setting data	-	-	-	-	
	Uploading setting data	-	-	-	-	

SYSTEM SETTING FLOW

First of all, make the network settings. The network setting method differs according to the network environment. Select the flow suitable for your network environment from the chart below, and start the network settings after you fully understand it. After the network settings are finished, make the other individual system settings. See P. 15-28 for the system setting details.

NOTE:

The system settings should be made mainly on the IP host unit in the system (in a site). You select one as the IP host unit among the IP units connected to the system and others as the IP client units. (A PC master station (IS-SOFT) cannot be used as the IP host unit.)

First select the **Flow 1**, **Flow 2** or **Flow 3** from the chart below, then start the network settings by following the selected flow.

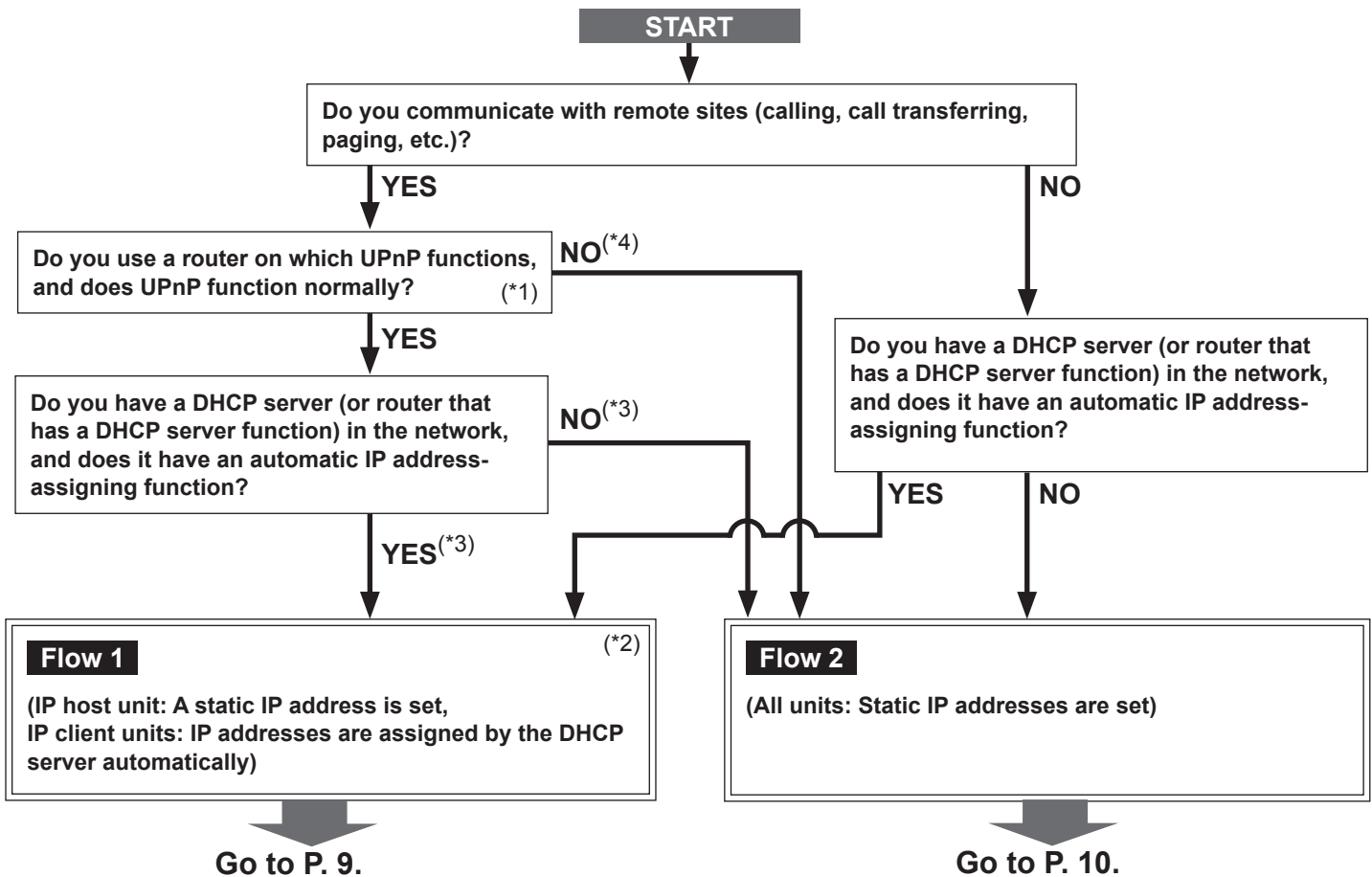

NOTE:

If you connect a PC master station (IS-SOFT) to the network, install the software (IS-SOFT) to a PC before connecting it to the network.

(*1): UPnP may not function normally depending on the router. Refer to [System log]→[UPnP operation check result] (→P. 29) on the IP host unit. If the [System log] window shows that UPnP is not functioning normally, the UPnP function of the router cannot be used with this system. In that case, set [UPnP] to OFF at [Network setting: Common] (→P. 16) and then make settings on the router again by confirming the settings at [IP unit registration] (→P. 19). See <http://www.aiphone.net/> for the router to which the operation check has finished and setting examples.

(*2): If the DHCP server (or router that has a DHCP server function) has a function to assign a static IP address to a specified MAC address, you can make the DHCP server assign the IP addresses to all the IP units automatically.

(→ **Flow 3** (All units: IP addresses are assigned by the DHCP server automatically) (P. 11))

(*3): Set [UPnP] to ON at [Network setting: Common] (→P. 16) (Default: ON).

(*4): Set [UPnP] to OFF at [Network setting: Common] (→P. 16) (Default: ON).

If you communicate with remote sites (calling, call transferring, paging, etc.), make the remote site connection settings (→P. 12) after the network settings for your site have finished.

Flow 1



(IP host unit: A static IP address is set, IP client units: IP addresses are assigned by the DHCP server automatically)

* This is the outline of setting flow. Also make the detailed settings on each setting window referring to the corresponding pages.

START

Write down the MAC addresses of all the IP units to be used in the system in advance by using the "Setting Information Memo" (→P. 30) etc.

* The MAC address is labeled on each unit.

 : Settings on the IP host unit
 : Settings on the IP client units

Decide the static IP address for the IP unit to be used as the IP host unit.

* Use an address out of the range of DHCP assignment for the IP host unit in order to prevent the address for the IP host unit being assigned to another IP client unit by an influence of the turn-on order between the IP host unit and the router (that has a DHCP server function) etc.

(When making the IP host unit settings
before connecting the units to the network)

Connect the IP host unit and the PC used for settings directly, and then turn them on. After a while, access "https://192.168.0.40/" from the browser on the PC. (→P. 14)

NOTES:

- When connecting a PC to the IP unit directly, use an Ethernet crossover cable.
- If a warning dialog box for security or guarding against virus programs appears when accessing the web browser, give permission.

(Log in.)

Make the [Network setting: Individual] settings on the IP host unit. (→ P. 16)

- * Set it as "Host unit".
- * Set the static IP address to the IP host unit.

Update the system at [Updating the system]. (→ P. 28)

Connect the units and the PC used for settings to the network, and then turn them on.
(IP addresses are assigned to the IP client units by the DHCP server automatically.)

Search for the IP units (other than PC master stations) you will use in the system at [IP unit search] on the IP host unit, and open the setting window for each IP unit. (→ P. 17)

Make the [Network setting: Individual] settings on the IP client units. (→ P. 16)

- * Set them as "Client unit" (if they are not set as "Client unit").
- * Enter the IP address of the IP host unit.
- * Select "DHCP" for acquiring IP addresses (if "DHCP" is not selected).

Update the system at [Updating the system]. (→ P. 28)

Confirm the [Network setting: Common] settings on the IP host unit. (→ P. 16)

- * Confirm that the multicast addresses and/or port numbers do not overlap those of other manufacturer's network devices connected to the same network.

(When making the IP host unit settings
after connecting the units to the network)

Connect the units and the PC used for settings to the network, and then turn them on.

Search for the IP address of the IP host unit from the MAC address of the IP host unit by using **IS_IPSEARCH.exe** (in the CD-ROM included with the IP master station (IS-IPMV)). (If the address does not appear, repeat this step until it appears.) Then access the address from the browser on the PC. (→P. 14)

- * This address is the temporary one for the initial setting.

(Log in.)

Make the [Network setting: Individual] settings on the IP host unit. (→ P. 16)

- * Set it as "Host unit".
- * Set the static IP address to the IP host unit.

Update the system at [Updating the system]. (→ P. 28)

Add IP units you will use in the system at [IP unit registration] on the IP host unit. (→ P. 19)

If you will connect your site with remote sites, make the remote site connection settings. (→ P. 12)

Make the other system settings. (→ P. 17-28)

Flow 2

(All units: Static IP addresses are set)

* This is the outline of setting flow. Also make the detailed settings on each setting window referring to the corresponding pages.

START

Write down the MAC addresses of all the IP units to be used in the system in advance by using the "Setting Information Memo" (→P. 30) etc.

* The MAC address is labeled on each unit.

Decide the static IP address for each IP unit.

Make the **[Network setting: Individual]** settings on each IP unit individually. (→ P. 16)

Connect the units and the PC used for settings to the network, and then turn them on respectively.



Confirm the **[Network setting: Common]** settings on the IP host unit. (→ P. 16)

* Confirm that the multicast addresses and/or port numbers do not overlap those of other manufacturer's network devices connected to the same network.

Add IP units you will use in the system at **[IP unit registration]** on the IP host unit. (→ P. 19)
(The selected unit is added in the list whenever selected.)

If you will connect your site with remote sites, make the remote site connection settings. (→ P. 12)

Make the other system settings. (→ P. 17-28)

 : Settings on the IP host unit
 : Settings on the IP client units

For the IP host unit

Connect the IP host unit and the PC used for settings directly, and then turn them on. After a while, access "<https://192.168.0.40/>" from the browser on the PC. (→P. 14)

NOTES:

- When connecting a PC to the IP unit directly, use an Ethernet crossover cable.
- If a warning dialog box for security or guarding against virus programs appears when accessing the web browser, give permission.

(Log in.)

Make the **[Network setting: Individual]** settings on the IP host unit. (→ P. 16)

- * Set it as "Host unit".
- * Set the static IP address to the IP host unit.

Update the system at **[Updating the system]**. (→ P. 28)

For each IP client unit

Connect an IP client unit and the PC used for settings directly, and then turn them on. After a while, access "<https://192.168.0.40/>" from the browser on the PC. (→P. 14)

NOTES:

- When connecting a PC to the IP unit directly, use an Ethernet crossover cable.
- If a warning dialog box for security or guarding against virus programs appears when accessing the web browser, give permission.

(Log in.)

Make the **[Network setting: Individual]** settings on the IP client unit. (→ P. 16)

- * Set it as "Client unit".
- * Enter the IP address of the IP host unit.
- * Set the static IP address to the IP client unit.

Update the system at **[Updating the system]**. (→ P. 28)

Flow 3

(All units: IP addresses are assigned by the DHCP server automatically)

* This is the outline of setting flow. Also make the detailed settings on each setting window referring to the corresponding pages.

START

Write down the MAC addresses of all the IP units to be used in the system in advance by using the "Setting Information Memo" (→P. 30) etc.

* The MAC address is labeled on each unit.

□ : Settings on the IP host unit
□ : Settings on the IP client units

Set the router (or DHCP server) so that it assigns a static IP address to the IP unit to be used as the IP host unit.

Connect the units and the PC used for settings to the network, and then turn them on.

Access the IP address assigned to the IP host unit from the browser on the PC. (→P. 14)

(Log in.)

Make the **[Network setting: Individual]** settings on the IP host unit. (→ P. 16)

* Set it as "Host unit".

* Select "DHCP" for acquiring an IP address.

Update the system at **[Updating the system]**. (→ P. 28)

Search for the IP units (other than PC master stations) you will use in the system at **[IP unit search]** on the IP host unit, and open the setting window for each IP unit. (→ P. 17)

Make the **[Network setting: Individual]** settings on the IP client units respectively. (→ P. 16)

* Set them as "Client unit" (if they are not set as "Client unit").

* Enter the IP address of the IP host unit.

* Select "DHCP" for acquiring IP addresses (if "DHCP" is not selected).

Update the system at **[Updating the system]**. (→ P. 28)

Confirm the **[Network setting: Common]** settings on the IP host unit. (→ P. 16)

* Confirm that the multicast addresses and/or port numbers do not overlap those of other manufacturer's network devices connected to the same network.

Add IP units you will use in the system at **[IP unit registration]** on the IP host unit. (→ P. 19)

If you will connect your site with remote sites, make the remote site connection settings. (→ P. 12)

Make the other system settings. (→ P. 17-28)

Remote site connection settings

You need to make the remote site connection settings to enable communication between your site and remote sites. Make the settings by following the procedure below after the network settings for your site have finished.

* This is the outline of setting flow. Also make the detailed settings on each setting window referring to the corresponding pages.

Procedure

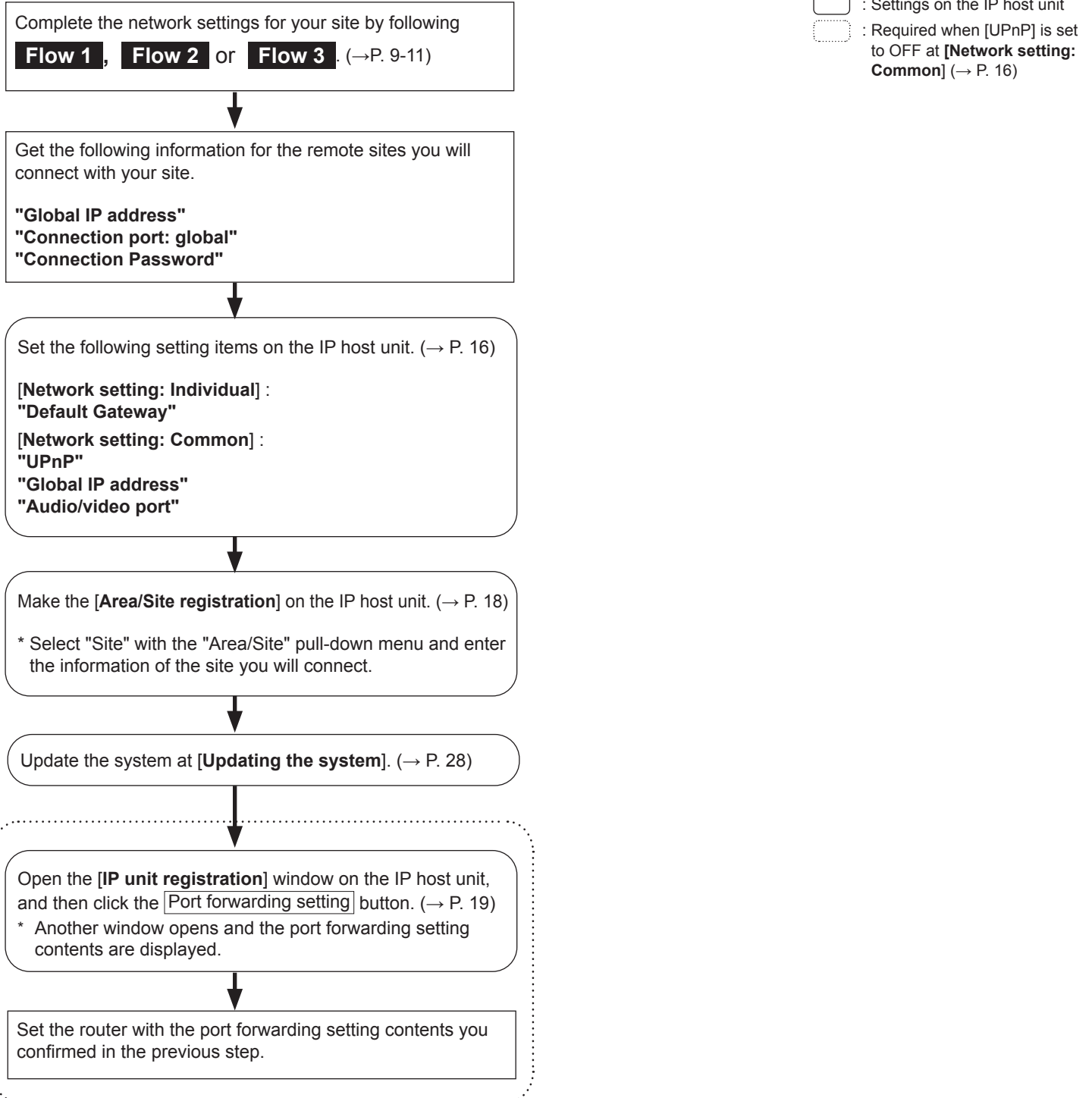

STARTING UP THE SYSTEM AND PREPARING FOR THE SETTINGS

The system settings are mainly made on the PC by accessing the web browser for the settings incorporated with the IP unit as the IP host unit. It is recommended to use only one PC for the settings that is connected to the system.

System requirements for PC

Your PC and operating environment must meet the following system requirements to make the settings.

Network	10BASE-T Ethernet, 100BASE-TX Ethernet
Web browser	Internet Explorer 6.0 or later (with Internet Options SSL 3.0 enabled)

Starting up the system

1 Connect a PC to the IP unit.

[When connecting a PC to the IP unit via a hub (switch)]

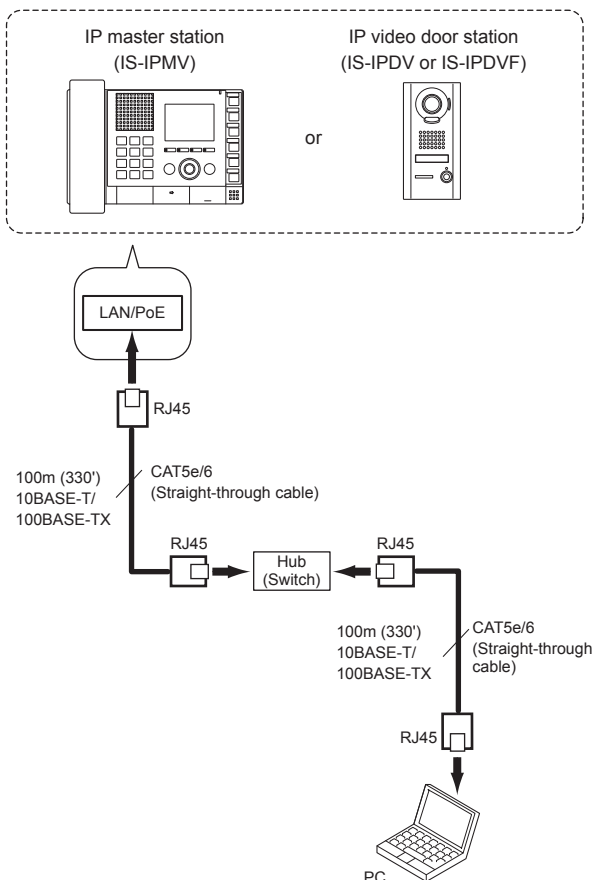

NOTES:

- Be sure to connect the CAT5e/6 cable to the LAN ports of both units.
- The IP address of IP unit is set to (192.168.0.40) and Subnet Mask is set to (255.255.255.0) as default. Change the IP address of your PC if needed.

[When connecting a PC to the IP unit directly]

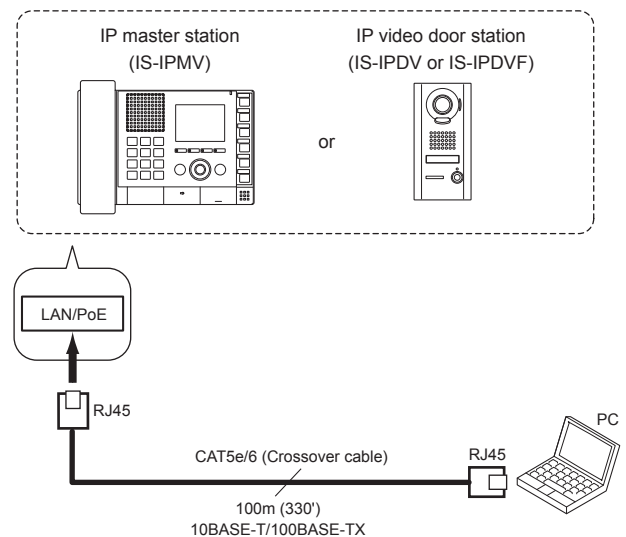

NOTES:

- When connecting a PC to the IP unit directly, use an Ethernet crossover cable.
- The IP address of IP unit is set to (192.168.0.40) and Subnet Mask is set to (255.255.255.0) as default. Change the IP address of your PC if needed.

(Continued on next page)

2 Turn on the power to the IP unit.

- * If the unit is connected to a switch or injector that has a PoE function, the power is being supplied. If a power supply unit is connected to the unit, turn on the power of the power supply unit.
- * Turn on all the units constituting the system depending on the network setting method.
- * The status LED of an IP video door station changes from red lighting to orange blinking.
(When the settings have correctly made, it changes to orange lighting.)
The status LED of an IP master station changes from red lighting to red blinking.
(When the settings have correctly made, it turns off.)

3 Start up the PC, and then open the browser window.

4 Enter the **(static) IP address** assigned to the IP unit to access the web browser for settings.

Default: <https://192.168.0.40>

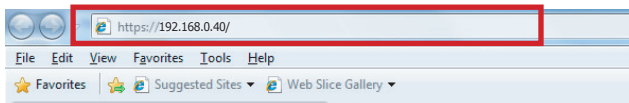

After selecting as the target language, the login window of the web browser is displayed.

5 Log in to the system by setting the following items.

- **ID**
Enter "aiphone".
- **Password**
Enter "aiphone".
- Click to display the setting window.

- * When you log in for the first time, the **[Registration]** window appears. Register your system as needed.
(When registering your system, if you use an IS-SOFT in the system, enter the license key of the IS-SOFT.)

NOTE:

Be sure not to log in to the system more than once at the same time by opening multiple browser windows on the PC.



Go to the next page.

THE SYSTEM SETTING DETAILS

The basic setting procedure

When you have logged in to the system, the setting window appears. You can make the settings on this window.

- * **Make sure to refer to the on-screen instructions and comments displayed on each window when you make the settings.**
- * **Depending on the PC and its OS or environment, the display may differ.**

<Setting window example>

Setting contents display area

The setting items of the selected setting title and their details are displayed here.

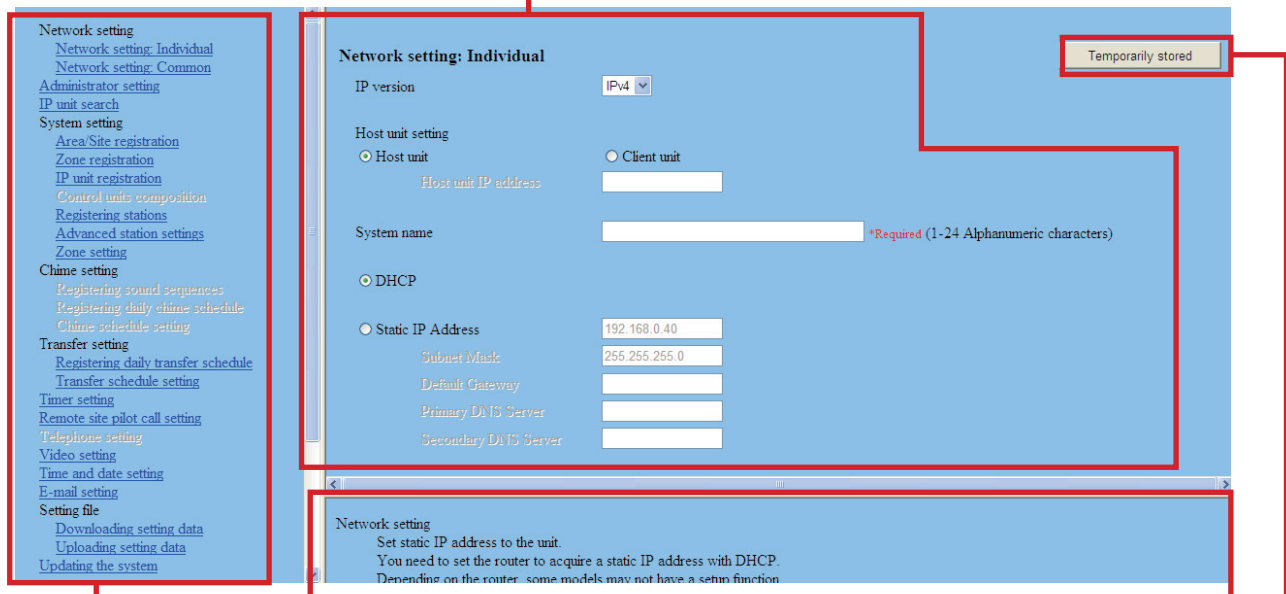

Table of contents

The setting titles are listed here. Click the title on which you want to make the settings to display the corresponding setting window.

NOTE:

The setting titles not required for a network direct system are also grayed out.

Instructions area

The instructions for settings are displayed here.

Temporarily stored

Click this to save the current setting results temporarily.

- * This temporary storing will not update the system with the new setting results. To update the system, click the title "Updating the system" and follow the necessary procedure.

The setting procedure

- 1 Click a title in the table of contents on which you wish to make the settings.
The setting window of the title is displayed.
- 2 Make the settings on the setting items individually.
- 3 When you have finished making the settings on the current window, click **Temporarily stored** to save the setting results temporarily.
 - * If you wish to cancel the setting results you have made, click a title in the table of contents or "Refresh" in the web browser menu. (If you change the current window to another without storing the setting results temporarily, a pop-up window appears asking if you want to store the results temporarily or not.)
- 4 Repeat step 1 to 3 to make the settings on the other titles.

- * To log out of the system, click **[Logout]** in the table of contents.

The following shows the setting procedure for the items of each title.
Refer to "SETTING LIST" (→P. 4-7) for details about the settings. Make the settings by also referring to the on-screen instructions.

Making network settings to each IP unit [Network setting: Individual]

Make the settings for network to each IP unit connected to the system according to your requirements.

- 1 Click **Network setting: Individual** in the table of contents.

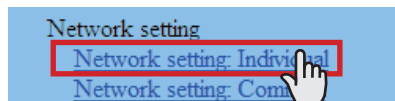

- 2 Make the settings on the following items displayed in the setting window.

- **[Host unit setting]:**
Set this unit as either "Host unit" or "Client unit". **When set to "Client unit", also enter the IP address of the IP host unit.**

- **[System name]: Required**
When "Host unit" is selected at [Host unit setting], it is required to enter a name for this system.

Selecting the network setting method

Set a (static) IP address to this unit. Select the method for acquiring a (static) IP address between [DHCP] and [Static IP Address].

- **[DHCP]:**
Check this when you will acquire an IP address with DHCP.
* A DHCP server (or a router) is required to acquire an IP address with DHCP. A router may not have the setup function depending on some models. For information about setting a router, see the instruction manual for the router.
- **[Static IP Address]:**
Check this when you set the static IP address manually, and then enter the static IP address suitable for the network you are using, subnet mask, etc.
* **It is required to enter the static IP address and subnet mask.**
- **[Unit name]:**
Enter a name for this unit.
* This name is used for searching for this unit in the network. If not named, this unit is recognized only by the unit (station) type and MAC address.
- **[Connection port], [Connection Password]: Required**
Enter the port number for controlling communication and the password for security. Use the same port number and password among the IP host unit and IP client units within the site.

NOTES:

- The IP host unit must not have an IP address identical to the IP address of a remote site's IP host unit.
- The items that cannot be entered or selected are grayed out.

- 3 Click **Temporarily stored** to save the current setting results temporarily.

- * If you wish to cancel the setting results you have made, click a title in the table of contents or "Refresh" in the web browser menu.

- 4 When the settings on this window have finished, update the system from **[Updating the system]**. (→P. 28)

Making network settings for the whole system [Network setting: Common]

Make the network settings for the whole system on the web browser of the IP host unit.

- 1 Click **Network setting: Common** in the table of contents.

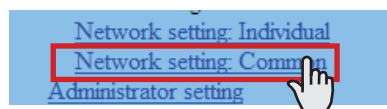

- 2 Make the settings on the following items displayed in the setting window.

- **[UPnP]:**
If you do not use UPnP, set [UPnP] to OFF.
- **[Global IP address]:**
When [UPnP] is set to OFF, enter the static global IP address of the router for use in your site.
- **[Multicast address 1 – 5]: Required**
Enter the multicast addresses for the following:
1: For sound communication for paging between sites
2: For sound communication for paging in your site
3: (Not available)
4: For video communication in your site
5: For video communication between sites
* Do not use multicast addresses that overlap those of other devices connected to the same network.
- **[Audio/video port]: Required**
Enter the port numbers used for audio and video communication.
* Do not use port numbers that overlap those of other devices connected to the same network.

- 3 Click **Temporarily stored** to save the current setting results temporarily.

- * If you wish to cancel the setting results you have made, click a title in the table of contents or "Refresh" in the web browser menu.

Setting the administrator ID and password [Administrator setting]

We recommend that you change the administrator ID and password from default to unique ones for security purposes.

- * This setting can be made to each of the IP units in your site.
- * "aiphone" is preset as the default for both ID and password.

1 Click **Administrator setting** in the table of contents.

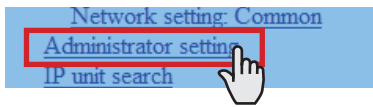

2 Make the settings on the following items displayed in the setting window.

- **[New administrator ID]:**
Enter the new ID.
- **[Current Password]:**
Enter the current password.
- **[New Password]:**
Enter a new password.
- **[New Password (Re-type)]:**
Enter the new password again.

3 Click **Temporarily stored** to save the current setting results temporarily.

- * If you wish to cancel the setting results you have made, click a title in the table of contents or "Refresh" in the web browser menu.

NOTE:

The system administrator must keep the ID and password without fail. If you forget the ID and password, you must initialize the unit, thus all the setting contents return to default.

Confirming the IP units connected to the system [IP unit search]

Before configuring system wide settings, confirm the IP units are connected to the network, and set the network setting for each IP unit using **[IP unit search]**.

1 Click **IP unit search** in the table of contents.



2 Click **[IP unit search]**.

All the IP units connected to the system are displayed in the list.

- * If IP units are not displayed, repeat this step until displayed.

3 Confirm the "Station type", "MAC address" and "Unit name" of the IP units in the list.

4 To make or change settings to an IP unit, check the box for the target IP unit and click

Open the setting window.

Another window opens. You can make settings for the target IP unit individually. (→P. 16)

5 Close the window.

- * Repeat step 3 to 5 to make settings to other IP units.

NOTES:

- This procedure cannot search for PC master stations (IS-SOFT) and it is not a system failure. To add a PC master station (IS-SOFT) in the system, install the application (IS-SOFT) to a PC before connecting it to the network and see page 19.
- It may be required to log in to open the setting window, and update the system at **[Updating the system]** before closing the window.

Registering areas and remote sites [System setting – Area/Site registration]

Required

Register areas (for separating stations in your site) and/or remote sites. The number to which a name is entered is registered as an area or site number. Up to 99 areas and/or sites (up to 31 for sites only) can be registered.

- 1 Click **Area/Site registration** in the table of contents.

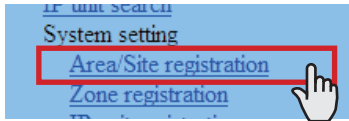

- 2 Enter an area name in the cell for the area number 01.

- * Be sure to enter an area name. A site cannot be registered to the number 01.
- * The figures under “Number” in the tables means the area or site numbers.

- 3 Enter area and/or site names in the cells for other numbers to register more areas and/or sites.

- Select “Area” or “Site” from the pull-down menu of “Area/Site”.
- For a site, enter the IP address (global IP address of the target site), port number and connection password for the target site.
- For a site, set “Door release” to enable (ON) or disable (OFF) the door release action from the target site.

- 4 Click **Temporarily stored** to save the current setting results temporarily.

- * If you wish to cancel the setting results you have made, click a title in the table of contents or “Refresh” in the web browser menu.

NOTES:

- Be sure to register at least one area to the area number 01. (“1” is entered in the cell for the area number 01 as default.)
- A call number displayed on the master station monitor consists of an area number plus a station number (when called from within your site).

Registering zones [System setting – Zone registration]

Register zones for paging (transmitting announcements) in your site. The number to which a name is entered is registered as a zone number. Up to 99 zones can be registered.

* Zones are groups of stations designated for paging.

- 1 Click **Zone registration** in the table of contents.

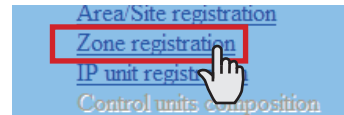

- 2 Enter a zone name in the cell for the target zone number.

- * The figures under “Number” in the table means the zone number.

- 3 Enter zone names in the cells for other numbers to register more zones.

- 4 Click **Temporarily stored** to save the current setting results temporarily.

- * If you wish to cancel the setting results you have made, click a title in the table of contents or “Refresh” in the web browser menu.

Registering IP units [System setting – IP unit registration]

Register IP units by selecting from the connected ones to the system.

* To register a PC master station, first install the application (IS-SOFT) to a PC, then connect the PC to the network and then start IS-SOFT.

1 Click **IP unit registration** in the table of contents.

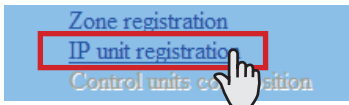

2 Click **IP unit search**.

All the IP units connected to the system are displayed in the [Search result] on the lower side of the window.

* If IP units are not displayed, repeat this step until displayed.

3 Check the boxes for the IP units you want to register, and then click **Add to the imported IP units list**.

The checked IP units are registered and displayed in [Imported IP units list] on the upper side of the window.

4 Enter data or change settings for the registered IP units as needed.

* For "Port number", the sequential numbers are automatically assigned as needed. (You can also enter port numbers manually.)

* Do not use port numbers that overlap those of other devices connected to the same network.

- **Port number auto-setting**:

Click this to assign sequential port numbers automatically.

- **Port forwarding setting**:

Click this and you can confirm the port forwarding settings to be made on the router in another window.

* If [UPnP] is set to OFF at **[Network setting: Common]**, make the port forwarding setting on the router with the set contents in this window manually.

* Click **Reload** on this window to update the current port forward setting, and click **Close** to close this window.

5 Click **Temporarily stored** to save the current setting results temporarily.

* If you wish to cancel the setting results you have made, click a title in the table of contents or "Refresh" in the web browser menu.

NOTE:

A PC master station must be also registered as an IP unit. First install the application (IS-SOFT) to a PC, then connect the PC to the network and then register it.

Registering stations [System setting – Registering stations]

Register all the stations connected in the system, and set the area, station no. and station name to them.

- 1 Click **Registering stations** in the table of contents.

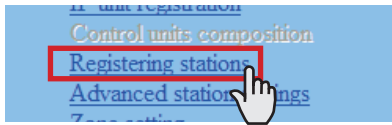

- 2 Set the area, station no. and station name to the target stations.

- * **Setting the station no. is required to register the station to the system.**
- * For a cell with the mark, select the target one from the pull-down menu.
- * Do not set stations with the same number in an area.

NOTE:

The name of a master station displayed on its monitor in standby mode is up to 16 alphanumeric characters.

Other buttons

- **Connection check**
Click to confirm the connected units.
Connected: yellowish green
Not connected: gray
Station type error: pink
- **[Collective setting]:**
The following buttons are used to make the settings to all the checked stations at one time.
* Pressing each button opens another window.

NOTE:

Be sure to check all the target stations before using these buttons.

- **Area**
Click to set the same area number to all the checked stations.
- **Station number**
Click to assign sequential numbers to all the checked stations from top to bottom. The number you enter will be set as the first number and will be assigned to the top station of the ones checked. Other checked stations will be numbered sequentially.
- **Station name**
Click to assign the same station name and sequential numbers to all the checked stations from the top down. Enter a name only.
- **Station type**
(Not available in a network direct system.)

How to select multiple stations

- Click to check the stations you will register.

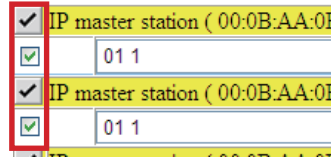

- By clicking the button on the top of the list, you can check or cancel all the stations on the list.

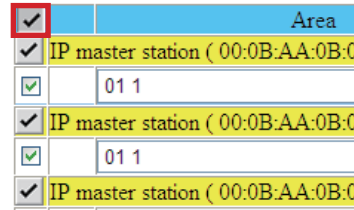

- 3 Click **Temporarily stored** to save the current setting results temporarily.

- * If you wish to cancel the setting results you have made, click a title in the table of contents or "Refresh" in the web browser menu.

Making detailed settings to stations [System setting – Advanced station settings]

Make detailed settings for the registered stations. The settings can be made to a station individually, or multiple stations of the same type at a time. The setting items differ from the station type. First select a station (or stations), and then open the “Advanced settings” window to make the settings.

Basic setting procedure

Click **Advanced station settings** in the table of contents.

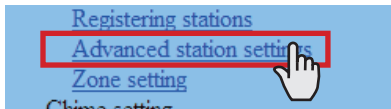

Click to check the station(s) where detailed settings are to be made.

- * Multiple stations of the same type can be set together.
- * All stations of the same type can be selected by clicking the corresponding button under [Select all by type].



Click **Advanced settings**.
The “Advanced settings” window for the selected station type opens.



Make the settings in the displayed windows.

For door stations 

⇒ The right column of this page

For master stations 

⇒ P.22



When you have finished making all the detailed settings:

Click **Temporarily stored** to save the current setting results temporarily.

- * If you wish to cancel the setting results you have made, click a title in the table of contents or “Refresh” in the web browser menu.

Making detailed settings to door stations



The following setting item buttons are displayed in the “Advanced settings” window.

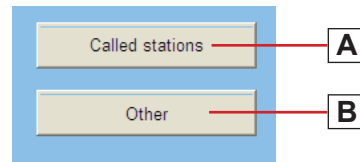

- * Click either the button **A** or **B** to open the corresponding setting window, and then make the settings in the displayed window(s). See the detailed instructions for **A** or **B** below.

- * Click **Close** to close the current window and return to the previous window.

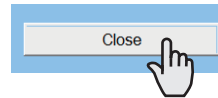

A Settings on [Called stations] setting window

Set the master station(s) in your site and/or a remote site that is (are) to be called from the selected station(s).

- * Up to 20 master stations in your site can be set. Or up to 19 master stations in your site and a remote site (up to 20 master stations are to be set at the remote site) can be set.

- 1 Select the “Call priority” from the pull-down menu.
- 2 Click **Reference** to open another window, then check the target master stations, and then click **Close** to return to the previous window.

The selected master stations are added and displayed in the list.

- * Click **Remote sites** to open another window for selecting the remote site as the target to be called from the selected station(s).

*Set up to 20 master stations.

	<input checked="" type="checkbox"/>	Area/Site	Station number
1	<input type="checkbox"/>	01 1	001
2	<input type="checkbox"/>	01 1	002
3	<input type="checkbox"/>	01 1	003

- * To delete a station (or stations) and/or remote site from the list, check the targets in the list and click **Delete**.

- 3 Repeat step 2 to add more master stations.
- 4 Click **Close** to close the current window and return to the previous window.

B Settings on [Other] window

- **[Transmit volume boost at PTT]:**
Select whether to increase the press-to-talk sound volume transmitted to the stations (ON) or not (OFF).
- **[Camera zoom image preset]:**
Select the default of camera's Zoom/Wide function at calling from the 9 zoom positions and "0" (wide) from the pull-down menu.
- **[Call acknowledge tone on/off]:**
Select whether to sound the call acknowledge tone of door station (ON) or not (OFF).
- **[Backlight adjustment]:**
Select the method of adjusting the backlight in the daytime between "Exposure +" and "Exposure -".
- **Close**
Click this to close the current window and return to the previous window.

About the priority

The order of priority for actions (communication, calling, paging, monitoring, etc.) is as follows depending on the priority setting.

Priority	Setting	Action
1 (high)	[Urgent], [Broadcast]	Communication, calling, paging
2	[Priority]	
3	[Normal]	
4 (low)	-	Monitoring, scan-monitoring

Making detailed settings to master stations



The following setting item buttons are displayed in the "Advanced settings" window.

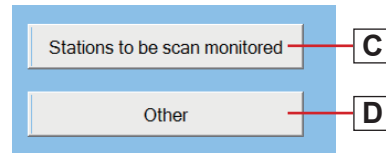

- * Click either the button **C** or **D** to open the corresponding setting window, and then make the settings in the displayed window(s). See the detailed instructions for **C** or **D** below.
- * Click **Close** to close the current window and return to the previous window.



C Settings on [Stations to be scan monitored] window

Set the scan-monitoring target sub station(s).

- * Up to 20 sub stations in your site can be set.

- 1 Click **Reference** to open another window, then select the target stations, and then click **Close** to return to the previous window.
The selected stations are added and displayed in the list.
 - * To delete a station (or stations) from the list, check the target station(s) in the list and click **Delete**.
- 2 Repeat step 1 to register more stations.
- 3 Click **Close** to close the current window and return to the previous window.

D Settings on [Other] window

- **[Master station function: paging, chime, monitor, door release, and remote site call]:**

Select whether to enable the following functions of master station (ON) or not (OFF).

- Starting paging
- Starting chime paging (Not available)
- Monitoring/scan-monitoring
- Releasing door
- Remote site call
- **Close**
Click this to close the current window and return to the previous window.

Registering stations to zones [System setting – Zone setting]

Assign stations to the registered zones.

- 1 Click **Zone setting** in the table of contents.

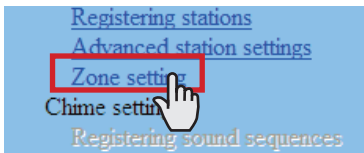

- 2 Select a zone from the pull-down menu.

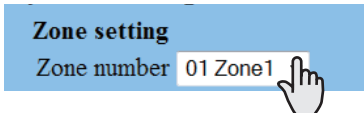

- 3 Click **Reference** to display all the registered stations in your site.

Another window opens and the registered stations are displayed in the list.

- 4 Check to select the target stations.

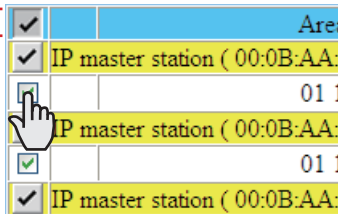

Select stations in the following ways.

- Select stations by checking one by one.
- All stations of the same type can be selected by clicking the corresponding button under [Select all by type].
- By clicking the button on the top of the list, all the stations are checked or canceled.

- 5 Click **Close** after you have finished selecting the stations.

In the previous window, the selection results are displayed in the list.

* When canceling a registered station, check the station in the list, then click **Delete**.

- 6 Click **Temporarily stored** to save the current setting results temporarily.

* If you wish to cancel the setting results you have made, click a title in the table of contents or “Refresh” in the web browser menu.

Registering daily transfer schedule [Transfer setting – Registering daily transfer schedule]

You can set the schedule for transferring calls to other master stations in your site or remote sites automatically. The schedules registered on this setting are used when making a transfer setting on a master station.

Up to 2 daily schedules can be registered.

- 1 Click **Registering daily transfer schedule** in the table of contents.

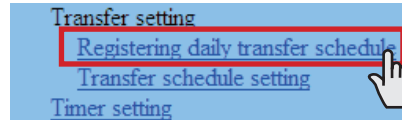

- 2 [Schedule number]:
Select the schedule number DT1 or DT2 from the pull-down menu.

- 3 [Schedule name]:
Enter the name of daily schedule.

- 4 [Call transfer time]:
Set the [Start time (hour and minute)] and [End time (hour and minute)] of transferring.

- 5 Click **Temporarily stored** to save the current setting results temporarily.

* If you wish to cancel the setting results you have made, click a title in the table of contents or “Refresh” in the web browser menu.

Setting transfer schedule [Transfer setting – Transfer schedule setting]

You can set a weekly transfer schedule and individual daily schedule.

* The settings can be made 1 year ahead.

- 1 Click **Transfer schedule setting** in the table of contents.
- 2 Make the settings by clicking **Weekly schedule** and **Individual schedule** respectively to open the corresponding window.

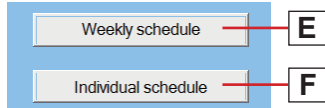

* **Individual schedule** should be clicked after the target date is clicked on the calendar.

- 3 Make the settings in the displayed window(s).



See the detailed instructions for **E** or **F** on the right column of this page.

- 4 After the setting is finished on the corresponding window, click **Close** to close the window.

Calendar and setting status can be checked for the selected month.

The registered daily transfer schedules are identified by colors and shown on the calendar.

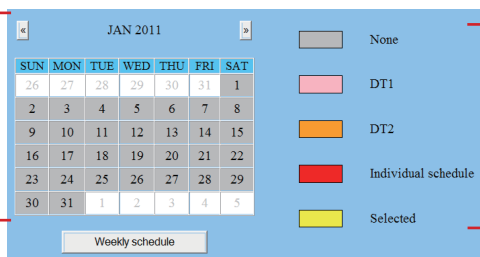

- 5 Click **Temporarily stored** to save the current setting results temporarily.

* If you wish to cancel the setting results you have made, click a title in the table of contents or “Refresh” in the web browser menu.

- 6 When the settings on this window have finished, update the system from **[Updating the system]**. (→P. 28)

E Settings on [Weekly schedule] setting window

- 1) Select either [Every week] or [Every other week].
- 2) Set the schedule start and end dates.
 - * The monthly calendar is displayed by clicking **Refer calendar** and you can select the start and end dates.
 - * If necessary, you can change the month by clicking **◀** or **▶**.
- 3) Set one of the registered daily transfer schedules or no schedule to each day of the week. (Select one from the pull-down menu.)

F Settings on [Individual schedule] setting window

Set an individual schedule to the target date.

* [Individual schedule] setting window will not open if you have not selected the target date on the calendar in the [Transfer schedule setting] window.

- 1) If necessary, you can change the date by clicking **◀** or **▶** repeatedly.
 - 2) [Daily transfer schedule]:
Select either of the registered daily schedules (DT1 or DT2) or no schedule from the pull-down menu.
 - 3) [Call transfer time]:
 - When “DT1” or “DT2” is selected:
The call transfer time is automatically entered. If necessary, change the [Start time (hour and minute)] and [End time (hour and minute)] of transferring manually.
 - When no schedule is selected:
Enter the call transfer time manually.
- * When the time is entered or changed manually, [Daily transfer schedule] changes to “Individual schedule”.

Setting the timer [Timer setting]

Set the time for each operation.

- 1 Click **Timer setting** in the table of contents.

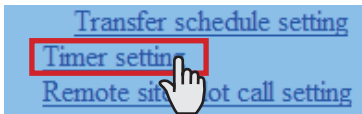

- 2 Set the time for the following operations respectively.

- * The setting range is displayed on the right side of each input box.
- **[Call]:**
Set the duration of call from door stations to [Normal], [Priority] or [Urgent].
- **[Communication]:**
Set the duration of communication between stations in the system including between remote sites [Via IP].
 - * [In Local] and [Telephone]: Not available in a network direct system.
- **[Paging]:**
Set the duration of paging.
- **[Monitor]:**
Set the duration of monitoring only one station.
- **[Scan monitor: Switching]:**
Set the duration of monitoring each station while scan-monitoring.
NOTE:
The actual duration slightly differs from the setting value.
- **[Contact output]:**
(Not available)
- **[Door release]:**
Set the duration of door release.
 - * If you set the time to "0", the door is released while the door release button on the master station is held down.

- 3 Click **Temporarily stored** to save the current setting results temporarily.

- * If you wish to cancel the setting results you have made, click a title in the table of contents or "Refresh" in the web browser menu.

Setting stations to receive calls and zones to receive paging from remote sites [Remote site pilot call setting]

Set the master stations and sub stations to receive calls, and zones to receive paging from remote sites.

* The setting can be made for each priority individually.

- 1 Click **Remote site pilot call setting** in the table of contents.

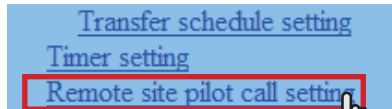

- 2 Make the setting by clicking **Advanced settings** for the setting items **G**, **H**, **I** respectively to open the corresponding window.

G	Remote site master call	Advanced settings
H	Remote site door call	Advanced settings
*1	Remote site room sub call	Advanced settings
I	Remote site paging	Advanced settings
*2	Remote site chime	Advanced settings

- 3 Make the setting in the displayed window(s).



See the detailed instructions for **G**, **H**, **I** on the right column of this page.

- 4 After the setting is finished on the corresponding window, click **Close** to close the window.
- 5 Click **Temporarily stored** to save the current setting results temporarily.

* If you wish to cancel the setting results you have made, click a title in the table of contents or "Refresh" in the web browser menu.

*1: The settings on this item are available for a call from the standard (IP) system in a remote site. The setting method is the same as the item **H**. (Refer to the "SETTING MANUAL" for a standard (IP) system for details.)

*2: Not available

G Settings on [Remote site master call] setting window

You can set a station (master station or door station) that receives a call from a master station in a remote site. One station can be set for each priority.

- 1) Click **Reference** for "Normal".
All the registered stations are displayed in the list in another window.
- 2) Check the box for the target station in the list, and then click **Close**.
The current window closes and the set station is displayed in the [Remote site master call] setting window.

To delete a set station

Click **Delete** for "Normal".

* Selecting another station also overwrites the previous one.

Make the setting for "Priority" and "Urgent" in the same way.

H Settings on [Remote site door call] setting window

You can set up to 20 master stations that receive a call from a door station in a remote site. Up to 20 master stations can be set for each priority.

- 1) Click **Reference** for "Normal".
All the registered master stations are displayed in the list in another window.
- 2) Check the boxes for the target master stations in the list, and then click **Close**.
The current window closes and the set stations are displayed in the [Remote site door call] setting window.

To delete a set station

Check the box for the target station and click **Delete**.

* You can also select two or more stations and delete them at a time.

Make the setting for "Priority" and "Urgent" in the same way.

I Settings on [Remote site paging] setting window

You can set a zone that receives paging from a remote site. One zone can be set for each priority.

- 1) Select the target zone from the pull-down menu for "Normal".
- * Make the setting for "Priority", "Urgent" and "Broadcast" in the same way.

Video setting

- 1 Click **Video setting** in the table of contents.
- 2 Set the following settings for video quality.
 - **[Frame Rate]:**
Set the frame rate selecting “1”, “2”, “5”, “7.5”, “10” or “15” fps from the pull-down menu.
 - **[Quality]:**
Set the video quality selecting “Low”, “Middle”, “High” or “Excellent” from the pull-down menu.
- 3 Click **Temporarily stored** to save the current setting results temporarily.
 - * If you wish to cancel the setting results you have made, click a title in the table of contents or “Refresh” in the web browser menu.

NOTE:

Raising **[Frame Rate]** from 1 to 15 fps gives you a smoother image quality. Also, raising **[Quality]** gives you a finer image. However, if both **[Frame Rate]** and **[Quality]** are raised at the same time, a large amount of network bandwidth will be required.

Setting time and date [Time and date setting]

Set the time and date of the system, used for transfer schedule.

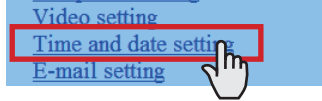
- 1 Click **Time and date setting** in the table of contents.
- 2 Set the following settings.
 - **[Set current time] Required :**
Set the current time and date in one of the following methods.
 - Input the current time and date manually, and then click **Manual setting**.
 - Click **Synchronized with PC** to set the current time and date by making it synchronized with the PC.
 - You can also set the current time and date by making it synchronized with NTP server [**Synchronized with NTP server**] as shown below.
 - * If there is no power supply to the system for a long time because of power failure etc., the time and date setting may be cleared.
 - **[NTP (Network Time Protocol)]:**
Set [**Synchronized with NTP server**] to ON to set the current time and date by making it synchronized with NTP server. Then set the [**NTP server**] and [**NTP port number**].
 - * [**NTP server**]:
Enter the IP address or domain name of the NTP server to be used as the master clock.
 - **[UTC time zone]:**
Set the time differences from Coordinated Universal Time (UTC). Set the [**Hour difference**] and [**Minute difference**] respectively.
 - **[Synchronize interval]:**
When [**Synchronized with NTP server**] is set to ON, the current time and date are set by being synchronized with the NTP server with the entered time interval.
 - **[Daylight savings time]:**
Set whether to utilize daylight savings time (ON) or (OFF). When set to ON, then set the start and end times (Month, Week of the month, Day of the week, Hour and Minute), and time differences (Hour and Minute).
 - * It is recommended to connect the system with a PC or NTP server constantly to keep the correct time and date setting.
- 3 Click **Temporarily stored** to save the current setting results temporarily.
 - * If you wish to cancel the setting results you have made, click a title in the table of contents or “Refresh” in the web browser menu.

E-mail setting

You can send an e-mail when calling or send error messages etc. by e-mail. Up to 3 mail addresses can be set.

NOTES:

- Prepare an e-mail account for this function beforehand.
- Make sure to enter the system name at **[Network setting: Individual]** – [System name] to display the title with an e-mail.
- Make sure to enter primary and/or secondary DNS server information at **[Network setting: Individual]** to all the IP units.

1 Click **E-mail setting** in the table of contents.

2 Set the following settings.

- **[Email destination address]:**
Enter up to 3 mail addresses (destination addresses).
- **[Email source address]:**
Enter the source mail address.
- **[SMTP authentication]:**
Configure SMTP authentication as required by source E-mail provider.
- **[Language selection]:**
Set the language you want to use for entering the system name.
* You can use English only for the body of the message.
- **[Mailing event]:**
Select mailing events by setting the target ones to [ON].

3 Click **Temporarily stored** to save the current setting results temporarily.

- * If you wish to cancel the setting results you have made, click a title in the table of contents or “Refresh” in the web browser menu.

Downloading/uploading setting data [Setting file]

You can download the setting data you have made into a file and save it on the PC. On the contrary, you can upload the setting data from the PC.

- * It is recommended to download the setting data as a backup copy after you finish making settings or setting changes.

■ When downloading setting data onto the PC

1 Click **Downloading setting data** in the table of contents.

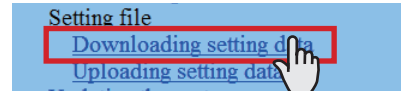

2 Click **Download** to download the current setting data into a file.

■ When uploading setting data

1 Click **Uploading setting data** in the table of contents.

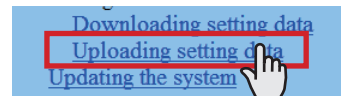

2 Click **Upload** to upload the setting data from the PC to the system.
You can select the setting data file from another window, and upload it.

3 Update the system.

- * Refer to “Updating the system” below.

NOTE:

Uploading the setting data will overwrite the current data.

Updating the system [Updating the system]

Update the system with the setting data you have entered (currently stored temporarily).

1 Click **Updating the system** in the table of contents.

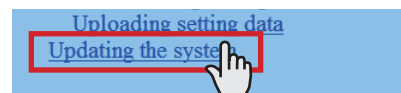

2 Click **Update** to update the system with the setting data currently stored temporarily.

NOTE:

Do not turn off the system while updating the system.

MAINTENANCE

This section describes the use of functions for the system maintenance. These functions are available on the web server.

Initializing the system [Initialization]

You can reset the system settings to factory default.

- 1 Access the web browser and log in.
(→P. 14)
- 2 Click **Initialization** in the table of contents.

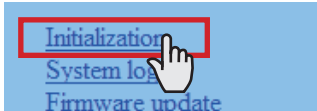

- 3 Click .

Downloading system log [System log]

You can acquire the system operation log.

- 1 Access the web browser and log in.
(→P. 14)
- 2 Click **System log** in the table of contents.



- 3 Click to acquire the log from the system.
- 4 Confirm the log, and save it as needed.

NOTE:

The log is overwritten constantly from the oldest records.

Updating the firmware [Firmware update]

■ Downloading updated firmware data

Please access our web page at <http://www.aiphone.net/> and download the firmware data on the PC to update the system. For the download procedure, see the instructions on our web page.

- 1 Access the web browser and log in. (→P. 14)
- 2 Click **Firmware update** in the table of contents.

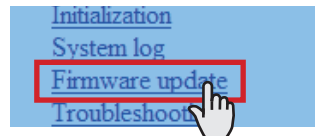

- 3 Click .
 - Another window opens.
 - 4 Click and select the target firmware.
 - 5 When the firmware is displayed in the window, click .
- When "Update firmware." is displayed, the update process is complete.

NOTES:

- If the power is turned off while it is writing, the product will malfunction.
- The system may not operate normally while updating the firmware.

NOTE:

If the update fails, try again.

Referring to the troubleshooting guide [Troubleshooting]

- 1 Click **Troubleshooting** in the table of contents.
The following information appears in the window.
 - Information about the online-help that you can refer to when trouble occurs in setting the system
 - Supported characters and symbols

Registering your system [Registration]

- 1 Click **Registration** in the table of contents.
- 2 Click to open the registration window, and then register your system on the window.
 - * If you use an IS-SOFT in the system, enter the license key of the IS-SOFT.

Setting Information Memo

Record your settings information. It will need when resetting or maintenance.

Host unit					
Network setting: Individual					
Static IP Address			Subnet Mask		
Default Gateway					
Primary DNS Server			Secondary DNS Server		
MAC address					
Unit name					
Connection port			Connection Password		
Network setting: Common					
Global IP address					
Connection port: global					
Multicast address		1:	2:		
		3:	4:		
		5:			
Audio/video port					
Administrator setting					
ID			Password		
Client unit					
Network setting: Individual / Administrator setting					
#	Unit name	MAC address	IP Address	ID	Password
1					
2					
3					
4					
5					
6					
7					
8					
9					
10					
11					
12					
13					
14					
15					
16					
17					
18					
19					
20					
21					
22					
23					
24					
25					
26					
27					
28					
29					
30					
31					

* Download and save the setting data on the PC. Refer to [Setting file] for details.



AIPHONE®

Providing Peace of Mind

<http://www.aiphone.net/>

AIPHONE CO., LTD., NAGOYA, JAPAN
AIPHONE CORPORATION, BELLEVUE, WA, USA
AIPHONE S.A.S., LISSES-EVRY, FRANCE

Free Manuals Download Website

<http://myh66.com>

<http://usermanuals.us>

<http://www.somanuals.com>

<http://www.4manuals.cc>

<http://www.manual-lib.com>

<http://www.404manual.com>

<http://www.luxmanual.com>

<http://aubethermostatmanual.com>

Golf course search by state

<http://golfingnear.com>

Email search by domain

<http://emailbydomain.com>

Auto manuals search

<http://auto.somanuals.com>

TV manuals search

<http://tv.somanuals.com>