

AIPHONE

IS SERIES

Commercial & Security IP Video Intercom system

Network Direct System

INSTALLATION MANUAL

Thank you for selecting Aiphone for your communication and security needs. Please read this manual carefully before installation, and keep it in a safe place for future reference.

Also read the SETTING MANUAL and OPERATION MANUAL on the CD-ROM included with the IP master station (IS-IPMV).

* Refer to the manuals for the standard (IP) system as needed.

When the installation is completed, configure the system by following the SETTING MANUAL. Otherwise, the system will be non-functional.

IMPORTANT

- **Do not install the system until you have completely understood the system and this manual.**
- **The system must be installed and wired by a qualified technician well-versed in network construction.**

Please note that the illustrations in this manual may differ from the actual ones.

CONTENTS

PRECAUTIONS	3
WARNING	3
CAUTION	3
GENERAL PRECAUTIONS	3
Notes on using this system	4
Notices	4
SYSTEM CONFIGURATIONS AND CONNECTIONS	4
Entire system	4
Network direct system connection diagram	5
Cables	6
UNIT DETAILS	7
Color monitor IP master station (IS-IPMV)	7
■ Accessories	7
■ Mounting	7
■ Connections	8

IP vandal-resistant video door station (IS-IPDV, IS-IPDVF)	9
■ Accessories	9
■ Mounting locations	9
■ Mounting positions and image view area of IP video door station	9
■ Mounting	10
■ Connections (IS-IPDV and IS-IPDVF)	11
TECHNICAL DATA AND PRECAUTIONS	12
WARRANTY	13

After unpacking, check the included parts for each product referring to the corresponding pages.

ABOUT THIS MANUAL

The IS system provides various manuals to meet various system planning and work processes. Use the manuals necessary for your system.

Manual configurations

The following manuals are provided for a network direct system. Read all the manuals for installing, setting up, and using a network direct system, or provide the manuals to the persons working with the system.

* These manuals may also be needed when installing an IP master station or IP video door station in a standard (IP) system.



INSTALLATION MANUAL (This manual included with the IP master station (IS-IPMV))

Used for installing and connecting stations. (For an installer or serviceman)



SETTING MANUAL (An electronic manual on the CD-ROM included with the IP master station (IS-IPMV))

Used for making the system settings and system maintenance. (For an installer or serviceman)

OPERATION MANUAL (An electronic manual on the CD-ROM included with the IP master station (IS-IPMV))

This manual describes how to use this system for calling, communicating, paging, monitoring, etc. (For users of the system)

* If you will use these products in a standard (IP) system, also refer to the INSTALLATION MANUAL, SETTING MANUAL and OPERATION MANUAL on the CD-ROM included with an IP control unit (IS-IPC).

PRECAUTIONS

⊘ General Prohibitions ⊘ Prohibition to Dismantle the Unit ⊘ Prohibition on Subjecting the Unit to Water

⚠ General Precautions

⚠ WARNING

Negligence could result in death or serious injury.

- ⊘ 1. Do not dismantle or alter the unit. Fire or electric shock could result.
- ⊘ 2. Keep the unit away from water or any other liquid. Fire or electric shock could result.
- ⊘ 3. High voltage is present internally. Do not open the case. Electric shock could result.
- ⊘ 4. The unit is not of explosion-proof. Do not install or use near gases or flammable materials. Fire or explosion could result.
- ⊘ 5. Do not connect any non-specified power source to the +, - terminals. Also, do not install two power supplies in parallel to a single input. Fire or damage to the unit could result. Be sure to connect a single power supply unit to the unit.
- ⊘ 6. Do not connect any terminal on the unit to an AC power line. Fire or electric shock could result.
- ⊘ 7. Do not use power supply with a voltage other than specified. Fire or electric shock could result.
- ⊘ 8. Keep AC cord from being marred or crushed. If the AC cord is fractured, fire or electric shock could result.
- ⊘ 9. Do not plug or unplug with wet hands. Electric shock could result.
- ⊘ 10. Insert AC plug completely and securely into AC outlet. Otherwise, fire or electric shock could result.
- ⊘ 11. Do not put any metal or flammable material into the unit through the openings. Fire, electric shock, or unit trouble could result.
- ⚠ 12. The unit must be installed and wired by a qualified technician.
- ⚠ 13. Existing wiring such as chime wiring, etc. may contain high voltage AC electricity. Damage to the unit or electric shock could result. Wiring and installation should be done by a qualified technician.

⚠ CAUTION

Negligence could result in injury to people or damage to property.

- ⊘ 1. Do not install or make any wire terminations while power supply is plugged in. It can cause electrical shock or damage to the unit.
- ⚠ 2. When mounting the unit on a wall, install the unit in a convenient location, but not where it could be jarred or bumped. Injury could result.
- ⚠ 3. Before turning on power, make sure wires are correctly connected, not crossed or not shorted. If not, fire or electric shock could result.
- ⊘ 4. Do not install the unit in locations subject to frequent vibration or impact. It may fall or tip over, resulting in damage to the unit or personal injury.
- ⚠ 5. For power supply, use Aiphone power supply model or model specified for use with system. If non-specified product is used, fire or malfunction could result.
- ⚠ 6. On products with ground terminals, connect to an earth ground. Fire or malfunction could result.
- ⊘ 7. Do not put high pressure on the monitor. If fractured, injury could result.

- ⊘ 8. If LCD is punctured, do not allow contact with the liquid crystal inside. Inflammation could result. If necessary, gargle your mouth and clean your eyes or skin with clear water for at least 15 minutes, and consult your doctor.
- ⊘ 9. Do not put anything on the unit or cover the unit with cloth, etc. Fire or unit trouble could result.
- ⊘ 10. Do not install the unit in any of the following locations. Fire, electric shock, or unit trouble could result.
 - * Places under direct sunlight or places near heating equipment that varies in temperature.
 - * Places subject to dust, oil, chemicals, hydrogen sulfide (hot spring).
 - * Places subject to moisture and humidity extremes, such as bathrooms, cellars, greenhouses, etc.
 - * Places where the temperature is quite low, such as inside a refrigerated area or in front of an air conditioner.
 - * Places subject to steam or smoke (near heating or cooking surfaces).
 - * Where noise generating devices such as dimmer switches or inverter electrical appliances are closeby.
 - * Locations subject to frequent vibration or impact.
- ⚠ 11. Do not use the handset when you perform a call test or check the volume, otherwise it may cause damage to your ear. Be sure to use the built-in speaker.
- ⚠ 12. Be sure to perform a call test or check the volume with the handset on the hook. If you operate the hook switch with the handset on your ear, a sudden call etc. may arrive causing damage to your ear.

GENERAL PRECAUTIONS

1. Keep the unit more than 1 m (3.3') away from radio or TV.
2. Keep the intercom wires more than 30cm (12") away from AC 100-240V wiring. AC induced noise and/or unit malfunction could result.
3. Install the unit in an area that will be accessible for future inspections, repairs, and maintenance.
4. As to other manufacturer's devices (such as door releases) used with this system, comply with the Specifications and Warranty conditions that the manufacturers or vendors present.
5. If the unit is down or does not operate properly, unplug the power supply.
6. If it is used close to a cellular phone, the unit may malfunction.
7. The unit can be damaged if dropped. Handle with care.
8. The unit turns inoperative during power failure.
9. In areas where broadcasting station antennas are close by, the intercom system may be affected by radio frequency interference.
10. All the units, except for door station, is designed for indoor use only. Do not use outdoor.
11. This product, being a control unit of door release, should not be used as a crime prevention device.
12. It must be noted in advance that the LCD panel, though manufactured with very high precision techniques, inevitably will have a very small portion of its picture elements always lit or not lit at all. This is not considered a unit malfunction.
13. Door station is weather-resistant, but do not spray with high-pressure water. Unit trouble could result.
14. For wiring, specify CAT5e/6 straight cable.

15. Due to the environmental sound around the unit, it may hinder smooth communication, but this is not a malfunction.
16. When outside temperature lowers sharply after rainfall, etc., the inside of camera may fog up slightly, causing a blurry picture, but this is not a malfunction. Normal operation will be restored when moisture evaporates.
17. Do not locate the units in a location with restricted access. It impedes maintenance inspection or repairs. Also, unit trouble could result.

Notes on using this system

- The ID/Password to access the web server for setting the system is the customer's responsibility. Make sure you set a password that cannot be easily guessed by a third party. We recommend that you change the ID/Password on a regular basis.

Notices

- We will under no conditions be liable for damage that occurs due to failures in network equipment; failures due to internet providers and cell phone companies; failures such as disconnected lines and other losses in communication, which render it impossible to provide this service or in any way delay this service due to causes outside of our responsibility; or if an error or missing data occurs during transmission.

- We will under no conditions be liable for damage that occurs due to the inability to communicate due to malfunctions, problems, or operational errors in this product.
- We will under no conditions be liable for damage caused if a customer's password or transmitted information are leaked through bugging or unlawful computer access over Internet communication.
- We will under no conditions be liable for any damages or losses resulting from this product's contents or specifications.
- This manual was created by Aiphone Co., Ltd., all rights reserved. Copying a part of or this entire manual without prior permission from Aiphone Co., Ltd. is strictly forbidden.
- Please note that images depicted in this manual may differ from the actual images.
- Please note that this manual may be revised or changed without prior notice.
- Please note that product specifications may be changed for the sake of improvement without prior notice.
- Please be aware that it is the customer's responsibility to ensure that their computer is secure. We will under no conditions be liable for security failures.
- This system is not intended for life support or crime prevention. It is just a supplementary means of conveying information. Aiphone will under no conditions be liable for loss of life or property which occurs while the system is being operated.

SYSTEM CONFIGURATIONS AND CONNECTIONS

The IS system is a commercial and security video intercom system especially designed for applications in facilities such as office buildings, factories, schools, hospitals, and prisons. Installed separately from conventional general-purpose internal communications systems, the IS system can be used as a video door entry system, emergency announcement system, rescue assistance system, urgent call system, public announcement system, and access control system.

The IS system can be constructed on an IP network so multiple sites of IS system can be connected and controlled as a global system. You can design the system to any scale depending on your needs.

Entire system

You can construct a large-scale IS system by connecting up to 32 sites (a site can consist of up to 32 IP units) on an IP network. In this system, calling, communication, etc. are possible among sites.

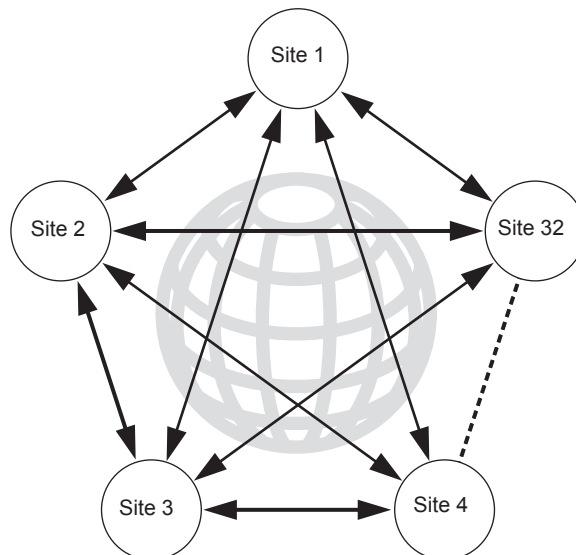

Network direct system connection diagram

The following is an example of network direct system for controlling security and communication for facilities.

- A site must be configured with an IP-based system.
- A network direct system can consist of IP units.
- An IP unit (PC master station, IP door station or IP master station) can be connected directly to a LAN.
- In a site, up to 32 IP units can be connected.

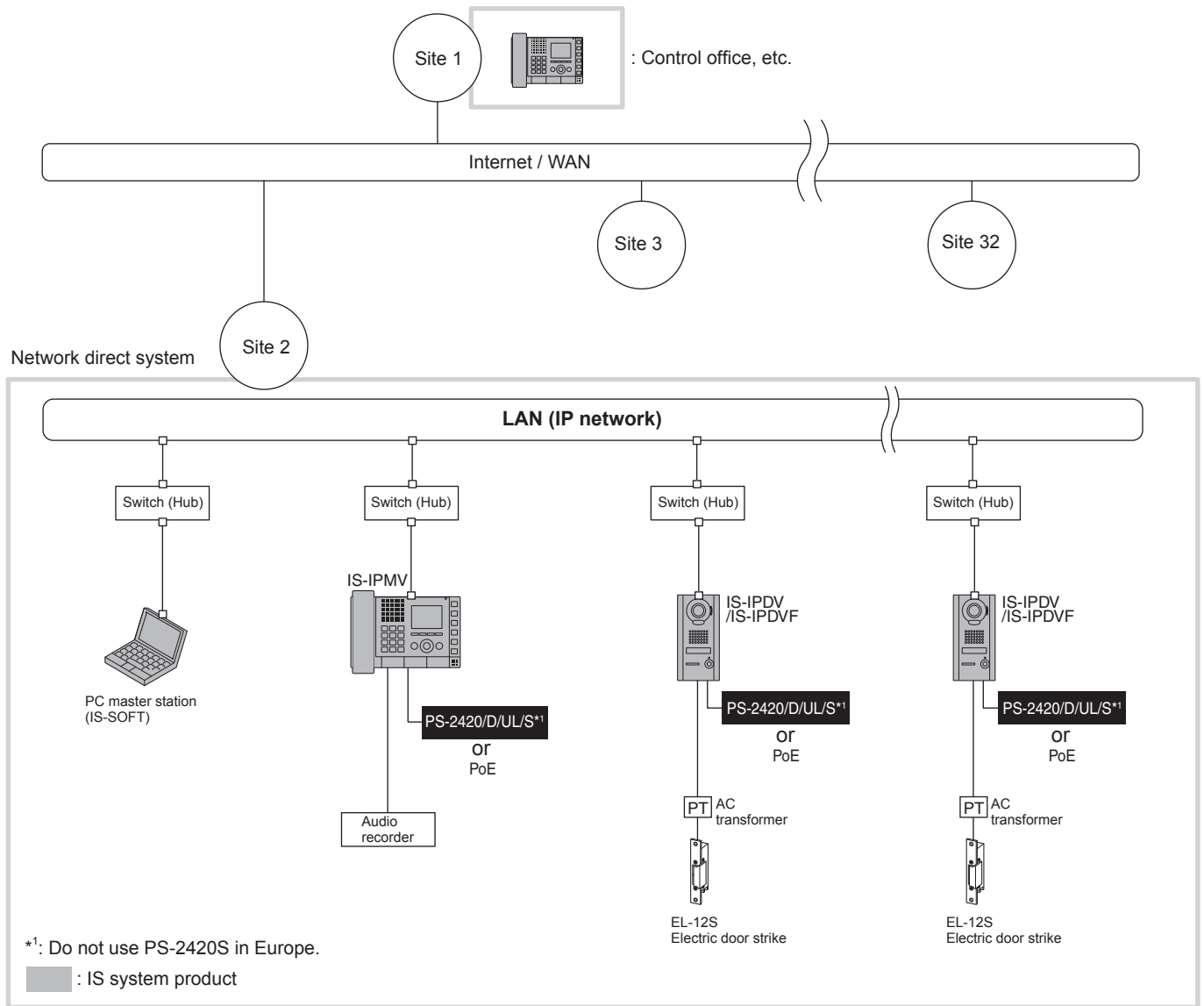

Maximum number of units connectable to a site of "network direct system"

Category		Model name	Type	Max. number
IP	Master station	IS-IPMV	Color monitor IP master station	32*2
		IS-SOFT (PC master station)	PC master station	
	Sub station	IS-IPDV	IP vandal-resistant video door station (surface-mount)	
		IS-IPDVF	IP vandal-resistant video door station (flush-mount)	

*2: Up to 31 PC master stations (IS-SOFT) can be connected within an IP network per site. If you do so, at least one color monitor IP master station (IS-IPMV) or IP vandal-resistant video door station (IS-IPDV or IS-IPDVF) must be also connected. (A site of network direct system cannot consist of PC master stations (IS-SOFT) only.)

Cables

Cables and connectors are not included with the products. Refer to page 7 to 11 for details about each unit connection.

Notes on cables

- Unless otherwise noted, never use individual conductors, twisted pair cable or coaxial cable.

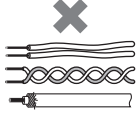

- Odd number cables, such as three conductor wire, cannot be used.



Notes on CAT5e/6 cables

- Do not bend the cables to an extent where the radius is less than 25 mm (1"). Communication failure could result.

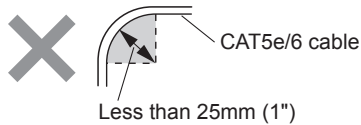
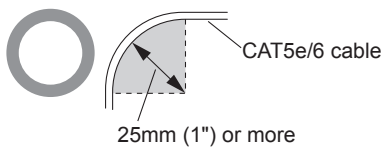

- Do not remove the CAT5e/6 cable jacket more than necessary.

- Arrange the color code of the RJ45 connections in accordance with EIA/TIA-568A or 568B.

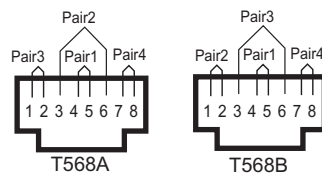

- **Be sure to check the condition of cable connections with a LAN checker before connecting with a LAN cable.**
- An RJ45 connector with a cover cannot be connected to the port for CAT5e/6 on IP master stations or IP door stations. Use a cable without a cover.

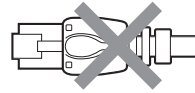

- Do not pull or put excess strain on CAT5e/6 cables.
- **Use a straight-through cable for connecting units. Use a crossover cable when connecting with a PC directly.**

How to connect or disconnect stranded wires.

- Twist the strands together, then insert the wire into one of the quick coupling terminals.
- To ensure that the wire won't bend, press the release button while inserting into terminal.

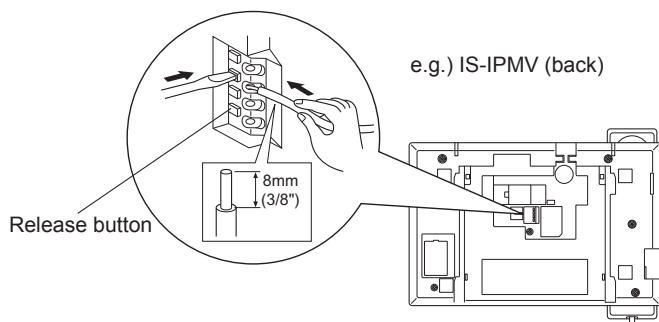

UNIT DETAILS

Color monitor IP master station (IS-IPMV)

* For the part names and their functions, see the OPERATION MANUAL.

■ Accessories

- Mounting bracket × 1
- Desktop stand × 1
- Tie-wrap × 1
- Name plate × 1
- Name card × 1
- Screw (15mm (5/8"), for wall-mounting) × 4
- Screw (25mm (1"), for gang box) × 4
- Screw (10mm (7/16"), for desktop stand) × 4
- Installation manual (a booklet in English) × 1
- CD-ROM (Installation manual, Setting manual and Operation manual) × 1
- China RoHS paper × 1

■ Mounting

When mounting on a wall

<Back wiring>

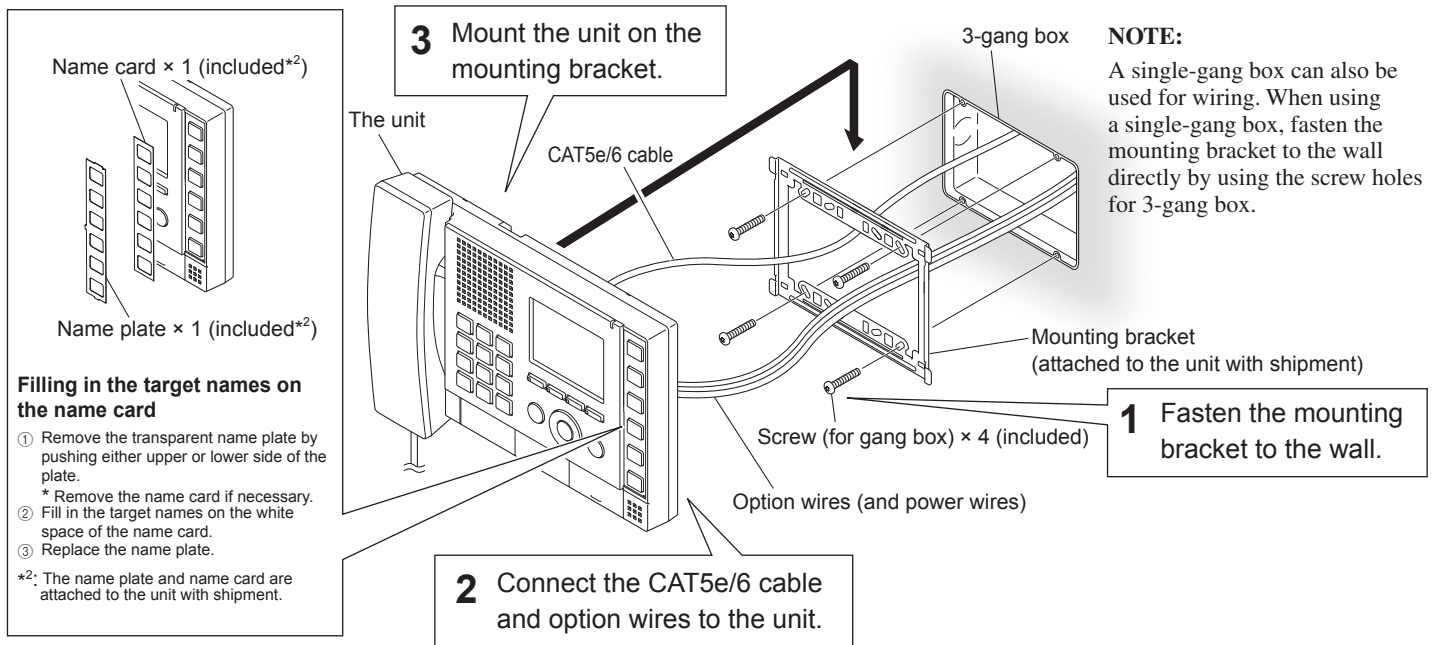

<Surface wiring>

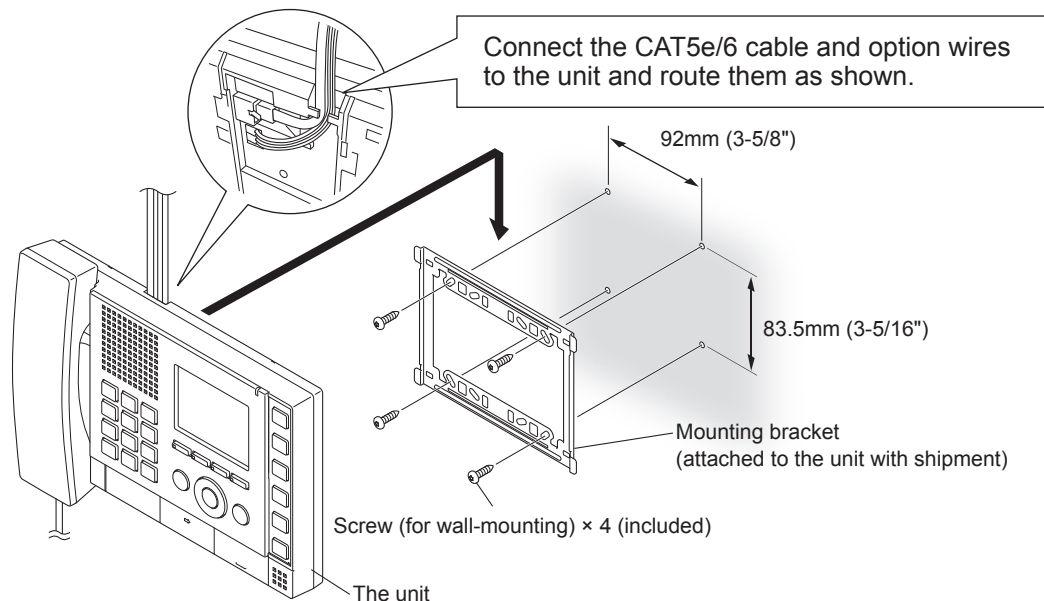

When mounting on a desktop stand

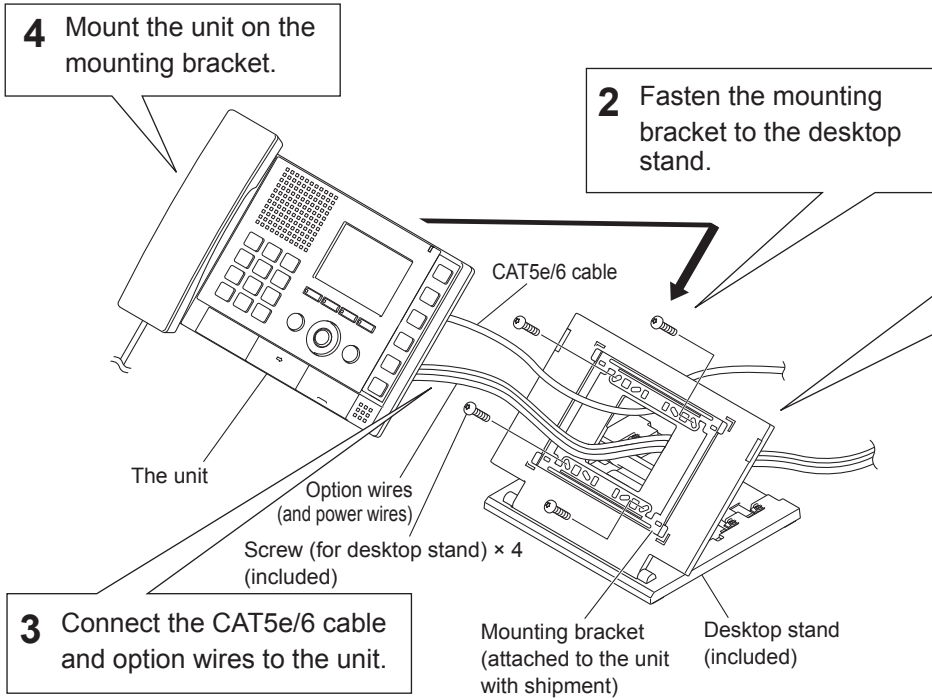

1 Set up the desktop stand.

- * Set up the desktop stand on a level surface etc. so that it is stabilized. Fix the desktop stand in place if needed.
- * The desktop stand allows you to adjust it in 3 setup angles. Put the leg in a groove on the base that corresponds to the desired angle.

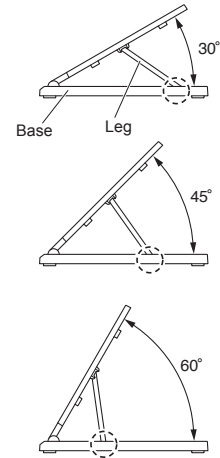

NOTES:

- Attach the screws to the screw holes for 3-gang box on the mounting bracket to make both sides of the mounting bracket contact the desktop stand.
- If necessary, secure the CAT5e/6 cable with the tie-wrap (included).

■ Connections

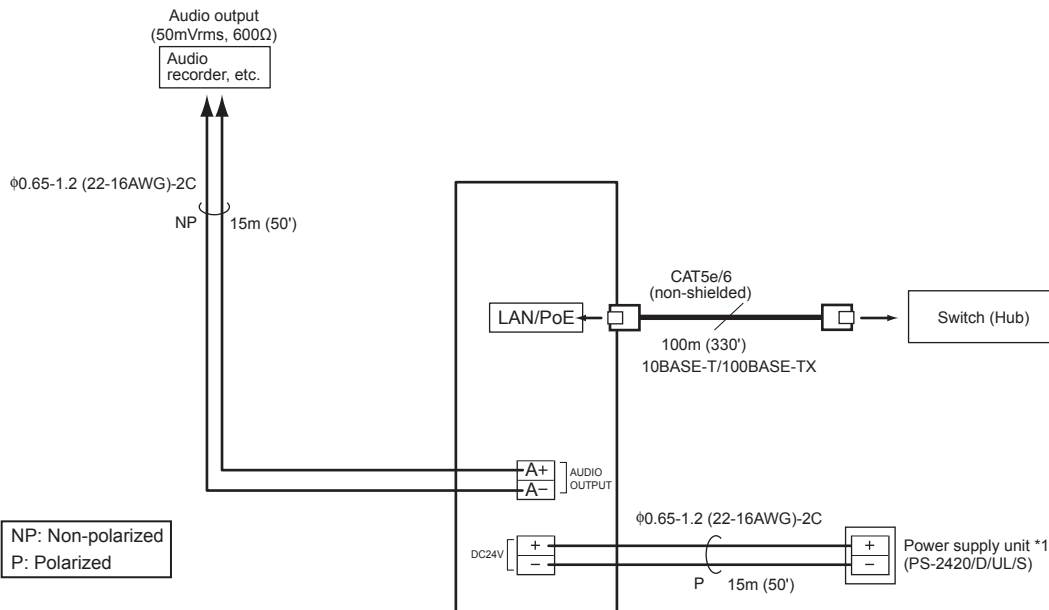

*1: A power supply unit is not needed when using a switch or injector that has a PoE (Power over Ethernet) function. The unit is supplied with power along with data signal via a LAN cable.

NOTES:

- Do not use the unoccupied terminals and ports for other purposes.
- In order to prevent miswiring, label both ends of each cable with the unit and terminal names to which they are to be connected.
- For connecting other manufacturer's products, refer to the instruction manuals for those products.
- The illustration of the unit's rear panel differs from the actual one. This is for simplifying the connection diagram.

IP vandal-resistant video door station (IS-IPDV, IS-IPDVF)

Accessories

- Screw (for wall-mounting) × 4 (IS-IPDV only)
- Anchor × 4 (IS-IPDV only)
- Transparent name plate × 2
- Special screw × 4 (IS-IPDVF only)
- Special screwdriver × 1
- Back box × 1 (IS-IPDVF only)
- China RoHS paper × 1

Mounting locations

Do not install this unit in any of the following locations where lighting or the ambient environment could impact the display on the video monitor due to the characteristics of the door station's camera.

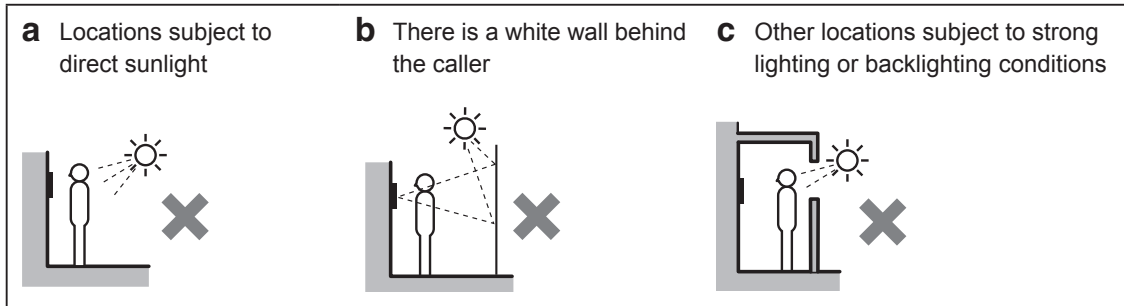

Mounting positions and image view area of IP video door station

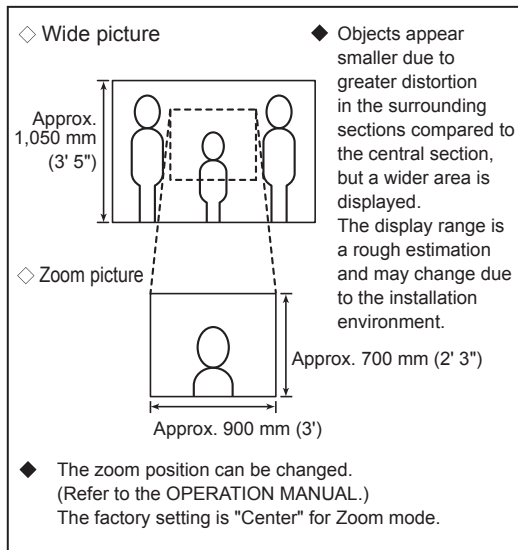

◇ Wide picture

Up/Down

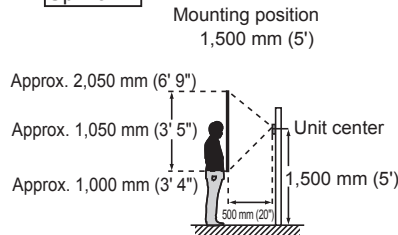

Mounting position 1,300 mm (4' 3")

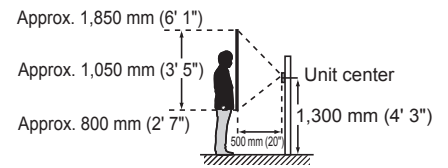

Left/Right

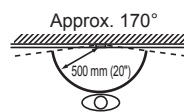

◆ An area over a range of approx. 170° in a 500 mm (20") radius from the camera displays. (The display range is a rough estimation and may change due to the installation environment.)

◇ Zoom picture (when mounting position is 1,500 mm (5'))

Up/Down

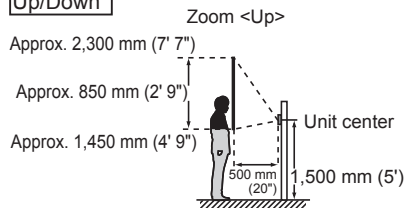

Zoom <Center>

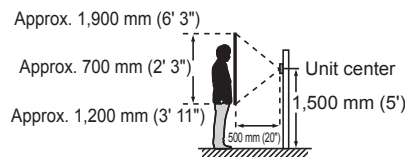

Zoom <Down>

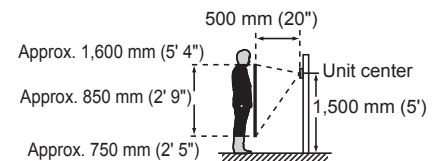

Left/Right

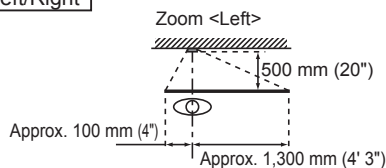

Zoom <Center>

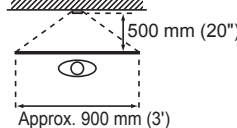

Zoom <Right>

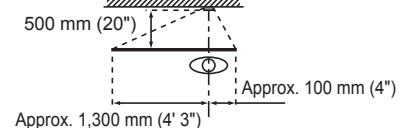

■ Mounting

IS-IPDV (surface-mount)

1 Loosen the screw with the special screwdriver, and remove the front panel.

2 Insert the transparent name plate. (IS-IPDV and IS-IPDVF)

- Peel off the protective seals on the plate (both sides).
- Fill in the name on the transparent name plate. **⚠** Be sure to leave 25 mm (1") of white space on the right end to account for insertion.
- Insert the filled-in transparent name plate at the specified insertion opening (indicated with ← in diagram).

3 Open the terminal cover, and connect the CAT5e/6 cable and option wires to the unit.

4 Fasten the unit to the mounting surface.

* Use board anchors or concrete plugs as needed.

5 Attach the front panel to the unit by hanging the upper 2 parts on the unit.

* Tighten the screw with the lower part of the front panel pressed to the wall.

NOTE
Make room for threading a screw.

Screw mounting hole x 4

Unit center

Ø 6 mm (Ø 1/4") 35 mm (1-3/8")

Unit center

Mounting height GL=1,500 mm (5')

90 mm (3-9/16")

25 mm (1")

81 mm (3-1/4")

194 mm (7-11/16")

25 mm (1")

Anchor x 4 (included)

Option wires (and power wires)

CAT5e/6 cable

The unit

Screw (for wall-mounting) x 4 (included)

Water escape holes
Do not block the holes.

Vandal-resistant front panel

Loosen

Special screwdriver (included)

Tighten

To insertion opening ←

25 mm (1")

To insertion opening ←

2 mm (1/8")

ABCDEFG

IS-IPDVF (flush-mount)

1 Install the back box in the wall, and then connect the CAT5e/6 cable and option wires to the unit with the terminal cover open.

2 Insert the transparent name plate.

* See above for details.

3 Fasten the front panel to the back box with the special screws.

Flush mount back box (included)

120 mm (4-3/4")

Vandal-resistant front panel with the unit attached

235 mm (9-5/16")

Loosen

Special screwdriver (included)

Tighten

Special screw x 4 (included)

45 mm (1-13/16")

Transparent name plate

Mounting height (box center) GL=1,500 mm (5')

■ Connections (IS-IPDV and IS-IPDVF)

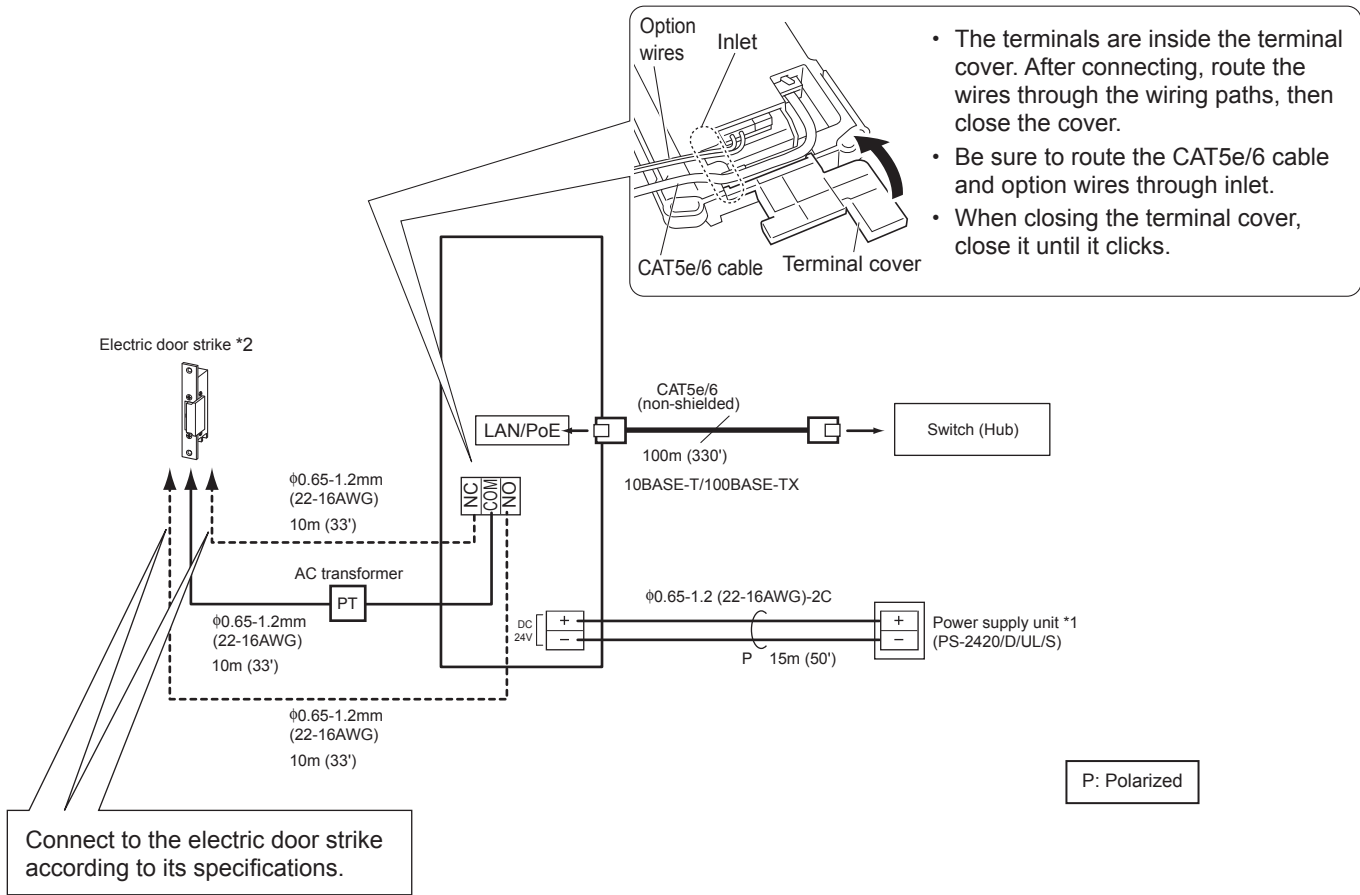

*1: A power supply unit is not needed when using a switch or injector that has a PoE (Power over Ethernet) function. The unit is supplied with power along with data signal via a LAN cable.

*2: Output specifications

Output method	N/O or N/C dry closure contact
Voltage between terminals	24V AC, 0.5A (resistive load) 24V DC, 0.5A (resistive load) Minimum overload (AC/DC): 100mV, 0.1mA

NOTES:

- Do not use the unoccupied terminals and ports for other purposes.
- In order to prevent miswiring, label both ends of each cable with the unit and terminal names to which they are to be connected.
- For connecting other manufacturer's products, refer to the instruction manuals for those products.
- The illustration of the unit's rear panel differs from the actual one. This is for simplifying the connection diagram.

TECHNICAL DATA AND PRECAUTIONS

Technical data

- Operating temperature:

Color monitor IP master station (IS-IPMV)	0 - 40°C (+32°F - +104°F)
IP vandal-resistant video door station (IS-IPDV, IS-IPDVF)	-10 - 60°C (+14°F - +140°F)

- Dimensions:

Color monitor IP master station (IS-IPMV)		250 (W) x 189 (H) x 59 (D) mm 9-7/8" (W) x 7-1/2" (H) x 2-3/8" (D)
IP vandal-resistant video door station (IS-IPDV)		105 (W) x 215 (H) x 32 (D) mm 4-3/16" (W) x 8-1/2" (H) x 1-5/16" (D)
IP vandal-resistant video door station (IS-IPDVF)	IS-IPDVF	150 (W) x 265 (H) x 38 (D) mm 5-15/16" (W) x 10-7/16" (H) x 1-1/2" (D)
	Flush mount back box	120 (W) x 235 (H) x 45 (D) mm 4-3/4" (W) x 9-5/16" (H) x 1-13/16" (D)

- Weight:

Color monitor IP master station (IS-IPMV)		Approx. 820 g (1.81 lbs.)
IP vandal-resistant video door station (IS-IPDV)		Approx. 540 g (1.19 lbs.)
IP vandal-resistant video door station (IS-IPDVF)	IS-IPDVF	Approx. 860 g (1.90 lbs.)
	Flush mount back box	Approx. 600 g (1.32 lbs.)

Technical precautions

- Cleaning: Clean the units with a soft cloth dampened with a neutral household cleanser. Do not use an abrasive cleanser or cloth.

WARRANTY

Aiphone warrants its products to be free from defects of material and workmanship under normal use and service for a period of two years after delivery to the ultimate user and will repair free of charge or replace at no charge, should it become defective upon which examination shall disclose to be defective and under warranty. Aiphone reserves unto itself the sole right to make the final decision whether there is a defect in materials and/or workmanship; and whether or not the product is within the warranty. This warranty shall not apply to any Aiphone product which has been subject to misuse, neglect, accident, power surge, or to use in violation of instructions furnished, nor extended to units which have been repaired or altered outside of the factory. This warranty does not cover batteries or damage caused by batteries used in connection with the unit. This warranty covers bench repairs only, and any repairs must be made at the shop or place designated in writing by Aiphone. Aiphone will not be responsible for any costs incurred involving on site service calls. Aiphone will not provide compensation for any loss or damage incurred by the breakdown or malfunction of its products during use, or for any consequent inconvenience or losses that may result.

The object area of  is the EU.

FCC

This device complies with Part 15 of the FCC Rules. Operation is subject to the following two conditions: (1) this device may not cause harmful interference, and (2) this device must accept any interference received, including interference that may cause undesired operation.

This equipment has been tested and found to comply with the limits for a Class B digital device, pursuant to Part 15 of the FCC Rules. These limits are designed to provide reasonable protection against harmful interference in a residential installation. This equipment generates, uses, and can radiate radio frequency energy, and if not installed and used in accordance with the instructions, may cause harmful interference to radio communications. However, there is no guarantee that interference will not occur in a particular installation. If this equipment does cause harmful interference to radio or television reception, which can be determined by turning the equipment off and on, the user is encouraged to try to correct the interference by one or more of the following measures:

- Reorient or relocate the receiving antenna
- Connect the equipment to an outlet on a circuit different from that to which the receiver is connected. Increase the separation between the equipment and receiver.
- Consult the dealer or an experienced radio/TV technician for help.



Providing Peace of Mind

<http://www.aiphone.net/>

AIPHONE CO., LTD., NAGOYA, JAPAN
AIPHONE CORPORATION, BELLEVUE, WA, USA
AIPHONE S.A.S., LISSES-EVRY, FRANCE

Printed in Thailand

Free Manuals Download Website

<http://myh66.com>

<http://usermanuals.us>

<http://www.somanuals.com>

<http://www.4manuals.cc>

<http://www.manual-lib.com>

<http://www.404manual.com>

<http://www.luxmanual.com>

<http://aubethermostatmanual.com>

Golf course search by state

<http://golfingnear.com>

Email search by domain

<http://emailbydomain.com>

Auto manuals search

<http://auto.somanuals.com>

TV manuals search

<http://tv.somanuals.com>