

PCI-6872

**PCI Socket370 SlotPC, with
VGA/LCD/LVDS/LAN/CFC
and second LAN**

User's Manual

Copyright

This document is copyrighted, © 2004. All rights are reserved. The original manufacturer reserves the right to make improvements to the products described in this manual at any time without notice.

No part of this manual may be reproduced, copied, translated or transmitted in any form or by any means without the prior written permission of the original manufacturer. Information provided in this manual is intended to be accurate and reliable. However, the original manufacturer assumes no responsibility for its use, nor for any infringements upon the rights of third parties that may result from such use.

Acknowledgements

Award is a trademark of Award Software International, Inc.

VIA is a trademark of VIA Technologies, Inc.

IBM, PC/AT, PS/2 and VGA are trademarks of International Business Machines Corporation.

Intel and Pentium are trademarks of Intel Corporation.

Microsoft Windows® is a registered trademark of Microsoft Corp.

RTL is a trademark of Realtek Semiconductor Co., Ltd.

ESS is a trademark of ESS Technology, Inc.

UMC is a trademark of United Microelectronics Corporation.

SMI is a trademark of Silicon Motion, Inc.

Creative is a trademark of Creative Technology, LTD.

All other product names or trademarks are properties of their respective owners.

For more information on this and other Advantech products, please visit our websites at: **<http://www.advantech.com>**

<http://www.advantech.com/epc>

For technical support and service, please visit our support website at:

<http://support.advantech.com>

This manual is for the PCI-6872.

Part No. 2006687200

1st Edition, May, 2004

Packing List

Before you begin installing your card, please make sure that the following materials have been shipped:

- 1 PCI-6872 all-in-one single board computer
- 1 startup manual
- CD-ROM or disks for utility, drivers, and manual(in PDF format)
- 1 power cable p/n: 1703080101
- 1 PS/2 KB/M cable p/n: 1700060202
- 1 COM port cable p/n:1700100250
- 1 Printer cable p/n:1700260250
- 1 FDD cable p/n:1701260125
- 1 EIDE cable p/n:1701400452

If any of these items are missing or damaged, contact your distributor or sales representative immediately.

Optional item

- 9681000044 PURCH 26-34 Pin FDD CABLE Converter(+5V)
- 1703100260 USB cable adapter (2.00 mm)
- 1703200100 ATX power cable
- CF-HDD-ADP CompactFlash 50-pin to IDE 44-pinadapter
- 1759209100 Fan/Heatsink modile
- 1759209100 Fan/Heatsink module

Model No. List

Description

PCI-6872F-00A1	PCI Socket 370 half-sized CPU Card with VGA/LCD/LVD/LVDS/LAN/CFC
PCI-6872F-02A1	PCI Socket 370 half-sized CPU Card with VGA/LCD/LVD/LVDS/2LAN/CFC

Additional Information and Assistance

1. Visit the Advantech web site at www.advantech.com where you can find the latest information about the product

2. contact your distributor, sales representative, or Advantech's customer service center for technical support if you need additional assistance

Please have the following information ready before you call:

- Product name and serial number
- Description of your peripheral attachments
- Description of your software (operating system, version, application software, etc.)
- A complete description of the problem
- The exact wording of any error messages

FCC

This device complies with the requirements in part 15 of the FCC rules: Operation is subject to the following two conditions:

- 1. This device may not cause harmful interference, and*
- 2. This device must accept any interference received, including interference that may cause undesired operation*

This equipment has been tested and found to comply with the limits for a Class A digital device, pursuant to Part 15 of the FCC Rules. These limits are designed to provide reasonable protection against harmful interference when the equipment is operated in a commercial environment. This equipment generates, uses, and can radiate radio frequency energy and, if not installed and used in accordance with the instruction manual, may cause harmful interference to radio communications. Operation of this device in a residential area is likely to cause harmful interference in which case the user will be required to correct the interference at his/her own expense. The user is advised that any equipment changes or modifications not expressly approved by the party responsible for compliance would void the compliance to FCC regulations and therefore, the user's authority to operate the equipment.

Caution!



Achtung!

There is a danger of a new battery exploding if it is incorrectly installed. Do not attempt to recharge, force open, or heat the battery. Replace the battery only with the same or equivalent type recommended by the manufacturer. Discard used batteries according to the manufacturer's instruction.

Contents

Chapter 1	General Information	1
1.1	Introduction	2
1.2	Features	3
1.3	Specifications	3
1.3.1	Standard SBC Functions	3
1.3.2	VGA/LCD Interface	4
1.3.3	Solid State disk	4
1.3.4	PCI bus Ethernet interface	4
1.3.5	Mechanical and Environmental	4
1.4	Board layout: dimensions	5
	Figure 1.1:Board layout: dimension(component side)....	5
	Figure 1.2:Board layout: dimension (solder side).....	6
Chapter 2	Installation	7
2.1	Jumpers.....	8
	Table 2.1:Jumpers	8
2.2	Connectors.....	8
	Table 2.2:Connectors	9
2.3	Locating Connectors&Jumpers(component side)	10
	Figure 2.1:Jumper & Connector location.....	10
2.4	Locating Connectors(solder side).....	11
	Figure 2.2:Connectors (solder side).....	11
2.5	Setting Jumpers	12
2.6	Clear CMOS (J1).....	13
	Table 2.3: CMOS clear (J1)	13
2.7	COM2 RS232-422-485 Select (J3)	14
	Table 2.4: COM2 RS232-422-485 Select	14
2.8	Watchdog timer configuration	14
2.8.1	Watchdog timer output option (J2).....	14
	Table 2.5: Watchdog timer output option (J2)	14
2.9	Installing DIMMs.....	15
2.10	ATX power control connector (CN20,CN21).....	15
2.10.1	ATX feature connector (CN20) and soft power switch connector (CN21).....	15
	Figure 2.3:Wiring for ATX soft power switch function	16
2.11	Printer port connector (CN4).....	16
2.12	CompactFlash Card connector	16
2.12.1	CompactFlash (CN5).....	16
2.13	Floppy drive connector (CN3)	17
2.13.1	Connecting the floppy drive	17
2.14	IDE connector(CN1,CN2).....	17
2.14.1	Connecting the hard drive.....	17

2.15	VGA/LCD interface connections	18
2.15.1	CRT display connector (CN7).....	18
2.15.2	Flat panel display connector (CN22).....	18
2.15.3	Extension flat panel connector(CN23)	18
2.15.4	LVDS LCD panel connector (CN25)	18
2.15.5	Panel type selection(SW1).....	19
	Table 2.6: S1 Panel Type Select (SW1)	19
2.16	USB connectors (CN6).....	19
2.17	Ethernet configuration.....	20
2.17.1	100Base-T connector (CN8).....	20
2.17.2	Network boot	20
2.18	Power connectors (CN14, CN15).....	20
2.18.1	Main power connector, +5 V, +12 V (CN15).....	20
2.18.2	CPU Fan power supply connector (CN14).....	20
2.19	ATX Power & HDD LED, speaker out Connector (CN16, CN17, CN19).....	20
2.19.1	HDD LED (CN19).....	21
2.19.2	ATX power LED&KB-LOCK (CN16)	21
2.19.3	Speaker out(CN17)	21
2.20	COM port connector(CN9,CN10, CN29)	21
2.21	Keyboard and PS/2 mouse connector (CN11)	21
2.22	External KB/mouse connector (CN12)	21
2.23	Watchdog output (CN18).....	21
2.24	Daughter card connector (CN27,CN28).....	22
Chapter 3	Software Configuration	23
3.1	Introduction	24
3.2	VGA display firmware configuration	24
Chapter 4	Award BIOS Setup.....	27
4.1	System test and initialization.....	28
4.1.1	System configuration verification.....	28
4.2	Award BIOS setup	29
4.2.1	Entering setup	29
4.2.2	Standard CMOS Features setup.....	30
4.2.3	Advanced BIOS Features setup	31
4.2.4	Advanced Chipset Features setup.....	32
4.2.5	Integrated Peripherals	33
4.2.6	Power Management Setup	33
4.2.7	PnP/PCI Configurations.....	34
4.2.8	PC Health Status	34
4.2.9	Frequency/Voltage Control.....	35
4.2.10	Load Optimized Defaults.....	36
4.2.11	Set Password	36
	Figure 4.11:Establish Password.....	37

	4.2.12	Save & Exit Setup.....	38
	4.2.13	Exit Without Saving.....	38
Chapter	5	PCI SVGA Setup	39
	5.1	Introduction	40
	5.1.1	Chipset	40
	5.1.2	Display memory.....	40
	5.1.3	Display types.....	40
	5.2	Installation of the SVGA Driver	41
	5.2.1	Installation for Windows 95	41
	5.2.2	Installation for Windows 98/Me.....	45
	5.2.3	Installation for Windows NT.....	50
	5.2.4	Installation for Windows 2000	56
	5.2.5	Installation for Windows XP	61
	5.3	Further Information	67
Chapter	6	PCI Bus Ethernet Interface.....	69
	6.1	Introduction	70
	6.2	Installation of Ethernet driver	70
	6.2.1	Installation for MS-DOS and Windows 3.1.....	70
	6.2.2	Installation for Windows 98	71
	6.2.3	Installation for Windows 2000	74
	6.2.4	Installation for Windows NT	79
	6.3	Further information	85
Appendix A		Programming the Watchdog Timer	87
	A.1	Supported Input Timing Modes	88
Appendix B		Pin Assignments	91
	B.1	ATX power feature connector(CN20).....	92
		Table B.1:ATX power feature connector (CN20).....	92
	B.2	Parallel Port Connector(CN4)	93
	B.3	Floppy Disk Drive Disk connector (CN3)	93
		Table B.3:Floppy Disk Drive Connector (CN3)	93
	B.4	IDE Hard Drive Connector (CN1,CN2).....	94
		Table B.4:IDE HDD connector (CN1,CN2)	94
	B.5	CompactFlash card connector (CN5).....	95
		Table B.5:CompactFlash Card Connector(CN5)	95
	B.6	CRT Display Connector (CN7).....	96
		Table B.6:CRT Display Connector (CN7)	96
	B.7	USB Connector (CN6)	97
		Table B.7:USB Connector (CN6)	97
	B.8	LAN, RJ45 Connector (CN8).....	97
		Table B.8:LAN, RJ45 Connector (CN8)	97
	B.9	Main Power Connector (CN15)	98
		Table B.9:Main Power Connector(CN15)	98

B.10	ATX power LED and KB-Lock connector (CN16)	99
	Table B.10:ATX Power LED and KB-Lock Connector(CN16)	99
B.11	Speaker Out (CN17).....	99
	Table B.11:Speaker Out(CN17)	99
B.12	Watchdog output connector (CN18)	100
	Table B.12:Watchdog Output Connector(CN18)	100
B.13	HDD LED (CN19)	100
	Table B.13:HDD LED(CN19)	100
B.14	PowerButton (CN21).....	101
	Table B.14:Power Button(CN21)	101
B.15	Flat Panel Connector (CN22).....	102
	Table B.15:Flat Panel Connector(CN22)	102
B.16	Extension flat panel connector (CN23).....	103
	Table B.16:Extension Flat Panel Connector(CN23) ..	103
B.17	LVDS LCD connector (CN25)	104
	Table B.17:LVDS LCD Connector(CN25)	104
B.18	COM Connector (CN9, CN10, CN29)	104
	Table B.18:COM connector (CN9, CN10, CN29)	104
B.19	COM2 Extension connector RS422-RS485(CN29).....	105
	Table B.19:COM2 Extension Connector RS422-RS485(CN29)	105
B.20	LCD Inverter Backlight Connector (CN24).....	105
	Table B.20:LCD Inverter Backlight Connector(CN24)	105
B.21	Keyboard and PS/2Mouse Connector (CN11)	106
	Table B.21:Keyboard and mouse connector (CN11)	106
B.22	CPU Fan Power connector(CN14).....	106
	Table B.22:FAN connector (CN14)	106
B.23	External KB/Mouse connector (CN12).....	107
	Table B.23:External KB/Mouse Connector(CN12)	107
B.24	I/O daughter board connector1(CN27)	107
	Table B.24:I/O Daughter Board Connector1(CN27)	107
B.25	I/O daughter board connector1 (CN28)	108
	Table B.25:I/O Daughter Board Connector1(CN28)	108

Appendix D System Assignments 109

D.1	System I/O Ports.....	110
	Table D.1:System I/O ports	110
D.2	1st MB memory map.....	111
	Table D.2:1st MB memory map	111
D.3	DMA channel assignments.....	111
	Table D.3:DMA channel assignments	111
D.4	Interrupt assignments	112

Table D.4:Interrupt assignments	112
---------------------------------------	-----

General Information

This chapter gives background information on the PCI-6872.

Sections include:

- Introduction
- Features
- Specifications
- Board layout and dimensions

Chapter 1 General Information

1.1 Introduction

Advantech's new PCI-6872 is a new Socket 370 half-sized CPU card that will support up to 1.26GHz Pentium III with 512KB using VIA VT8606"TwisterT" chipset. This SBC includes a 4X AGP controller, a PCI Ethernet interface, and 36-bit TTL interface. Its design is based on the half-sized CPU card and supports PCI bus expansion. Other on-board features include an FDD, LPT, 2 USBs (4 USBs optional), and 2 serial ports. The SSD solution supports CompactFlash cards . This product uses a VIA TwisterT chip with Integrated Savage4 2D/3D/Video Accelerator and supports 4X AGP VGA/LCD interface and up to 8/16/32 MB frame buffer using system memory. With the selection of daughter boards, the PCI-6872 board can support a second LAN at 10/100Mbps

1.2 Features

- Supports Socket 370 for VIA C3 and Intel processors up to Pentium III 1.26GHz with 512K (Tualatin).
- PCI bus half-sized CPU card
- Supports selectable LAN(1 x 10/100BASE-T LAN or 2 x 10/100BASE-T LAN)
- 4X AGP graphics for high performance applications
- Supports boot from USB device.
- Supports wake-on-LAN.
- Supports Ring-up by Modem .
- Supports LVDS interface.
- Supports LCD backlight turn-off function.

1.3 Specifications

1.3.1 Standard SBC Functions

- **CPU:** Supports Socket 370 for VIA C3 and Intel processors up to PentiumIII 1.26 GHz with 512K cache (Tualatin)
- **System chipsets:** VIA VT8606"TwisterT"+VT82C686B
- **BIOS:** Award 2Mb Flash memory BIOS
- **System memory:** One DIMM socket accepts 64 MB up to 512 MB SDRAM
- **2nd cache memory:** 128/256/512KB on Celeron/PentiumIII processor, or 64 KB on the VIA C3 processor
- **Enhanced IDE interface:** One channel supports up to two EIDE devices. Supports ATA-100, ATA-33 and PIO modes.Compact Flash Card occupys secondary master.
- **FDD interface:** Supports one FDD.

- **Serial ports:** Two serial RS-232 ports:
COM1:RS-232
COM2:RS-232/422/485
RS-485 supports AUTO-flow
- **Parallel port:** Parallel port supports SPP/EPP/ECP mode

- **Keyboard/mouse connector:** Supports standard PC/AT keyboard and a PS/2 mouse
- **Power management:** Supports power saving modes including Normal/Standby/Suspend modes. APM 1.2 compliant
- **Watchdog timer:** 62 level timer intervals
- **USB:** Two universal serial bus ports, Optional 4 ports.

1.3.2 VGA/LCD Interface

- **Chipset:** VIA VT8606"TwisterT" chip with integrated Savage4 2D/3D/Video Accelerator
- **Frame buffer:** Supports 8/16/32MB frame buffer with system memory
- **Interface:** 4X AGP VGA/LCD interface, Support for up to 36 bit TFT
- **Display modes:**
 - CRT Modes: 1280 x 1024@16bpp (60Hz),
1024 x 768@16bpp (85Hz),
 - LCD/Simultaneous Modes:
1280 x 1024@16bpp (60Hz),
1024 x 768@16bpp (60Hz);
 - LVDS interface:
Supports LVDS interface.

1.3.3 Solid State disk

- Supports One 50-pin socket for CFC Type I/II

1.3.4 PCI bus Ethernet interface

- Chipset: Intel 82551ER
- Ethernet interface: IEEE 802.3u compatible 10/100Base-T interface.
Supports selectable LAN 1 x 10/100base-T LAN or 2 x 10/100base-T LAN(Optional)
- I/O address switchless setting

1.3.5 Mechanical and Environmental

- **Dimensions (L x W):** 185 x 122 mm(7.28" x 4.80")
- **Power supply voltage:** +5 V, +12V \pm 5%
- **Power requirements:**
 - **Max:**
5.68 A @ +5 V, 0.15 A @+12 V
 - **Typical:**
5.5 A @ +5 V, (with PC133 256MB SDRAM,1.26 GHz)
0.11 A @ +12 V, (with PC133 256MB SDRAM,1.26 GHz)
- **Operating temperature:** 0 ~ 60°C (32 ~ 140°F)
- **Operating humidity:** 0% ~ 90% Relative Humidity, Non condensing
- **Weight:** 0.27 kg (weight of total package)

1.4 Board layout: dimensions

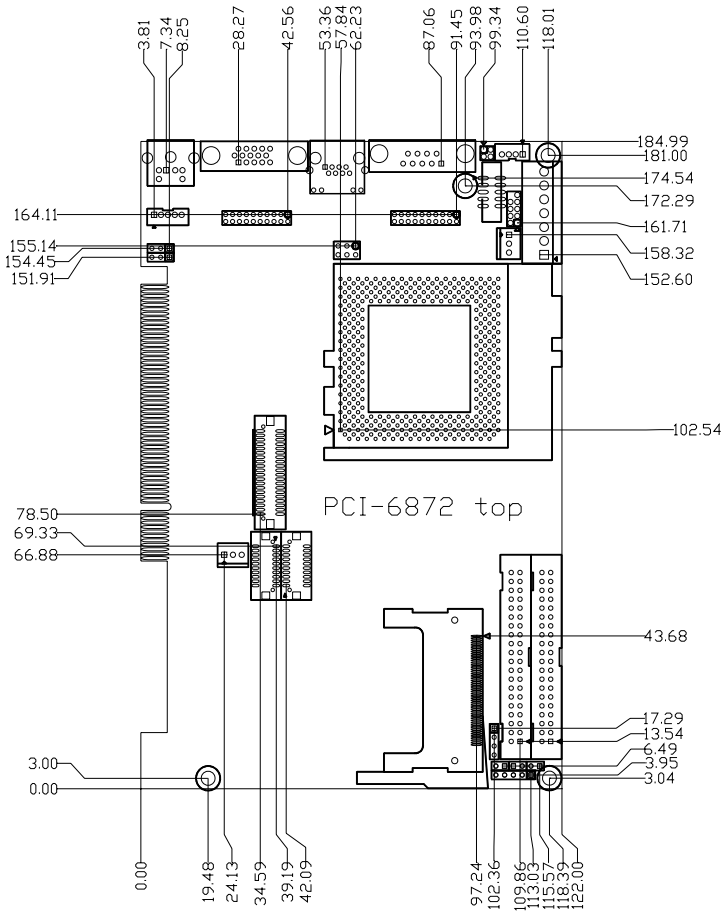

Figure 1.1: Board layout: dimension(component side)

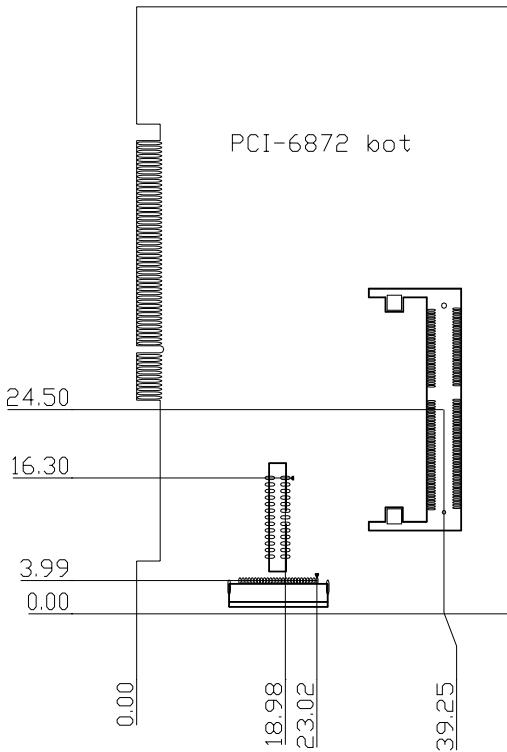

Figure 1.2: Board layout: dimension (solder side)

CHAPTER 2

Installation

This chapter explains the setup procedures of PCI-6872 hardware, including instructions on setting jumpers and connecting peripherals, switches and indicators. Be sure to read all safety precautions before you begin the installation procedure.

Chapter 2 Installation

2.1 Jumpers

The PCI-6872 has a number of jumpers that allow you to configure your system to suit your application. The table below lists the function of the various jumpers.

Table 2.1: Jumpers

Label	Function
J1	CMOS clear
J2	Watchdog timer output selection
J3	COM2 RS232-422-485 select

2.2 Connectors

On-board connectors link the PCI-6872 to external devices such as hard disk drives, a keyboard, or floppy drives. The table below lists the function of each of the board's connectors

Table 2.2: Connectors

Label	Function
CN1	Primary IDE connector
CN2	Secondary IDE connector
CN3	FDD connector
CN4	Parallel port connector
CN5	CompactFlash Card connector
CN6	USB1, USB2 connector
CN7	VGA connector
CN8	10/100MHz LAN connector
CN9	COM1 connector
CN10	COM2 connector
CN11	PS/2 Keyboard&Mouse connector
CN12	External Keyboard
CN14	CPU FAN
CN15	Main Power connector(EBX)
CN16	Power LED&Keyboard Lock
CN17	External speaker
CN18	Reset connector
CN19	HDD LED connector
CN20	ATX Power feature connector
CN21	ATX Soft-ON Power Button connector
CN22	LCD 40 PIN connector
CN23	LCD 20 PIN connector2
CN24	LCD BackLight connector
CN25	LVDS connector
CN27	I/O Daughter Card connector1
CN28	I/O Daughter Card connector2
CN29	RS485/422 Connector

2.3 Locating Connectors&Jumpers(component side)

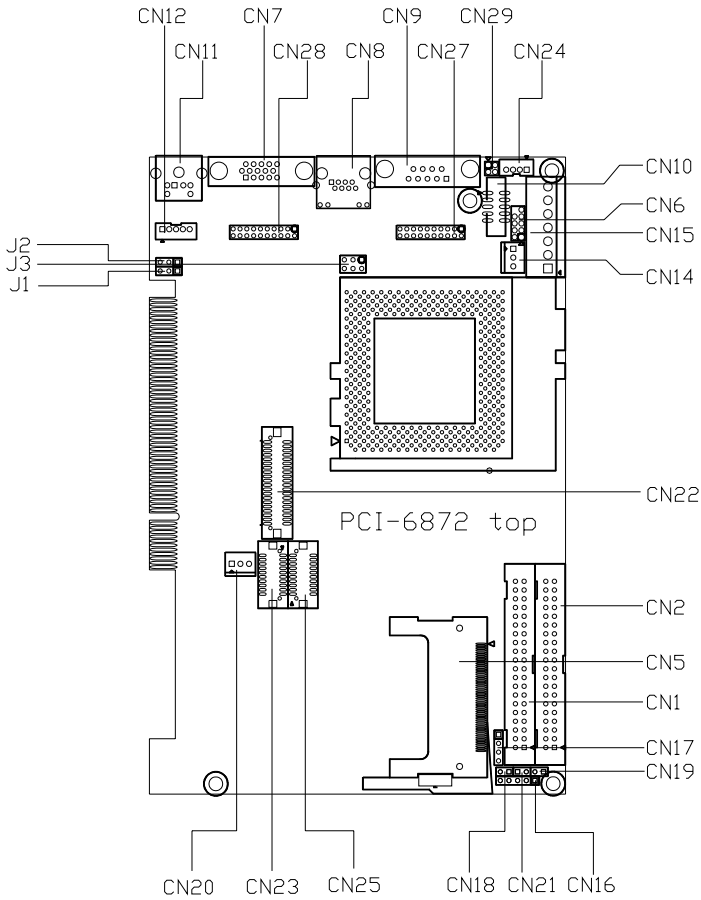

Figure 2.1: Jumper & Connector location

2.4 Locating Connectors(solder side)

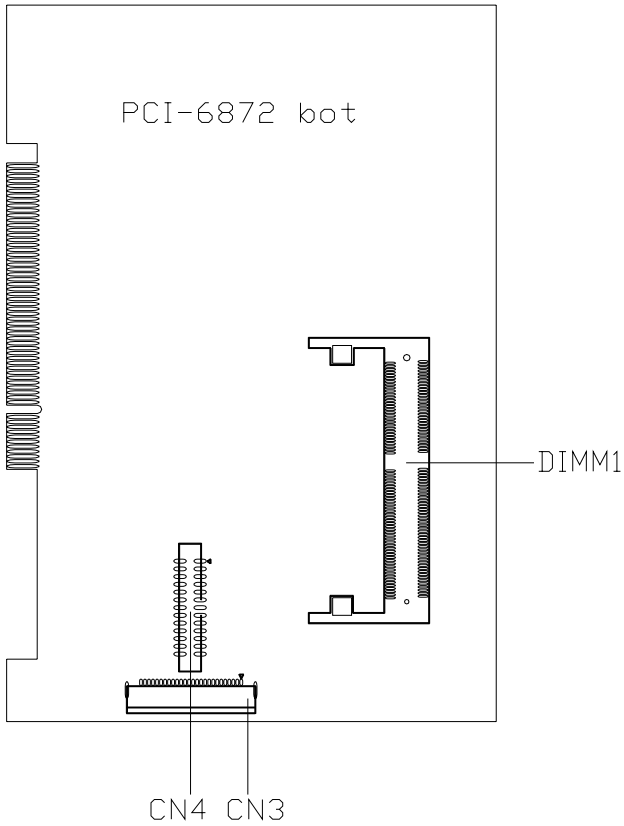
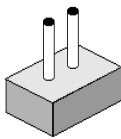

Figure 2.2: Connectors (solder side)

2.5 Setting Jumpers

You may configure your card to match the needs of your application by setting jumpers. A jumper is a metal bridge used to close an electric circuit. It consists of two metal pins and a small metal clip (often protected by a plastic cover) that slides over the pins to connect them. To “close” a jumper, you connect the pins with the clip. To “open” a jumper, you remove the clip. Sometimes a jumper will have three pins, labeled 1, 2 and 3. In this case you would connect either pins 1 and 2, or 2 and 3.



open

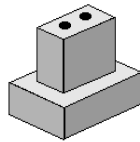

closed

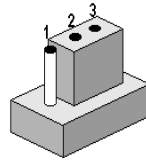

closed 2-3

The jumper settings are schematically depicted in this manual as follows:

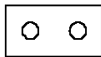

open



closed

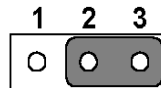

closed 2-3

A pair of needle-nose pliers may be helpful when working with jumpers.

If you have any doubts about the best hardware configuration for your application, contact your local distributor or sales representative before you make any changes.

Generally, you simply need a standard cable to make most connections.

2.6 Clear CMOS (J1)

Warning! To avoid damaging the computer, always turn off the power supply before setting “Clear CMOS.” Before turning on the power supply, set the jumper back to “3.0 V Battery On.”

This jumper is used to erase CMOS data and reset system BIOS information.

The procedure for clearing CMOS is:

1. Turn off the system.
2. Short pin 2 and pin 3.
3. Return jumper to pins 1 and 2.
4. Turn on the system. The BIOS is now reset to its default setting

Table 2.3: CMOS clear (J1)



* default setting

2.7 COM2 RS232-422-485 Select (J3)

Table 2.4: COM2 RS232-422-485 Select

PIN	RS232*	RS422	RS484
1-2	Closed	Open	Open
3-4	Open	Closed	Open
5-6	Open	Open	Closed

2.8 Watchdog timer configuration

An on-board watchdog timer reduces the chance of disruptions which EMP (electro-magnetic pulse) interference can cause. This is an invaluable protective device for standalone or unmanned applications. Setup involves one jumper and running the control software (refer to Appendix A).

2.8.1 Watchdog timer output option (J2)

When the watchdog timer activates (CPU processing has come to a halt), it can reset the system or generate an interrupt on IRQ11. This can be set via setting J2 as shown below:

Table 2.5: Watchdog timer output option (J2)



* default setting

2.9 Installing DIMMs

The procedure for installing DIMMs is described below. Please follow these steps carefully. The number of pins are different on either side of the breaks, so the module can only fit in one way. DIMM modules have different pin contacts on each side, and therefore have a higher pin density.

1. Make sure that the two handles of the DIMM socket are in the “open” position. i.e. The handles remain leaning outward.
2. Slowly slide the DIMM module along the plastic guides on both ends of the socket.
3. Press the DIMM module right down into the socket, until you hear a click. This is when the two handles have automatically locked the memory module into the correct position of the socket.

To **remove** the memory module, just push both handles outward, and the module will be ejected from the socket.

2.10 ATX power control connector (CN20,CN21)

2.10.1 ATX feature connector (CN20) and soft power switch connector (CN21)

The PCI-6872 can support an advanced soft power switch function, if an ATX power supply is used. To enable the soft power switch function:

1. Get the specially designed ATX-to-EBX power cable (PCI-6872 optional item, part no. 1703200100)
2. Connect the 3-pin plug of the cable to CN20 (ATX feature connector).
3. Connect the power on/off button to CN21. (A momentary type of button should be used.)

Important *Make sure that the ATX power supply can take at least a 10 mA load on the 5 V standby lead (5VSB). If not, you may have difficulty powering on your system.*

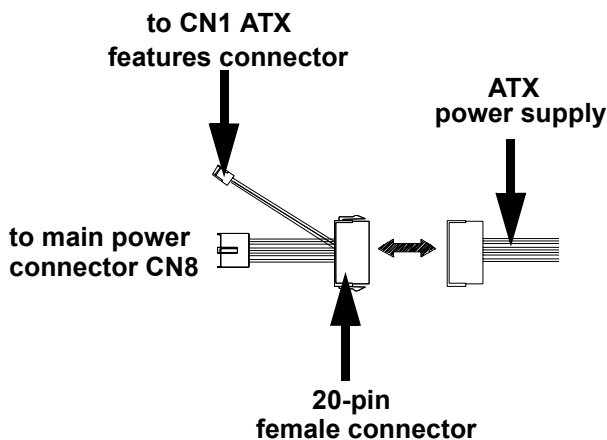

Figure 2.3: Wiring for ATX soft power switch function

2.11 Printer port connector (CN4)

Normally, the parallel port is used to connect the card to a printer. The PCI-6872 includes a multi-mode (ECP/EPP/SPP) parallel port accessed via CN4 and a 26-pin flat-cable connector. You will need an adapter cable if you use a traditional DB-25 connector. The adapter cable has a 26-pin connector on one end, and a DB-25 connector on the other.

The parallel port is designated as LPT1, and can be disabled or changed to LPT2 or LPT3 in the system BIOS setup.

The parallel port interrupt channel is designated to be IRQ7.

You can select ECP/EPP DMA channel via BIOS setup.

2.12 CompactFlash Card connector

The PCI-6872 provides a 50-pin socket for CompactFlash card type I/II.

2.12.1 CompactFlash (CN5)

The CompactFlash card shares a secondary IDE channel which can be enabled/disabled via the BIOS settings.

2.13 Floppy drive connector (CN3)

You can attach one 3.5" floppy drive to the the PCI-6872's onboard controller. This is useful for notebooks, for example.

A daisy-chain drive cable converter (part no. 9681000044) is required for a single floppy system. A 34-pin flat-cable connector is fitted on one end of the cable converter, while the other end has one floppy disk drive connector. It consists of a 34-pin flat-cable connector (for the 3.5" drives).

2.13.1 Connecting the floppy drive

1. Plug the 34-pin flat-cable connector into the cable converter. Make sure that the red wire corresponds to pin 1 on the connector.
2. Attach the appropriate connector at the other end of the cable to the floppy drive(s). You can use only one connector in the set. The set at the other end (after the twist in the cable) connects to the A: drive.

When connecting a 3.5" floppy drive, you may have some difficulties in determining which pin is number one. Look for a number on the circuit board indicating pin number one. In addition, you should check if the connector on the floppy drive has an extra slot. If the slot is up pin number one should be on the right. Please refer to any documentation that came with the drive for more information.

If your cable needs to be custom made, you can find the pin assignments for the board's connector in Appendix C.

2.14 IDE connector(CN1,CN2)

The PCI-6872 provides two IDE channel to which you can attach up to four Enhanced Integrated Device Electronics hard disk drives or CDROM to the PCI-6872's internal controller. The PCI-6872's IDE controller uses a PCI interface. This advanced IDE controller supports faster data transfer, PIO Mode 3 or Mode 4, UDMA 33/66/100 mode.

2.14.1 Connecting the hard drive

Connecting drives is done in a daisy-chain fashion. The cable depending on the drive size. 1 x 40-pin flat cable(p/n: 1701400452) is packing in PCI-6872's package.

Wire number 1 on the cable is red or blue, and the other wires are gray.

1. Connect one end of the cable to CN1,CN2. Make sure that the red (or blue) wire corresponds to pin 1 on the connector, which is labeled on the board (on the right side).

2. Plug the other end of the cable into the Enhanced IDE hard drive, with pin 1 on the cable corresponding to pin 1 on the hard drive. (See your hard drive's documentation for the location of the connector.)

If desired, connect a second drive as described above.

Unlike floppy drives, IDE hard drives can connect to either end of the cable. If you install two drives, you will need to set one as the master and one as the slave by using jumpers on the drives. If you install only one drive, set it as the master.

2.15 VGA/LCD interface connections

The PCI-6872's display interface can drive conventional CRT displays and is capable of driving a wide range of flat panel displays as well, including passive LCD and active LCD displays. The board has two display connectors: one for standard CRT VGA monitors, and one for flat panel displays.

2.15.1 CRT display connector (CN7)

CN7 is a standard 15-pin D-SUB connector commonly used for VGA.

Pin assignments for CRT display connector CN7 are detailed in Appendix C

2.15.2 Flat panel display connector (CN22)

CN22 consists of a 40-pin connector which can support an 18-bit LCD panel. It is Hirose's product no. DF13A-40DP-1.25 V.

The PCI-6872 provides a bias control signal on CN22 that can be used to control the LCD bias voltage. It is recommended that the LCD bias voltage not be applied to the panel until the logic supply voltage (+5 V or +3.3 V) and panel video signals are stable. Under normal operation, the control signal (ENAVEE) is active high. When the PCI-6872's power is applied, the control signal is low until just after the relevant flat panel signals are present. CN22 can connect up to 18 bit TFT LCD.

2.15.3 Extension flat panel connector(CN23)

CN23 consists of a 20-pin connector which is Hirose's product no. DF13-20DP-1.25V. The PCI-6872 supports a 36-bit LCD panel which must be connected to both the CN22(40-pin) and CN23 (20-pin). The pin assignments for both CN22 and CN23 can be found in Appendix C.

2.15.4 LVDS LCD panel connector (CN25)

The PCI-6872 uses the VIA "TwisterT" chip that supports 2 channel LVDS LCD panel displays. Users can connect to LVDS LCD with CN25.

2.15.5 Panel type selection(SW1)

SW1 is an 8 segment DIP switch for DSTN/TFT panel type and resolution functions

Table 2.6: S1 Panel Type Select (SW1)

SW 1-1	SW 1-2	SW 1-3	SW 1-4	Panel Type & Resolution		
ON	ON	ON	ON	TFT	640x480**	18bit (H. V. Freq)
ON	ON	ON	OFF	TFT	640x480	18bit (Synthetic)
ON	ON	OFF	ON	TFT	640x480**	N/A
ON	ON	OFF	OFF	TFT	640x480**	LVDS
ON	OFF	ON	ON	DSTN	640x480**	18bit
ON	OFF	ON	OFF	TFT	800x600**	18bit (H. V. Freq)
ON	OFF	OFF	ON	TFT	800x600	18bit (Synthetic)
ON	OFF	OFF	OFF	TFT	800x600**	LVDS
OFF	ON	ON	ON	TFT	800x600**	N/A
OFF	ON	ON	OFF	DSTN	800x600**	18bit
OFF	ON	OFF	ON	TFT	1024x768**	36bit (H. V. Freq)
OFF	ON	OFF	OFF	TFT	1024x768**	36bit (Synthetic)
OFF	OFF	ON	ON	TFT	1024x768**	LVDS
OFF	OFF	ON	OFF	TFT	1024x768**	N/A
OFF	OFF	OFF	ON	DSTN	1024x768**	18bit
OFF	OFF	OFF	OFF	DSTN	1024x768**	24bit

* Default setting

** will support in the future

2.16 USB connectors (CN6)

The PCI-6872 board provides up to two USB (Universal Serial Bus) ports. This gives complete Plug and Play, and hot attach/detach for up to 127 external devices. The USB interfaces comply with USB specification Rev. 1.1, and are fuse protected.

The USB interface is accessed through the 5 x 2-pin flat-cable connector, CN6 (USB1, 2). You will need an adapter cable if you use a standard

USB connector. The adapter cable has a 5 x 2-pin connector on one end and a USB connector on the other.

The USB interfaces can be disabled in the system BIOS setup.

2.17 Ethernet configuration

The PCI-6872 is equipped with a high performance 32-bit PCI-bus Ethernet interface which is fully compliant with IEEE 802.3U 10/100Mbps CSMA/CD standards. It is supported by all major network operating systems.

The PCI-6872 supports 10/100Mbps Ethernet connections with onboard RJ-45 connectors(CN8)

2.17.1 100Base-T connector (CN8)

10/100Base-T connects to the PCI-6872 via an adapter cable to an 8-pin polarized header (CN8).

2.17.2 Network boot

The Network Boot feature can be utilized by incorporating the Boot ROM image files for the appropriate network operating system. The Boot ROM BIOS files are included in the system BIOS, which is on the utility CD disc.

2.18 Power connectors (CN14, CN15)

2.18.1 Main power connector, +5 V, +12 V (CN15)

Supplies main power to the PCI-6872 (+5 V), and to devices that require +12 V.

2.18.2 CPU Fan power supply connector (CN14)

Provides power supply to CPU cooling fan. Only present when +12 V power is supplied to the board.

2.19 ATX Power & HDD LED, speaker out Connector (CN16, CN17, CN19)

Next, you may want to install external switches to monitor and control the PCI-6872. These features are optional: install them only if you need them. CN16, CN17, CN19 integrated in one connector, which is an 5x3

pin header, 180degree, male. It provides connections for a speaker, hard disk access indicator.

2.19.1 HDD LED (CN19)

The HDD LED indicator for hard disk access is an active low signal(24mA sink rate).

2.19.2 ATX power LED&KB-LOCK (CN16)

Power supply activity LED indicator and KB_lock funcnction.

2.19.3 Speaker out(CN17)

Support a buzzer function, pin assignment refer to Appendix C.

2.20 COM port connector(CN9,CN10, CN29)

The PCI-6872 provides two serial ports (COM1: RS-232 and COM2: RS422/485) in one COM port connector. It provides connections for serial devices (a mouse, etc.) or a communication network. You can find the pin assignments for the COM port connector in Appendix C.

2.21 Keyboard and PS/2 mouse connector (CN11)

The PCI-6872 board provides a keyboard connector that supports both a keyboard and a PS/2 style mouse. In most cases, especially in embedded applications, a keyboard is not used. If the keyboard is not present, the standard PC/AT BIOS will report an error or fail during power-on self-test (POST) after a reset. The PCI-6872's BIOS standard setup menu allows you to select "All, But Keyboard" under the "Halt On" selection. This allows no-keyboard operation in embedded system applications, without the system halting under POST.

2.22 External KB/mouse connector (CN12)

In addition to the PS/2 mouse/keyboard connector on the PCI-6872's rear plate, there is an additional onboard external keyboard connector, allowing for greater flexibility in system design.

2.23 Watchdog output (CN18)

It provides connection for watchdog output, detailed pin assignment refer to appendix.

2.24 Daughter card connector (CN27,CN28)

CN27, CN28 are 20 pin 180degree female connectors. With daughter board, PCI-6872 can support 2 LAN and 4 USB ports. Detailed pin definition you will find in appendixB.

Software Configuration

This chapter details the software configuration information. It shows you how to configure the card to match your application requirements. Award System BIOS will be covered in Chapter 4.

Sections include:

- Introduction
- VGA display software configuration

Chapter 3 Software Configuration

3.1 Introduction

The system BIOS and custom drivers are located in a 256 KB, 32-pin (JEDEC spec.) Flash ROM device, designated U10. A single Flash chip holds the system BIOS, VGA BIOS, and network Boot ROM image. The display can be configured via software. This method minimizes the number of chips and eases configuration. You can change the display BIOS simply by reprogramming the Flash chip.

3.2 VGA display firmware configuration

The board's on-board VGA interface supports a wide range of popular LCD, EL, gas plasma flat panel displays and traditional analog CRT monitors. The optimized shared memory architecture supports an 8/16/32 MB frame buffer using system memory to provide resolutions of 1280 x 1024 @ 16 bpp, the interface can drive CRT displays with resolutions up to 1024 x 768 @ 16 bpp and 800 x 600 @ 16 bpp.

The VGA interface is configured completely via the software utility, so you do not have to set any jumpers. Configure the VGA display as follows:

1. Apply power to the board with a color TFT display attached. This is the default setting for this board. Ensure that the AWD-FLASH.EXE and *.BIN files are located in the working drive.

NOTE: *Ensure that you do not run AWDFLASH.EXE while your system is operating in EMM386 mode.*

2. At the prompt, type AWDFLASH.EXE and press <Enter>. The VGA configuration program will then display the following:

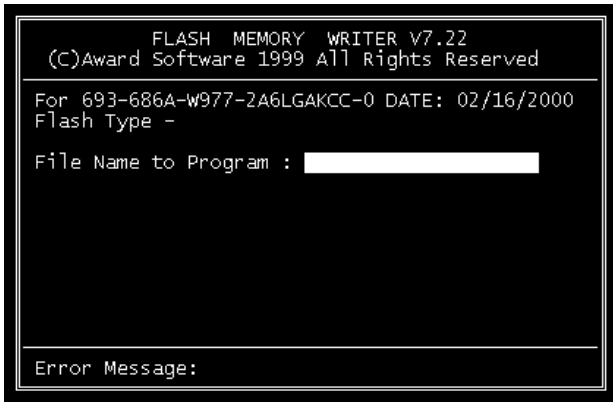

Figure 3.1: VGA setup screen

3. At the prompt, enter the new BIN file which supports your display. When you are sure that you have entered the file name correctly press <Enter>.
4. The screen will ask "Do you want to save BIOS?". If you change your mind or have made a mistake, press N to abort and end the setup procedure. Press Y if you wish to save the existing configuration before changing it. Then type the name under which you want to save the current configuration.
5. The prompt will then ask "Are you sure to program?". Press Y if you want the new file to be written into the BIOS. Press N to exit the program.

The new VGA configuration will then write to the ROM BIOS chip. This configuration will remain the same until you run the AWDFLASH.EXE program and change the settings.

CHAPTER 4

Award BIOS Setup

This chapter describes how to set BIOS configuration data.

Chapter 4 Award BIOS Setup

4.1 System test and initialization

These routines test and initialize board hardware. If the routines encounter an error during the tests, you will either hear a few short beeps or see an error message on the screen. There are two kinds of errors: fatal and non-fatal. The system can usually continue the boot up sequence with non-fatal errors. Non-fatal error messages usually appear on the screen along with the following instructions:

press <F1> to RESUME

Write down the message and press the F1 key to continue the bootup sequence.

4.1.1 System configuration verification

These routines check the current system configuration against the values stored in the board's CMOS memory. If they do not match, the program outputs an error message. You will then need to run the BIOS setup program to set the configuration information in memory.

There are three situations in which you will need to change the CMOS settings:

1. You are starting your system for the first time
2. You have changed the hardware attached to your system
3. The CMOS memory has lost power and the configuration information has been erased.

The PCI-6872 Series' CMOS memory has an integral lithium battery backup. The battery backup should last at least three years in normal service, but when it finally runs down, you will need to replace the complete unit.

4.2 Award BIOS setup

Award's BIOS ROM has a built-in Setup program that allows users to modify the basic system configuration. This type of information is stored in battery-backed CMOS RAM so that it retains the Setup information when the power is turned off.

4.2.1 Entering setup

Power on the computer and press immediately. This will allow you to enter Setup.

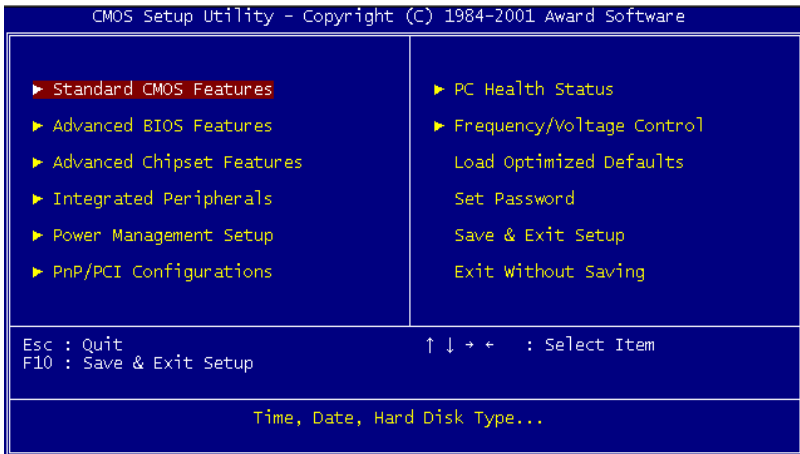

Figure 4.1: BIOS setup program initial screen

4.2.2 Standard CMOS Features setup

When you choose the Standard CMOS Features option from the Initial Setup Screen menu, the screen shown below is displayed. This standard Setup Menu allows users to configure system components such as date, time, hard disk drive, floppy drive and display. Once a field is highlighted, on-line help information is displayed in the left bottom of the Menu screen.

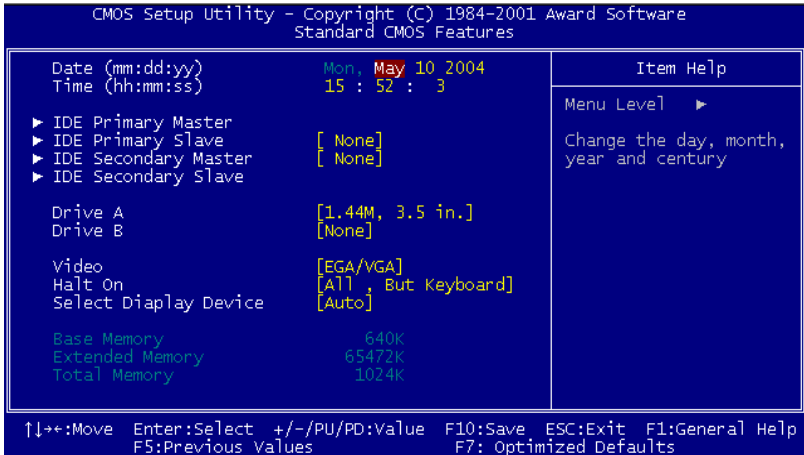

Figure 4.2: CMOS Features setup

4.2.3 Advanced BIOS Features setup

By choosing the Advanced BIOS Features Setup option from the Initial Setup Screen menu, the screen below is displayed. This sample screen contains the manufacturer's default values for the PCI-6872 Series.

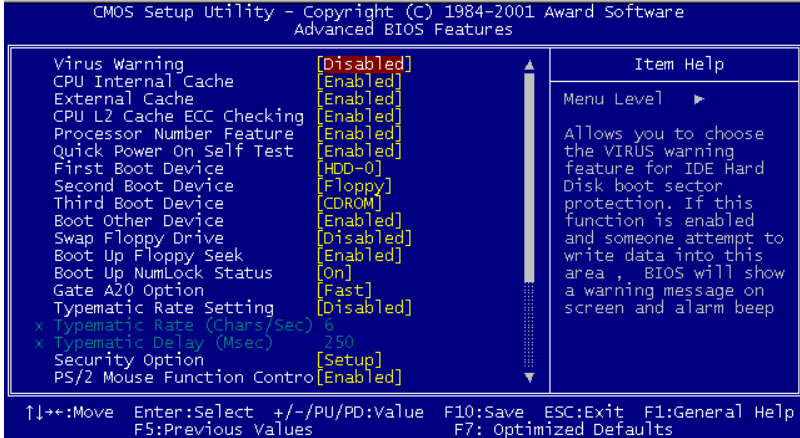

Figure 4.3: Advanced BIOS Features setup

4.2.4 Advanced Chipset Features setup

By choosing the Advanced Chipset Features option from the Initial Setup Screen menu, the screen below is displayed. This sample screen contains the manufacturer's default values for the PCI-6872 Series.

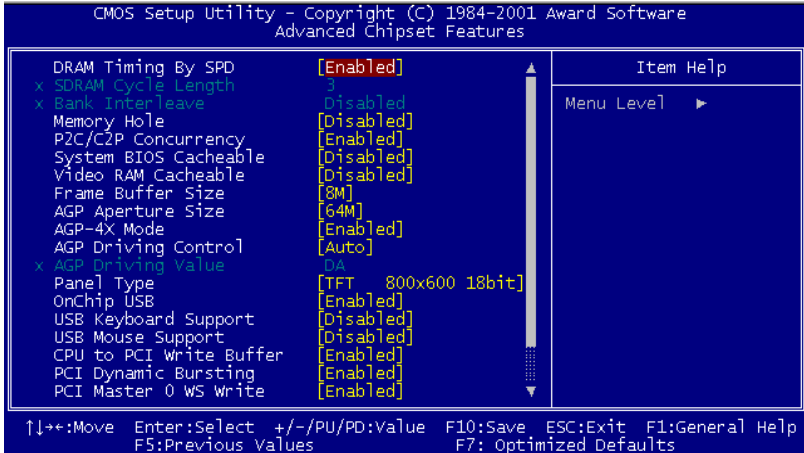

Figure 4.4: Advanced Chipset Features setup

4.2.5 Integrated Peripherals

Choosing the Integrated Peripherals option from the Initial Setup Screen menu should produce the screen below. Here we see the manufacturer's default values for the PCI-6872 Series.

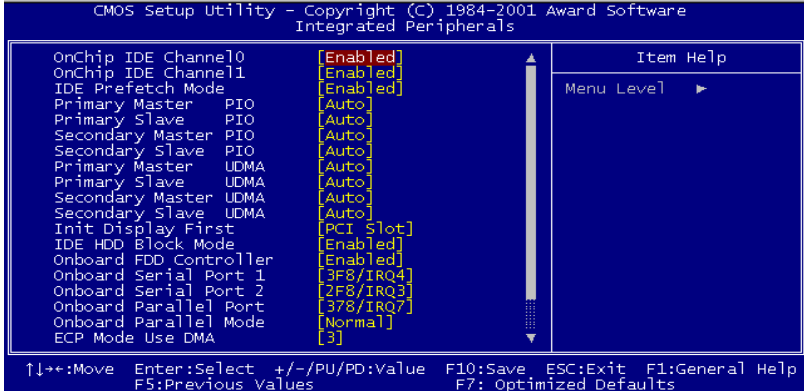

Figure 4.5: Integrated Peripherals

4.2.6 Power Management Setup

By choosing the Power Management Setup option from the Initial Setup Screen menu, the screen below is displayed. This sample screen contains the manufacturer's default values for the PCI-6872 Series.

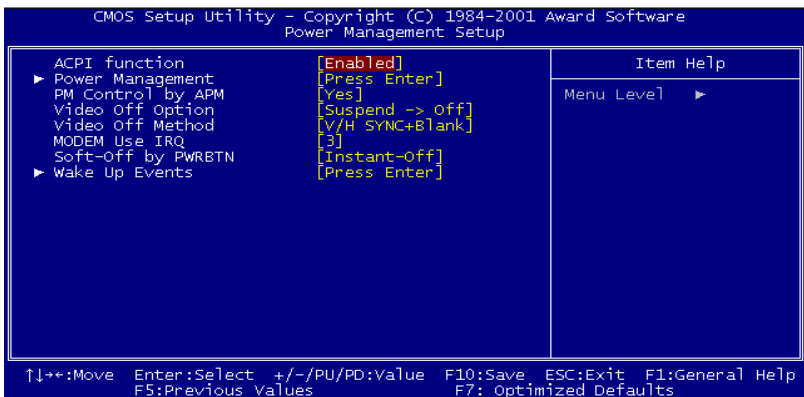

Figure 4.6: Power Management Setup

4.2.7 PnP/PCI Configurations

By choosing the PnP/PCI Configurations option from the Initial Setup Screen menu, the screen below is displayed. This sample screen contains the manufacturer's default values for the PCI-6872 Series.

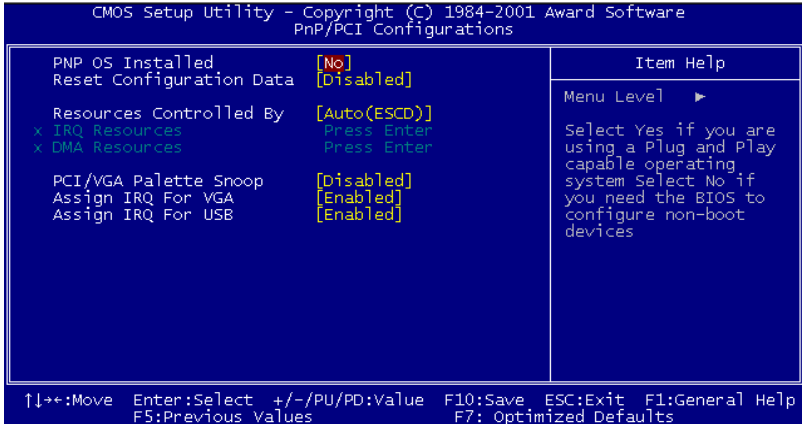

Figure 4.7: PnP/PCI Configurations

4.2.8 PC Health Status

The PC Health Status option displays information such as CPU and motherboard temperatures, fan speeds, and core voltage.

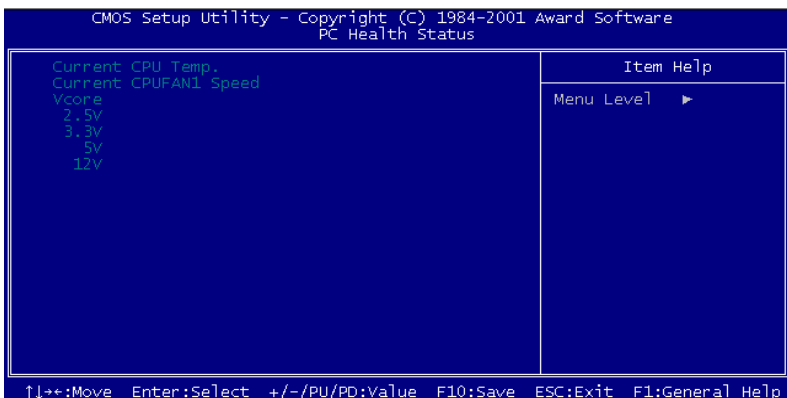

Figure 4.8: PC Health Status

4.2.9 Frequency/Voltage Control

By choosing the Frequency/Voltage Control option from the Initial Setup Screen menu, the screen below is displayed. This sample screen contains the manufacturer's default values for the PCI-6872

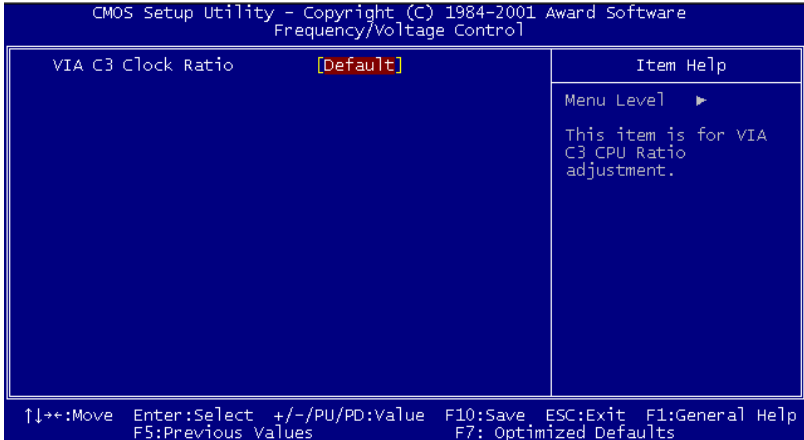

Figure 4.9: Frequency/Voltage Control

Caution *Incorrect settings in Frequency/Voltage Control may damage the system CPU, video adapter, or other hardware.*

4.2.10 Load Optimized Defaults

Load Optimized Defaults loads the default system values directly from ROM. If the stored record created by the Setup program should ever become corrupted (and therefore unusable), these defaults will load automatically when you turn the PCI-6872 Series system on.

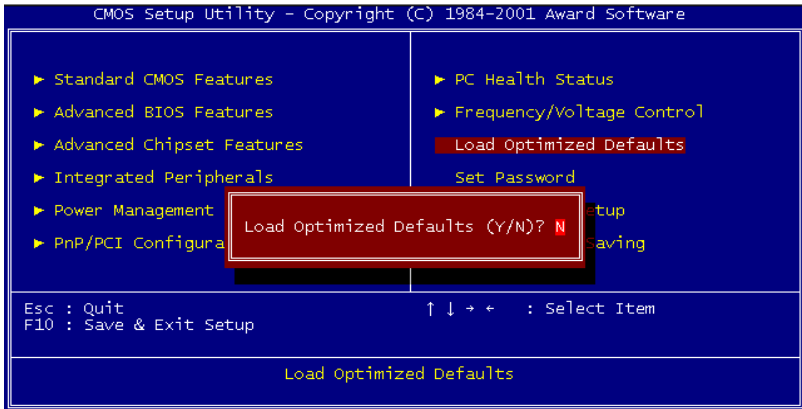

Figure 4.10: Load BIOS defaults screen

4.2.11 Set Password

Note *To enable this feature, you should first go to the Advanced BIOS Features menu, choose the Security Option, and select either Setup or System, depending on which aspect you want password protected. Setup requires a password only to enter Setup. System requires the password either to enter Setup or to boot the system.*

A password may be at most 8 characters long.

To Establish Password

1. Choose the Set Password option from the CMOS Setup Utility main menu and press <Enter>.
2. When you see "Enter Password," enter the desired password and press <Enter>.

3. At the “Confirm Password” prompt, retype the desired password, then press <Enter>.
4. Select Save to CMOS and EXIT, type <Y>, then <Enter>.

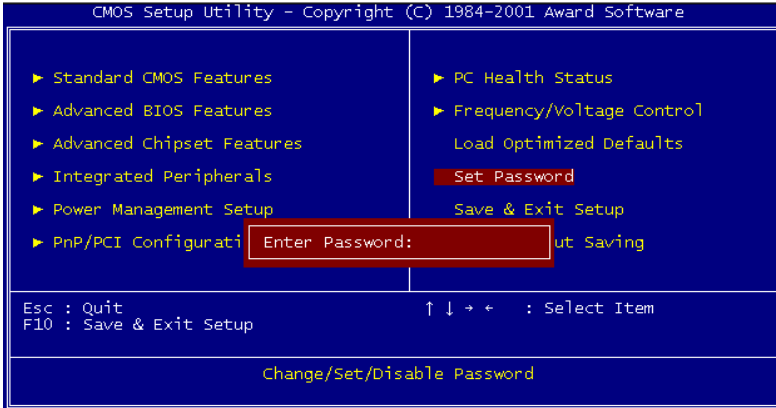

Figure 4.11: Establish Password

To Change Password

1. Choose the Set Password option from the CMOS Setup Utility main menu and press <Enter>.
2. When you see “Enter Password,” enter the existing password and press <Enter>.
3. You will see “Confirm Password.” Type it again, and press <Enter>.
4. Select Set Password again, and at the “Enter Password” prompt, enter the new password and press <Enter>.
5. At the “Confirm Password” prompt, retype the new password, and press <Enter>.
6. Select Save to CMOS and EXIT, type <Y>, then <Enter>.

To Disable Password

1. Choose the Set Password option from the CMOS Setup Utility main menu and press <Enter>.

2. When you see “Enter Password,” enter the existing password and press <Enter>.
3. You will see “Confirm Password.” Type it again, and press <Enter>.
4. Select Set Password again, and at the “Enter Password” prompt, don’t enter anything; just press <Enter>.
5. At the “Confirm Password” prompt, again don’t type in anything; just press <Enter>.
6. Select Save to CMOS and EXIT, type <Y>, then <Enter>.

4.2.12 Save & Exit Setup

If you select this option and press <Y> then <Enter>, the values entered in the setup utilities will be recorded in the chipset’s CMOS memory. The microprocessor will check this every time you turn your system on and use the settings to configure the system. This record is required for the system to operate.

4.2.13 Exit Without Saving

Selecting this option and pressing <Enter> lets you exit the Setup program without recording any new values or changing old ones.

CHAPTER 5

PCI SVGA Setup

- Introduction
- Installation of SVGA drivers
 - for Windows 95/98/Me
 - for Windows NT/2000/XP
- Further information

Chapter 5 PCI SVGA Setup

5.1 Introduction

The board has an onboard AGP flat panel/VGA interface. The specifications and features are described as follows:

5.1.1 Chipset

The board uses a VIA Twister 8606T chipset from VIA Technology Inc. for its AGP/SVGA controller. It supports many popular LCD, and LVDS LCD displays and conventional analog CRT monitors. The VIA8606T VGA BIOS supports color TFT and DSTN LCD flat panel displays. In addition, it also supports interlaced and non-interlaced analog monitors (color and monochrome VGA) in high-resolution modes while maintaining complete IBM VGA compatibility. Digital monitors (i.e. MDA, CGA, and EGA) are NOT supported. Multiple frequency (multisync) monitors are handled as if they were analog monitors.

5.1.2 Display memory

The Twister chip can support 8/16/32MB frame buffer shared with system memory; the VGA controller can drive CRT displays or color panel displays with resolutions up to 1280 x 1024 at 16 M colors.

5.1.3 Display types

CRT and panel displays can be used simultaneously. The board can be set in one of three configurations: on a CRT, on a flat panel display, or on both simultaneously. The system is initially set to simultaneous display mode. If you want to enable the CRT display only or the flat panel display only, please contact VIA Technology Inc., or our sales representative for detailed information.

5.2 Installation of the SVGA Driver

Complete the following steps to install the SVGA driver. Follow the procedures in the flow chart that apply to the operating system that you are using within your PCI-6872.

- Notes:**
1. The windows illustrations in this chapter are intended as examples only. Please follow the listed steps, and pay attention to the instructions which appear on your screen.
 2. For convenience, the CD-ROM drive is designated as "E" throughout this chapter.

5.2.1 Installation for Windows 95

Step 1. Select "Start", "Settings", "Control Panel", "Display", "Settings", and "Advanced Properties".

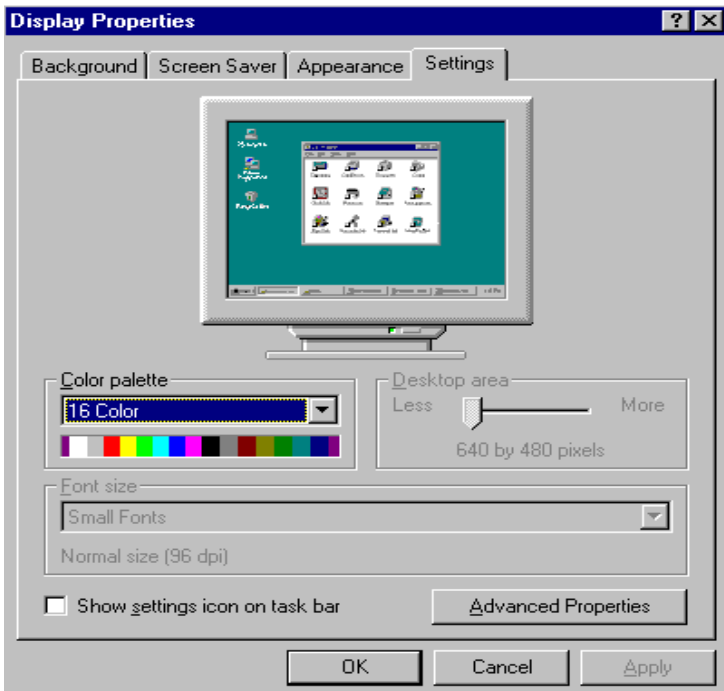

Step 2. Choose the "Adapter" tab, then press the "Change..." button.

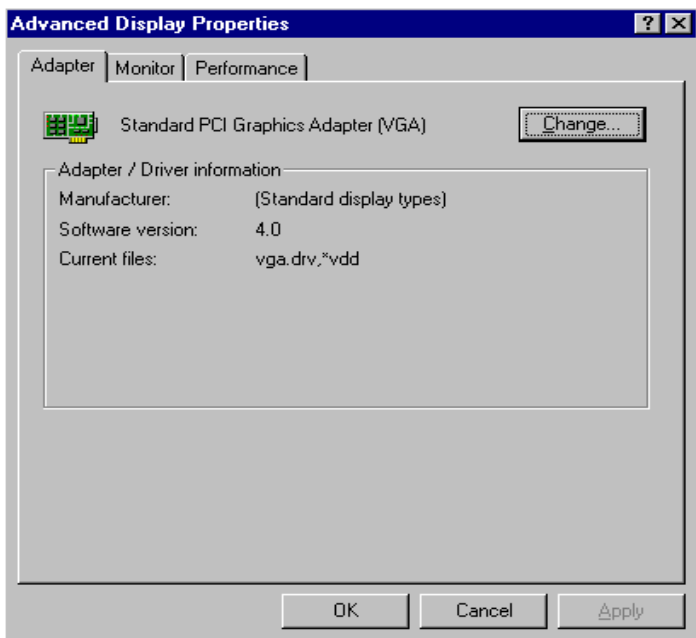

Step 3. Press the "Have Disk" button.

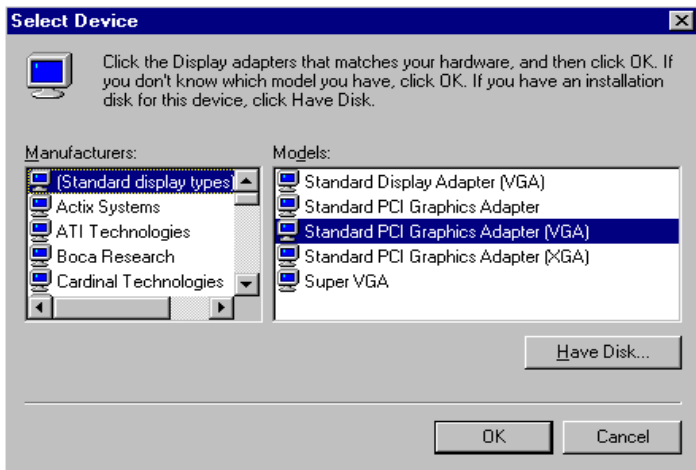

Step 4. Type in the path:

D:\Biscuit\9577\VGA\Win9x_Me

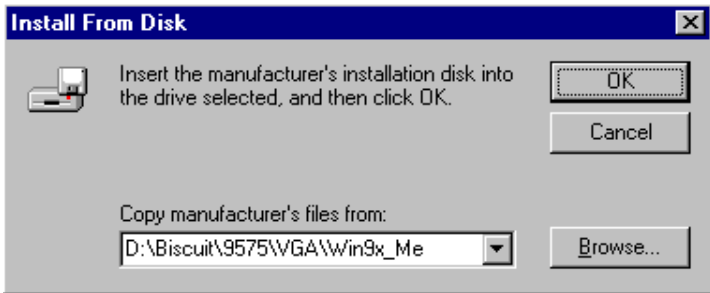

Step 5. Select the highlighted item, and click the "OK" button.

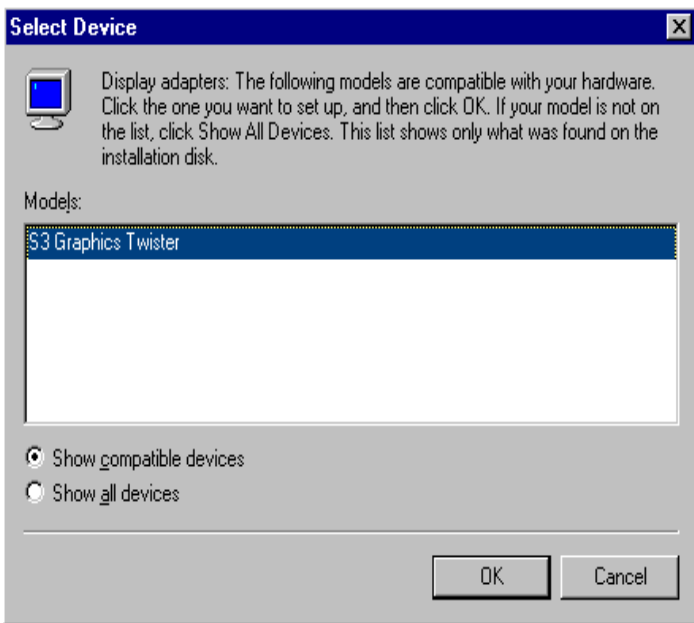

Step 6. "S3 GraphicsTwister" appears under the adapter tab. Click the "Apply" button, then the "OK" button

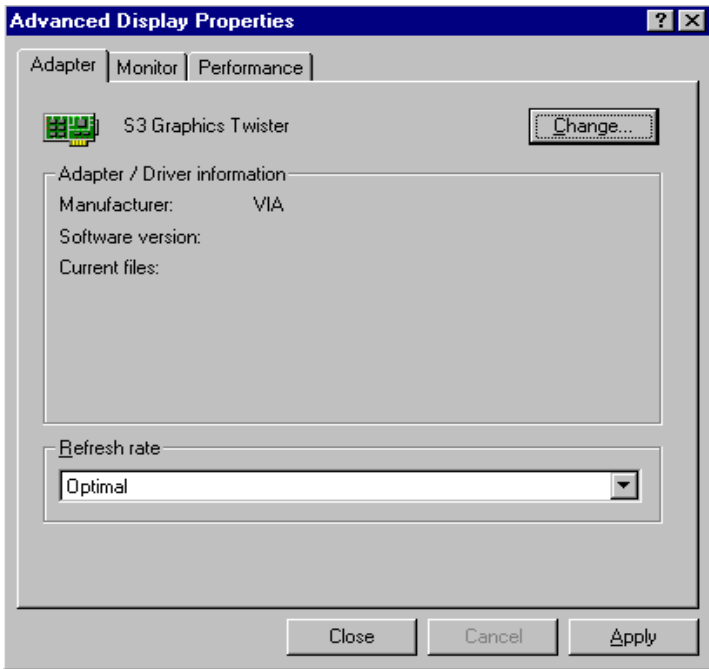

Step 7. Press "Yes" to reboot.

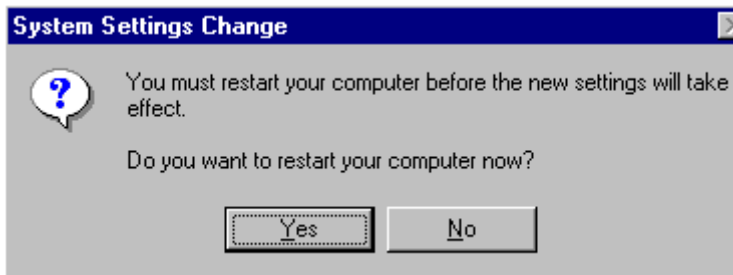

5.2.2 Installation for Windows 98/Me

Step 1. Select "Start", "Settings", "Control Panel", "Display", and "Settings," then press the "Advanced..." button.

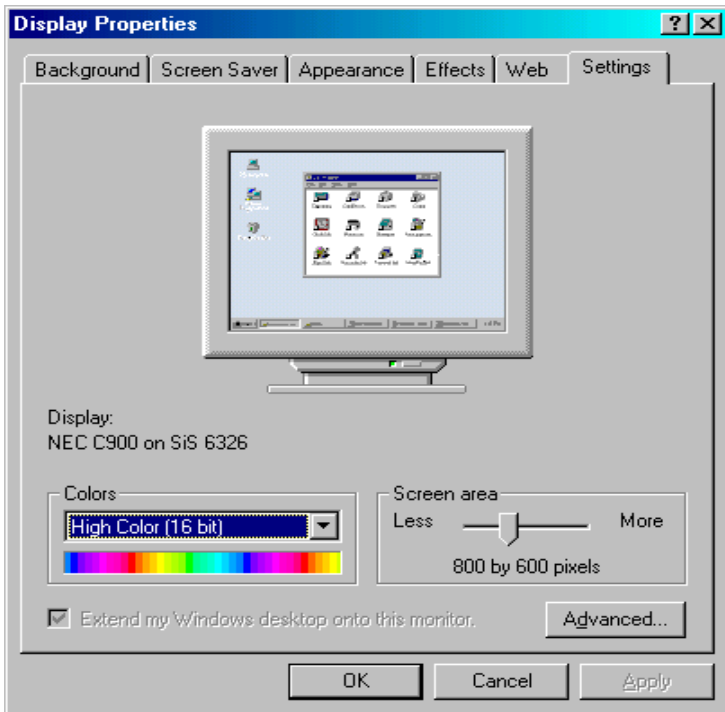

Step 2. Select “Adapter,” then “Change.”



Step 3. Press “Next,” then “Display a list...”

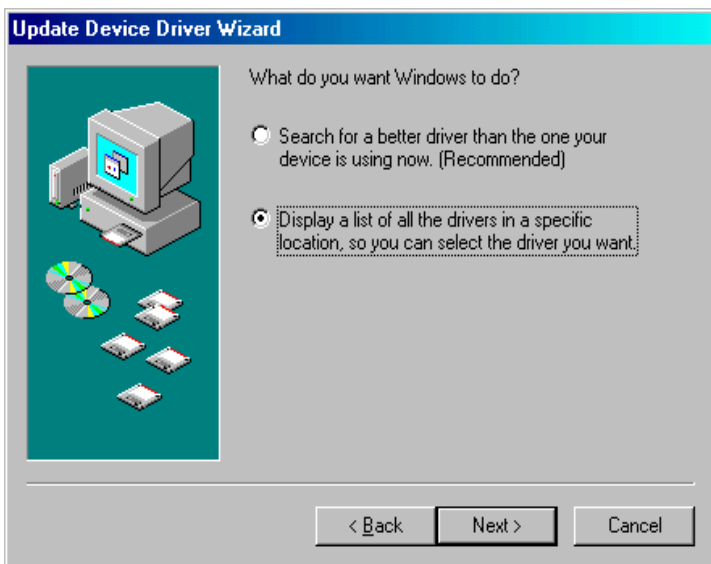

Step 4. Press the “Have disk...” button.

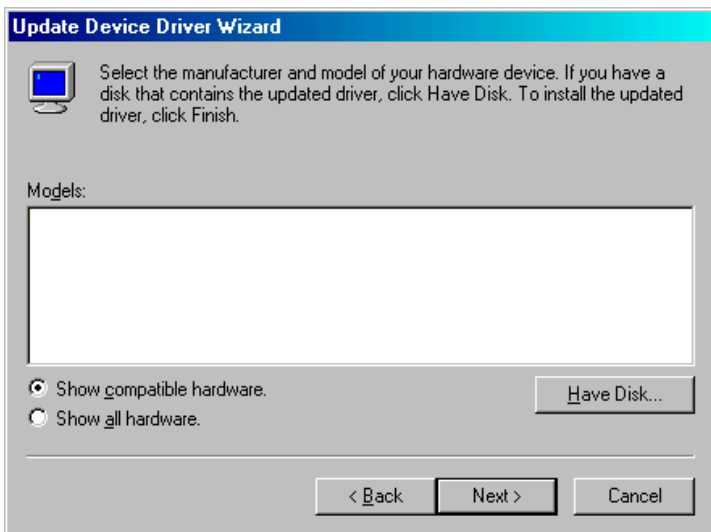

- Step 5. Insert the CD into the CD-ROM drive. Type in the path
D:\Biscuit\9577\VGA\Win9x_Me
Then press “OK”



- Step 6. Select the highlighted item, then click “OK.”

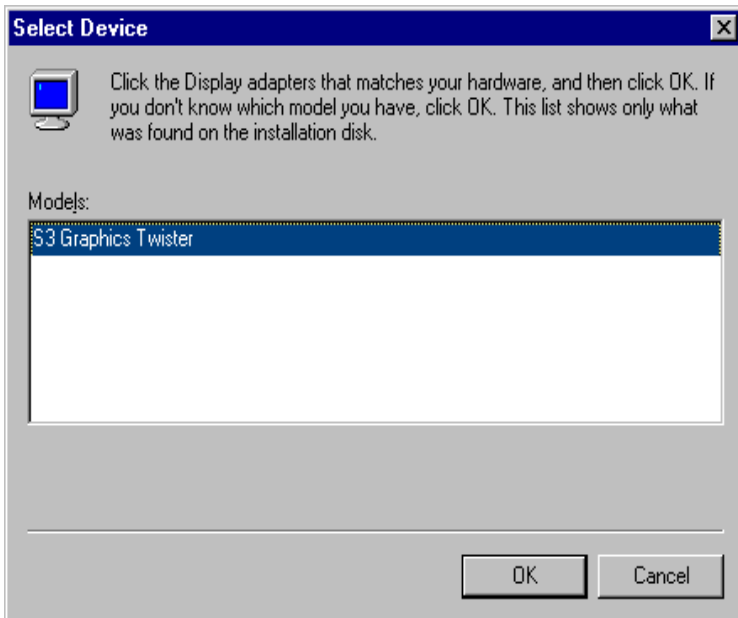

Step 7. "S3 Graphics Twister" appears under the adapter tab. Click the "Apply" button.

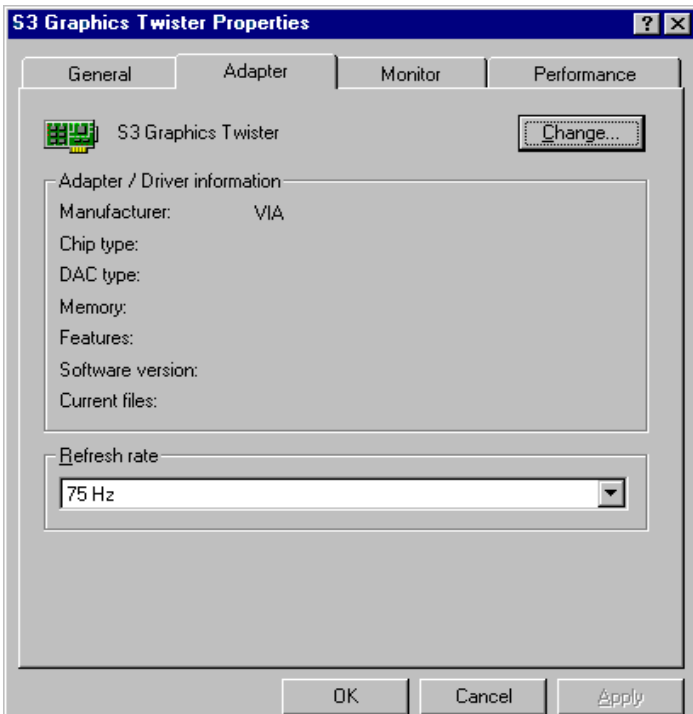

Step 8. Press "Yes" to reboot.

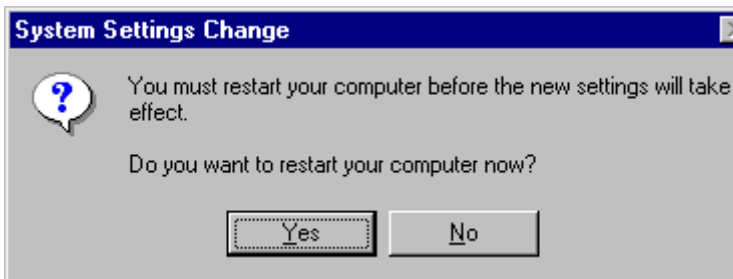

5.2.3 Installation for Windows NT

Note: Service Pack X (X = 3, 4, 5, 6,...) must be installed first, before you install the Windows NT VGA driver.

Step 1. Select "Start", "Settings", "Control Panel" and double click the "Display" icon.

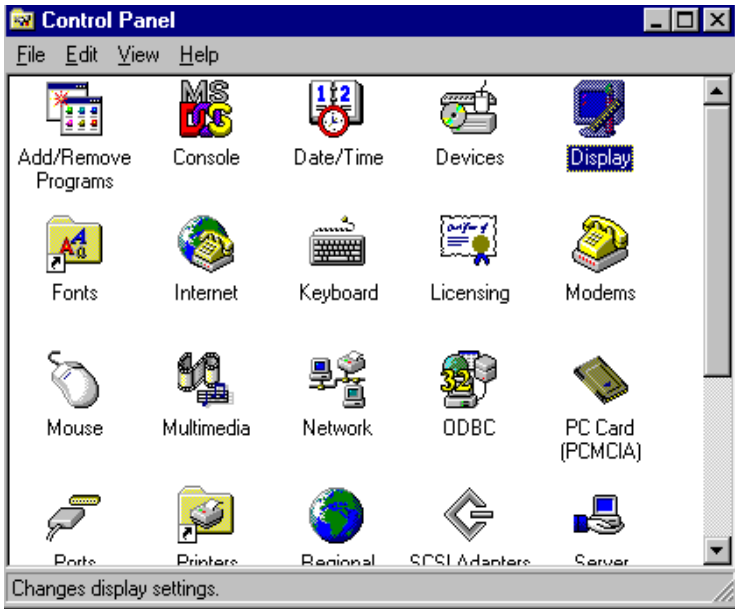

Step 2. Choose the "Settings" tab, and press the "Display Type" button.

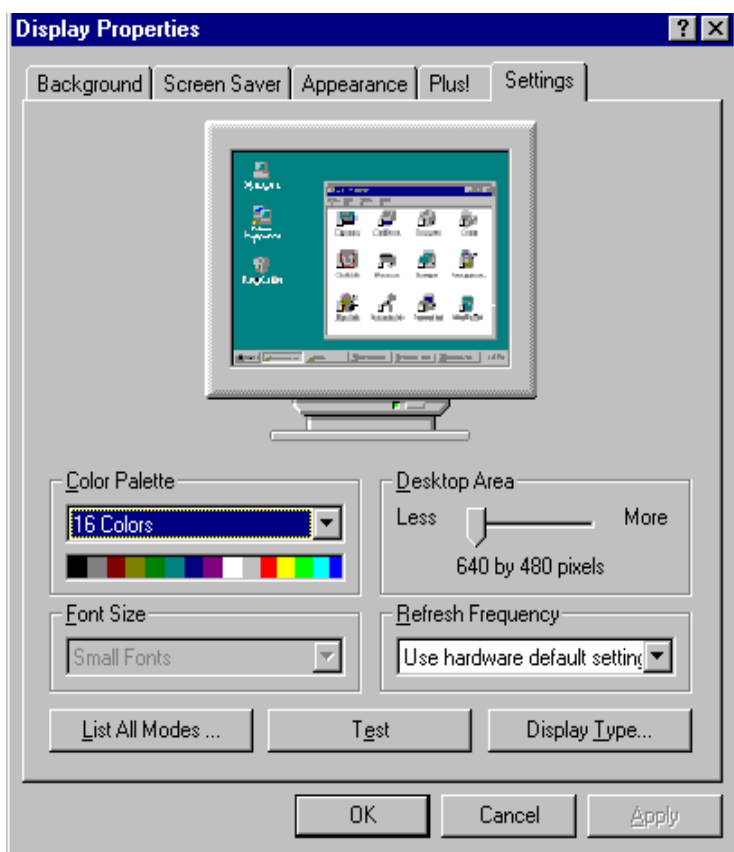

Step 3. Press the "Change..." button.

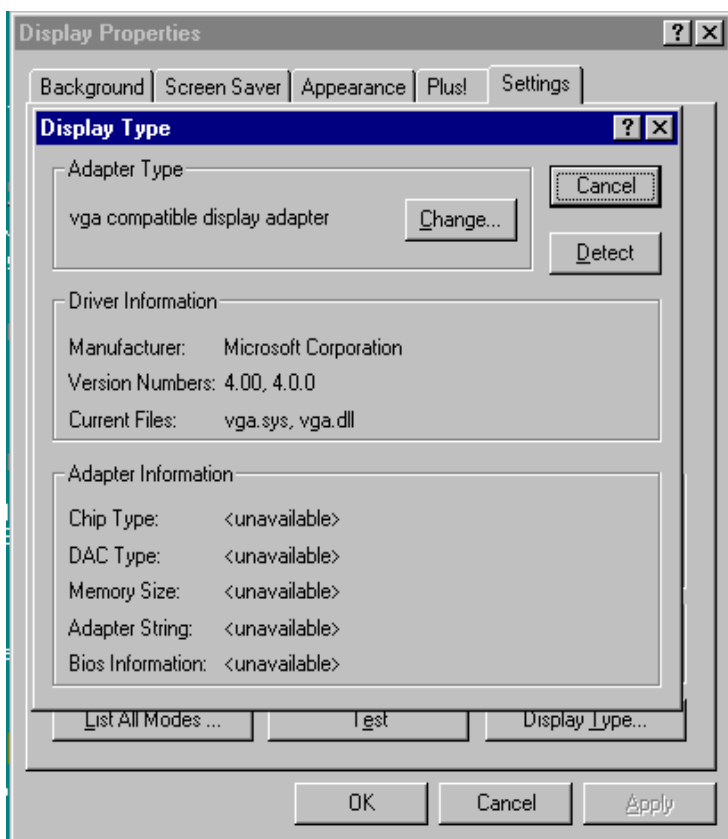

Step 4. Click the "Have Disk..." button.

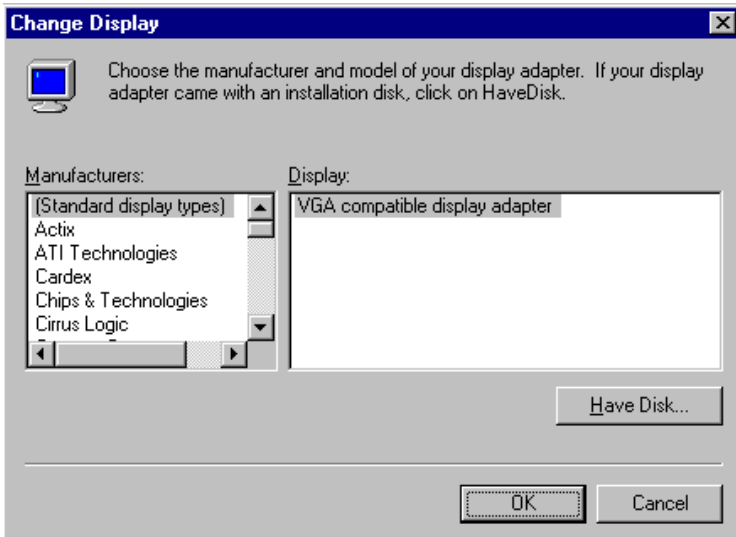

Step 5. Type the path:

D:\Biscuit\VGA\WinNT

Press the "OK" button.

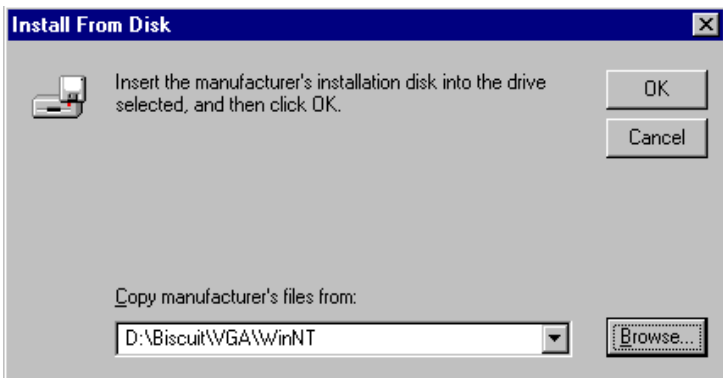

Step 6. Select the highlighted item, and click the "OK" button.

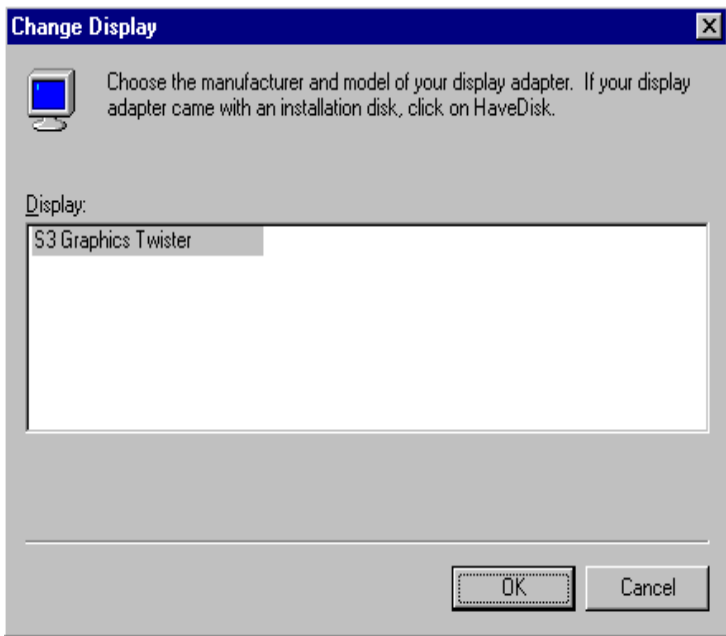

Step 7. Press "Yes" to proceed.

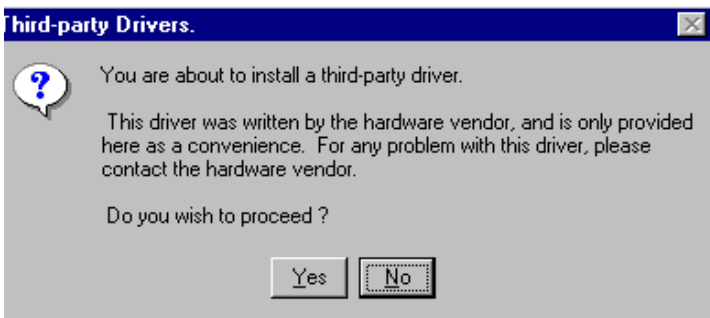

Step 8. Press "OK" to reboot.

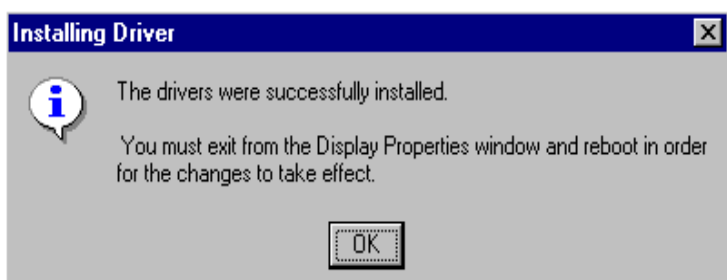

5.2.4 Installation for Windows 2000

Step 1. Select "System", "Settings", "Control Panel" and double click the "system" icon.



Step 2. Choose the "Video Controller (VGA Compatible)" button.

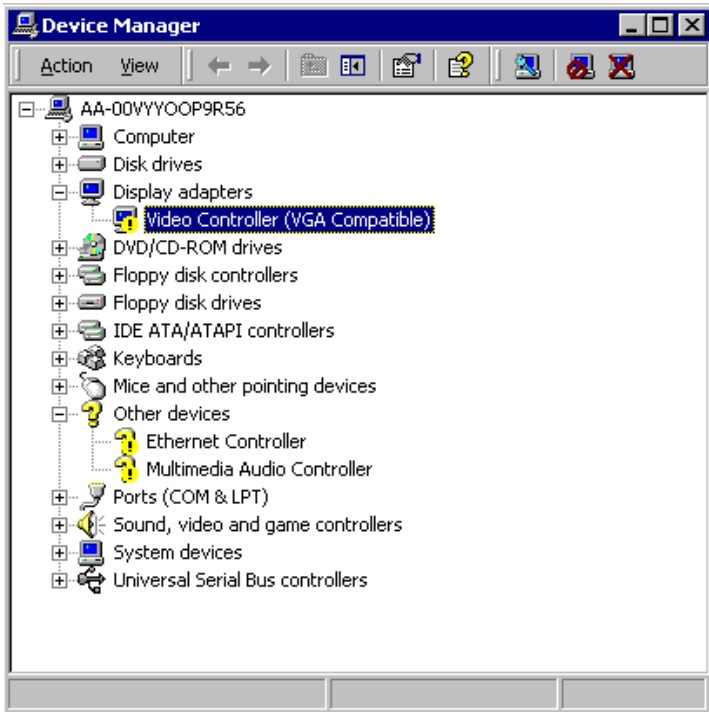

Step 3. Choose the "Drive" button, press "Update Driver..." button.



Step 4. Choose "Display a list of..." , then press "Next" button.



Step 5. Choose "Display adapters", press "Next" button.

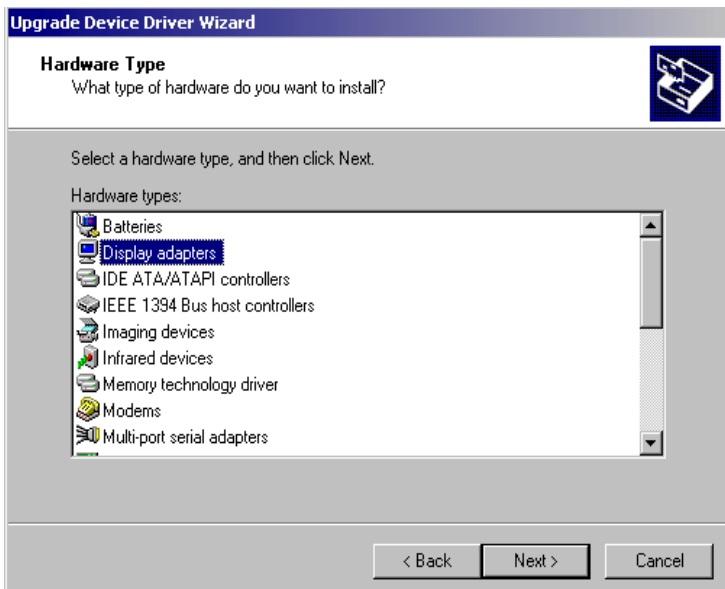

Step 6. Click the “Have Disk” button.

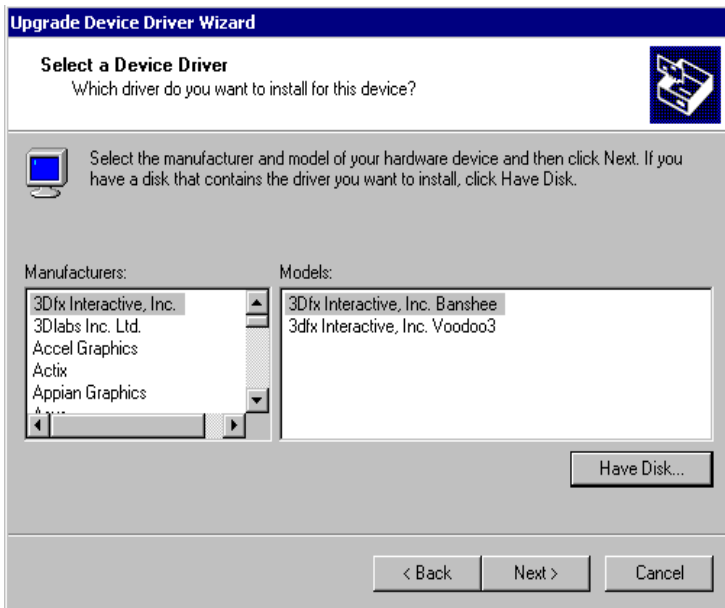

Step 7. Type the path D:\Biscuit\9577\VGA\Win2000 press the “OK” button.

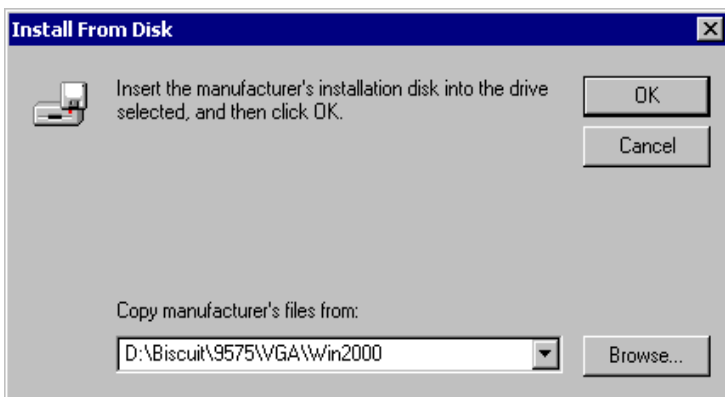

Step 8. Press “Finish” to reboot.

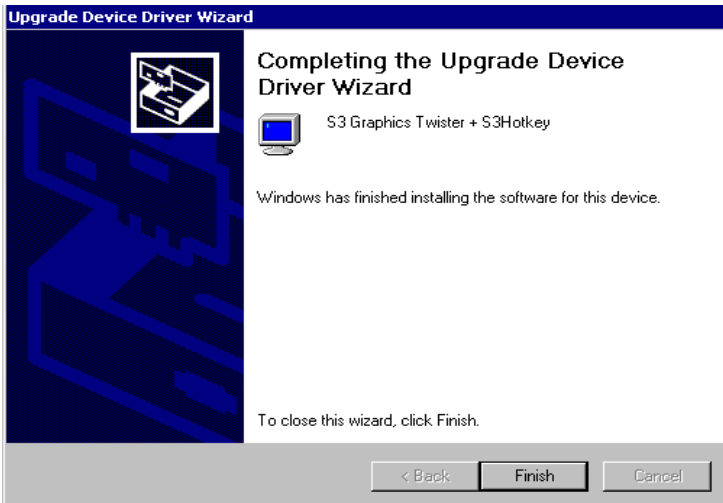

5.2.5 Installation for Windows XP

Step 1. Select “Start,” “Settings,” “System,” “Control Panel” and double click the “system” icon.

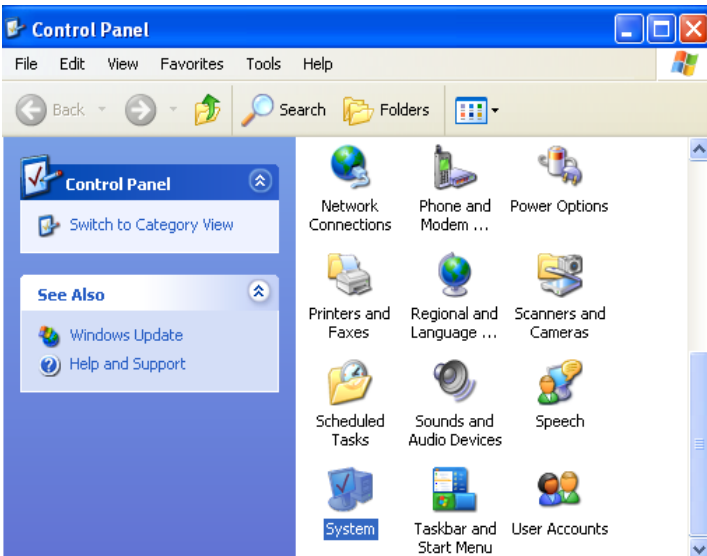

Step 2. Choose “Hardware” and “Device Manager”, press “OK” button”

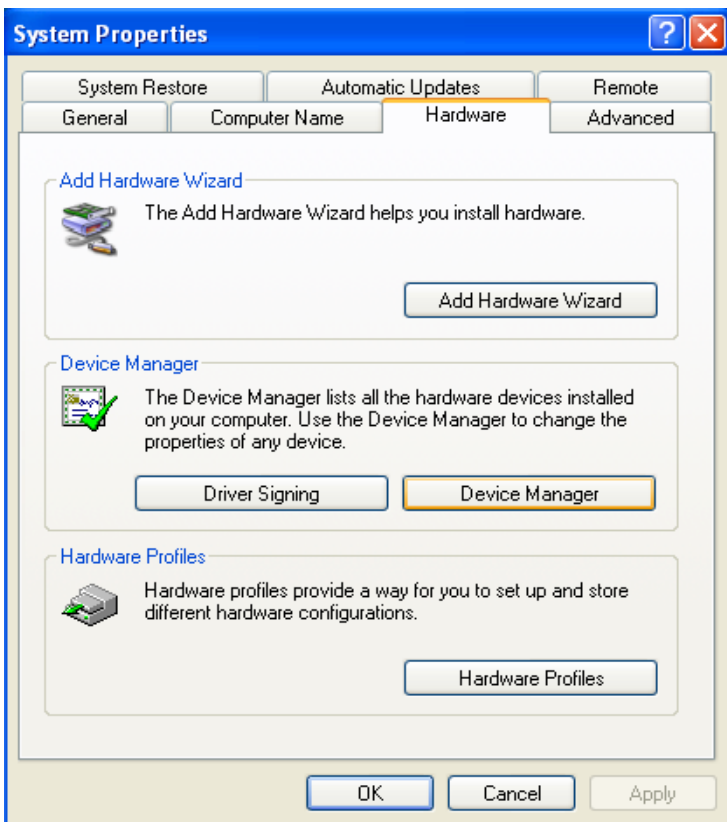

Step 3. Choose “Video Controller (VGA Compatible), press “OK” button

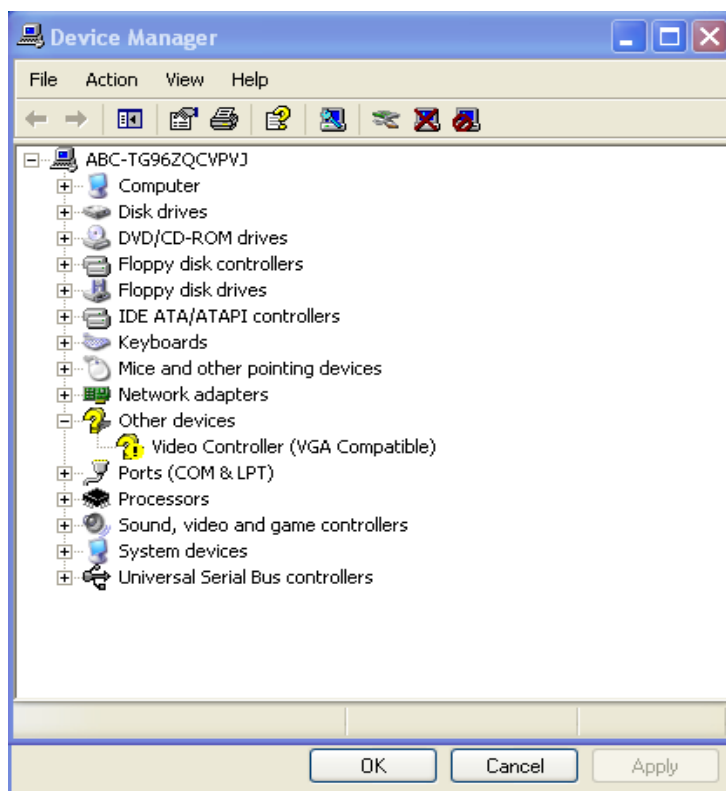

Step 4. Choose "Driver", "Update Driver", press "OK" button.

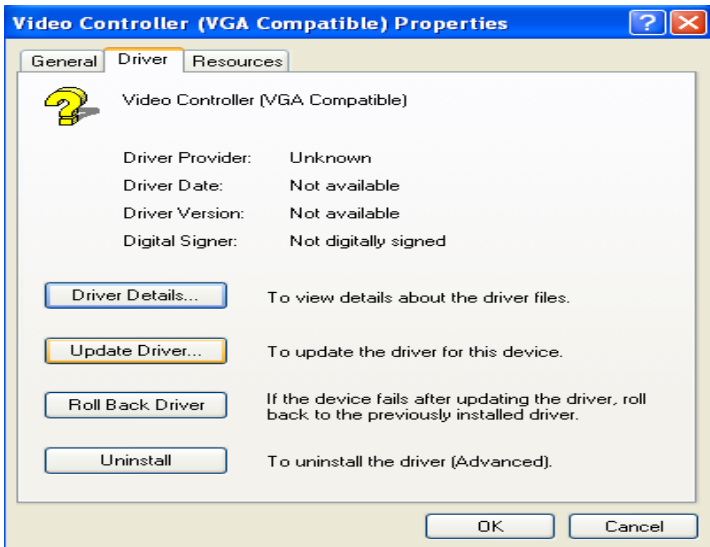

Step 5. Choose "Install from a list.....", press "Next"

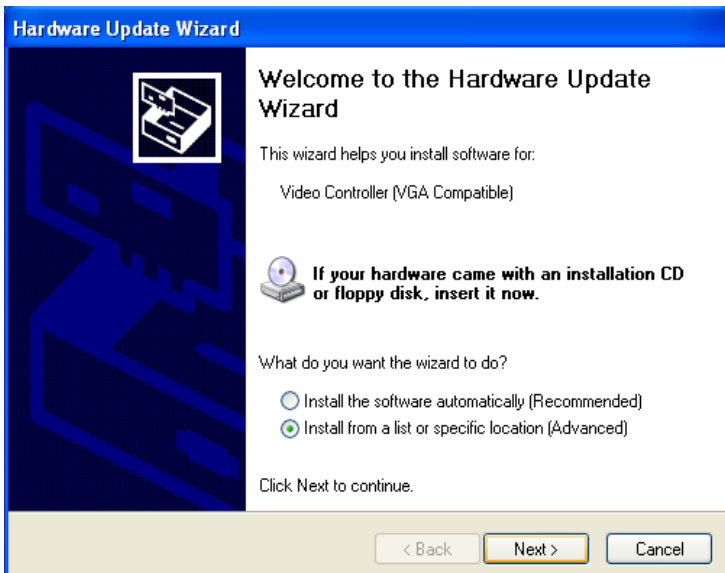

Step 6. Choose “Don’t search. I will...”, press “Next” button.

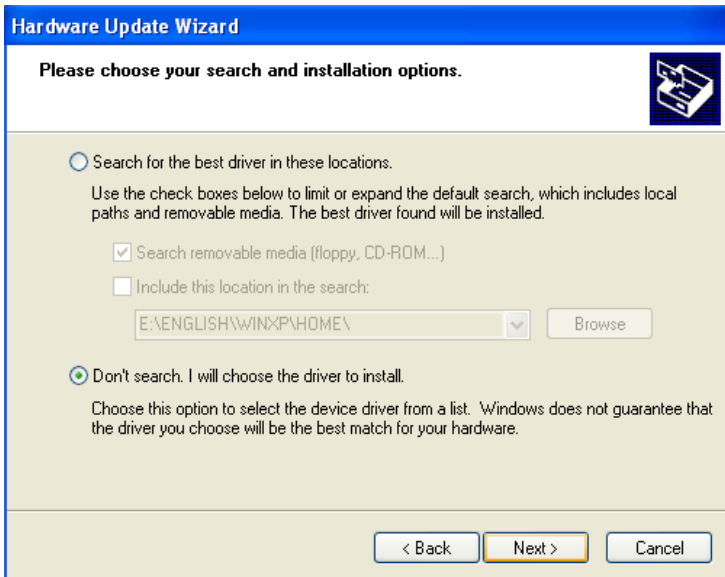

Step 7. Choose “Display adapters”, press “Next” button.

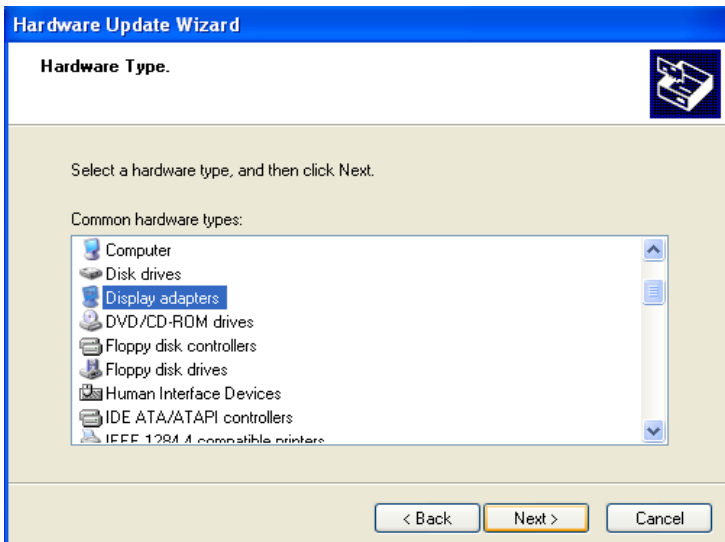

Step 8. Type the path D:\Biscuit\9577\VGA\WinXP then press “OK” button.

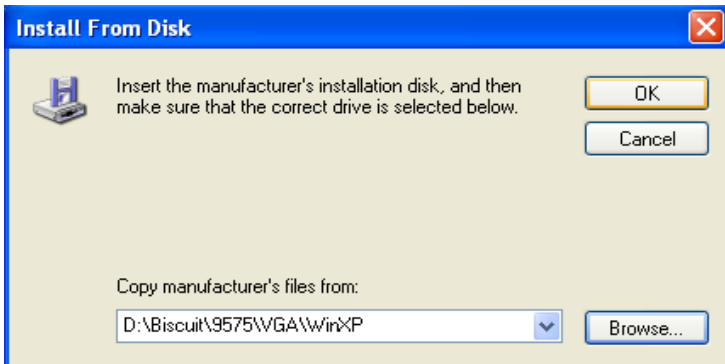

Step 9. Choose “S3 Graphics Twister + S3 Hotkey” then press “Next” button.

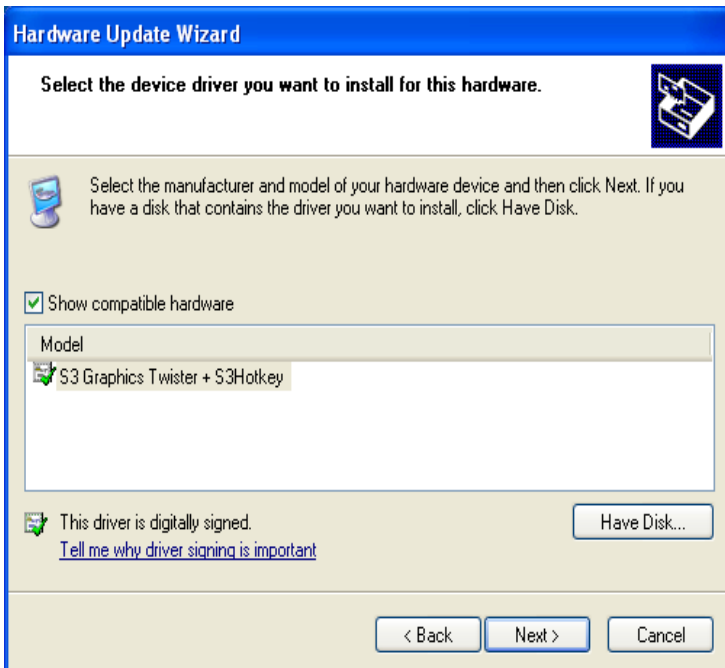

Step 10. Press "Finish" to reboot.

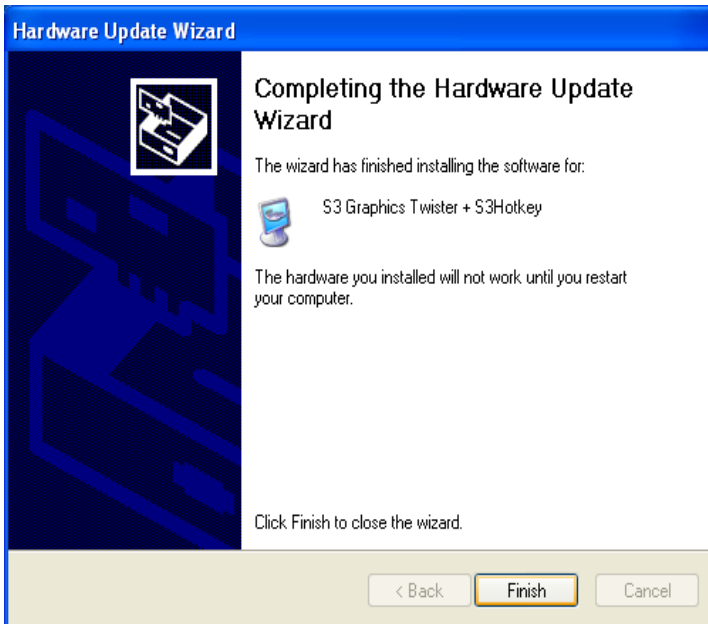

5.3 Further Information

For further information about the AGP/VGA installation in your PCI-6872, including driver updates, troubleshooting guides and FAQ lists, visit the following web resources:

VIA website: www.via.com.tw

Advantech websites: www.advantech.com
www.advantech.com.tw

PCI Bus Ethernet Interface

This chapter provides information on Ethernet configuration.

- Introduction
- Installation of Ethernet drivers for Windows 98/2000/NT
- Further information

Chapter 6 PCI Bus Ethernet Interface

6.1 Introduction

The board is equipped with a high performance 32-bit Ethernet chipset which is fully compliant with 802.3u 100BASE-T \Fast Ethernet CSMA/CD standards (F version) and compliant IEEE 802.3z/ab 1000BAS-T Gigabit Ethernet(FG version). It is supported by major network operating systems. It is also both 100Base-T and 10Base-T compatible.

The Ethernet port provides a standard RJ-45 jack. The network boot feature can be utilized by incorporating the boot ROM image files for the appropriate network operating system. The boot ROM BIOS files are combined with system BIOS, which can be enabled/disabled in the BIOS setup.

6.2 Installation of Ethernet driver

Before installing the Ethernet driver, note the procedures below. You must know which operating system you are using in your board Series, and then refer to the corresponding installation flow chart. Then just follow the steps described in the flow chart. You will quickly and successfully complete the installation, even if you are not familiar with instructions for MS-DOS or Windows.

Note: The windows illustrations in this chapter are examples only. Follow the steps and pay attention to the instructions which appear on your screen.

6.2.1 Installation for MS-DOS and Windows 3.1

If you want to set up your Ethernet connection under the MS-DOS or Windows 3.1 environment, you should first check your server system model. For example, MS-NT, IBM-LAN server, and so on.

Then choose the correct driver to install in your biscuit PC.

The installation procedures for various servers can be found on the supplied CD-ROM, the correct path being:

D:\Biscuit\9577\LAN\82559er\wfw311

6.2.2 Installation for Windows 98

1. a. Select "Start", "Settings", "Control Panel".
b. Double click "Network".



2. a. Click "Add" and prepare to install network functions.

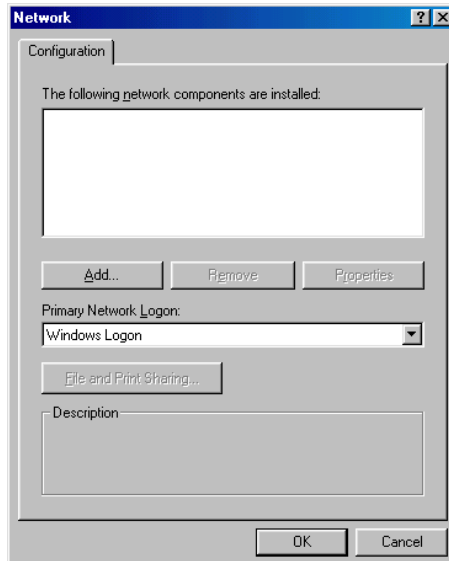

3. a. Select the "Adapter" item to add the Ethernet card.

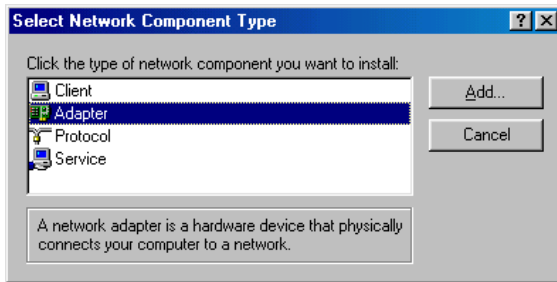

4. a. Click "Have Disk" to install the driver.

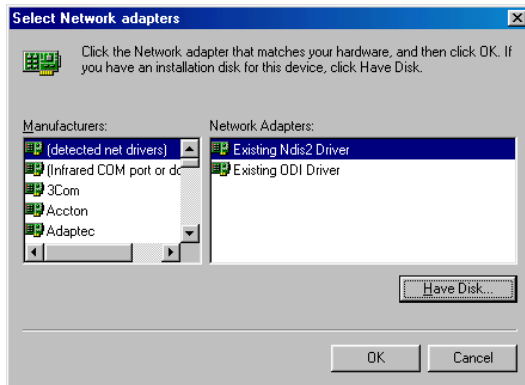

5. a. Insert the CD into the D: drive
b. Fill in "D:\Biscuit\9577\LAN\
c. Click "OK"

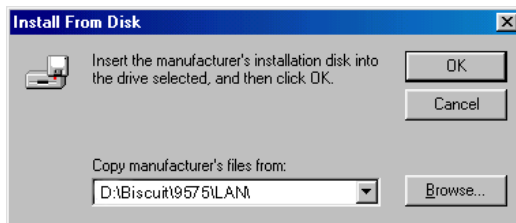

6.
 - a. Choose the " Intel 8255x based PCI Ethernet Adapter (10/100)"
 - b. Click "OK".

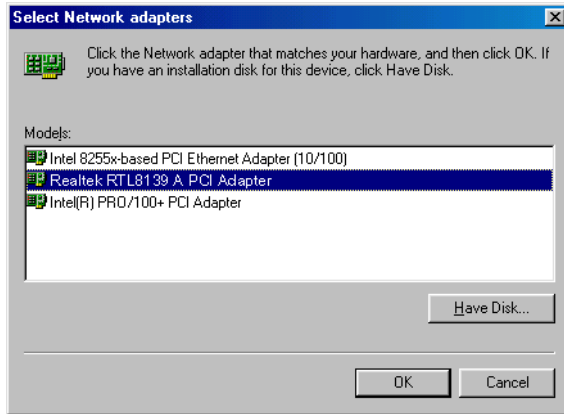

7.
 - a. Make sure the configurations of relative items are set correctly.
 - b. Click "OK" to reboot.

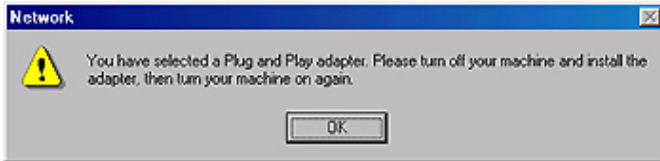

6.2.3 Installation for Windows 2000

1. Open Device Manager, right click “Ethernet Controller” and choose “properties.”

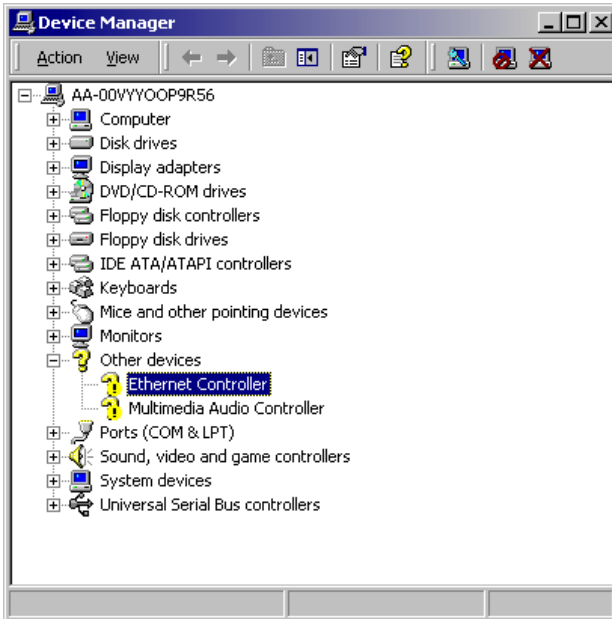

2. Choose the “Driver” tab ; press “Update Driver...”button



3. Choose “Display a list of.....,” then press “Next” button



4. Choose “Network adapters;” press “Next” button

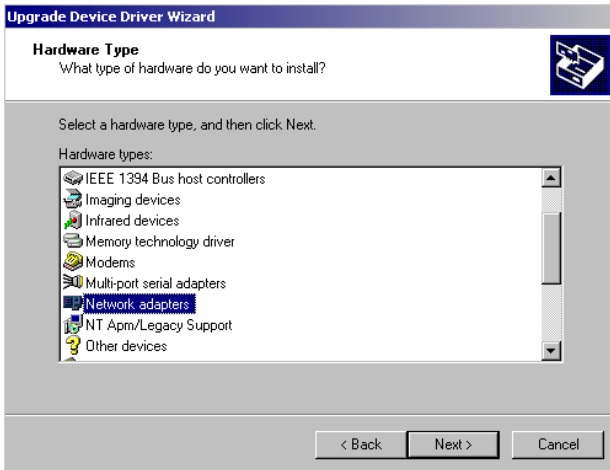

5. Click the “Have Disk” button

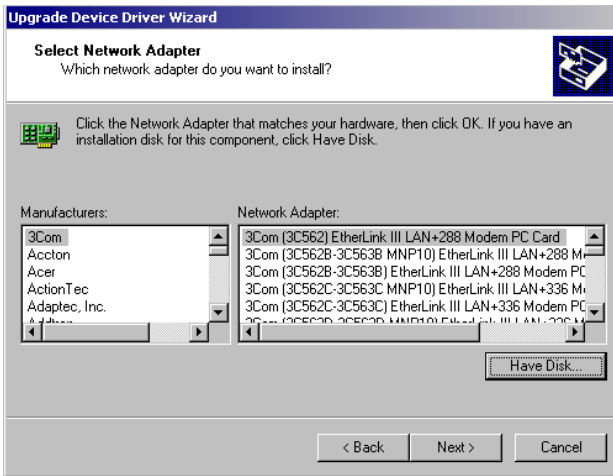

6. Type the path to the Windows 2000 LAN drivers on your driver CD, and press the “OK” button.

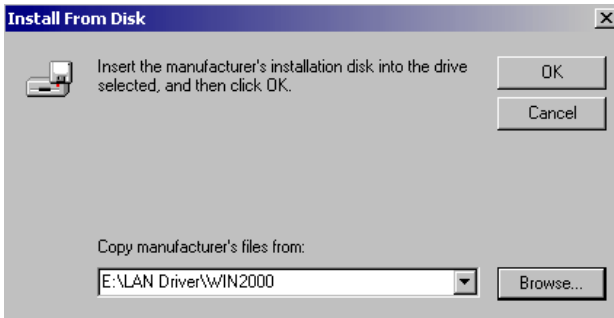

7. Select “Realtek RTL8139/810X Family PCI Fast Ethernet NIC,” and click “Next.”

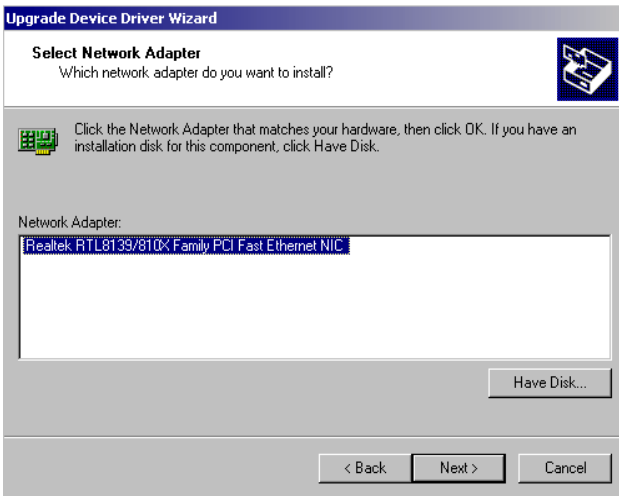

8. Press “Finish” to reboot.



9. In the System Setting Change window, click “Yes” to restart your computer.

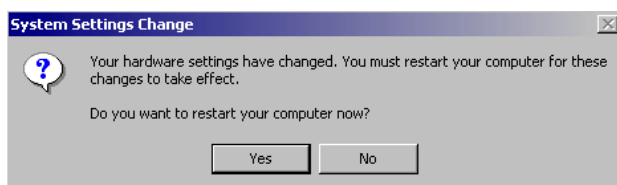

6.2.4 Installation for Windows NT

1. a. Select "Start", "Settings", "Control Panel"
b. Double click "Network"

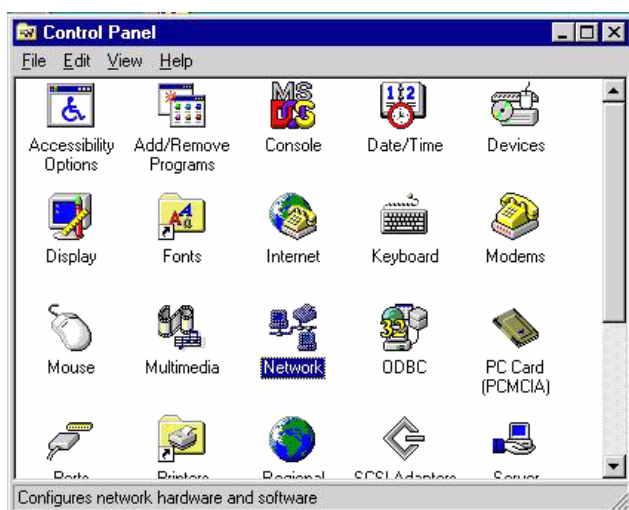

2. a. Choose type of network.
b. Click "Next"

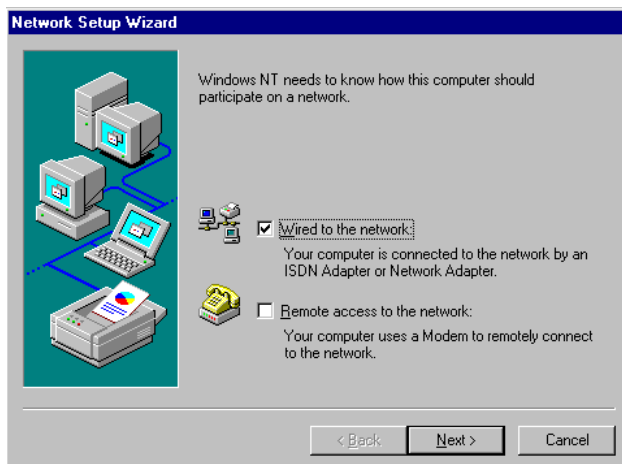

3. a. Click "Select from list..."

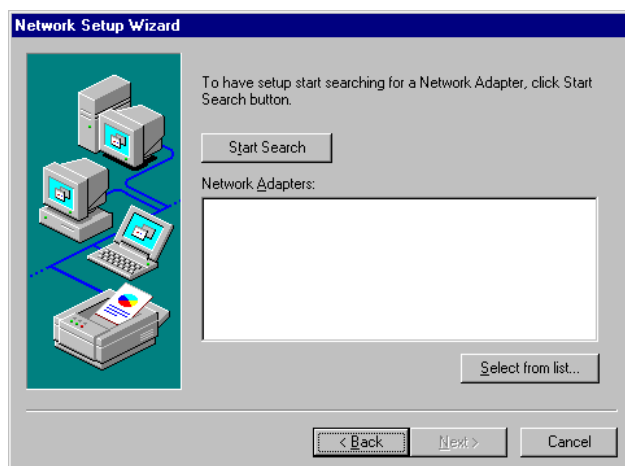

4. Click "Have Disk."

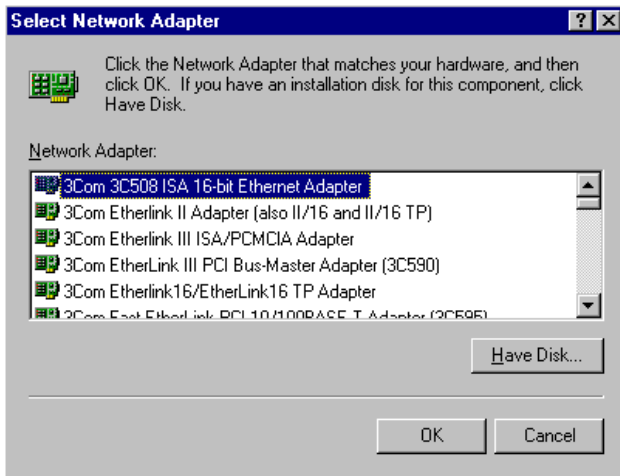

5. a. Insert the Utility CD ROM
b. Fill in the correct path: D:\Biscuit\9577\LAN\82559er\winnt4
c. Click "OK".

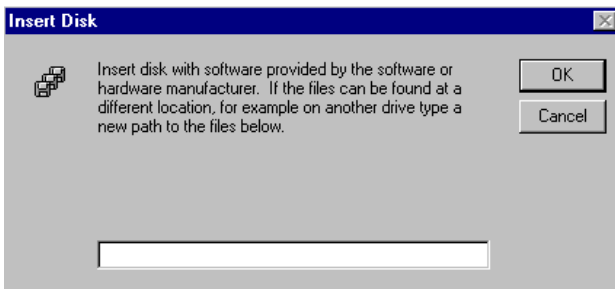

6. Check the highlighted item, and click “OK.”

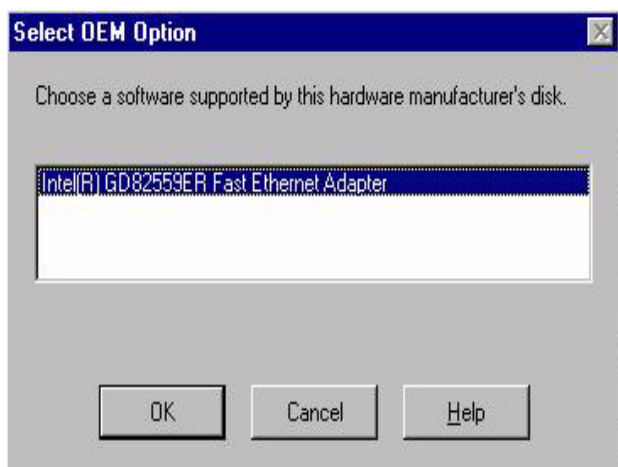

7. Click “Next” to continue setup.

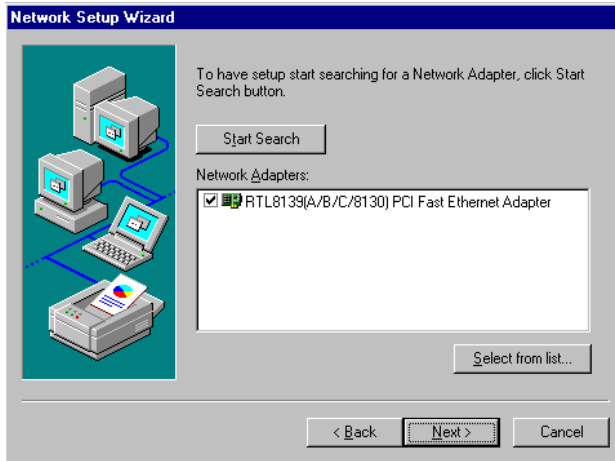

8. Choose the networking protocols, then click "Next"

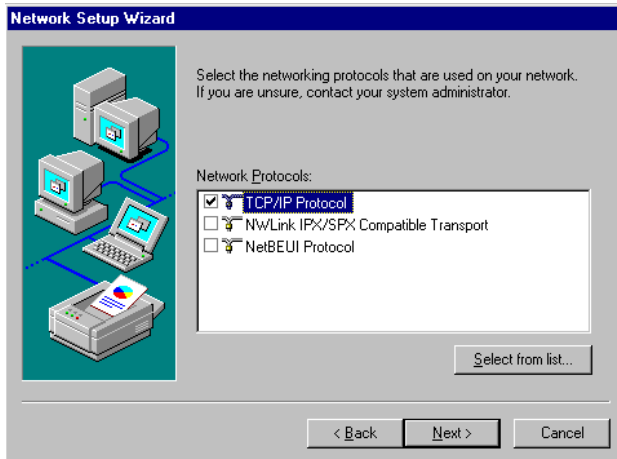

9. Select the correct Network Services then click "Next"

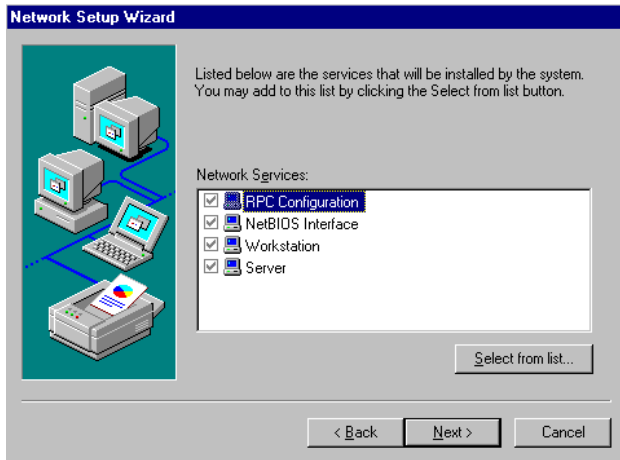

10. Click "Next" to continue setup.

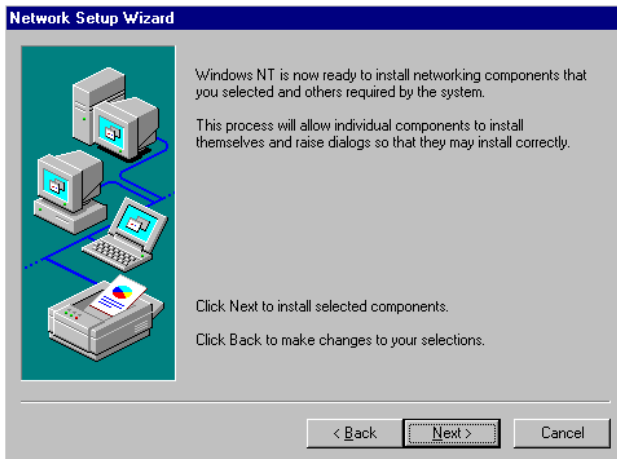

11. Click “Next” to start the network.

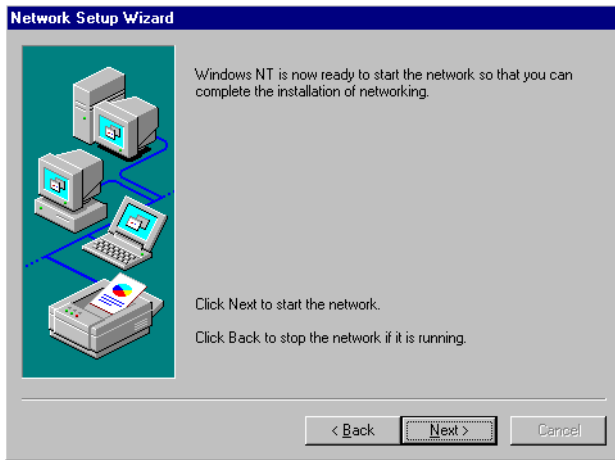

6.3 Further information

Realtek website:	www.realtek.com.tw
Intel website:	www.intel.com
Advantech websites:	www.advantech.com www.advantech.com.tw

Programming the Watchdog Timer

The board is equipped with a watchdog timer that resets the CPU or generates an interrupt if processing comes to a standstill for any reason. This feature ensures system reliability in industrial standalone or unmanned environments.

Appendix A Programming the Watchdog Timer

A.1 Supported Input Timing Modes

In order to program the watchdog timer, you must write a program which writes I/O port address 443 (hex). The output data is a value of time interval. The value range is from 01 (hex) to 3E (hex), and the related time interval is 1 sec. to 62 sec.

Data	Time Interval
01	1 sec.
02	2 sec.
03	3 sec.
04	4 sec.
.	.
.	.
.	.
3E	62 sec.

After data entry, your program must refresh the watchdog timer by rewriting the I/O port 443 (hex) while simultaneously setting it. When you want to disable the watchdog timer, your program should read I/O port 443 (hex).

The following example shows how you might program the watchdog timer in BASIC:

```
10 REM Watchdog timer example program
20 OUT &H443, data REM Start and restart the
   watchdog
30 GOSUB 1000 REM Your application task #1
40 OUT &H443, data REM Reset the timer
50 GOSUB 2000 REM Your application task #2
60 OUT &H443, data REM Reset the timer
70 X=INP (&H443) REM Disable the watchdog timer
80 END

1000 REM Subroutine #1, your application task
.
.
.
```

```
1070  RETURN
2000  REM  Subroutine #2, your application task
      .
      .
      .
2090  RETURN
```

Pin Assignments

This appendix contains information of a detailed or specialized nature. It includes

- Suspend 5V and ATX PS_ON
- Parallel Port Connector
- Floppy Drive Connector
- Primary IDE Connector
- CRT Display Connector
- USB Connector
- LAN RJ45 Connector
- Main Power Connector
- Power & HDD LED
- Flat Panel Connector
- Extensin Flat Panel Connector
- LVDS LCD Connector
- LCD Inverter Backlight Connector
- Panel back-light VR connector
- External KB/mouse connector
- Reset Button Connector
- Keyboard and PS/2 Mouse Connector
- CPU Fan Power Connector
- COM Port Connector
- ATX soft power switch Connector
- Daughter card Connector
- Compact Flash card Connector

Appendix B Pin Assignments

B.1 ATX power feature connector(CN20)



Table B.1: ATX power feature connector (CN20)

Pin	Signal
1	ATX PS_ON signal output
2	GND
3	Suspend 5V input

B.2 Parallel Port Connector(CN4)

Table B.2: Parallel Port connector (CN4)

Pin	Signal	Pin	signal
1	STB	2	AFD*
3	D0	4	ERR
5	D1	6	INIT*
7	D2	8	SLIN*
9	D3	10	GND
11	D4	12	GND
13	D5	14	GND
15	D6	16	GND
17	D7	18	GND
19	ACK*	20	GND
21	BUSY	22	GND
23	PE	24	GND
25	SLCT	26	GND

*low active

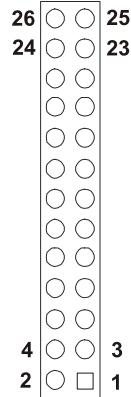

B.3 Floppy Disk Drive Disk connector (CN3)

Table B.3: Floppy Disk Drive Connector (CN3)

Pin	Signal	Pin	Signal
1	VCC	2	INDEX
3	VCC	4	DRIVE SELECTA
5	VCC	6	DISKE IE CHANGE
7	VCC	8	NC
9	NC	10	MOTOR A ON
11	NC	12	DIRECTION SELECT
13	NC	14	STEP
15	NC	16	WRITE DATA
17	GND	18	WRITE GATE
19	GND	20	TRACK 00
21	GND	22	WRITE PROTECT
23	GND	24	READ DATA
25	GND	26	HEAD SELECT

B.4 IDE Hard Drive Connector (CN1,CN2)

Table B.4: IDE HDD connector (CN1,CN2)

Pin	Signal	Pin	Signal
1	IDE RESET	2	GND
3	D7	4	D8
5	D6	6	D9
7	D5	8	D10
9	D4	10	D11
11	D3	12	D12
13	D2	14	D13
15	D1	16	D14
17	D0	18	D15
19	GND	20	NC
21	REQ	22	GND
23	IOW	24	GND
25	IOR	26	GND
27	READY	28	GND
29	DACK	30	GND
31	IRQ14	32	IOCS16#
33	A1	34	Cable check
35	A0	36	A2
37	CS0	38	CS1
39	Active LED	40	GND

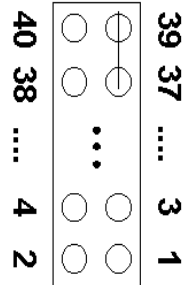

B.5 CompactFlash card connector (CN5)

Table B.5: CompactFlash Card Connector(CN5)

Pin	Signal	Pin	Signal
1	GND	26	#CD1
2	D3	27	D11
3	D4	28	D12
4	D5	29	D23
5	D6	30	D14
6	D7	31	D15
7	#CE	32	#CE2
8	A10	33	#VS14
9	#OE	34	#IORD
10	A9	35	#IOWR
11	A8	36	#WE
12	A7	37	#IRQ
13	Vcc	38	Vcc
14	A6	39	#CSEL
15	A5	40	#VS2
16	A4	41	RESET
17	A3	42	#WAIT
18	A2	43	#INPACK
19	A1	44	#REG
20	A0	45	BVD2
21	D0	46	BVD1
22	D1	47	D8
23	D2	48	D9
24	IOCS16	49	D10
25	#CD2	50	GND

B.6 CRT Display Connector (CN7)

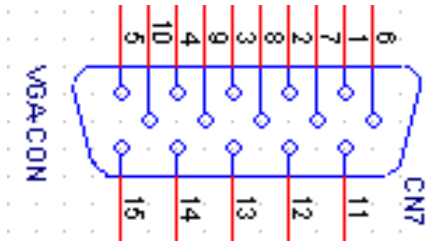

Table B.6: CRT Display Connector (CN7)

Pin	Signal	Pin	Signal
1	RED	9	CRT Vcc
2	GREEN	10	GND
3	BLUE	11	NC
4	NC	12	DDCDATA
5	GND	13	HSYNC
6	GND	14	VSYNC
7	GND	15	DDCCLOCK
8	GND		

B.7 USB Connector (CN6)

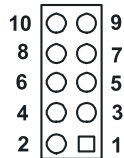

Table B.7: USB Connector (CN6)

Pin	Signal	Pin	Signal
1	+5V	6	+5V
2	DATA0-	7	DATA1-
3	DATA0+	8	DATA1+
4	USB GND	9	USB GND
5	Chassis GND	10	N/C

B.8 LAN, RJ45 Connector (CN8)

Table B.8: LAN, RJ45 Connector (CN8)

Pin	Signal
1	TX+
2	TX-
3	RX+
4	GND
5	GND
6	RX-
7	GND
8	GND
9	GND
10	GND

B.9 Main Power Connector (CN15)

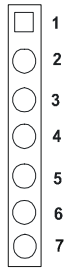

Table B.9: Main Power Connector(CN15)

Pin	Signal
1	+5V input
2	GND
3	GND
4	+12V input
5	NC
6	GND
7	+5V input

B.10 ATX power LED and KB-Lock connector (CN16)

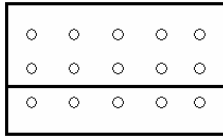

Table B.10: ATX Power LED and KB-Lock Connector(CN16)

Pin	Signal
1	Power LED+
2	NC
3	Power LED-
4	KB_LOCK+
5	KB_LOCK-(GND)

B.11 Speaker Out (CN17)

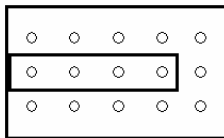

Table B.11: Speaker Out(CN17)

Pin	Signal
1	Vcc
2	NC
3	Internal Buzzer
4	Speaker Signal

B.12 Watchdog output connector (CN18)

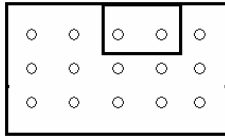

Table B.12: Watchdog Output Connector(CN18)

Pin	Signal
1	WDT_OUT
2	GND

B.13 HDD LED (CN19)

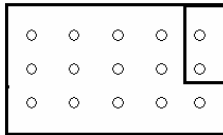

Table B.13: HDD LED(CN19)

Pi	Signal
1	HDD LED+
2	HDD LED-

B.14 PowerButton (CN21)

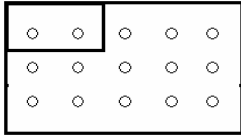

Table B.14: Power Button(CN21)

Pin	Signal
1	POWER ON
2	GND

B.15 Flat Panel Connector (CN22)

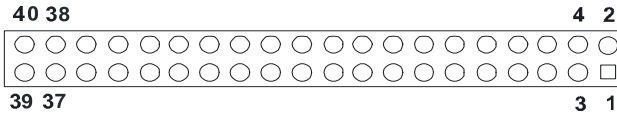

Table B.15: Flat Panel Connector(CN22)

Pin	Signal	Pin	Signal
1	+5V output	2	+5V output
3	GND	4	GND
5	+3.3V output	6	+3.3V output
7	NC	8	GND
9	PD0 signal output	10	PD1 signal output
11	PD2 signal output	12	PD3 signal output
13	PD4 signal output	14	PD5 signal output
15	PD6 signal output	16	PD7 signal output
17	PD8 signal output	18	PD9 signal output
19	PD10 signal output	20	PD11 signal output
21	PD12 signal output	22	PD13 signal output
23	PD14 signal output	24	PD15 signal output
25	PD16 signal output	26	PD17 signal output
27	PD18 signal output	28	PD19 signal output
29	PD20 signal output	30	PD21 signal output
31	PD22 signal output	32	PD23 signal output
33	GND	34	GND
35	FPCLK signal output	36	FLM
37	M	38	LP
39	ENABKL	40	ENVEE signal

Note: The model number of the CN22 socket is DF13A-40DP-1.25V(Hirose Electric Co., Ltd)

B.16 Extension flat panel connector (CN23)

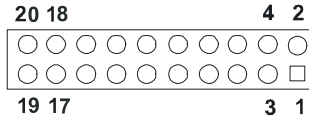

Table B.16: Extension Flat Panel Connector(CN23)

Pin	Signal	Pin	Signal
1	GND	2	GND
3	PD24	4	PD25
5	PD26	6	PD27
7	PD28	8	PD29
9	PD30	10	PD31
11	PD32	12	PD33
13	PD34	14	PD35
15	GND	16	GND
17	NC	18	NC
19	NC	20	NC

B.17 LVDS LCD connector (CN25)

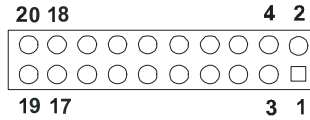

Table B.17: LVDS LCD Connector(CN25)

Pin	Signal	Pin	Signal
1	GND	2	GND
3	YP0	4	ZP0
5	YM0	6	ZM0
7	YP1	8	ZP1
9	ZM1	10	ZM1
11	YP2	12	ZP2
13	ZM2	14	ZM2
15	YCP	16	ZCP
17	YCM	18	ZCM
19	3V_SAFE	20	3V_SAFE

B.18 COM Connector (CN9, CN10, CN29)

Table B.18: COM connector (CN9, CN10, CN29)

COM1 connector (CN9)				COM2connector (CN10) RS232 Only			
Pin	Signal	Pin	Signal	Pin	Signal	Pin	Signal
1	DCD	6	DSR	1	DCD	2	DSR
2	RX	7	RTS	3	RX	4	RTS
3	TX	8	CTS	5	TX	6	CTS
4	DTR	9	RI	7	DTR	8	RI
5	GND			9	GND	10	NC

B.19 COM2 Extension connector RS422-RS485(CN29)

Table B.19: COM2 Extension Connector RS422-RS485(CN29)

Pin	Signal	Pin	Signal
1	TXD-	2	TXD+
3	RXD-	4	RXD+

B.20 LCD Inverter Backlight Connector (CN24)

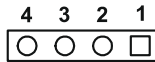

Table B.20: LCD Inverter Backlight Connector(CN24)

Pin	Signal
1	+12V output
2	GND
3	Back-light enable signal output
4	NC

B.21 Keyboard and PS/2 Mouse Connector (CN11)

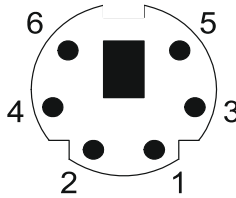

Table B.21: Keyboard and mouse connector (CN11)

Pin	Signal
1	KB data
2	Mouse DATA
3	Ground
4	+5V
5	KB CLOCK
6	MS CLOCK
7	NC
8	NC

B.22 CPU Fan Power connector(CN14)



Table B.22: FAN connector (CN14)

Pin	Signal
1	GND
2	+12V
3	Fan speed detect signal input

B.23 External KB/Mouse connector (CN12)

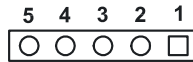

Table B.23: External KB/Mouse Connector(CN12)

Pin	Signal
1	Keyboard Clock
2	keyboard Data
3	NC
4	GND
5	+5V

B.24 I/O daughter board connector1(CN27)

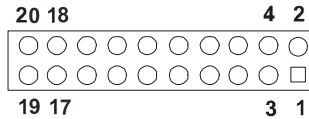

Table B.24: I/O Daughter Board Connector1(CN27)

Pin	Signal	Pin	Signal
1	USBD3+	2	USBD2+
3	USBD3-	4	USBD32
5	USBV2	6	USBV2
7	GND	8	GND
9	USBD1+	10	USB0+
11	USB1-	12	USB0-
13	USBV0	14	USBV0
15	GND	16	GND
17	3V3B	18	LAN2 ACTLED+
19	LAN2 ACTLED-	20	LAN SPLED

B.25 I/O daughter board connector1 (CN28)

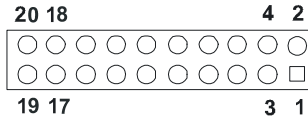

Table B.25: I/O Daughter Board Connector1(CN28)

Pin	Signal	Pin	Signal
1	NC	2	NC
3	NC	4	NC
5	NC	6	NC
7	NC	8	NC
9	NC	10	NC
11	NC	12	NC
13	LAN2 TD+	14	GND
15	LAN2 RD+	16	LAN2 TD-
17	3V3B	18	LAN2 RD-
19	MSCLK	20	Vcc

Appendix **D**

System Assignments

This appendix contains information of a detailed nature. It includes:

- System I/O ports
- 1st MB memory map
- DMA channel assignments
- Interrupt assignments

Appendix D System Assignments

D.1 System I/O Ports

Table D.1: System I/O ports

Addr. range (Hex)	Device
00-1F	Master DMA controller
20-3F	Master Interrupt controller
40-5F	Timer/Counter
60-6F	Keyboard controller
(60h)	KBC Data
(61h)	Misc Functions & Spkr Ctrl
(64h)	KBC Command/Status
70-77	RTC/CMOS/NMI-Disable
78-7F	-available for system use-
80	-reserved-(debug port)
81-8F	DMA Page Registers
90-91	-available for system use-
92	System Control
93-9F	-available for system use-
A0-BF	Slave Interrupt Controller
C0-DF	Slave DMA Controller
E0-FF	-available for system use-
100-CF7	-available for system use*
CF8-CFB	PCI Configuration Address
CFC-CFF	PCI Configuration Data
D00-FFFF	-available for system use-
200-20F	Game Port
2F8-2FF	COM2
378-37F	Parallel Port(Standard & AFF)
3F0-3F1	Configuration Index/Data
3F0-3F7	Floppy Controller
3F8-3FF	COM1
778-77A	Parallel Port(ECP Extensions)(Port 378+400)

MPU-401 select from 300 ~ 330H (2 bytes)

D.2 1st MB memory map

Table D.2: 1st MB memory map

Addr. range (Hex)	Device
F0000h - FFFFFh	System ROM
*CC000h - EFFFFh	Unused (reserved for Ethernet ROM)
C0000h - CBFFFh	Expansion ROM (for VGA BIOS)
B8000h - BFFFFh	CGA/EGA/VGA text
B0000h - B7FFFh	Unused
A0000h - AFFFFh	EGA/VGA graphics
00000h - 9FFFFh	Base memory

* If Ethernet boot ROM is disabled (Ethernet ROM occupies about 16 KB)

* E0000 - EFFFF is reserved for BIOS POST

D.3 DMA channel assignments

Table D.3: DMA channel assignments

Channel	Function
0	Available
1	Available (audio)
2	Floppy disk (8-bit transfer)
3	Available (parallel port)
4	Cascade for DMA controller 1
5	Available
6	Available
7	Available

* Audio DMA select 1, 3, or 5

** Parallel port DMA select 1 (LPT2) or 3 (LPT1)

D.4 Interrupt assignments

Table D.4: Interrupt assignments

Interrupt#	Interrupt source
IRQ 0	Interval timer
IRQ 1	Keyboard
IRQ 2	Interrupt from controller 2 (cascade)
IRQ 3	COM2
IRQ 4	COM1
IRQ 5	Unused
IRQ 6	FDD
IRQ 7	LPT1
IRQ 8	RTC
IRQ 9	Reserved (audio)
IRQ 10	Unused
IRQ 11	Reserved for watchdog timer
IRQ 12	PS/2 mouse
IRQ 13	INT from co-processor
IRQ 14	Primary IDE
IRQ 15	Secondary IDE for CFC

* Ethernet interface IRQ select: 9, 11, 15

* PNP audio IRQ select: 9, 11, 15

* PNP USB IRQ select: 9, 11, 15

* PNP ACPI IRQ select: 9, 11, 15

Free Manuals Download Website

<http://myh66.com>

<http://usermanuals.us>

<http://www.somanuals.com>

<http://www.4manuals.cc>

<http://www.manual-lib.com>

<http://www.404manual.com>

<http://www.luxmanual.com>

<http://aubethermostatmanual.com>

Golf course search by state

<http://golfingnear.com>

Email search by domain

<http://emailbydomain.com>

Auto manuals search

<http://auto.somanuals.com>

TV manuals search

<http://tv.somanuals.com>