

Addonics TECHNOLOGIES

Multilane 4X RAID5/JBOD PCI-E 8x Controller ADSA3GPX8-ML

User's Guide

Overview

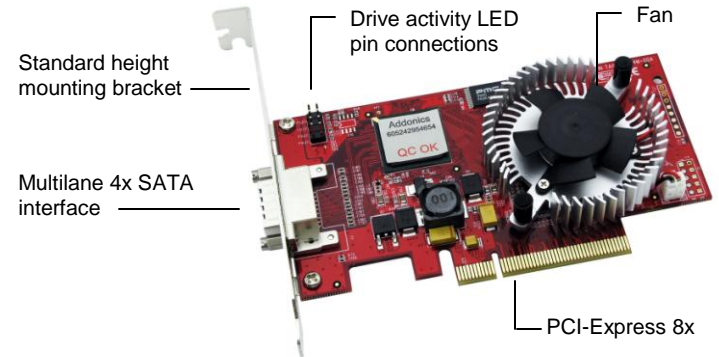

To switch between RAID and non-RAID mode

The controller card comes with jumper pins that would allow you to switch between RAID and non-RAID mode. The RAID mode means you can create RAID volumes using the SATARAID5 array manager. The non-RAID mode means you can only configure individual drives.

The RAID mode uses the SATARAID5 array manager and the raid driver version. The non-RAID mode uses the base driver.

Detailed View of J4

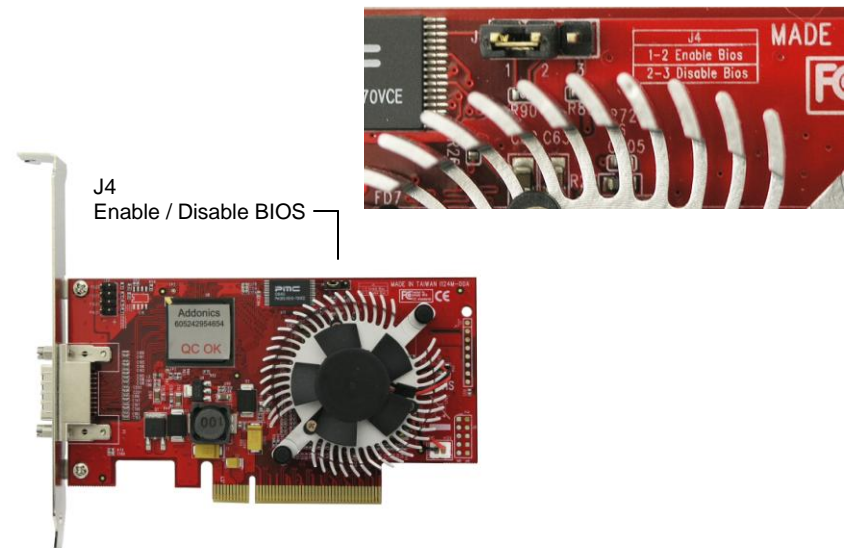

Windows Software Installation for RAID mode

Note: Install the SATA Utilities from the CD that came with your package first before installing the Host Controller.

- From the CD start-up menu select SATA RAID Utilities. Select Model #ADSA3GPX8-ML.
- Unzip the file on your drive.
- Click on the folder that matches your OS. Run the 3124-W-I32-R_version.msi.
- This will install the SATARAID5 Array Manager. This utility will allow you configure and monitor the status of the raid volume. It will also create and store the driver files of the controller card. The location of the driver files is C:\Program\Silicon Image\3124-W-I32-R SATARAID5\RAID Driver.

Hardware Installations:

- Power OFF PC and remove its cover.
- Select an empty PCI-E 8x slot and insert the SATA Controller.
- Makes sure to secure the bracket with a screw.
- Close the PC's cover.

Windows 2000, XP, 2003 server Driver Installations

- Turn computer ON. When Windows boots up, "A New Hardware Found" pops on the screen and the Addonics Serial ATA PCI Host Controller is identified.
- At the "Add New Hardware Wizard Window, click "Next"
- Choose "Install from a list or specific location", and click "Next"
- Select "Don't Search. I will choose the driver to install" and click "Next".
- Click "Have Disk" then Browse the location "C:\Program\Silicon Image\3124-W-I32-R SATARAID5\RAID Driver."
- If using a driver that has not been digitally signed by Microsoft, you will be asked if you want to continue the installation. Click Continue.
- When the new hardware wizard has finish installing the Serial ATA card. Click "Finish" to complete the installations.

Confirming Serial ATA Driver Installation

- Right click the My Computer icon and select properties.
- Click Device Manager in the Menu Tree.
- Click the "+" sign in front of SCSI controllers. Silicon Image SATA controller should appear.

Important Note:

- To do a RAID SET, you can press F4 or CTRL+S from the boot up screen. Read and follow the instruction inside the BIOS screen.
- You can also install the SATA GUI utility Under Windows to monitor the RAID Set. It is under the Utility section of the driver disc.

Installing ADSA3GPX8-ML under Mac OSX.

Below are the instructions to install drivers for Mac OSX compatible SATA controllers which support RAID 0, 1, 10, 5, and JBOD. An internet connection may be required to download the latest drivers from the Addonics website.

1. Physically install the controller into the Apple computer.

PCI-Express RAID controllers can only be installed onto Mac Pro systems. PCI-Express RAID controllers have not been thoroughly tested under the final model of PowerMac G5 and are not guaranteed to be compatible.

To verify that your PCI-Express controller has been correctly installed and is recognized by the system, Enter *Applications -> Utilities -> System Profiler* and click on "PCI Cards" from the selection menu at the left. A generic *pci-bridge* card should be displayed on the slot where you physically installed the controller.

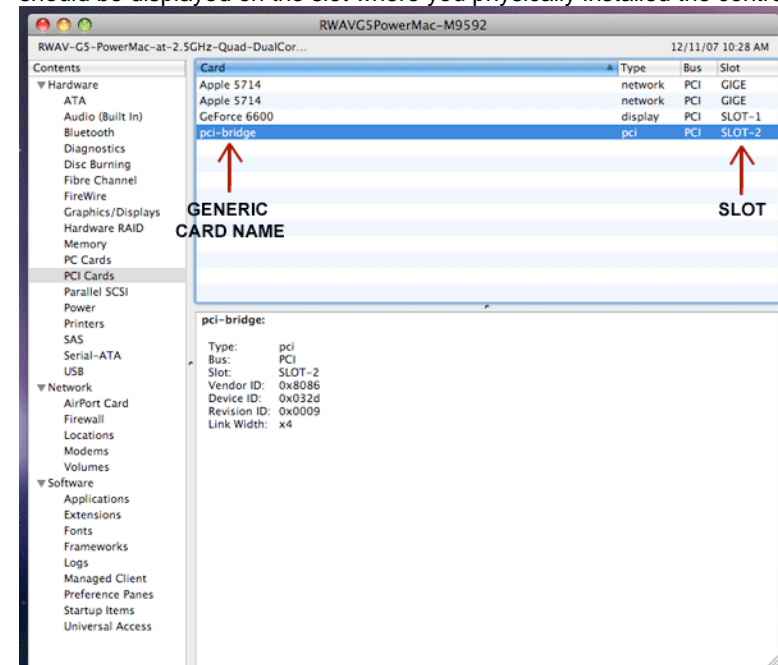

- Download the latest drivers for your controller from the Addonics web site.

3. Locate the downloaded driver and extract the contents. Double click on the extracted installer to begin the installation process.

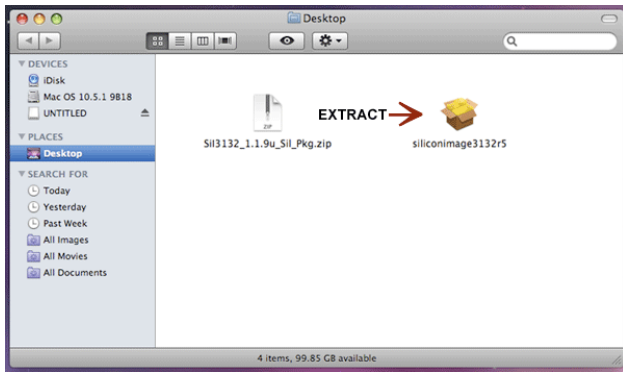

4. Continue through the installation process, entering in your desired settings.

When the installation process is finished, the RAID controller driver and RAID software have been installed.

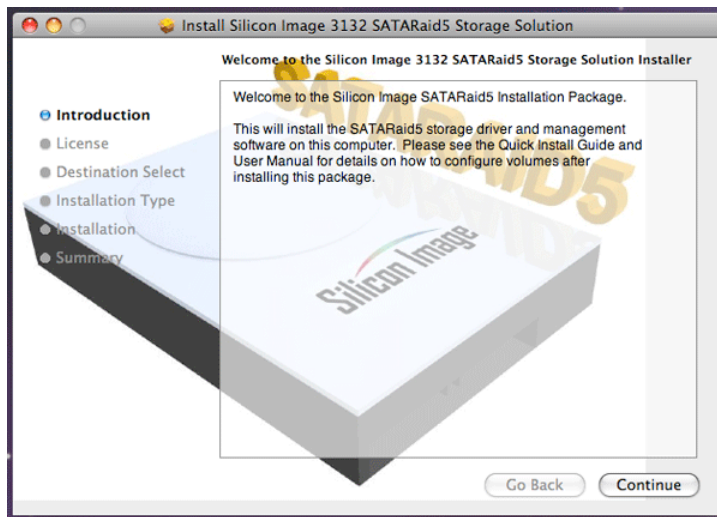

5. Return to **Applications -> Utilities -> System Profiler** and check the "PCI Cards" list to see if the controller drivers have been correctly installed.

A correctly installed PCI-Express RAID controller will display as: *pci1095,7124* for RAID controllers based on the Sil3124 chipset with RAID firmware

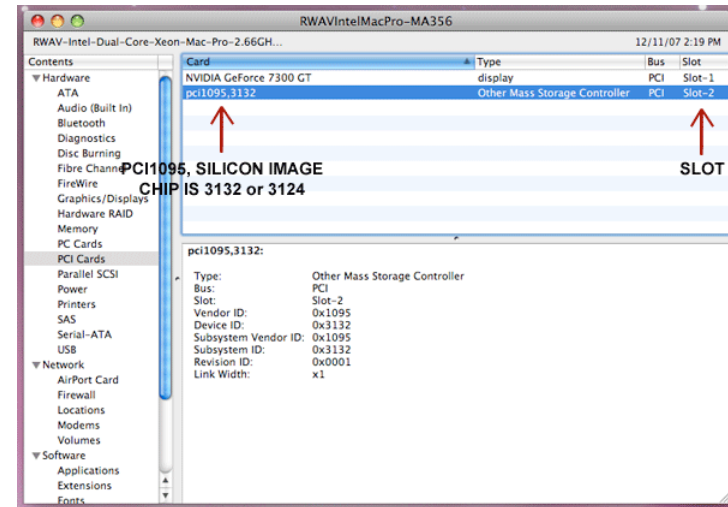

6. The Silicon Image SATAraid5 Manager has been installed at the same time as the controller driver.

A. The new folder containing the SATAraid5 Manager can be accessed from **Applications -> Utilities -> Silicon Image**.

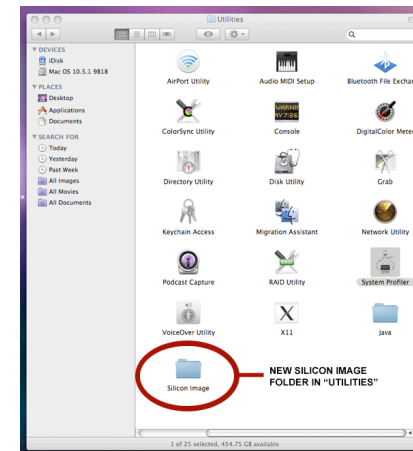

5. Return to **Applications -> Utilities -> System Profiler** and check the "PCI Cards" list to see if the controller drivers have been correctly installed.

B. Within this folder, click on "SATAraid5Manager" to execute the RAID creation and management utility.



C. For detailed instructions on creating and managing RAID volumes, read the [SATAraid5 Manager User Manual](#).

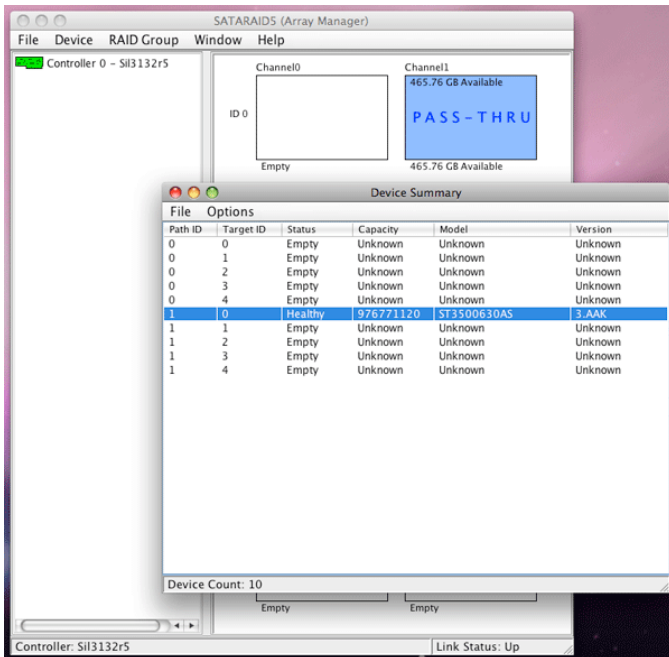

Technical Support

If you need assistance to get your unit functioning properly, please call Addonics Technical Support. Our technical staff will be happy to assist you, but they will need your help to do so. Calling the technical support staff without all the proper information can be both time consuming and frustrating. Here are some tips to help you out:

Contact Information

Phone: 408-573-8580
Fax: 408-573-8588
Email: <http://www.addonics.com/sales/query/>
Internet: <http://www.addonics.com>

TECHNICAL SUPPORT

Phone: 408-453-6212
Hours: 8:30 am - 6:00 pm PST
Email: <http://www.addonics.com/support/query/>

Free Manuals Download Website

<http://myh66.com>

<http://usermanuals.us>

<http://www.somanuals.com>

<http://www.4manuals.cc>

<http://www.manual-lib.com>

<http://www.404manual.com>

<http://www.luxmanual.com>

<http://aubethermostatmanual.com>

Golf course search by state

<http://golfingnear.com>

Email search by domain

<http://emailbydomain.com>

Auto manuals search

<http://auto.somanuals.com>

TV manuals search

<http://tv.somanuals.com>