

## HD-DV Camcorder

## Welcome:

Dear user, thanks for purchasing this product.

Much investment in time and effort has gone into its development, and it is our hope that it will give you many years of trouble-free service.

## Safety Notice:

1. Do not drop, puncture or disassemble the camera; otherwise the warranty will be voided.
2. Avoid all contact with water, and dry hands before using.
3. Do not expose the camera to high temperature or leave it in direct sunlight. Doing so may damage the camera.
4. Use the camera with care. Avoid pressing hard on the camera body.
5. For your own safety, avoid using the camera when there is a storm or lightning.
6. Do not use batteries of different specifications. Doing so may lead to the potential for serious damage.
7. Remove the battery during long periods between usage, as a deteriorated battery may affect the functionality of the camera.
8. Remove the battery if it shows signs of leaking or distortion.
9. Use only the accessories supplied by the manufacturer.
10. Keep the camera out of the reach of infants.

## FCC Compliance Statement:

This device complies with Part 15 of the FCC Rules. Operation is subjected to the following two conditions: (1) this device may not cause harmful interference, and (2) this device must accept any interference received, including interference that may cause undesired operation.



This equipment has been tested and found to comply with limits for a Class B digital device, pursuant to Part 15 of the FCC rules. These limits are designed to provide reasonable protection against harmful interference in residential installations. This equipment generates, uses, and can radiate radio frequency energy, and if not installed and used in accordance with the instructions, may cause harmful interference to radio communications.

However, there is no guarantee that interference will not occur in a particular installation. If this equipment does cause interference to radio or television equipment reception, which can be determined by turning the equipment off and on, the user is encouraged to try to correct the interference by one or more of the following measures:

- Reorient or relocate the receiving antenna.
- Move the equipment away from the receiver.
- Plug the equipment into an outlet on a circuit different from that to which the receiver is connected.
- Consult the dealer or an experienced radio/television technician for additional suggestions.

You are cautioned that any change or modifications to the equipment not expressly approved by the party responsible for compliance could void Your authority to operate such equipment.



Do not throw the appliance away with the normal household waste at the end of its life, but hand it in at an official collection point for recycling. By doing this you will help to preserve the environment.

# Table of Contents

<b>Getting Started.....</b>	<b>1</b>
Knowing your camcorder parts.....	1
Installing the battery.....	2
Charging the battery.....	2
Inserting a memory card (optional).....	3
Turning on/off your camcorder.....	3
Setting language.....	4
Setting time.....	4
Reading LCD indicators.....	5
<b>Basic Operations .....</b>	<b>6</b>
Recording a video clip.....	6
Taking a still picture.....	7
Playing back your recordings.....	8
Playing back your recordings on PC.....	9
Connecting the camcorder to TV.....	10
<b>Advanced Operations .....</b>	<b>12</b>
Menu operation.....	12
Menu items in Camera mode.....	12
Menu items in Playback mode.....	13
Menu items in Setting mode.....	14
Battery Life Indicator.....	15
Battery Life.....	16
Storage Capacity.....	16
Specifications.....	17
System Requirements.....	18

# Getting Started

## ● Knowing your camcorder parts

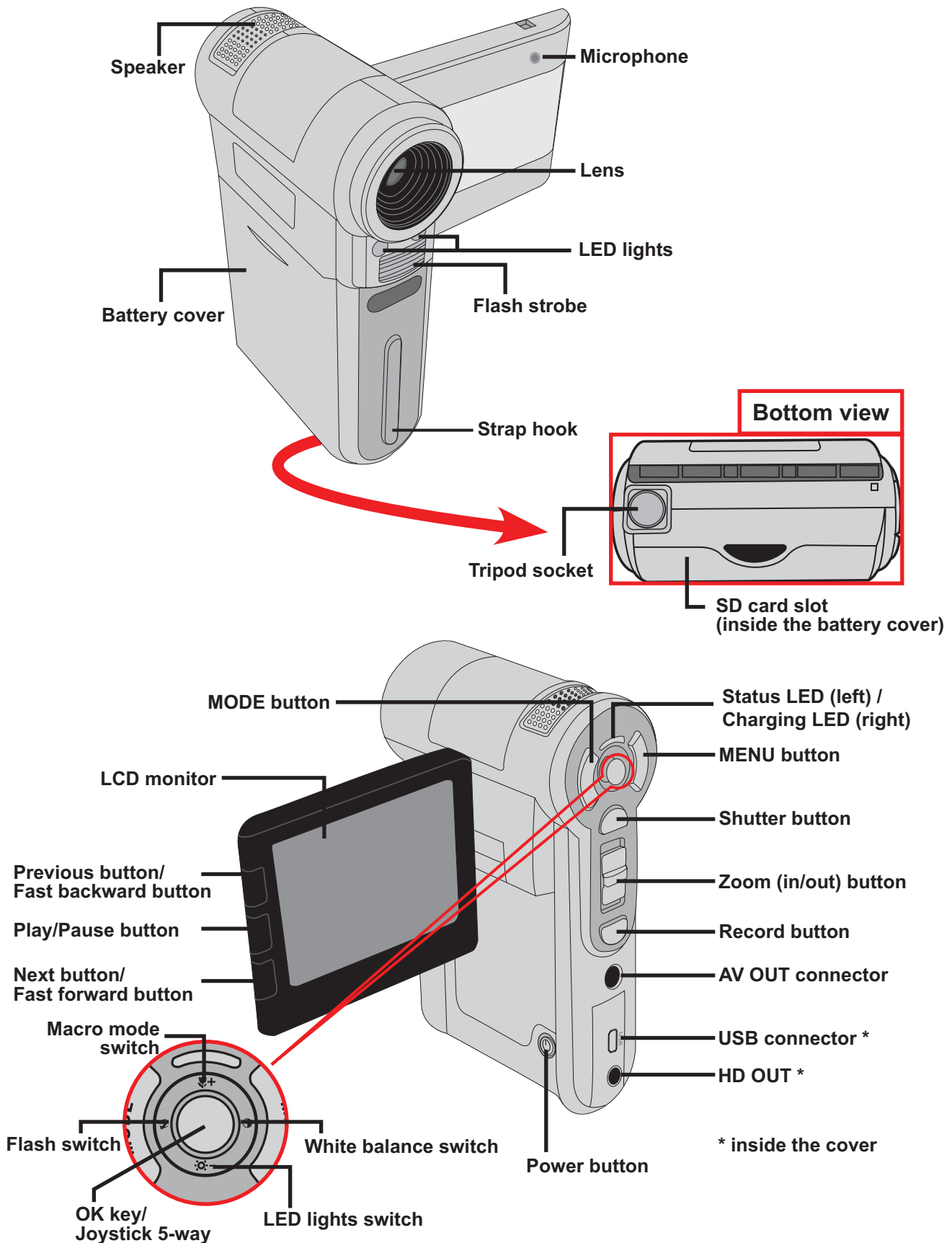

## ● Installing the battery

1. Slide the battery cover open as indicated.
2. Place the accessory Li-Ion battery into the compartment. Note that the metallic contacts must be aligned with the contacts in the compartment.
3. After the battery is properly installed, replace the battery cover.

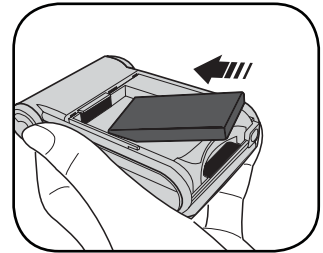

## ● Charging the battery

Please charge the battery at least 8 hours for first time use.

1. Connect the cable.  
Connect one end of the supplied AC adapter to the USB port of the camcorder and the other end to a wall outlet.

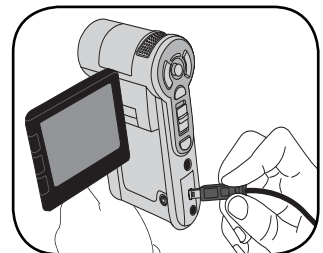

OR

Connect one end of the supplied USB cable to the USB port of the camcorder and the other end to a powered PC. Make sure the camcorder is powered off.

2. The charging LED turns red and the charge starts.
3. When the charging is interrupted or the battery pack is fully charged, the charging LED will turn green.

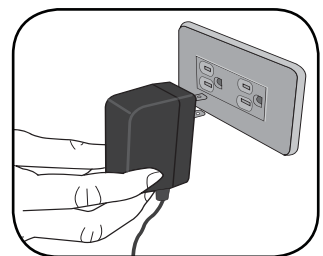

**OR**

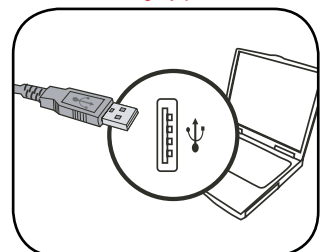

⚠ When using a PC to charge the battery, do not power on the camcorder, or the charge will stop.

## ● Inserting a memory card (optional)

To insert a memory card, do the followings:

- (1) Open the battery cover.
- (2) Gently push the card as indicated until the card reaches the bottom of the slot.

To remove the memory card, gently push the card and it will pop up. Then pull the card out of the slot.

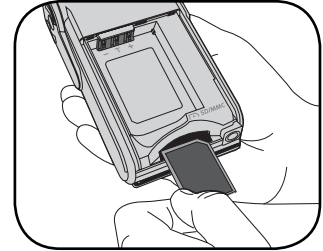

## ● Turning on/off your camcorder

Open the LCD monitor or press and hold down the Power button for 1 second to turn on the camcorder.

To turn off the camcorder, press and hold down the Power button for 1 ~ 3 seconds or close the LCD monitor.

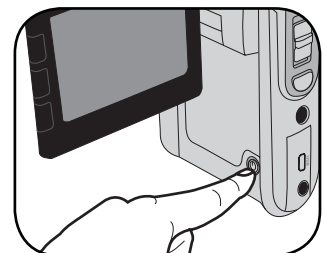
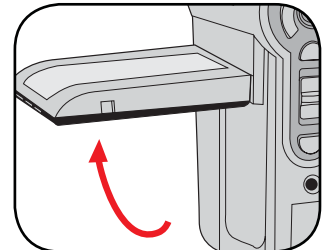

- ❗ If the camcorder is not turned on after pressing the Power button, please check:
  1. The battery pack is well installed in the camcorder.
  2. The battery pack has enough power left.
- ❗ If the camcorder stays inactive for a long period of time, it may automatically shut down due to the Auto-Off setting.

## ● Setting language

1. Power on the camcorder.
2. Press the **MODE** key to enter the **MODE** menu.
3. Use the **Joystick** switch to select the **Setting** mode and press **OK** to enter the menu screen.
4. Use the **Joystick** to select the **Language** item, and then Press **OK** to confirm.
5. Move the **Joystick** up/down to select a language.
6. When done, press **OK** to confirm the setting.



## ● Setting time

1. Power on the camcorder.
2. Press the **MODE** key to enter the **MODE** menu.
3. Use the **Joystick** switch to the **Setting** mode and press **OK** to enter the menu screen.
4. Use the **Joystick** to select the **Date & Time** item, and then Press **OK** to confirm.
5. Move the **Joystick** up/down to adjust value. Move the **Joystick** left/right to shift between fields.
6. When done, press **OK** to confirm the setting.

## ● Reading LCD indicators

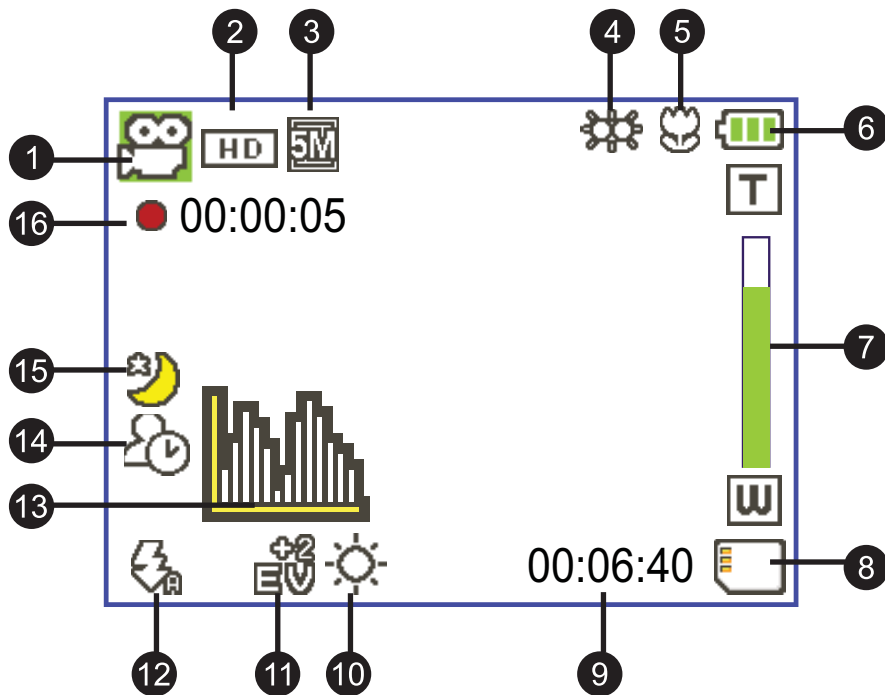

- |                        |                             |
|------------------------|-----------------------------|
| ① Mode icon            | ⑨ Remaining recordable time |
| ② Video resolution     | ⑩ While Balance mode        |
| ③ Picture resolution   | ⑪ Exposure mode             |
| ④ LED lights mode      | ⑫ Flash mode                |
| ⑤ Macro mode           | ⑬ Histogram mode            |
| ⑥ Battery life         | ⑭ Selftimer mode            |
| ⑦ Zoom ratio indicator | ⑮ NightShot mode            |
| ⑧ SD card inserted     | ⑯ Recording time            |

- ❗ The LCD will display 16:9 ratio while setting as HD (720P) video resolution.
- ❗ The LCD will display 4:3 ratio while setting as D1 (480P) or CIF video resolution. (Please refer to the page 7 for more detailed instructions.)



# Basic Operations

## ● Recording a video clip

### 1. Adjust the focus:

Normally the camcorder can auto focus without adjusting focus. If you want to take close-up pictures, you can push the Up button to switch to Macro mode (🌸).

**Note: Please make sure your memory is inserted before recording.**

-	30cm ~ ∞ (12" ~ ∞)
🌸	5cm ~ 30cm (2" ~ 12") * At 1.5X fixed zoom

### 2. Zooming:

Move the **Zoom** button up or down to zoom in or zoom out the screen. The optical magnification is 3X.

### 3. Press the **Record** button to start recording.

### 4. Press the **Record** button again to stop recording.

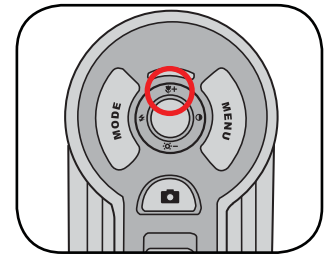

Zoom in

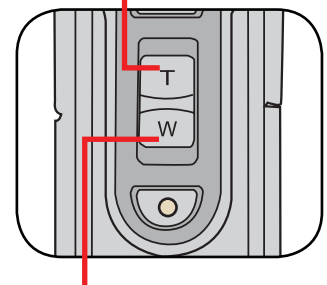

Zoom out

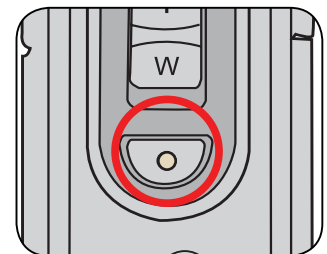

- ❗ The zoom function is also available during recording (except in macro mode).
- ❗ If the surroundings are dark, you can switch the LED lights mode to On or Auto to help focus and lighting.
- ❗ It's normal that the camcorder will feel slightly warm with continuous use / recording due to its high performance.

# ● Taking a still picture

## 1. Adjust the focus:

Normally the camcorder can auto focus without adjusting focus. If you want to take close-up pictures, you can push the Up button to switch to Macro mode (  ).

**Note: Please make sure your memory is inserted before recording.**

-	30cm ~ ∞ (12" ~ ∞)
	5cm ~ 30cm (2" ~ 12") * At 1.5X fixed zoom

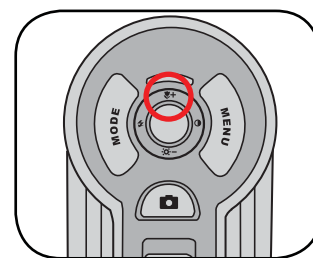

Zoom in

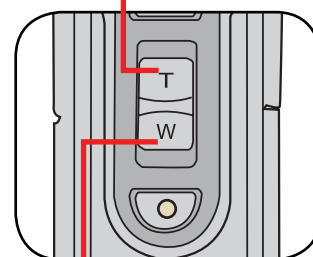

Zoom out

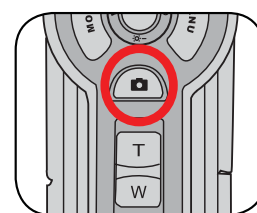

## 2. Zooming:

Move the **Zoom** button up or down to zoom in or zoom out the screen. The optical magnification is

- ❗ Adjust other advanced settings if necessary.
- ❗ If the surroundings are dark, you can switch the LED lights mode to On or Auto to help focus and lighting.

3. Press the **Shutter** button half way down and hold for the camcorder to auto focus. When the focus frame turns green, press the button fully down to take a still picture.

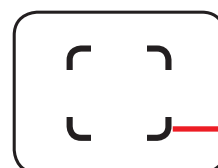

focus frame

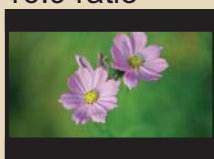
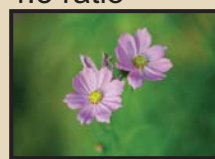
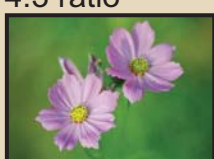
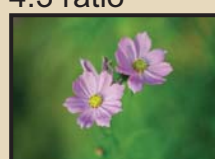

❗ Due to the sensor capture feature, the LCD preview and ratio of still picture capture will vary depending upon different video resolution settings. The image capture of the camera is set where as video resolutions are different.

Video resolution	Preview	Taking pictures and focusing
HD(1280x720)	16:9 ratio 	4:3 ratio 
D1(720x480)	4:3 ratio 	4:3 ratio 
CIF(352x288)		

# ● Playing back your recordings

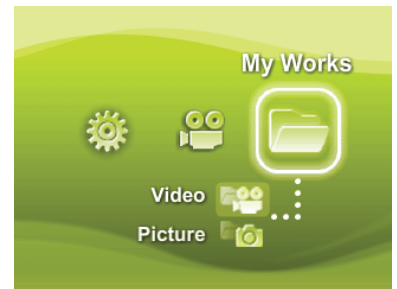
1. Press the **MODE** button and use the **Joystick** to switch to “**My Works**” mode.  
Or press the **Play/Pause** button ( **▶** ) on the left side of the LCD monitor.
2. There are two folders below **My works: Video** and **Picture**. Select Video or Picture, and then press the **OK** key to enter the index mode.
3. Operations in playback mode:

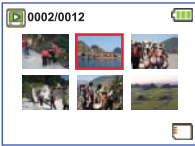

File type	How to...	Action
Index mode 	Shift between Index mode and Full-screen mode	In Index mode, press the <b>OK</b> key to switch to Full-screen mode. In Full-screen mode, press the <b>MENU</b> button to switch to Index mode.
Full-screen mode 	Shift between files	1. In Index mode: Use the <b>Joystick</b> to move the highlight box. 2. In Full-screen mode: Use the <b>Joystick</b> to move left or right.
Video	Start playing	When selected (in full-screen mode), the file automatically starts playing.
	Pause/Resume playing	During playing/While paused, press the <b>OK</b> key.
	Adjust the volume level	During playing, use the <b>Joystick</b> to move up or down.
	Stop playing	During playing, press the <b>MENU</b> button.
	Return to the preview screen	Press the <b>Shutter</b> button.
	Fast forward	During playing, press the <b>Next</b> ( <b>▶</b> ) button. To stop, press the <b>Play/Pause</b> ( <b>▶</b> ) button.
	Fast backward	During playing, press the <b>Previous</b> ( <b>◀</b> ) button. To stop, press the <b>Play/Pause</b> ( <b>▶</b> ) button.
	Select the next file	While paused/stopped, press the <b>Next</b> ( <b>▶</b> ) button.
Select the previous file	While paused/stopped, press the <b>Previous</b> ( <b>◀</b> ) button.	
Picture	Zoom in/out	Use the <b>Joystick</b> to move up or down.
	Lock/Release zoom ratio	When the zoom ratio is greater than 1.0x, press the <b>OK</b> key.
	Browse the enlarged picture	When the zoom ratio is locked, use the <b>Joystick</b> to browse the picture.

# ● Playing back your recordings on PC

## ▶ Installing software

Please notice that the recorded videos are .mov format. So you need some special programs to view the recordings on PC. For first time use, please make sure you have QuickTime 7.0 player on your PC. If not, Please follow the below instructions to install the software first.

Please download the QuickTime 7.0 player from the below website:  
<http://www.apple.com/quicktime/download/win.html>

**OR**

Please install the HD-DV DECODER program on the bundled CD.  
(\* HD-DV DECODER is designed for playing back the .mov files recorded by our camcorder with Windows Media Player 10 & 11.)

## ▶ Connecting PC and Save files

After the software is properly installed on your PC, please follow below procedures.

1. Turn on the camcorder.
2. Connect the camcorder (with SD card inserted) to your computer with the USB cable.
3. A dialogue window will appear automatically. Please select the item "**Open folder to view files**" and click "**OK**".
4. If the dialogue window does not appear automatically, you may double click on "My computer" and open the "Removable Drive".
5. Double-click on the **DCIM** file folder.
6. Double-click on the **100MEDIA** file folder.
7. Copy the files you wish to keep and save them to the desired location on your computer.

## ● Connecting the camcorder to TV

Please follow the below instructions to connect your camcorder and TV via accessory AV cables for real-time display. You can display your video clips and still pictures on your TV, sharing them with your friends and family.

### ▶ Connecting the camcorder to HDTV

HD TV hereby means the HDTV built-in component input ports, thus can perform HD (720P) high resolution quality while connected.

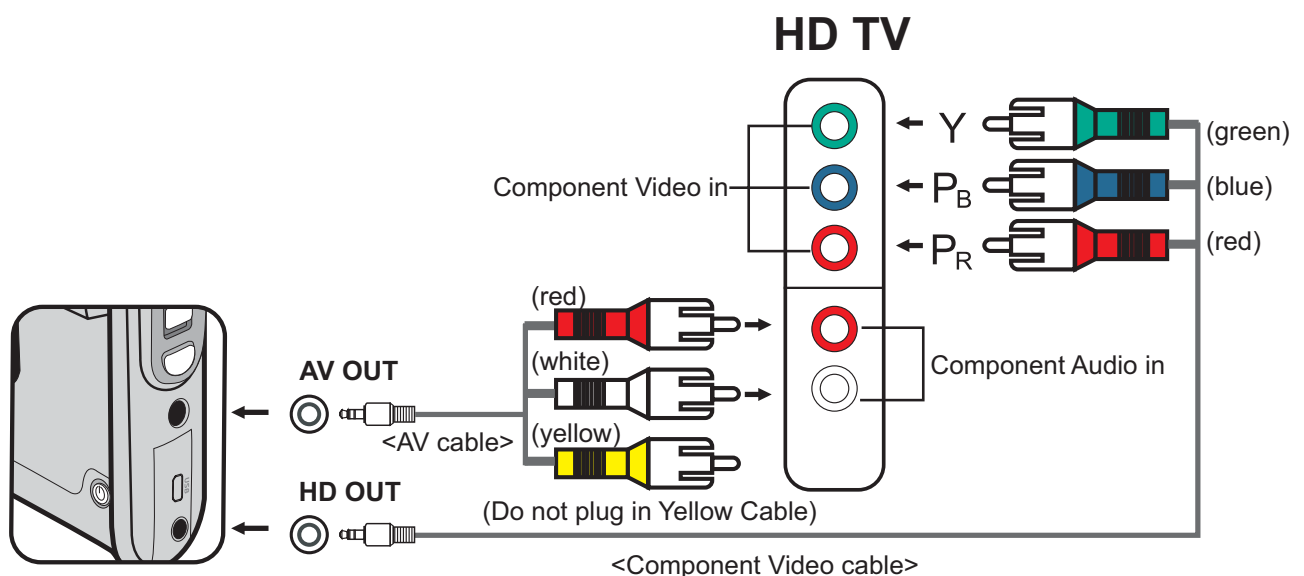

1. Turn on your HD TV.
2. Turn on the Camcorder.
3. Plug one end of the component video cable into the (Component Video IN) port on the HDTV and the other end into the (HD OUT) port on Camcorder.
4. Plug one end of the other AV cable into the (Component Audio IN) port on the HDTV and the other end into the (AV OUT) port on Camcorder. (Please do not plug in the yellow connector to HDTV's AV-IN.)
5. Press the input switch mode on HD TV and select "Component Input".

! If you record an HD resolution clip while connected to your HD TV, the TV display video resolution will down size to D1 (480P) resolution due to data bit rate, but the recorded file will remain HD (720P) with no change.

## ▶ Connecting the camcorder to Standard TV

TV = Traditional CRT TV

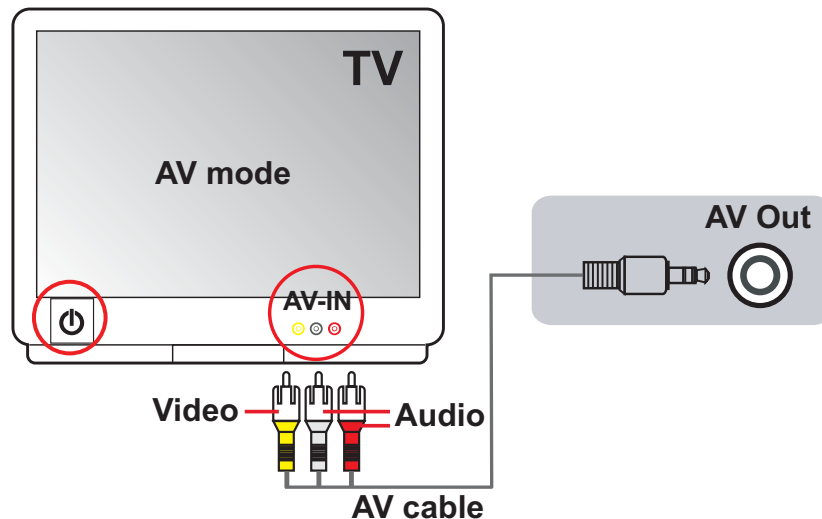

1. Power on the camcorder.
2. Press the **MODE** key to enter the Mode menu.
3. Use the Joystick switch to the **Setting** mode and press **OK** to enter the menu screen.
4. Use the **Joystick** to select the TV-out item, and then press **OK** to confirm.
5. Move the **Joystick** up/down to select NTSC or PAL.

⚠ NTSC or PAL system is different across countries, please refer to page 14 for the Flicker Setting table.

6. When done, press **OK** to confirm the setting.
7. Press the **Shutter** key to return to the preview screen.
8. Connect the audio and video ends of the AV cable (yellow/white/red color) to the TV “AV-IN” jacks.
9. Connect the other end of the AV cable to the “AV out” port on your camcorder.

# Advanced Operations

## ● Menu operation

The menu items provide several options for you to fine-tune your camera functions. The following table gives details on menu operations.

How to...	Action
Bring up the menu	Press the <b>MENU</b> button.
Move the highlight bar	Use the <b>Joystick</b> to move up or down.
Enter sub-menu/Confirm an item	Press the <b>OK</b> key.
Exit menu/Go back to upper menu	Press the <b>MENU</b> button (when in sub-menu).

## ● Menu items in Camera mode

Power-on → Press the **Menu** button.





Item	Option	Description
Video resolution	HD	Set the video resolution to HD (1280x720 pixels).
	D1	Set the video resolution to D1 (720x480 pixels).
	CIF	Set the video resolution to CIF (352x288 pixels).
Picture Resolution	3M	Set picture resolution to 3 mega pixels.
	5M	Set picture resolution to 5 mega pixels.
NightShot	On/Off	Enabling this setting allows you to take a photograph with a dark background. Since the shutter speed will slow down when taking photographs at a dark place, we recommend using a tripod to eliminate blurring from hand shake. <b>Warning: Noise increases when Night Shot is enabled.</b>
WB	Auto	The camera automatically adjusts white balance.
	Sunny	This setting is suitable for outdoor recording in sunny weather.
	Cloudy	This setting is suitable for recording in cloudy weather or shady environments.
	Fluorescent	This setting is suitable for indoor recording with fluorescent lamp lighting, or environments with high color temperature.
	Tungsten	This setting is suitable for indoor recording with incandescent lamp lighting, or environments with low color temperature.

## ● Menu items in Camera mode (continued)

Item	Option	Description
Flashlight	On	The flash is forced to fire in every shot.
	Auto	The flash automatically fires when the lighting is insufficient.
	Off	The flash is disabled.
Video light	On/Auto/Off	This setting allows you to add extra light when the lighting is insufficient during recording video clips.
Effect	Normal	Make recordings in natural color.
	B&W	Make recordings in black and white.
	Classic	Make recordings in sepia-toned color.
Exposure	-2~+2	Manually adjust the exposure to gain better effect when the preview image appears too bright or too dark. A positive value indicates the image will be brighter than usual; while a negative value makes the image dimmer.
Selftimer	On/Off	Enable/Disable the selftimer. After the selftimer is turned on, the camera will have ten seconds delay before recording when the Shutter button is pressed.
Histogram	On/Off	Enable/Disable image histogram display on the screen.
Icon	On/Off	Enable/Disable OSD (on screen display) icons to display on the screen.

## ● Menu items in Playback mode

Power-on → Press the **MODE** button → Use the Joystick to switch to **My Works** mode → Select **Video** or **Picture** folder → Press the **OK** button → Press the **MENU** button.

Item	Option	Description
 Delete One	Yes/No	Delete current file.
 Delete All	Yes/No	Delete all pictures and video/audio files stored in the memory.
 Slide Show	-	The camera displays images in sequence. Only JPEG pictures and the first frames of MPEG files will be displayed. You can press the Menu button to stop the slide show.
 Lock	Yes/No	Single, multiple, or all files can be locked. A locked file cannot be erased by a delete function. While the formatting function will erase all locked/unlocked files.

\* If there are no files in the camera, no items will be seen.



## ● Menu items in Setting mode

Power-on → Press the **MODE** button → Enter the **Setting** (  ) mode → Press the **MENU** button.





Item	Option	Description
Date & Time	-	Set date and time.
Beep	On/Off	Enable/Disable beep sound.
Flicker	50Hz	Set flicker frequency to 50Hz*.
	60Hz	Set flicker frequency to 60Hz*.
TV-out	HDTV	Set TV system compatibility to HDTV. This option is suitable for HDTV.
	NTSC	Set TV system compatibility to NTSC. This option is suitable for America, Taiwan, Japan, and Korea areas.
	PAL	Set TV system compatibility to PAL. This option is suitable for Germany, England, Italy, Netherlands, China, Japan, and Hong Kong.
Icon	On/Off	Enable/Disable OSD icons to display on the screen.
LCD Bright	-2~+2	Set LCD brightness. A positive value makes the LCD brighter; while a negative value makes the LCD dimmer.
Format	Yes	Format the storage medium. Note that all files stored in the medium will be gone.
	No	Cancel action.
Auto Off	Off	Disable Auto-off function.
	1 min	The camera automatically shuts down when staying inactive for over 1 minute.
	3 min	The camera automatically shuts down when staying inactive for over 3 minutes.
	5 min	The camera automatically shuts down when staying inactive for over 5 minutes.
Language	-	Lets you select the language used for OSD.
Default	Yes	Restore factory defaults. Note that your current settings will be overridden.
	No	Cancel action.

## ● Menu items in Setting mode (continued)

\* Flicker settings table:

<b>Region</b>	England	Germany	France	Italy	Spain	Netherlands	Russia
<b>Setting</b>	50Hz	50Hz	50Hz	50Hz	50Hz	50Hz	50Hz
<b>Region</b>	Portugal	America	Taiwan	China	Japan	Korea	Thailand
<b>Setting</b>	50Hz	60Hz	60Hz	50Hz	50/60Hz	60Hz	50Hz

## ● Battery Life Indicator

Icon	Description
	Full battery life
	Moderate battery life
	Low battery life * The flash strobe and the LED lights will be disabled."
	Empty battery life

**Note:** To avoid sudden outage of power supply, you are recommended to replace the battery when the icon indicates low battery life.

## ● Battery Life

Still picture	Video clip
Number of shots	Recording time (minute)
110	30
* shoot every 30 seconds ** flash is off *** resolution is set to 5M (2560x1920)	* resolution is set to HD (1280x720 pixels)

**Note:** This table is for your reference only. The actual battery life depends on your battery type and recharge level.

## ● Storage Capacity

Memory	Video (min.)			Still picture	
	HD	D1	CIF	3M	5M
SD card (256MB)	7	18	40	230	145
SD card (512MB)	15	36	80	460	290
SD card (1GB)	30	72	160	920	580
SD card (2GB)	60	144	320	1840	1160
SD card (4GB)	120	288	640	3680	2320

**Note:** The actual value of capacity may vary (up to  $\pm 30\%$ ) depending on the color saturation and complexity of your subject and surroundings.

## ● Specifications

Item	Description
Model	5 Mega-pixel camera
Image sensor	5 Mega (2592x1944 pixels)
Resolution	Still image: 3M/5M 1280x720 (HD) 720x480 (D1) 352x288 (CIF)
Lens	3X optical zoom lens
File format	MOV, JPEG
Video frame rate	1280x720, up to 30fps 720x480, up to 30fps 352x288, up to 30fps
External memory	SD (256MB ~ 4GB), speed rate 12X above
LCD display	2.4" LCD
TV out	Component out, NTSC/PAL system supported
Interface	USB 2.0
Microphone	Yes
Speaker	Yes
Night shot	Yes (both in still image and video modes)
Battery	NP60 compatible Li-ion rechargeable battery

**Note:** Specifications are subject to change without notification.

## ● System Requirements

System requirements are different in different video resolution settings:

Video Resolution	PC system requirements
HD (1280x720) @30fps	OS = Windows XP SP2 or above (QuickTime 7.0 or above) CPU = Pentium 4 3.0GHz or above System RAM = 512MB (1GB recommended) Display card = nvidia Geforece 7600 or ATI X1600 or above with 256MB of RAM
D1 (720x480) @30fps	OS = Windows 2000/XP or above (QuickTime 7.0 or above)
CIF (352x288) @30fps	CPU = Pentium 4 1.5GHz or above System RAM = 256MB (512MB or above recommended) Display card = 64MB (128MB or above recommended)

## Free Manuals Download Website

<http://myh66.com>

<http://usermanuals.us>

<http://www.somanuals.com>

<http://www.4manuals.cc>

<http://www.manual-lib.com>

<http://www.404manual.com>

<http://www.luxmanual.com>

<http://aubethermostatmanual.com>

Golf course search by state

<http://golfingnear.com>

Email search by domain

<http://emailbydomain.com>

Auto manuals search

<http://auto.somanuals.com>

TV manuals search

<http://tv.somanuals.com>