

TKS-CS

Compact Station for Connecting the Solar Inverter to Medium Voltage

EN



AEG Power Solutions GmbH, Warstein-Belecke

Department: PS AE

Revision: 01

Revision date: 15/10/2012 / Hagelstein

Released: 15/10/2012 / Songur

Document no.: 8000043213_BAL_en

AEG
POWER SOLUTIONS

Revision Service

Status	Revision	Date	Name
00		07/08/2012	Hagelstein
01	Corrections (pages 6, 15, 21)	15/10/2012	Hagelstein

Table of Contents

1	General Information	6
1.1	Validity	6
1.2	Appropriate Use	6
1.3	List of Abbreviations	6
2	Safety	7
2.1	Installation Location.....	7
2.2	Lightning Protection.....	7
3	Scope of Delivery	8
4	Equipment Specifications.....	9
4.1	Structure	9
4.2	Dimensions	10
4.3	Low-Voltage Box	10
4.3.1	AC Connections	11
4.3.2	ISO Small Distribution Box	12
4.3.3	Communications Cabinet PV LoG-MH	13
4.3.4	Central Earthing System	13
4.4	Medium-Voltage System	14
4.5	Transformer.....	15
5	Functional Description.....	16
6.	Transport	17
7	Assembly	18
7.1	Setting in Place	18
7.2	Installation.....	19
7.2.1	Low-Voltage Box	19
7.2.2	ISO Small Distribution Box	20
7.2.3	Communication Interface PV.LoG-MH.....	20
7.2.4	Central Earthing System	21
7.2.5	Medium-Voltage System	21
7.2.6	Medium-Voltage Transformer.....	22
7.3	Tightening Torques for Screw Connections.....	23
8	Start-up	24
9	Operation	24
10	Servicing.....	25
10.1	Obligation to Keep a Written Record	27
10.2	Maintenance and Inspection.....	28
10.2.1	Visual Inspection	28
10.2.2	Cleaning.....	28
10.2.3	Functional Test.....	29
10.2.4	Testing/Measuring.....	29
10.2.5	Care	30
10.2.5.1	Lubrication	30
10.2.5.2	Replacing the Axial Ventilator.....	30

10.3	Repairs.....	31
10.3.1	Testing after Repairs	31
10.3.2	Replacement Work.....	31
10.3.2.1	Replacing the Transformer	31
10.3.2.2	Replacing the MV Switchgear	33
10.4	Maintenance Schedule	34
10.5	Storing Spare Parts	35
11	Decommissioning and Dismantling	36
11.1	Removing Connection Cables	36
11.2	Dismantling	36
11.3	Disposal	37
11.3.1	Statutory Provisions	37
11.3.2	Chemical System Components	37
	List of Tables.....	39
	List of Figures	39



AEG Power Solutions GmbH

Emil-Siepmann-Strasse 32
59581 Warstein
Germany



+49 2902 763 100

Fax: +49 2902 763 645

E-mail: service.aegpss@aepps.com

Internet: <http://www.aegps.com>

1 General Information

1.1 Validity

These instructions relate to the technical specifications of the equipment at the time of publication. These instructions are a component part of the system.

Legal claims arising from this contractual relationship shall only be recognised by AEG Power Solutions GmbH subject to the terms agreed under the warranty obligation in the main contract.

1.2 Appropriate Use

The compact station TKS-CS is designed for use in solar power stations with one or two Protect PV inverters, in accordance with IEC 62271-202. The compact station is intended for outdoor installation.

An output-related transformer for electrical isolation and output-dependent medium-voltage switchgear for feeding into the local medium-voltage mains are installed in the compact station.

The equipment may only be used for this purpose. Any other use constitutes misuse and can endanger personal safety.

1.3 List of Abbreviations

Abbreviation	Meaning
CS	Compact Station
MH	Metal Housing

Further information can be found in the Protect PV Inverter Operating Instructions (BAL).

2 Safety

The qualified skilled personnel are responsible for safety.
The member of personnel who is responsible for the equipment must ensure that only suitably qualified persons are allowed access to the equipment.

To ensure safety in the electrical operating areas, these areas should be lockable; i.e. suitable locking systems should be installed by the owner on all exterior doors of the compact station.

2.1 Installation Location

The equipment is intended for use outdoors as an enclosed electrical unit.

- Environmental conditions: (→ technical data) in accordance with DIN EN 60721-3-4.
- Freely accessible air vents for heat dissipation.
- Ground pressure: min. 250 kN/m² (→ excavation plan)

Refer to the technical data for additional criteria.

When selecting the installation location, regional regulations governing noise emissions must be taken into account.

Do not install the equipment in areas subject to flooding or those with a high groundwater level.

2.2 Lightning Protection

The connection to the potential equalisation system of the foundation provides the equipment with effective protection against lightning strikes.

The manufacturer's specifications must be implemented effectively in order to provide the photovoltaic system with suitable lightning protection measures.

Further safety information can be found in the Protect PV Inverter Operating Instructions (BAL).

3 Scope of Delivery

Check that the following components have been delivered with the equipment:

- 1x compact station TKS-CS inc.:
 - Transformer corresponding to nominal output
 - Medium-voltage system corresponding to nominal output
 - Low-voltage box
 - Power supply and auxiliary power supply

- Technical documents comprising:
 - Technical data
 - Installation and operating instructions
 - Drawings/circuit diagrams

Available to order

AEG Service can also provide the following documents:

- Spare parts list
- Service book

To place an order, please contact:



AEG Power Solutions GmbH
Emil-Siepmann-Strasse 32
59581 Warstein
Germany



+49 2902 763 100

Fax: +49 2902 763 645

E-mail: service.aegpps@aeg.com

Internet: <http://www.aegpps.com>

4 Equipment Specifications

4.1 Structure

The compact station TKS-CS consists of a metal housing with a detachable roof structure and a concrete base.

The concrete base comprises a warp-resistant foundation with an oil and water-tight trough in the transformer compartment.

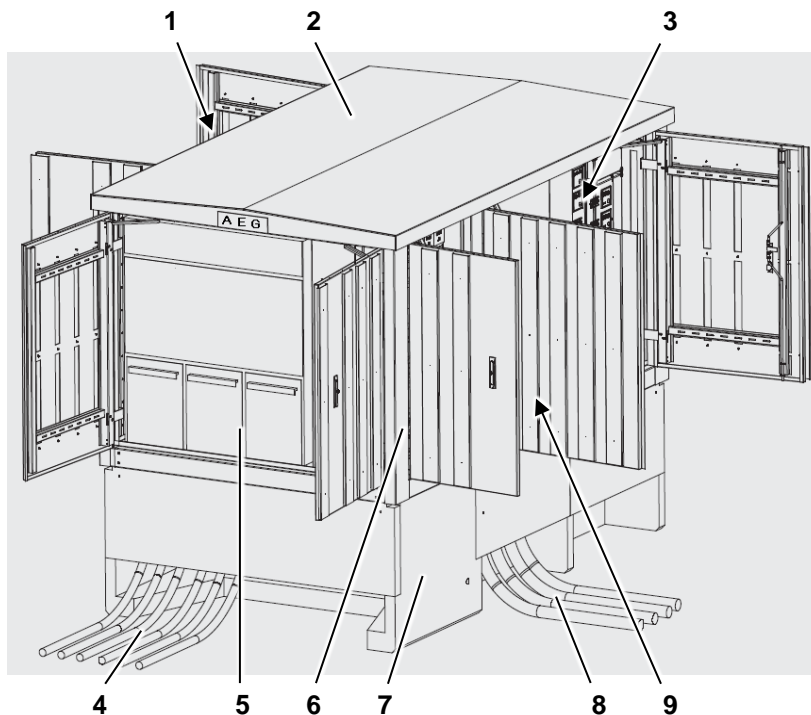

Figure 1 - Compact station TKS-CS

- | | |
|---|-------------------|
| 1 Transformer compartment | 6 Wall structure |
| 2 Roof structure | 7 Concrete base |
| 3 ISO small distribution box,
PV.LoG | 8 AC feed from MH |
| 4 MV branch - feed | 9 Low-voltage box |
| 5 MV switchgear | |

The wall and door structures are designed with double walls and forced ventilation. An additional axial ventilator is installed in the door of the transformer compartment for ventilation purposes.

4.2 Dimensions

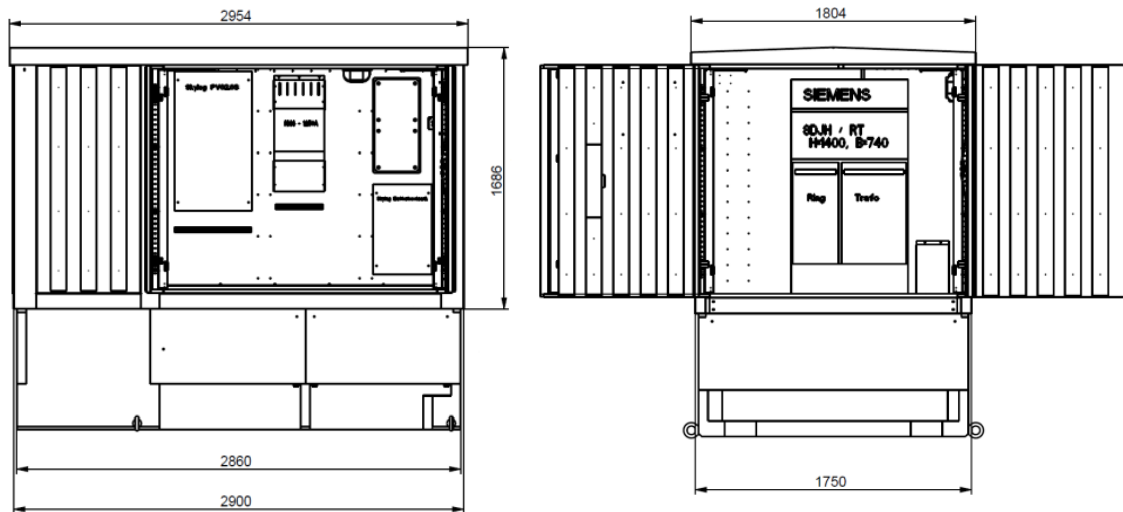

Figure 2 - Compact station side views

Dimension	[mm]
Height of metal housing with roof	1686.5
Height of concrete base	780
MH depth (roof)	1750 (1804)
MH width (roof)	2900 (2954)

Table 1 - Dimensions

4.3 Low-Voltage Box

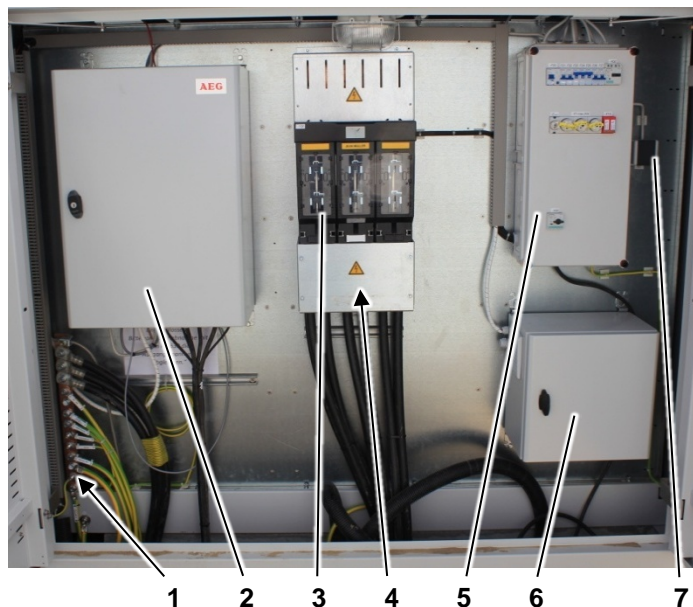

Figure 3 - Low-voltage box (example)

- | | |
|--|---------------------------------------|
| 1 Central earthing system | 5 ISO small distribution box |
| 2 Communications cabinet PV.LoG-MH | 6 Battery cabinet |
| 3 Load interrupter switch, 3-pin | 7 Socket outlet with earthing contact |
| 4 LV connections with protective cover | |

The low-voltage box must remain closed during operation.

4.3.1 AC Connections

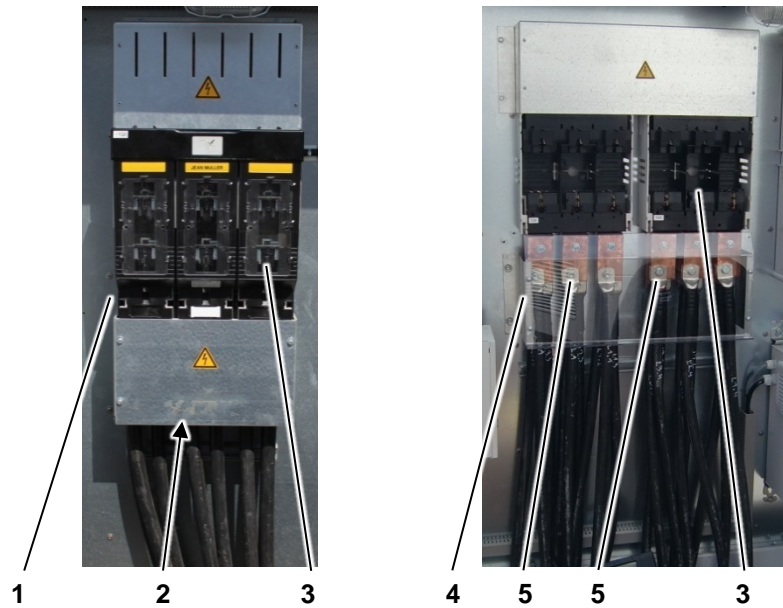

Figure 4 - Low-voltage boxes (example)

- | | |
|---|--|
| 1 LV box for an MH | 4 LV box for two MH |
| 2 AC connection - 1Q0 with steel sheet protective cover | 5 AC connection - 1Q0/2Q0 with Makrolon protective cover |
| 3 Load interrupter switch | |

4.3.2 ISO Small Distribution Box

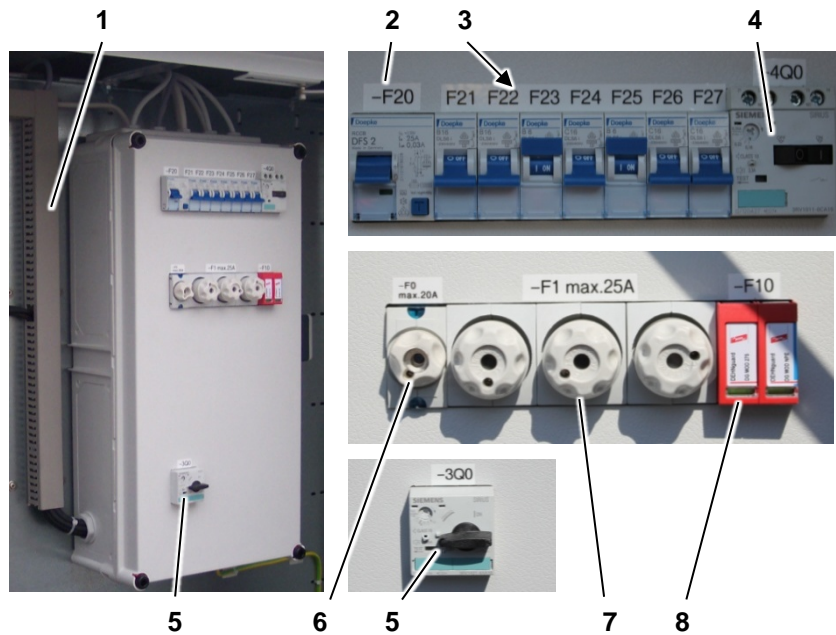

Figure 5 - ISO small distribution box (example)

- 1 Cable duct (internal)
- 2 -F20 - FI switch 25 A
- 3 F21 - 27 miniature circuit breakers
- 4 -4Q0 - motor protection switch Fan
- 5 -3Q0 - motor protection switch Auxiliary transformer
- 6 -F0 - fuse max. 20 A Sub-distribution
- 7 -F1 - fuses max. 25 A Auxiliary transformer
- 8 -F10 - overvoltage protection

Fuse		
F21	16 A	Socket outlet with earthing contact
F22	16 A	Door contacts and lighting
F23	6 A	Medium-voltage tripping
F24	16 A	Power supply PV.LoG-MH
F25	6 A	Axial fan
F26	16 A	optional
F27	16 A	optional
-F0	20 A	Sub-distribution supply
-F1	25 A	Auxiliary transformer
-F10		Overvoltage protection

Table 2 - Fuses

4.3.3 Communications Cabinet PV LoG-MH



Figure 6 - PV.LoG-MH (example)

- | | |
|--|------------------------------|
| 1 Data logger | 5 Ethernet coupler |
| 2 Fuses | 6 Data acquisition boards |
| 3 UPS 24 V DC | 7 CAN overvoltage protection |
| 4 Short-circuit and overvoltage protection | 8 Terminal strip |
| | 9 Shield terminals |

The compact station TKS-CS features the PV.LoG-MH and a variety of interfaces for monitoring and control. Data exchange between the PV.LoG-MH and the MH station control systems, the PV.lcX, and the transfer station takes place via Ethernet, modbus, CAN bus and FO cables.

For further information, refer to the PV.LoG-MH Operating Instructions.

4.3.4 Central Earthing System



Figure 7 - Central earthing system (example)

No.	H07V-K [mm ²]	Name
1	70	Low-voltage box
2	95	Cable entry
3	70	Station housing
4	16	Sub-distribution
5	16	Communications cabinet PV.LoG-MH
6	70	Medium-voltage system
7	70	Transformer

Table 3 - Potential equalising strip

The central earthing system is preinstalled on the potential equalising strip in the compact station.

4.4 Medium-Voltage System



Figure 8 - MV switchgear (example)

The installed MV switchgear (example) is an interior system with cable branch line (K) and transformer branch line (T) modules. Further information on the MV switchgear is available in the installation and operating instructions included in the scope of delivery.

4.5 Transformer

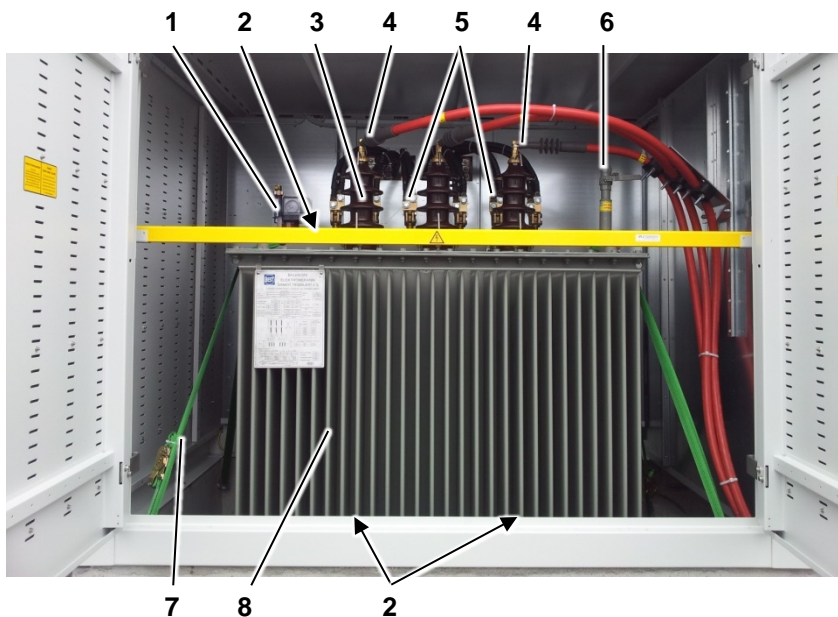

Figure 9 - Transformer (example)

- | | |
|-----------------------------------|-----------------------------|
| 1 Temperature - sensor/indication | 5 LV connection to LV box |
| 2 Earth terminal | 6 Oil fill level valve |
| 3 MV porcelain isolator | 7 Transport securing device |
| 4 MV connection to MV system | 8 Cooling fins |

All internal connections to and from the transformer are preinstalled in the compact station.

The transformer is on vibration dampers and is secured for transport. The transport securing device does not need to be removed for operation.

The transformer is equipped with temperature and oil level monitoring equipment, which is connected to the PV.LoG-MH and emits a warning if abnormal values occur.

For further information, refer to the transformer documentation.

5 Functional Description

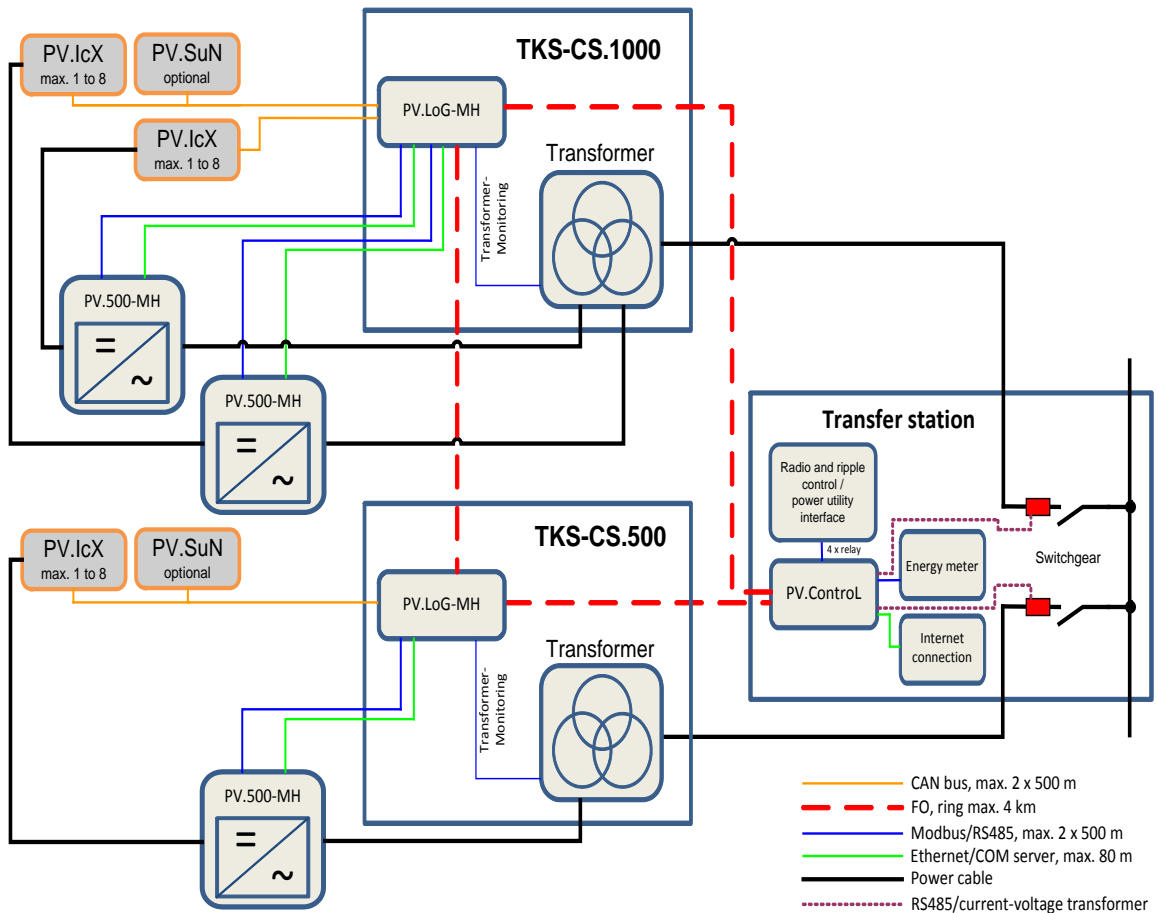

Figure 10 - Equipment diagram (example)

The station equipment is configured in accordance with the required nominal output.

One or two Protect PV inverters can be connected to a compact station TKS-CS.

The PV.Control or Skycontrol unit is adapted to the power station capacity and the local feed conditions.

Further functional information can be found in the Protect PV Inverter Operating Instructions (BAL).

6. Transport



	 DANGER
	<p>Suspended loads during transport</p> <p>Possibility of death or crushing.</p> <ul style="list-style-type: none">→ Select lifting gear according to the total weight to be transported.→ Do not step under suspended loads.→ Secure the danger zone.→ Wear personal protective equipment.



Figure 11 - Crane transport

The station may only be lifted using the crane rings on the longitudinal sides. The crane rings on the face sides are only intended for transport securing purposes and for dragging/towing the stations while they are raised. Raising the stations using the crane rings on the face sides is not permitted.

The load-carrying equipment used (ropes/belts) must have a sufficient carrying capacity. The weight of the station is dependent on the equipment configuration; please see the technical data.

The load must be evenly distributed between all four ropes/belts. Lifting at one side is not permitted.

No people or objects may be on the platforms in front of the station doors during lifting.

7 Assembly

7.1 Setting in Place

The compact station TKS-CS does not need a foundation. The concrete base serves as its foundation.



Figure 12 - Setting the compact station in place

- | | |
|-----------------|---------------------|
| 1 Ground | 4 Transport eyelets |
| 2 Concrete base | 5 Transport rod |
| 3 Metal housing | |

Using the construction pit pin, create a construction pit on clear ground.

The system may only be installed by crane
(→ Chapter 6 - Transport).

Remove the transport rod after the system has been installed.

7.2 Installation

	WARNING
	<p>Hinge side of the door when closing</p> <p>Fingers or hands may be crushed.</p> <ul style="list-style-type: none"> → Do not hold the hinge side of the door. → Take care while closing the cabinet door.

	<p>Observe the bending radius of the supply lines.</p> <p>With one bend:</p> <p>bending radius = 10 x diameter of supply line.</p>
--	---

7.2.1 Low-Voltage Box

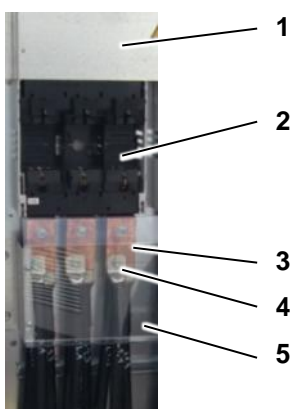

Figure 13 - LV box

- | | |
|--|--------------------|
| 1 LV box protective cover | 4 Cable lug |
| 2 Load interrupter NH4 - 1250 A | 5 Protective cover |
| 3 Connection panel NH4
(Cu busbars) | |

Connection	Design	*)	Torque (Nm)
L1-3:U, V, W	max. 3x240 mm ² , M12	2	15.5
PE	max. 3x120 mm ² , M12	2	15.5

*) 2 = cable lug connection

Table 4 - LV box connections

1. Remove the protective cover from the connection panel.

	<p>The order of the conductors (L1, L2, L3) must be adhered to.</p>
--	---

2. Establish the AC power connections and PE connections using the cable lug in accordance with the circuit diagram, and using the relevant tightening torque.
3. Remove any cable debris and tools from the equipment and replace the protective cover on the connection panel.

7.2.2 ISO Small Distribution Box

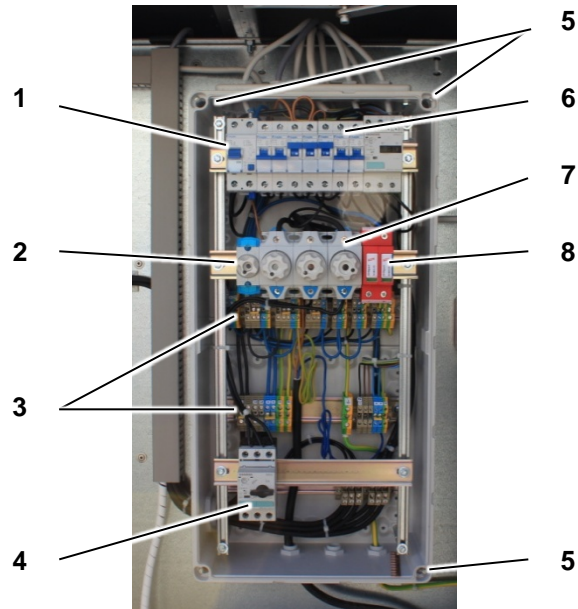

Figure 14 - ISO small distribution box (example)

- | | |
|--|------------------------------|
| 1 Residual-current-operated circuit-breaker | 5 Screw connections |
| 2 Back-up fuse sub-distribution | 6 Miniature circuit breakers |
| 3 Terminal strips | 7 Fuses, max. 25 A |
| 4 Motor protection switch
Auxiliary transformer | 8 Overvoltage protection |

The ISO small distribution box is preinstalled in the compact station.

To open the ISO small distribution box, unscrew the four screw connections. The cover can then be pulled out towards the front. Establish the connections in accordance with the circuit diagram.

7.2.3 Communication Interface PV.LoG-MH

The communications cabinet PV.LoG-MH includes batteries, which are installed in the cabinet or in a separate box.

Install the communications cabinet PV.LoG-MH in accordance with the PV.LoG installation instructions. Wiring is carried out in accordance with the circuit diagram.

Data is exchanged between the PV.IcX combiner boxes or the PV.Control and the PV.LoG-MH via CAN bus (→ *.USP and operating instructions for PV.LoG and PV.Control).

7.2.4 Central Earthing System

Connect the active earthing to the potential equalising strip according to the circuit diagram.

7.2.5 Medium-Voltage System

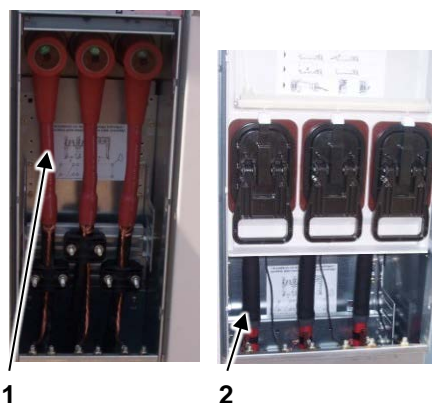

Figure 15 - Medium-voltage system (example)

- 1 Cable branch line L1/L2/L3 (left flap), external AC connections
- 2 Transformer branch line (right flap), internal AC connections from transformer to load interrupter switch

The MV system is preinstalled in the compact station.

Use the power cables supplied for the system AC connections, and connect in accordance with the manufacturer's installation instructions located in the system. Insert the branch cable into the compact station from below.

7.2.6 Medium-Voltage Transformer

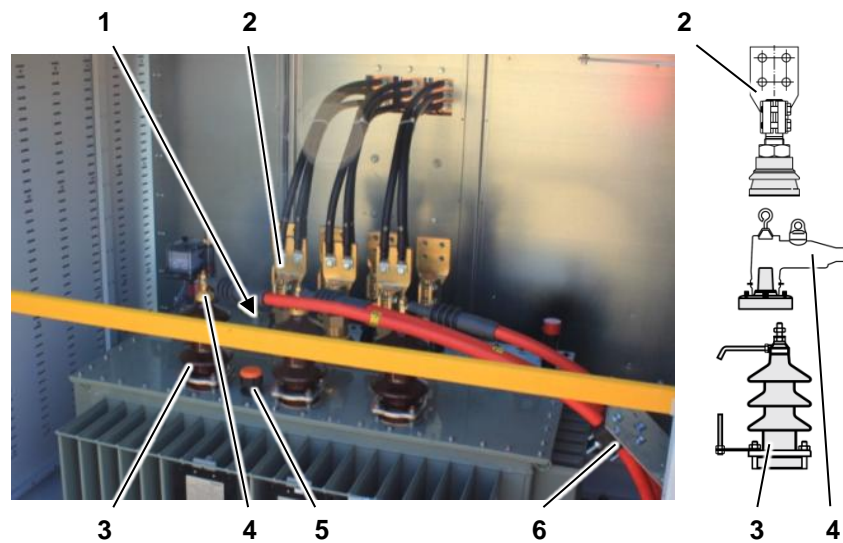

Figure 16 - Transformer (example)

- | | |
|--|------------------------------------|
| 1 Earth connection
Transformer cover | 4 MV elbow connector |
| 2 LV connection with
porcelain isolator | 5 Voltage tap changer |
| 3 MV porcelain isolator | 6 Retaining plate with cable clips |

The oil transformer is preinstalled and wired in the compact station TKS-CS. The LV connections are established in accordance with DIN EN 50386. Transformer and MV connections with porcelain isolators comply with DIN EN 504180.

During replacement work, establish the electrical cabling connections as normal and connect the three earthing terminals (→ manufacturer's technical operating documentation).



7.3 Tightening Torques for Screw Connections

Thread	Electrical connection [Nm]	Mechanical connection		
		Cheese head screw strength category 5.8 [Nm]	Hexagon screw strength category 8.8 [Nm]	Slotted cheese head screw DIN 84 [Nm]
M4	1.2	1.3	2.0	1.2
M5	2.0	2.65	4.0	2.0
M6	3.0	4.4	7.0	2.5
M8	6.0	10.5	17.0	3.5
M10	10.0	-	33.0	4.0
M12	15.5	-	56.0	-
M16	30.0	-	140.0	-
M20	52.0	-	260.0	-
M24	80.0	-	445.0	-

Table 5 - Tightening torques

These values apply to electrical and mechanical screw connections. They do not apply to floor attachment with dynamic stress applied.

8 Start-up

	 DANGER
	Working with voltages up to 1 kV Risk to life due to electric shock. → Comply with BGV A3, DIN VDE 0105-100 (EN 50110, IEC 61243). → Skilled personnel with a Working with Live Current certificate.

Special AEG Power Solutions software and hardware tools must be used for initial start-up. Only skilled personnel trained by AEG PS are in a position to use these tools correctly and to perform initial start-up.



Once the equipment has been fully installed, the following aspects must be checked:



- Screw connections properly tightened
- Cable connections properly established
- Tools removed
- Protective covers properly installed



9 Operation

The system is operated as a result of power emerging from the Protect PV inverter; this is determined by the power plant control system.



10 Servicing



	 DANGER
	<p>Contact with voltage</p> <p>Risk to life due to electric shock.</p> <ul style="list-style-type: none"> → Press emergency off. → Move the victim away from live parts using dry insulating material. → Get medical help and inform the control room. → Disconnect the equipment safely.

	 DANGER
	<p>Working with voltages up to 1 kV</p> <p>Risk to life due to electric shock.</p> <ul style="list-style-type: none"> → Comply with BGV A3, DIN VDE 0105-100 (EN 50110, IEC 61243). → Skilled personnel with a Working with Live Current certificate.

	 DANGER
	<p>Residual voltage from capacitors</p> <p>Risk to life due to electric shock.</p> <ul style="list-style-type: none"> → Observe discharge time. → Disconnect the equipment safely.

	<i>Keep the equipment clean to minimise leakage currents.</i>
---	---

	 DANGER
	<p>Contact with leakage current</p> <p>Risk to life due to electric shock.</p> <ul style="list-style-type: none"> → Disconnect the equipment safely.

	 DANGER
	<p>Toppling of cargo during transport by industrial trucks</p> <p>Possibility of death or crushing.</p> <ul style="list-style-type: none"> → Lift cargo under its centre of gravity. → Secure the cargo and danger zone. → Wear personal protective equipment.

	⚠ ATTENTION
	<p>Insufficient ventilation of equipment</p> <p>Equipment may overheat.</p> <ul style="list-style-type: none"> → Keep air vents clear. → Ensure the equipment is sufficiently ventilated.

	⚠ WARNING
	<p>Heat generation in resistors</p> <p>Risk of burning.</p> <ul style="list-style-type: none"> → Do not touch hot components.

	⚠ WARNING
	<p>Hinge side of the door when closing</p> <p>Fingers or hands may be crushed.</p> <ul style="list-style-type: none"> → Do not hold the hinge side of the door. → Take care while closing the cabinet door.

	⚠ WARNING
	<p>Entry of water into electrical equipment</p> <p>Risk to life due to electric shock.</p> <ul style="list-style-type: none"> → Do not use water to clean the cabinets. → Do not place any vessels containing fluids (beverage cups, for example) on electrical equipment.

5 safety rules

1. Disconnect safely.
2. Secure the equipment against being switched back on.
3. Verify that all poles are de-energised.
4. Earth the equipment, close the earthing switch and short-circuit the equipment.
5. Provide protection in the form of covers or barriers for any neighbouring live parts.

	<p><i>A safe disconnection certificate or a release certificate according to DIN VDE 0105-100 (EN 50110) must be presented prior to all maintenance and repair work.</i></p>
---	--

	<p><i>The owner must draw up a safe disconnection procedure and brief personnel on this.</i></p>
---	--

The owner is responsible for correct servicing of the systems and the equipment. This also applies to system components that fall within the responsibility of the grid operator.

In order to ensure uninterrupted availability of the equipment, preventive servicing work should be carried out based on the maintenance schedule. Regular maintenance reduces the risk of breakdowns and disruption due to technical faults.

To maintain the validity of the warranty:

- Regular maintenance must be carried out and documented according to the maintenance schedule.
- Only original AEG PS spare parts (or spare parts purchased from AEG PS) may be used.

For further details, please refer to the provisions of the individual contracts.

The owner must define work instructions for carrying out servicing work, giving details of:

- Ambient conditions
- Tools, equipment, means of protection and auxiliary equipment
- Suitable personal protective equipment and organisational safety measures.

Servicing work must be carried out in accordance with BGV A3 (DIN VDE 0100/VDE 0105) and DIN 31051 (DIN EN 13306).

AEG PS will rescind all obligations such as warranty agreements, service contracts, etc. entered into by AEG PS or its representatives without prior notice, in the event of anything other than original AEG PS spare parts being used.

10.1 Obligation to Keep a Written Record

Inspection results and details of any servicing work carried out must be recorded in writing. Experience has shown that the best way to document inspection results is in the form of a test report.

The following information must be recorded:

- Maintenance schedule
- Date of the measure carried out
- Work performed
- Any special notes on the work performed
- Persons who carried out the work
- Signatures of the persons who carried out the work
- Signature of the person responsible (supervisor)

A correct test report, completed in full, is important for technicians as evidence of exoneration in case of later complaints or for investigations in case of damage. For this reason, test reports should be retained for a long time (around 10 years).

10.2 Maintenance and Inspection

10.2.1 Visual Inspection

Visual inspections should be carried out in accordance with DIN EN 13018.

Inspections must involve careful checks for the following in the equipment:

- Mechanical damage
- Corrosion, thermal changes to and tightness of the electrical connections
- Moisture
- Accumulation of conductive dirt or dust
- Defective fuses
- Foreign bodies
- Fans dirty or damaged (M2 and M3 when the waste air duct is open)
- Filter mat dirty or damaged

Safety devices and warning notices should be checked for damage and legibility.

If there is condensation in the equipment, the internal heating device should be checked to determine whether it is working properly.

10.2.2 Cleaning



Only equipment tested in accordance with DIN VDE 0680 may be used for cleaning.



If there is condensation in the equipment parts that are to be cleaned, cleaning must not be carried out.

The cleaning procedure used must comply with the relevant regulations and provisions of the accident prevention regulation VBG 4 "Elektrische Anlagen und Betriebsmittel" (Electrical installations and equipment) and DIN VDE 0105-100 (Operation of electrical installations). Only specially trained electricians may carry out cleaning work when the equipment is live.

The log for dry-cleaning low-voltage installations using a vacuum cleaner must be completed before and after cleaning work. Circuit and installation markings should be noted before cleaning, so that if a marking is damaged or falls off, this can be rectified.

10.2.3 Functional Test



Always perform a functional test after completing any servicing work and before starting operation.

Electrical equipment must only be started up if it is in perfect working order and must be kept in this condition.

Following repair, replacement or modification work, a functional test must be performed in accordance with the commissioning log. For repeat tests, functional testing of the equipment or its components need only be carried out to an extent that verifies the safety of the equipment.

10.2.4 Testing/Measuring

The aim of testing/measuring is to verify that the electrical equipment complies with the installation standards.

In the case of recurrent tests, all measurements must be taken in accordance with the initial start-up and DIN VDE 0105100, and compliance with all values/limits must be verified.



All measuring and monitoring devices used for testing must comply with the standards DIN VDE 0413/EN 61557 and DIN 0404, and must be tested and calibrated regularly in accordance with ISO 9001:2000.

The equipment has various diagnostic functions (some of which are optional), which can significantly reduce the time required for maintenance work and troubleshooting.

Self-diagnosis:

This is activated when the equipment is switched on. Internal auxiliary programs monitor the bus system, the control PCBs and the sensors (amongst other things), and signal any faults that occur.

Data logger:

Measured data, parameters and fault indications are saved continuously. Measured data and performance data, as well as fault histories, can be read out and evaluated as required.



The operating instructions describe how to output performance and fault histories.

BGV A2 requires the owner to perform repeat tests at stipulated times in order to verify that the electrical equipment is in perfect working order.

At stipulated times, the owner must check that the fault current, differential current and fault voltage protection devices are functioning properly.

Carry out manual insulation testing.

10.2.5 Care

10.2.5.1 Lubrication

Carry out the following care measures for the station:

- Lubricate hinges, rods and guide rails after cleaning.
- Lubricate the ball bearings in the axial ventilator after around 20,000 operating hours or a maximum of 4 years, according to the manufacturer's specifications.

10.2.5.2 Replacing the Axial Ventilator

	<p>WARNING</p>
	<p>Rotating parts</p> <p>Injury to fingers and hands possible.</p> <p>→ Do not reach into rotating parts.</p> <p>→ De-energise fans.</p>

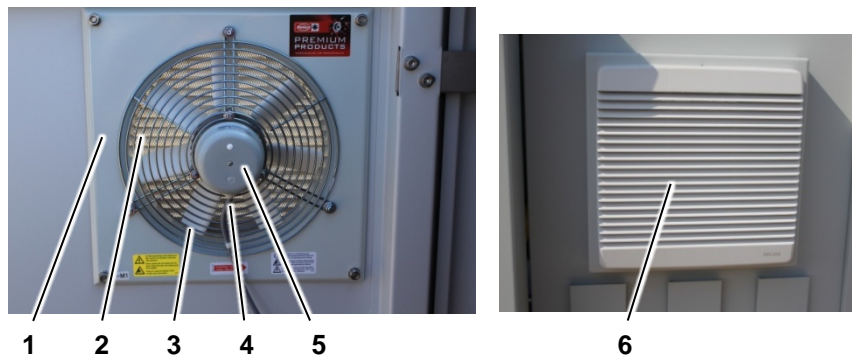

Figure 17 - Replacing the axial ventilator

- | | |
|-------------------------|------------------------------|
| 1 Housing plate with M9 | 4 Connection cable with seal |
| 2 Protective screen | 5 Drive motor |
| 3 Impeller | 6 Weather-proof cover |

The axial ventilator must be replaced if it is defective or runs out of round. As a precaution, it should be changed every 4 years (when bearing lubrication is due).

Remove the axial ventilator in accordance with the manufacturer's specifications and send it to the manufacturer for maintenance.

10.3 Repairs

Only AEG PS skilled personnel may carry out repairs and modifications on the compact station CS.xx.

If you want other personnel to carry out this work, this will need to be authorised by means of written approval from AEG PS.

Only original AEG PS spare parts (or spare parts purchased from AEG PS) may be used.

10.3.1 Testing after Repairs

Each time the equipment is repaired or modified, all recurrent tests/measurements are to be carried out and documented in accordance with DIN VDE 0105 (initial start-up log) once the work is complete.

10.3.2 Replacement Work

10.3.2.1 Replacing the Transformer

The transformer can be accessed via the detachable roof or a door. It can only be replaced when the roof structure has been removed.

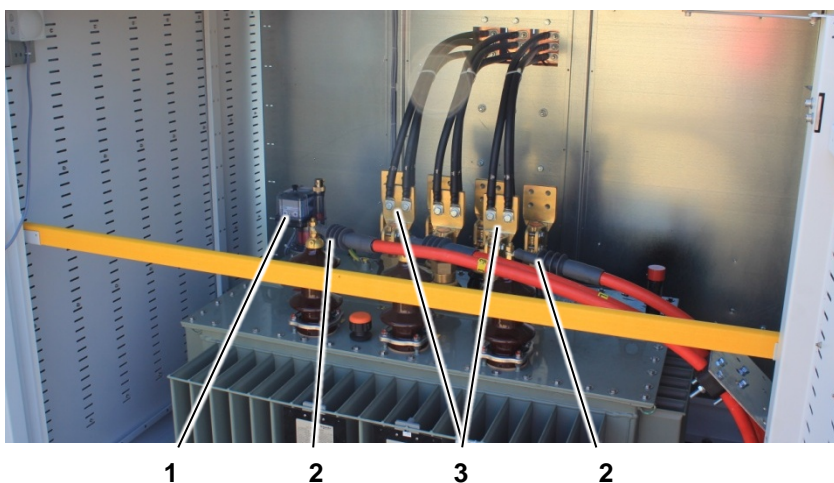

Figure 18 - Replacing the transformer, 1 (example)

- | | |
|-------------------------------------|---|
| 1 Temperature sensor | 3 Internal connections from low-voltage box |
| 2 Internal connections to MV system | |

1. Disconnect the equipment safely.
2. Remove all connections from the transformer, and secure the equipment.

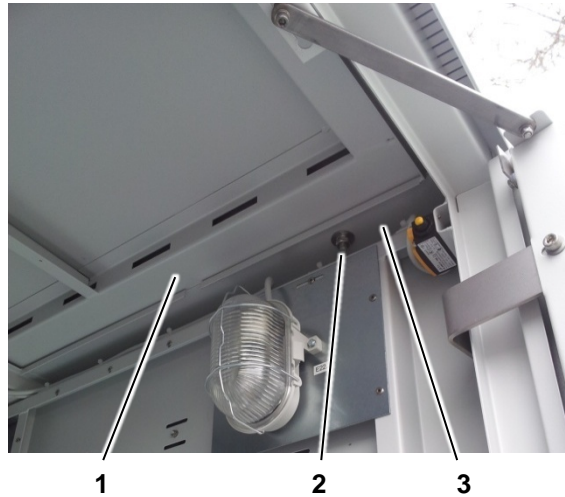

Figure 19 - Station roof

- 1 Roof structure
- 2 Screw connection
- 3 Station frame



The roof structure weighs around 130 kg. Comply with Directive 90/269/EEC (handling of loads).

3. Open all doors and unscrew the 6 roof structure screw connections. Completely remove the roof structure from the compact station TKS.CS (→ roof removal: Bosecker).

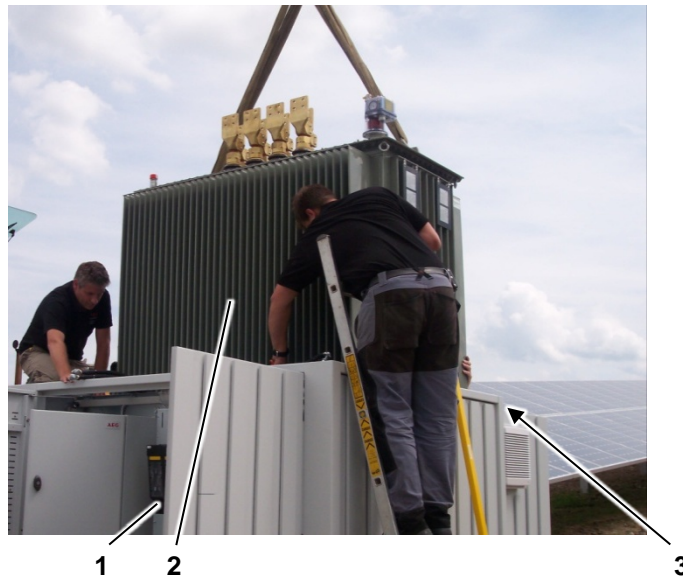

Figure 20 - Replacing the transformer, 2 (example)

- 1 Low-voltage box
- 2 Transformer
- 3 Transformer compartment

4. Attach the transformer to the transport eyelets and carefully lift it using lifting gear.

5. Place a new transformer in the compact station's trough and establish the connections. Finally, replace and align the roof structure, and establish the screw connections (→ transformer operating instructions).

10.3.2.2 Replacing the MV Switchgear

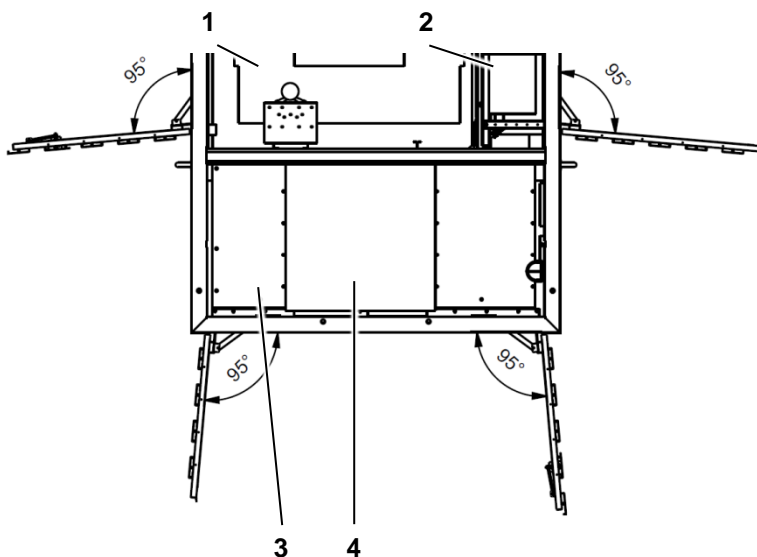

Figure 21 - Partial top view TKS-CS (example)

- | | |
|---------------------------|------------------------------|
| 1 Transformer compartment | 3 Medium-voltage compartment |
| 2 Low-voltage box | 4 MV switchgear |

1. Disconnect the equipment safely.
2. Remove all connections from the MV switchgear, and secure the equipment.
3. Unscrew the screws of the MV switchgear and remove it from the compact station using an industrial truck (→ MV switchgear BAL).

10.4 Maintenance Schedule

The maintenance schedule does not release the owner from his obligation to create his own maintenance and operating instructions for the location and to document them fully as quickly as possible.

Maintenance instructions supplied by component manufacturers must be included in the detailed specifications relating to the scope of maintenance work.



For recurrent measurements and measurements after repair work as per BGV A3, compliance with the DIN VDE 0105-100 inspection intervals is mandatory.

Ongoing

Check the measured results of the equipment for plausibility.
Replace defective measuring instrumentation at the end of production.

Data bus:
Ongoing functional testing in operation.

Monthly

Test lamps and replace diodes if required.

Check the function of the system's internal measuring instrumentation by comparing the values during operation with the values displayed.

Check the function of the measuring instruments and accessory systems required for operation and servicing.

Check the interior area and equipment for moisture and, if necessary, establish the cause and dry the equipment.

Clean the interior areas of the compact station (operating area).

Every 6 months

Check the fastenings and function of the electrical connections of all components in the compact station.

Check the function of the fault current, differential current and fault voltage protective circuits.

Carry out recurrent measurements in accordance with DIN VDE 0105.

Check the axial ventilator for damage and whether it is working correctly (rotation), and repair or replace if necessary.

Check the axial ventilator and weather-proof cover for dirt, and clean if necessary.

Check the function of the overtemperature warning system by opening the sensor path.

Annually
Measuring and monitoring devices must comply with the VDE 0413 standard. Check and calibrate all measuring instruments.
Check that the equipment as a whole is in perfect working order: <ul style="list-style-type: none"> - Check housing and roof structure for damage - Check line connections for dirt and corrosion - Check protective covers for damage and check their fastenings
Check all input, monitoring and output values in the equipment and also in interaction with the external control system. Check the control behaviour of the equipment and readjust, correct or change the limit values if required.
Check the function of the peripheral connections, i.e. all connections of the various accessory systems, and repair them if required.
Clean the equipment to minimise creepage currents (do not use water). Comply with BGV A3, DIN VDE 0105-100 during this process.
Check that the safety signs are complete and legible, and replace if required. (Must be checked by an expert every 2 years.)
Check the function of the lighting in the compact station, and replace if necessary.
Every 2 years
Check of the safety signs in the operating area and in the equipment by an expert.
Every 4 years
Replace the axial ventilator and clean the weather-proof cover.

10.5 Storing Spare Parts



When ordering spare parts, you must provide the component designation, installation location and component number as well as the unit number of the component.

The AEG PS customer service department will be happy to send you a spare parts list on request.

11 Decommissioning and Dismantling

The compact station TKS-CS can be decommissioned or dismantled for the purposes of changing its location or disposal.

Before beginning any work on the equipment, it must be de-energised. For this purpose, the **five safety rules** of electrical engineering in accordance with DIN VDE 0105 (EN 50110) must be observed:

5 safety rules

1. Disconnect safely.
2. Secure the equipment against being switched back on.
3. Verify that all poles are de-energised.
4. Earth the equipment, close the earthing switch and short-circuit the equipment.
5. Provide protection in the form of covers or barriers for any neighbouring live parts.



The owner must draw up a safe disconnection procedure and brief personnel on this.

11.1 Removing Connection Cables

- Disconnect power terminals.
- Disconnect the power supply and auxiliary power supply.
- Disconnect all external control cables.
- Disconnect the earthing line clips from the central earthing system.

11.2 Dismantling





DANGER

Suspended loads during transport

Possibility of death or crushing.

- Select lifting gear according to the total weight to be transported.
- Do not step under suspended loads.
- Secure the danger zone.
- Wear personal protective equipment.

	 DANGER
<p>Topping of cargo during transport by industrial trucks</p> <p>Possibility of death or crushing.</p> <ul style="list-style-type: none"> → Lift cargo under its centre of gravity. → Secure the cargo and danger zone. → Wear personal protective equipment. 	

- If necessary, secure the transformer to prevent it slipping.
- Attach suitable load-carrying equipment to the compact station (using the transport eyelets on the concrete base).
- Lift the equipment carefully and remove cables.

11.3 Disposal

11.3.1 Statutory Provisions

Equipment at the end of its life is electrical scrap.

In commercial contexts, the manufacturer is responsible for the disposal of electrical scrap unless otherwise agreed. Electrical scrap must always be disposed of by an expert.

	<p><i>Electrical and electronic scrap may only be disposed of in compliance with local legislation and regulations German Electrical and Electronic Equipment Act, 2002/96/EC (WEEE) and the Basel Convention.</i></p>
---	--

Electronic scrap consists of valuable materials which can be reclaimed as secondary raw materials, but it also contains environmentally harmful substances.

Commercial disposal companies have information on the best way to recycle material (e.g. in the form of a Recycling Handbook).

For example, it is possible to recycle:

- PCBs and circuit boards
- Electronic components, EPROMs, ICs and relays
- Chips, processors, hard disks and drives
- Batteries

11.3.2 Chemical System Components

AEG PS complies with the restrictions on the use of hazardous substances in electrical and electronic units according to the German Electric and Electronic Equipment Act Section 5 (2002/95/EC).



Do not dispose of old batteries with refuse. They contain environmentally harmful materials (Hg, Cd or Pb).

Ensure compliance with local legislation and regulations governing the storage, handling and disposal of batteries.

Components such as plastics and insulating materials should be disposed of as industrial waste and should be recycled.

List of Tables

Table 1 - Dimensions.....	10
Table 2 - Fuses.....	12
Table 3 - Potential equalising strip	14
Table 4 - LV box connections	19
Table 5 - Tightening torques.....	23

List of Figures

Figure 1 - Compact station TKS-CS	9
Figure 2 - Compact station side views.....	10
Figure 3 - Low-voltage box (example).....	10
Figure 4 - Low-voltage boxes (example)	11
Figure 5 - ISO small distribution box (example)	12
Figure 6 - PV.LoG-MH (example).....	13
Figure 7 - Central earthing system (example)	13
Figure 8 - MV switchgear (example).....	14
Figure 9 - Transformer (example).....	15
Figure 10 - Equipment diagram (example)	16
Figure 11 - Crane transport	17
Figure 12 - Setting the compact station in place	18
Figure 13 - LV box	19
Figure 14 - ISO small distribution box (example)	20
Figure 15 - Medium-voltage system (example)	21
Figure 16 - Transformer (example).....	22
Figure 17 - Replacing the axial ventilator	30
Figure 18 - Replacing the transformer, 1 (example).....	31
Figure 19 - Station roof	32
Figure 20 - Replacing the transformer, 2 (example).....	32
Figure 21 - Partial top view TKS-CS (example).....	33

Free Manuals Download Website

<http://myh66.com>

<http://usermanuals.us>

<http://www.somanuals.com>

<http://www.4manuals.cc>

<http://www.manual-lib.com>

<http://www.404manual.com>

<http://www.luxmanual.com>

<http://aubethermostatmanual.com>

Golf course search by state

<http://golfingnear.com>

Email search by domain

<http://emailbydomain.com>

Auto manuals search

<http://auto.somanuals.com>

TV manuals search

<http://tv.somanuals.com>