

ADURAN[®]

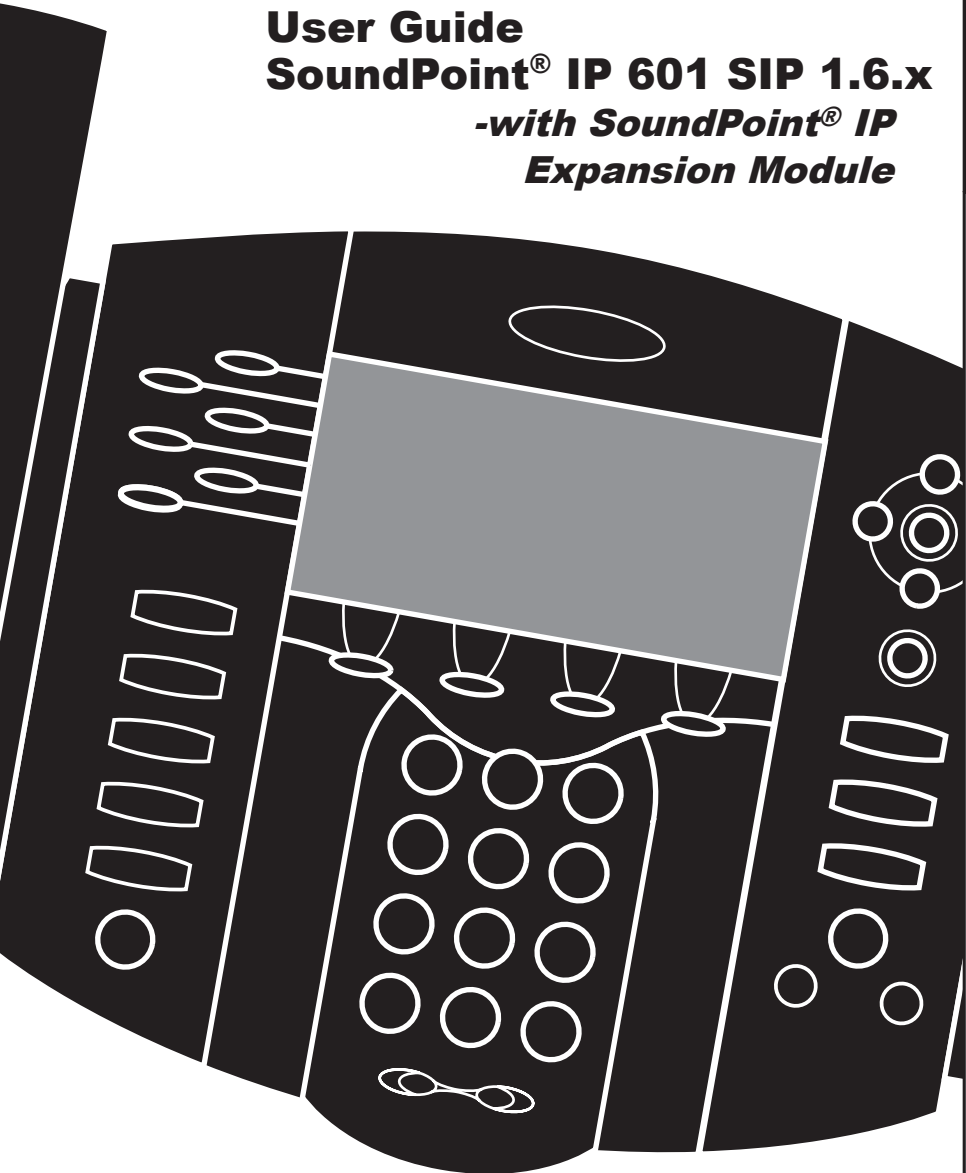

POLYCOM[®]

User Guide
SoundPoint[®] IP 601 SIP 1.6.x
-with SoundPoint[®] IP
Expansion Module



SoundPoint[®] IP 601 SIP

USER GUIDE

May 1, 2005

Contents

Introduction	1
Parts List	1
Installing SoundPoint® IP 601 SIP.....	2
Connecting Network and Power Source	2
Connecting the Handset and Optional Headset.....	3
Attaching the Base	3
Features	4
Key Descriptions	5
Using SoundPoint® IP 601 SIP.....	6
Placing a Call	6
Answering a Call	7
Call Hold and Resume	7
Multiple Calls on Hold	7
Microphone Mute.....	7
General Key Use.....	8
Local Conferencing.....	8
Splitting a Conference	8
Transferring a Call.....	9
Call Timer.....	9
Ending a Call	9
Redial.....	9
Call Forwarding.....	10
Volume Adjustment	10
Do Not Disturb.....	10
Time and Date	11
Headset Memory Mode	11
Display Contrast.....	11
Ring Type	12
Call Lists.....	12
Contact Directory	12
Speed Dial	13
Multiple Lines.....	14
Multiple Keys per Line.....	14
Multiple Call Appearances	15
Shared Lines	16
Voice Mail	16
Distinctive Ringing / Call Treatment.....	17

Multilingual Support (Localization)	17
Phone Reboot	18
Optional Features	18
Text Messaging	18
Presence / Status / Buddy Lists	19
SoundPoint® IP Expansion Module	21
Introduction	22
Parts List	22
Installing the SoundPoint® IP Expansion Module	23
Features	24
To Place a Call	25
To Answer a Call	25
Display Contrast	25
Speed Dial	25
Troubleshooting	27
Safety and Compliance	28
Part 15 Rules	28
Class B Digital Device or Peripheral	28
Modifications	29
Installation Instructions	29
Plug Acts as Disconnect Device	29
Industry Canada (IC)	29
CE & VCCI Mark	29
Polycom Limited Warranty and Limitation Liability	29
Exclusions	30
Warranty Exclusive	30
Service Agreements	30
Limitations of Liability	31
Disclaimer	31
Governing Law	31
Copyright Notice	31

Introduction

Thank you for choosing SoundPoint® IP 601 SIP, a full-duplex, hands-free phone running the industry standard Session Initiation Protocol (SIP). This unit provides business telephony features and functions such as Multiple Call Appearances, Call Hold, Transfer, and Conference over an IP network. In this User Guide, you will find everything you need to quickly use your new phone.

Be sure to verify with your system administrator that your network is prepared for configuring your SoundPoint® IP 601 SIP phone or consult the *Administrator Guide SoundPoint®/SoundStation® IP SIP* for more information. As well, be sure to read the Parts List, and the Safety Notices section in this guide before you set up the SoundPoint® IP 601 SIP phone.

Parts List

The following items are included in your SoundPoint® IP 601 SIP package. Check this list before installation to ensure that

you have received each item. If you are missing any items, please contact your system administrator.

Polycom SoundPoint® IP 601 SIP

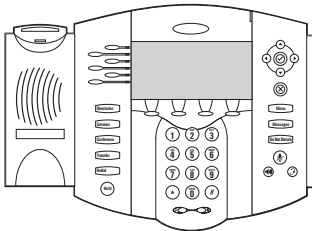

Power Adapter

(specification varies according to country)

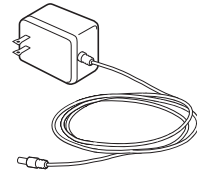

Handset & Handset Cord

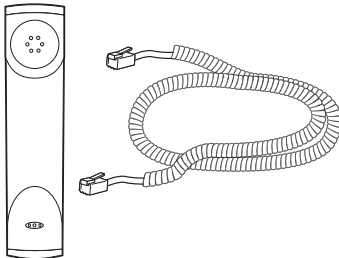

Phone Base

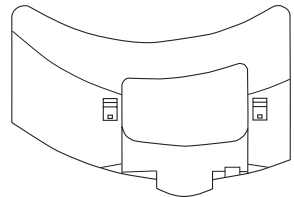

Network Cable

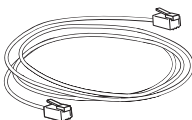

Quick Start Guide



Installing SoundPoint® IP 601 SIP

This section provides basic installation instructions and information for obtaining the best performance with the SoundPoint® IP 601 SIP phone. If you require additional information or assistance with your new phone, please contact your system administrator.

The SoundPoint® IP 601 SIP User Guide includes regulatory compliance information that your system administrator should review and can also be found at www.polycom.com.

Connecting Network and Power Source

AC Power Option

Connect the supplied Network cable between the LAN jack on the phone and the LAN port on the wall or hub/switch device. Connect the DC plug on the AC wall adapter to the DC jack marked on the phone.

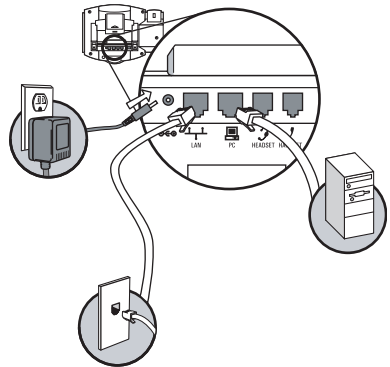

In-Line Power Option

If the phone is connected to a compatible Ethernet switch that can provide in-line power, the phone will use that power option. Simply plug the supplied Network cable between the LAN jack on the phone and an available Power and Data port on the In-Line Power switch.

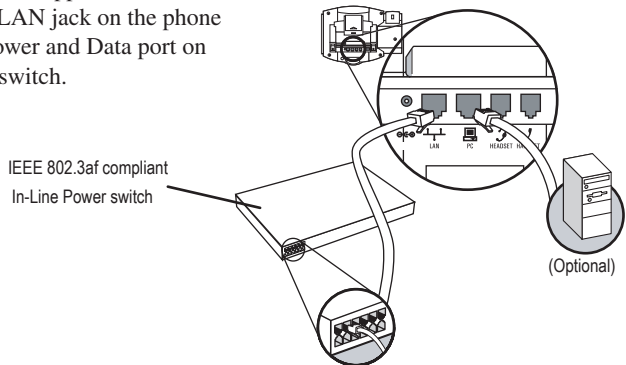

Connecting the Handset and Optional Headset

1. Connect the short, straight end of the phone cord to the handset and the corresponding longer straight end of the cord to the handset jack on the back of the phone.
2. Connect the headset (optional accessory) to the headset jack on the back of the phone.

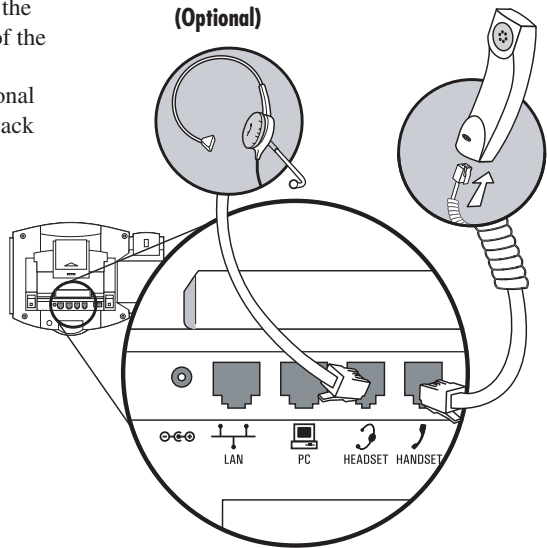

For information on headsets, please visit www.polycom.com and choose the Support link.

Attaching the Base



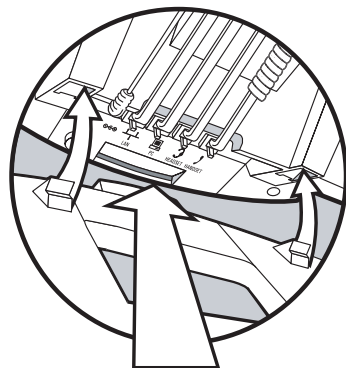
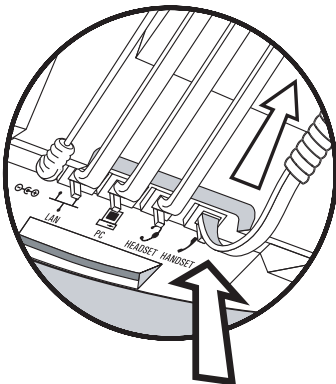



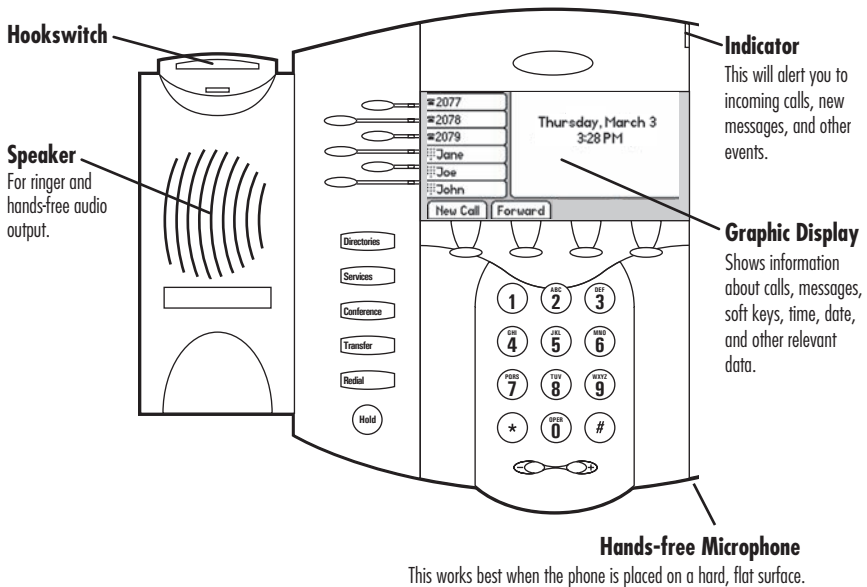
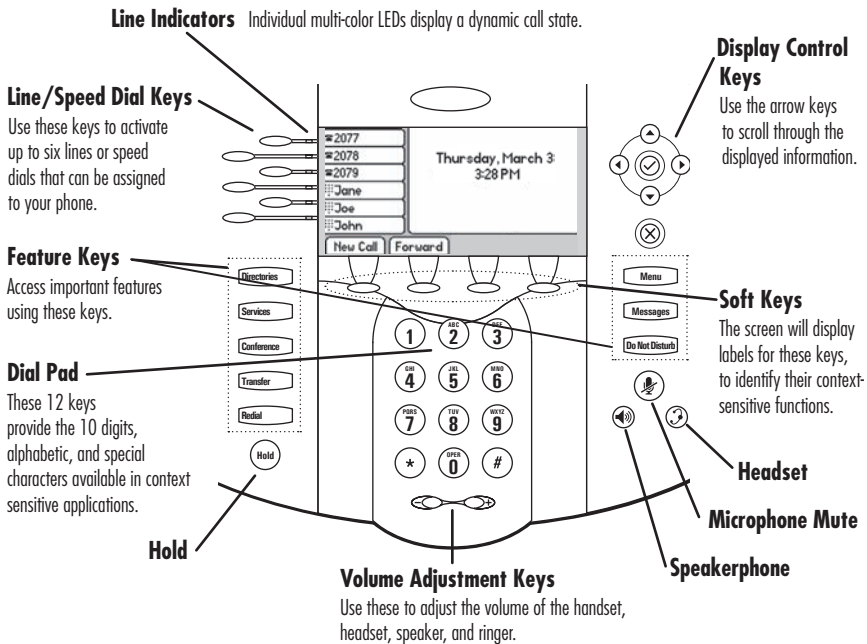





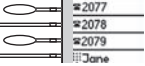



1. Place all cords in the recessed area above the modular jacks as shown.
2. Align the two protrusions on the bracket with their corresponding holes in the phone and snap them together to lock the base to the phone.



Features



Key Descriptions



Feature Key	Description
	Allows for hands-free communication during calls.
	Mutes audio transmission locally during calls.
	Allows users to place and receive calls through an optionally connected headset.
	Line or Speed Dial keys with LED indicators.
	Access to local directories and call lists.
	Access to special services.
	Allows setup of a 3-way local conference.
	Transfer of current call to third party.
	Dials last connected party from the phone.
	Places current active call in Hold state.
	Cancels ringing and directs incoming calls to your Voice Mail (if supported).
	Place/receive text and voice messages.
	Access local and server features.
	Select and Delete controls for options and text within local menus.
	Scrolling of lists and control of text/number entry on display.
	Soft keys to select from various context-sensitive options.
	Volume keys to adjust audio and ringer volume.
Dial Pad	General dialing and alphanumeric entry (incl. special characters).

Using SoundPoint® IP 601 SIP

Placing a Call

Using the Handset:

1. To obtain dial tone, pick up the handset.
2. Dial the desired number.
OR
Dial by SIP URL/IP address[†]:
 - After obtaining dial tone, press **Name**
 - Enter URL or IP (press * for "." and # or "@")
 - Press **Send** to complete the call.

During a call, users can alternate between handset, headset, or hands-free modes by pressing the  or  keys, or picking up the handset.



Using Hands-Free Speakerphone Mode:

1. With the handset on-hook, press any assigned line key, , or **NewCall** to obtain dial tone.
2. Dial the desired number.
OR
Dial by SIP URL or IP address[†] as above.

Using the Headset:

1. With the optional headset connected, press any assigned line key, , or **NewCall** to obtain dial tone.
2. Dial the desired number.
OR
Dial by SIP URL or IP address[†] as above.

See also Headset Memory Mode.

Users also have the option to dial directly from the dial pad without first getting dial tone. Simply enter the number then lift the handset, press the **Dial** soft key, or press the  or  keys.

In all cases, the active call will appear on the display showing call duration and destination.

[†]Examples: 10.3.0.42
joe@205.173.1.24
sip: jane@polycom.com

To obtain the IP address of your phone, press  followed by **Status**, **Platform** and **Phone**. The IP address is listed together with other phone information.

Answering a Call

Using the Handset:

Pick up the handset.

Using Hands-Free Speakerphone Mode:

Press , or with the handset on hook press the line key with the active indicator, or the **Answer** soft key.

Using the Headset:

Press , to answer the call through an optionally connected headset.

In all cases, the active call will appear on the display showing call duration and destination.

*Incoming calls may be ignored by pressing the **Reject** soft key or **Do Not Disturb** during ringing. Note that **Do Not Disturb** stays active when the call is dropped and will remain so until toggled off.*

Call Hold and Resume



During a call, press  or the **Hold** soft key. The call will be placed on hold and this will be indicated on the display. Press the **Resume** soft key, or the line key to retrieve the call.

Multiple Calls on Hold

If multiple calls are on hold on a single line key, use the arrow keys to switch between the calls then press the **Resume** soft key to retrieve the desired call. If more than two calls are on hold on a single key, an indication will appear on the display, for example “2/3” shows that this is the second call out of three calls.

If calls are on hold on more than one line key, the details of the calls on any line key can be viewed by pressing that line key and holding it down for a few seconds. If a line key is pressed briefly, the first call on hold on that line key will be retrieved.

Microphone Mute









During a call, press . The  key lights up to indicate that the other party (parties) cannot hear you.

To turn off Microphone Mute, press  again.

Microphone Mute applies to all modes: handset, headset, and hands-free. You can still hear all other parties while Mute is enabled.



General Key Use

To navigate through menus and to enter data, these are useful tips:

1. Use  and  to scroll through lists. In some lists the  and  keys can be used as “Page Up” and “Page Down”.
2. When menus have submenus, use  and  to move one level down or one level back up.
3. The  key can be pressed to quickly exit from any menu.
4. The  key can be pressed to quickly exit from any directory.
5. To enter text using the dialpad, press the number keys one or more times. For example, for ‘A’ press ‘2’ and for ‘C’ press ‘222’. When in text entry mode the display title will show whether keys will generate numbers (1), upper-case (A) or lower-case (a) characters and the **I/A/a** soft key can change this.

Local Conferencing

A conference may be created with two other parties using the phone’s local conferencing feature.

1. Place a call to the first party.
2. Press  or the **Confrnc** soft key to create a new call (the active call is placed on hold).
3. Dial the phone number of the second party or use the arrow keys to access speed dial numbers, missed, placed and received call lists. From one of these lists press the **Dial** soft key.
4. When the second party answers, press  or the **Confrnc** soft key again to join all parties in the conference, or press the **Split** soft key to put the first call on hold and keep the second call as the active call.

Ending the call on the conference originator’s phone will terminate the conference.

A conference may be created at any time between an active call and a call which is on hold (on the same line or another line) by pressing the **Join** soft key.

Splitting a Conference

When a conference has been established, a **Split** soft key is available. Pressing this key will split the conference into two calls on hold.

Transferring a Call

1. During a call, press **Transfer** or the **Trnsfer** soft key (the active call is placed on hold).
2. Press the line key if set up for speed dial on the SoundPoint® IP 601 and SoundPoint® Expansion Module or dial the number to which you want to transfer the call.

OR

Use the arrow keys to access speed dial numbers, missed, placed, and received call lists. From one of these lists, press the **Dial** soft key.

3. Press **Transfer** or the **Trnsfer** soft key again to complete the transfer. This

can be done as soon as the ringback sound is heard or you can wait until the third party answers and talk to them before completing the transfer. Press the **Split** soft key to put the first call on hold and keep the second call as the active call.

Transfer may be cancelled during establishment by pressing the **Cancel** soft key. The original call is resumed.

*A blind transfer (without consultation) can also be supported by pressing the **Blind** soft key.*

Call Timer

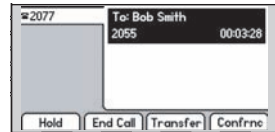

Call duration on an active call is monitored through a local call timer. This is visible within the active call window on the display.



Ending a Call



Press the **EndCall** soft key.

OR

Replace the handset, or press  if in Hands-free Mode, or  if in Headset Mode.

Redial

Press **Redial** to dial the last call placed from your phone.

To redial another previously dialed number, press  from the phone's idle display, and press  again to place the call.

OR

Press **Directories** and select *Call Lists* and *Placed Calls* to scroll through the list.

Call Forwarding

Calls may be Forwarded (Diverted) to another extension as follows:

1. Press the **Forward** soft key from the phone's idle display or press  and select *Features* and *Forward* at any time.
2. (Optional) If multiple lines are in use, select which line to forward.
3. Enter a number or URL to forward all future calls to.
4. Press the **Enable** soft key to confirm Call Forwarding.

A moving arrow replaces the usual indicator for that line to confirm Call Forwarding enabled.

To turn call forwarding off:

1. Press the **Forward** soft key from the phone's idle display or press  and select *Features* and *Forward*.
2. (Optional) If multiple lines are in use, select which line to disable.
3. Press the **Disable** soft key.

The line indicator now displays the regular icon.

Volume Adjustment

Press the volume keys to adjust handset, headset, and hands-free speaker volume during a call. Pressing these keys in idle state adjusts the ringer volume.

To conform to regulatory requirements, handset and headset volume will return to a preset level after each call. Hands-free volume settings will be maintained across calls.

Do Not Disturb

Press  to prevent the phone from ringing on incoming calls. A flashing icon and text on the display indicates that Do Not Disturb is on.

Calls received while Do Not Disturb is enabled are logged in the *Missed Calls* list.



To turn off Do Not Disturb, press

 again.

(Optional) If multiple lines are in use, Do Not Disturb can be set on a line-by-line basis. Contact your system administrator for further details. When Do Not Disturb is enabled for a particular line, this is indicated by a flashing "X" beside the line indicator on the display.



Time and Date

Time and Date is clearly displayed on the SoundPoint® IP 601 SIP phone. If the phone cannot obtain a time and date from the server, the display will flash. Contact your system administrator if either time or date is incorrect. Users have control over the format of the display and can turn it off. Select options which are right for you as follows:

1. Press .
2. Select *Settings* followed by *Basic, Preferences, Time & Date*.
3. Select from *Clock Date, Clock Time, Clock Order* or *Enable / Disable*.
4. Scroll through the options via the up and down arrow keys.
5. Press **Select** to confirm and  to return directly to the idle display.

Headset Memory Mode

As an option, the headset can be permanently enabled. This is especially useful for regular headset users. To do this:



1. Press .
2. Select *Settings* followed by *Basic, Preferences, Headset Memory*.
3. Use the up or down arrows and **Select** soft key to enable Headset Memory Mode.
4. Press  to return to the main menu.

Subsequent calls to or from this phone using the headset will cause the headset key to flash. Pressing the line keys or the **Answer** soft key to receive a call will now connect to the user's headset automatically.

Repeat steps 1-3 and select **Disable** to turn Headset Memory Mode off.

Display Contrast

To adjust the contrast on the display to a comfortable level:

1. Press . Select *Settings* followed by *Basic, Contrast*.
2. Pressing the **Up** or **Down** soft keys or volume keys will increase or decrease the display contrast.
3. Press the **Ok** or **Cancel** soft keys to accept or reject changes.
4. Press  or the **Exit** soft key to return to the idle display.

Ring Type

Many ring types are available including a “Silent Ring”. Users can select different rings to distinguish between lines or to have a different ring from their neighbor’s phone.

To change the incoming ring:

1. Press **Menu**. Select *Settings* followed by *Basic, Ring Type*.
2. (Optional) If multiple lines are used, first select which line to change.
3. Using the arrow keys, highlight the desired ring type. Press the **Play** soft key to hear the selected ring type.

*If “Silent Ring” is selected, incoming calls can only be answered by pressing the **Answer** soft key.*

4. Press **Select** to change to the selected ring type.
5. Press **Menu** or the **Exit** soft key to return to the idle display.

See also **Distinctive Ringing / Call Treatment**.

Call Lists

A local list of calls missed, received, and placed is maintained by the phone (up to 100 for each).

Press **Directories** followed by *Call Lists* and *Missed, Received, or Placed Calls* as desired. Call information will be displayed. From this screen:

1. Choose **Edit** to amend the dial string before dialing.
2. Choose **Dial** to return the call.
3. Choose **Exit** to return to the previous menu.

For additional choices, press **More** followed by:

4. **Info** to view information about the call.
5. **Save** to store the contact to the Contact Directory.
6. **Clear** to delete the call from the list.

Press **More** and **Exit** soft keys to return to the idle display.

To quickly view respective call lists from the idle display:

Press **▶** for Placed Calls.
Press **◀** for Received Calls.
Press **⌂** for Missed Calls.

Contact Directory

In addition to a directory of missed, placed, or received calls, the phone can store a local directory of 500 or more contacts*.

Users can add, delete, edit, dial, or search for any contact in this list through just a few key strokes.

**Limit depends on server configuration.
Contact your system administrator for full details.*

To add or edit a contact:

1. Press **Directories** and select *Contact Directory*.
2. Press **More** and then **Add** to enter another contact into the phone's database or highlight an existing entry then press **Edit**.
3. Enter first and/or last name from the keypad. Press the **1/A/a** soft key to select between numeric and upper/lower case alphanumeric modes. Press the **Encoding** soft key to access special characters in other languages if necessary.
4. Enter the Contact number. This is a required field and it must be unique (not already in the directory).
 - ▶ The Speed Dial Index will automatically be assigned the next available index value.
5. Ring Type and Divert Contact may be left blank.
6. Use **▶** and **◀** to switch between Enabled and Disabled settings for the last four fields.
7. Press **Save** to confirm or **Cancel** to **abandon** the changes then press **Directories** or the **Exit** soft keys to return to the idle display.

*Contacts can be easily added from Call Lists. See **Call Lists** for more information.*

To search for a particular contact:

1. Press **More** and then **Search** from the *Contact Directory* menu.
2. Using the dial pad, enter the first few characters for First or Last names.
3. Press **Search** to search for contacts.
4. Successful matches can be dialed from the resulting screen.

Speed Dial

Pre-assigned numbers can be associated with line keys for rapid automated dialing. Speed Dial entries are consecutively placed next to assigned line keys on the phone. When a new entry is added to the

Contact Directory, it is automatically assigned the next available speed dial index. Speed dial assignments always appear after line keys, and there can be no gaps between subsequent speed dials.

Example: To change a Speed Dial key assignment:

1. Press **Directories** and select *Contact Directory*. Highlight an existing directory entry and press **Edit**.
 - ▶ OR press and hold a line key which already has a speed dial number assigned to it. That contact in the directory will automatically be displayed.
2. If a speed dial index already exists, delete it by pressing the **▶** the **⊗** keys.
3. If desired, enter a new speed dial index. For example, enter speed dial index as 1. This assigns the entry to the first available line key on the display.

- OR when editing the contact, press and hold an unassigned line key. This will automatically assign the speed dial index which is required to assign that line key as a speed dial for the contact. A confirmation beep is heard when this happens.

4. Press **Save** to confirm or **Cancel** to abandon the change then press **Exit** to return to the idle display.

Idle display could now be as shown:

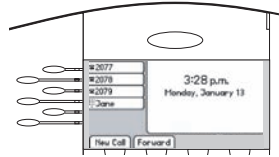

On a default configuration of the phone, there could be up to five line keys available for speed dial.

To dial a number assigned to a Line Key, simply press the line key directly opposite the number on the display.

To quickly view a complete list of assigned speed dial entries, press . Dial directly from a selected number.

Multiple Lines

SoundPoint® IP 601 SIP can support up to six lines. Lines can be configured for private or shared lines.

Typically, the top-most line key is reserved for the principle directory number of the phone. Depending on how your phone is configured, the display could resemble one of the displays shown:

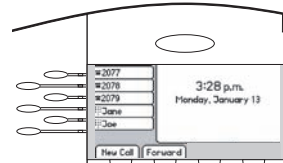
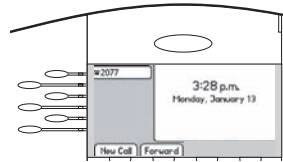

Multiple Keys Per Line

Each line on the phone can be configured to have more than one line key associated with it. If this is the case, the display could look like this:

Incoming calls to this line will be distributed evenly among the available keys. Similarly, outgoing calls will be distributed.

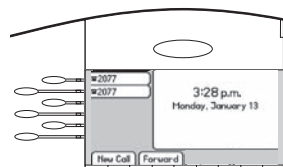

Multiple Call Appearances

Each line on the phone can be configured to have one or more call appearances. More than one call appearance is useful if there is an active call and an incoming call arrives on the same line. In the example shown, extension 9301 is in an outbound call with 9304. The second diagram shows an incoming call from John Brown. To answer this incoming call, put the original call on Hold or press the  key to access the new call. Soft key labels will be updated on the display with these options:

1. **Answer** the incoming call.
2. **Reject** the incoming call.
3. **Forward** the incoming call to another extension.

Answering the incoming call places the original call on Hold and refreshes the soft key labels as indicated (third illustration). If more than two call appearances are in use, two will appear on the display and the total number will be indicated by a counter at the bottom right corner of the display. For example “2/3” indicates that the highlighted call is the second one out of a total of three.

In the example case illustrated, another outbound call can be placed on the same first line. Press **Hold** during the first call and press **NewCall** to obtain dial tone and a new call appearance for a second call.

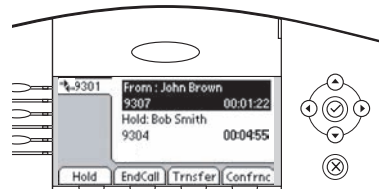
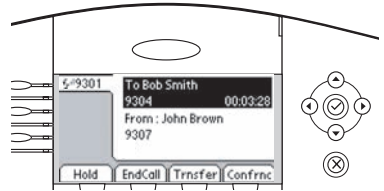
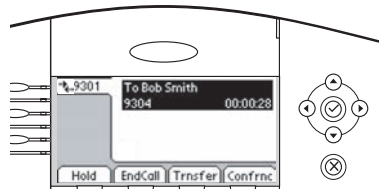

Shared Lines

The phone supports shared lines **. A shared line is indicated by a different line icon. In the diagram, the first line is private and the second line is shared. If two phones share a line, an incoming call to that number will cause both phones to ring. The call can be answered on either phone but not both.

If a shared line is in use on one of the phones, it cannot be used on the other one. The shared line icon changes to a moving icon and the line LED turns red when the line is in use remotely.

Calls on shared lines can be transferred, put on hold, or added to a conference.

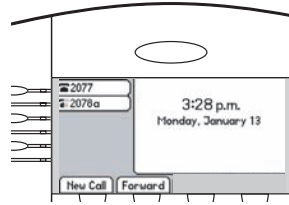

***Shared lines are an optional feature configured on the server and may not be supported on your particular system. Contact your system administrator to find out.*

Voice Mail

Received messages will be indicated by a flashing Message Waiting Indicator LED on the front of the phone and optionally a visual notification on the display.

Individual line indicators reflect voice or text messages left on that line (useful if multiple lines are in use).

To listen to voice messages:

1. Press **Messages**.
2. Select **Message Center** * †.
3. (Optional) If multiple lines are in use, select from which line messages are to be retrieved.
4. Display indicates number of messages and their importance. Press **Connect** to initiate Voice Mail retrieval from the Message Center, OR Press **Clear** to turn off the flashing LED without listening to messages.
5. Follow voice prompts to listen to messages.

**Voice Mail is an optional feature configured on the server and may not be supported on your particular system. Contact your system administrator to find out.*

†Screen options may vary with served-based application. Voice Mail can be accessed with a single key press. Contact your system administrator to configure this option.

Distinctive Ringing / Call Treatment

Users can set distinctive incoming ringing tones for contacts in their local directory. This allows identification of a contact by a specific ring tone.

To set a distinctive ring for a local contact:

1. Press **Directories** and select *Contact Directory*.
2. Using the arrow keys, scroll through the directory to choose a contact.
3. Press **Edit** and scroll down to *Ring Type*.
4. Enter a number corresponding to one of the ring types available (press **▶** then **⊗** to remove an existing value). See **Ring Type** in this guide for further details.
5. Press the **Save** soft key or **Cancel** to abandon the change then press **Directories** to return to the idle display.

Incoming calls from this contact will now have a distinctive ringing pattern.

This feature is local to the phone, and may be over-ridden by server settings. Contact your system administrator for more details.

Multilingual Support (Localization)

Many languages are supported by the phone.

To change language:

1. Press **Menu** and select *Settings, Basic, Preferences, Language*.
2. Scroll through the list of available languages and press the **Select** soft key when the desired language is highlighted.
3. The display will change to the language of your choice.
4. Exit to the idle display by pressing **Menu**.

Phone Reboot

Periodically, the phone may require a user reboot. Reasons for this include accepting a new configuration or new software.

There are two ways to reboot the phone:

- ▶ Simultaneously press and hold the Messages, Microphone Mute, and Volume keys (see illustration) for more than 3 seconds or until a beep is heard.
- ▶ Press **Menu** and select *Settings, Advanced, Restart Phone* (the user password is required to access this menu).

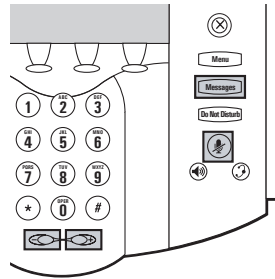

The reboot process will begin and is complete when the idle display is shown.

In the case of problems, it may be possible to restore normal operation of your phone without rebooting. Contact your system administrator before attempting to reboot the phone.

Optional Features

Text Messaging

Users can send and receive Text messages on the phone. SIP Instant (Text) Messaging is supported in real-time. Received messages will be indicated by a flashing

Message Waiting Indicator LED on the front of the phone and optionally a visual notification on the display.

To read text messages:

1. Press **Messages** and select *Instant Messages*,
OR
Press the **InstMsg** soft key to read a message just received.
2. (Optional) If multiple lines are in use, select from which line messages are to be retrieved.
3. Messages appear first to last in sent order.
4. Press the **Next** or **Prev** soft keys to cycle through messages in order.
5. Press the **More** soft key to access the **Delete**, **Reply** and **New** options.

To send a text message:

1. Press **Messages**.
2. Select *Instant Messages*.
3. (Optional) If multiple lines are in use, first select from which line to send a message.
4. Press the **New** soft key.
5. Enter the desired extension or SIP URL. Press the **1/A/a** soft key to alternate between numeric and upper/lower case alphanumeric modes.
6. Press the **Select** soft key to choose from various pre-scripted short messages.

OR

Press **Edit** to compose a custom message. Use dialpad keys to cycle through the character set. Use keys 1,*,0, and # to select special characters.

7. Press **Send** when finished.

Presence / Status / Buddy Lists

The phone combines interactive message services and status monitoring to complement a traditional messaging application such as email.

Live interaction within a pool of phones is possible by monitoring the “presence” of the parties involved.

Each phone can “watch” the status of up to eight other phones. These other phones form the “Buddy List”. The status of buddies is displayed and updated in real time. Each phone can also be “watched” by up to eight other phones.

To add or delete a contact from your buddy list, or block a contact:

1. Press **Directories** and select *Contact Directory*.
2. Using the arrow keys, scroll through the directory to choose a contact.
3. Press **Edit** and scroll down to the *Watch Buddy* or *Block Buddy* fields.
4. Press **⏪** to switch between Enabled or Disabled status.
5. Press the **Save** soft key or **Cancel** to abandon the change then press **Directories** to return to the idle display.

The diagrams show a typical Buddy Status screen display of monitored phones and a My Status display.

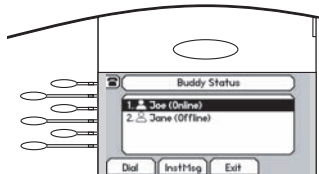
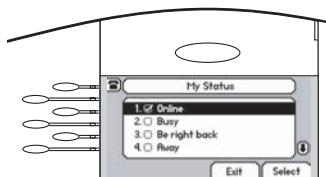

To view and change Presence settings:

1. Press **Menu** and select *Features and Presence*.
2. Choose *My Status* to change your own status (online, busy, etc.). This affects information sent to watching phones. Presence information will also be sent to watching phones when the user goes off-hook or invokes Do Not Disturb. The *My Status* display can also be accessed by pressing the **MyStat** soft key from the idle display.
3. Choose *Buddy Status* to monitor the status of the contacts within your buddy list. This can also be accessed by pressing the **Buddies** soft key on the idle display.
4. Choose *Watcher List* to see which phones are currently monitoring your status. Press the **Block** soft key to block a watcher.
5. Choose *Blocked List* to see which phones you have blocked from monitoring your status. Press the **Unblock** soft key to unblock a contact.

The software running on the phone is compatible with Windows™ and MSN Messenger™ for peer-to-peer presence and instant messaging.

SoundPoint® IP Expansion Module

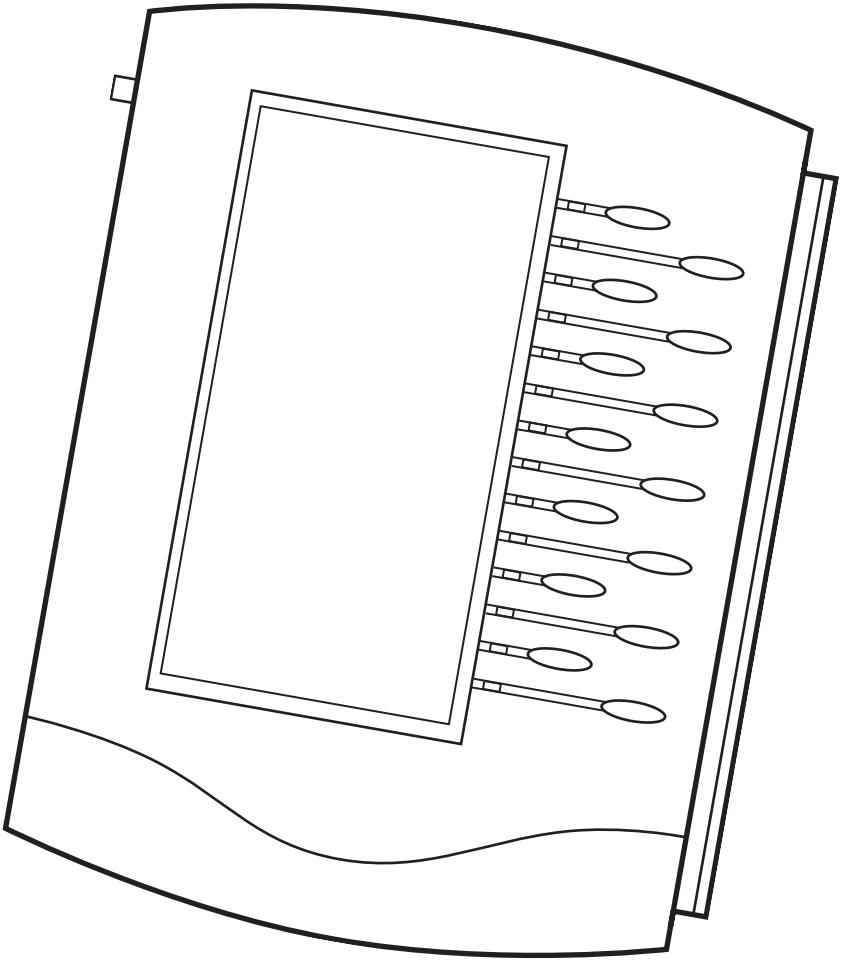

Introduction

Thank you for choosing the SoundPoint® IP Expansion Module, a 14-line console that expands the potential of call handling when used with the SoundPoint® IP 601 phone. Up to three SoundPoint® IP Expansion Modules can be cascaded to a single host phone increasing the total number of buttons to 48 for intensive business IP telephony users.

Each of the 14 keys on the SoundPoint® IP Expansion Module features individual

bi-color LED indicators, allowing easy recognition of line or call state. Keys may be programmed for speed dials or directory numbers (DN).

Installation and configuration of the SoundPoint® IP Expansion Module is easy, since power and signaling are taken from the host SoundPoint® IP 601 phone upon connection. No extra wires or power supplies are required for the SoundPoint® IP Expansion Module.

Parts List

The following items are included in your SoundPoint® IP Expansion Module package. Check this list before installation to ensure that you have received both items.

If you are missing an item, please contact your system administrator.

SoundPoint® IP Expansion Module

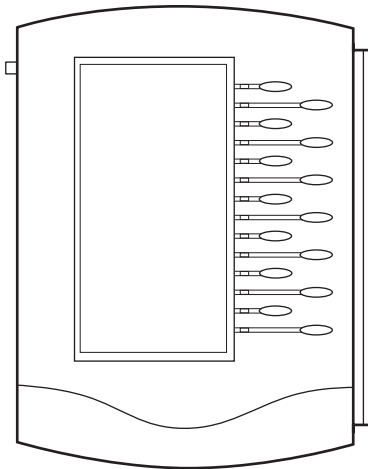

Base Stand

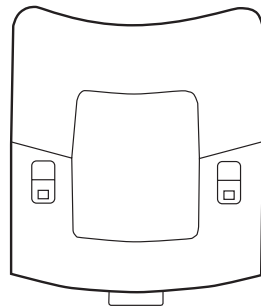

Installing the SoundPoint® IP Expansion Module

This section provides basic installation instructions and information for obtaining the best performance with the SoundPoint® IP Expansion Module. If you require additional information or assistance with your new phone, please contact your system administrator.

The SoundPoint® IP 601 User Guide includes regulatory compliance information that your system administrator should review and can also be found at www.polycom.com.

- ① Remove the rubber plug from the SoundPoint® IP 601 or the SoundPoint® IP Expansion Module.

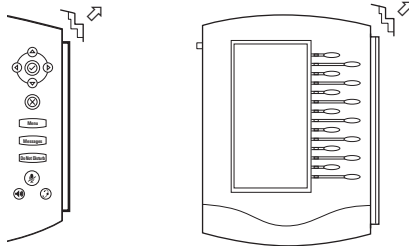

- ② Align the SoundPoint® IP Expansion Module at the top of the groove lines on the SoundPoint® IP 601 phone and slide it downwards until it clicks into position. Connect the Base Stand by aligning the two protrusions on the stand to the holes on the back of the ExMod and snap it into place.

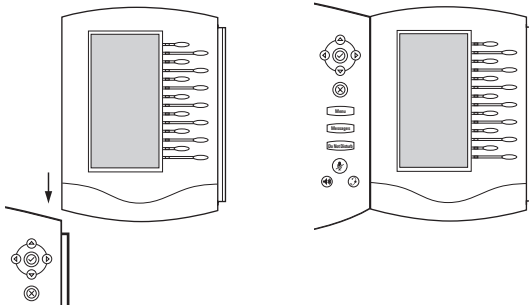

- ③ To connect up to three SoundPoint® IP Expansion Modules together, repeat steps ① and ②.

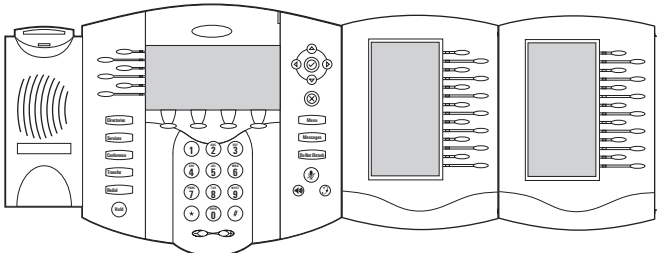

Features

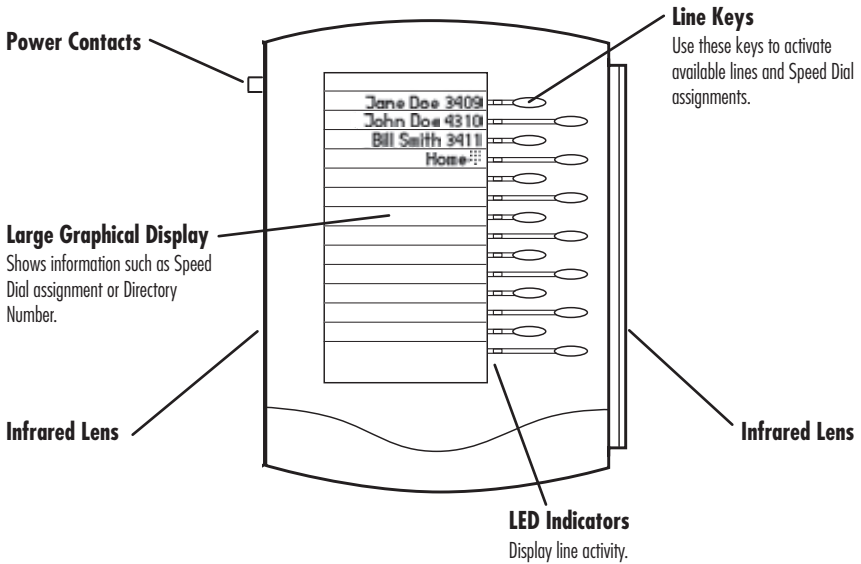

Base Stand

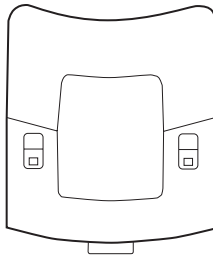

Power is automatically transferred from the host SoundPoint® IP 601 phone to the SoundPoint® IP Expansion Module(s) upon connection.

Units may be plugged in and unplugged (hot swapped) at any time to a live SoundPoint® IP 601 host phone.

Using SoundPoint® IP Expansion Module

To Place a Call

Line keys on the SoundPoint® IP Expansion Module activate available lines. To place a call from an available line, press the corresponding line key and dial the desired number,

OR

Press the line key of the Speed Dial assignment you wish to call.

For other call-handling functions such as Hold, Redial, and Call Forwarding, please see the relevant sections earlier in this User Guide.

To Answer a Call

Press the line key with the flashing green LED indicator.

Display Contrast

To adjust the contrast on the display to a comfortable level:

1. Press **Menu**. Select *Settings* followed by *Basic, Contrast*.
2. The display on the SoundPoint® IP Expansion Module(s) will change, presenting a new display along with line keys that are assigned **Up** or **Down** status. Pressing the **Up** or **Down** line keys will increase or decrease the display contrast.
3. Press the **Ok** or **Cancel** soft keys on the phone to accept or reject changes.
4. Press **Menu** or the **Exit** soft key to return to the idle display.

Speed Dial

You can create up to 47 speed dial entries when three SoundPoint® IP Expansion Modules are attached. To add speed dial entries, see the sections **Contact Directory** and **Speed Dial** earlier in this User Guide. The SoundPoint® IP Expansion Module will assign line designations to the first available line keys and then follow them with speed dial assignments.

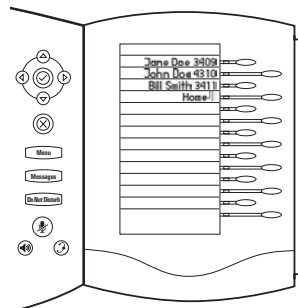

Troubleshooting

No Dial-Tone

Verify power is correctly applied to the SoundPoint® IP 601 SIP phone:

- Check that the display is illuminated.
- Make sure the LAN cable is inserted properly at the rear of the phone (try unplugging and re-inserting the cable).
- If using inline powering, check that the switch is supplying power to the phone (contact your System Administrator).

Verify if dial tone is present on any other audio paths:

- Switch between handset, headset (if present) or hands-free to see if dial tone is present on these other paths.
- If dial tone exists on one of these, connect a different handset or headset to isolate the problem.

No Display, Incorrect Display, or Bad Contrast

Verify power is correctly applied to the SoundPoint® IP 601 SIP phone:

- As “No Dial-Tone” above.

Verify contrast adjustment:

- Follow the instructions in this User Guide to readjust the contrast to a darker level.
- Reboot the phone to obtain a default level of contrast (follow the instructions in this User Guide).

Verify successful outbound or inbound calling:

- Place a call to the phone under investigation - check that the display indicates incoming call information.
- Lift the handset. Ensure dial tone is present and place a call to another extension or number, check that the display changes in response.

No Ringing

Verify incoming ring setting and volume levels:

- Adjust the ringing level from the front panel using the volume up/down keys.
- Check that ring type selection is not Silent Ring.

Verify successful outbound or inbound calling:

- As “No Display” above.
- Check same status of handset, headset (if connected) and through the hands-free speakerphone.

No Audio on Headset

Verify correct connections:

- Ensure the headset is plugged into the jack marked **Headset** at the rear of the phone.
- Ensure the headset amplifier (if present) is turned on and/or the volume is correctly adjusted.
- Ensure that headset is compatible with the phone.

No Response from Feature Key Presses

Verify phone is in active state:

- Make a call to the phone to check for inbound call display and ringing as normal. If successful, try to press feature keys within the call to access Directory or Buddy Status for example.
- Press  followed by *System Status* and *Server Status* to confirm line is actively registered to the server.
- Reboot the phone to attempt re-registration to the server.

Display shows “Network Link is Down”

Verify LAN cable is properly connected:

- Check termination at the switch or hub (furthest end of the cable from the phone).
- Check that the switch or hub is operational (flashing link/status lights) or contact your System Administrator.
- Press  followed by *System Status* and *Network Status*. Scroll down to verify LAN port is Active.
- Reboot the phone to attempt reconnection to the network.

Safety and Compliance

Part 15 Rules

This device complies with Part 15 of the FCC Rules. Operation is subject to the following two conditions:

1. This device may not cause harmful interference, and
2. This device must accept any interferences received, including interference that may cause undesired operation.

Class B Digital Device or Peripheral

Note: This equipment has been tested and found to comply with the limits for a Class B digital device, pursuant to Part 15 of the FCC Rules. These limits are designed to provide reasonable protection against harmful interference in a residential installation. This equipment generates, uses, and can radiate radio frequency energy and, if not installed and used in accordance with the instructions, may cause harmful interference to radio communications. However, there is no guarantee that interference will not occur in a particular installation. If this equipment does cause harmful interference to radio or television reception, which can be determined by turning the equipment off

and on, the user is encouraged to try to correct the interference by one or more of the following measures:

1. Reorient or relocate the receiving antenna.
2. Increase the separation between the equipment and receiver.
3. Connect the equipment into an outlet on a circuit different from that to which the receiver is connected.
4. Consult the dealer or an experienced radio/TV technician for help.

Modifications

In accordance with Part 15 of the FCC Rules, the user is cautioned that any changes or modifications not expressly approved

by Polycom, Inc. could void the user's authority to operate the equipment.

Installation Instructions

Installation must be performed in accordance with all relevant national wiring rules.

L'Installation doit être exécutée conformément à tous les règlements nationaux applicable au filage électrique.

Plugs Acts as Disconnect Device

The socket outlet to which this apparatus is connected must be installed near the equipment and must always be readily accessible.

La prise électrique à laquelle l'appareil est branché doit être installée près de l'équipement et doit toujours être facilement accessible.

Industry Canada (IC)

This Class [B] digital apparatus complies with Canadian ICES-003.

Cet appareil numérique de la classe [B] est conforme à la norme NMB-003 du Canada.

CE and VCCI Mark

This SoundPoint® IP 601 SIP has been marked with the CE mark. This mark indicates compliance with EEC directories 89/336/EEC and 73/23/EEC.

A full copy of the Declaration of Conformity can be obtained from Polycom Ltd., 270 Bath Road, Slough, Berkshire, SL1 4DX, UK.

この装置は、情報処理装置等電波障害自主規制協議会（VCCI）の基準に基づくクラスB情報技術装置です。この装置は、家庭環境で使用することを目的としていますが、この装置がラジオやテレビジョン受信機に近接して使用されると、受信障害を引き起こすことがあります。
取扱説明書に従って正しい取り扱いをして下さい。

ADTRAN Limited Warranty and Limitation Liability

LIMITED WARRANTY. ADTRAN, Inc. warrants this product against defects and malfunctions during a one (1) year period from the date of original purchase. If there is a defect or malfunction, ADTRAN, Inc. shall, at its option, and as the exclusive remedy, either repair or replace the telephone set at no charge, if returned within the warranty period. If replacement parts are used in making repairs, these parts may be refurbished, or may contain refurbished materials. If it is necessary to replace the telephone set, it may be replaced with a refurbished telephone of

the same design and color. If it should become necessary to repair or replace a defective or malfunctioning telephone set under this warranty, the provisions of this warranty shall apply to the repaired or replaced telephone set until the expiration of ninety (90) days from the date of pick up, or the date of shipment to you, of the repaired or replacement set, or until the end of the original warranty period, whichever is later. Proof of the original purchase date is to be provided with all telephone sets returned for warranty repairs.

Exclusions

ADTRAN, Inc. does not warrant its telephone sets to be compatible with the equipment of any particular telephone company or PBX manufacturer. This warranty does not extend to damage to products resulting from improper installation or operation, alteration, accident, neglect, abuse, misuse, fire, or natural causes such as storms or floods, after the telephone is in your possession.

ADTRAN, Inc. shall not be liable for any incidental or consequential damages, including, but not limited to, loss, damage, or expense directly or indirectly arising from the customers use of or inability to

use this telephone, either separately or in combination with other equipment. This paragraph, however, shall not apply to consequential damages for injury to the person in the case of telephones used or bought for use primarily for personal, family, or household purposes.

This warranty sets forth the entire liability and obligations of ADTRAN, Inc. with respect to breach of warranty, and the warranties set forth or limited herein are the sole warranties and are in lieu of all other warranties, expressed or implied, including warranties or fitness for particular purpose and merchantability.

Warranty Repair Services

Your ADTRAN certified representative is responsible for handling Warranty and Repair issues. ADTRAN will repair and return this product within the warranty period if it does not meet its published specifications or fails while in service. Additional warranty and repair information should be acquired from your ADTRAN certified representative or

authorized dealer. Should the set fail during the warranty period, repairs to this product may be made only by the manufacturer and its authorized agents, or by others who are legally authorized. This restriction applies during and after the warranty period. Unauthorized repair will void the warranty.

Repair and Return

If you determine that a repair is needed, please contact your ADTRAN certified

representative. They will assist you in the repair and return process.

Service Agreements

Please contact your ADTRAN authorized dealer for information about service

agreements applicable to your product.

Limitation Of Liability

LIMITATION OF LIABILITY. TO THE FULL EXTENT ALLOWED BY LAW, ADTRAN EXCLUDES FOR ITSELF AND ITS SUPPLIERS ANY LIABILITY, WHETHER BASED IN CONTRACT OR TORT (INCLUDING NEGLIGENCE), FOR INCIDENTAL, CONSEQUENTIAL, INDIRECT, SPECIAL, OR PUNITIVE DAMAGES OF ANY KIND, OR FOR LOSS OF REVENUE OR PROFITS, LOSS OF BUSINESS, LOSS OF INFORMATION OR DATA, OR OTHER FINANCIAL LOSS ARISING OUT OF OR IN CONNECTION WITH THE SALE, INSTALLATION, MAINTENANCE,

USE, PERFORMANCE, FAILURE, OR INTERRUPTION OF ITS PRODUCTS, EVEN IF ADTRAN OR ITS AUTHORIZED DEALER HAS BEEN ADVISED OF THE POSSIBILITY OF SUCH DAMAGES, AND LIMITS ITS LIABILITY TO REPAIR, REPLACEMENT, OR REFUND OF THE PURCHASE PRICE PAID, AT ADTRAN'S OPTION. THIS DISCLAIMER OF LIABILITY FOR DAMAGES WILL NOT BE AFFECTED IF ANY REMEDY PROVIDED HEREIN SHALL FAIL OF ITS ESSENTIAL PURPOSE.

Disclaimer

Some countries, states, or provinces do not allow the exclusion or limitation of implied warranties or the limitation of incidental or consequential damages for certain products supplied to consumers, or the limitation of liability for personal injury, so the above limitations and exclusions may be limited in their

application to you. When the implied warranties are not allowed to be excluded in their entirety, they will be limited to the duration of the applicable written warranty. This warranty gives you specific legal rights which may vary depending on local law.

Governing Law

This Limited Warranty and Limitation of Liability shall be governed by the laws of the State of Alabama, U.S.A., and by the laws of the United States, excluding their conflicts of laws principles. The United Nations Convention on Contracts for the

International Sale of Goods is hereby excluded in its entirety from application to this Limited Warranty and Limitation of Liability. All rights reserved under International and Pan-American Copyright Conventions. No part of the

contents of this manual may be copied, reproduced, or transmitted in any form or by any means, or translated into another language or format, in whole or part, without written consent from ADTRAN, Inc. Do not remove (or allow anybody else to remove) any product identification,

copyright or other notices. ADTRAN and the ADTRAN logo are registered trademarks of ADTRAN, Inc. All other trademarks and registered trademarks mentioned in this publication are the property of their respective owners.

ADTRAN[®]



POLYCOM[®]

**ADTRAN, Inc.
901 Explorer Blvd.
Huntsville, AL 35806**

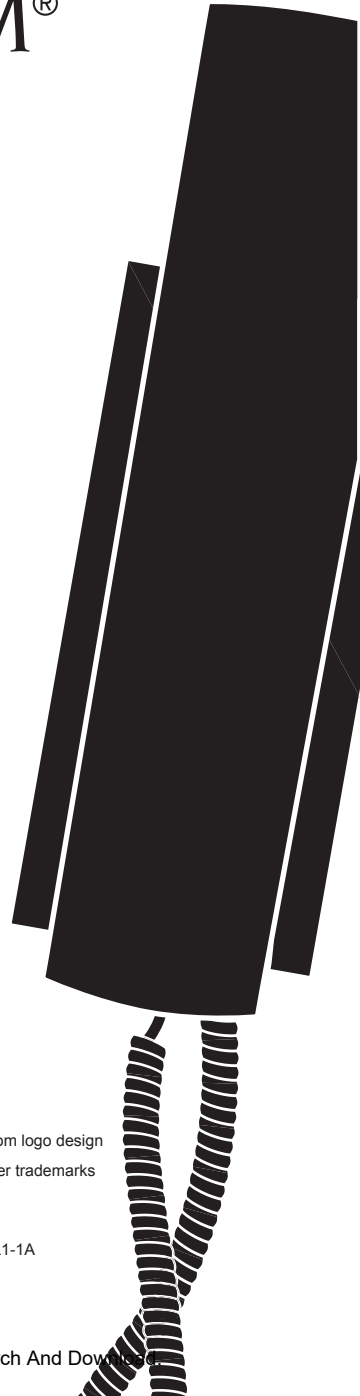

©2006 Polycom, Inc. All Rights Reserved. Polycom®, SoundPoint®, and the Polycom logo design are registered trademarks of Polycom, Inc. in the U.S. and various countries. All other trademarks are the property of their respective companies.

61200778L1-1A

Free Manuals Download Website

<http://myh66.com>

<http://usermanuals.us>

<http://www.somanuals.com>

<http://www.4manuals.cc>

<http://www.manual-lib.com>

<http://www.404manual.com>

<http://www.luxmanual.com>

<http://aubethermostatmanual.com>

Golf course search by state

<http://golfingnear.com>

Email search by domain

<http://emailbydomain.com>

Auto manuals search

<http://auto.somanuals.com>

TV manuals search

<http://tv.somanuals.com>