

Service Overview

Carefully read through this chapter for a look at various components of the notebook and necessary cautions and tools before performing any service and repairs.

To provide the best service and support for the ASUS S96J Series, we have provided the below information for technicians from distributors and resellers to perform the complete notebook disassembly and assembly. But before performing the procedures, please be sure to read through the overview in this chapter for component overview, cautions and tools to avoid any unwarranted damages to the notebook's hardware.

The following chapter includes:

- S96J Overview
- Components
- Precautions
- Appropriate Tools

S96J Series Overview and Components

The ASUS S96 Series Notebook is a product combining the power of Intel® Pentium M CPU with uFC-PGA mobile system. In this section, an overview for the S96J, along with its components, will be presented.

OVERVIEW

S96J Overview

The illustrations below show the notebook's overview from front view, right side view, left side view, and rear side view. Most of the parts will be discussed in this manual.

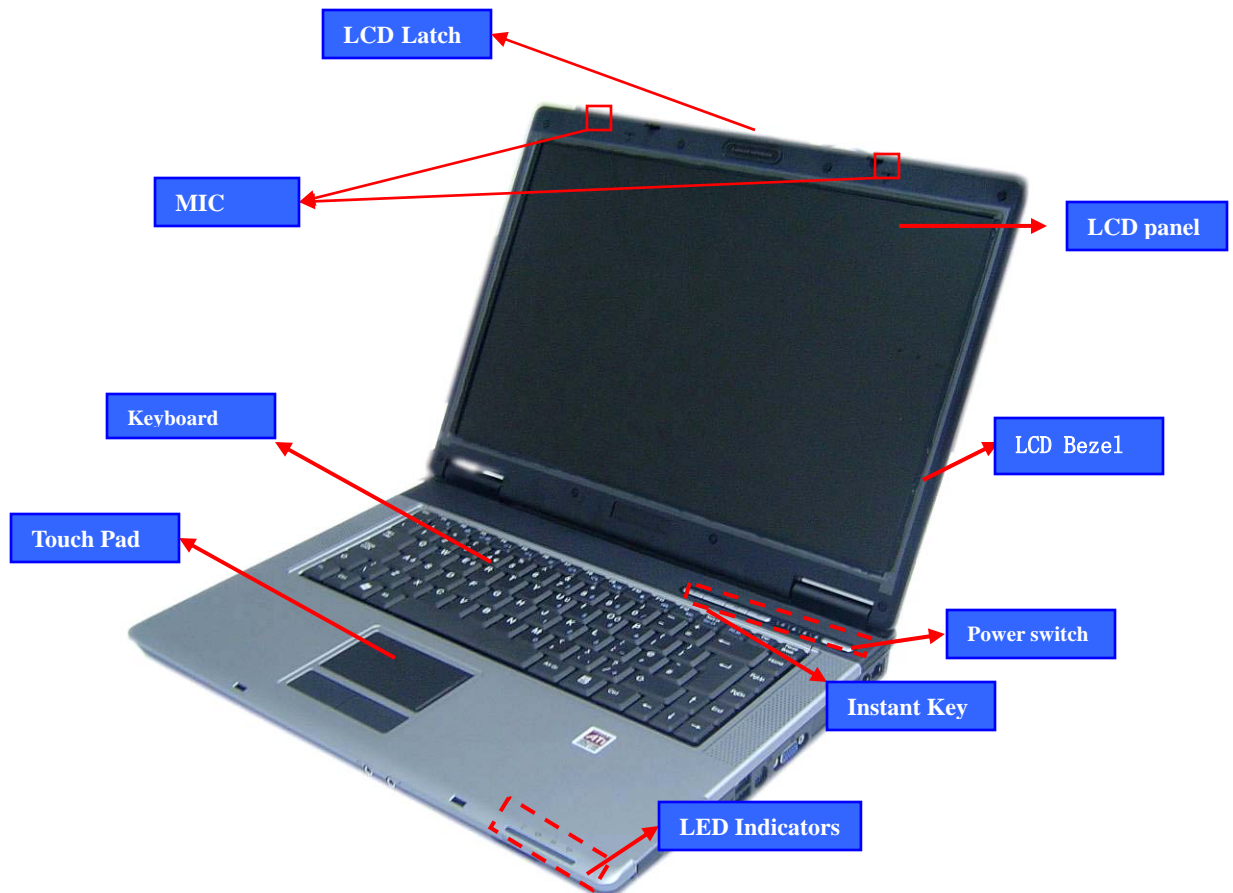

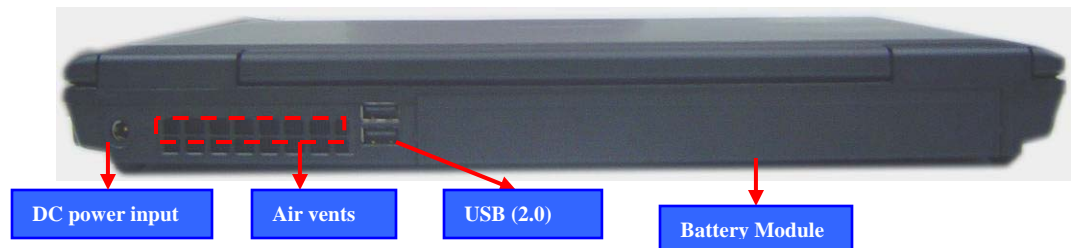
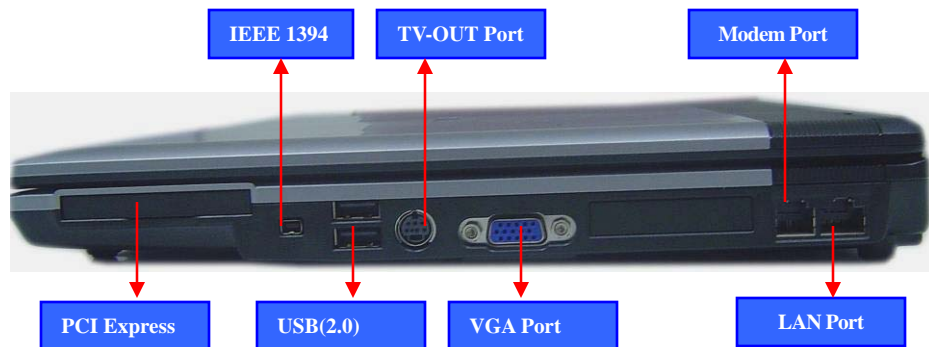
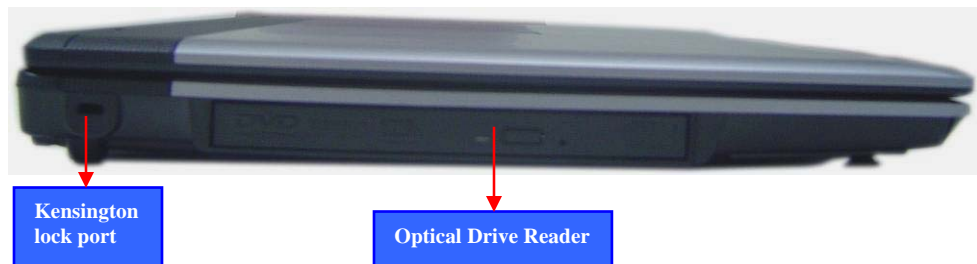
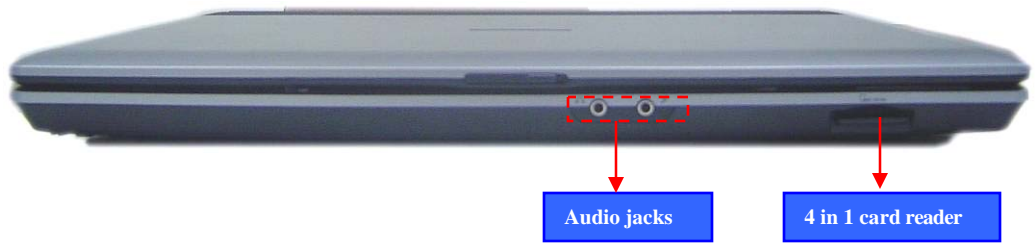

COMPONENTS

Components

The illustrations below show the components of the S96J Series.

LCD

LCD Panel*

The illustration below shows the LCD display panel. The S96J Series notebook comes with 15.4" TFT LCD Panel.



LCD BRACKETS

LCD Bracket

The illustration below shows the LCD Bracket.



INVERTER BOARD MODULE

Inverter Board

The illustration below shows the inverter board, which is hidden underneath the lower edge of the LCD front bezel.



LCD HINGE

LCD Hinge

The illustration below shows the LCD Hinges.



L C D C A S E

LCD Case

The illustration below shows the LCD case. Here is the LCD front cover, back cover.



K E Y B O A R D

Keyboard

The illustration below shows the keyboard plate. It can be exchanged with keyboard plates with different language layouts, such as U.S., German, Japanese, British, France and others.



T O P C A S E &

Top Case Module

The illustration below shows the top case of the notebook..

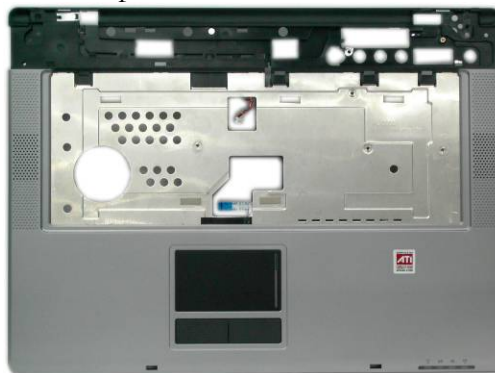

T O U C H P A D

Touch Pad Module

The illustration below shows the Touch Pad module.



BATTERY

Battery Pack

The illustration below shows the battery pack of the notebook. It's located at bottom of the notebook.



OPTICAL
DRIVE

Optical Drive

The illustration below shows the Optical Drive



HDD BRACKET

HDD Bracket

The illustration below shows the HDD Bracket.



HDD DRIVE

Hard Disk Drive

The illustration below shows the 2.5" industry-standard HDD with 9.5mm height.



C P U

uFC-PGA CPU Module

The illustration below shows the Intel uFC-PGA CPU Module, top and bottom views

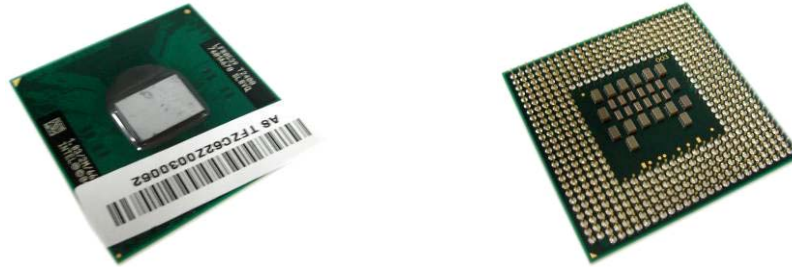

C P U T H E R M A L
M O D U L E

CPU Thermal Module

The illustration below shows the thermal module for the CPU. It's located on the top of CPU.

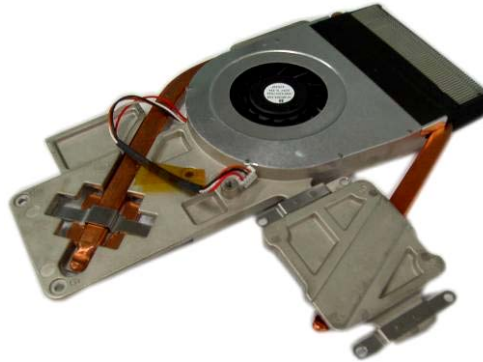

C P U D O O R

CPU door

The illustration below shows CPU door.



MEMORY

Memory Module

The illustration below shows the industry-standard 200pin SO-DIMM DDR SDRAM module for the notebook.



**MOTHER
BOARD
MODULE**

Motherboard Module

The illustration below shows the motherboard module of the notebook.



BOTTOM CASE

Bottom Case Module

The illustration below shows the bottom case module of the notebook. It include speaker sets

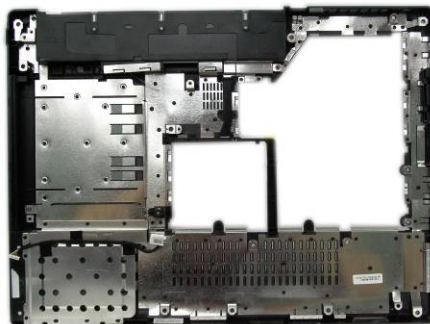

**K/B COVER
MODULE**

K/B Cover Module

The illustration below shows the keyboard cover.



WIRELESS
LAN MODULE

Wireless LAN Module

The illustration below shows the Wireless LAN Module of the notebook. It contains Wireless LAN Card.



BLUETOOTH
MODULE

Bluetooth Module

The illustration below shows the Bluetooth Module of the notebook.



Service Overview

Please pay special attention to the cautions below to prevent any damages to the notebook and also please be sure to select the appropriate tools described in this section to perform any services desired.

CAUTIONS

Precautions

Before you perform any service and/or repair on the notebook, please follow the steps below first.

1. Be sure that the notebook is powered down.
2. Disconnect the AC plug from the notebook



3. Turn the notebook over. Unlock and hold the latches, and remove the battery.



3. Remove all rings, watches and any other metal objects from your hands.

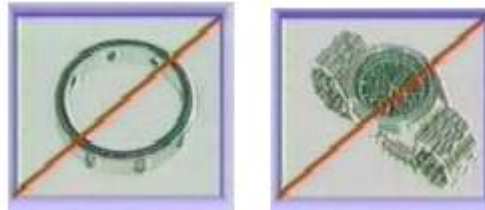

4. Always wear a ground strap on your hand to protect the notebook from static discharge.

 TOOLS

Appropriate Tools

The illustrations below show the appropriate tools that should be used for the notebook's service and repair.

 CROSS
SCREW-
DRIVER

Phillips-head Screwdriver

Use a Phillips-head screwdriver to fasten/remove the K- or B-typed screws.



 FLATHEAD
SCREW-
DRIVER

Single-Slotted Screwdriver

Use a single-slotted screwdriver to lock/unlock the flexible cable connector locks



 TWEEZERS

Tweezers

Use a pair of tweezers to remove/insert flexible cables.



 INSERTION
AND
EXTRACTION
TOOL FOR
FPC
CONNECTOR

Insertion and extraction tool for FPC connector

Use insertion and extraction tool for FPC connector to handle locking and unlocking of FPC connectors.



 VACUUM
HANDLING
TOOL

Vacuum Handling Tool



Disassembly Procedure

Please follow the information provided in this section to perform the complete disassembly procedure of the notebook. Be sure to use proper tools described before.

ASUS S96J Series Notebook consists of various modules. This chapter describes the procedures for the complete notebook disassembly. In addition, in between procedures, the detailed disassembly procedure of individual modules will be provided for your service needs.

The disassembly procedure consists of the following steps:

- Battery Module
- HDD Module
- Memory Module
- WLAN Module
- CPU Module
- Optical Drive Module
- Keyboard Module
- Top Case Module
- Motherboard Module
- Bottom case Module
- LCD Module

BATTERY

Battery Module

The illustration below shows how to remove the battery module.

1. Turn the notebook over. Unlock and hold the latch, and remove the battery.



HDD
MODULE

HDD Module

The illustrations below show how to remove the HDD module from the notebook.

Removing HDD Module

1. Remove 2 screws and take the HDD out.



2. Remove 4 screws to separate HDD from HDD housing



MEMORY
MODULE

Memory Module

The illustration shows how to remove the memory module from the notebook.

Removing Memory module

1. Remove 3 screws and take the CPU door away.



2. Pull two Latches and pop the module up to a 45° angles, and then pulling out the module in that angle.



WLAN
MODULE

WLAN Module

The illustrations below show how to remove the WLAN module from the notebook.

Remove WLAN module

1. Remove 2 Antenna cables from Wireless LAN Module



WLAN
MODULE
REMOVAL

2. Remove 2 screws, then take the WLAN module away.



CPU MODULE
REMOVAL

CPU Module

The illustrations below show how to remove the CPU module from the notebook.

Removing CPU

1. Disconnect the FAN cable and remove 7 screws from 1 to 7, then take away the thermal module

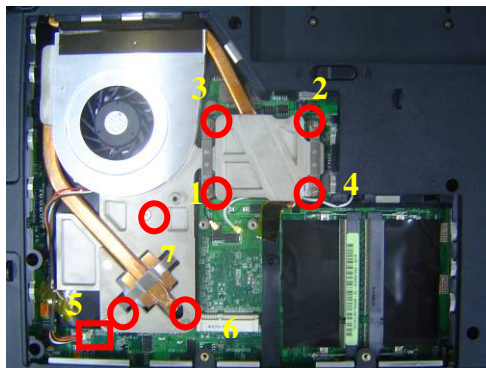

2. Turn the non-removable screw here 180 degrees counter-clockwise to loosen the CPU.



3. Squeeze the vacuum handling pump and use it to lift the CPU away.



Optical Drive Module

OPTICAL
DRIVE
REMOVAL

1. Move 2 screws here, and then pull the ODD module out slowly.



Keyboard Module

KEYBOARD

The illustration of below shows how to remove the keyboard

INDICATOR
COVER
REMOVAL

Removing Keyboard and indicator Cover

1. Remove 3 screws here, and then turn over the notebook.

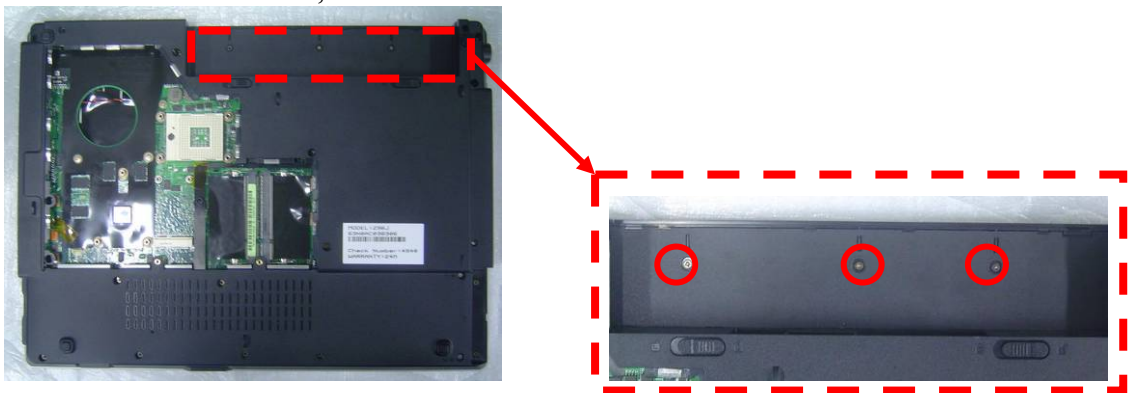

2. Unlock 9 indicator cover latches.



3. Take away indicator cover by hand



4. Pull out the keyboard forward and lay the keyboard on the front side then disconnect the FPC, then take away keyboard.

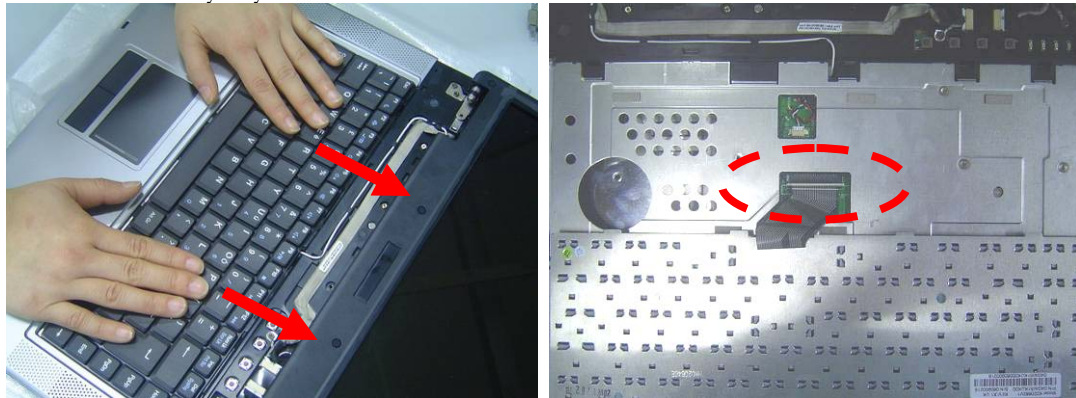

TOP CASE
MODULE

Top Case Module

The illustrations below show how to disassemble and remove the top case module of the notebook. The module contains the top case itself.

TOP CASE
MODULE

Removing top Case Module

1. Remove 6 screws here, and then disconnect the Coaxial & inverter cable.



2. Turn over the notebook, and then remove 2 screws here.



3. Separate the LCD module from the Top Case module



BOTTOM
CASE
REMOVAL

1. Turn over the NB and remove 18 screws on the bottom case.

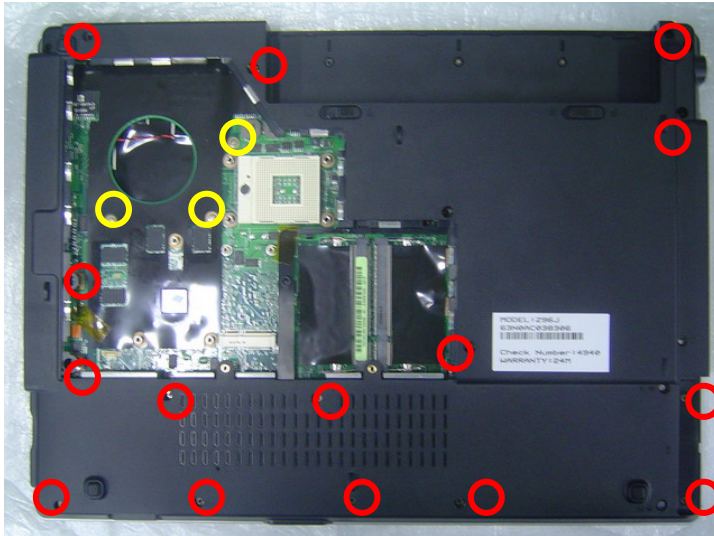

2. Disconnect the Touchpad FPC and Speaker cable

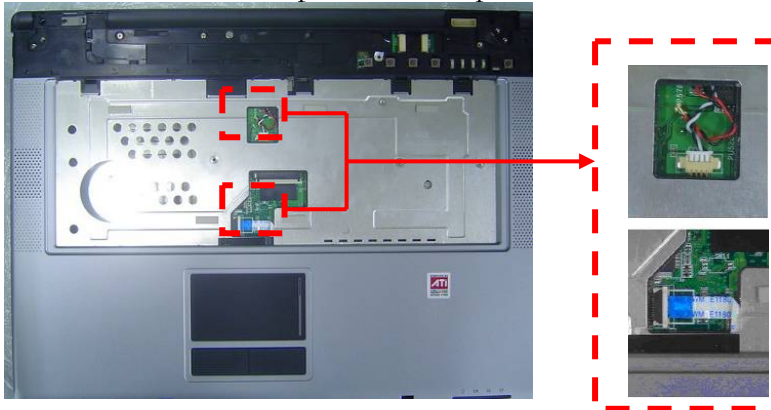

3. Separate the Top case from the bottom case.



TOPCASE
REMOVAL

1. Disconnect the touch pad FFC and then take away the touch pad FPC.

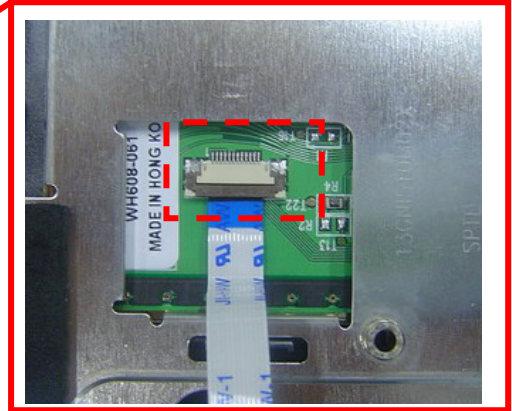
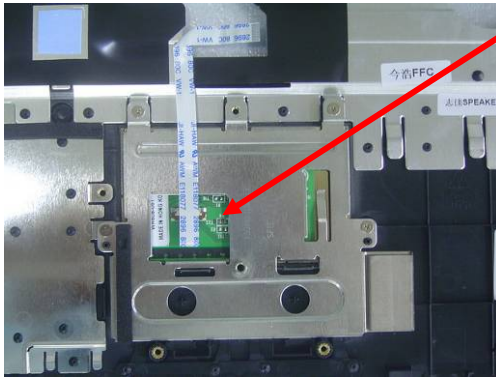

2. Remove 4 screws and take away the touchpad bracket.

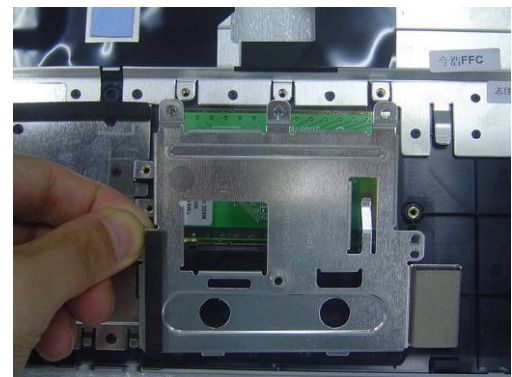
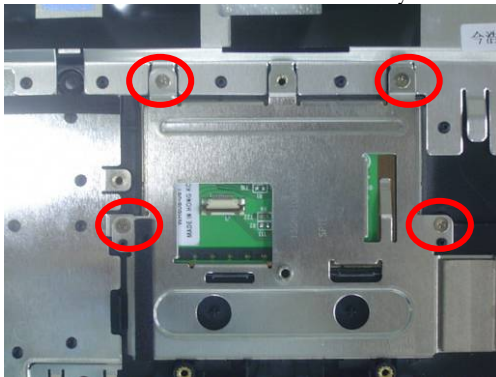

3. Take away the touchpad

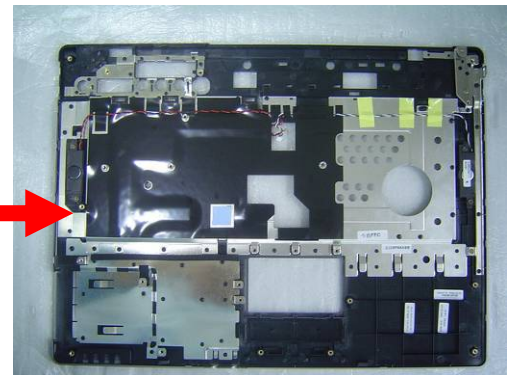

4. Remove 4 screws and take away the speaker module.

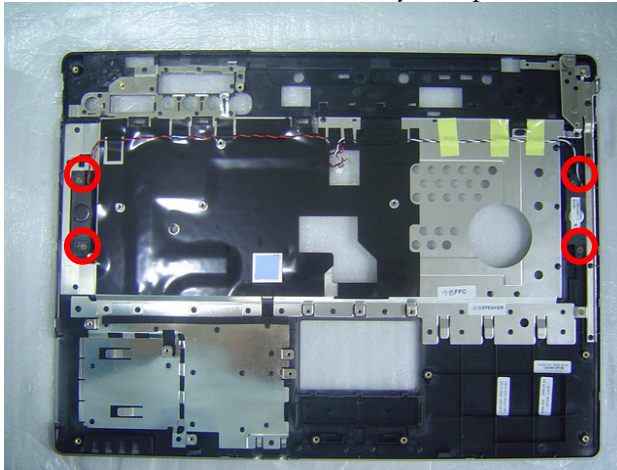

Motherboard

The illustrations below show how to disassemble and remove the Motherboard.

MOTHERBOARD

MOTHERBOARD
REMOVAL

Removing Motherboard

1. Remove 1 screw here and then disconnect the Bluetooth cables then take away the Motherboard.

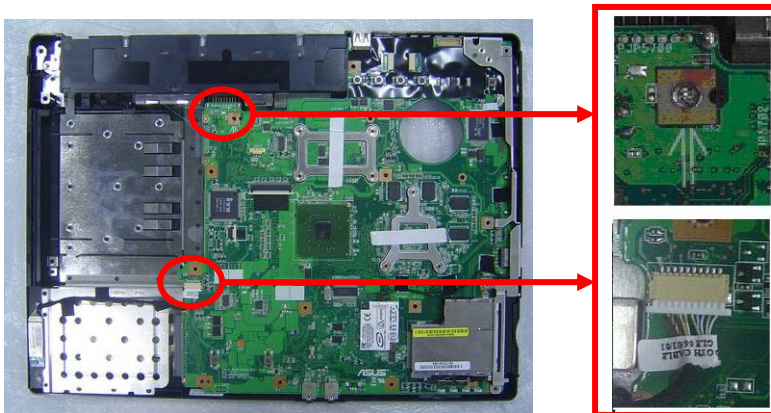

2. Separate the Motherboard from the bottom case.



3. Remove 1 screw on the IO bracket.



4. Remove 2 screws for CRT on the right side by a spacer screwdriver then take away the IO bracket.

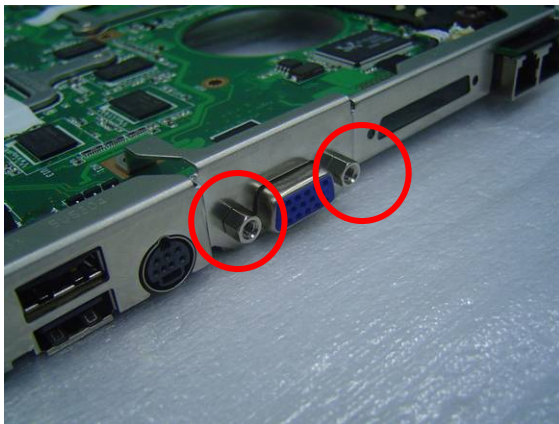

5. Remove 5 pieces of tapes and disconnect the modem cable.

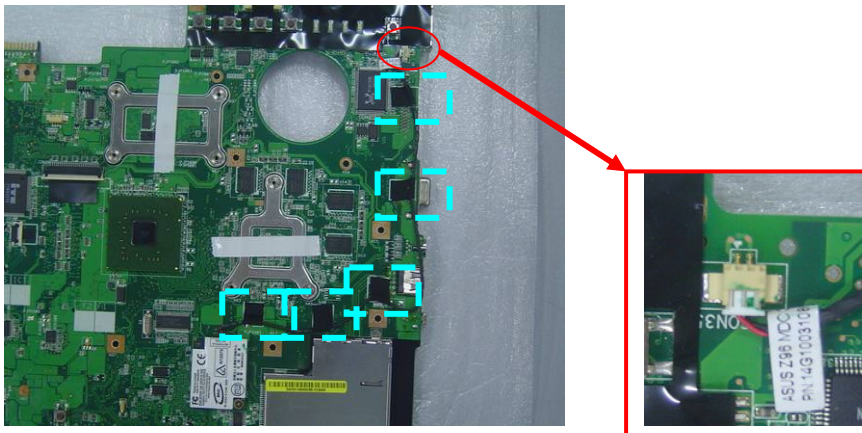

6. Remove 2 screws and take away the modem board.

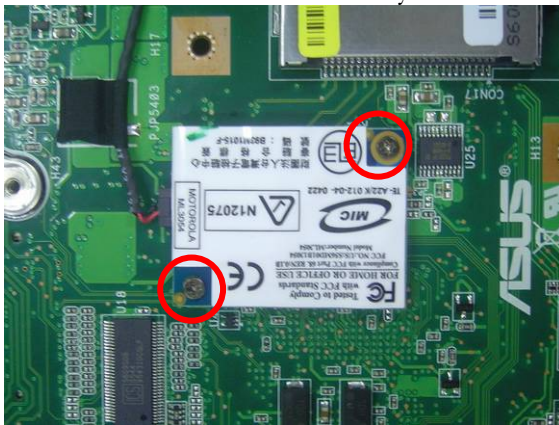

BOTTOM CASE
MODULE

Bottom Case Module

The illustrations below show how to remove and disassemble the Bottom case module. The module contains Bluetooth board, speaker cable.

BOTTOM
CASE
DISASSEMBLY

Disassembling Bottom case Module

1. Remove Bluetooth module from bottom case.

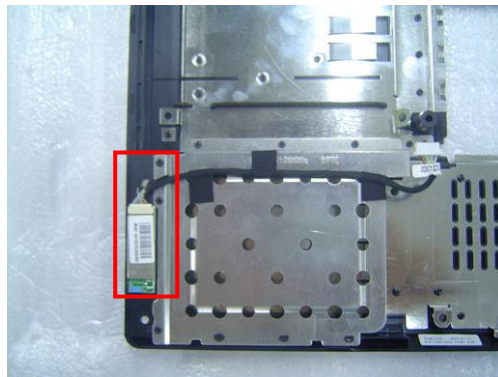

LCD MODULE

LCD Module

The illustrations below show how to remove and disassemble the LCD module. The module contains LCD panel, Inverter board, LCD bezel, LCD back cover.

LCD MODULE
DISASSEMBLY

Disassembling LCD Module

1. Remove 8 rubber pads and 8 screws from LCD module.

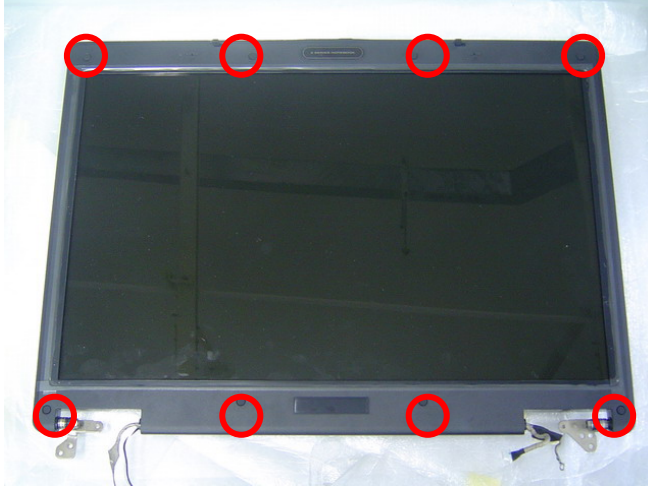

2. Prying the inside edges of the LCD bezel, and then separates it from LCD back cover.

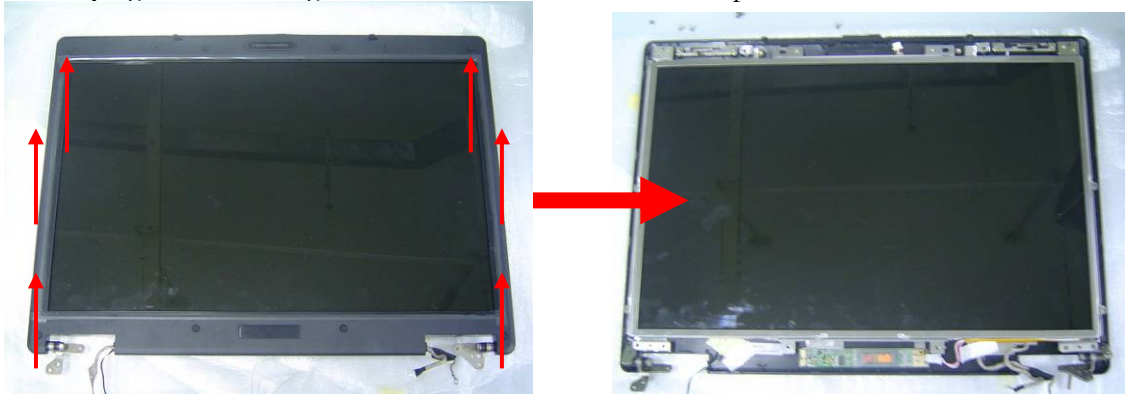

3. Disconnect the LCD cable. and inverter cable

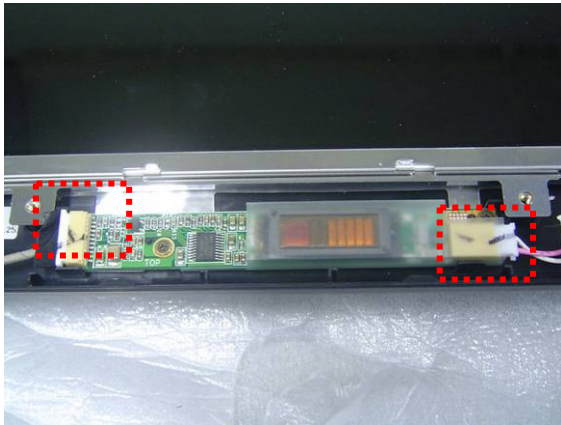

4. Remove 10 screws and take away the LCD panel.

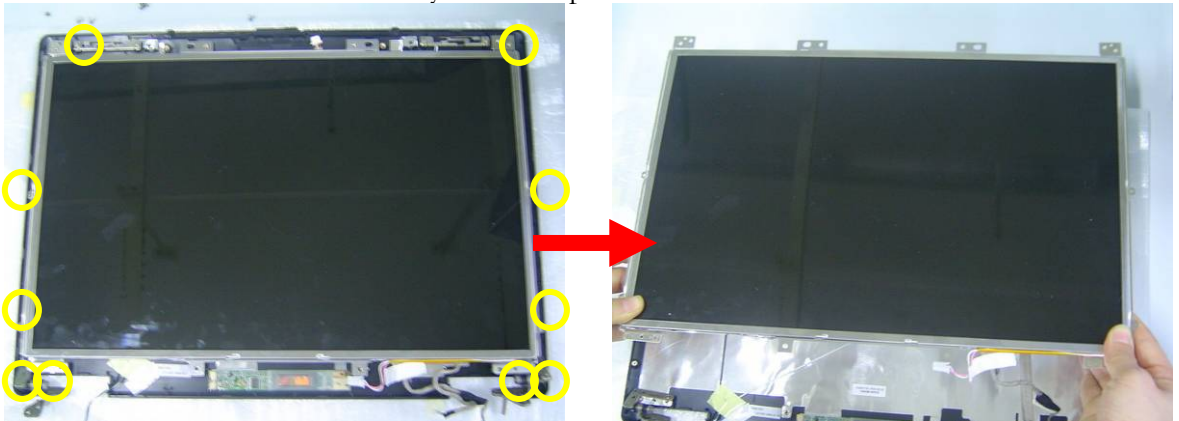

5. Remove 4 screws on the right LCD bracket to disassemble the LCD bracket.

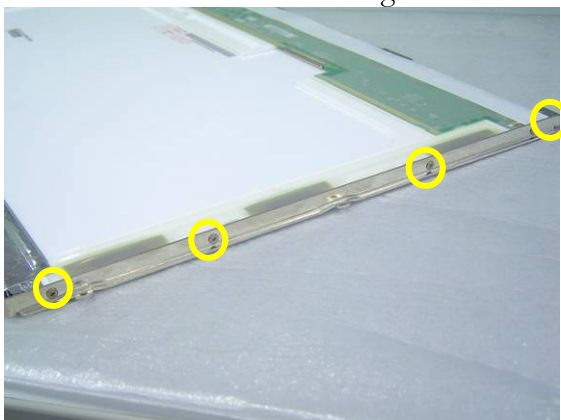

6. Remove 4 screws on the left LCD bracket to disassemble the other LCD bracket.

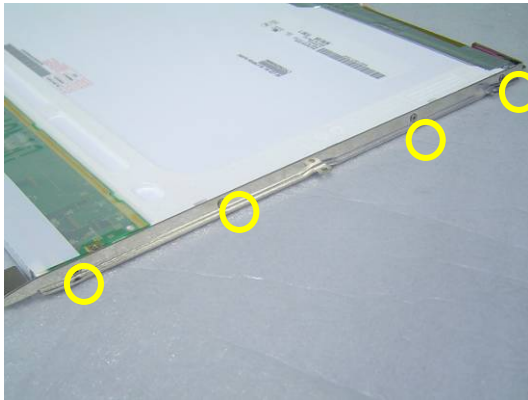

7. Remove 2 pieces of tapes and disconnect the coaxial cable then take it away.

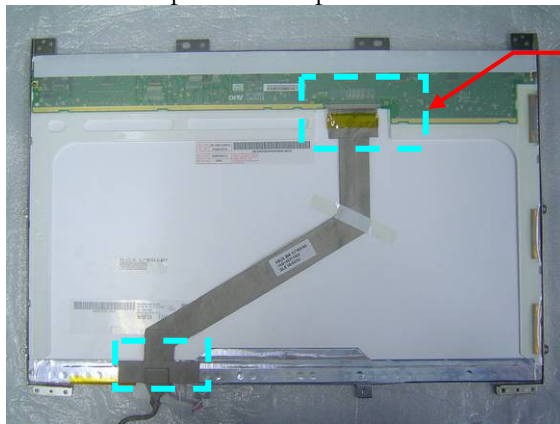

8. Remove 2 screw and then take inverter board away.

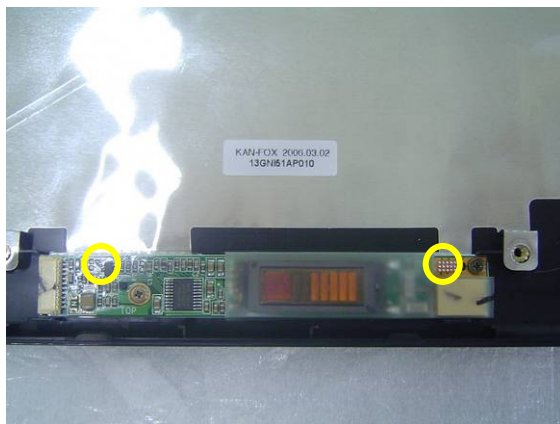

9. Remove both hinge and take them away.

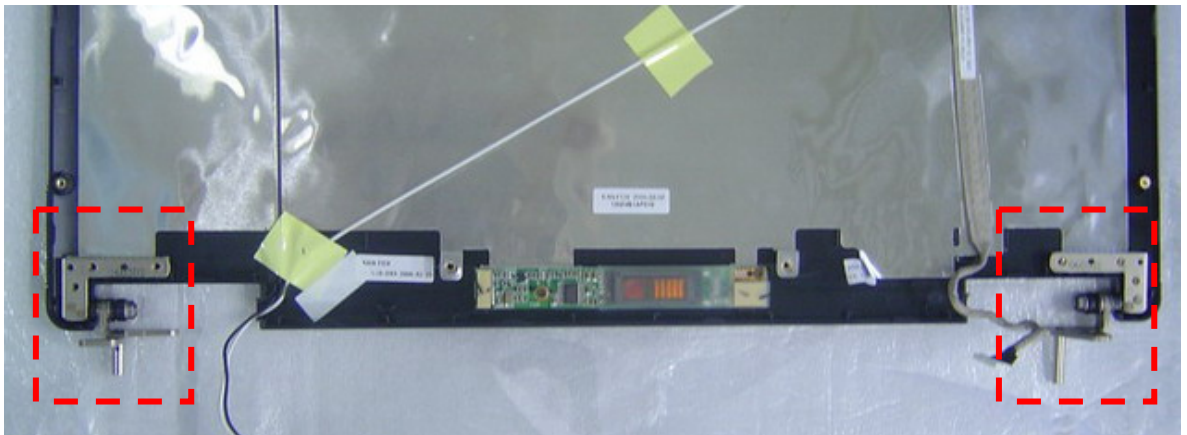

10. Remove 2 screw and remove 2 pieces of tapes then take away the wireless black wire.

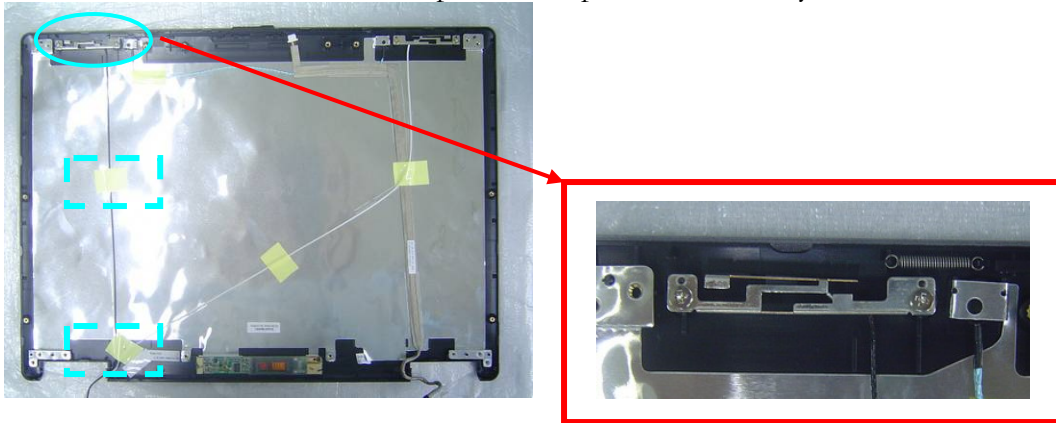

11. Remove 2 screw and remove 2 pieces of tapes then take away the wireless white wire.

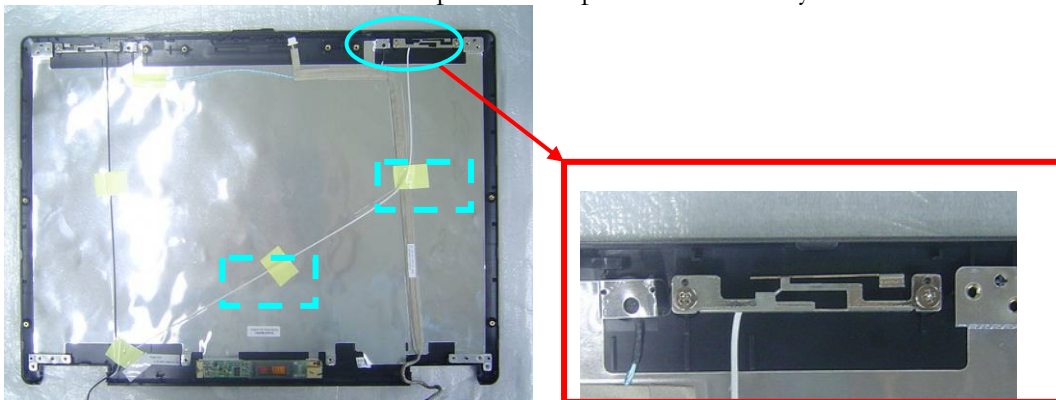

12. Remove the microphone cable from the LCD cover.

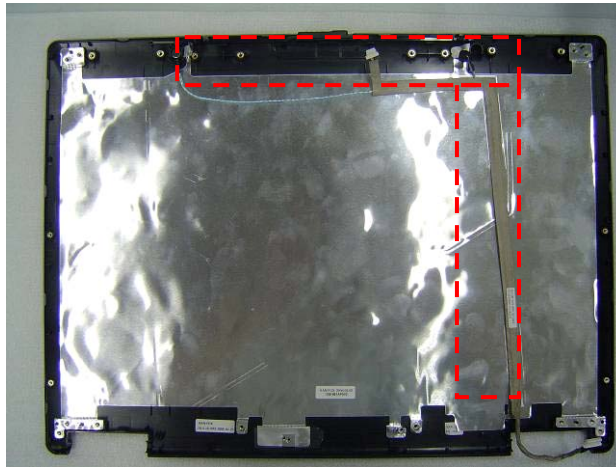

Assembly Procedure

Please follow the information provided in this section to perform the complete assembly procedure of the notebook. Be sure to use proper tools described before.

After you have completed the previous chapter of complete disassembly, please follow this chapter to assemble the notebook back together. This chapter describes the procedures of the complete notebook assembly. In addition, in between procedures, the detailed assembly procedure of individual modules will be provided for your service needs.

The assembly procedure consists of the following steps:

- LCD Module
- Bottom case Module
- Motherboard Module
- Top Case Module
- Keyboard Module
- Optical Drive Module
- CPU Module
- Wireless Module
- Memory Module
- HDD Module
- Battery Module

LCD MODULE

LCD Module

The illustrations below show how to assemble and install the LCD module of the notebook.

LCD MODULE
ASSEMBLY

1. Install the microphone cable on the LCD cover



2. Install the wireless white wire module and secure 2 screws then paste 2 pieces of tapes to secure it.

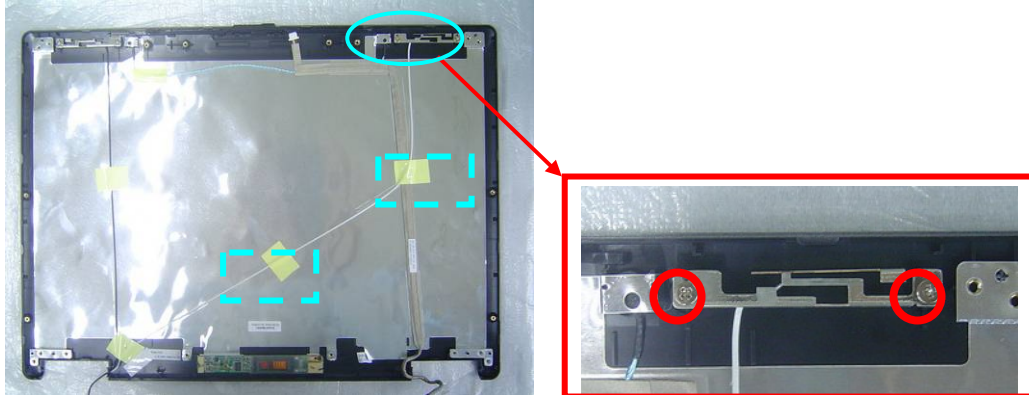

3. Install the wireless black wire module and secure 2 screws then paste 2 pieces of tapes to secure it.

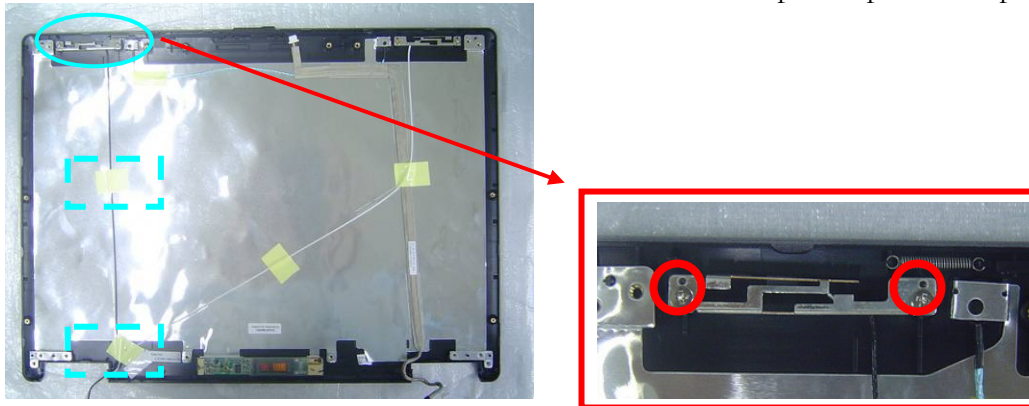

4. Install the both hinge on LCD back cover.

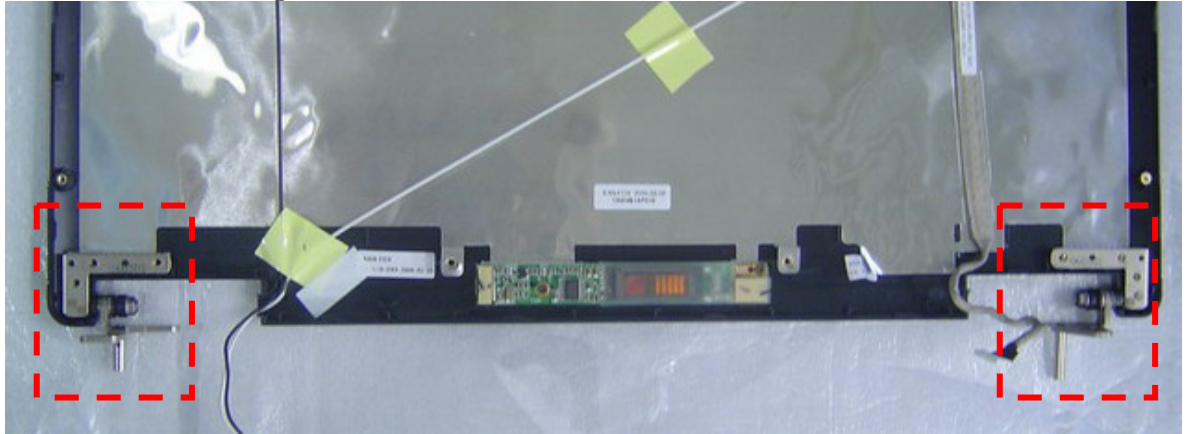

5. Install the inverter board on LCD back cover and then secure 2 screws to secure it.

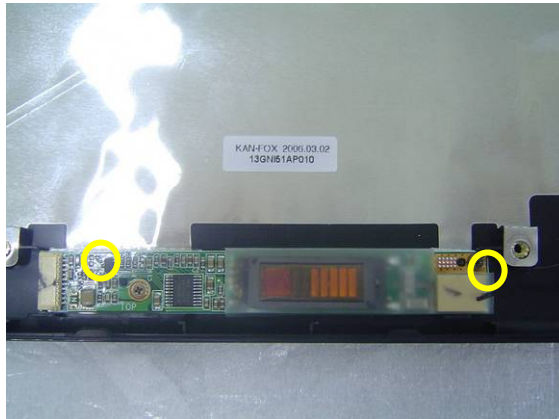

Assembly LCD Module

1. Connect the coaxial cable and paste 2 pieces of tapes to secure it.

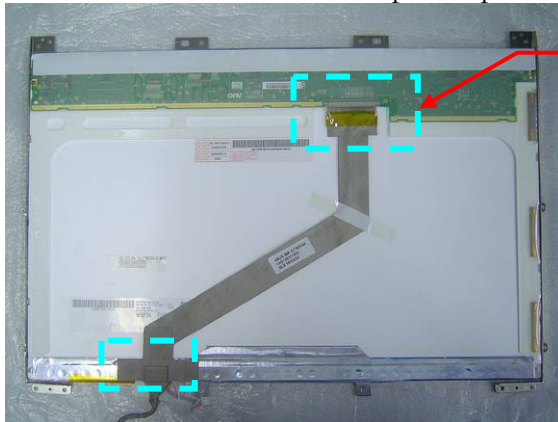

2. Install the left LCD bracket and secure 4 screws to fix it.

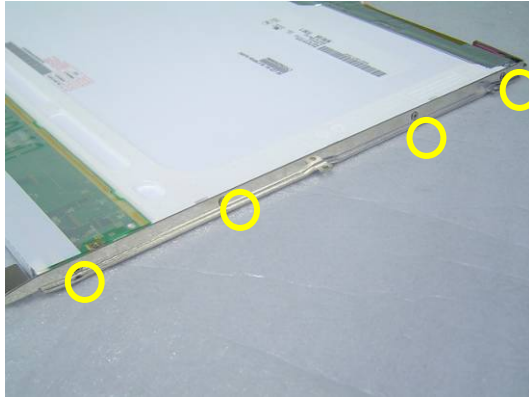

3. Install the right LCD bracket and secure 4 screws to fix it.

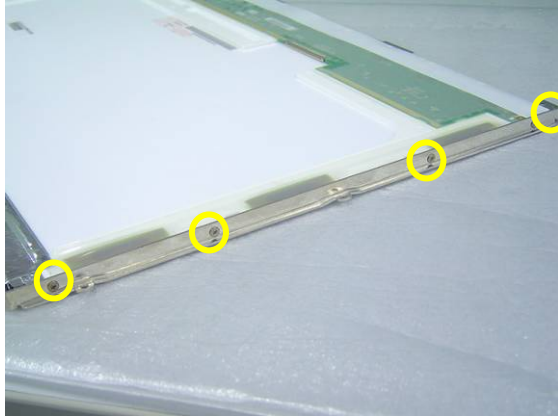

4. Install the LCD panel and secure 10 screws to secure it.

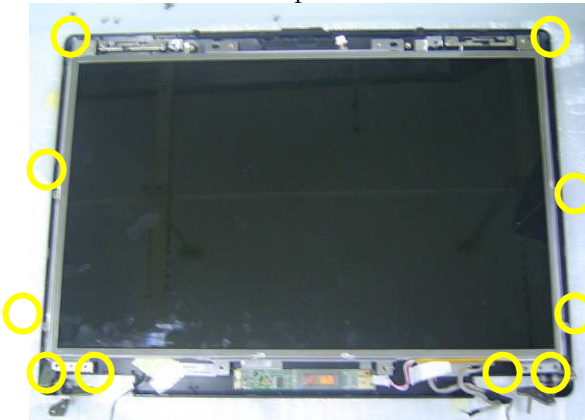

5. Connect the LCD cable. and inverter cable

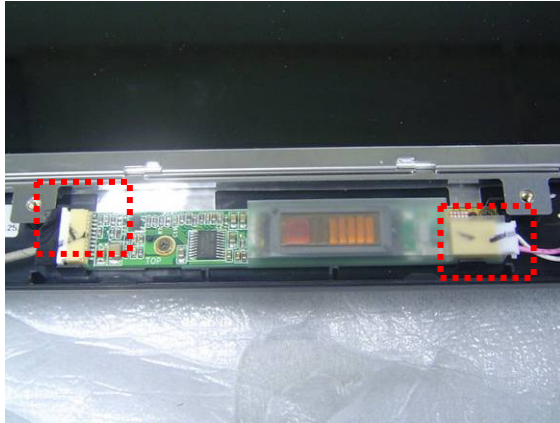

6. Combine the LCD bezel and LCD Cover properly and press on all four edges until they snap into position.



7. Secure 8 screws on LCD front bezel then paste 7 rubber pads above.

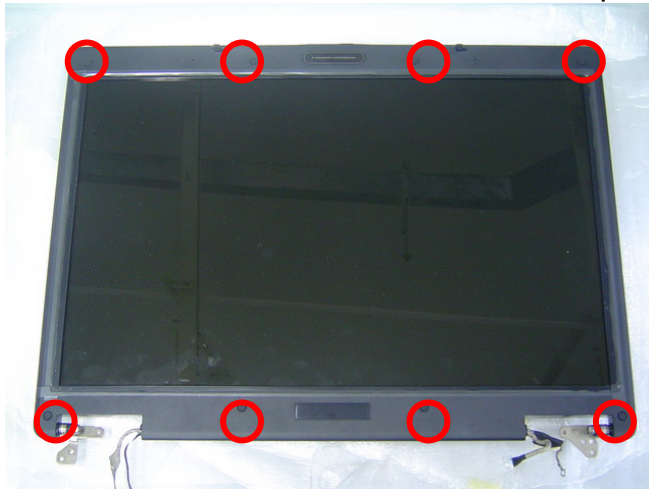

BOTTOM
CASE
MODULE

Bottom Case Module

The illustrations below show how to assembly the Bottom case module. The module contains Bluetooth board, speaker cable.

BOTTOM
CASE ASSEMBLY

Assembling Bottom case Module

1. Install the Bluetooth module on the bottom case.

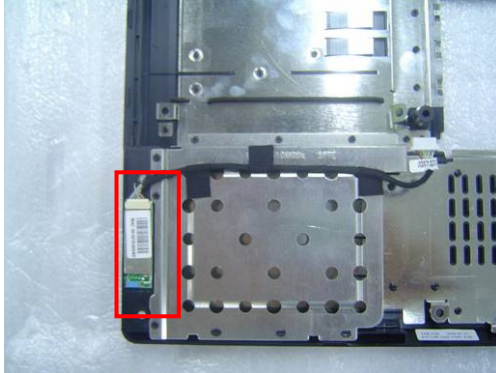

MOTHERBOARD

Motherboard

The illustrations below show how to assemble and install the motherboard of the notebook.

MOTHERBOARD
ASSEMBLY

1. Install the modem board and secure 2 screws.

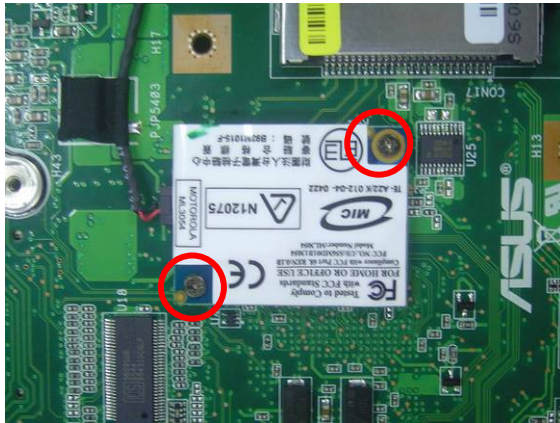

2. Connect the modem cable and paste 5 pieces of tape to fix the cable.

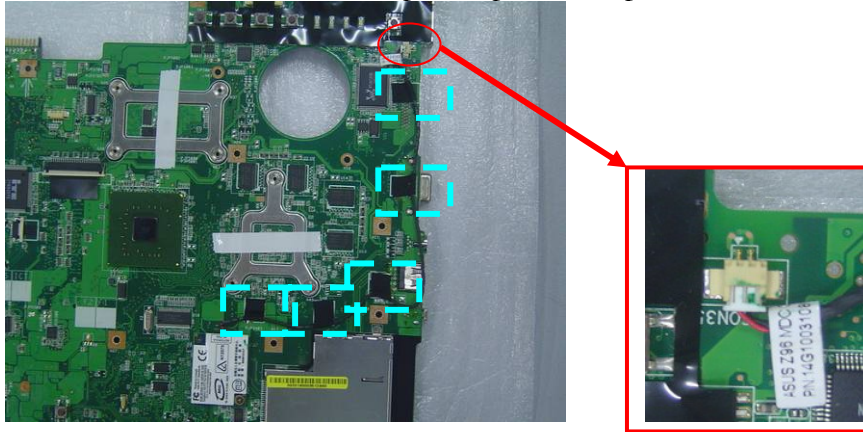

3. Secure 2 screws for CRT on the right side by a spacer screwdriver.

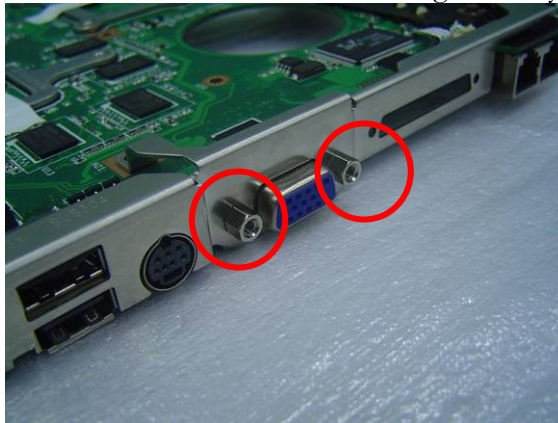

4. Secure 1 screw on the IO bracket to secure it.

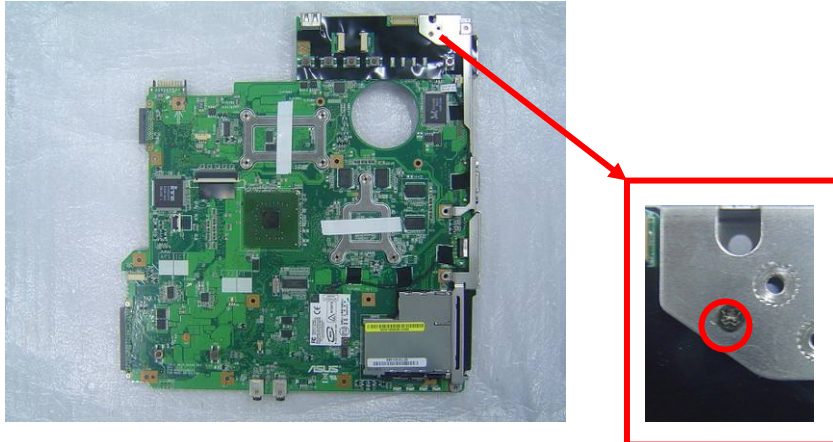

5. Combine the Motherboard and the bottom case.



6. Secure 1 screw here and then connect the Bluetooth cables in the motherboard.

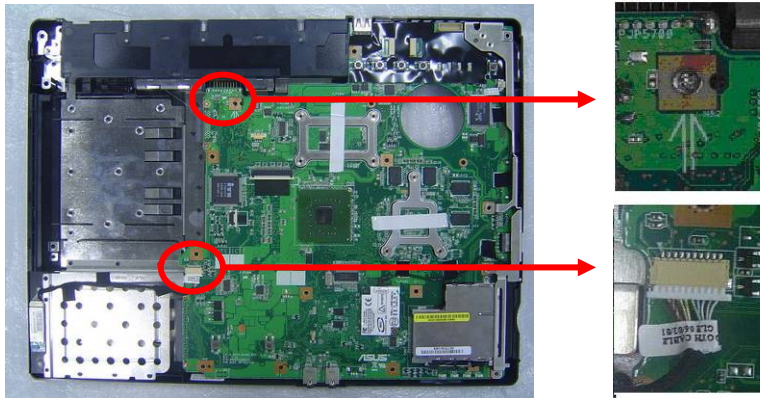

TOP CASE
MODULE

Top Case Module

The illustrations below show how to assemble and install the top case module of the notebook.

1. Install the speaker module on the Top case Module and then secure 4 screws

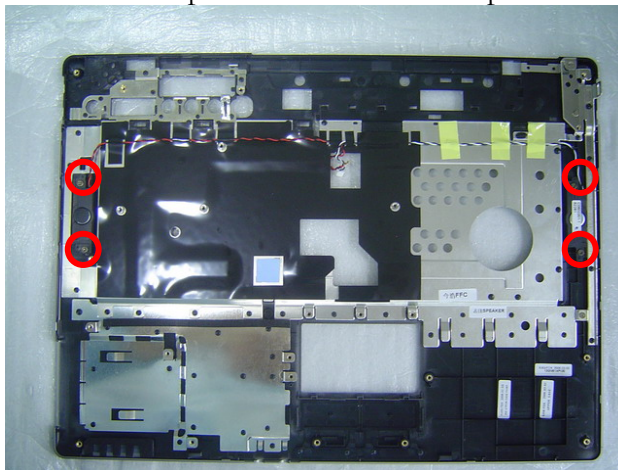

TOP
CASE
ASSEMBLY

2. Install the touchpad on the top case.

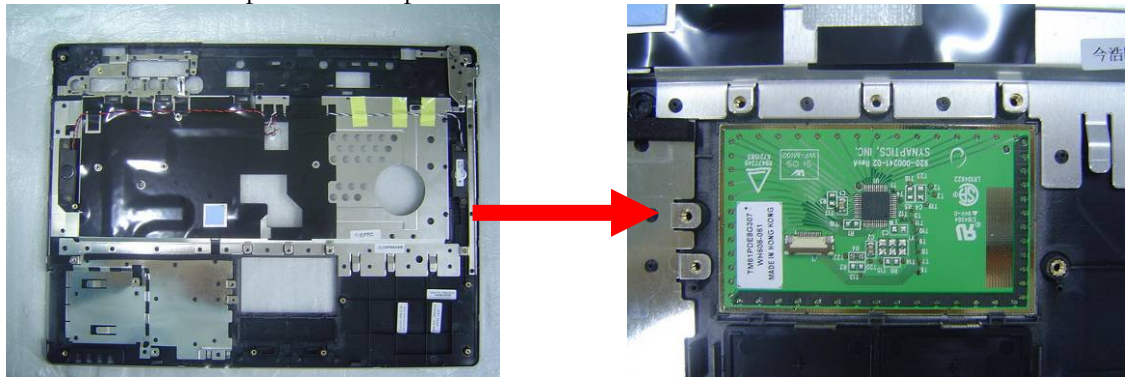

3. Install the touchpad bracket and secure 4 screws to secure it.

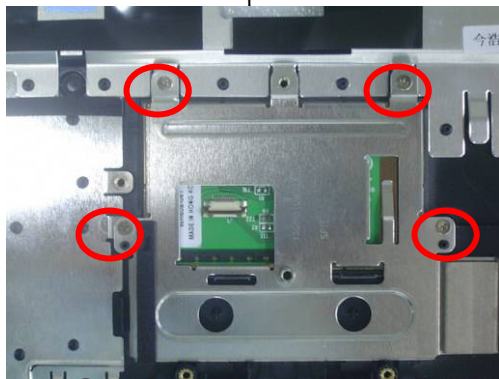

4. Connect the touch pad FPC

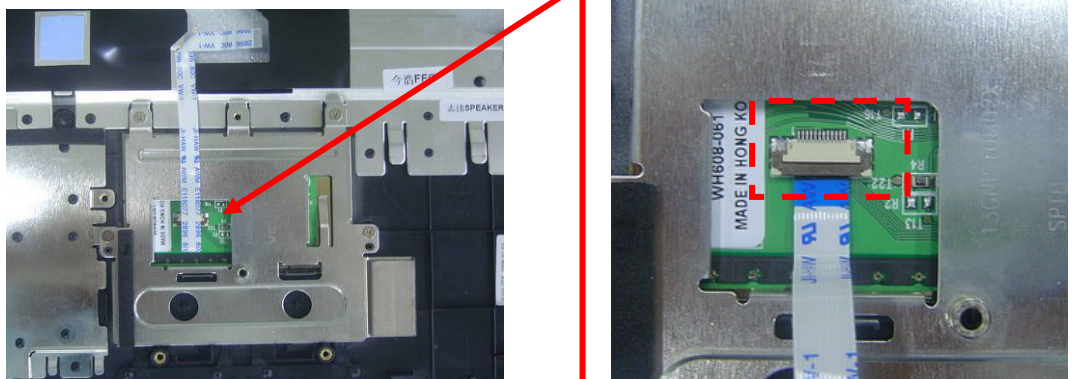

5. Combine the bottom case with the top case.



6. Connect the Touchpad FPC and Speaker cable from the top case.

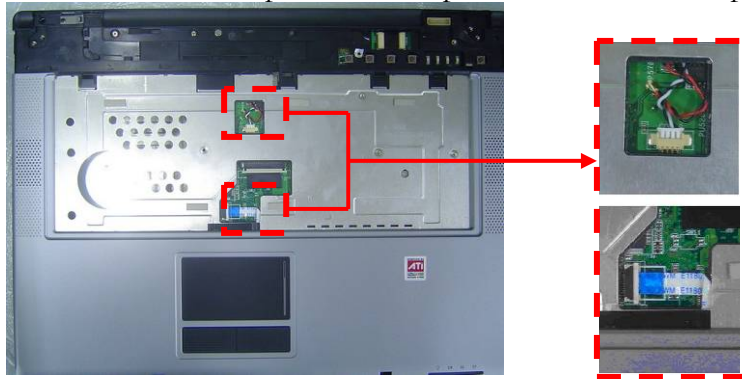

BOTTOM CASE
ASSEMBLY

1. Turn over the NB and secure 18 screws on the bottom case.

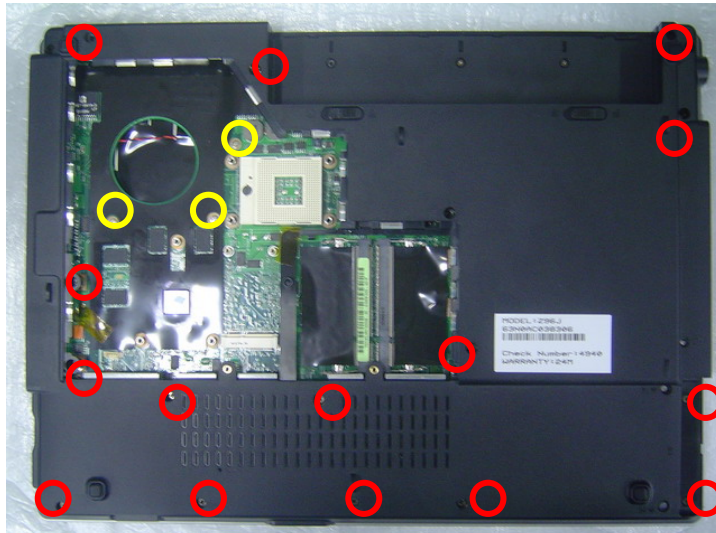

2. Combine the Top case module and LCD module.



3. Secure 4 screws which are in red circle, and then connect the Coaxial & inverter cable, then secure 2 screws (in yellow circle) to fix the cable.



4. Turn over the notebook, and then secure 2 screws here.



KEYBOARD

Assembling Keyboard

The illustrations below show how to assemble and install the Keyboard of the notebook.

KEYBOARD
ASSEMBLY

1. Connect the keyboard FPC cable and place the keyboard on the top case

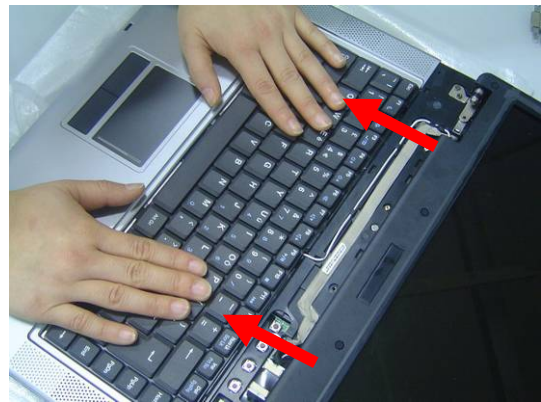
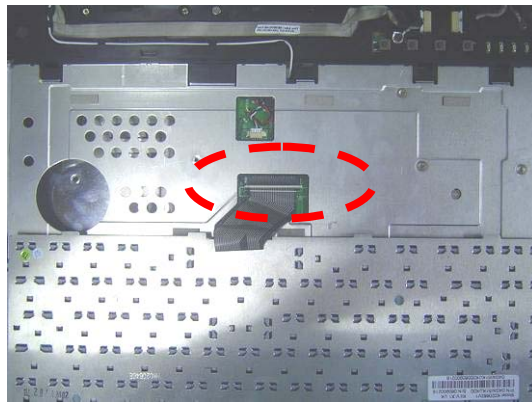

2. Install the indicator cover on the top case .

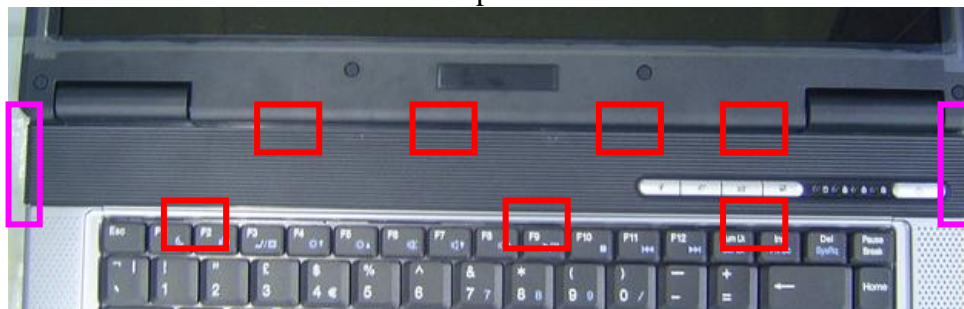

3. Turn over the notebook and then secure 3 screws here.

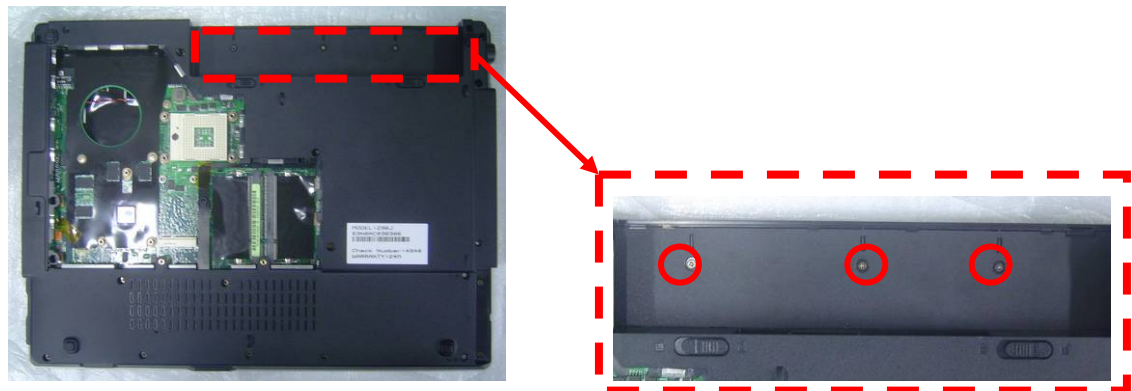

Optical Drive Module

The illustrations below show how to assemble and install the optical drive Module of the notebook.

1. Insert the optical drive module to its compartment and secure 2 screws to fix it.

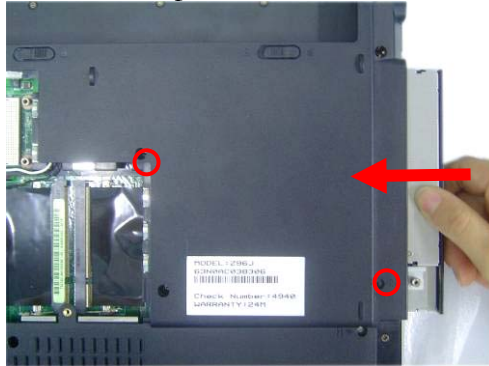

CPU INSTALL

CPU Module Assembly

The illustration below shows how to install CPU and the heat sink plate of the notebook.

1. Use the CPU vacuum to “suck up” the CPU.



2. Install the CPU and use a single-slotted screwdriver to fix it.



3. Install the CPU heat sink module gently and secure 4 screws (M2*4L(K)) upon the CPU module, then connect the fan cable.

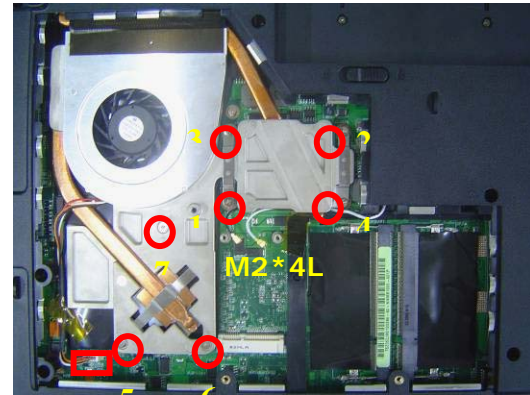

WLAN
MODULE
INSTALL

WLAN MODULE ASSEMBLY

The illustrations below show how to install the VGA Board module.

1. Insert the WLAN module and secure 2 screws to fix it



2. Connect the 2 antenna cables (black cable should be connected on main).



MEMORY
MODULE
INSTALL

Memory Module

The illustrations below show how to install the external Memory Module of the notebook.

1. Insert memory at the same 45° angles and press down until it clicks into the latches.

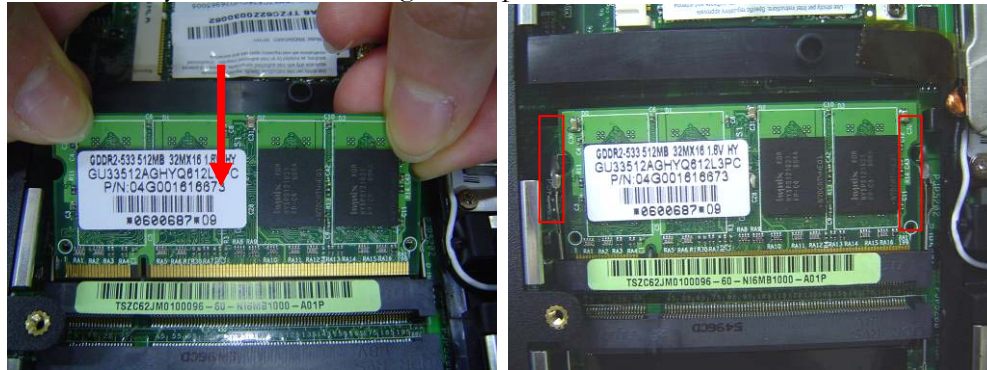

2. Put the CPU Module cover on then secure 3 screws to fix it.



HDD MODULE
INSTALL

HDD Module

The illustrations below show how to assemble and install the HDD module of the notebook

1. Install HDD bracket and secure 4 screws to fix HDD and HDD housing.



2. Install the new HDD, and secure 2 screws to fix it.

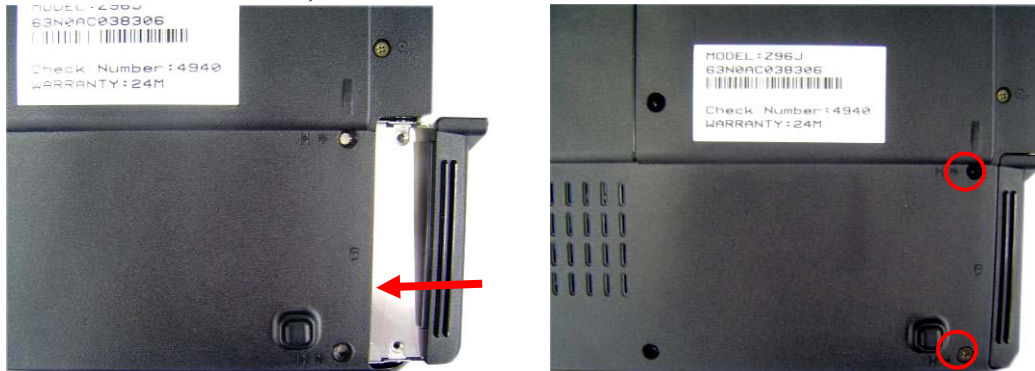

BATTERY
MODULE

Battery Module

The illustrations below show how to install battery module of the notebook.

1. Put the battery module into its compartment.



Chapter

4

Upgrade & Replacement

Follow the individual procedures in this chapter to perform the notebook's upgrade and replacement of various major components.

Asus S96J Series Notebook is a 2 spindles product, which means there are less options for you to upgrade to. The key upgradeable and replaceable items include the CPU module, memory module, HDD, ODD, and Wireless LAN module.

In order to avoid redundancy, please refer to chapters 2 and 3 of this manual for repeated and reused disassembly and assembly procedures, such as keyboard & heat sink replacement, which is used by several different procedures in this chapter. ***Be sure to follow the safety instructions described in Chapter 1 to safeguard the notebook against any potential damages.*** For any other components which you need to replace not covered in this chapter, please refer to Chapters 2 and 3 for detailed disassembly and assembly and perform necessary procedures accordingly.

This chapter includes the following items:

- CPU Upgrade
- Memory Upgrade
- HDD Upgrade
- ODD Replacement
- WLAN Replacement

CPU Upgrade

The S96J Series Notebook comes standard with a Intel® Micro-FCPGA Socket on the motherboard, which means it can support all Intel Micro-FCPGA CPUs up to 2.1 GMHz.

Upgrading CPU

Remove battery module

1. Turn the notebook over. Unlock and hold the latch, and remove the battery.



Replacement CPU

1. Remove 3 screws and take the CPU door away.



Remove Thermal module

1. Disconnect the FAN cable and remove 7 screws from 1 to 7, then take away the thermal module

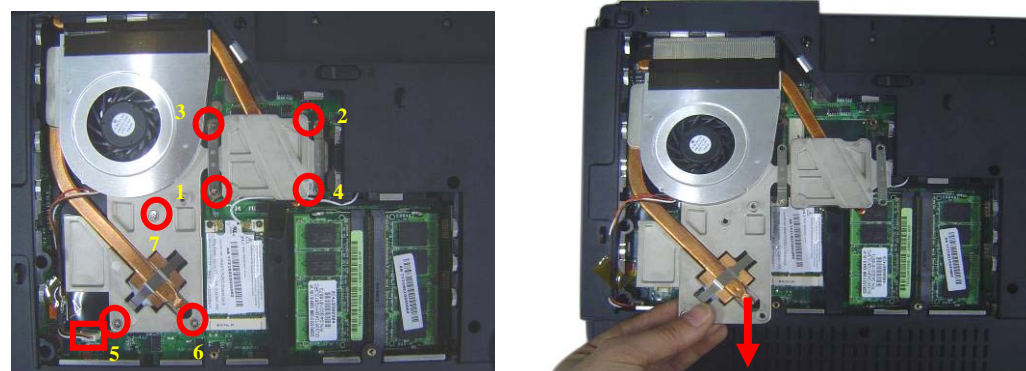

2. Turn the non-removable screw here 180 degrees counter-clockwise to loosen the CPU.

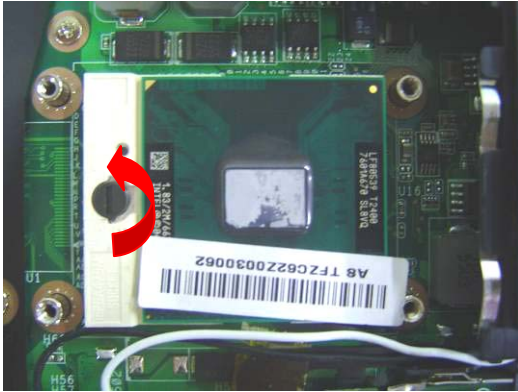

3. Squeeze the vacuum handling pump and use it to lift the CPU away.



Installing CPU

1. Use the CPU vacuum to “suck up” the CPU.



2. Install the CPU and use a single-slotted screwdriver to fix it.

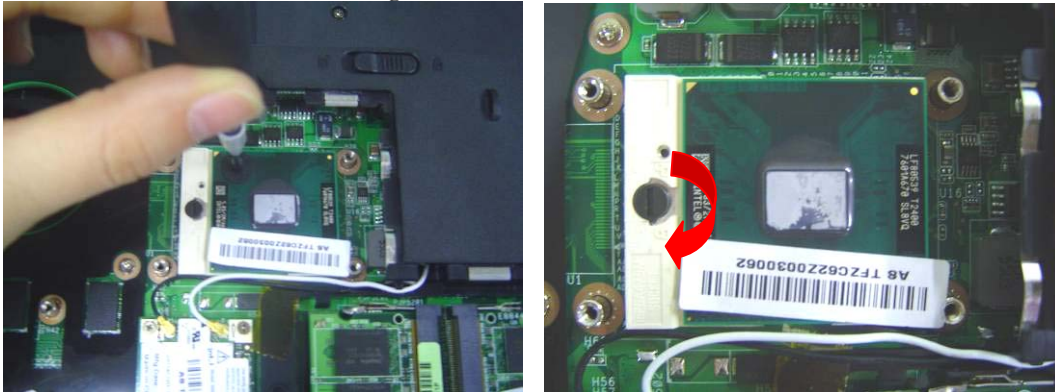

3. Install the CPU heat sink module gently and secure 7 screws upon the CPU module, then connect the fan cable.

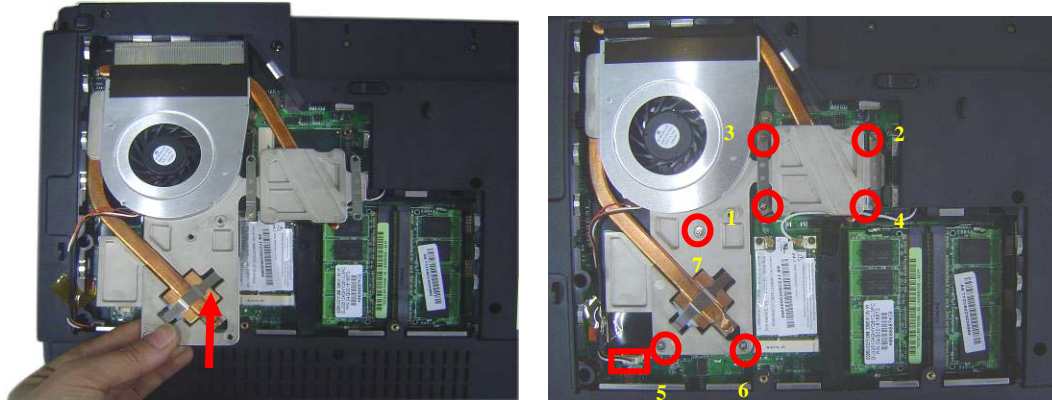

4. Put the CPU Module cover on then secure 3 screws to fix it.



Install battery module.

1. Put the battery module into its compartment.



MEMORY

Memory Upgrade

Upgrading Memory Module

Remove battery module

1. Turn the notebook over. Unlock and hold the latch, and remove the battery .

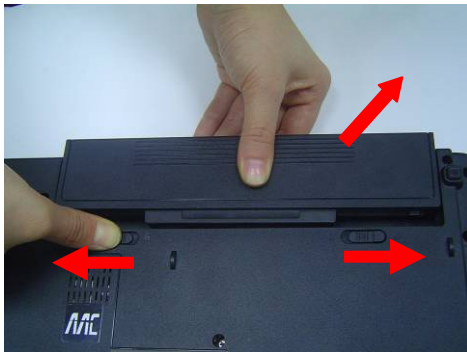

Replacement Memory module

1. Remove 3 screws and take the CPU door away.



2 Pull two latches and pop the module up to a 45° angles, and then pulling out the module in that angle.

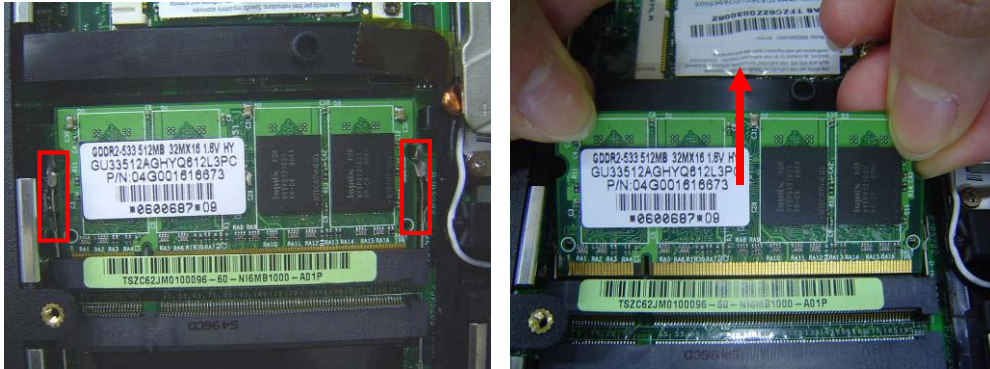

Installing Memory Module

1. Insert memory at the same 45° angles and press down until it clicks into the latches.

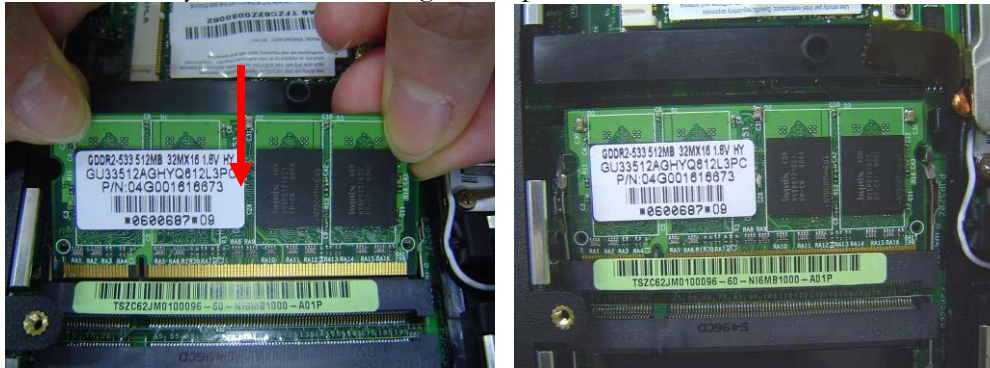

2. Put the CPU Module cover on then secure 3 screws to fix it.



Install battery module

1. Put the battery module into its compartment.



HDD

HDD Module Replacement

Replacement HDD Module

Remove original HDD module

1. Remove 2 screws and take the HDD out.



2. Remove 4 screws to separate HDD from HDD housing



Install new HDD module.

1. Install HDD bracket and secure 4 screws to fix HDD and HDD housing.



2. Install the new HDD, and secure 2 screws to fix it.

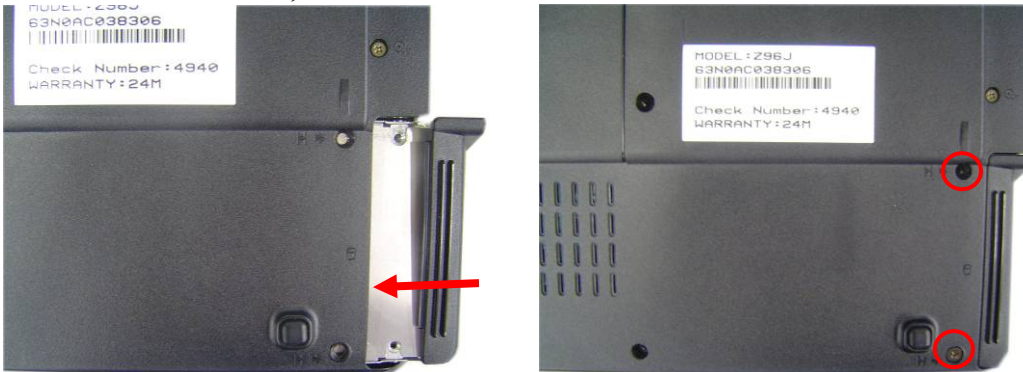

Install battery module.

Put the battery module into its compartment.



ODD Module Replacement

Replacing ODD

Remove battery module

1. Turn the notebook over. Unlock and hold the latch, and remove the battery.

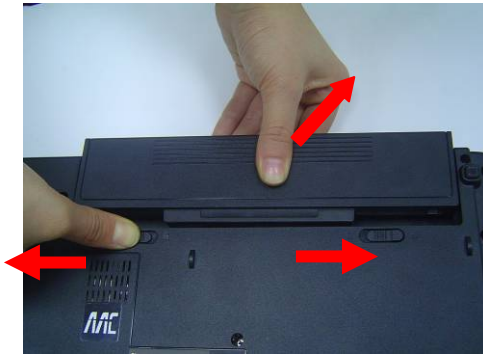

Replacement ODD

1. Remove 3 screws and take the CPU door away.



2. Remove 2 screws and Push the module out.



Install New ODD module

1. Insert the optical drive module to its compartment, and secure the 2 screws.

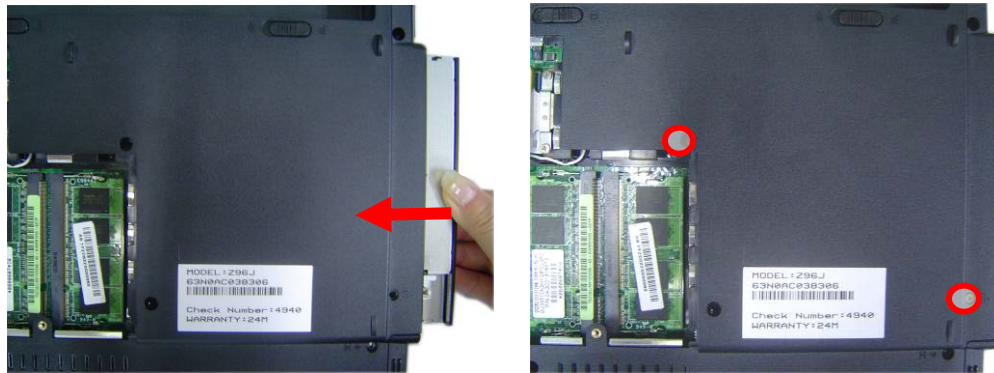

2. Put the CPU cover on and secure 3 screws (M2*4L(K)) to fix it.



Install battery module.

Put the battery module into its compartment.



WLAN Module Replacement

This slot usually has Wireless LAN module when leaving the factory, this slot is for optional system upgrade.

Replacing WLAN module

Remove battery module

2. Turn the notebook over. Unlock and hold the latch, and remove the battery .



Replacement WLAN

2. Remove 3 screws and take the CPU door away.



1. Remove 2 Antenna cables from Wireless LAN Module



2. Remove 2 screws, then take the WLAN module away.





Installing Wireless LAN Module

3. Insert the WLABN module and secure 2 screws to fix it

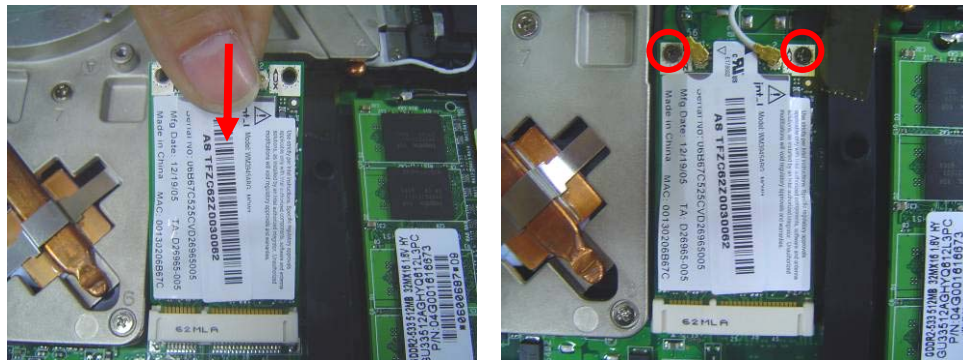

4. Connect the 2 antenna cables (black cable should be connected on main).



5. Put the CPU cover on and secure 3 screws to fix it.



Install battery module.

Put the battery module into its compartment.



Free Manuals Download Website

<http://myh66.com>

<http://usermanuals.us>

<http://www.somanuals.com>

<http://www.4manuals.cc>

<http://www.manual-lib.com>

<http://www.404manual.com>

<http://www.luxmanual.com>

<http://aubethermostatmanual.com>

Golf course search by state

<http://golfingnear.com>

Email search by domain

<http://emailbydomain.com>

Auto manuals search

<http://auto.somanuals.com>

TV manuals search

<http://tv.somanuals.com>