



42 inch Plasma TV

Operating Instructions

Model No.: AR4200

For assistance, please call: **1-800-619-3848**



Before connecting, operating or adjusting this product, please read these instructions completely. Please keep this manual for future reference

Important Information.....	1
Important Safety Precautions	2
Preparations.....	5
Using the Remote Control	5
Batteries for the Remote Control	5
Power connection.....	6
Speaker connection.....	6
Antenna Connection	7
Identification of Controls	8
Main unit (front view)	8
Main unit (rear view)	9
Remote Control	10
Connections	12
Cautions before connecting	12
Connect a VCR	12
Connect a Camcorder.....	13
Connect a DVD player	14
Connect a DTV receiver.....	15
Connect a PC.....	16
Connect a VCR (for recording) or external amplifier	17
Turning the Unit On and Off	18
Memorizing the Channels	19
Selecting the Signal Source.....	19
Storing Channels in Memory Automatically	19
Setting Auto Fine Tune (AFT)	20
Manual Fine Tuning	20
Adding and Erasing Channels	20
Basic Operations	21
Changing Channels	21
Adjusting the Volume.....	21
Select input source signal.....	22
Selecting a MENU language	22
Setting Channel Options	23
Editing Channel Label.....	23
Setting Picture	24
Customizing the Picture	24
Using the Preset Picture Mode	24
Setting System.....	25
Setting the Menu Background.....	25
Setting Sleep Timer	25
Changing Screen Options.....	26
Changing the Scaling mode of Image.....	26
Freezing the Picture	26
Changing the Position of the Image.....	27
Using Digital Pan and Zoom	27

Table of Contents

Setting Sound	28
Using the Preset Audio Mode	28
Customizing the Sound	28
Adjusting the Headphone Volume	28
Choosing a Multi-Channel Sound (MTS) Soundtrack	29
Using the Auto Volume	29
Changing Screen Layout	30
Selecting Screen Layout	30
PIP	31
Split Screen	31
POP3	31
Grid	31
PIP Operations	32
Viewing the Picture-in-Picture	32
Swap the Contents of the PIP Image and Main Image	32
Changing the Position of the PIP Frame	33
Adjusting the Size of PIP Frame	33
Adjustment in PC (VGA) Mode	34
Adjusting Picture	34
Adjusting the Phase and Frequency	34
Adjusting the Picture Automatically	34
Changing the Scaling mode of Image	35
Changing the Position of Image	35
Displaying the Information	35
Adjustment in YPbPr Mode	36
Changing the Scaling mode of Image	36
Changing the Position of Image	36
Adjusting Image width and height	36
Viewing Closed Captions	37
Setting Closed Caption	37
Setting the Background of Closed Caption	37
Adjusting V-CHIP Settings	38
V-CHIP	38
Accessing the V-CHIP Menu	40
Changing the Password	40
Adjusting the Movie Rating	41
Adjusting the TV Rating	41
Troubleshooting	42
Specifications	43
Dimensional Drawings	45

WARNING: TO REDUCE THE RISK OF FIRE OR ELECTRIC SHOCK, DO NOT EXPOSE THIS APPARATUS TO RAIN OR MOISTURE.

	CAUTION RISK OF ELECTRIC SHOCK DO NOT OPEN	
CAUTION- To reduce the risk of electric shock, do not perform any servicing other than that contained in the operating instructions		

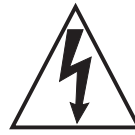

The lightning flash with arrowhead symbol, within an equilateral triangle is intended to alert the user to the presence of uninsulated dangerous voltage within the product's enclosure that may be of sufficient magnitude to constitute a risk of electric shock to persons.



The exclamation point within an equilateral triangle is intended to alert the user to the presence of important operating and maintenance (servicing) instructions in the literature accompanying the appliance.

"Note to CATV system installer: This reminder is provided to call the CATV system installer's attention to Article 820-40 of the National Electrical Code that provides guidelines for proper grounding and, in particular, specifies that the cable ground shall be connected to the grounding system of the building, as close to the

This product utilizes tin-lead solder, and fluorescent lamp containing a small amount of mercury. Disposal of these materials may be regulated due to environmental considerations. For disposal or recycling information, please contact your local authorities or the Electronic Industries Alliance: www.eia.org

FCC STATEMENT

FCC Notice

PDP TV: A CLASS B digital device

This equipment has been tested and found to comply with the limits for a Class B digital device, pursuant to part 15 of the FCC Rules. These limits are designed to provide reasonable protection against harmful interference when the equipment is operated in a commercial environment.

This equipment generates, uses, and can radiate radio frequency energy and, if not installed and used in accordance with the instruction manual, may cause harmful interference to radio communications. Operation of this equipment in a residential area is likely to cause harmful interference in which case the user will be required to correct the interference at his own expense.

FCC CAUTION:

Pursuant to 47CFR, Part 15.21 of the FCC rules, any changes or modifications to this monitor not expressly approved by the manufacturer could cause harmful interference and would void the user's authority to operate this device.

WARNING: This is a CLASS B product. In a domestic environment this product may cause radio interference in which case the user may be required to take adequate measures to counter interference.

Important Safety Precautions

Electrical energy can perform many useful functions, but it can also cause personal injuries and property damage if improperly handled. This product has been engineered and manufactured with the highest priority on safety. But **IMPROPER USE CAN RESULT IN POTENTIAL ELECTRICAL SHOCK OR FIRE HAZARD**. In order to prevent potential danger, please observe the following instructions when installing, operating and cleaning the product. To ensure your safety and prolong the service life of your PDP TV product,

1. Read these instructions---All operating instructions must be read and understood before the product is operated.

2. Keep these instructions---These safety and operating instructions must be kept in a safe place for future reference.

3. Heed all warnings---All warnings on the product and in the instructions must be observed closely.

4. Follow all instructions---All operating instructions must be followed.

5. Do not use this apparatus near water---for example, near a bathtub, washbowl, kitchen sink, or laundry tub, in a wet basement, or near a swimming pool, and the like.

Do not use immediately after moving from a low temperature to high temperature environment, as this causes condensation, which may result in fire, electric shock, or other hazards.



6. Clean only with dry cloth---Unplug this product from the wall outlet before cleaning. Do not use liquid cleaners or aerosol cleaners. Use a damp cloth for cleaning.

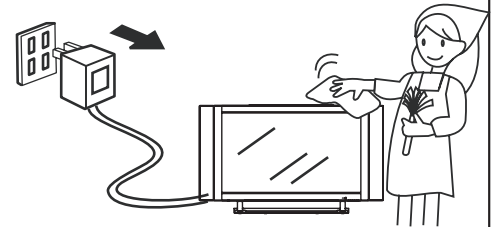

7. Ventilation---Do not block any ventilation openings. Install in accordance with the manufacturer instructions. The vents and other openings in the cabinet are designed for ventilation. Do not cover or block these vents and openings since insufficient ventilation can cause overheating and/or shorten the life of the product. Do not place the product on a bed, sofa, rug or other similar surface, since they can block ventilation openings. This product is not designed for built-in installation; do not place the product in an enclosed place such as a bookcase or rack, unless proper ventilation is provided or the manufacturer's instructions are followed. 4" clearance on all sides and back are required

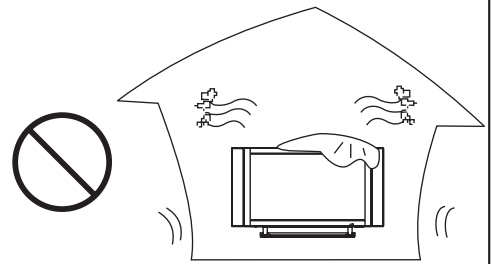

8. Heat sources---Do not install near any heat sources such as radiators, heat registers, stoves, or other apparatus (including amplifiers) that produce heat.

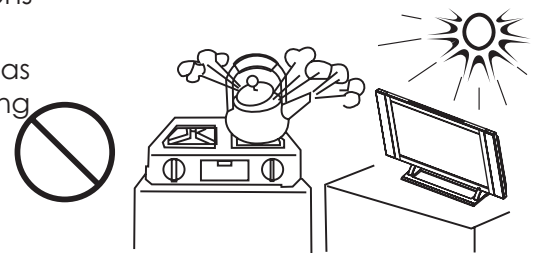

9. Grounding or Polarization---Do not defeat the safety purpose of the polarized or grounding-type plug. A polarized plug has two blades with one wider than the other. A grounding type plug has two blades and a third grounding prong. The wide blade or the third prong are provided for your safety. If the provided plug does not fit into your outlet, consult an electrician for replacement of the obsolete outlet.

10. Power cord protection---Protect the power cord from being walked on or pinched particularly at plugs, convenience receptacles, and the point where they exit from the apparatus.

11. Attachments---Only use attachments/accessories specified by the manufacturer. Do not use attachments not recommended by the manufacturer. Use of improper attachments can result in accidents.

12. Stand---Use only with the cart, stand, tripod, bracket, or table specified by the manufacturer, or sold with the apparatus. Do not place the product on an unstable trolley, stand, tripod or table. Placing the product on an unstable base can cause the product to fall, resulting in serious personal injuries as well as damage to the product. When mounting the product on a wall, be sure to follow the manufacturer's instructions. Use only the mounting hardware recommended by the manufacturer.

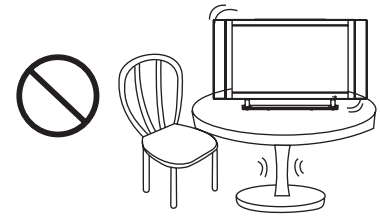

13. Careful move---When a cart is used, use caution when moving the cart/apparatus combination to avoid injury from tip-over. Sudden stops, excessive force and uneven floor surfaces can cause the product to fall from the trolley.



14. Lightning---Unplug this apparatus during lightning storms or when unused for long periods of time.

For added protection for this television equipment during a lightning storm, or when it is left unattended and unused for long periods of time, unplug it from the wall outlet and disconnect the antenna. This will prevent damage to the equipment due to lightning and power-line surges.

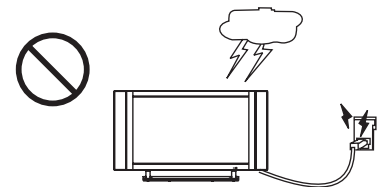

15. Servicing---Refer all servicing to qualified service personnel. Servicing is required when the apparatus has been damaged in any way, such as power-supply cord or plug is damaged, liquid has been spilled or objects have fallen into the apparatus, the apparatus has been exposed to rain or moisture, does not operate normally, or has been dropped.

16. Replacement parts---In case the product needs replacement parts, make sure that the service person uses replacement parts specified by the manufacturer, or those with the same characteristics and performance as the original parts. Use of unauthorized parts can result in fire, electric shock and/or other danger.

17. Overloading---Do not overload wall outlets, extension cords, or convenience receptacles on other equipment as this can result in a risk of fire or electric shock.

18. Entering of objects and liquids---Never insert an object into the product through vents or openings. High voltage flows in the product, and inserting an object can cause electric shock and/or short internal parts. For the same reason, do not spill water or liquid on the product.

19. Damage requiring service---If any of the following conditions occurs, unplug the power cord from the AC outlet, and request a qualified service person to perform repairs.

- When the power cord or plug is damaged.
- When a liquid is spilled on the product or when objects have fallen into the product.
- When the product has been exposed to rain or water.
- When the product does not operate properly as described in the operating instructions.

Do not touch the controls other than those described in the operating instructions. Improper adjustment of controls not described in the instructions can cause damage, which often requires extensive adjustment work by a qualified technician.

- If the product has been dropped or the cabinet has been damaged in any way.
- When the product displays an abnormal condition or exhibits a distinct change in performance. Any noticeable abnormality in the product indicates that the product needs servicing.

20. Safety checks---Upon completion of service or repair work, request the service technician to perform safety checks to ensure that the product is in proper operating condition.

21. Wall or ceiling mounting---When mounting the product on a wall or ceiling, be sure to install the product according to the method recommended by the manufacturer. This is a safety feature.

22. Power source---This product is intended to be supplied by a listed power supply indicated on the marking label. If you are not sure of the type of power supply to your home, consult your product dealer or local power company. For added protection for this product during a lightning storm, or when it is left unattended and unused for long periods of time, unplug it from the wall outlet and disconnect the cable system. This will prevent damage to the product due to lightning and power line surges. When the unit has to be used with another power supply voltage, the power cable must be changed. Consult your product dealer. The socket outlet should be installed near the equipment and easily accessible. Use only the power cord designated by our dealer to ensure safety and EMC. When connecting other products such as VCRs and personal computers, you should turn off the power of the unit for protection against electric shock.

23. Panel protection---The PDP panel used in this product is made of glass. Therefore, it can break when the product is dropped or impacted upon by other objects. Be careful not to be injured by broken glass pieces in case the PDP panel breaks.

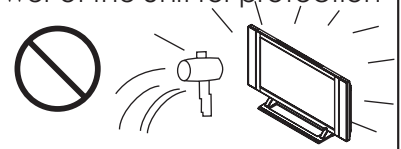

24. Pixel defect---The PDP panel is a very high technology product, giving you finely detailed pictures. Occasionally, a few non-active pixels may appear on the screen as a fixed point of blue, green or red. Please note that this does not affect the performance of your product.

- If an outside antenna is connected to the television equipment, be sure the antenna system is grounded so as to provide some protection against voltage surges and built-up static charges. Section 810 of the National Electrical Code provides information with respect to proper grounding of the mast and supporting structure, grounding of the lead-in wire to an antenna discharge unit, size of grounding conductors, location of antenna-discharge unit, connection to grounding electrodes, and requirements for the grounding electrode.

EXAMPLE OF ANTENNA GROUNDING AS PER NATIONAL ELECTRICAL CODE

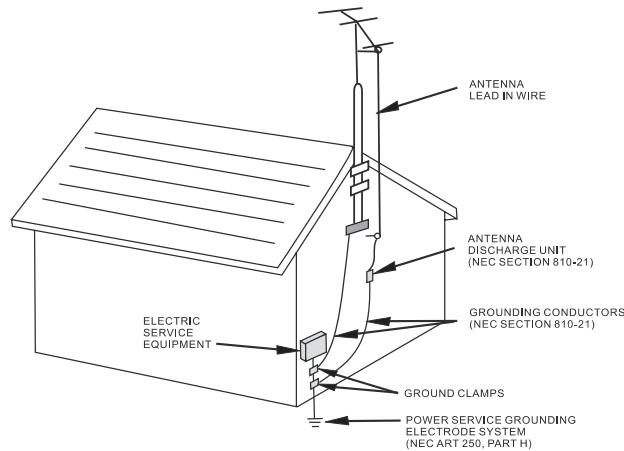

NEC—NATIONAL ELECTRICAL CODE

- An outside antenna system should not be located in the vicinity of overhead power lines or other electric light or power circuits, or where it can collide with such power lines or circuits. When installing an outside antenna system, extreme care should be taken to keep from touching such power lines or circuits, as contact with them might be fatal.

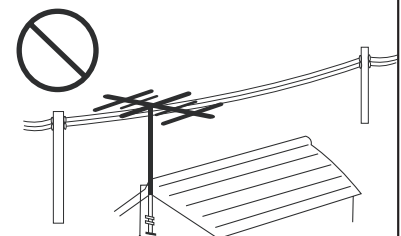

Using the Remote Control

- Use the remote control by pointing it towards the remote sensor window of the set. Objects between the remote control and sensor window may prevent proper operation.

Note: the illustration is for your reference only, the remote sensor may locate differently with different model.

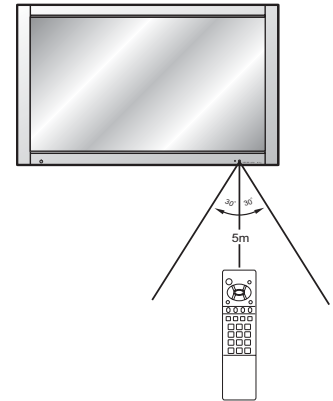

Cautions regarding use of remote control

- Do not expose the remote control to shock. In addition, do not expose the remote control to liquids, and do not place in an area with high humidity.
- Do not install or place the remote control under direct sunlight. The heat may cause deformation of the unit.
- The remote control may not work properly if the remote sensor window of the main unit is under direct sunlight or strong lighting. In such a case, change the angle of the lighting or PDP TV set, or operate the remote control closer to the remote sensor window.

Batteries for the Remote Control

If the remote control fails to operate the PDP TV functions, replace the batteries in the remote control.

- 1 Open the battery cover.

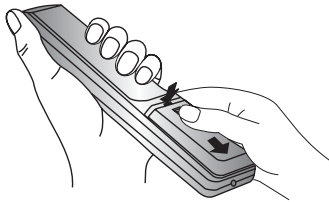

- (Slide the cover while pressing down.)

- 2 Insert two size-AAA batteries.

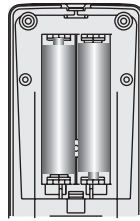

- (Place the batteries with their terminals corresponding to the (+) and (-) indications in the battery)

- 3 Replace the cover and slide in reverse until the lock snaps.

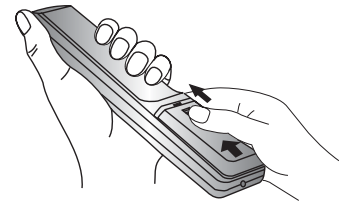

Precaution on battery use

Improper use of batteries can result in a leakage of chemicals and/or explosion. Be sure to follow the instructions below.

- Place batteries with their terminals corresponding to the (+) and (-) indications.
- Different types of batteries have different characteristics. Do not mix batteries of different types.
- Do not mix old and new batteries. Mixing old and new batteries can shorten the life of new batteries and/or cause old batteries to leak chemicals.
- Remove batteries as soon as they are non-operable. Chemicals that leak from batteries can cause a rash. If chemical leakage is found, wipe with a cloth.
- The batteries supplied with the product may have a shorter life expectancy due to storage conditions.
- If the remote control is not used for an extended period of time, remove the batteries from the remote control.

Power connection

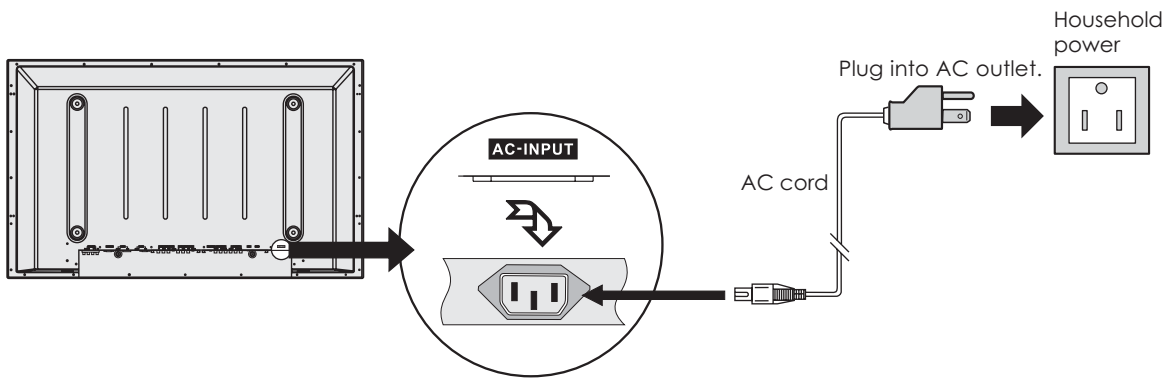

1. Connecting the female plug to the AC socket on the unit.
2. Connecting the male plug to the wall outlet as illustrated.

Note:

- This product should be operated only from the type of power source indicated on the marking label.
- Always unplug the AC cord from power outlet when not using for a long period of time.

Speaker connection (Optional)

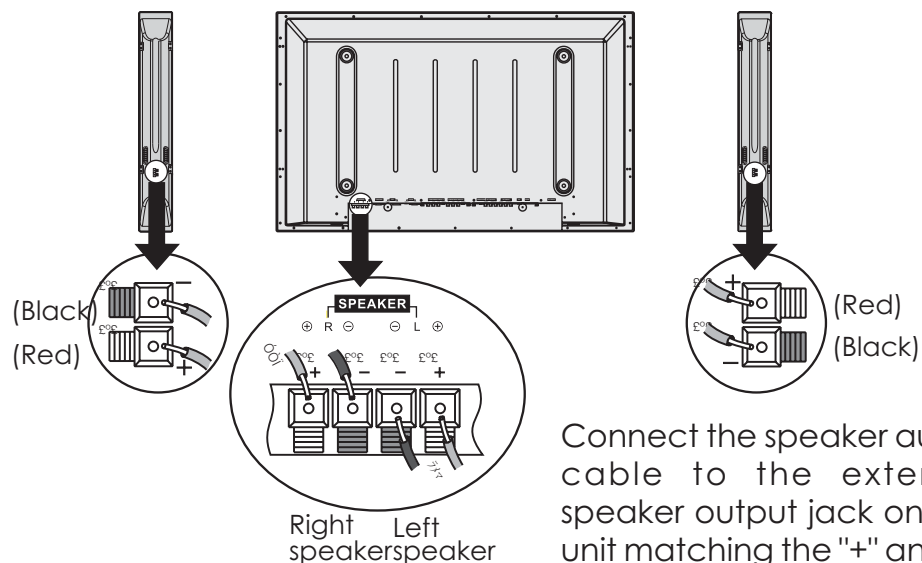

Connect the speaker audio cable to the external speaker output jack on the unit matching the "+" and "-" ends of the cable with color.

Note: the illustration may be different depending on model.

Antenna Connection

CABLE TV (CATV) CONNECTION

A 75-ohm coaxial cable connector is built into the set for easy hookup. When connecting the 75-ohm coaxial cable to the set, screw the 75-ohm cable to the ANT. Terminal.

Some cable TV companies offer "premium pay channels". Since the signals of these premium pay channels are scrambled, a cable TV converter/descrambler is generally provided to the subscriber by the cable TV company.

This converter/descrambler is necessary for normal viewing of the scrambled channels. For more specific instructions on installing cable TV, consult your cable TV company. One possible method of utilizing the converter/descrambler provided by your cable TV company is explained below. Please note: An RF switch provided with two inputs (A and B) is required (not supplied).

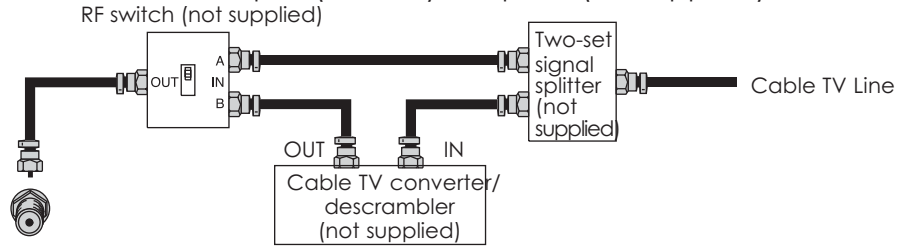

"A" position on the RF switch (not supplied) : You can view all unscrambled channels by using the TV's channel keys.

"B" position on the RF switch (not supplied) : You can view the scrambled channels via the converter/descrambler by using the converter's channel keys.

Antenna connection (Continued)

ANTENNAS

The antenna requirements for good color television reception are more important than those for black & white television reception. For this reason, a good quality outdoor antenna is strongly recommended. The following is a brief explanation of the type of connections that are provided with the various antenna systems.

1. A 75-ohm system is generally a round cable with F-type connector that can easily be attached to a terminal without tools (not supplied).
2. A 300-ohm system is a flat "twin-lead" cable that can be attached to a 75-ohm terminal through a 300-75-ohm

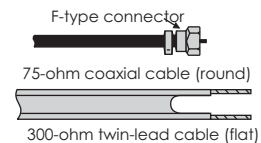

OUTDOOR ANTENNA CONNECTION

Use one of the following two diagrams if you connect an outdoor antenna.

A: Using a VHF/UHF combination outdoor antenna.

B: Using separate VHF and/or UHF outdoor antennas.

Connect the outdoor antenna cable lead-in to the ANT. terminal on the rear of the TV set.

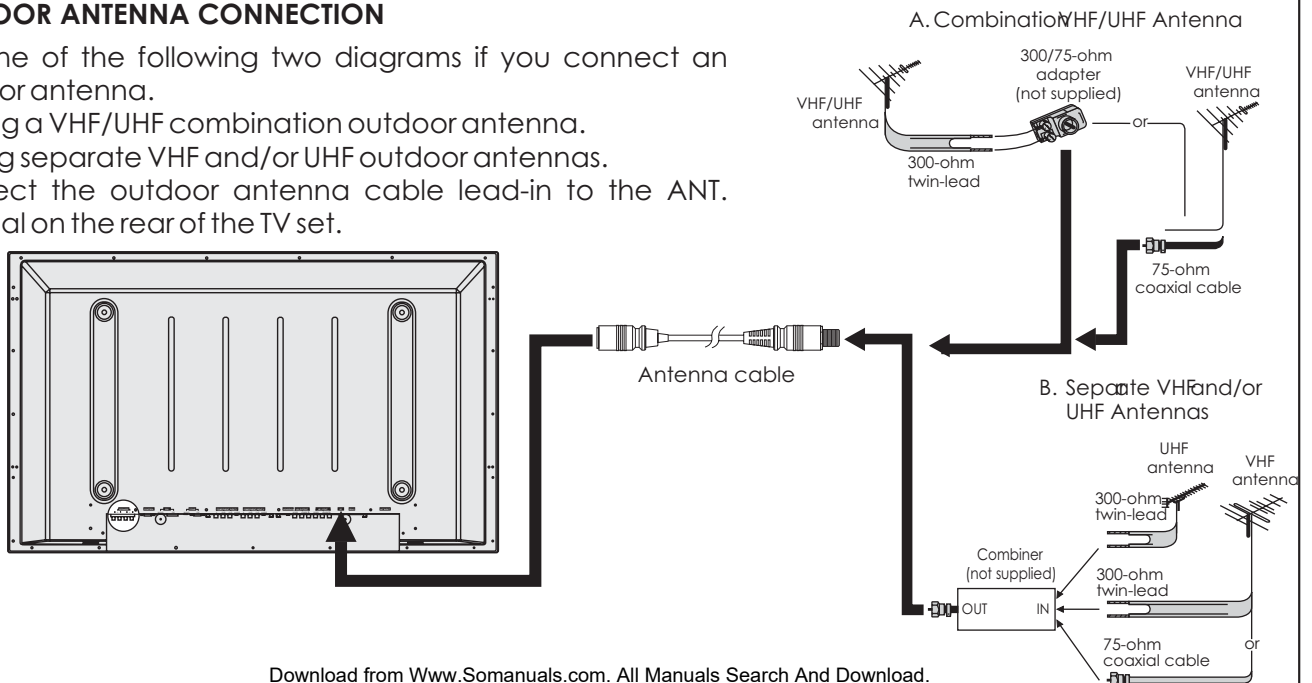

Identification of Controls

Main unit (front view)

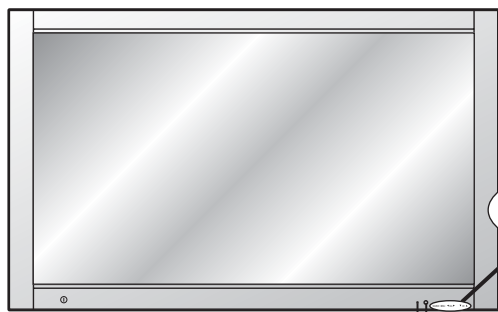

REMOTE SENSOR

POWER INDICATOR

A blue indicator lights when the power is on and a red indicator lights when in the standby mode.

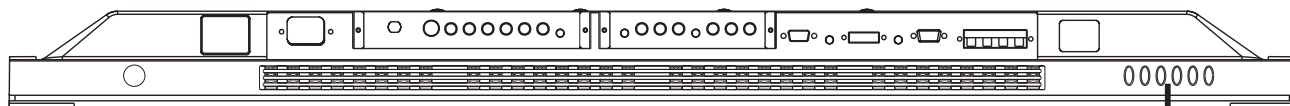

BOTTOM VIEW

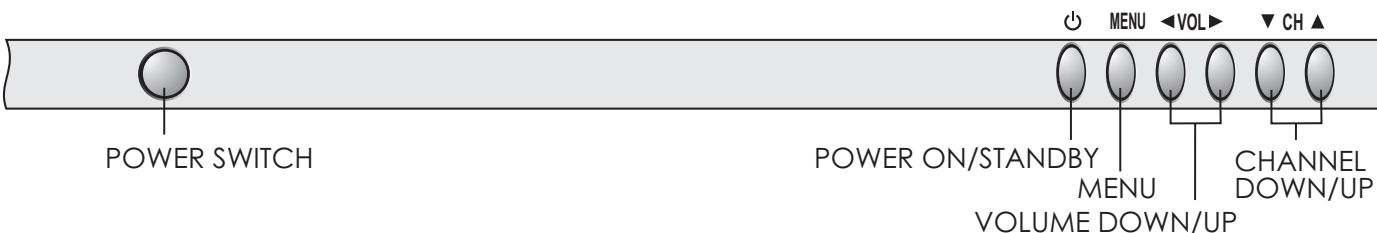

POWER SWITCH

POWER ON/STANDBY

MENU

VOLUME DOWN/UP

CHANNEL DOWN/UP

1. POWER

Press this button to turn the unit ON from STANDBY mode. Press it again to turn the set back to STANDBY.

2. MENU

Press this button to access the MENU main page.





3. Volume ◀ / ▶

Press the VOL ▶ or VOL ◀ button to directly increase or decrease the sound volume level. In OSD Menu, press these buttons to adjust the value or setting of each item

4. Channel ▲ / ▼

Press these two buttons to directly change the TV channel. In OSD Menu, press these buttons to choose the OSD items.

5. Power Switch: Press to remove power from the unit

POWER  , **VOL**  /  , **CH**  /  and **MENU** on the main unit have the same functions as the corresponding buttons on the remote control.

Main unit (rear view)

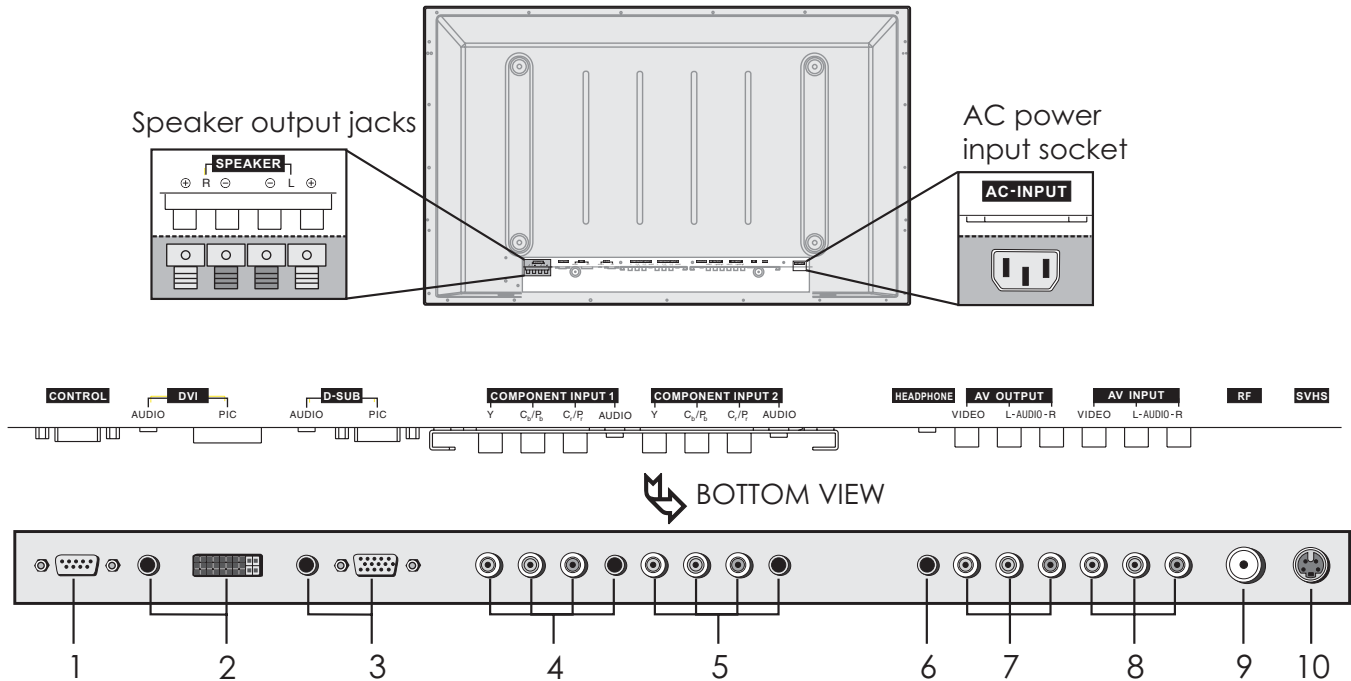

1. RS232 terminals

For service use only. The user cannot operate the unit through the RS232 terminals.

2. DVI input / Audio in

Receives the digital video/audio signals from a set top box.

3. VGA input / Audio in

Connect to the VGA/audio output jacks on your PC.

4. Component inputs 1 (Y, Pb/Cb, Pr/Cr, Audio)

Connect to the audio and component output jacks of a DVD player or Set-Top Box.

5. Component inputs 2 (Y, Pb/Cb, Pr/Cr, Audio)

Connect to the audio and component output jacks of a DVD player or Set-Top Box.

6. Headphone jack

7. AV outputs (Video, Audio L, R)

Connect to the VCR input jacks to record programs.

8. AV inputs (Video, Audio L, R)

Receive video/audio signals from external sources such as VCR or DVD player.

9. Antenna input

Allows you to connect cable or outdoor antenna.

10. S-Video input

Receive a S-Video signal from external source such as VCR or DVD player. (Note: S-Video Shares audio input with AV input.)

Remote Control

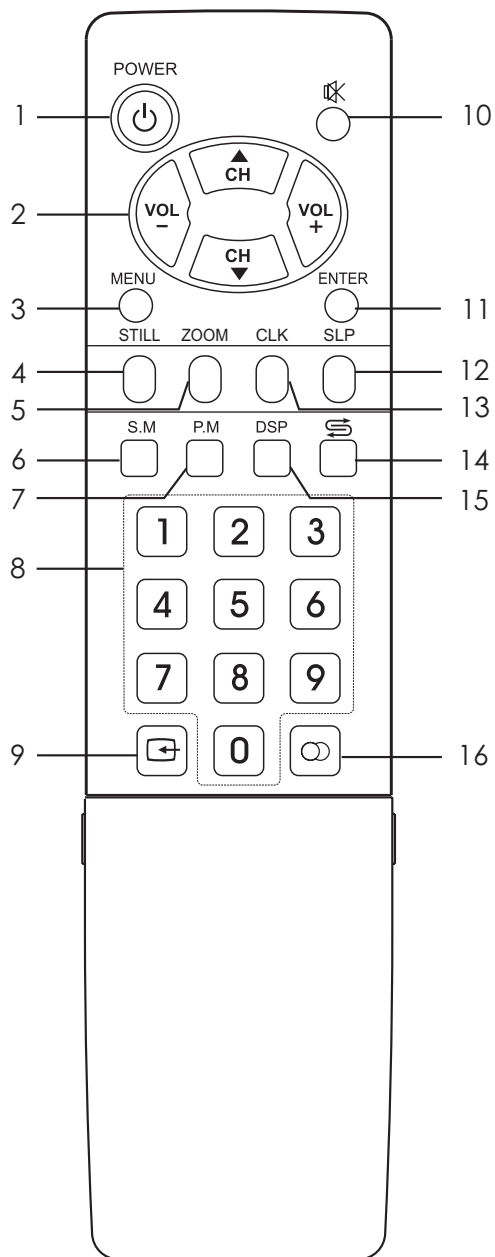

1. POWER Turn the unit on or standby
2. CH ▲/▼, VOL+/-
CH ▲/▼ ---Use to switch channels;
VOL+/- ---Use to adjust volume;
In MENU operation, use CH ▲/▼ to select menu item and
VOL+/- to adjust selected item
3. MENU
To access the MENU main page
4. STILL
To freeze current picture
5. ZOOM
To go into ZOOM or PAN mode
6. S.M.
To access sound mode select menu
7. P.M.
To access picture mode select menu
8. 0~9 digit buttons
Direct channel select
9. SOURCE To access source select menu
10. MUTE Sound mute
11. ENTER
To confirm your operation or setting or access the
submenu
12. SLP
To access Sleep timer setting menu
13. CLK
To access current time setting menu
14. RETURN
To quickly jump between current channel and last
selected channel.
15. DSP To display channel status or signal information
16. MTS
To select STEREO, SAP or MONO

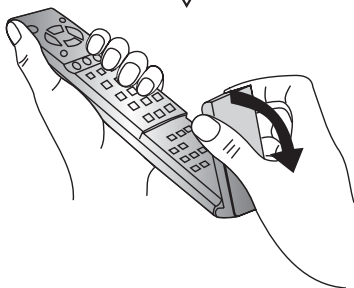
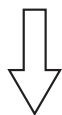







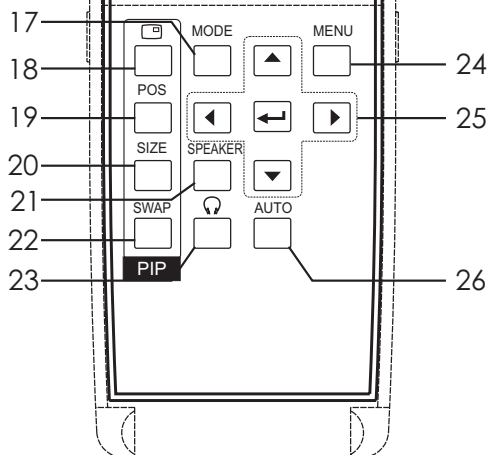
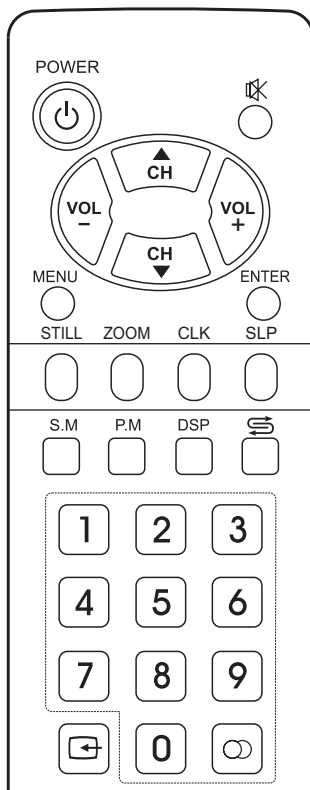





Flip the cover, open in
the direction of the

Note: Remote layout subject to change

Remote Control



17. MODE
To access screen layout select menu
18. PIP display 
To activate picture in picture
19. POS
To access PIP frame position select menu
20. SIZE
To access PIP frame size adjusting menu
21. SPEAKER
In multi-picture mode, press this button to output the sound of the selected picture frame from speaker
22. SWAP
To exchange PIP and MAIN PICTURE source
23. HEADPHONE 
In multi-picture mode, press this button to output the sound of the selected picture frame from headphone
24. MENU
To access the MENU main page
25.     
 -   : To move upward or downward in menu operation;
To adjust zoom rate in ZOOM mode and pan picture in PAN mode;
To select picture frame in multi-picture mode, the selected picture frame displays with a green border;
 -   : To move left or right in menu operation;
To adjust selected menu item in menu operation;
 -  : To pan picture in PAN mode;
 -  : To confirm your operation or setting or to access a submenu.
26. AUTO
To rectify the picture automatically in VGA mode

Note: Remote layout subject to change

Connections

Cautions before connecting

- Carefully check the terminals for position and type before making any connections.
- The illustration of the external equipment may be different depending on your model.
- Loose connectors can result in image or color problems. Make sure that all connectors are securely inserted into their terminals.
- Refer to the user manual of the external device as well.
- When connecting an external device, turn the power off on the panel to avoid any issues.

Connect a VCR

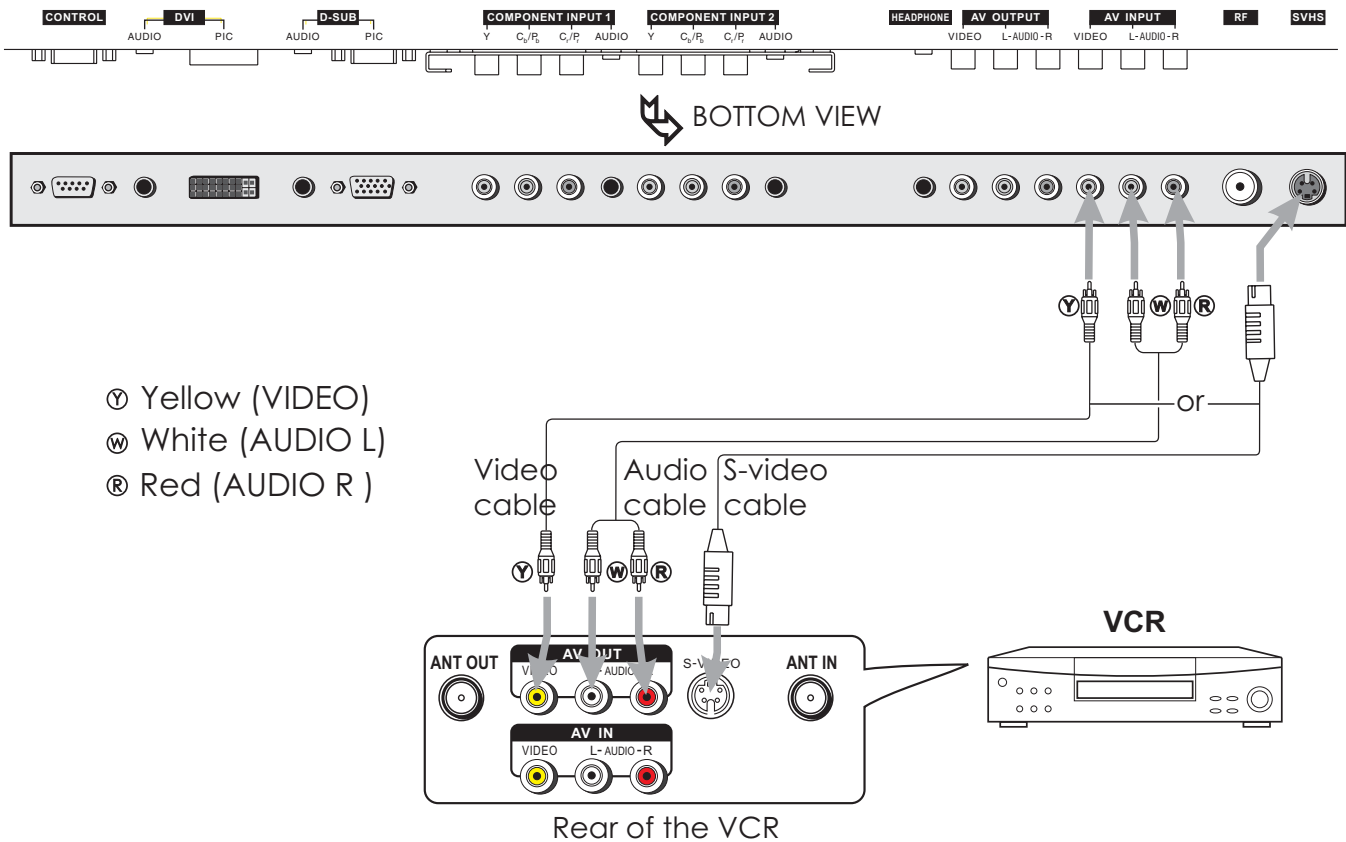

How to connect:

Connect the Audio/Video cables between the Audio (L/R)/Video jacks on the unit and VCR.

Note:

For better video, you can use the S-video terminal if your source supports it.
When you use S-video terminal, the source menu displays **SV** instead of **AV**.
S-video and AV input can not be used together. S-Video is master over AV

To play VCR

1. Turn on your PDP TV , press **SOURCE** button on the remote control.
2. Press **VOL+/-** to select **AV** (VIDEO) and press **ENTER** to

source [A] [D] [C1] [C2] [AV] [TV]
VIDEO

Connect a Camcorder

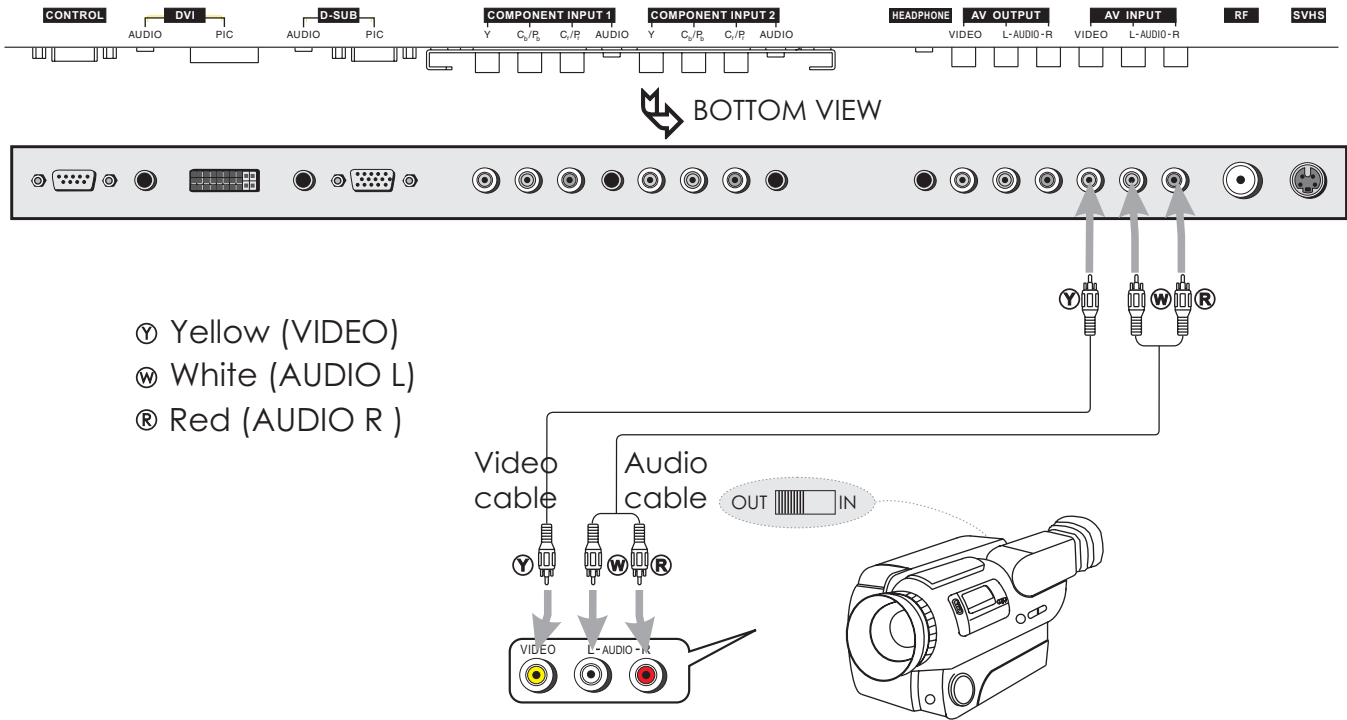

How to connect:

Connect the Audio/Video cables between the Audio (L/R)/Video jacks on the unit and camcorder.

To playback Camcorder

1. Turn on your PDP TV , press **SOURCE** button on the remote control.
2. Press **VOL+/-** to select **AV** (VIDEO) and press **ENTER** to confirm.
3. Turn on your camcorder and set it to output mode. (For details, refer to your camcorder user

Note:

The operations of the camcorder may be different and is

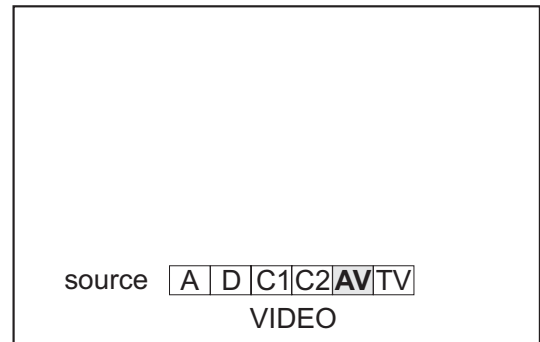

Connect a DVD player

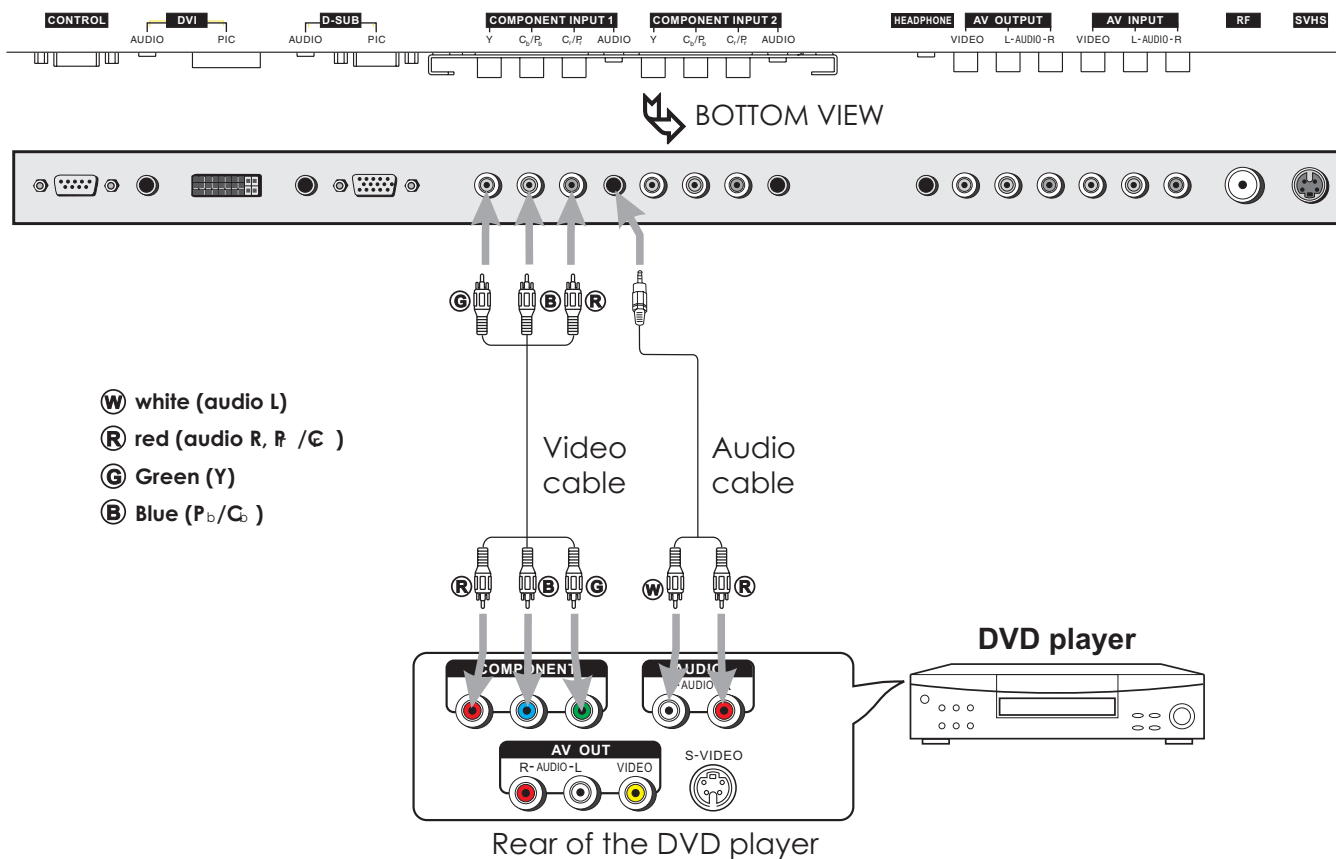

How to connect a DVD Player using Component Video Connections:

Connect the Video cable between the Y, Cb, Cr input jacks on the unit and Y, Cb, Cr output jacks on the DVD player.

To play DVD

1. Turn on your PDP TV , press **SOURCE** button on the remote
4. Turn on your DVD player, insert a DVD disc and press the

source **A** **D** **C1** **C2** **AV** **TV**
 YPbPr1/YCbCr1

Note:

This unit identifies the type of component video terminals automatically. If you connect **Y, Cb, Cr** terminals, the screen displays **YCbCr detected** on the bottom-right corner. Similarly, if the component

Connect a DTV receiver

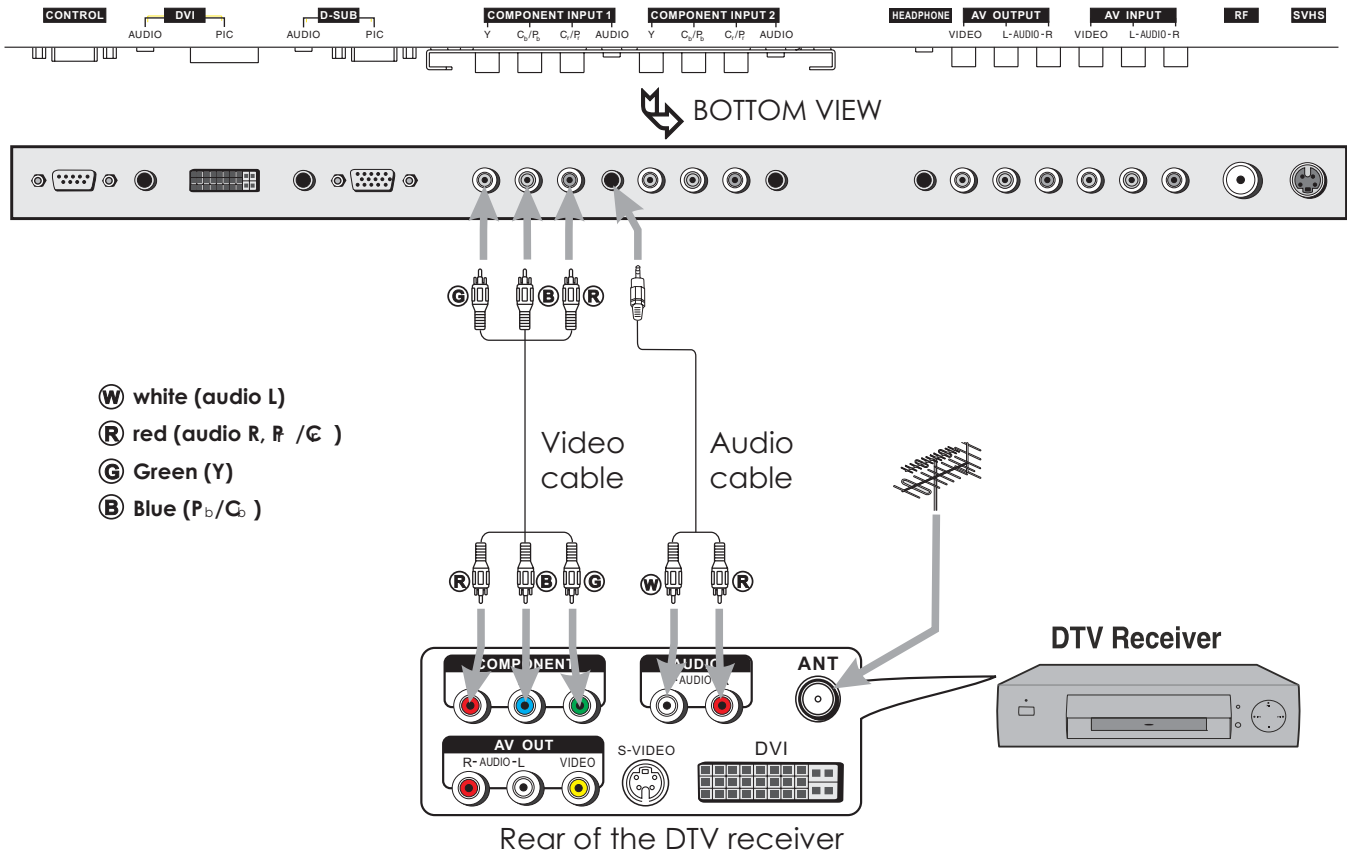

How to connect:

Connect the cable or antenna to the antenna input jack on the DTV receiver.

Connect the Video cable between the Y, Pb, Pr input jacks on the unit and Y, Pb, Pr output jacks on the DTV receiver .

To Watch DTV

1. Turn on your PDP TV , press **SOURCE** button on the remote control.
2. Press **VOL+/-** to select **C1**(YPbPr1/YCbCr1) or **C2**(YPbPr2/YCbCr2).

source

A	D	C1	C2	AV	TV
---	---	-----------	-----------	----	----

YPbPr1/YCbCr1

Connect a PC

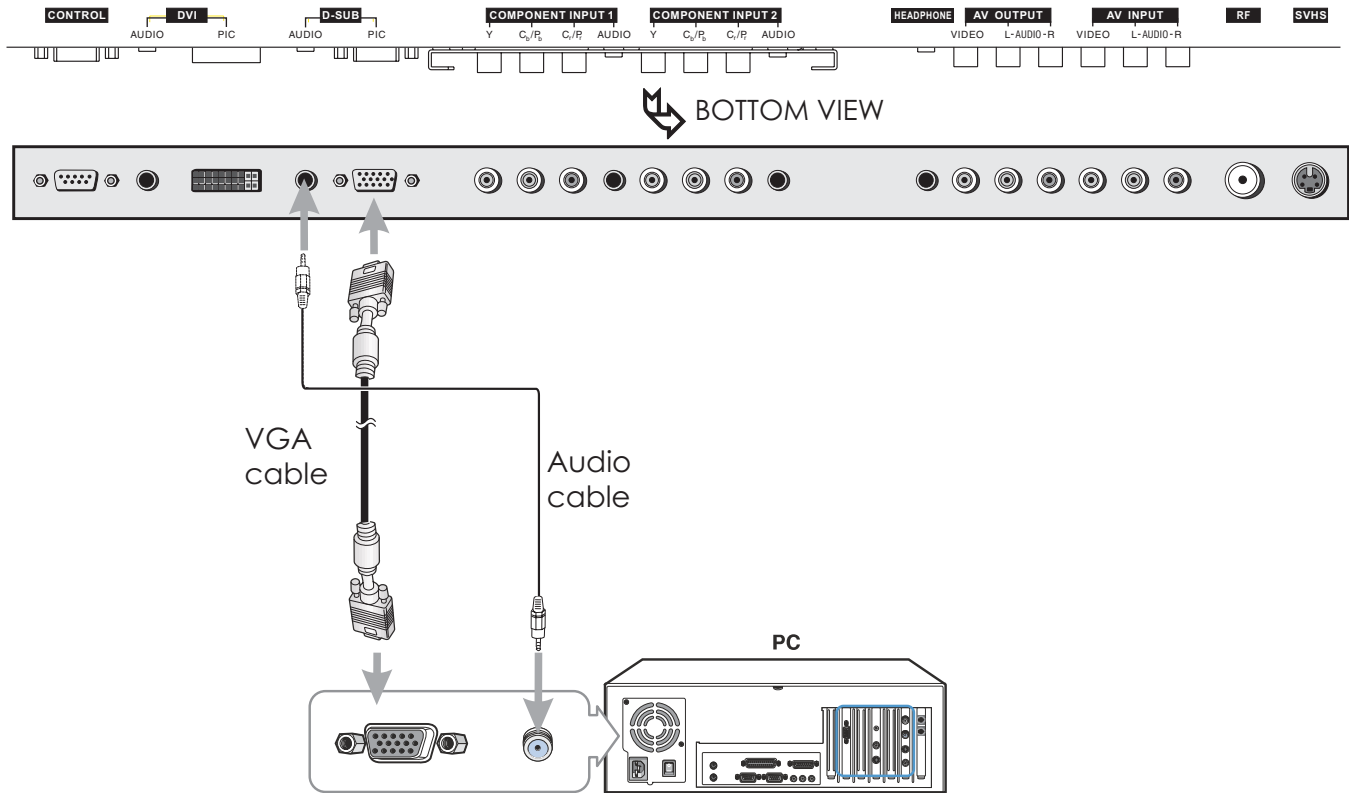

How to connect:

Connect a VGA cable between the VGA jack on the PC and the VGA input jack on the unit.

Connect an Audio cable between the AUDIO output on the PC and AUDIO input jack on the unit.

To Watch the PC screen

1. Turn on your PDP TV , press **SOURCE** button on the remote control.
2. Press **VOL+/-** to select **A** (VGA).
3. Press **ENTER** to confirm.

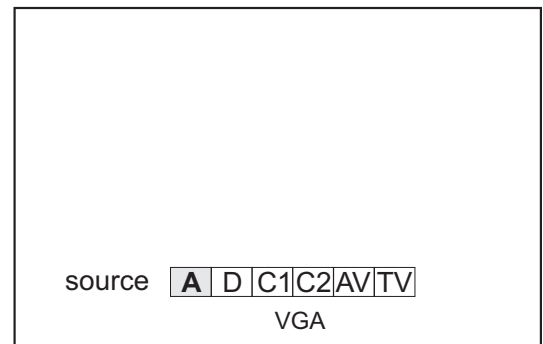

Connect a VCR (for recording) or external amplifier

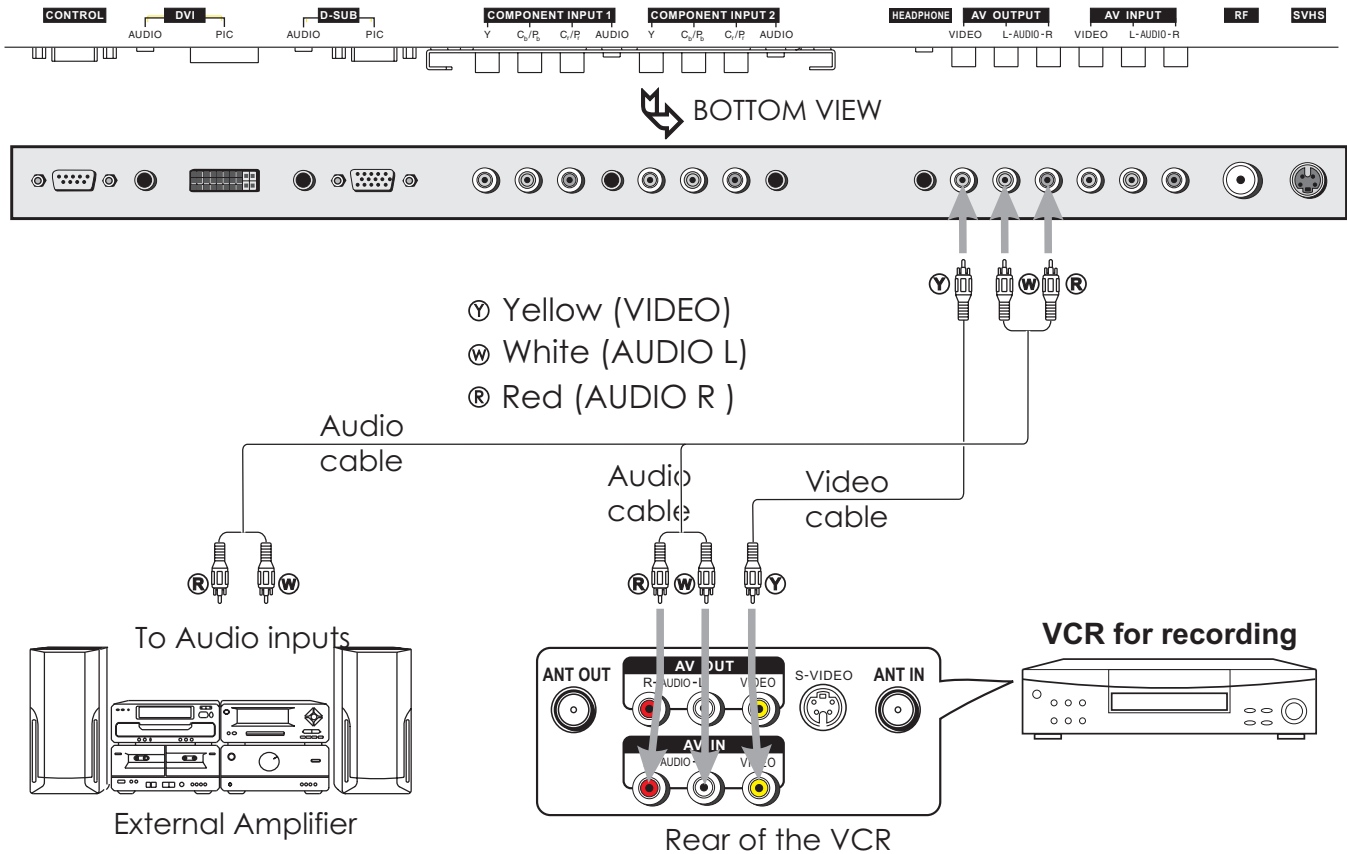

How to connect:

Connect the Audio/Video cables between the Audio (L/R)/Video jacks on the unit and VCR.



Connect the Audio cables between the Audio (L/R) jacks on the unit and external amplifier.

To record program

1. Turn on your PDP TV, select AV or TV source you wish to record.
2. Turn on your VCR, insert a videotape for recording.
3. Press the Record button to begin recording.

To enjoy high-quality sound through an external amplifier

1. Turn on your PDP TV, select AV or TV source.
2. Turn the main volume of the amplifier to minimum.
3. Turn on the amplifier and adjust for a proper volume.

Note:

The operations of the amplifier may be different depending on model. Please read the user manual of your amplifier to confirm proper operation.

The AV output terminals output audio/video signal inputted from Antenna input or AV inputs only.

Turning the Unit On and Off

Turning the Unit On and Off

Turning On

Insert the power cord into the wall outlet.
Press the Power Switch on the unit.
Press the **Power** button on the remote control.

Turning Off

With the power on, Press the **Power** button on the remote control to turn off the unit temporarily. If you want to cut off

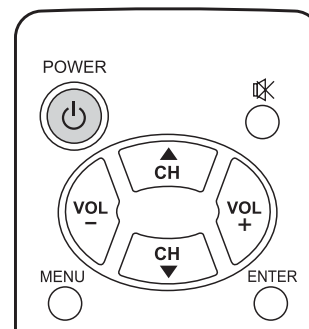

Note:



Viewing the Menu and Displays

Your PDP TV has a simple, easy-to-use menu system that appears on the screen. This system makes it convenient and fast to use features on the unit.

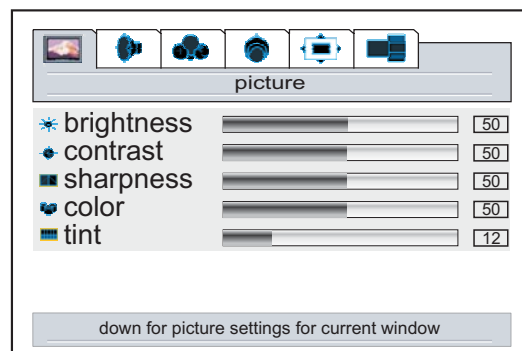

Viewing the Menu

1 With the power on, press the **MENU** button on the remote

2 Use the **CH** \uparrow / \downarrow to select menu item. Use **VOL** \pm to adjust value or setting of each item. Use **ENTER** to confirm or access items of menu.

On-screen menu will disappear from the screen automatically after about 15 seconds, or you can press

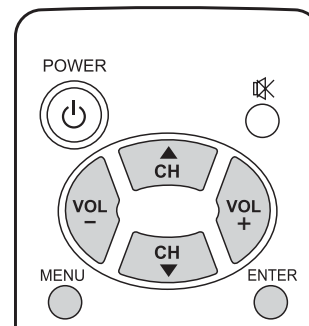

Note:

To clearly introduce the menu operations, this operation

3 In MENU operations, the \uparrow / \downarrow buttons have the same function with the **CH** \uparrow / \downarrow buttons, the \leftarrow / \rightarrow buttons have the same function with the **VOL** \pm buttons, the button

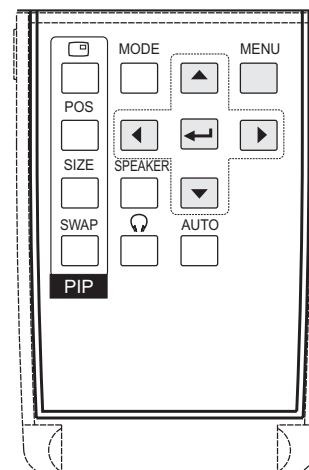

Displaying Status Information

Press the **DSP** button on the remote control, the unit will display current status information such as

Your PDP TV can memorize and store all of the available channels for both antenna and cable channels. After the available channels are memorized, use CH▲/▼ to scan through the available

Selecting the Signal Source

Before your PDP TV can memorize the available channels, you must specify the type of signal source that is connected

- 1 Press **MENU** to display the menu main
- 2 Press **VOL+/-** repeatedly to display **options** menu page
- 3 Press **CH▼** to select **tv tuner** item.
- 4 Press **VOL+** or **ENTER** to access the submenu.
If the **search** menu does not display, press **VOL+/-** repeatedly to display **search** menu page.
- 5 Press **CH▼** to select **source** item.
- 6 Press **VOL+/-** to select **antenna** or **cable**.

If you are connected to an antenna, please select antenna (the selected item displays in green). If you connect cable, please select cable.

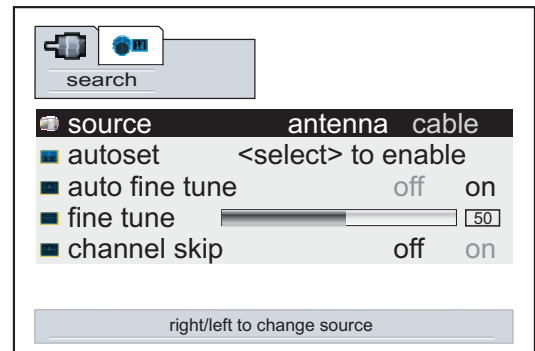
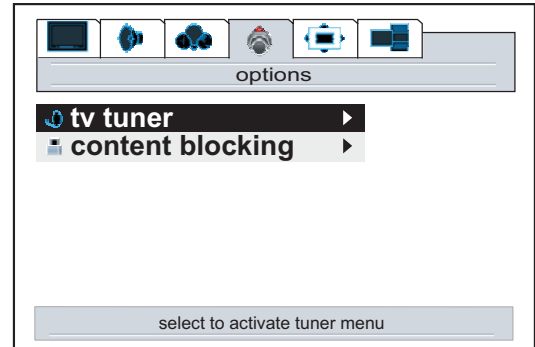

Storing Channels in Memory Automatically

- 1 Repeat steps 1~4 in [**Selecting the Signal Source**] to
- 2 Press **CH▼** twice to select **autoset** item.
- 3 Press **ENTER** to store channels in memory automatically.
The unit will begin memorizing all of the available channels.

Note:

The process of auto memory will be stopped if you press the **MENU** button.

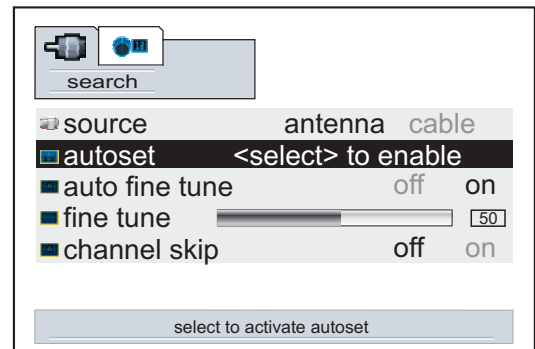

Setting Auto Fine Tune (AFT)

- 1 Repeat steps 1~4 in [**Selecting the Signal Source**] to display **search** menu page.
- 2 Press **CH** ▾ repeatedly to select **auto fine tune** item.
- 3 Press **VOL+/-** to select **on** or **off**.
When the AFT is set to On, the unit will automatically tune the program frequency to provide the best possible picture and sound.

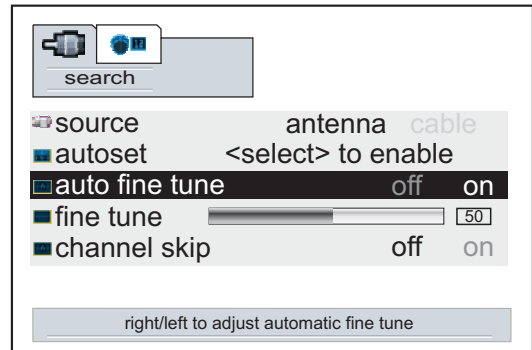

Manual Fine Tuning

- 1 Repeat steps 1~4 in [**Selecting the Signal Source**] to display **search** menu page.
- 2 Press **CH** ▾ repeatedly to select **fine tune** item.
- 3 Press **VOL+/-** to fine tune till the best possible picture and sound are obtained.
If you fine tune a program manually, the **auto fine tune** item will be turned to **off** automatically.

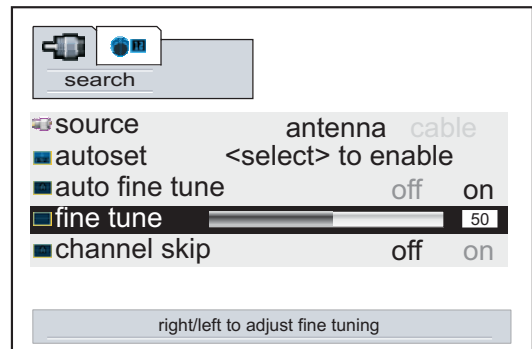

Adding and Erasing Channels

- 1 Use **number buttons** to directly select a channel that will be added or erased.
- 2 Repeat steps 1~4 in [**Selecting the Signal Source**] to display **search** menu page.
- 3 Press **CH** ▾ repeatedly to select **channel skip** item.
- 4 Press **VOL+/-** to select **on** or **off**.
When the item is set to on, the selected channel will be erased. When the item is set to off, the selected channel will be added.
The erased channels can not be selected by using the **CH** ▲ / ▾ buttons unless you use **number buttons** to input channel number directly.

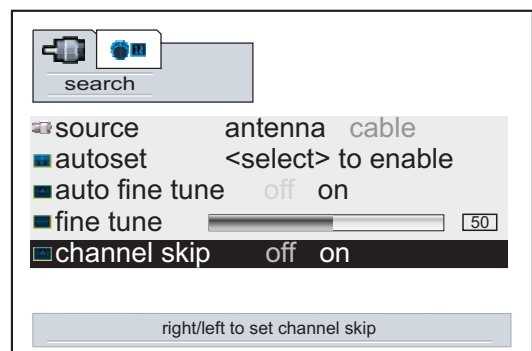

Changing Channels

Using the Channel Buttons (CH ▲ or CH ▼)

Press the **CH ▲** or **CH ▼** to change channels.

When you press the **CH ▲** or **CH ▼**, the unit changes channels in sequence. You will see all the channels that the unit has memorized.

You will not see channels that were erased, not memorized or unavailable.

Direct Accessing Channels

Press the number buttons to go directly to a channel.

To select a one-digit channel:

Input the channel using the **0-9 number buttons** directly and then press **ENTER** or wait for 3 seconds.

To select a two-digit channel:

Input the channel using the **0-9 number buttons** directly and then press **ENTER** or wait for 3 seconds.

To select a three-digit channel:

Note:

Be sure to enter the channel within 3 seconds.

When you use the number buttons, You may directly select channels that were erased.

Using the RETURN button

Press this button to switch between the current channel and the previous channel.

Adjusting the Volume



Using the volume buttons (VOL- and VOL+)

Press the **VOL +** or **VOL -** to increase or decrease the volume.

Using the Mute

Using the MUTE button

At any time, you can temporarily turn off the sound using the **MUTE ** button.

- 1 Press the **MUTE ** button and the sound turns off.
- 2 To turn mute off, press the **MUTE ** button again, or simply press either the **VOL -** or **VOL+**.

Select input source signal

Using the SOURCE button

- 1 Press the **SOURCE** button to access **source** menu.
- 2 Press **VOL+** or **VOL-** to select a desired input channel.
- 3 Press **ENTER** to confirm and the unit display signal from the selected input channel.

A-----VGA, select signal from VGA (15-pin D-sub) terminals.

D-----DVI, select signal from DVI terminals.

C1-----YPbPr1/YCbCr1, select signal from YPbPr1/YCbCr1 terminals.

C2-----YPbPr2/YCbCr2, select signal from YPbPr2/YCbCr2 terminals.

AV -----VIDEO (SVIDEO), select signal from S-Video or Video terminal.

The S-Video is prior to Video terminal when they are connected at the same time.

TV -----Select TV signal.

Note:

This unit identifies the type of component video terminals automatically. If you connect **Y, Cb, Cr** terminals, the screen displays **YCbCr detected** on the bottom-right corner. Similarly, if the component video terminals are **Y, Pb, Pr**, the screen displays **YPbPr detected** on the bottom-right corner.

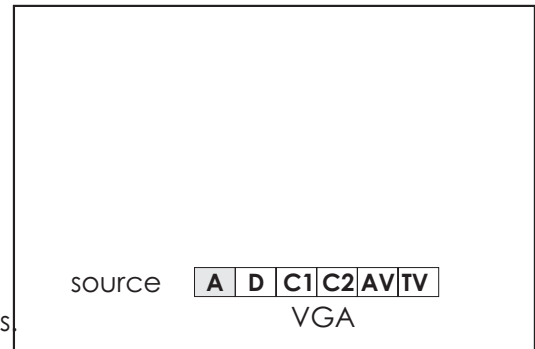

Using source select menu

- 1 Press **MENU** to display the menu main
- 2 Press **VOL+/-** to display **settings** menu page.
- 3 Press **CH** repeatedly to select **source select** item.
- 4 Press **VOL+** to access **source select** menu.
- 5 Press **CH** or **CH** to select a desired input channel.
- 6 Press **ENTER** to confirm and the unit displays signal from the selected input channel.

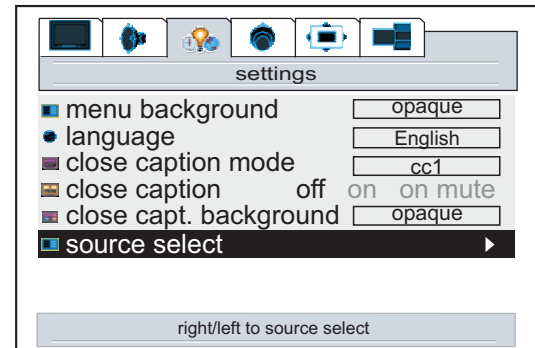

Selecting a MENU language

- 1 Press **MENU** to display the menu main
- 2 Press **VOL+/-** repeatedly to display **settings** menu page
- 3 Press **CH** twice to select **language** item.
- 4 Press **VOL+/-** to select the appropriate language: **English, French** and **Spanish**.
- 5 Press **MENU** to exit.

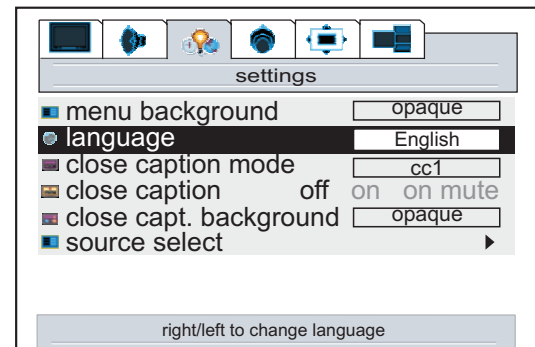

Editing Channel Label

- 1 Press **MENU** to display the menu main
- 2 Press **VOL+/-** repeatedly to display **options** menu page
- 3 Press **CH**▼ to select **tv tuner** item.
- 4 Press **VOL+** to enter.
- 5 Press **VOL+** again to display **channel** menu page.
- 6 Press **CH**▼ to select **edit labels** item.
- 7 Press **VOL+** to enter into channel label editing mode.
- 8 Use **CH**▲/▼ to select a channel you want add label to.
 Use ▲/▼ to select character.
 Use ◀/▶ to move cursor left or right.
 Use **SOURCE** [] to clear label text if you wish to reset.
 Use **MENU** to return.

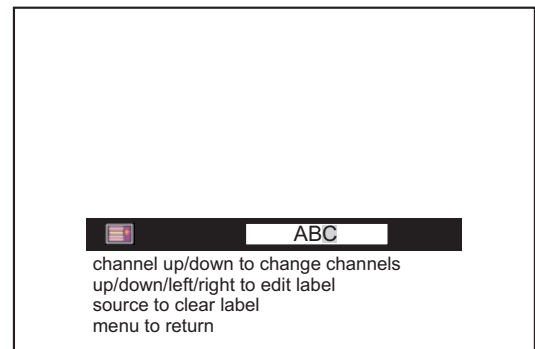
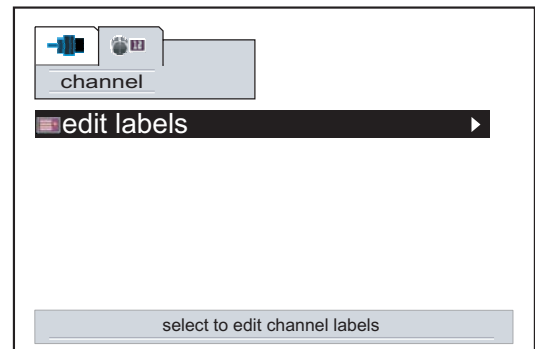
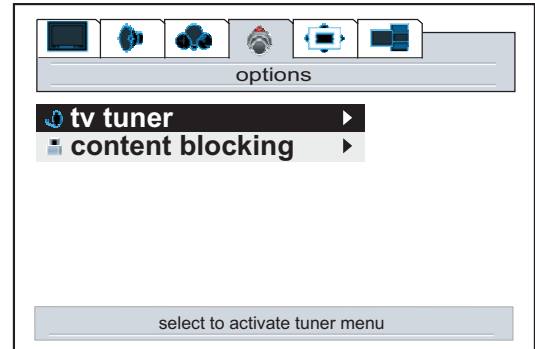

Setting Picture

Customizing the Picture

- 1 Press **MENU** to display the menu main
If the **picture** menu does not display, press **VOL+/-** repeatedly to display **picture** menu page.
- 2 Press **CH ▲ / ▼** to select the item you wish to change.
- 3 Press **VOL+/-** to adjust the value of the item.
- 4 Press **MENU** to exit.

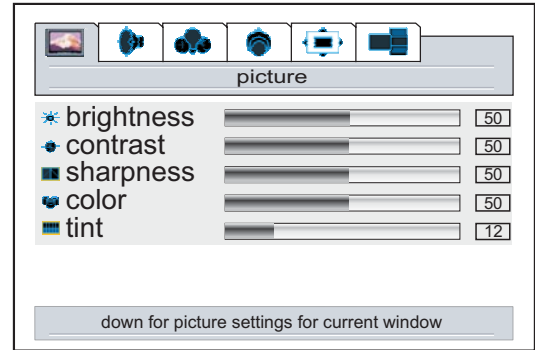

Using the Preset Picture Mode

- 1 Press **P.M** on the remote to display **picture mode** select menu.
- 2 Press **VOL+/-** to select a desired picture mode.
- 3 Press **MENU** to exit.

There are three preset picture modes (**Normal**, **Bright** and **Soft**) and one user-set picture mode (**User**). Each preset mode has its own picture settings.

Normal: Select for a normal picture.

Bright: Select for a bright picture.

Soft: Select for a fine/soft picture.

Adjusted settings are stored in User

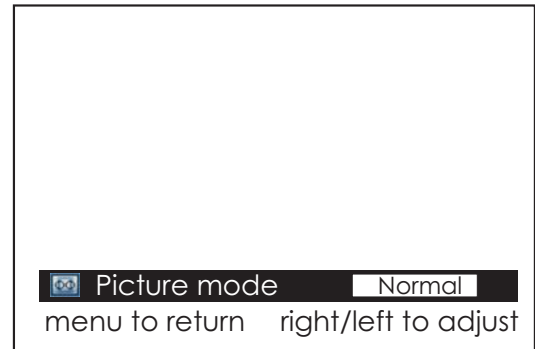

Setting the Menu Background

- 1 Press **MENU** to display the menu main
- 2 Press **VOL+/-** to display **settings** menu page.
- 3 Press **CH**▼ to select **menu background** item.
- 4 Press **VOL+/-** to select **opaque** or **translucent**.

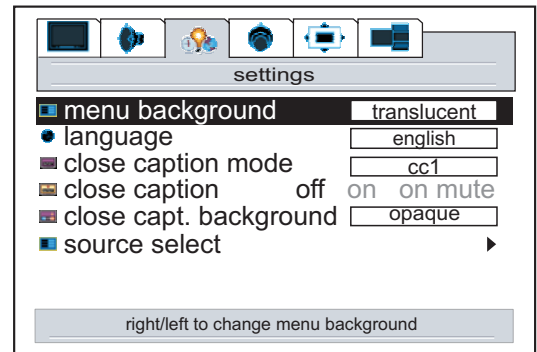

Setting Sleep Timer

- 1 Press the **SLP** button to display **sleep time** menu.
- 2 Press **VOL+/-** to adjust.
- 3 Press **MENU** to exit.

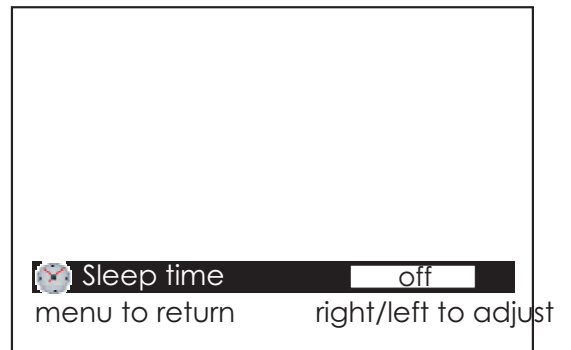

Changing the Scaling mode of Image

- 1 Press **MENU** to display the menu main page.
- 2 Press **VOL+/-** to display **window** menu page.
- 3 Press **CH** ▾ to select **image size** item.
- 4 Press **VOL+/-** to select a proper image size.
The image size can be selected between: fill all, normal, wide and zoom.

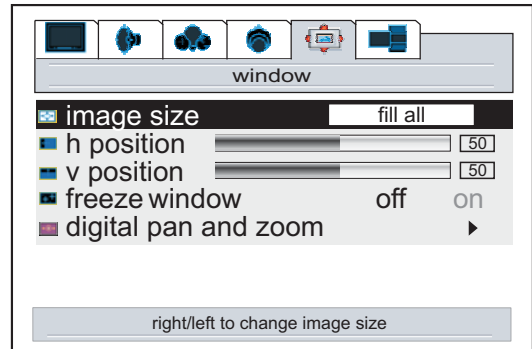

Fill All

The Fill All mode stretches the input vertically and horizontally to fill the display from edge to edge. This mode is the default mode.

Normal

The Normal mode fills the display vertically with a 4:3 aspect picture, preserving the geometry of the input format.

Wide

The Wide mode only affects displays that are greater than 4:3 aspect. If the picture is less than or equal to 4:3, this mode acts as if it is in Normal mode. It is intended to display 4:3 images on a 16:9 panel with the least picture deformity. The center of the picture is left unstretched. The left and right sides of the picture are stretched in a non-linear fashion with the areas of greatest distortion on the extreme left and right edges of the picture. The top and bottom five percent of the picture are cropped.

Zoom

If the display aspect ratio is greater than 4:3, this mode fills the panel horizontally, cropping 10 percent off the top and bottom of the picture. If the display aspect ratio is less than 4:3, this mode crops the picture by 16.5 percent on all sides and fills the panel with the remaining picture.

Freezing the Picture

- 1 Press **MENU** to display the menu main page.
- 2 Press **VOL+/-** to display window menu page.
- 3 Press **CH** ▾ repeatedly to select **freeze window** item.
- 4 Press **VOL+/-** to select **on** or **off**.

When you set this item to **on**, the current picture will be frozen until you set this item to **off**.

Note:

This menu item appears only when the current screen layout is full screen.

*You can also quickly freeze current picture by using the **STILL** button.*

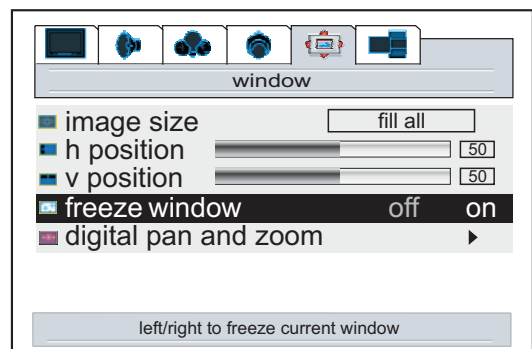

Changing the Position of the Image

The unit allows you to adjust the position of the image if it is not well-aligned.

- 1 Press **MENU** to display the menu main page.
- 2 Press **VOL+/-** to display **window** menu page.
- 3 Press **CH**▼ repeatedly to select **h position** or **v position**
- 4 Press **VOL+/-** to adjust until the picture is well-aligned.

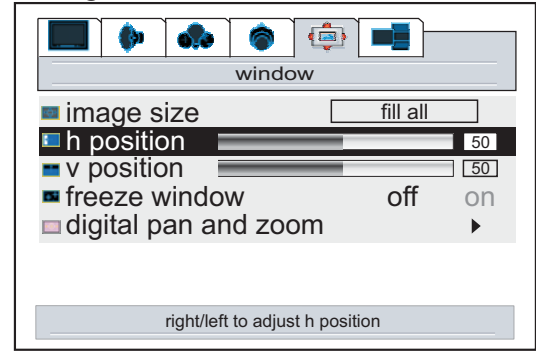

Using Digital Pan and Zoom

- 1 Press **MENU** to display the menu main page.
- 2 Press **VOL+/-** to display **window** menu page.
- 3 Press **CH**▼ repeatedly to select **digital pan and zoom**
- 4 Press **VOL+** to enter.
- 5 Press **CH**▲/▼ to adjust zoom ratio.

Note:

You can quickly access Zoom menu by using the **ZOOM** button.

Digital pan and zoom are not always available.

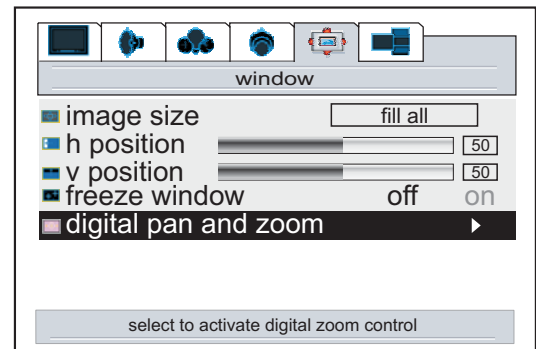

The unit allows you to pan the picture after you zoom in the picture

- 1 Repeat steps 1~5 above to zoom in the picture.
- 2 Press **ENTER** to access Pan mode.
- 3 Press **VOL+/-** or **CH**▲/▼ to pan the current picture in the relevant direction.

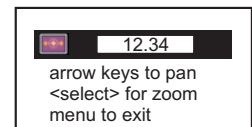
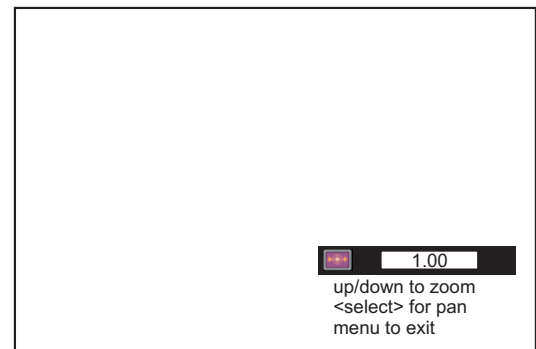

Using the Preset Audio Mode

- 1 Press **MENU** to display the menu main page.
- 2 Press **VOL+/-** to display **audio** menu page.
- 3 Press **CH**▼ to select **Audio mode** item.
- 4 Press **VOL+/-** to select a desired Audio mode.

Note:

You can not access the **treble** and **bass** item unless the **Audio mode** is set to **User**.

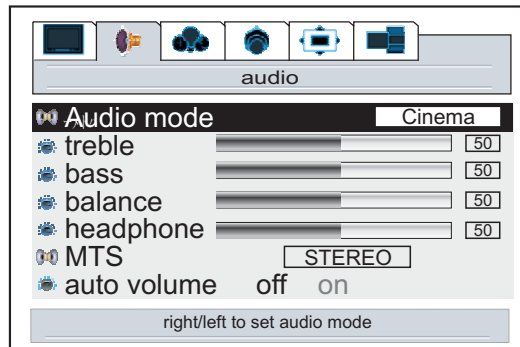

Customizing the Sound

- 1 Press **MENU** to display the menu main
- 2 Press **VOL+/-** to display **audio** menu page.
- 3 Press **CH**▲/▼ to select **treble**, **bass** or **balance** item.
- 4 Press **VOL+/-** to adjust the value of the item.

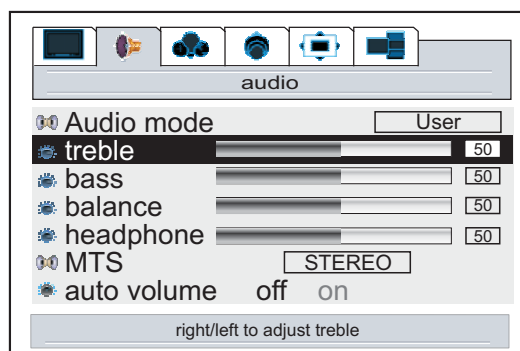

Using the S.M button

- 1 Press **S.M** to display **Audio mode** select menu.
- 2 Press **VOL+/-** to select a desired Audio mode.
- 3 Press **MENU** to exit.

There are three preset Audio modes (**Cinema**, **Music** and **News**) and one user-set Audio mode (**User**).

Each preset mode has its own Audio settings.

Cinema: Select for a movie program picture.

Music: Select for a music program.

News: Select for a speech or conversation program.

Adjusted settings are stored in User mode.

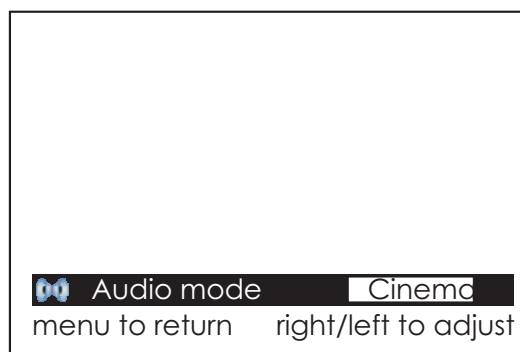

Adjusting the Headphone Volume

- 1 Press **MENU** to display the menu main
- 2 Press **VOL+/-** to display **audio** menu page.
- 3 Press **CH**▼ repeatedly to select **headphone** item.
- 4 Press **VOL+/-** to adjust the volume of headphone.

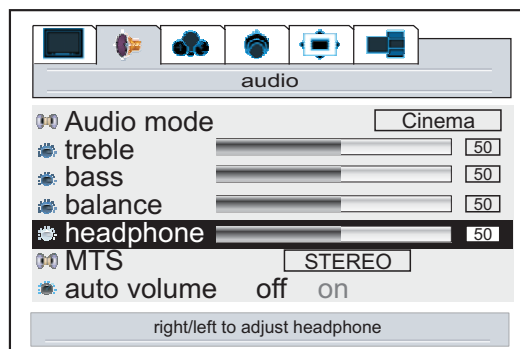

Choosing a Multi-Channel Sound (MTS) Soundtrack

1 Press **MENU** to display the menu main page.

2 Press **VOL+/-** to display **audio** menu page.

3 Press **CH** repeatedly to select **MTS** item.

4 Press **VOL+/-** to select **STEREO**, **SAP** or **MONO**.

Choose **STEREO** for channels that are broadcasting in stereo.

Choose **MONO** for channels that are broadcasting in mono, or if you are having difficulty receiving a stereo signal.

Choose **SAP** to listen to the Separate Audio Program, which is usually a foreign-language translation of a program.

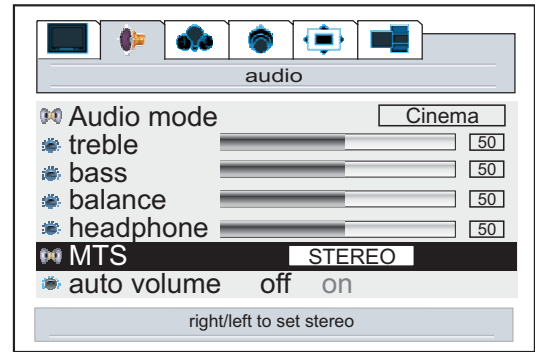

Using the MTS button

1 Press the **MTS** button to access **MTS** setting menu.

2 Press **VOL+/-** to select **STEREO**, **SAP** or **MONO**.

3 Press **MENU** to exit.

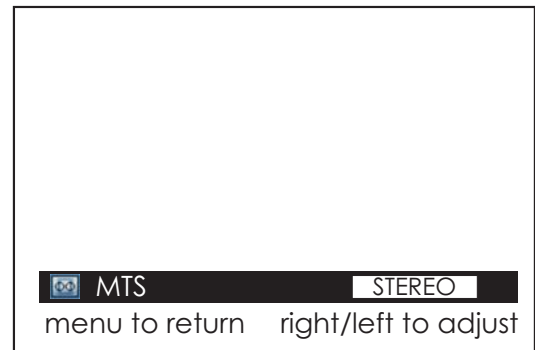

Using the Auto Volume

Each broadcasting station has its own signal conditions, which can make it necessary to adjust the volume every time the channel is changed. "Auto volume" lets you automatically adjust the volume of the desired channel by lowering the sound output when the modulation signal is high or by raising the sound output when the modulation signal is low.

1 Press **MENU** to display the menu main page.

2 Press **VOL+/-** to display **audio** menu page.

3 Press **CH** repeatedly to select **Auto volume** item.

4 Press **VOL+/-** to select **on** or **off**.

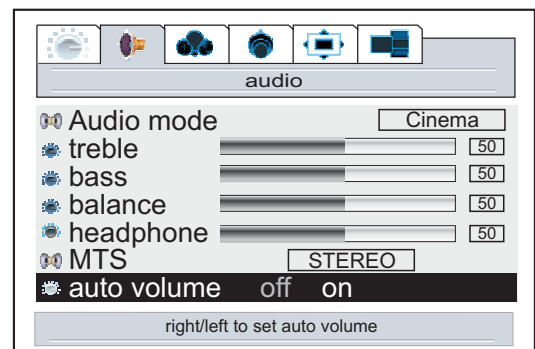

Changing Screen Layout

Selecting Screen Layout

Using the Layout Menu

- 1 Press **MENU** to display the menu main page.
- 2 Press **VOL+/-** to display **layout** menu page.
- 3 Press **CH▲/▼** to select item.
- 4 Press **VOL+** or **ENTER** to confirm.

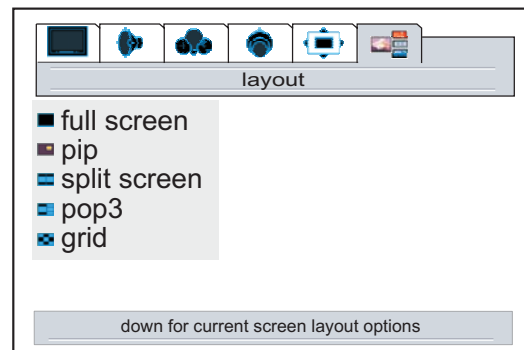

Using the MODE button

- 1 Press the **MODE** button to display the **screen layout** select
- 2 Press **VOL+/-** to select item.
- 3 Press **ENTER** to confirm.
- 4 Press **MENU** to exit.

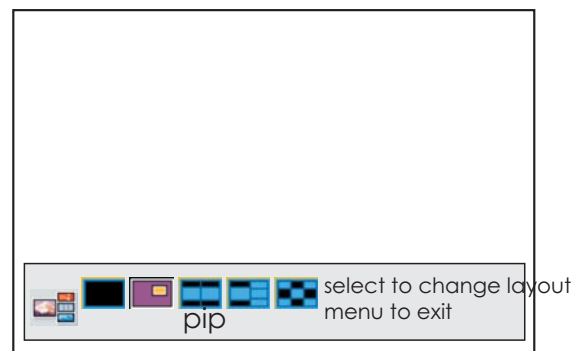

Full Screen

When this item is selected, only main frame displays on the screen.

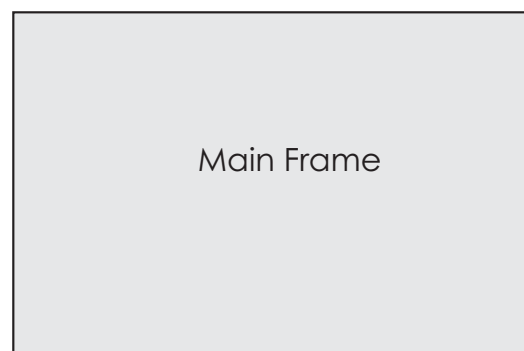

PIP

When this item is selected, one main frame and one PIP frame display on the screen at the same time.

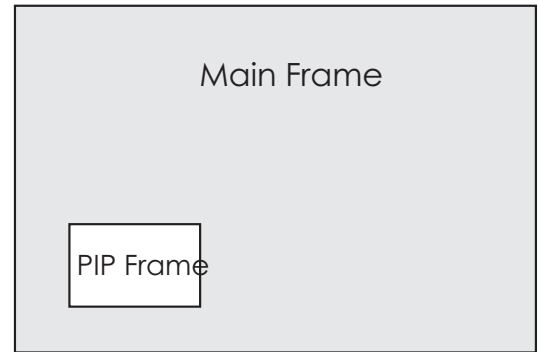

Split Screen

When this item is selected, the screen will be split into two frames.

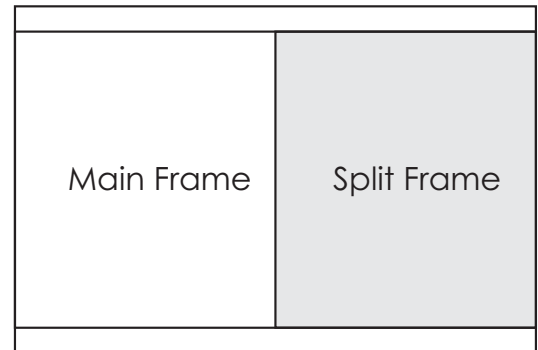

POP3

When this item is selected, one main frame and three scanning frames display on the screen.

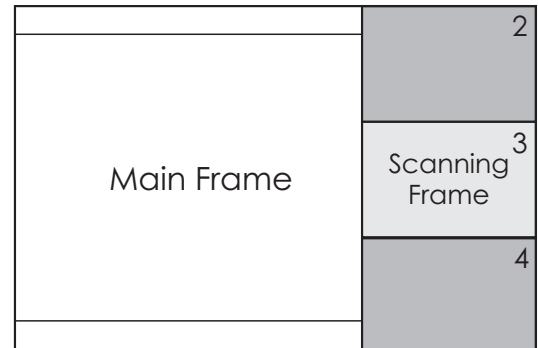

Grid

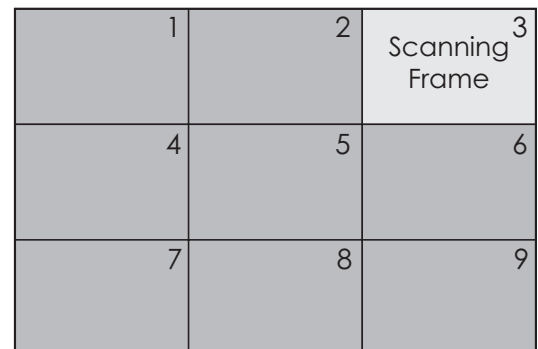

When this item is selected, the screen displays 9 scanning frames.



Viewing the Picture-in-Picture

- 1 Press **MENU** to display the menu main page.
- 2 Press **VOL+/-** to display **layout** menu page.
- 3 Press **CH** ▾ twice to select **pip** item.
- 4 Press **VOL+** or **ENTER** to display pip frame.
The screen displays one main frame and one PIP frame.
- 5 Press ▲ or ▼ to select main frame or PIP frame.
The selected frame displays with a green border.

Note:

- ▶ You can quickly open or close PIP frame by directly using the **PIP displaying**  button.
- ▶ Many but not all adjustments and settings can be applied to the PIP picture when the PIP frame is selected.
- ▶ To cancel PIP frame, press the **PIP displaying** button or select the full screen item and confirm.
- ▶ The audio of the selected picture can be output from the speaker or headphone by using the **SPEAKER** or  button on the remote control.

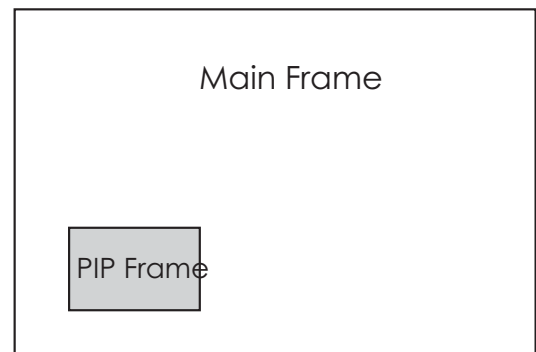
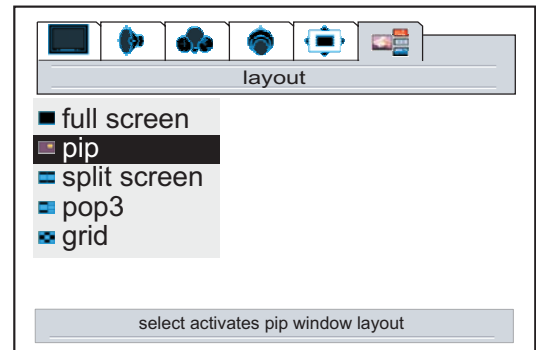

Swap the Contents of the PIP Image and Main Image

- 1 Press the **PIP displaying**  button to display the PIP frame.
- 2 Press the **SWAP** button to swap the contents of the PIP image and main image.

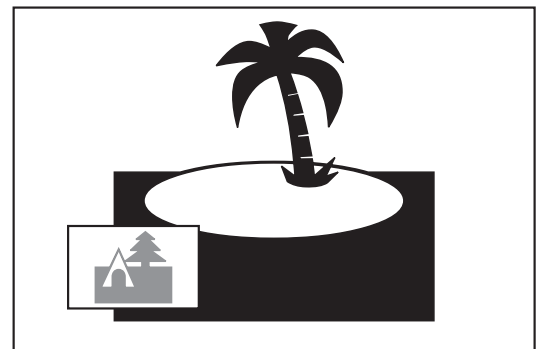
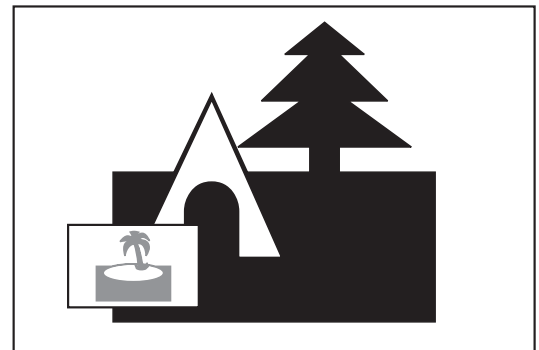

Changing the Position of the PIP Frame

- 1 With the PIP frame displaying, press **MENU** to display the menu main page.
- 2 Press **VOL+/-** to display **window** menu page.
- 3 Press **CH** repeatedly to select **pip position** item.
- 4 Press **VOL+/-** to select a desired position for the PIP frame.

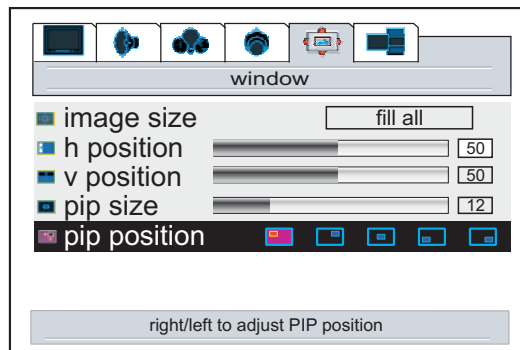

Using the POS button

- 1 Press the **POS** button to quickly access the **pip position** select menu.
- 2 Press **VOL+/-** to select a desired position for the pip frame.
- 3 Press **MENU** to exit.

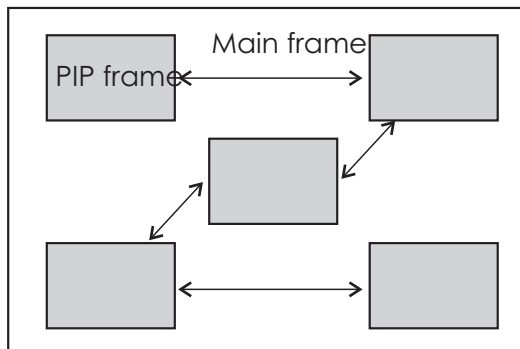

Adjusting the Size of PIP Frame

- 1 With the PIP frame displaying, press **MENU** to display the menu main page.
- 2 Press **VOL+/-** to display **window** menu page.
- 3 Press **CH** repeatedly to select **pip size** item.
- 4 Press **VOL+/-** to adjust the size of PIP frame.
- 5 Press **MENU** to exit.

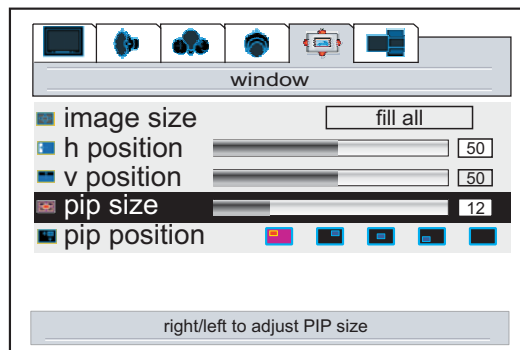

Using the SIZE button

- 1 Press the **SIZE** button to quickly access the **pip size** adjusting menu.
- 2 Press **VOL+/-** to adjust the size of the pip frame.
- 3 Press **MENU** to exit.

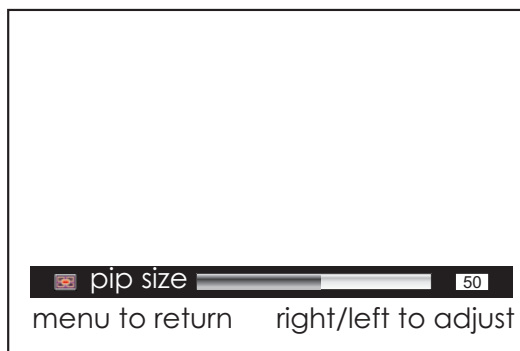

Adjustment in PC (VGA) Mode

With working in VGA mode, this unit allows you to perform several adjustments.

Adjusting Picture

- 1 Press **MENU** to display the menu main page.
If the **picture** menu does not display, press **VOL+/-** repeatedly to display **picture** menu page.
- 2 Press **CH ▲ / ▼** to select **brightness** or **contrast** item.
- 3 Press **VOL+/-** to adjust the value of the item.

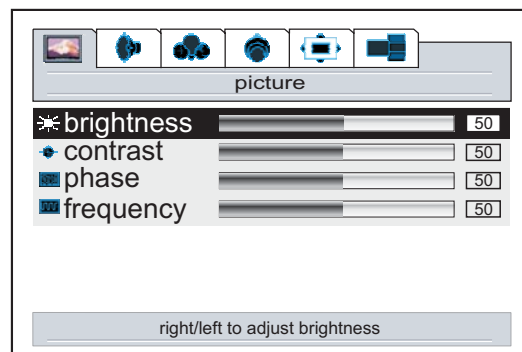

Adjusting the Phase and Frequency

- 1 Press **MENU** to display the menu main page.
If the **picture** menu does not display, press **VOL+/-** repeatedly to display **picture** menu page.
- 2 Press **CH ▲ / ▼** to select **phase** or **frequency** item.
- 3 Press **VOL+/-** to adjust the value of the item.
- 4 Press **MENU** to exit.

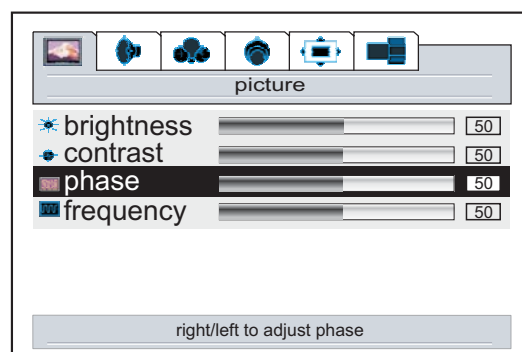

You may find that images blur, depending on the clock phase of your PC's Processor. If you experience blurring , you can obtain a clearer image by adjusting the phase setting. Adjust the clock frequency of the set's internal clock signal. If shimmering or rainbow-like noise is apparent in the image, try adjusting the frequency setting.

Adjusting the Picture Automatically

If you are not satisfied with the picture , you may quickly adjust the picture by using the **AUTO** button. After the **AUTO** button is pressed, the message "**Auto running**" appears on the screen and the picture adjustments are automatically activated.

Changing the Scaling mode of Image

- 1 Press **MENU** to display the menu main
- 2 Press **VOL+/-** to display **window** menu page.
- 3 Press **CH ▾** to select **image size** item.
- 4 Press **VOL+/-** to select **fill all** or **Normal**.
- 5 Press **MENU** to exit.

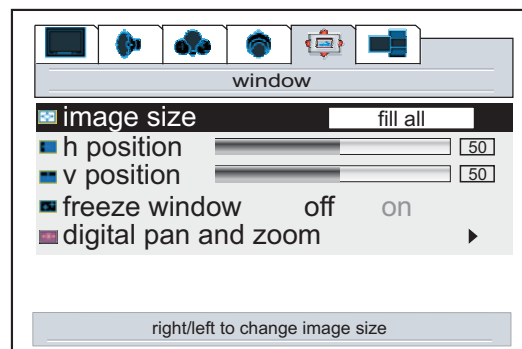

Fill All---this mode stretches the input vertically and horizontally to fill the full screen. This mode is the default mode.

Normal---this mode displays the incoming picture with normal ratio.

Changing the Position of Image

After connecting the unit to your PC, adjust the position of the screen if it is not well-aligned.

- 1 Press **MENU** to display the menu main
- 2 Press **VOL+/-** to display window menu page.
- 3 Press **CH ▲ / ▾** to select **h position** or **v position** item.
- 4 Press **VOL+/-** to adjust the value of the item until the screen is well-aligned.
- 5 Press **MENU** to exit.

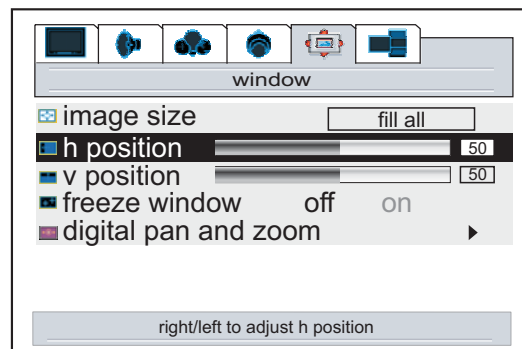

Displaying the Information

When the **DSP** button is pressed in PC (VGA) mode, the unit displays some information such as the vertical frequency and resolution.

Changing the Scaling mode of Image

- 1 Press **MENU** to display the menu main page.
- 2 Press **VOL+/-** to display **window** menu page.
- 3 Press **CH** \blacktriangledown to select **image size** item.
- 4 Press **VOL+/-** to select **fill all** or **Normal**.
- 5 Press **MENU** to exit.

Fill All---this mode stretches the input vertically and horizontally to fill the full screen. This mode is the default mode.

Normal---this mode displays the incoming picture with normal ratio.

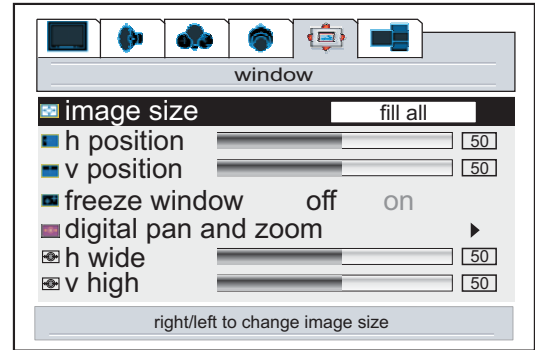

Changing the Position of Image

After connecting the unit to your device, adjust the position of the screen if it is not well-aligned.

- 1 Press **MENU** to display the menu main
- 2 Press **VOL+/-** to display window menu page.
- 3 Press **CH** \blacktriangle / \blacktriangledown to select **h position** or **v position** item.
- 4 Press **VOL+/-** to adjust the value of the item until the screen is well-aligned.
- 5 Press **MENU** to exit.

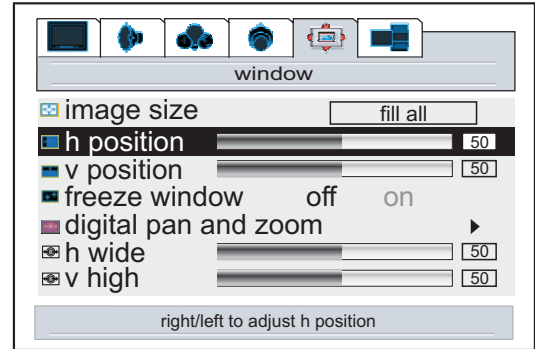

Adjusting Image width and height

- 1 Press **Menu** to display the menu main
- 2 Press **VOL+/-** to display window menu page.
- 3 Press **CH** \blacktriangle / \blacktriangledown to select **h wide** or **v high** item.
- 4 Press **VOL+/-** to adjust the value of the item.
- 5 Press **Menu** to exit.

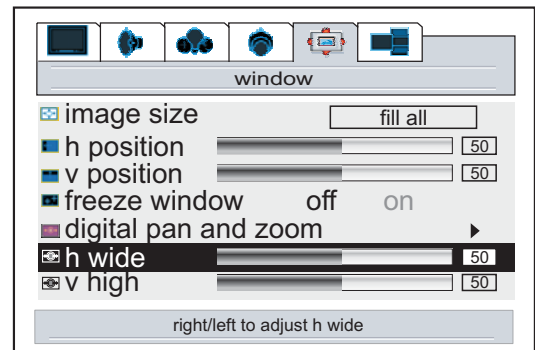

The unit decodes and displays the closed captions that are broadcast with certain TV shows. These captions are usually subtitles for the hearing impaired or foreign language translations. All VCRs record the closed caption signal from television programs, so home-recorded video tapes can also provide closed captions. Most prerecorded commercial video tapes provide closed captions as well. Check for the closed caption symbol in your television schedule and on the tape's packaging:

Note:

The Caption feature works in TV mode only.

Not all the programs and videos will offer closed captioning. Please look for the  symbol to ensure that captions have been provided.

Setting Closed Caption

- 1 Press **MENU** to display the menu main page.
- 2 Press **VOL+/-** to display **settings** menu page.
- 3 Press **CH**▼ repeatedly to select **close caption** item.
- 4 Press **VOL+/-** to select **off**, **on** or **on mute** item.

Off---Turn off the closed caption. If you select **off**, the **close caption mode** and **close capt. background** can not be accessed.

On---Turn on the closed caption.

On Mute---Turn on the closed caption when mute. If you select **on mute**, the **close caption mode** and **close capt. background** can not be accessed unless you mute the sound.

- 5 Press **CH**▲ to select **close caption mode** item.
- 6 Press **VOL+/-** to select a desired mode.

You can select between **cc1**, **cc2**, **t1**, **t2**, **cc3**, **cc4**, **t3** and The Closed Caption broadcasts can be viewed in two modes: CAPTION and TEXT. For each mode, four channels

The [CAPTION] mode shows subscripts of dialogues and commentaries of TV dramas and news programs while allowing a clear view of the picture.

The [TEXT] mode displays various information over the picture (such as TV program schedule, weather forecast, etc.) that is independent of the TV programs.

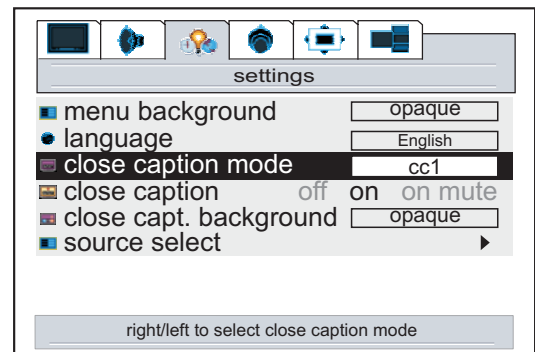
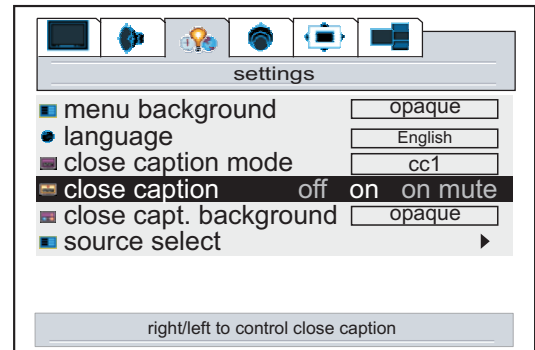

Setting the Background of Closed Caption

- 1 Press **MENU** to display the menu main page.
- 2 Press **VOL+/-** to display **settings** menu page.
- 3 Press **CH**▼ repeatedly to select **close capt. background** item.
- 4 Press **VOL+/-** to select **opaque** or **transparent**.

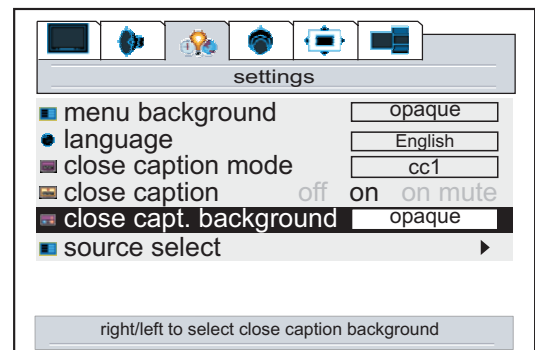

Adjusting V-CHIP Settings

V-CHIP

This function allows TV programs to be restricted and TV usage to be controlled based on FCC data. It prevents children from watching violent or sexual scenes that may be harmful.

Restriction of TV programs includes two ratings that contain information about the program: the MPAA rating and the TV Parental Guidelines. The MPAA rating is restricted by age. TV Parental Guidelines are restricted by age and content.

Since a TV program may use either the MPAA rating or the TV Guidelines, both should be adjusted for complete control.

[1] Movie Rating (MPAA)

Rating		
age based	G	GENERAL AUDIENCES. All ages admitted.
	PG	PARENTAL GUIDANCE SUGGESTED. Some material may not be suitable for children.
	PG-13	PARENTAL STRONGLY CAUTIONED. Some material may be inappropriate for children under 13.
	R	RESTRICTED. Under 17 requires accompanying parent or adult guardian.
	NC-17	NO ONE 17 AND UNDER ADMITTED.
	X	X Rating is an older rating that is unified with NC-17 but may be encoded in the data of older movies.
	NR	NOT RATED.

Note:

The Movie rating is only age-based.

Example 1:

"PG-13" in the age based rating is blocked, this will automatically block the higher ratings "R", "NC-17", "X" also.

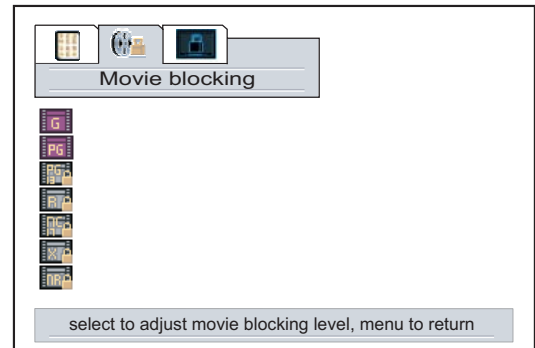

Example 2:

"R" in the age based rating is blocked, this will automatically block the higher rating "NC-17", "X" also.

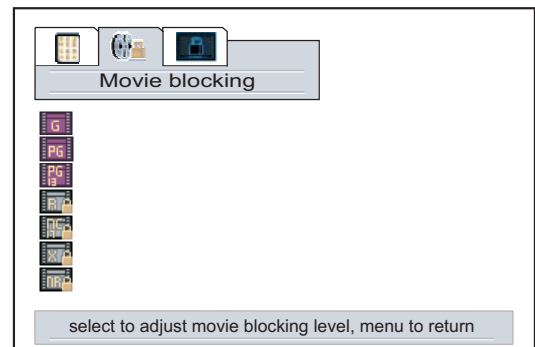

[2] TV Parental Guidelines

Rating		← content based →				
		D	L	S	V	FV
age based	TV-Y (All children)	X	X	X	X	X
	TV-Y7 (Direct to Older Children)	X	X	X	X	●
	TV-G (General Audience)	X	X	X	X	
	TV-PG (Parental Guidance Suggested)	●	●	●	●	
	TV-14 (Parents Strongly Cautioned)		●	●	●	
	TV-MA (Mature Audience Only)					

X — Content Rating can be set but this Rating is not normally broadcast by TV Station.

● — Content Rating can be set.

D: Sexually Suggestive Dialog

L: Adult Language

S: Sexual Situation

V: Violence

FV: Fantasy Violence

Note:

Age-based ratings can be modified by the content-based ratings but only in the combinations indicated by an ● in the table above.

Choosing lower age-based rating blocks the higher age-based ratings regardless of content ratings settings.

Example 1:

When TV-Y7 in the age-based rating is set to BLOCK, this will automatically block the higher ratings: TV-G, TV-PG, TV-14 and TV-MA.

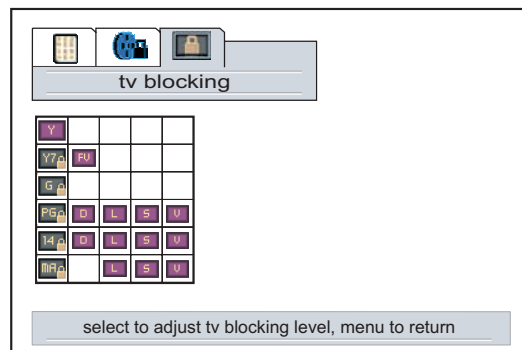

Example 2:

When TV-14 in the age-based rating is set to BLOCK, this will automatically block the higher ratings: TV-MA.

In addition, if you block "L" sub-rating in TV-PG, then the "L" sub-ratings in TV-14 and TV-MA will automatically be blocked.

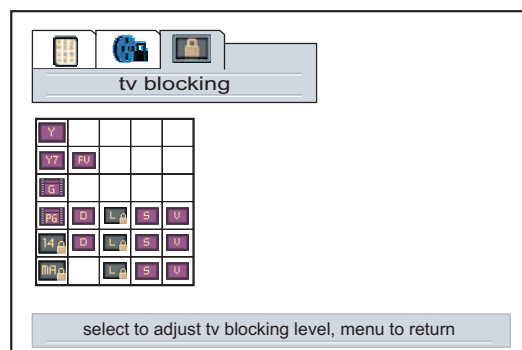

Accessing the V-CHIP Menu

- 1 Press **MENU** to display the menu main page.
- 2 Press **VOL+/-** to display **options** menu page.
- 3 Press **CH▼** to select **content blocking** item.
- 4 Press **VOL+** or **ENTER** to display password menu page.
- 5 Press **CH▼** to select **enter** item.
- 6 Input the password and highlight **OK**.
Use **VOL+/-** to move password digit leftward or rightward.
Use **CH▲/▼** to select character for password.
The default password is **000000**, you may change the password yourself.
- 7 Press **ENTER** to access the **V-CHIP** menu.
The unit allows you to access the V-CHIP menu if you input the right password, or you will be denied.

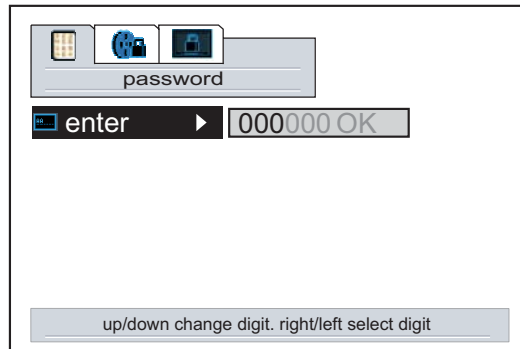
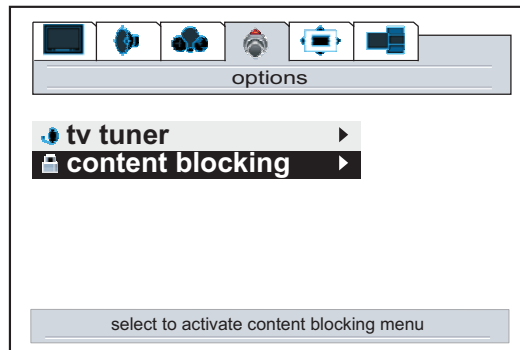

Changing the Password

- 1 From the **password** menu page, press **CH▼** to select **change** item.
- 2 Input a new password and highlight **OK**.
Use **VOL+/-** to move password digit left or right.
Use **CH▲/▼** to select character for new password.
- 3 Press **ENTER** to confirm.
Be sure to write down your password and retain it for future use.

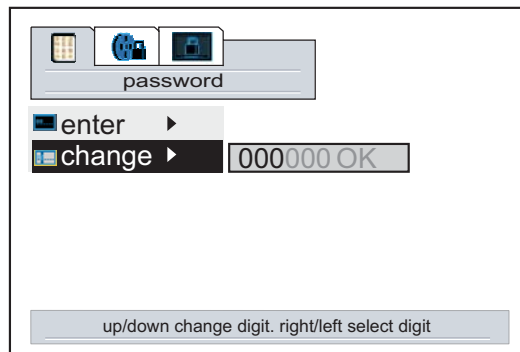

Adjusting the Movie Rating

- 1 Repeat steps 1~7 in [**Accessing the V-CHIP Menu**].
- 2 Press the **MENU** button.
- 3 Press **VOL+/-** to display **movie blocking** menu page.
- 4 Press **CH▲/▼** to select a rating to be blocked.
- 5 Press **ENTER** to confirm and **MENU** to return.

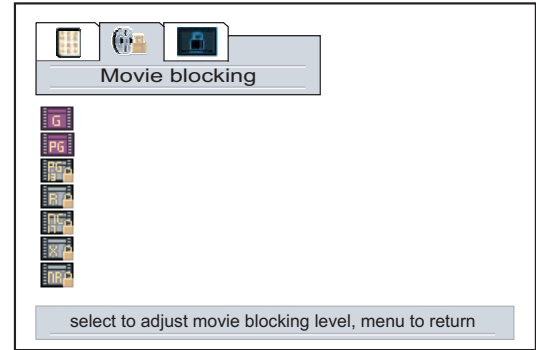

"PG-13" in the age-based rating is blocked, this will automatically block the higher ratings "R", "NC-17", "X" also.

How to unblock a Movie Rating

If you want to unblock a movie rating, please repeat steps 1~3 in [**Adjusting the Movie Rating**] and use **CH▲/▼** to select a blocked movie rating, then press **ENTER** to confirm.

Adjusting the TV Rating

- 1 Repeat steps 1~7 in [**Accessing the V-CHIP Menu**].
- 2 Press the **MENU** button.
- 3 Press **VOL+/-** to display **tv blocking** menu page.
- 4 Press **CH▲/▼** or **VOL+/-** to select an age or content rating to be blocked.
- 5 Press **ENTER** to confirm and **MENU** to return.

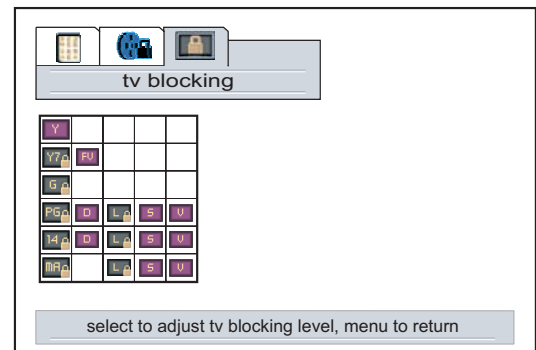

When TV-Y7 in the age-based rating is set to BLOCK, this will automatically block the higher ratings: TV-G, TV-PG, TV-14 and TV-MA. In addition, if you block "L" sub-rating in TV-PG, then the "L" sub-ratings in TV-14 and TV-MA will automatically be blocked.

Note:

Since a TV program may use either the MPAA rating or the TV Guidelines, both should be adjusted for complete control.

How to unblock a TV Rating

If you want to unblock a TV rating, please repeat steps 1~3 in [**Adjusting the TV Rating**] and use **CH▲/▼** or **VOL+/-** to select a blocked TV rating (including age rating and content rating), then press **ENTER** to confirm.

Troubleshooting

Before calling for repair service, check the following items for possible remedies to an encountered symptom.

Symptoms	Check item
"Ghost" or double images	<ul style="list-style-type: none">✍ This may be caused by obstruction to the antenna due to high rise buildings or hills. Using a highly directional antenna may improve the picture.
No power	<ul style="list-style-type: none">✍ Check that the AC power cord is plugged into the mains socket.✍ Unplug the power cord, wait for 60 seconds. Then re-insert plug into the mains socket and turn on the unit again.
No picture	<ul style="list-style-type: none">✍ Check antenna connections at the rear of the unit to see if it is properly connected to the unit.✍ Possible broadcast station trouble. Try another channel.✍ Adjust the contrast and brightness settings.✍ Check the Closed Captions control. Some TEXT modes could block the screen.✍ Select a correct input.✍ Is a non-compatible signal being used?
Good picture but no sound	<ul style="list-style-type: none">✍ Increase the VOLUME.✍ Check that the unit is not muted.✍ Check Whether the sound is output to headphone
Good sound but poor color	<ul style="list-style-type: none">• Adjust the contrast, color and brightness settings.
Poor picture	<ul style="list-style-type: none">✍ Sometimes, poor picture quality occurs when having activated an S-VHS camera or camcorder connected and having connected another peripheral at the same time. In this case, switch off one of the other peripherals.✍ Check whether the room is too bright
Horizontal dotted line	<ul style="list-style-type: none">✍ This may be caused by electrical interference (e.g. hairdryer, nearby neon lights, etc.)✍ Turn off the equipment.
Television not responding to remote control	<ul style="list-style-type: none">✍ Check whether the batteries are working. Replace if necessary.✍ Clean the remote control sensor lens on the unit.✍ Do not use the remote control under strong or fluorescent lighting.✍ The batteries should be inserted with polarity (+, -) aligned.
Snowy picture and noise	<ul style="list-style-type: none">✍ Check the antenna connection.
No stable or not synchronized VGA picture	<ul style="list-style-type: none">✍ Check if you have selected the correct VGA mode in your PC.
No output from one of the speakers	<ul style="list-style-type: none">✍ Adjust Balance in the audio menu.

Note:

If your problem is not solved, restart your TV by turning it off and then on using the POWER SWITCH.

Never attempt to repair a defective TV yourself.

Specifications:

Model Number: AR4200		Features	
UPC number: 0-44476-01943-2		EDTV Ready	
Display Specs		Progressive scan display	
Display type	Plasma	High Contrast Ratio	
Screen Size	42" (diagonal)	High Brightness (Cd/m ²)	
Aspect Ratio	16:9 aspect	3D Digital Comb Filter	
Resolution (native)	852 (H) x 480 (V)	Hi-Resolution Component, S-video, AV, RF, VGA and DVI	
Active Area	36.73 inches (H) x 20.98 inches (V)	Picture in Picture (PIP) / Split screen / POP3 / Grid	
Brightness *	640Cd/m ² (Avg)	Parental Control with V-Chip	
Contrast ratio *	1000:1 aspect (Avg)	Closed Captions (CC)	
Viewing Angle	160/160	MTS - SAP / Stereo / Mono	
Dot Pitch	1.095 x 1.110mm	Sleep (Power/OFF)	
Maximum Color	16,777,216	Model Specific Remote	
MTBF Value***	30,000hours (8Hr/Day)	Wall mounting bracket included	
TV Reception		User friendly OSD Menu	
TV System	NTSC	OSD Menu in Opaque or Translucent background	
Channel	181 Channel Cable/Air	181 Channel Cable/Air Ready	
Antenna Impedance	VHF-L, VHF-H, UHF 75 Ohm	Personal Computer (PC) support (VGA 15 pin D-Sub)	
Connector type	Coax F-Connector	2 sets of component inputs	
Audio		On Screen Audio Equalizer	
Maximum Audio Output	10watt x 2ch	No Cooling fans	
Audio Output connection	spring clips	Screen Mode (normal 4:3, Wide 16:9, zoom, fill all)	
Total number of speakers included	0	Preset Auto and Video settings	
Connections		Power	
RF: TV/CATV 75ohms coaxial	1	Power Source	AC100V-240V, 60/50Hz
Composite Video input	1	Unit input power	AC100V-240V, 60/50Hz
S-Video input (4pin DIN)	1	Power ON consumption	400W
L/R Audio for Composite/S-Video input	1 (RCA)	Standby consumption	5W
Component input (Y,Pb/Cb,Pr/Cr)	2 (480i/p, 720p**, 1080***)	Dimension (WxHxD)	
Component audio input jack	2 (3.5mm)	Unit W/stand	41.3 x 28.9 x 11.4 inches
VGA input 15 pin D-Sub	1 (640x480)	Unit W/O stand	41.3 x 25.5 x 3.2 inches
VGA audio input jack	1 (3.5mm)	Weight	
DVI-D input	1 (not intended for PC use)	Unit W/Stand	81.4lbs
DVI audio input jack	1 (3.5mm)	Unit W/O Stand	70.4lbs
Headphone: mini stereo jack	1 (3.5mm)	G.W. Carton	99.0lbs
Composite Video output	1	Environment	
L/R Audio for Composite output	1 (RCA)	Operating Temperature	0 to 50
RS232	1 (Service only)	Operating Humidity	20 to 80% RH
Video Standards supported		Storage Temperature	-55 to 60 p
Composite Video input	NTSC	Storage Humidity	20 to 80% RH
Composite Video output	NTSC	Warranty	
S-Video Input	NTSC	Parts and Labor	1 Year
RF	NTSC	* - measured at peak	
		** - signal down-converted to native resolution	
		*** - Based on brightness at 50 percent, (Average time)	

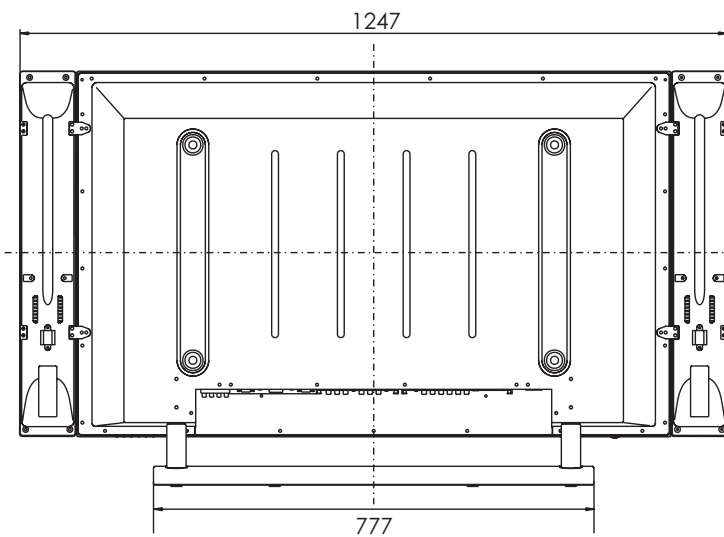
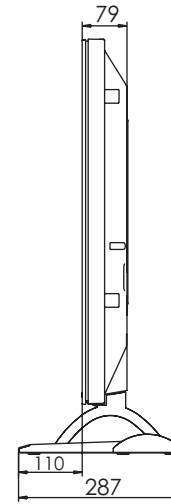
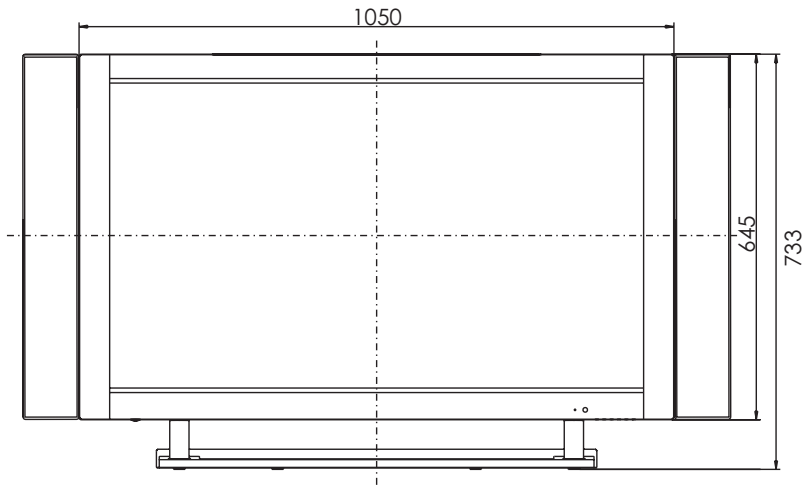

(Unit: mm)

⚠ Design and specifications are subject to change without notice.

Free Manuals Download Website

<http://myh66.com>

<http://usermanuals.us>

<http://www.somanuals.com>

<http://www.4manuals.cc>

<http://www.manual-lib.com>

<http://www.404manual.com>

<http://www.luxmanual.com>

<http://aubethermostatmanual.com>

Golf course search by state

<http://golfingnear.com>

Email search by domain

<http://emailbydomain.com>

Auto manuals search

<http://auto.somanuals.com>

TV manuals search

<http://tv.somanuals.com>