

NX800LX

AMD® Geode LX800 500MHz Nano ITX Main Board

User's Manual



Ver. 1.00

Contents

Safety Information	4
Technical Support	5
Conventions Used in This Guide	5
Packing List	6
Revision History	7
Specifications Summary.....	8
Block Diagram.....	10
Production Introduction	12
1.1 Before you Proceed	12
1.2 Motherboard Overview.....	13
1.2.1 Placement Direction	13
1.2.2 Screw Holes	13
1.3 Motherboard Layout.....	14
1.3.1 Layout Content List	15
1.4 Expansion Slots	17
1.4.1 Installing an Expansion Card	17
1.4.2 Configuring an Expansion Card	17
1.5 Jumpers	18
1.5.1 Clear CMOS (J3).....	18
1.5.2 LCD Backlight Brightness Adjustment Connector (LCDPJ1).....	19
1.5.3 COM1/COM2 RI/+5V Selection (COMAJ1, COMBJ1).....	19
1.5.4 COM1/COM2 +5V/+12V Selection (COMAPJ1, COMBPJ1).....	19
1.6 Connectors.....	20
1.6.1 Rear Panel Connectors	20
1.6.2 CF Power Connector (CFPJ1)	21
1.6.3 ATX Power Connector (CN5).....	21
1.6.4 Power Fan Connector (CN7).....	21
1.6.5 SM Bus Connector (CN8)	22
1.6.6 Serial port 1 in RS-232 mode (COMB1).....	22
1.6.7 Serial port 2 in RS-232 mode (COMB2).....	22
1.6.8 Front Panel Connector (FPANEL1).....	23
1.6.9 IrDA Connector (IRB1)	24
1.6.10 Primary IDE Connector (IDEB1)	24
1.6.11 AC97 Line-in Connector (J1)	25
1.6.12 GPIO Connector (J2)	25

Contents

1.6.13	LCD Inverter Connector (LCDB1).....	26
1.6.14	LVDS Connector (LVDS1).....	26
1.6.15	TTL Connector (TTL1).....	27
1.6.16	USB 2.0 Connector (USBB1).....	27

Safety Information

Electrical safety

- To prevent electrical shock hazard, disconnect the power cable from the electrical outlet before relocating the system.
- When adding or removing devices to or from the system, ensure that the power cables for the devices are unplugged before the signal cables are connected. If possible, disconnect all power cables from the existing system before you add a device.
- Before connecting or removing signal cables from the motherboard, ensure that all power cables are unplugged.
- Seek professional assistance before using an adapter or extension cord. These devices could interrupt the grounding circuit.
- Make sure that your power supply is set to the correct voltage in your area. If you are not sure about the voltage of the electrical outlet you are using, contact your local power company.
- If the power supply is broken, do not try to fix it by yourself. Contact a qualified service technician or your retailer.

Operation safety

- Before installing the motherboard and adding devices on it, carefully read all the manuals that came with the package.
- Before using the product, make sure all cables are correctly connected and the power cables are not damaged. If you detect any damage, contact your dealer immediately.
- To avoid short circuits, keep paper clips, screws, and staples away from connectors, slots, sockets and circuitry.
- Avoid dust, humidity, and temperature extremes. Do not place the product in any area where it may become wet.
- Place the product on a stable surface.
- If you encounter technical problems with the product, contact a qualified service technician or your retailer.



The symbol of the crossed out wheeled bin indicates that the product (electrical and electronic equipment) should not be placed in municipal waste. Check local regulations for disposal of electronic products.

Technical Support

If a problem arises with your system and no solution can be obtained from the user's manual, please contact your place of purchase or local distributor. Alternatively, please try the following help resources for further guidance. Visit the BCM TW website for FAQ, technical guide, BIOS updates, driver updates, and other information:

<http://www.bcmimb.com.tw>

Conventions Used in This Guide

To make sure that you perform certain tasks properly, take note of the following symbols used throughout this manual.



DANGER/WARNING: Information to prevent injury to yourself when trying to complete a task.



CAUTION: Information to prevent damage to the components when trying to complete a task.



IMPORTANT: Instructions that you **MUST** follow to complete a task.



NOTE: Tips and additional information to help you complete a task.

Packing List

Before you begin installing your single board, please make sure that the following materials have been shipped:

- ✓ 1 x AMD LX800 Nano ITX Main board
- ✓ 1 x CD-ROM contains the followings:
 - User's manual (this manual in PDF file)
 - Drivers
- ✓ 2 x Serial port cable
- ✓ 1 x 6 to 20 pin power cable
- ✓ 1 x Y cable
- ✓ 1 x IDE HDD cable
- ✓ 1 x Startup Manual



If any of the above items is damaged or missing, please contact your retailer.

Revision History

Revision	Revision History	Date
V 1.0	First release for PCB 1.00	September 04, 2007

Specifications Summary

Features	1	Onboard AMD Geode LX800 500 MHz @ 0.9 W with 128K L2 Cache & 64K L1 Cache CPU
	2	AMD Geode CS5536 Companion Chip
	3	One 200-pin SODIMM up to 1GB DDR 400 SDRAM
	4	24-bit TTL, 18-bit LVDS
	5	Realtek RTL8139DL 10/100Mbps LAN
	6	1 Mini PCI, Type I/II CF
	7	2 COM, 4 USB 2.0
System		
CPU	Onboard AMD Geode LX800 @ 0.9 W with 128K L2 Cache or 64K L1 Cache	
BIOS	Award 4 Mb Flash BIOS	
System Chipset	AMD Geode LX800/CS5536	
I/O Chipset	Winbond W83627HG-AW	
Memory	1 x 200-pin SODIMM socket supports up to 1 GB DDR 400 SDRAM	
SSD	1 x CompactFlash Type I/II socket	
Watchdog Timer	Reset: 1 sec.~255 min. and 1 sec. or 1 min./step	
H/W Status Monitor	Monitoring CPU temperature, voltage, and cooling fan status. Auto throttling control when CPU overheats	
Expansion Slots	1 x Mini PCI	
I/O		
MIO	1 x EIDE (DMA 33), 2 x RS-232, 1 x K/B, 1 x Mouse	
IrDA	115k bps, IrDA 1.0 compliant	
USB	4 x USB 2.0 ports	
DIO	8-bit General Purpose I/O for 4 DI and 4 DO	

Specifications Summary

I/O	
Internal I/O	1 x 6Pin ATX compatible power connector 1x LVDS 20Pin Panel Connector 1x TTL 40Pin Panel Connector 1x Front Panel Connector 1 x 44Pin IDE Connector 2 x COM Port Connector 1 x LCD Invert Power Connector 1 x 3Pin FAN Connector 1 x ext. USB Connector 1 x ext Line-in Connector
Back Panel	1 x PS/2 Keyboard+Mouse (through Y-Cable) 1 x VGA port 2 x USB 2.0/1.1 1 x RJ45 port 1 x Audio Jack for Mic-in 1 x Audio Jack for Line-out
Display	
Display Memory	AMD LX800 integrated graphics controller supports up to 32 MB video memory
Resolution	CRT mode: 1024 x 768 @ 32 bpp (85 Hz) TFT mode: 1600 x 1200 @ 32 bpp (100Hz)
VGA/LCD interface	AMD Geode LX800 supports 18-bit Single channel LVDS
Audio	
Chipset	AMD Geode CS5536
Audio Codec	Realtek ALC655 supports 2 CH AC97 Audio
Audio Interface	Mic in, Line in, Line out
Ethernet	
LAN1	Realtek RTL8139DL 10/100Mbps LAN
Mechanical & Environmental	
Power Type	ATX
Operating Temperature	0 ~ 60°C (32 ~ 140°F)
Operating Humidity	0% ~ 90% relative humidity, non-condensing
Size (L x W)	4.72" x 4.72" (120 mm x 120 mm)
Weight	0.88 lbs (0.4 Kg)

* Specifications are subject to change without notice.

Block Diagram

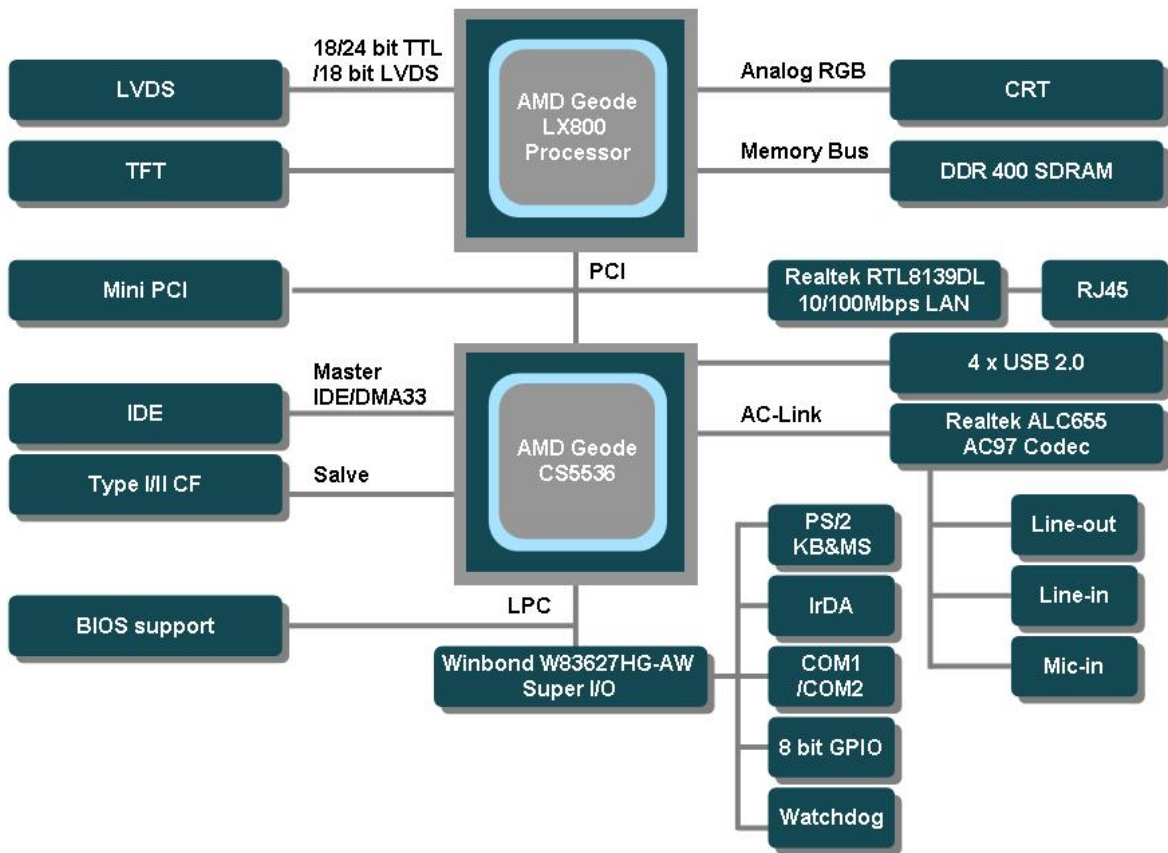

This chapter describes the motherboard features and the new technologies it supports.

1 Product introduction

Production Introduction

1.1 Before you Proceed

Take note of the following precautions before you install motherboard components or change any motherboard settings.



-
- Unplug the power cord from the wall socket before touching any component.
 - Use a grounded wrist strap or touch a safely grounded object or a metal object, such as the power supply case, before handling components to avoid damaging them due to static electricity
 - Hold components by the edges to avoid touching the ICs on them.
 - Whenever you uninstall any component, place it on a grounded antistatic pad or in the bag that came with the component.
 - Before you install or remove any component, ensure that the ATX power supply is switched off or the power cord is detached from the power supply. Failure to do so may cause severe damage to the motherboard, peripherals, and/or components.
-

1.2 Motherboard Overview

Before you install the motherboard, study the configuration of your chassis to ensure that the motherboard fits into it. Refer to the chassis documentation before installing the motherboard.



Make sure to unplug the power cord before installing or removing the motherboard. Failure to do so can cause you physical injury and damage motherboard components.

1.2.1 Placement Direction

When installing the motherboard, make sure that you place it into the chassis in the correct orientation. The edge with external ports goes to the rear part of the chassis as indicated in the image below.

1.2.2 Screw Holes

Place four (4) screws into the holes indicated by circles to secure the motherboard to the chassis.



Do not over tighten the screws! Doing so can damage the motherboard.

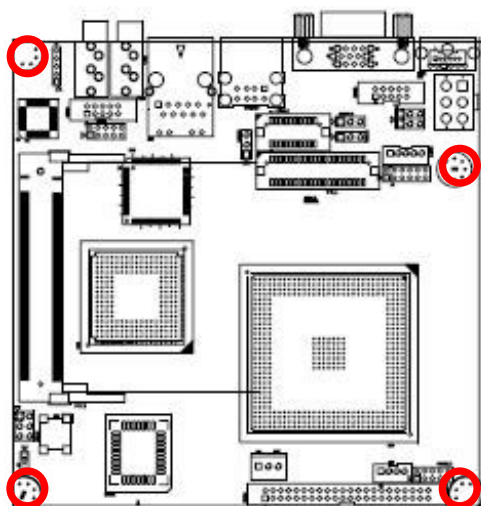

Place this side towards the rear of the chassis

1.3 Motherboard Layout

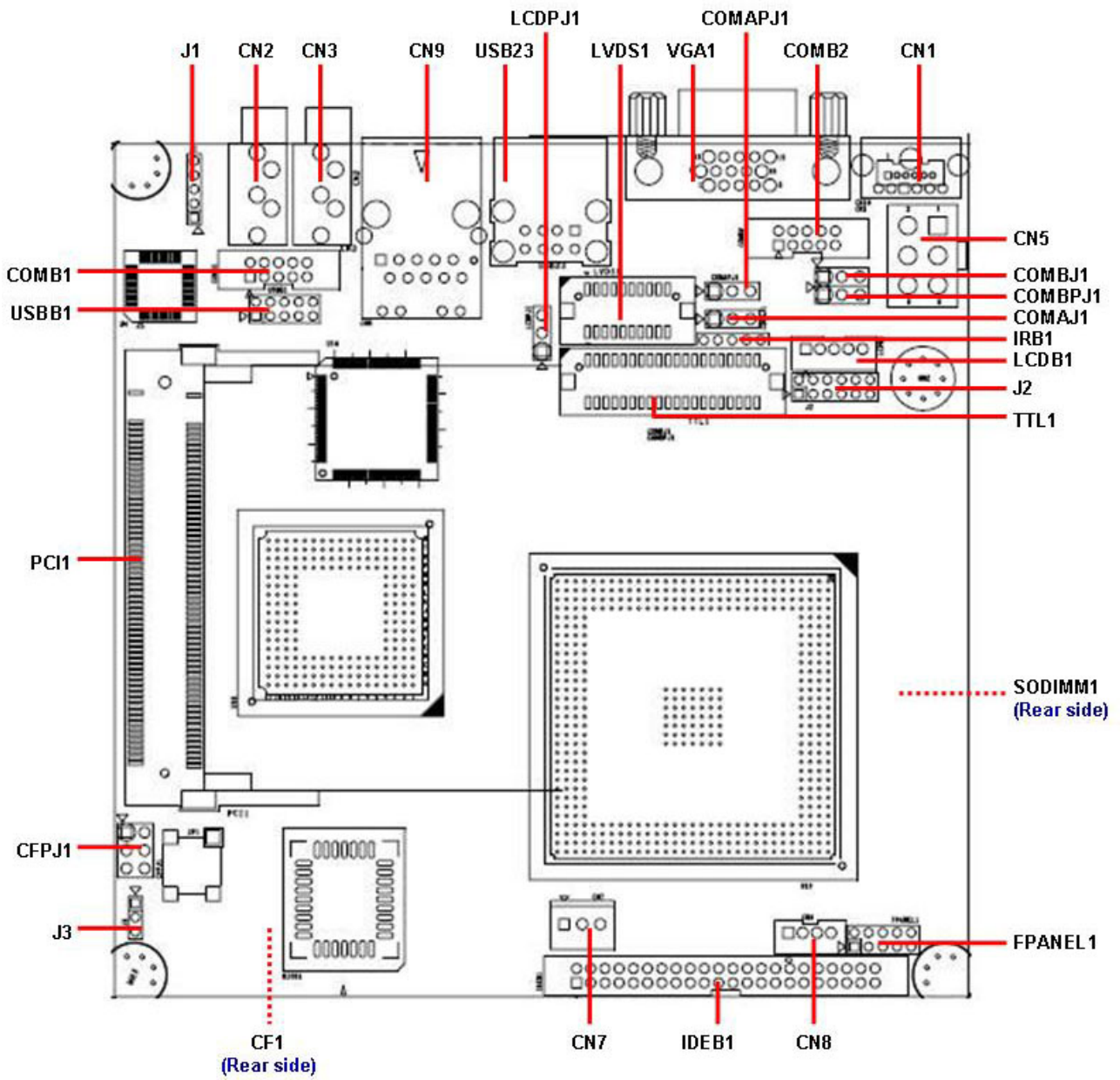

1.3.1 Layout Content List

Slots			
Label	Function	Note	Page
CF1	CompactFlash card connector	(Rear side)	N/A
SODIMM1	200-pin DDR SDRAM DIMM socket	(Rear side)	N/A
PCI1	Mini PCI slot		N/A

Jumpers			
Label	Function	Note	Page
J3	Clear CMOS	3 x 1 header, pitch 2.00mm	18
LCDPJ1	LCD Backlight Brightness Adjustment Connector	3 x 1 header, pitch 2.54mm	19
COMAJ1	COM 1 RI/+5V selection	3 x 1 header, pitch 2.54mm	19
COMAPJ1	COM 1 +5V/+12V selection	3 x 1 header, pitch 2.54mm	19
COMBJ1	COM 2 RI/+5V selection	3 x 1 header, pitch 2.54mm	19
COMBPJ1	COM 2 +5V/+12V selection	3 x 1 header, pitch 2.54mm	19

Rear Panel Connector			
Label	Function	Note	Page
CN1	PS/2 keyboard and mouse	6-pin Mini-Din	20
VGA1	VGA port	D-sub 15-pin, female	20
USB23	USB 2.0 connector x 2		20
CN9	RJ-45 Ethernet connector		20
CN2	Line-in / Line-out port	Phone jack	20
CN3	Microphone port	Phone jack	20

Internal Connector			
Label	Function	Note	Page
CFPJ1	CF power connector	3 x 2 header, pitch 2.54mm	21
CN5	ATX power connector	3 x 2 header	21
CN7	Power fan connector	3 x 1 wafer, pitch 2.54mm	21
CN8	SM Bus connector	4 x 1 wafer, pitch 2.00mm	22
COMB1	Serial port 1 in RS-232 mode	5 x 2 header, pitch 2.00mm	22
COMB2	Serial port 2 in RS-232 mode	5 x 2 header, pitch 2.00mm	22
FPANEL1	Front panel connector	5 x 2 header, pitch 2.00mm	23
IRB1	IrDA connector	5 x 1 header, pitch 2.00mm,	24
IDEB1	Primary IDE connector	22 x 2 header, pitch 2.00mm	24
J1	AC97 line in connector	5 x 1 header, pitch 2.00mm	25
J2	GPIO connector	6 x 2 header, pitch 2.00mm	25
LCDB1	LCD inverter connector	5 x 1 header, pitch 2.00mm	26
LVDS1	LVDS connector	HIROSE DF13-20DP-1.25V	26
TTL1	TTL connector	HIROSE DF13-40DP-1.25V	27
USBB1	USB 2.0 connector	5 x 2 header, pitch 2.00mm	27

1.4 Expansion Slots

In the future, you may need to install expansion cards. The following sub-sections describe the slots and the expansion cards that they support.



Make sure to unplug the power cord before adding or removing expansion cards. Failure to do so may cause you physical injury and damage motherboard components.

1.4.1 Installing an Expansion Card

1. Before installing the expansion card, read the documentation that came with it and make the necessary hardware settings for the card.
2. Remove the system unit cover (if your motherboard is already installed in a chassis).
3. Remove the bracket opposite the slot that you intend to use. Keep the screw for later use.
4. Align the card connector with the slot and press firmly until the card is completely seated on the slot.
5. Secure the card to the chassis with the screw you removed earlier.
6. Replace the system cover.

1.4.2 Configuring an Expansion Card

After installing the expansion card, configure it by adjusting the software settings.

1. Turn on the system and change the necessary BIOS settings.
2. Assign an IRQ to the card if needed.
3. Install the software drivers for the expansion card.

1.5 Jumpers

1.5.1 Clear CMOS (J3)

This jumper allows you to clear the Real Time Clock (RTC) RAM in CMOS. You can clear the CMOS memory of date, time, and system setup parameters by erasing the CMOS RTC RAM data. The onboard button cell battery powers the RAM data in CMOS, which include system setup information such as system passwords. To erase the RTC RAM:

1. Turn OFF the computer and unplug the power cord.
2. Remove the onboard battery.
3. Move the jumper cap from pins 1-2 (default) to pins 2-3. Keep the cap on pins 2-3 for about 5~10 seconds, then move the cap back to pins 1-2.
4. Re-install the battery.
5. Plug the power cord and turn ON the computer.
6. Hold down the key during the boot process and enter BIOS setup to re-enter data.



Except when clearing the CMOS, never remove the cap on J3 jumper default position. Removing the cap will cause system boot failure!

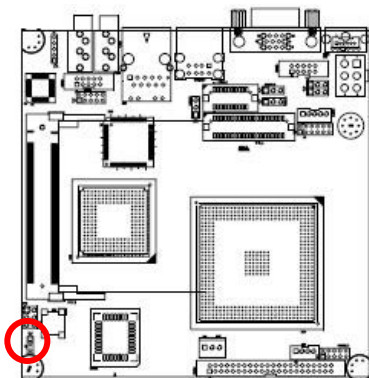

Normal (Default)



Clear RTC



1.5.2 LCD Backlight Brightness Adjustment Connector (LCDPJ1)

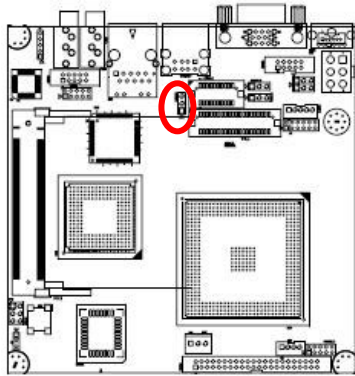

+5V (Default)



+3.3V



1.5.3 COM1/COM2 RI/+5V Selection (COMAJ1, COMBJ1)

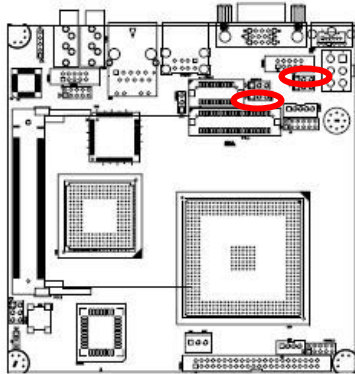

Ring (Default)



+5V



1.5.4 COM1/COM2 +5V/+12V Selection (COMAPJ1, COMBPJ1)

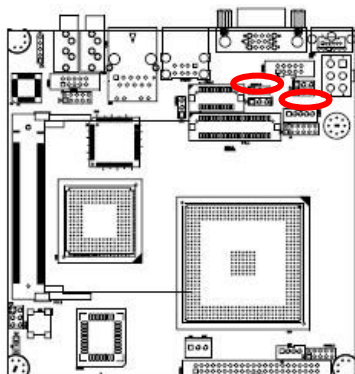

+5V (Default)



+12V



1.6 Connectors

1.6.1 Rear Panel Connectors

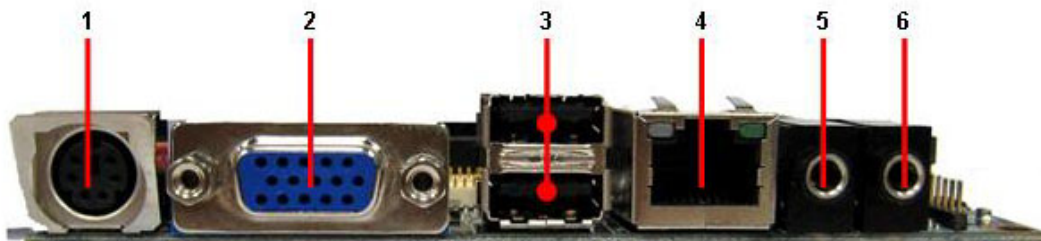

No	Label	Function	Description																
1	CN1	PS/2 keyboard and mouse connector	The standard PS/2 DIN connector is for a PS/2 keyboard and mouse																
2	VGA1	VGA port	This 15-pin port is for a VGA monitor or other VGA-compatible devices.																
3	USB23	USB 2.0 connector x 2	These two 4-pin Universal Serial Bus (USB) ports are available for connecting USB 2.0 devices.																
4	CN9	LAN (RJ-45) connector	This port allows Gigabit connection to a Local Area Network (LAN) through a network hub. Refer to the table below for the LAN port LED indications. The optional 10/100 Mbps LAN controller allows 10/100 Mbps connection to a Local Area Network (LAN) through a network hub.																
<p>ACT/LINK LED SPEED LED</p> <p>LAN port</p>																			
<table border="1"> <thead> <tr> <th colspan="2">ACT / LINK LED</th> <th colspan="2">SPEED LED</th> </tr> <tr> <th>Status</th> <th>Description</th> <th>Status</th> <th>Description</th> </tr> </thead> <tbody> <tr> <td>OFF / Y</td> <td>Linked</td> <td>OFF</td> <td>10Mbps connection</td> </tr> <tr> <td>B. Y</td> <td>Activity</td> <td>Green/Orange</td> <td>100Mbps connection</td> </tr> </tbody> </table>				ACT / LINK LED		SPEED LED		Status	Description	Status	Description	OFF / Y	Linked	OFF	10Mbps connection	B. Y	Activity	Green/Orange	100Mbps connection
ACT / LINK LED		SPEED LED																	
Status	Description	Status	Description																
OFF / Y	Linked	OFF	10Mbps connection																
B. Y	Activity	Green/Orange	100Mbps connection																
5	CN3	Microphone port (Black)	This port connects a microphone.																
6	CN2	Line in / Line out port (Black)	This port connects a headphone or a speaker.																

1.6.2 CF Power Connector (CFPJ1)

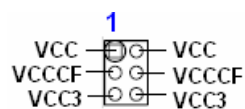
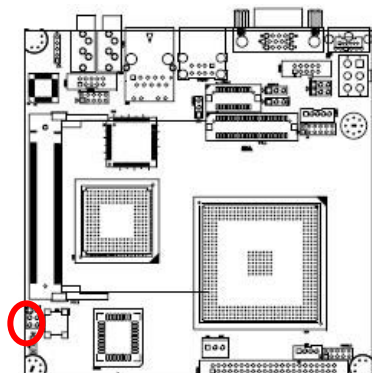

1.6.3 ATX Power Connector (CN5)

This connector is for ATX power supply plugs. The power supply plugs are designed to fit this connector in only one orientation. Find the proper orientation and push down firmly until the connector completely fit.

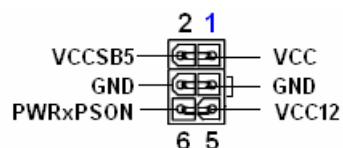
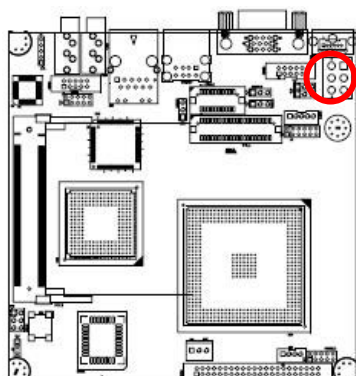

1.6.4 Power Fan Connector (CN7)

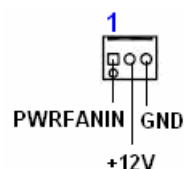
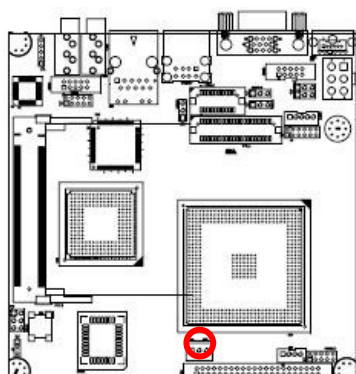

1.6.5 SM Bus Connector (CN8)

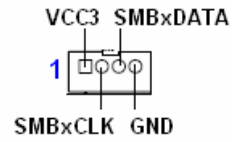
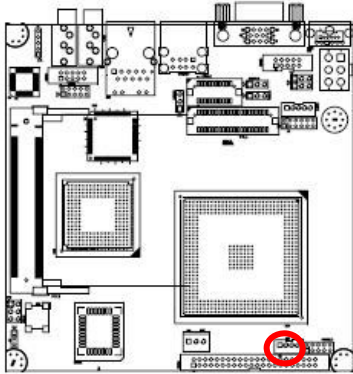

1.6.6 Serial port 1 in RS-232 mode (COMB1)

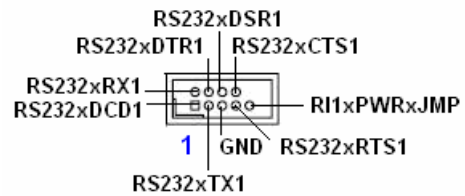
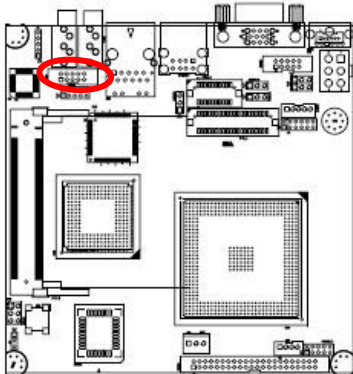

1.6.7 Serial port 2 in RS-232 mode (COMB2)

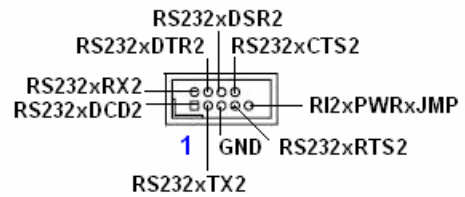
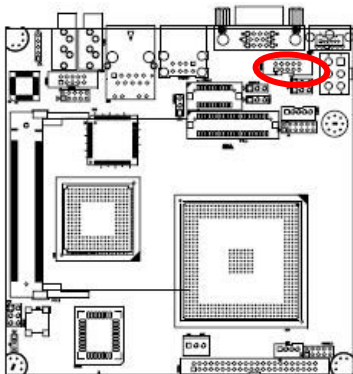

1.6.8 Front Panel Connector (FPANEL1)

This connector supports several chassis-mounted functions.

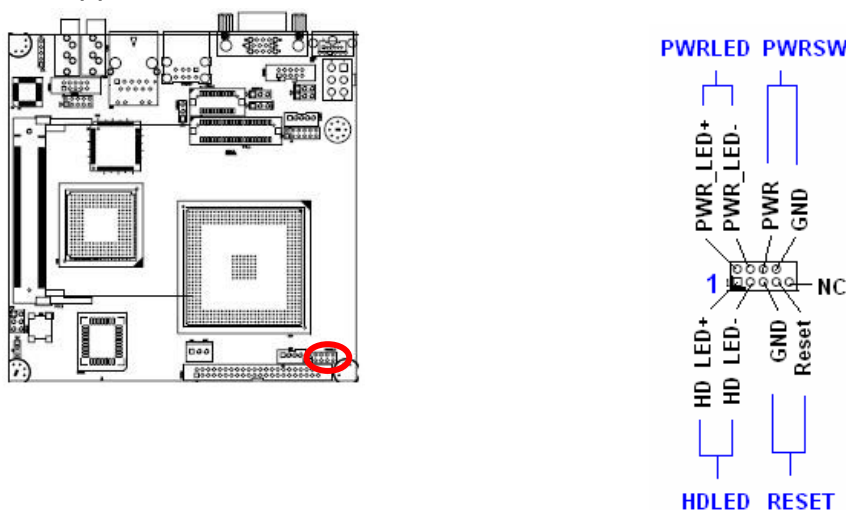

- **System Power LED (2-pin PWRLED)**

This 2-pin connector is for the system power LED. Connect the chassis power LED cable to this connector. The system power LED lights up when you turn on the system power, and blinks when the system is in sleep mode.

- **ATX Power Button/Soft-off Button (2-pin PWRSW)**

This connector is for the system power button. Pressing the power button turns the system on or puts the system in sleep or soft-off mode depending on the BIOS settings. Pressing the power switch for more than four seconds while the system is ON turns the system OFF.

- **Hard Disk Drive Activity LED (2-pin HDLED)**

This 2-pin connector is for the HDD Activity LED. Connect the HDD Activity LED cable to this connector. The IDE LED lights up or flashes when data is read from or written to the HDD.

- **Reset Button (2-pin RESET)**

This 2-pin connector is for the chassis-mounted reset button for system reboot without turning off the system power.

1.6.9 IrDA Connector (IRB1)

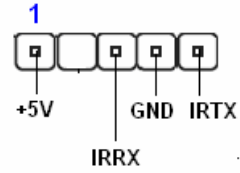
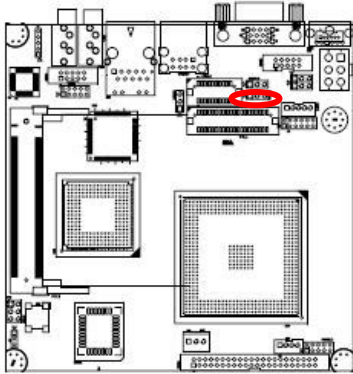

- **Signal Description**

Signal	Signal Description
IRRX	Infrared Receiver Input
IRTX	Infrared Transmitter Output

1.6.10 Primary IDE Connector (IDEB1)

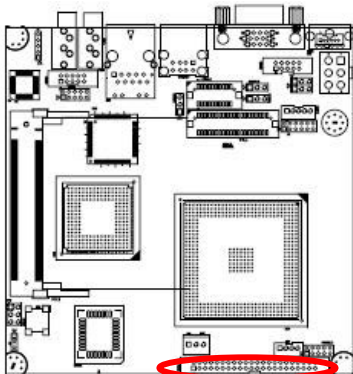

- Orient the red markings (usually zigzag) on the IDE cable to Pin 1.

1.6.11 AC97 Line-in Connector (J1)

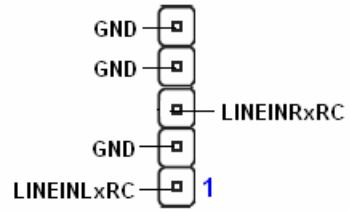
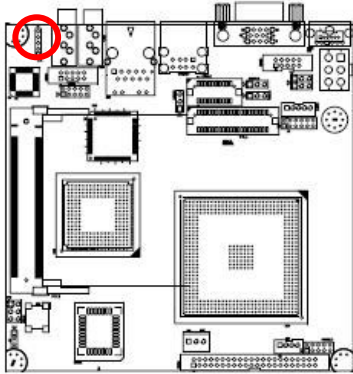

1.6.12 GPIO Connector (J2)

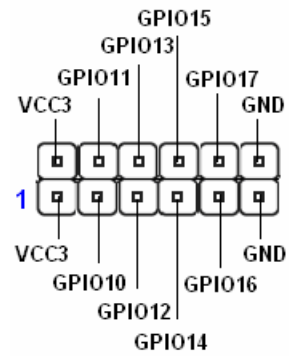
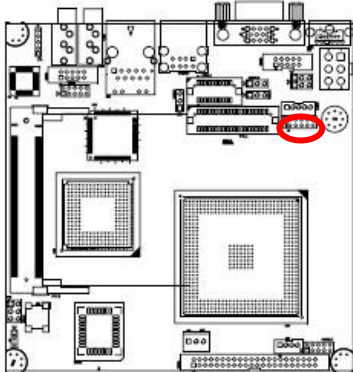

1.6.13 LCD Inverter Connector (LCDB1)

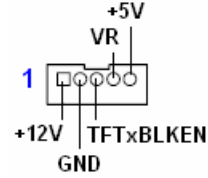
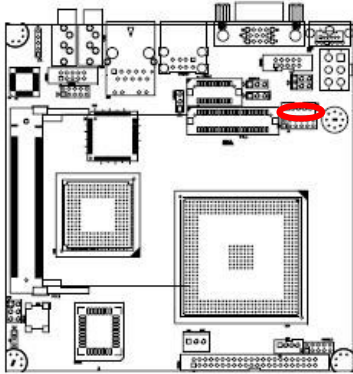

For inverters with adjustable Backlight function, it is possible to control the LCD brightness through the VR signal controlled by **LCDPJ1**. Please see the **LCDPJ1** section for detailed circuitry information.



- **Signal Description**

Signal	Signal Description
VR	Vadj=0.75V ~ 4.25V (Recommended: 4.7KΩ, > 1/16W)
TFTxBLKEN	LCD backlight ON/OFF control signal

1.6.14 LVDS Connector (LVDS1)

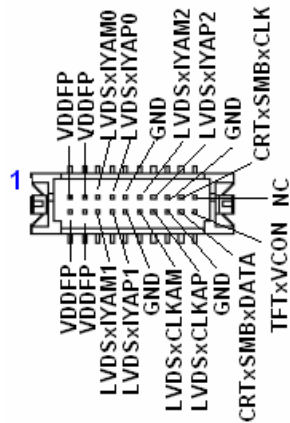
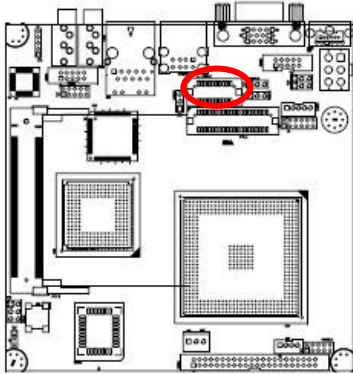

1.6.15 TTL Connector (TTL1)

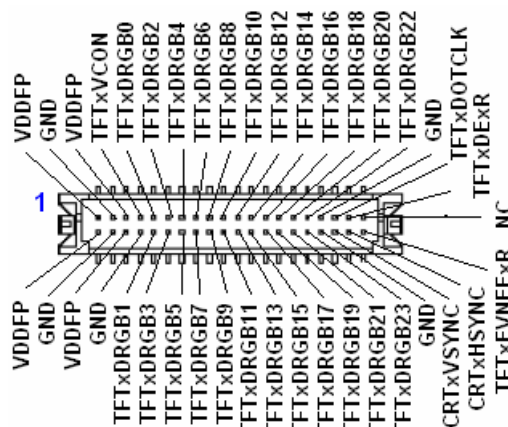
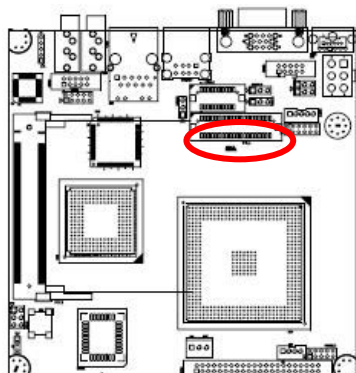

1.6.16 USB 2.0 Connector (USBB1)

These connectors are for USB 2.0 ports. Connect the USB/GAME module cable to any of these connectors, then install the module to a slot opening at the back of the system chassis. These USB connectors comply with USB 2.0 specification that supports up to 480 Mbps connection speed.

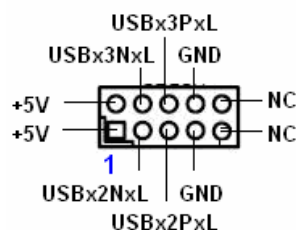
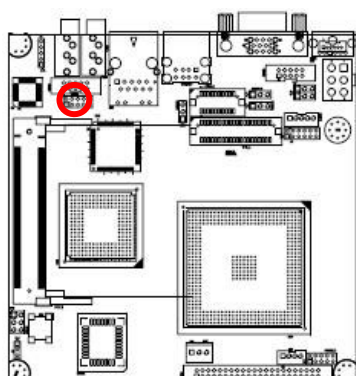

Never connect a **1394 cable** to the USB connectors. Doing so will damage the motherboard!



The USB module is purchased separately.

Free Manuals Download Website

<http://myh66.com>

<http://usermanuals.us>

<http://www.somanuals.com>

<http://www.4manuals.cc>

<http://www.manual-lib.com>

<http://www.404manual.com>

<http://www.luxmanual.com>

<http://aubethermostatmanual.com>

Golf course search by state

<http://golfingnear.com>

Email search by domain

<http://emailbydomain.com>

Auto manuals search

<http://auto.somanuals.com>

TV manuals search

<http://tv.somanuals.com>