

adaptec[®]

SAS and SATA HostRAID Controller Installation and User's Guide

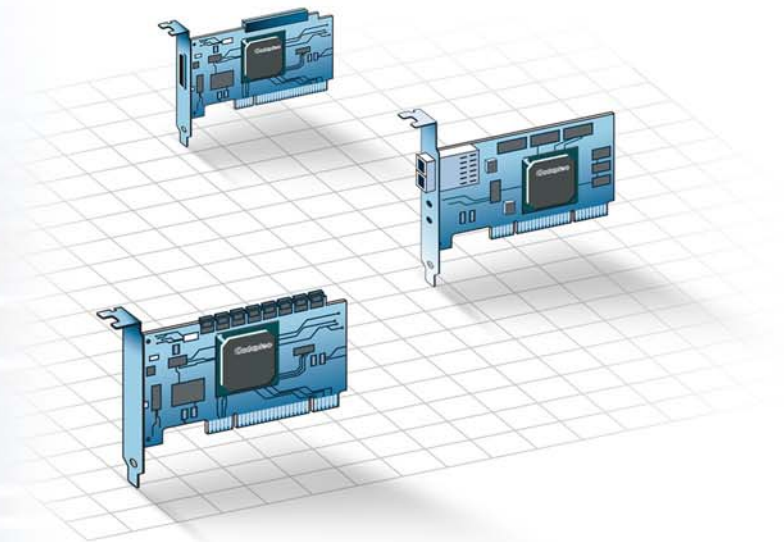

Copyright

©2007 Adaptec, Inc. All rights reserved. No part of this publication may be reproduced, stored in a retrieval system, or transmitted in any form or by any means, electronic, mechanical, photocopying, recording or otherwise, without the prior written consent of Adaptec, Inc., 691 South Milpitas Blvd., Milpitas, CA 95035.

Trademarks

Adaptec, Adaptec Storage Manager, SCSISelect, SATASelect, SerialSelect and the Adaptec logo are trademarks of Adaptec, Inc., which may be registered in some jurisdictions.

Microsoft and Windows are trademarks of Microsoft Corporation in the US and other countries, used under license.

Red Hat is a trademark of Red Hat, Inc. in the US and other countries, used under license.

Novell and NetWare are trademarks of Novell, Inc. in the US and other countries, used under license.

All other trademarks are the property of their respective owners.

Changes

The material in this document is for information only and is subject to change without notice. While reasonable efforts have been made in the preparation of this document to assure its accuracy, Adaptec, Inc. assumes no liability resulting from errors or omissions in this document, or from the use of the information contained herein.

Adaptec reserves the right to make changes in the product design without reservation and without notification to its users.

Disclaimer

IF THIS PRODUCT DIRECTS YOU TO COPY MATERIALS, YOU MUST HAVE PERMISSION FROM THE COPYRIGHT OWNER OF THE MATERIALS TO AVOID VIOLATING THE LAW WHICH COULD RESULT IN DAMAGES OR OTHER REMEDIES.

Adaptec Customer Support

If you have questions about installing or using your Adaptec product, check this document first—you will find answers to most of your questions. If you need further assistance, use the support options listed below. To expedite your service, have your computer in front of you.

Technical Support Identification (TSID) Number

- Before contacting Technical Support, you need your unique 12-digit TSID number. The TSID number identifies your product and support status.
- The TSID number is included on a white, bar-coded label, like this example:

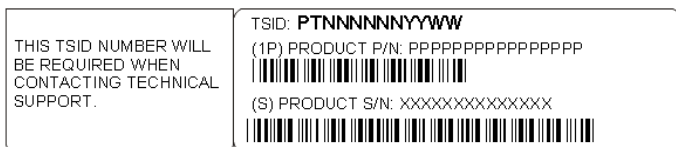

- Affix a copy of the TSID label to the CD jacket so that you don't lose it.

North America

- Visit our Web site at www.adaptec.com.
- Search the Adaptec Support Knowledgebase (ASK) at ask.adaptec.com for articles, troubleshooting tips, and frequently asked questions for your product.
- For information about Adaptec's support options, call +1 408-957-2550, 24 hours per day, 7 days per week. To speak with a Technical Support Specialist, call +1 408-934-7274 or +1 321-207-2000.
- For support via e-mail, submit your question at ask.adaptec.com.
- You can order Adaptec products, including accessories and cables, by calling +1 408-957-7274. Or, you can order cables online at www.adaptec.com.

Europe

- Visit our Web site at www.adaptec.com.
- **German:** Call +49 89 43 66 55 22, Monday to Friday, 9:00 to 17:00, CET. For support via e-mail, submit your question at ask-de.adaptec.com.
- **French:** Call +49 89 43 66 55 33, Monday to Friday, 9:00 to 17:00, CET. For support via e-mail, submit your question at ask-fr.adaptec.com.
- **English:** Call +49 89 43 66 55 44, Monday to Friday, 9:00 to 17:00, GMT. For support via e-mail, submit your question at ask.adaptec.com.
- You can order Adaptec cables online at www.adaptec.com.

Japan

- Visit our Web site at www.adaptec.co.jp.
- Call 0044 2213 2601.

Limited 3-Year Hardware Warranty

1. Adaptec, Inc. ("Adaptec") warrants to the purchaser of this product that it will be free from defects in material and workmanship for a period of three (3) years from the date of purchase. If the product should become defective within the warranty period, Adaptec, at its option, will repair or replace the product, or refund the purchaser's purchase price for the product, provided it is delivered at the purchaser's expense to an authorized Adaptec service facility or to Adaptec.
2. Repair or replacement parts or products will be furnished on an exchange basis and will either be new or reconditioned. All replaced parts or products shall become the property of Adaptec. This warranty shall not apply if the product has been damaged by accident, misuse, abuse or as a result of unauthorized service or parts.
3. Warranty service is available to the purchaser by delivering the product during the warranty period to an authorized Adaptec service facility or to Adaptec and providing proof of purchase price and date. The purchaser shall bear all shipping, packing and insurance costs and all other costs, excluding labor and parts, necessary to effectuate repair, replacement or refund under this warranty.
4. For more information on how to obtain warranty service, write or telephone Adaptec at 691 South Milpitas Boulevard, Milpitas, CA 95035, (800) 959-7274.
5. THIS LIMITED WARRANTY DOES NOT EXTEND TO ANY PRODUCT WHICH HAS BEEN DAMAGED AS A RESULT OF ACCIDENT, MISUSE, ABUSE, OR AS A RESULT OF UNAUTHORIZED SERVICE OR PARTS.
6. THIS WARRANTY IS IN LIEU OF ALL OTHER EXPRESS WARRANTIES WHICH NOW OR HEREAFTER MIGHT OTHERWISE ARISE RESPECT TO THIS PRODUCT. IMPLIED WARRANTIES, INCLUDING THOSE OF MERCHANTABILITY, FITNESS FOR A PARTICULAR PURPOSE AND NON-INFRINGEMENT SHALL (A) HAVE NO GREATER DURATION THAN 3 YEARS FROM THE DATE OF PURCHASE, (B) TERMINATE AUTOMATICALLY AT THE EXPIRATION OF SUCH PERIOD AND (C) TO THE EXTENT PERMITTED BY LAW BE EXCLUDED. IN THE EVENT THIS PRODUCT BECOMES DEFECTIVE DURING THE WARRANTY PERIOD, THE PURCHASER'S EXCLUSIVE REMEDY SHALL BE REPAIR, REPLACEMENT OR REFUND AS PROVIDED ABOVE. INCIDENTAL OR CONSEQUENTIAL DAMAGES, INCLUDING WITHOUT LIMITATION LOSS OF DATA, ARISING FROM BREACH OF ANY EXPRESS OR IMPLIED WARRANTY ARE NOT THE RESPONSIBILITY OF ADAPTEC AND, TO THE EXTENT PERMITTED BY LAW, ARE HEREBY EXCLUDED BOTH FOR PROPERTY DAMAGE, AND TO THE EXTENT NOT UNCONSCIONABLE, FOR PERSONAL INJURY DAMAGE.
7. SOME STATES DO NOT ALLOW THE EXCLUSION OR LIMITATION OF INCIDENTAL OR CONSEQUENTIAL DAMAGES FOR CONSUMER PRODUCTS, AND SOME STATES DO NOT ALLOW LIMITATIONS ON HOW LONG AN IMPLIED WARRANTY LASTS, SO THE ABOVE LIMITATION OR EXCLUSIONS MAY NOT APPLY TO YOU.
8. This warranty gives you specific legal rights, and you may also have other rights which vary from state to state.

Regulatory Compliance Statements

Federal Communications Commission Radio Frequency Interference Statement

WARNING: Changes or modifications to this unit not expressly approved by the party responsible for compliance could void the user's authority to operate the equipment.

This equipment has been tested and found to comply with the limits for a Class B digital device, pursuant to Part 15 of the FCC rules. These limits are designed to provide reasonable protection against harmful interference in a residential installation. This equipment generates, uses, and can radiate radio frequency energy, and if not installed and used in accordance with the instruction manual, may cause harmful interference to radio communications. However, there is no guarantee that interference will not occur in a particular installation. However, if this equipment does cause interference to radio or television equipment reception, which can be determined by turning the equipment off and on, the user is encouraged to try to correct the interference by one or more of the following measures:

- Reorient or relocate the receiving antenna.
- Increase the separation between equipment and receiver.
- Connect the equipment to an outlet on a circuit different from that to which the receiver is connected.
- Consult the dealer or an experienced radio/television technician for help.
- Use a shielded and properly grounded I/O cable and power cable to ensure compliance of this unit to the specified limits of the rules.

This device complies with part 15 of the FCC rules. Operation is subject to the following two conditions: (1) this device may not cause harmful interference and (2) this device must accept any interference received, including interference that may cause undesired operation.

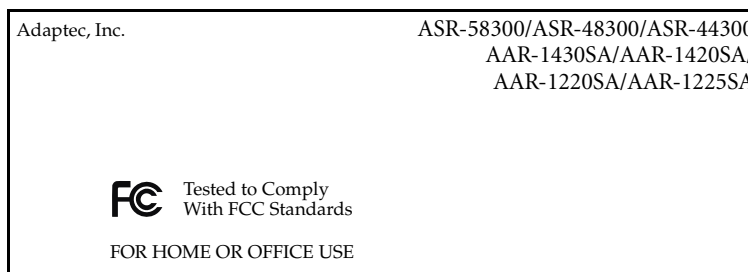

CE European Union Compliance Statement

This Information Technology Equipment has been tested and found to comply with EMC Directive 89/336/EEC, as amended by 92/31/EEC and 93/68/EEC, in accordance with:

- EN55022 (1998+A1:2000+A2:2003) Emissions
- EN55024 (1998+A1:2001+A2:2003) Immunity:
 - EN61000-4-2 (1995) Electrostatic discharge: ±4 kV contact, ±8 kV air
 - EN61000-4-3 (1996) Radiated immunity
 - EN61000-4-4 (1995) Electrical fast transients/burst: ±1 kV AC, ±0.5 kV I/O
 - EN61000-4-5 (1995) Surges ±1 kV differential mode, ±2 kV common mode
 - EN61000-4-6 (1996) Conducted immunity: 3 V
 - EN61000-4-11 (1994) Supply dips and variation: 30% and 100%

In addition, all equipment requiring U.L. listing has been found to comply with EMC Directive 73/23/EEC as amended by 93/68/EEC in accordance with EN60950 with amendments A1, A2, A3, A4, A11.

Australian/New Zealand Compliance Statement

This device has been tested and found to comply with the limits for a Class B digital device, pursuant to the Australian/New Zealand standard AS/NZS 3548 set out by the Spectrum Management Agency.

Canadian Compliance Statement

This Class B digital apparatus meets all requirements of the Canadian Interference-Causing Equipment Regulations.
Cet appareil numérique de la classe B respecte toutes les exigences du Règlement sur le matériel brouilleur du Canada.

VCCI Japanese Compliance (Voluntary Control Council Initiative)

This equipment complies to class B Information Technology equipment based on VCCI (Voluntary Control Council for Interface). This equipment is designed for home use but it may causes radio frequency interference problem if used too near to a television or radio. Please handle it correctly per this documentation.

Contents

1 About This Guide

What You Need to Know Before You Begin	12
Terminology Used in this Guide	12
Conventions Used in This Guide	12
How to Find More Information.....	12

2 About Your HostRAID Controller

HostRAID Controller Features	15
Array Level Features	15
About the Adaptec 58300 Controller	17
About the Adaptec 48300 Controller	18
About the Adaptec 44300 Controller	19
About the Adaptec 1430SA Controller	20
About the Adaptec 1420SA Controller	21
About the Adaptec 1220SA Controller	22
About the Adaptec 1225SA Controller	23

3 Kit Contents and System Requirements

Kit Contents	25
System Requirements.....	25

4 Installing the HostRAID Controller and Disk Drives

Before You Begin.....	27
Installing the HostRAID Controller.....	27
Selecting Disk Drives	28
Selecting SAS Cables	28

Selecting SATA Cables	30
Connecting Disk Drives to SAS HostRAID Controllers	30
Connecting Directly to the HostRAID Controller	31
Connecting to a Backplane	31
Installing the SAS HostRAID Controller to a SAS Expander	32
Connecting Disk Drives to SATA HostRAID Controllers.....	32
Checking Your Controller and Devices	33
Setting the Boot Controller	33
Next Steps.....	34
5 Getting Started	
Choosing a RAID Level.....	36
Choosing Installation Options	36
Basic Installation Steps.....	36
Installing with an Operating System	36
Installing with an Operating System On a Bootable Disk Drive/Array.	36
Installing on an Existing Operating System.....	37
6 Creating a Bootable Array	
Creating an Array.....	39
Creating an Array with the ACU	39
Creating an Array with Adaptec Storage Manager	39
Making Your Array Bootable	41
7 Installing the Driver and an Operating System	
Before You Begin.....	43
Creating a Driver Disk	43
Installing with Windows.....	43
Installing with Red Hat Linux	44
Installing with SUSE Linux.....	44
Installing with NetWare.....	45
8 Installing the Driver on an Existing Operating System	
Before You Begin.....	47
Creating a Driver Disk or an Array	47
Installing on Windows XP or Windows 2003	47
Installing on Windows Vista	48
Installing on Red Hat or SUSE Linux	48
Installing on NetWare.....	48

9 Managing Your Storage Space

About Adaptec Storage Manager	51
Installing Adaptec Storage Manager.....	51
About the HRCNF Command Line Utility	51
About the ARC Utility	52
About the Adaptec Flash Utility	52
Which Utility Should I Use?	52

10 Solving Problems

Troubleshooting Checklist	54
Recovering from a Disk Drive Failure	54
Failed Disk Drive Protected by a Hot Spare	54
Failed Disk Drive <i>Not</i> Protected by a Hot Spare	54
Failure in Multiple Arrays Simultaneously	55
Disk Drive Failure in a RAID 0 Array	55
Multiple Failures in the Same Array.....	55
Resetting the Controller.....	55

A Introduction to SAS

Terminology Used in This Appendix.....	58
What is SAS?	58
How Do SAS Devices Communicate?.....	59
What's a Phy?	59
What's a SAS Port?	59
What's a SAS Address?	60
What's a SAS Connector?	60
What do SAS Cables Look Like?.....	60
How are Disk Drives Identified in SAS?	60
What are the SAS Connection Options?.....	61
Direct-Attach Connections.....	61
Backplane Connections.....	61
SAS Expander Connections	61
How is SAS Different from Parallel SCSI?	62

B Understanding RAID

RAID Technology Overview.....	65
Understanding Drive Segments.....	65
Stripe-Unit Size	65
RAID 0 (Non-RAID Arrays)	65
RAID 1 Arrays	66

RAID 10 Arrays	66
Selecting the Best RAID Level	67
C Using the ARC Utility	
Introduction to the ARC Utility	69
Running the ARC Utility	69
Creating and Managing Arrays	69
Creating a New Array	69
Managing Arrays	71
Adding/Deleting Hot Spares	72
Managing Bootable Arrays and Devices	73
Configuring Disk Drives	73
ATAPI Support	73
Using SerialSelect	73
SerialSelect Options	74
Using SATASelect	75
SATASelect Options	76
Formatting and Verifying Disk Drives	76
Locating Disk Drives	77
Identifying Disk Drives	77
Viewing the Event Log	78
D Using the Adaptec Flash Utility for DOS	
Introduction	80
System Requirements	80
Compatibility Information	80
Before You Begin	80
Obtaining the Firmware	80
Creating the Firmware Kit On Floppy Disks	81
Running the AFU	81
Running the Menu-Based AFU	81
Running the AFU from the Command Line	82
AFU Commands	82
HELP	82
LIST	83
SAVE	83
UPDATE	84
VERIFY	84
VERSION	85
Updating Flash Using AFU Command Line	85

E HostRAID Controller LED and I2C Connector Reference

Adaptec 58300 Activity LED Connector Specification	88
Adaptec 48300 Activity LED Connector Specification	88
Adaptec 44300 Activity LED Connector Specification	89
Adaptec 1430SA Activity LED and I2C Connector Specification	89
Adaptec 1420SA Activity LED and I2C Connector Specification	90
Adaptec 1220SA Activity LED Connector Specification.....	91
Adaptec 1225SA Activity LED Specification	91

F Safety Information

Electrostatic Discharge(ESD)	92
------------------------------------	----

G Technical Specifications

Environmental Specifications.....	94
DC Power Requirements	94
Current Requirements	94

Glossary**Index**

About This Guide

1

In this chapter...

What You Need to Know Before You Begin	12
Terminology Used in this Guide.....	12
Conventions Used in This Guide.....	12
How to Find More Information	12

This *Installation and User's Guide* explains how to install your Adaptec® HostRAID controller. It also describes the utilities included in your controller kit , and provides a basic overview of Serial Attached SCSI (SAS) technology.

What You Need to Know Before You Begin

You should be familiar with computer hardware, data storage, Redundant Array of Independent Disks (RAID) technology, and the characteristics of input/output (I/O) technology used by your HostRAID controller. Because SAS is a newer I/O technology, an introduction is provided in the [Appendix A](#).

Note: Because this guide covers multiple Adaptec HostRAID controllers, some of the features and functions described may not be available for your controller.

Terminology Used in this Guide

Because you can use your HostRAID controller to manage data storage in a variety of configurations from DAS to NAS to SAN, the generic term “storage space is used to refer to controllers and disk drives being managed with Adaptec Storage Manager™ or the other utilities described in this *Guide*.

Many of the terms and concepts referred to in this *Guide* have multiple names. To maintain consistency, they are represented as:

- Controller (also known as host bus adapter, board)
- Disk drive (also known as hard disk, hard drive, or hard disk drive)
- Array (also known as logical drive)

Note: In DAS environments, *Adaptec Storage Manager User's Guide* refers to arrays as logical drives. Your RAID controller creates arrays, which your operating system and Adaptec Storage Manager recognizes as logical drives. In NAS environments, Adaptec Storage Manager displays both arrays and logical drives. For more information, refer to the *Adaptec Storage Manager User's Guide* for Direct Attached Storage on the Adaptec Storage Manager Installation CD.

Conventions Used in This Guide

In this documentation, the term SAS-only means that the requirement, feature, or procedure is applicable only to SAS HostRAID controllers.

The term SATA-only means that the requirement, feature, or procedure is applicable only to SATA HostRAID controllers.

How to Find More Information

You can find more information about your HostRAID controller, and the software and utilities included with it in these documents:

- *Readme.txt*—Describes details about updated product information and known issues; located on the HostRAID Installation CD.
- *Adaptec Storage Manager User's Guide*—Describes how to install and use the Adaptec Storage Manager software located on the Adaptec Storage Manager Installation CD. See [Managing Your Storage Space on page 50](#) for more information.
- *Adaptec Storage Manager online Help*—Describes how to use the Adaptec Storage Manager software.
- *Command Line Utility for Direct Attached Storage User's Guide*—Describes how to use the Adaptec HostRAID Controller Configuration (HRCNF) command line utility to

perform basic array and configuration management functions; located on the Adaptec Storage Manager Installation CD.

About Your HostRAID Controller

2

In this chapter...

HostRAID Controller Features	15
About the Adaptec 58300 Controller	17
About the Adaptec 48300 Controller	18
About the Adaptec 44300 Controller	19
About the Adaptec 1430SA Controller.....	20
About the Adaptec 1420SA Controller.....	21
About the Adaptec 1220SA Controller.....	22
About the Adaptec 1225SA Controller.....	23

This chapter provides an overview of standard HostRAID controller features, and describes the unique features of Adaptec SAS and SATA HostRAID controllers.

HostRAID Controller Features

- Port multiplier support— You can connect one SATA drive enclosure with a port multiplier to 1225SA HostRAID controller.

Note: To find out the version of the port multiplier, refer to the drive enclosure documentation.

Adaptec supports SiI3726 with one 3 Gbps SATA II host interface and five SATA device ports. We support only 3Gbps NCQ enabled drives.

Note: NetWare does not support drive enclosures with port multipliers but supports eSATA drives.

- Greater than 2 TB support—You can create and manage HostRAID arrays which are bigger than 2TB size. Hence, users can use the current and future high capacity hard disk drives above 750GB.
- Flash ROM for updates to controller firmware.
- Event logging and broadcasting, including messaging for alphanumeric pagers.
- Support for Adaptec Metadata Format (AMF) allowing the migration of simple volumes and arrays to Adaptec RAID controllers.
- Multiple options for creating and managing RAID arrays—A full software application (Adaptec Storage Manager), a BIOS-based utility, and a command line utility. See [Managing Your Storage Space on page 50](#) for more information.
- Support for disk drive hot swapping.
- Support for disk drive enclosures with SAF-TE enclosure management hardware.

Array Level Features

- Support for RAID 0, 1, 10, and simple volumes with these HostRAID limitations:
 - RAID 0: support for max. six drives with SAS and max. four drives with SATA
 - RAID 10: support for max. four drives
 - RAID 1 is build with two drives always

The maximum number of arrays per controller is two.

The maximum number of global hot spares per controller is one.

- Hot swap rebuild of fault tolerant arrays through the operating system.
- Support for automatic failover, so arrays are automatically rebuilt when a failed disk drive is replaced (applies to redundant arrays in SES2- or SAF-TE-enabled disk drive enclosures only).
- Global hot spare protecting every fault tolerant array that the drive has enough available capacity to protect.
- Support for migration:
 - Simple Volume to RAID 0
 - Simple Volume to RAID 1
- (SATA-only) Native command queuing (NCQ), which lets disk drives arrange commands into the most efficient order for optimum performance.

- (SAS-only) Support for disk drive enclosures with SES2 enclosure management hardware.

About the Adaptec 58300 Controller

The Adaptec 58300 is a low-profile PCI-X to 8-Phy SAS 1.0 HostRAID controller with these features:

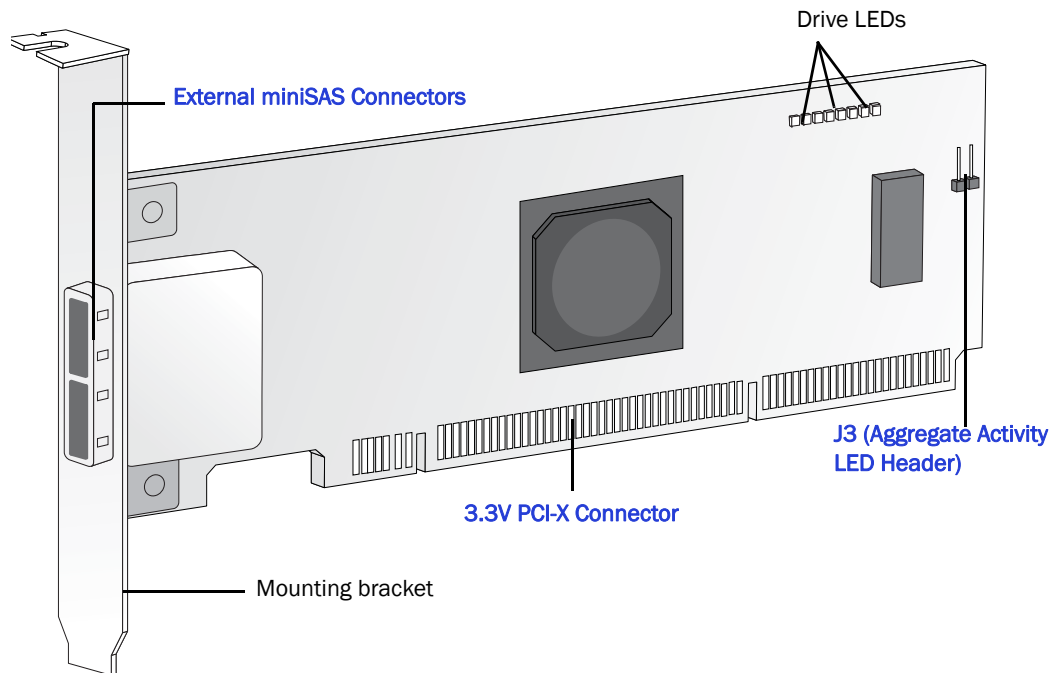

Form factor	Low-profile
Bus compatibility	PCI-X
PCI bus width (max)	64-bit
PCI bus speed (max)	133 MHz
PHYs	8
Connectors, internal	None
Connectors, external	2 x4 external SFF 8088 (miniSAS) miniSAS 1.0 connector
RAID levels	0, 1, 10
Simple volume	Yes
Disk drives	SAS (3.0Gb/s), SATA I (1.5Gb/s), SATA II 3.0Gb/s)
Maximum number of disk drives	8 direct-attached drives or up to 128 using expander technology
Hot spares	Yes
Enclosure support	Yes
Native Command Queuing (NCQ)	No
Automatic failover	Yes
Audible alarm	No

Note: There is NO I2C function on this controller, as all ports are external.

About the Adaptec 48300 Controller

The Adaptec 48300 is a low-profile PCI-X to 8-Phy SAS 1.0 HostRAID controller with these features:

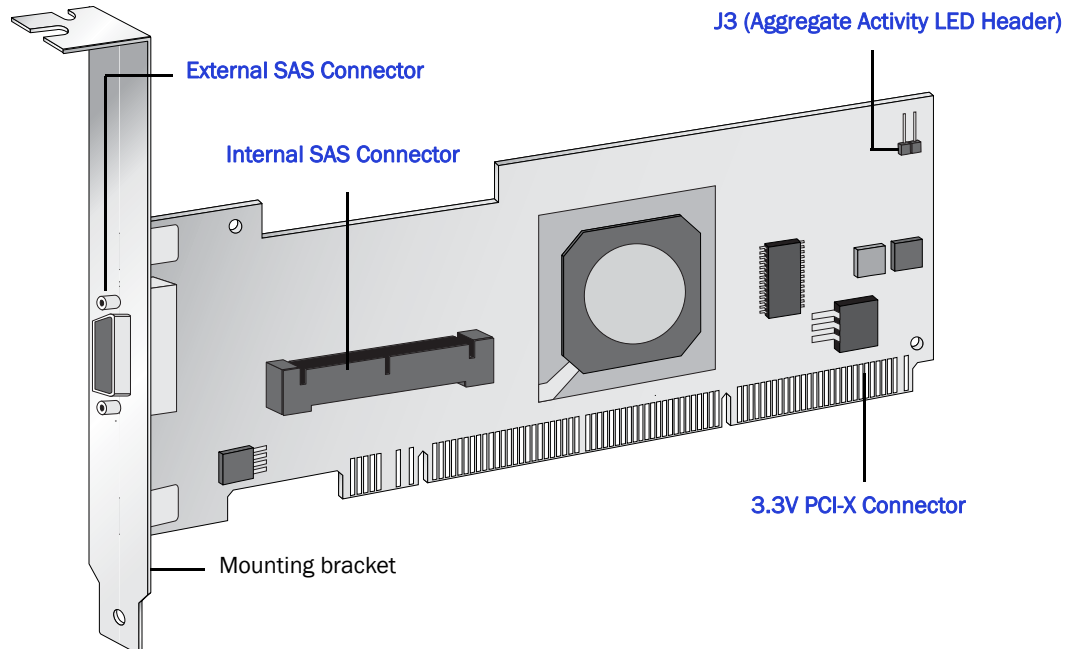

Form factor	Low-profile
Bus compatibility	PCI-X
PCI bus width (max)	64-bit
PCI bus speed (max)	133 MHz
PHYs	8
Connectors, internal	1 x4 internal SFF-8484 SAS 1.1 connector
Connectors, external	1 x4 external SFF-8470 SAS 1.0 connector
RAID levels	0, 1, 10
Simple volume	Yes
Disk drives	SAS (3.0Gbps), SATA I (1.5Gbps), SATA II (3.0Gbps)
Maximum number of disk drives	8 direct-attached drives or up to 128 using expander technology
Hot spares	Yes
Enclosure support	Yes
Native Command Queuing (NCQ)	No
Automatic failover	Yes
Audible alarm	No

Note: There is no separate I2C connector. See the [HostRAID Controller LED and I2C Connector Reference on page 87](#) for details.

About the Adaptec 44300 Controller

The Adaptec 44300 is a low-profile PCI-X to 4-Phy SAS 1.0 HostRAID controller with these features:

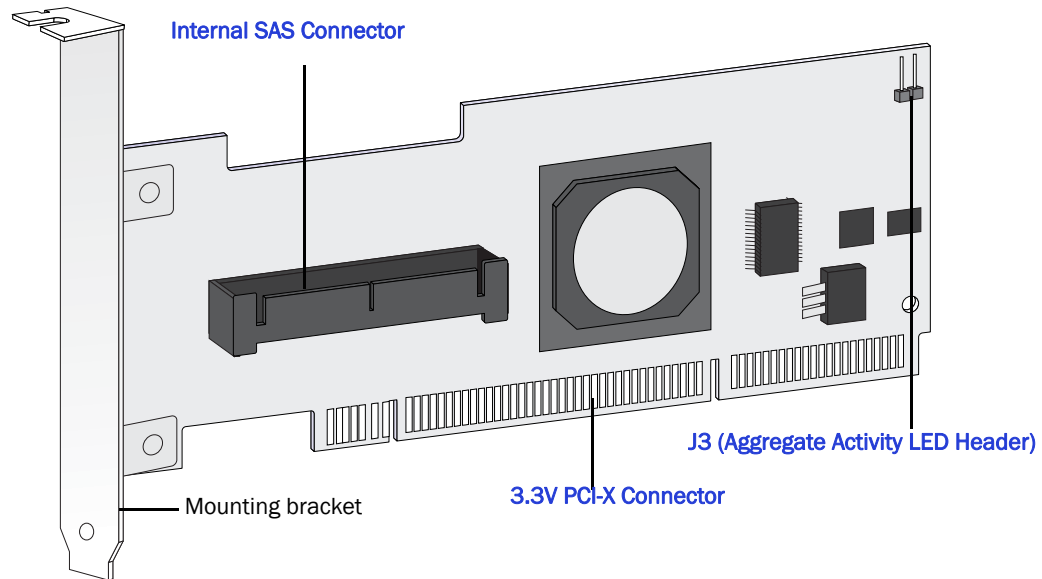

Form factor	Low-profile
Bus compatibility	PCI-X
PCI bus width (max)	64-bit
PCI bus speed (max)	133 MHz
PHYs	4
Connectors, internal	1 x4 internal SFF-8484 SAS 1.1 connector
RAID levels	0, 1, 10
Simple Volume	Yes
Disk drives	SAS (3.0Gbps), SATA I (1.5Gbps), SATA II (3.0Gbps)
Maximum number of disk drives	4 direct-attached drives or up to 128 using expanded technology
Hot spares	Yes
Enclosure support	Yes
Native Command Queuing (NCQ)	No
Automatic failover	Yes
Audible alarm	No

Note: There is no separate I2C connector. See the [HostRAID Controller LED and I2C Connector Reference on page 87](#) for details.

About the Adaptec 1430SA Controller

The Adaptec 1430SA is a low-profile 4-port PCIe SATA II HostRAID controller with these features:

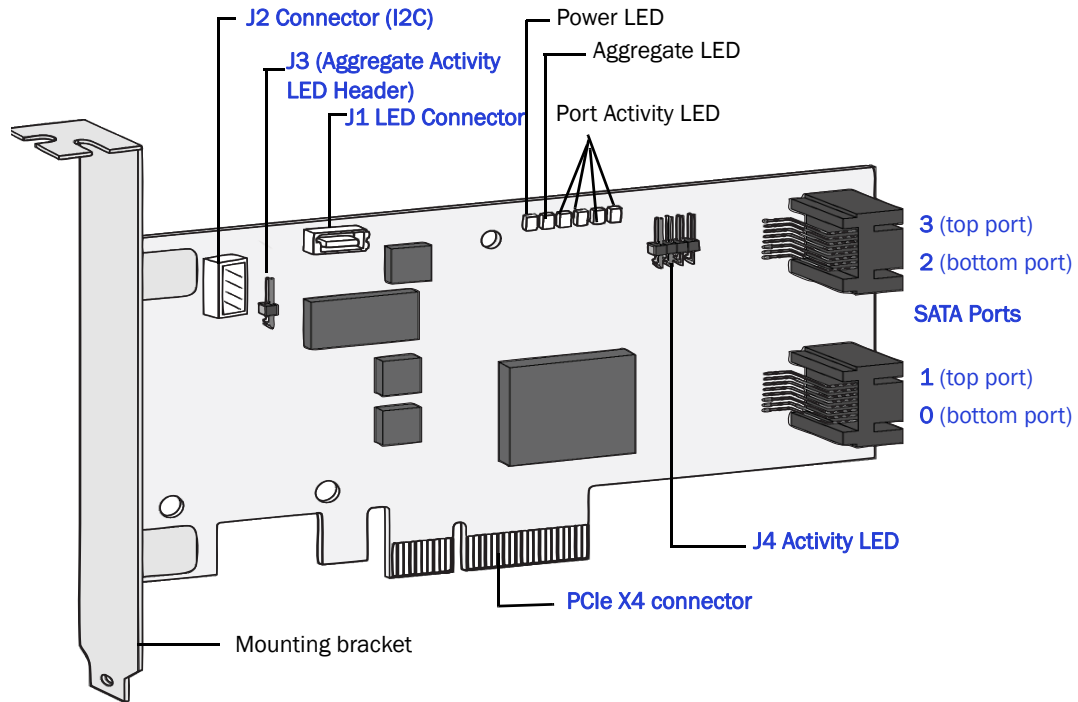

Form factor	Low-profile
Bus compatibility	PCIe x4
Ports	4
Connectors, internal	4 stacked
RAID levels	0, 1, 10
Simple volume	Yes
Disk drives	SATA I (1.5Gbps), SATA II (3.0Gbps)
Maximum number of disk drives	4
Hot spares	Yes
Enclosure support	Yes, SATA II Enclosure Management using I2C connection
Native Command Queuing (NCQ)	Yes
Automatic failover	Yes
Audible alarm	No

Note: There is no separate I2C connector. See the [HostRAID Controller LED and I2C Connector Reference on page 87](#) for details.

About the Adaptec 1420SA Controller

The Adaptec 1420SA is a low-profile PCI-X to 4 port SATA II HostRAID controller with these features:

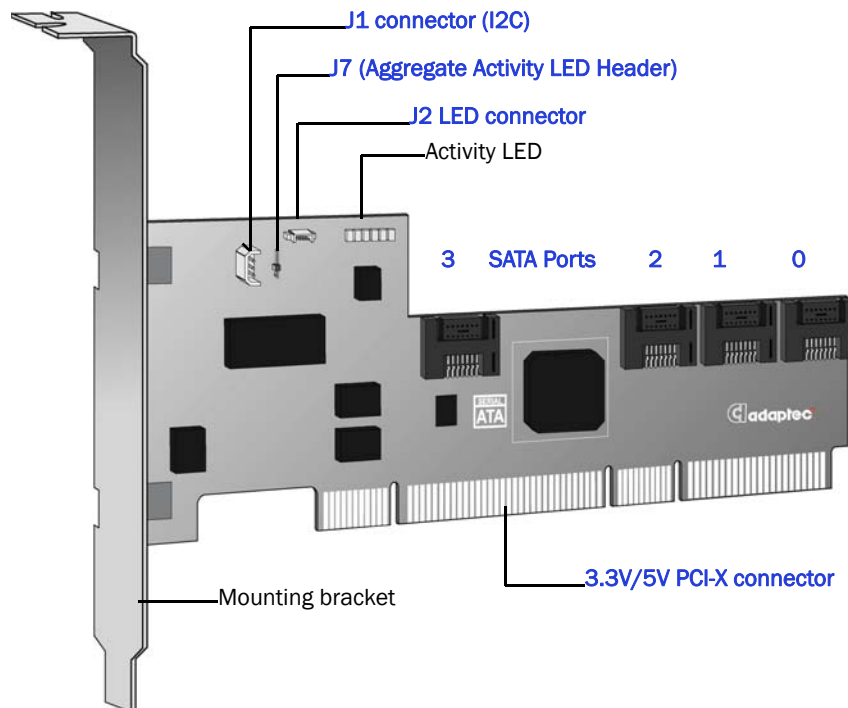

Form factor	Low-profile
Bus compatibility	PCI-X
Ports	4
Connector, internal	4
RAID levels	0, 1, 10
Simple volume	Yes
Disk drives	SATA I (1.5Gbps), SATA II (3.0Gbps)
Maximum number of disk drives	4
Hot spares	Yes
Enclosure support	Yes, SATA II Enclosure Management using I2C connection
Native Command Queuing (NCQ)	Yes
Audible alarm	No

Note: There is no separate I2C connector. See the [HostRAID Controller LED and I2C Connector Reference on page 87](#) for details.

About the Adaptec 1220SA Controller

The Adaptec 1220SA is a low-profile PCIe to 2 port SATA II HostRAID controller with these features:

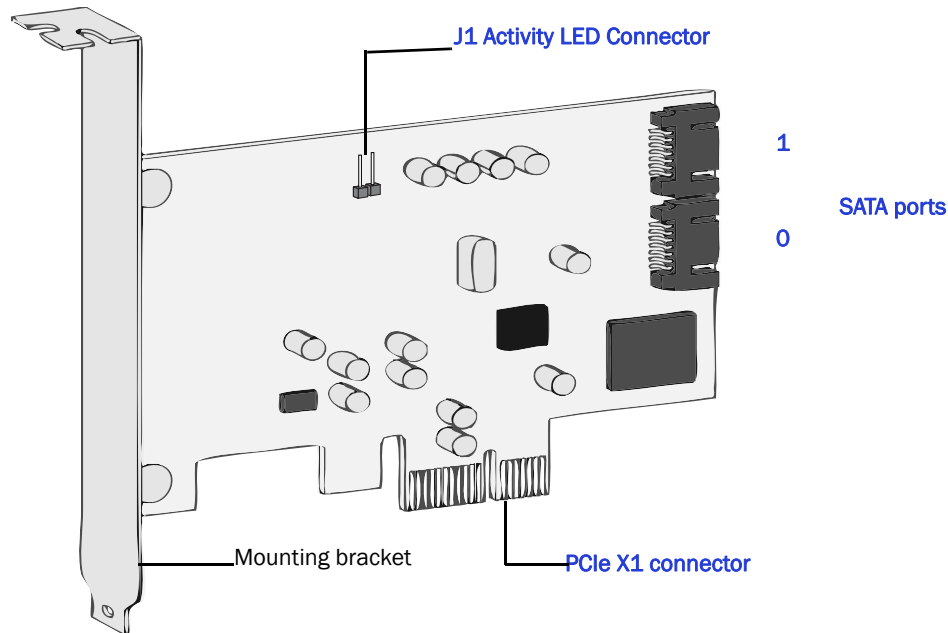

Form factor	Low-profile
Bus compatibility	PCIe-X1
Ports	2
Connector, internal	2
RAID levels	0, 1
Simple Volume	Yes
Disk drives	SATA I (1.5Gbps), SATA II (3.0Gbps)
Maximum number of disk drives	2
Hot spares	Yes
Enclosure support	No
Native Command Queuing (NCQ)	Yes
Audible alarm	No

Note: There is no separate I2C connector. See the [HostRAID Controller LED and I2C Connector Reference on page 87](#) for details.

About the Adaptec 1225SA Controller

The Adaptec 1225SA is a low-profile PCIe to 2 external port SATA II HostRAID controller with these features:

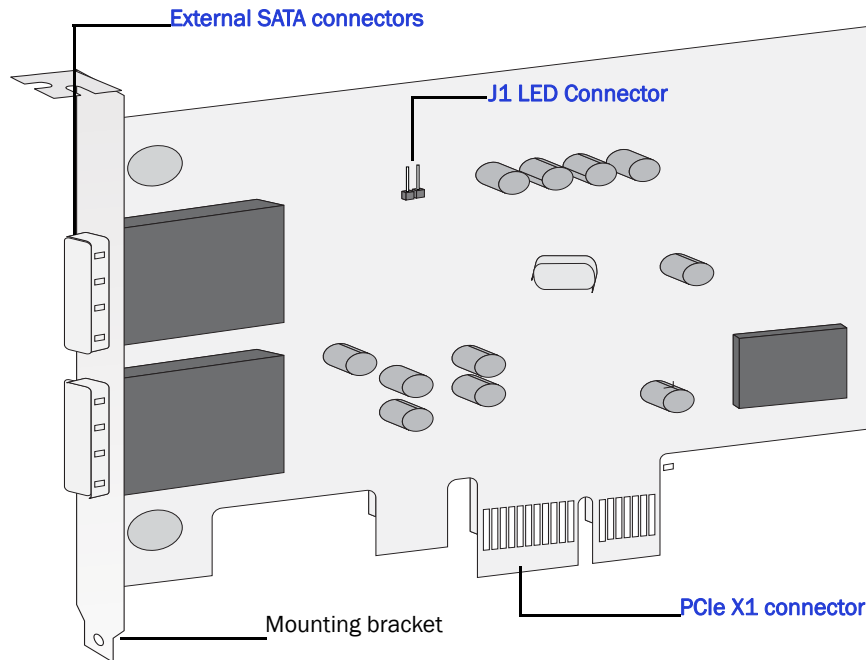

Form factor	Low-profile
Bus compatibility	PCIe-X1
Ports	2 external SATA ports You can also connect one SATA drive enclosure with a port multiplier. For details about supported port multipliers, refer to HostRAID Controller Features on page 15 .
Connector, internal	0
Connector, external	2 external SATA connectors
RAID levels	0, 1 and 10
Simple Volume	Yes
Disk drives	SATA II (3.0Gbps) NCQ-enabled drives or eSATA drives.
Maximum number of disk drives	2
Hot spares	Yes
Enclosure support	Yes—for port multiplier enclosures.
Native Command Queuing (NCQ)	Yes
Audible alarm	No

Note: Adaptec 1225SA controller does not support bootable devices.

Note: There is no separate I2C connector. See the [HostRAID Controller LED and I2C Connector Reference on page 87](#) for details.

Kit Contents and System Requirements

3

In this chapter...

Kit Contents.....	25
System Requirements	25

This chapter lists the contents of your HostRAID controller kit and the system requirements that must be met for you to successfully install and use your HostRAID controller.

Kit Contents

- Adaptec SAS or SATA HostRAID controllers
- These utilities are embedded in the controller's BIOS :
 - Array Configuration Utility (ACU)—Used to create, configure, and manage arrays
 - SerialSelect or SATASelect—Used to modify your controller and disk drive settings
 - Disk Utilities—Used to format and verify disk drives
- HostRAID installation CD (bootable), including controller drivers, and this *Guide*
- Adaptec Storage Manager installation CD (not bootable), including Adaptec Storage Manager and the Adaptec HRCNF (HostRAID Configuration) command line utility
- Readme files
- Cables (type and quantity vary depending on your HostRAID controller—not included in all controller kits. See [Chapter 5](#) for details.)
- Low-profile bracket
- *SAS and SATA HostRAID Controllers Quickstart Guide*

System Requirements

- PC-compatible computer with Intel Pentium, or equivalent processor
- A motherboard with these features:
 - Complies with the *PCI Local Bus Specification, Revision 2.2 and higher*
 - Supports multifunction devices where one of the devices is a PCI bridge
 - Large memory-mapped address ranges

Note: Refer to the Readme file on the HostRAID Installation CD for additional motherboard compatibility information.
- One of these operating systems:
 - Microsoft® Windows® Server 2003, XP and Windows Vista
 - Red Hat Linux
 - SUSE Linux
 - Novell® NetWare®

Note: For up-to-date operating system version support, visit www.adaptec.com.
- At least 256 MB of RAMs
- Available compatible PCI/PCI-X/PCIe slot (depending on your controller model—see [Chapter 2](#).)
- 40 MB of free drive space
- 16-bit SVGA color monitor with a resolution of at least 800 x 600
- CD drive
- Appropriate interface cables

Installing the HostRAID Controller and Disk Drives

4

In this chapter...

Before You Begin	27
Installing the HostRAID Controller	27
Selecting Disk Drives.....	28
Selecting SAS Cables	28
Selecting SATA Cables	30
Connecting Disk Drives to SAS HostRAID Controllers	30
Connecting Disk Drives to SATA HostRAID Controllers.....	32
Setting the Boot Controller.....	33
Next Steps	34

This chapter explains how to install your HostRAID controller, and how to connect disk drives.

Before You Begin

- Read the Safety Information on [page 92](#).
- Familiarize yourself with your HostRAID controller's physical features and the RAID levels that it supports (see [page 14](#)).
- Ensure that you have the right number of disk drives to achieve the desired RAID level (see [page 64](#)).
- Ensure that you have the proper cables for your controller and disk drives (see [page 28](#) for SAS [page 30](#) cables and for SATA cables).
- If you have a low-profile computer cabinet, replace the original full-height bracket with the low-profile bracket supplied in the controller kit.

 **Caution:** Handle the controller by its bracket or edges only.

Installing the HostRAID Controller

This section describes how to install your HostRAID controller into your computer cabinet.

- 1 Turn off your computer and disconnect the power cord. Open the cabinet, following the manufacturer's instructions.

- 2 Select an available PCI, PCIe or PCI-X expansion slot and remove the slot cover, as shown at right.

For the best performance, use the available slot that's compatible with your HostRAID controller (see [Chapter 2](#)).

PCI/PCIe bus compatibility is marked to the controller figures in [About Your HostRAID Controller on page 14](#).

 **Caution:** Touch a grounded metal object before handling the HostRAID controller.

- 3 As shown at right, insert the HostRAID controller into the expansion slot and press down gently but firmly until it clicks into place. When installed properly, the HostRAID controller should appear level with the expansion slot.

- 4 Secure the bracket in the expansion slot, using the retention device (for instance, a screw or lever) supplied with your computer.

- 5 Connect your computer's disk activity LED cable to the LED connector on the HostRAID controller, if applicable to your controller. The LED connectors are marked on the figures in [About Your HostRAID Controller on page 14](#).

Ensure that the positive lead of the LED cable (usually a red wire or a wire marked with a red stripe) is connected to pin 1.

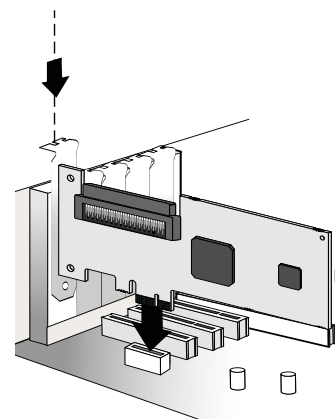
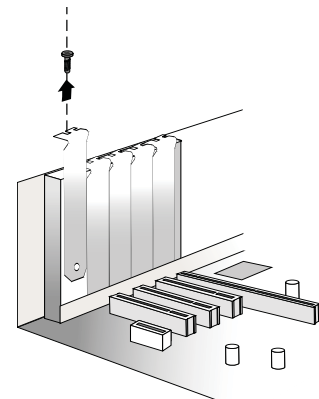

- 6 **Optional**—Connect your HostRAID controller's I2C connector (not available on all models) to an I2C connector on an internal backplane or enclosure, using an I2C cable.
- 7 Connect your disk drives, following the instructions on [page 30](#) for SAS controllers or [page 32](#) for SATA controllers.

Selecting Disk Drives

When selecting disk drives for your RAID array, ensure that all the disk drives have the same performance level. You can use different-sized disk drives in the array, but the array will be limited to the capacity of the smallest and slowest disk drive. For more information, refer to the *Adaptec Storage Manager User's Guide* or *Adaptec Storage Manager online Help*.

Adaptec SAS HostRAID controller supports both SAS and Serial ATA (SATA) I and II disk drives. For cable information, see next section.

Selecting SAS Cables

You need one SAS cable for each disk drive you are connecting to your SAS HostRAID controller. Depending on your requirements, you can use any of these cables:

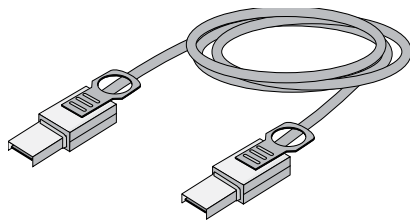

Internal SAS (SFF-8484) to SAS (SFF-8484) cable

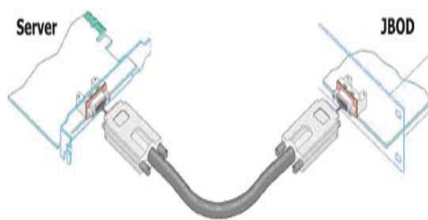

External miniSAS (SFF-8088) to SAS (SFF-8470) cable

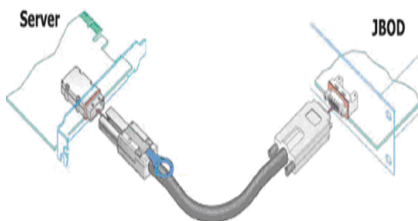

External SFF-8470 to SFF-8470 cable

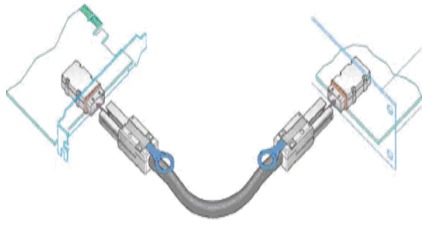

External SFF-8088 to SFF-8088 cable

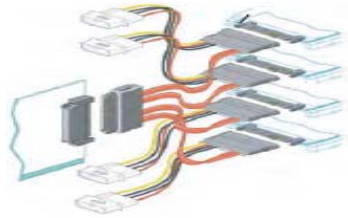

Internal SFF-8484 to 4x SFF-8482 fanout cable

Note: This cable is included in the Adaptec HostRAID 44300 and 48300 controller kit. It can be used to connect SAS or SATA disk drives



Internal SFF-8484 to 4x SATA fanout cable

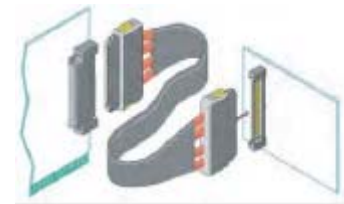

Internal SFF-8484 to SFF-8484 cable

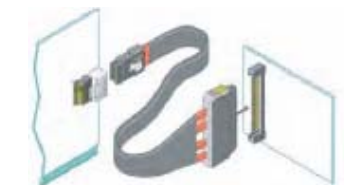

Internal SFF-8087 to SFF-8484 cable

Adaptec recommends using only Adaptec SAS cables. For more information or to purchase cables, visit the Adaptec Web site at www.adaptec.com.

Selecting SATA Cables

You need one straight connector to straight connector SATA cable for each disk drive you are connecting to your SATA HostRAID controller. SATA cables are included in the kit.



External SATA (eSATA) cable

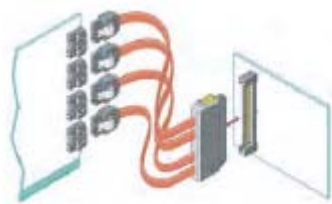

Internal 4x SATA to SFF-8484 fanout cable



Internal SATA to SATA cables

Note: These cables are included in the SATA HostRAID controller kit. There are two cables included in the 1220SA kit and four cables in the 1420SA or 1430SA kit.

All SATA straight connector to straight connector cables have the same connectors, as shown in the following figure, and the connectors are keyed so that you can't insert them incorrectly.

Adaptec recommends using only Adaptec SATA cables. For more information or to purchase cables, visit www.adaptec.com.

Connecting Disk Drives to SAS HostRAID Controllers

You can connect SAS disk drives, SATA disk drives, or a combination of both to your SAS HostRAID controller. There are no jumpers or switches to set before installation.

If you plan to build a bootable array using internal disk drives, ensure you install at least the minimum number disk drives required to support the RAID level you want. See [page 65](#) for more information.

Note: Although you can connect both SAS and SATA disk drives to your SAS HostRAID controller, Adaptec recommends not to combine SAS and SATA disk drives within the same array or logical drive. See [page 59](#) for more information.

You have these connection options:

- [Connecting Directly to the HostRAID Controller](#) (see below).
- [Connecting to a Backplane](#) on page 31.

Connecting Directly to the HostRAID Controller

In a direct-attach connection, SAS or SATA disk drives are connected directly to a SAS HostRAID controller with SAS cables. The number of direct-attached disk drives is limited to four per internal SAS connector. For more information, see [Direct-Attach Connections](#) on page 61.

- 1 Install your internal SAS or SATA disk drives, following the instructions in your system's documentation.
- 2 Use internal SAS cables to connect the disk drives to the SAS HostRAID controller.

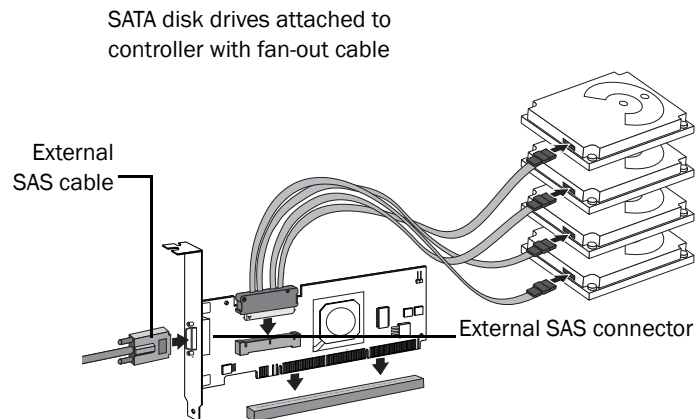

- 3 When you have installed all disk drives and connected them to the SAS HostRAID controller, close your computer cabinet, and reconnect the power cord.

Connecting to a Backplane

In a backplane connection, disk drives and SAS HostRAID controllers are connected to, and communicate with each other through a backplane.

The number of disk drives is limited to the number of slots available on the backplane. Some backplanes have embedded SAS expanders and can support up to 128 end devices. For more information about expander connections, see [page 32](#).

- 1 Connect one or more internal SAS or SATA disk drives to the backplane. Refer to your system's documentation for more information.
- 2 Use an internal SAS cable to connect the SAS HostRAID controller to the backplane.

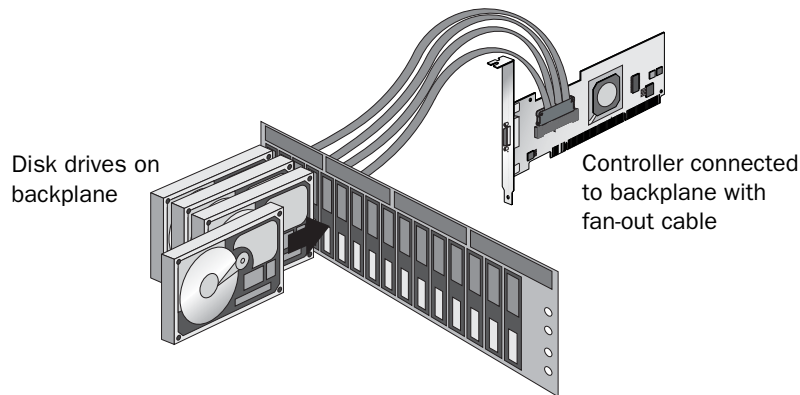

- 3 When all internal disk drives have been installed and connected, close your computer cabinet, reconnect the power cord.

Installing the SAS HostRAID Controller to a SAS Expander

You can use a SAS expander to connect multiple disk drives to your SAS HostRAID controller (or to multiple SAS HostRAID controllers). Commands can be sent down one link and data returned on another in a separate connection to increase fault tolerance. Using a SAS expander and dual-port SAS drives and SATA drives with 2-port adapters, you can design redundant systems for maximum fault-tolerance.

To install the HostRAID controller to a SAS expander:

- 1 Using the appropriate cable, connect the SAS HostRAID controller to the expander's PHY connector.
- 2 Connect a cable from the expander's PHY connector to a disk drive.

Connecting Disk Drives to SATA HostRAID Controllers

- 1 Install your SATA disk drives, following the instructions in your system's documentation. There are no jumpers or switches to set on the SATA controller or disk drives.
- 2 Connect each disk drive to a SATA port on the controller using a recommended SATA cable. For cable information, see [page 30](#).
- 3 When all disk drives have been installed and connected, close your computer cabinet, and reconnect the power cord.

Checking Your Controller and Devices

Now that you have installed your controller and connected your disk drives, you can use the ARC utility to check your controller and devices, as described below:

- 1 Turn on your computer.
- 2 When the Adaptec banner appears, press Ctrl+A to enter the Adaptec RAID Configuration (ARC) utility.
- 3 If your drives have already been used in another system (even if not part of an array), select Disk Utilities and format the drive. Otherwise, skip to [Step 4](#).

- 4 Select *SATASelect* (on SATA controller) and *SerialSelect* (on SAS controller) to verify the hardware configuration of the controller and the drives.

Verify that all drives are shown. If anything appears to be missing, power down the computer and check the connections.

Setting the Boot Controller

Note: If your system contains only one bootable controller, or if you are using the 1225SA controller that does not support bootable devices, proceed with [Creating an Array on page 39](#).

Most of the Adaptec HostRAID controllers support bootable disk drives and arrays. The default setting of the HostRAID controller and system Setup allows you to install and boot from either a disk drive connected to the motherboard, or from a drive or array connected to the HostRAID controller. To enable the system to boot from either a disk drive or an array connected to the HostRAID controller:

Note: Selecting the boot controller is done using the system BIOS Setup Utility. Launching the system BIOS Setup Utility varies depending on your computer model. Refer to your computer documentation for instructions on how to access the system BIOS.

- 1 Enter the system BIOS Setup.
- 2 Navigate to the disk drive boot sequence.
- 3 Move the boot controller to the top of the list.

Next Steps

If you are installing the driver and an operating system onto a bootable array, continue with [Creating a Bootable Array on page 38](#).

If you are completing a standard installation onto an existing operating system, continue with [Installing the Driver on an Existing Operating System on page 46](#).

Getting Started

5

In this chapter...

Choosing a RAID Level.....	36
Choosing Installation Options	36
Basic Installation Steps.....	36

This chapter provides the basic information you need to set up your disk drives and arrays the way you want them. It also describes the options you have for installing your HostRAID controller and disk drives, and creating arrays for data storage.

Before you begin, familiarize yourself with your HostRAID controller's physical features and the RAID levels that it supports. See [Chapter 2, *About Your HostRAID Controller*](#).

Choosing a RAID Level

Your HostRAID controller supports these RAID levels.

RAID 0 (Non-redundant Array)—Stripes data across multiple disk drives. Improved performance but no redundancy.

RAID 1 Array—Created from two disk drives where one disk drive is a mirror of the other (the same data is stored on each disk drive). Redundancy but reduced capacity.

RAID 10 Array—Built from two or more equal-sized RAID 1 arrays, stripes and mirrors data across multiple disk drives. Redundancy and improved performance.

See [page 64](#) for more information on RAID levels and use the table on [page 65](#) to see how many disk drives you must connect to your HostRAID controller to support the RAID level you want.

Choosing Installation Options

When you install your HostRAID controller, you can choose to create a bootable array and then install both operating system and controller driver on that array. Alternatively, you can complete a standard installation, where you install the controller driver on an existing operating system.

Note: Adaptec 1225SA controller does not support bootable devices, hence install this controller only on an existing operating system.

Basic Installation Steps

This section describes the installation process. Follow the steps for the installation option you've chosen.

Installing with an Operating System

You can install your HostRAID controller and the operating system using these steps:

- 1 Install and connect your controller and disk drives (see [page 26](#)).
- 2 Set the boot controller (see [page 38](#)).
- 3 Make the array bootable (see [page 41](#)).
- 4 Install your operating system and the driver (see [page 42](#)).
- 5 Install Adaptec Storage Manager and begin to manage your data storage (see [page 50](#)).

Installing with an Operating System On a Bootable Disk Drive/Array

When you install your HostRAID controller, you can create a bootable disk drive or an array and then install both operating system and controller driver on that disk drive or array. Alternatively, you can perform the standard installation, and install the controller driver on an existing operating system

- 1 Install and connect your controller and internal disk drives (see [page 26](#)).
If your controller has an external connector, you can also connect external disk drives, if required.
- 2 Install the controller driver (see [page 47](#)).
- 3 Install Adaptec Storage Manager and begin to manage your data storage (see [page 50](#)).

Installing on an Existing Operating System

- 1 Install and connect your controller and internal disk drives (see [page 26](#)).
If your controller has an external connector, you can connect external disk drives as well (or instead).
- 2 Install the controller driver (see [page 47](#)).
- 3 Install Adaptec Storage Manager and begin to manage your data storage (see [page 50](#)).

6

Creating a Bootable Array

In this chapter...

Creating an Array	39
Creating an Array with the ACU	39
Creating an Array with Adaptec Storage Manager	39
Making Your Array Bootable	41

This chapter explains how to set your HostRAID controller to be the boot controller, and how to create a bootable array.

Note: If you are completing a standard installation onto an existing operating system, proceed to [Installing the Driver on an Existing Operating System on page 46](#).

Note: Adaptec 1225SA controller does not support bootable devices.

Creating an Array

You can create a RAID 0, 1, or 10 array using one of these tools:

- **Array Configuration Utility (ACU)**—BIOS-based menus and keyboard navigation (see [Appendix C, Using the ARC Utility](#)).
- **Adaptec Storage Manager**—Graphical software application running from a bootable CD that you can navigate using your mouse (see [About Adaptec Storage Manager on page 51](#)).
- **HRCNF**—Command line utility, refer to the Command Line Interface User's Guide for Direct Attached Storage.

You can use either tool, but the ACU is quicker and easier.

Note: Adaptec recommends that you not combine SAS and SATA disk drives within the same array. Adaptec Storage Manager generates a warning if you try to create a logical drive using a combination of SAS and SATA disk drives.

Creating an Array with the ACU

The ACU is menu-based and instructions for completing tasks display on-screen. Menus can be navigated using the arrows, Enter, Esc, and other keys on your keyboard.

Before creating arrays, make sure the disks for the array are connected and installed. Disks with no usable space are shown in gray and cannot be used.

To create an array:

- 1 Turn on your computer and press **Ctrl+A** when prompted to access the Adaptec RAID Configuration (ARC) utility.
- 2 From the ARC menu, select **Array Configuration Utility (ACU)**.
- 3 From the ACU Main menu, select **Create Array**.
- 4 Select the disks for the new array. RAID 0 and 1 requires a minimum of two disk drives. RAID 10 requires a minimum of four disk drives. Then press **Insert**.

To deselect any disk, highlight the disk, then press **Delete**.

See the table on for the maximum number of drives that your HostRAID controller can support.

- 5 Select **Enter** when all disks for the new array are selected. The Array Properties menu displays. For more Information see [Assigning Array Properties on page 70](#).
- 6 When you are finished, select **Done**.

Creating an Array with Adaptec Storage Manager

This section describes how to use the Adaptec Storage Manager configuration wizard to build a RAID 0, 1, or 10 array.

Note: You will need the HostRAID Installation CD to complete this task.

To create a RAID 0, 1, or 10 array:

- 1 Insert the HostRAID Installation CD into your CD drive, then restart your computer.
- 2 When prompted, select the language you want, then press **Enter**.

- 3 Review the license information, then press **Enter**.

The Main Menu opens.

- 4 Click **Launch Configuration Utility**.

Adaptec Storage Manager opens.

- 5 Click **Create**.

The Configuration wizard opens.

- 6 Select **Express configuration...**, then click **Next**.

- 7 Review the information that is displayed.

Note: Adaptec Storage Manager uses the term logical drives when referring to arrays.

In this example, Adaptec Storage Manager has used two equal-sized disk drives to automatically create one logical drive with RAID 1.

To specify a size for the logical drives, or to make other changes to the configuration, click **Modify logical devices**.

- 8 Click **Apply**, then click **Yes** when prompted to confirm applying your new configuration.

Adaptec Storage Manager builds the logical drive(s).

The configuration is saved on the Adaptec controller (as an “array”) and on the physical disk drives.

- 9 Partition and format your logical drive.

The logical drive you created appears as a physical disk drive on your operating system. You must partition and format these logical drives before you can use them to store data.

- 10 Close all windows, then click **Reboot** to restart your system.

- 11 Remove the HostRAID Installation CD.

For information on installing and using Adaptec Storage Manager as a full software application, refer to the *Adaptec Storage Manager User's Guide* provided on the Adaptec Storage Manager CD.

- 12 Continue with [Making Your Array Bootable](#) (next section).

Making Your Array Bootable

Use the ACU to make the array bootable (see [Managing Bootable Arrays and Devices on page 73](#)).

Continue with [Installing the Driver and an Operating System on page 42](#).

Installing the Driver and an Operating System

7

In this chapter...

Before You Begin	43
Creating a Driver Disk	43
Installing with Windows	43
Installing with Red Hat Linux	44
Installing with SUSE Linux	44
Installing with NetWare	45

This chapter explains how to install your HostRAID controller driver and an operating system onto a bootable array (see [page 38](#)).

Note: To install the driver on an existing operating system, see [page 46](#).

Before You Begin

- Install and connect your HostRAID controller and internal disk drives, (see [page 26](#)).
- Create a bootable array (see [page 38](#)).
- Creating a driver disk (next section).

Note: For up-to-date operating system version support, visit www.adaptec.com.

Creating a Driver Disk

Before you install your driver, you must create a driver disk. You need a floppy disk to complete this task. To create a driver disk:

- 1 Set your system BIOS so that your computer boots from the CD drive. (For instructions, refer to your computer's documentation).
- 2 Boot your computer from the bootable HostRAID Installation CD.
- 3 Click **Create Driver Disk**, from the Main Menu.
- 4 Select one of the operating systems from the list:
 - Windows
 - Linux
 - Netware

- 5 Select the type of operating system you want to use.
- 6 Select the version of the operating system.
- 7 When prompted, insert a floppy disk, then click **OK**.

The system creates the driver disk.

- 8 Remove and label the driver disk.
- 9 Continue with the instructions for your operating system:
 - [Installing with Windows on page 43](#)
 - [Installing with Red Hat Linux on page 44](#)
 - [Installing with SUSE Linux on page 44](#)
 - [Installing with NetWare on page 45](#)

Installing with Windows

You will need your Windows Installation CD to complete this task. To install the HostRAID controller driver while installing Windows:

- 1 Insert your Windows CD, then restart the computer.
- 2 Follow the on-screen instructions to begin the Windows installation.
- 3 When prompted to install a third-party driver, press **F6**.

Note: When F6 is active, a prompt appears at the bottom of the screen for only 5 seconds. If you miss your chance to press F6, restart your computer.

- 4 Insert the driver disk, then wait until you are prompted to install a driver.
- 5 Press **S** to specify that the driver is on a floppy disk, then press **Enter**.
The computer reads the disk.
- 6 When the Adaptec SAS or SATA driver is found, press **Enter**.
- 7 Follow the on-screen instructions to complete the installation.
- 8 Continue with [Managing Your Storage Space on page 50](#).

Installing with Red Hat Linux

You will need your Red Hat Installation CD to complete this task. To install the HostRAID controller driver while installing Red Hat Linux:

- 1 Insert the first Red Hat Installation CD.
- 2 Restart your computer.
- 3 When the Red Hat Welcome screen displays, type `linux dd` at the **Boot:** prompt.
- 4 When prompted, insert the driver disk, then select **OK**.
- 5 Follow the prompts to set up the environment you want.
- 6 If you are installing other third-party devices, install them now. Otherwise, select **Done**.
- 7 Complete the Red Hat Linux installation, following the instructions included with your operating system.
- 8 Continue with [Managing Your Storage Space on page 50](#).

Installing with SUSE Linux

To install the HostRAID controller driver while installing SuSE Linux:

- 1 Insert the first SUSE Installation CD.
- 2 Restart your computer.
- 3 When the SUSE (SLES 9 and 10) installation selection screen displays, press the F6 key, select installation option from the Menu, then press **Enter**.
- 4 When prompted, insert the driver disk, then press any key to continue.
- 5 Follow the prompts to set up the environment you want.
- 6 If you are installing other third-party devices, install them now. Otherwise, select **Back**.
- 7 Complete the SUSE Linux installation, following the instructions included with your operating system.
- 8 Continue with [Managing Your Storage Space on page 50](#).

Installing with NetWare

Note: NetWare does not support drive enclosures with port multipliers but supports eSATA drives.

You will need your NetWare Installation CD to complete this task. To install the driver when installing NetWare:

- 1 Restart your computer, then install NetWare. (For instructions, refer to your NetWare documentation.)
To be able to load additional drivers later, select **Manual** install mode during the first part of the installation.
- 2 Click **Continue** to load additional drivers:
 - a Select **Modify** when the storage adapters are displayed.
 - b Select **Storage Adapters**, then press the **Insert** key twice to add an unlisted driver from the floppy disk.
- 3 When the Device Types screen displays, check the Storage adapters list, then select **Modify** to add another driver.
- 4 Select **Storage Adapters**, then press **Enter**.
All recognized controllers are displayed.
- 5 If necessary, remove the default HostRAID driver (*<driver-name>.ham*).
- 6 Press the **Delete** key to remove it.
- 7 Press **Insert** to add another driver.
The available drivers are displayed.
- 8 Insert the driver floppy disk.
- 9 Press the **Insert** key to scan the floppy disk drive.
Once the driver is selected, the Parameter screen is displayed.
- 10 From the lower window menu, select **Continue**, then press **Enter**.
If the driver installation process fails, the server console is displayed so you can see the cause of the failure.
To modify disk partitions, apply hot fixes, or perform volume maintenance, refer to your NetWare documentation.
- 11 Continue with [Managing Your Storage Space on page 50](#).

Installing the Driver on an Existing Operating System

8

In this chapter...

Before You Begin	47
Creating a Driver Disk or an Array	47
Installing on Windows XP or Windows 2003	47
Installing on Windows Vista	48
Installing on Red Hat or SUSE Linux.....	48
Installing on NetWare	48

This chapter explains how to install your HostRAID controller driver on an existing operating system.

Note: To install the driver and an operating system on the bootable array, see [page 42](#).

Before You Begin

Before you begin, install and connect your HostRAID controller and internal disk drives (see [page 26](#)).

You must also create a driver disk (see next section) before you begin installing the controller driver.

Note: For up-to-date operating system version support, visit the Adaptec Web Site at www.adaptec.com.

Creating a Driver Disk or an Array

Before you install your driver, you will need to create a driver disk. You will need a floppy disk to complete this task. To create a driver disk:

- 1 Set your system BIOS so that your computer boots from the CD drive. (For instructions, refer to your computer's documentation.)
- 2 Turn on your computer, then insert the HostRAID Installation CD included in your controller kit.
- 3 Follow the on-screen instructions to get to the Adaptec Start Menu.
- 4 Click **Create Driver Disk**, from the Main Menu.
- 5 Select one of the operating systems from this list:
 - Windows XP/2003 and Windows Vista
 - Linux
 - Netware
- 6 Select the type of operating system you want to use.
- 7 Select the version of the operating system.
- 8 When prompted, insert the floppy disk, then click **OK**.
The system creates the driver disk.
- 9 Remove and label the driver disk.
- 10 Continue the driver installation for your operating system:
 - [Installing on Windows XP or Windows 2003](#) (next section)
 - [Installing on Windows Vista on page 48](#)
 - [Installing on Red Hat or SUSE Linux on page 48](#)
 - [Installing on NetWare on page 48](#)

Installing on Windows XP or Windows 2003

To install the driver on Windows:

- 1 Start or restart Windows.
The Found New Hardware Wizard opens and searches for the driver.
- 2 Insert the driver disk, select **Floppy drive**, then click **Next**.

- 3 Click **Next**, then click **Next** again.
- 4 Follow the on-screen instructions to complete the driver installation.
- 5 Remove the driver disk and restart your computer.
- 6 Continue with [Managing Your Storage Space on page 50](#).

Installing on Windows Vista

- 1 Insert the Windows setup CD.
- 2 When prompted to install a third-party driver, click **Load Driver**.
- 3 Select the driver and click **Next**.
- 4 The disk array is displayed.
- 5 Click **Drive Options** to modify the RAID 10 size, else click **Next** to proceed with the installation.

Installing on Red Hat or SUSE Linux

To install the module on Red Hat or SUSE Linux:

- 1 Insert and mount the RAID Installation CD:

```
Red Hat—mount /dev/cdrom /mnt/cdrom  
SuSE—mount /dev/cdrom /media/cdrom
```

- 2 Install the module RPM:

```
rpm -Uvh mount-point/xxx/yyy.rpm
```

where `mount-point` is the specific mount point on the Linux system, `xxx` is the driver path, and `yyy.rpm` is the rpm file.

- 3 Run `fdisk`, `mkfs`, and create mount points for any new disk drives.
- 4 Continue with [Managing Your Storage Space on page 50](#).

Installing on NetWare

Note: Before you begin, ensure that the NetWare operating system has been upgraded to the minimum patch level specified by Novell. Refer to the Novell Web site for more information.

Note: NetWare does not support drive enclosures with port multipliers but supports eSATA drives.

To install the driver on NetWare:

- 1 Start your computer.
- 2 From the NetWare server console prompt, type `load hdetect`, then press **Enter**.
- 3 From the Device types menu, select **Continue**, then press **Enter**.
- 4 From the Device type option, select **Modify**, then press **Enter**.
- 5 Select **Storage Adapters**, then press **Enter**.
- 6 From the Additional Driver Options menu, select **Modify**, then press **Enter**.

- 7 From the Driver Name menu, press the **Insert** key.
- 8 Insert the driver disk, press the **Insert** key, then press F3.
- 9 From the A:\ prompt, press **Enter**.
The driver installs.
- 10 From the Additional Driver Option menu, select **Return to driver summary**, then press **Enter**.
- 11 From the Driver type menu, select **Load on Additional Driver Options**.
- 12 After the driver loads, select **Continue**.
- 13 Continue with [Managing Your Storage Space](#) on page 50.

Managing Your Storage Space

9

In this chapter...

About Adaptec Storage Manager	51
About the HRCNF Command Line Utility.....	51
About the ARC Utility.....	52
About the Adaptec Flash Utility	52
Which Utility Should I Use?	52

Once you have installed your HostRAID controller, disk drives (or other devices), and device driver, you can begin to build and manage your storage space.

This chapter introduces the tools you can use to manage your storage space. All the tools described in this chapter are included on the CDs included with your HostRAID controller.

About Adaptec Storage Manager

Adaptec Storage Manager is a full-featured software application that helps you build a storage space for your data. With Adaptec Storage Manager, you can group disk drives into logical drives and build in redundancy to protect your data and improve system performance.

Adaptec Storage Manager is included on the Adaptec Storage Manager Installation CD. For installation instructions, refer to the *Adaptec Storage Manager User's Guide*, also included on the Adaptec Storage Manager Installation CD.

You can also use Adaptec Storage Manager to monitor and manage all the controllers and disk drives in your storage space from a single location.

When Adaptec Storage Manager is installed on a computer, the *Adaptec Storage Manager agent* is also installed automatically. The agent is like a service that keeps your storage space running. It runs in the background, without user intervention, and monitors and manages system health, notifies events, schedules tasks, and manages other on-going processes. It sends notices when tasks are completed successfully, and sounds an alarm when errors or failures occur.

The agent uses less memory than the full application. If your storage space includes systems that won't be connected to monitors (and therefore won't require the user interface), you can choose to run the *agent only* on those systems instead of the full application. For more information, refer to the *Adaptec Storage Manager User's Guide* or online Help.

Installing Adaptec Storage Manager

Adaptec Storage Manager is included on the Adaptec Storage Manager Installation CD. For installation instructions, refer to the *Adaptec Storage Manager User's Guide* for Direct Access Storage , also included on the Adaptec Storage Manager Installation CD.

About the HRCONF Command Line Utility

HRCONF (HostRAID Configuration Utility) is a command line utility that you can use to perform some basic array and configuration management functions.

With HRCONF, you can:

- Create and delete logical drives
- Modify and copy configuration settings
- Recover from disk drive failures and troubleshoot

Note: Adaptec recommends that only advanced users familiar with command line interfaces use HRCONF.

About the ARC Utility

The Adaptec RAID Configuration (ARC) utility is a BIOS-based utility that you can use to create and manage controllers, disk drives and other devices, and arrays. The ARC utility comprises these tools:

- **Array Configuration Utility (ACU)**—For creating and managing arrays, and initializing and rescanning disk drives.
- **SerialSelect Utility**—Used to change device and HostRAID controller settings.
- **Disk Utilities**—For formatting or verifying disk drives.

The ARC utility is included in your controller's BIOS. For more information, see [Using the ARC Utility on page 68](#).

The ARC utility is primarily intended for pre-operating system installation configuration.

About the Adaptec Flash Utility

The Adaptec Flash Utility (AFU) is a text-based DOS utility that you can use to update, save, or verify your HostRAID controller's firmware BIOS and Non-Volatile Random Access Memory (NVRAM). For more information, see [page 80](#).

 **Caution:** Although the AFU contains safeguards to prevent you from accidentally damaging your RAID controller's flash contents, it is still important to use the AFU carefully and correctly to avoid rendering your RAID controller inoperable. Adaptec recommends that only advanced users familiar with working in DOS use the AFU.

Which Utility Should I Use?

To create a bootable array, Adaptec recommends that you use the BIOS-based ARC utility.

For all subsequent storage management tasks, Adaptec recommends that you install and use Adaptec Storage Manager (see [page 51](#)). As a full-featured software application with a graphical user interface (GUI), it is the easiest to use and offers the widest range of management functions.

Solving Problems

10

In this chapter...

Troubleshooting Checklist	54
Recovering from a Disk Drive Failure	54
Resetting the Controller	55

This chapter provides basic troubleshooting information and solutions for solving your HostRAID controller problems.

Troubleshooting Checklist

If you encounter difficulties installing or using your HostRAID controller, check these items first:

- With your computer powered off, check the connections to each disk drive, the power supply, the LED connector, and so on.
- Try disconnecting and reconnecting disk drives from the HostRAID controller.
- Check that your HostRAID controller is installed in a compatible expansion slot. To double-check the bus compatibility of your controller, see [About Your HostRAID Controller on page 14](#).
- Ensure that your HostRAID controller is firmly seated and secured in the PCI, PCI-X, or PCIe expansion slot.
- If your HostRAID controller is not detected during system boot, try installing it in a different expansion slot. See [Installing the HostRAID Controller on page 27](#) for instructions.
- Did the driver install correctly?

If you are still unable to resolve a problem, you can find additional troubleshooting information and direction on the Adaptec Web site at www.adaptec.com and the Adaptec Support Knowledgebase at ask.adaptec.com.

Recovering from a Disk Drive Failure

This section explains how to recover when a disk drive fails:

- If the array was protected by a hot spare, see next section.
- If the array was *not* protected by a hot spare, see [Failed Disk Drive Not Protected by a Hot Spare on page 54](#).
- If there is a disk drive failure in more than one array simultaneously, see [Failure in Multiple Arrays Simultaneously on page 55](#).
- If it is a RAID 0 array, see [Disk Drive Failure in a RAID 0 Array on page 55](#).
- If multiple disk drives fail within the same array, see [Multiple Failures in the Same Array on page 55](#).

Note: Adaptec Storage Manager uses the term *logical drives* when referring to *arrays*.

Failed Disk Drive Protected by a Hot Spare

When an array is protected by a hot spare, if a disk drive in that array fails the hot spare is automatically incorporated into the array and takes over for the failed drive.

To recover from the failure, remove and replace the failed disk drive (following manufacturer's instructions).

Failed Disk Drive Not Protected by a Hot Spare

If a disk drive fails in an array that is not protected by a hot spare, replace the failed drive. The controller detects the new disk drive and rebuilds the array.

If the controller fails to rebuild the array, check that the cables, disk drives, and controllers are properly installed and connected. Then, if necessary, use Adaptec Storage Manager to rebuild the array. For instructions, refer to the *Adaptec Storage Manager User's Guide* or online Help.

Failure in Multiple Arrays Simultaneously

If the disk drive failure in more than one array at the same time (one failure per array), and the arrays are protected by hot spares, the controller rebuilds the arrays with these limitations:

- A hot spare must be of equal or greater size than the failed disk drive it's replacing.
- Failed disk drives are replaced with hot spares in the order in which they failed. (The array that includes the disk drive that failed first is rebuilt first, assuming an appropriate hot spare is available—see bullet above).

If there are more disk drive failures than hot spares, see *Failed Disk Drive Not Protected by a Hot Spare* in previous section.

Disk Drive Failure in a RAID 0 Array

Because RAID 0 volumes do not include redundancy, if a disk drive fails in a RAID 0 array, the data can't be recovered.

Correct the cause of the failure or replace the failed disk drives. Then, restore your data (if available).

Multiple Failures in the Same Array

If more than one disk drive fails at the same time in the same RAID 1 array, the data can't be recovered.

Correct the cause of the failure or replace the failed disk drives. Then, restore your data (if available).

In some instances, RAID 10 arrays *may* survive multiple disk drive failures, depending on which disk drives fail. For more information, refer to the *Adaptec Storage Manager User's Guide* or online Help.

Resetting the Controller

This section explains how to reset (or *flash*) your Adaptec HostRAID controller. You may want to do this if the controller becomes inoperable, or if a firmware upgrade is unsuccessful.

To reset your Adaptec HostRAID controller:

- 1 Download the firmware version currently installed on your controller from www.adaptec.com.
- 2 Extract the downloaded files to a folder on your local hard drive (for example, C:\Download\Drivers).
- 3 Create a bootable MS-DOS floppy disk and copy the AFU.exe file to it. Copy the first firmware image to the same floppy disk.
- 4 Create additional bootable MS-DOS floppy disks and copy each additional firmware image to its own floppy disk.

- 5** Power off your computer, disconnect the power cord, then open the cabinet following the manufacturer's instructions.
- 6** Disconnect all cables from the controller, then attach a shorting jumper to the Mode 0 flash connector.
- 7** Reconnect the power cord, power on your computer, then boot to the floppy disk containing the AFU.exe file (see [Step 3](#)).
- 8** At the prompt, type `a:\afu update /c x`, where `x` is the controller number.
- 9** Insert the other floppy disks when prompted.
- 10** When the flash is complete, power off your computer, disconnect the power cord, then remove the jumper.
- 11** Close the computer cabinet, reconnect the power cord, then power on your computer.
The controller should boot correctly.

Understanding RAID

B

In this chapter...

RAID Technology Overview	65
RAID 0 (Non-RAID Arrays).....	65
RAID 1 Arrays	66
RAID 10 Arrays	66

When you create arrays (or logical drives), you can assign a RAID level to protect your data.

Each RAID level offers a unique combination of performance and redundancy. RAID levels also vary by the number of disk drives they support.

This appendix describes the RAID levels supported by your HostRAID controller, and provides a basic overview of each to help you select the best level of protection for your data storage.

RAID Technology Overview

RAID is the technology of grouping several *physical* drives into an *array* that you can define as one or more logical drives. Each *logical* drive appears to the operating system as a single drive. This grouping technique greatly enhances logical-drive capacity and performance beyond the physical limitations of a single physical drive.

When you group multiple physical drives into a logical drive, the HostRAID controller can transfer data in parallel from the multiple drives in the array. This parallel transfer yields data-transfer rates that are many times higher than with non-arrayed drives, allowing the system to better meet the *throughput* (amount of data processed in a given amount of time) or productivity needs of a multi-user network environment.

The ability to respond to multiple data requests provides not only an increase in throughput, but also a decrease in response time. The combination of parallel transfers and simultaneous responses to multiple requests allows disk arrays to provide a high level of performance in network environments.

Understanding Drive Segments

A drive segment is a disk drive or portion of a disk drive that is used to create an array. A disk drive can include both RAID segments (segments that are part of an array) and available segments. Each segment can be part of only one logical device at a time. If a disk drive is not part of any logical device, the entire disk is an available segment.

Stripe-Unit Size

With RAID technology, data is striped across an array of physical drives. This data-distribution scheme complements the way the operating system requests data.

The granularity at which data is stored on one drive of the array before subsequent data is stored on the next drive of the array is called the *stripe-unit size*.

You can set the stripe-unit size to 16, 32, or 64 KB. You can maximize the performance of your HostRAID controller by setting the stripe-unit size to a value that is close to the size of the system I/O requests. For example, performance in transaction-based environments, which typically involve large blocks of data, might be optimal when the stripe-unit size is set to 32 or 64 KB. However, performance in file and print environments, which typically involve multiple small blocks of data, might be optimal when the stripe-unit size is set to 16 KB.

The collection of stripe units, from the first drive of the array to the last drive of the array, is called a *stripe*.

RAID 0 (Non-RAID Arrays)

An array with RAID 0 includes two or more disk drives (maximum twelve) and provides data *striping*, where data is distributed evenly across the disk drives in equal-sized sections.

RAID 0 arrays do not maintain redundant data, so they offer no data protection. However, compared to an equal-sized group of independent disks, a RAID 0 array provides improved I/O performance.

Drive segment size is limited to the size of the smallest disk drive in the array. For instance, an array with two 250 GB disk drives and two 400 GB disk drives can create a RAID 0 drive segment of 250 GB, for a total of 1000 GB for the volume, as shown in the following figure.

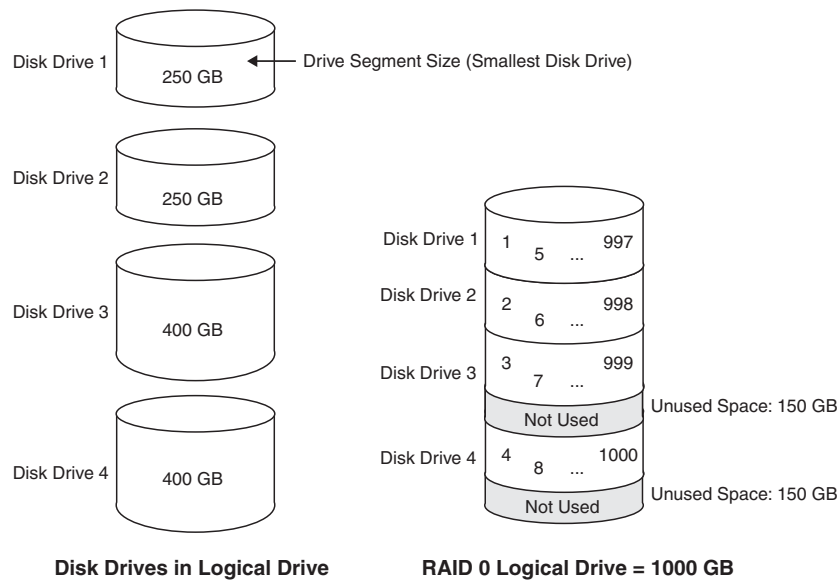

RAID 1 Arrays

A RAID 1 array is built from two disk drives, where one disk drive is a *mirror* of the other (the same data is stored on each disk drive). Compared to independent disk drives, RAID 1 arrays provide improved performance, with twice the read rate and an equal write rate of single disks. However, capacity is only 50 percent of independent disk drives.

If the RAID 1 array is built from different-sized disk drives, the free space, drive segment size is the size of the smaller disk drive, as shown in the following figure.

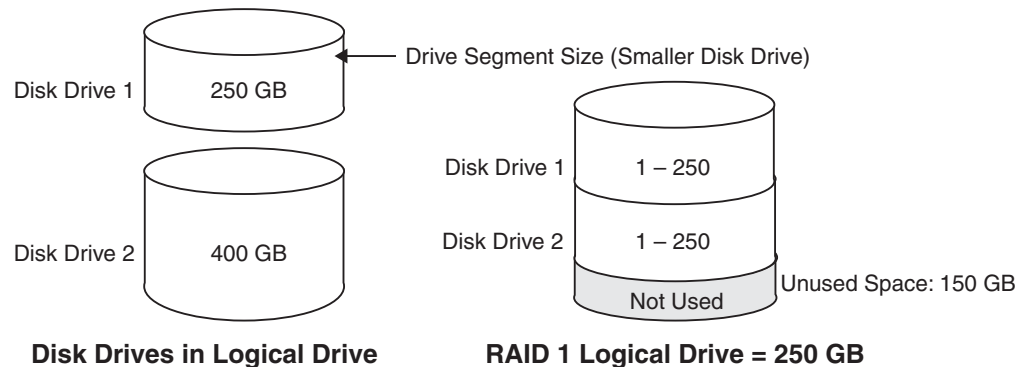

RAID 10 Arrays

A RAID 10 array is built from two or more equal-sized RAID 1 arrays. Adaptec RAID controllers support a maximum number of 48 disk drives in a RAID 10 array.

Data in a RAID 10 array is both striped and mirrored. Mirroring provides data protection, and striping improves performance.

Drive segment size is limited to the size of the smallest disk drive in the array. For instance, an array with two 250 GB disk drives and two 400 GB disk drives can create two mirrored drive segments of 250 GB, for a total of 500 GB for the array, as shown in the following figure.

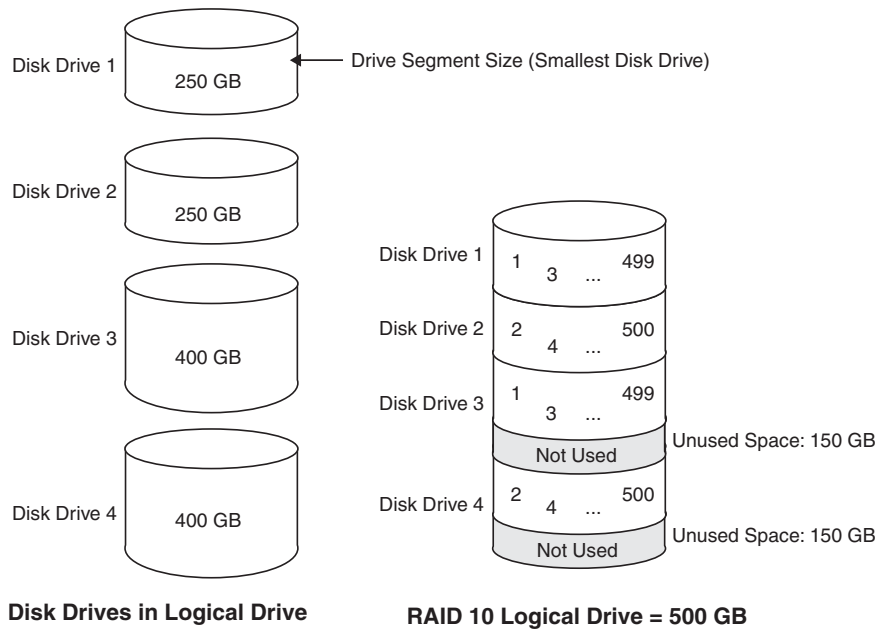

Selecting the Best RAID Level

Use this table to select the RAID levels that are most appropriate for the logical drives on your storage space, based on the number of available disk drives and your requirements for performance and reliability.

RAID Level	Redundancy	Disk Drive Usage	Read Performance	Write Performance	Built-in Hot Spare	Minimum Disk Drives
RAID 0	No	100%	www	www	No	2
RAID 1	Yes	50%	ww	ww	No	2
RAID 10	Yes	50%	ww	ww	No	4

Disk drive usage, read performance, and write performance depend on the number of drives in the logical drive. In general, the more drives, the better the performance.

Introduction to SAS



In this chapter...

Terminology Used in This Appendix	58
What is SAS?	58
How Do SAS Devices Communicate?	59
What's a Phy?	59
What's a SAS Port?.....	59
What's a SAS Address?.....	60
What's a SAS Connector?	60
What do SAS Cables Look Like?	60
How are Disk Drives Identified in SAS?	60
What are the SAS Connection Options?	61
How is SAS Different from Parallel SCSI?.....	62

This section provides a basic overview of the main features of SAS, introduces some common SAS terms, and explains how SAS differs from parallel SCSI.

Note: For technical articles and tutorials about SAS, refer to the SCSI Trade Association (STA™) Web site at www.scsita.org.

Terminology Used in This Appendix

For convenience, SAS HostRAID controllers are referred to generically in this appendix as SAS controllers, HBAs, disk drives, and external disk drive enclosures are referred to as *end devices* and expanders are referred to as *expander devices*.

For convenience, this chapter refers to end devices and expander devices collectively as SAS *devices*.

What is SAS?

Legacy parallel SCSI is an interface that lets devices such as computers and disk drives communicate with each other. Parallel SCSI moves multiple bits of data *in parallel*, using the SCSI command set.

SAS is an evolution of parallel SCSI to a point-to-point serial interface. SAS also uses the SCSI command set, but moves multiple bits of data one at a time. SAS links end devices through direct-attach connections, or through expander devices.

SAS controllers can typically support up to 128 end devices and can communicate with both SAS and SATA devices. You can add 128 end devices or even more with the use of SAS expanders. For more information, see [SAS Expander Connections on page 61](#).

Although you can use both SAS and SATA disk drives in the same SAS *domain*, Adaptec recommends that you not combine SAS and SATA disk drives within the same array or logical drive. The difference in performance between the two types of disk drives may adversely affect the performance of the array.

Data can move in both directions simultaneously across a SAS connection (called a *link*—see next section). Link speed is 600 MB/sec in full-duplex mode. A SAS controller with eight links has a maximum bandwidth of 4800 MB/sec in full-duplex mode.

Although they share the SCSI command set, SAS is conceptually different from parallel SCSI physically, and has its own types of connectors, cables, connection options, and terminology, as described in the rest of this chapter.

To compare SAS to parallel SCSI, see [page 62](#).

How Do SAS Devices Communicate?

SAS devices communicate with each other through links. A *link* is a physical connection between two phys.

As shown in the following figure, SAS devices contain ports which contain *phys* (see next section), and each phy contains one transmitter and one receiver (one transceiver). A phy can belong to one port only.

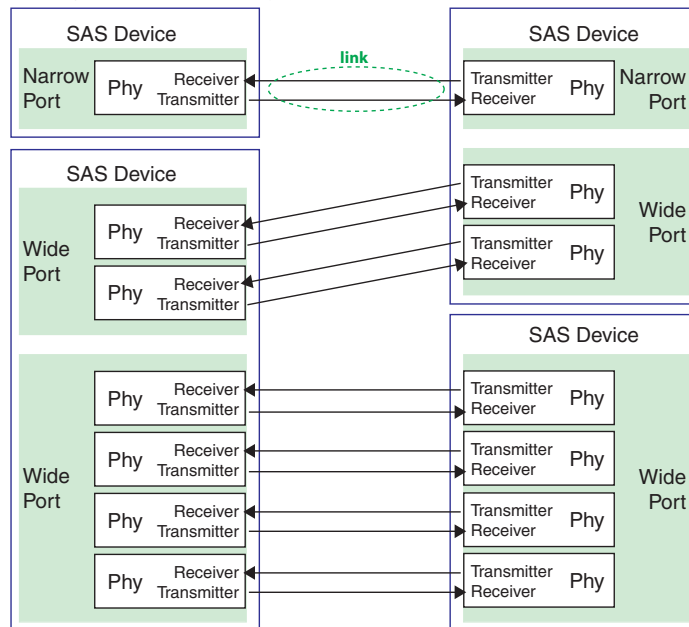

What's a Phy?

Phys are part of the physical communication connection between SAS devices. Each phy contains a transceiver that sends data back and forth between SAS devices.

When a connection is formed between two end devices, a link is established from a phy in one port to a phy in the other port. As shown in the figure above, a wide port can support multiple independent links simultaneously.

Phys are internal, within SAS connectors (see [page 60](#)).

SAS cables physically connect one or more phys on one SAS device to one or more phys on another SAS device.

What's a SAS Port?

Note: Because the physical link between SAS devices is from phy to phy, rather than port to port, a *port* is more of a virtual concept, different from what is normally considered a port on other types of RAID controllers and storage devices.

A *port* is one or more phys. A *narrow port* contains one phy. A *wide port* typically contains four phys.

Each port has its own unique SAS address (see [page 60](#)), and all the phys in a port share that same SAS address.

SAS controller port options vary. A SAS controller with four phys could be configured with one wide port, with two wide ports that comprise two phys, or with four narrow ports each containing one phy. (A wide port with four phys is referred to as a *4-wide* or *4x* port.)

What's a SAS Address?

Each SAS port is identified with a unique SAS address, which is shared by all phys on that port.

For example, a SAS disk drive might have two narrow ports. Each port has one unique SAS address. The single phy in each port uses its port's SAS address.

In another example, a SAS device might have one 4-wide port. That port has one SAS address, which is shared by all four phys in the port.

Unlike SCSI devices and SCSI IDs, SAS devices self-configure their SAS addresses. User intervention is not required to set SAS addresses, and SAS addresses cannot be modified.

What's a SAS Connector?

A SAS or mini-SAS connector is the physical plug or receptacle that you see on a SAS device. It supports the power and signal line cable. It's what you plug a SAS cable into, or the end of the SAS cable that's being plugged in.

A connector is what forms physical links between phys. Some SAS connectors can support multiple links. The number of links a SAS connector can support is referred to as its *width*. *Narrow* connectors support a single link; *wide* connectors support up to four links.

A single SAS device may have one or more connectors. You can use a single SAS connector to inter-link more than two SAS devices. For example, in the figure on [page 59](#), the 4-wide internal SAS connector forms links with four independent disk drives.

Mini-SAS connectors support both internal and external SAS connections. The mini-SAS connectors are smaller than the standard SAS internal and external connectors. Mini-SAS connectors support single and multilinks with the ability to scale to future speed needs.

What do SAS Cables Look Like?

Internal SAS cables are narrower than internal parallel SCSI cables. The connectors vary in size depending on the number of links they support, from single link connectors to 4-wide (or larger) connectors. Internal fan-out cables let you connect four disk drives to a single 4-wide connector.

For an example of some internal SAS or mini-SAS cables and an external SAS cable, see [Selecting SAS Cables on page 28](#).

How are Disk Drives Identified in SAS?

In the BIOS and in the management utilities, disk drives are identified with numbers in this format:

XX:YY:ZZ

where *XX* is the disk drive count number, *YY* is the enclosure number, and *ZZ* is the slot number (within the enclosure). If the disk drive is not installed in an enclosure, a double dashes (--) appear instead of *YY* and *ZZ* (for instance, 01:--:--).

In parallel SCSI, *XX* is the disk drive's channel number, *YY* is the target number, and *ZZ* is the logical unit number (LUN).

What are the SAS Connection Options?

You can connect end devices to each other through direct cable connections and through backplane connections. When you use one or more expander devices (see [page 61](#)), you can create large configurations.

Direct-Attach Connections

In a direct-attach connection, SAS or SATA disk drives are connected directly to a SAS controller with SAS cables. One disk drive is connected to one SAS connector with one SAS cable or multiple disk drives are connected to one SAS connector with one fan-out cable. The figure on [page 31](#) shows an example of direct-attach connections.

The number of direct-connected disk drives is limited to the number of phys supported by the SAS controller.

Note: There may be multiple phys within a single connector. See [page 60](#).

Backplane Connections

In a backplane connection, disk drives and SAS controllers are connected to and communicate with each other through a system backplane. The figure on [page 31](#) shows an example of backplane connections.

There are two types of backplane connections, *passive* and *active*. When connecting to either backplane, it's important to properly connect your disk drive LEDs in order to identify disk drive conditions. See [About Your HostRAID Controller on page 14](#) for your RAID controller Activity LED connections and locations.

When connecting to a backplane, the Adaptec Storage Manager enables you to manage your system disk drives, see [Next Steps on page 34](#).

The number of end devices is limited to the number of slots available on the backplane. For example, the Adaptec S50 enclosure, which contains an expander, is a backplane connection that supports up to 12 SAS or SATA disk drives.

Some backplanes support daisy-chain expansion to other backplanes. For example, you can daisy-chain up to nine Adaptec S50 enclosures to a single SAS controller in a host system.

SAS Expander Connections

A SAS expander device literally expands the number of end devices that you can connect together. Expander devices, typically embedded into a system backplane (see [page 31](#)), support large configurations of SAS end devices, including SAS controllers and SAS and SATA disk drives. With expander devices, you can build large and complex storage topologies.

There are two types of SAS expanders: *fanout expanders* and *edge expanders*. Each performs a different role in a storage system. (For more information about how SAS expanders work, refer to the STA Web site at www.scsita.org.)

You can connect up to 128 SAS ports to an edge expander. (A single edge expander can therefore support up to 128 SAS addresses.)

You can connect up to 128 edge expanders to a fanout expander.

You can use only one fanout expander in any single SAS domain (a topology of SAS—and possibly SATA—end devices and expander devices). A single SAS domain can therefore comprise up to 16,384 SAS ports (and therefore up to 16,384 SAS addresses).

The following figure illustrates (in very basic terms) a SAS domain and shows how SAS controllers, SAS and SATA disk drives, and expander devices can fit together in a large data storage topology.

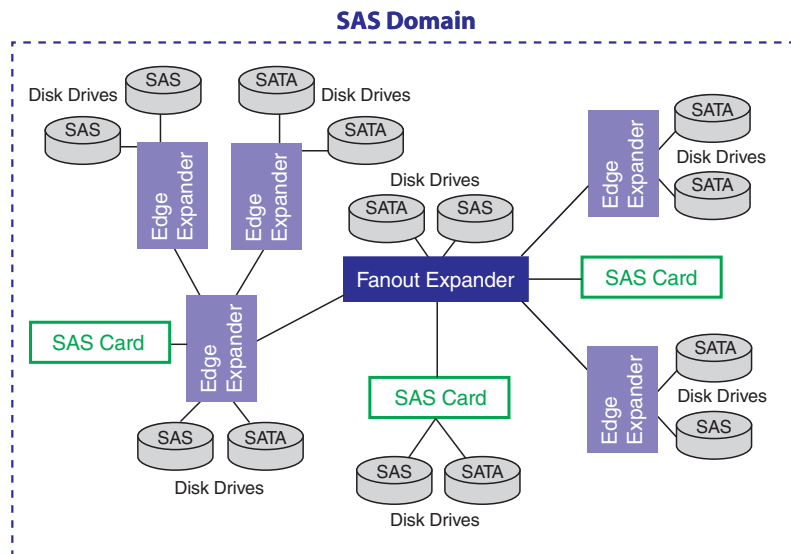

How is SAS Different from Parallel SCSI?

In summary, although SAS and parallel SCSI use the SCSI command set, how they move data from one place to another is very different. To support point-to-point *serial* data transport, SAS introduces new types of connectors, cables, connection options, and terminology.

Generally speaking, SAS is faster and more flexible than parallel SCSI, and provides more options for building your storage space. SAS lets you mix SAS and SATA disk drives together, and lets you connect many, *many* more devices.

The following table describes many of the main differences between the two interfaces.

Parallel SCSI	Serial Attached SCSI
Parallel interface	Serial interface
Maximum speed 320 MB/sec shared by all devices on the bus	Maximum speed 600 MB/sec per phy when in full-duplex mode
Supports SCSI devices only	Supports SATA and SAS disk drives simultaneously
Up to 16 devices per SCSI channel	More than 128 disk drives per SAS controller, using an expander (see page 61)
Supports single-port devices only	Supports single- and dual-port devices
Uses SCSI IDs to differentiate between devices connected to the same adapter	Uses unique SAS addresses to differentiate between devices

Parallel SCSI	Serial Attached SCSI
User intervention required to set SCSI IDs	SAS addresses self-configured by SAS devices
Requires bus termination	Requires no bus termination
Standard SCSI connectors	SAS connectors (see page 28)

C

Using the ARC Utility

In this chapter...

Introduction to the ARC Utility	69
Running the ARC Utility.....	69
Creating and Managing Arrays.....	69
Using SerialSelect	73
Using SATASelect.....	75
Formatting and Verifying Disk Drives	76

The Adaptec RAID Configuration (ARC) utility is an embedded BIOS-based utility that you can use to create, configure, and manage arrays, and format or verify disk drives.

Note: Adaptec recommends that only advanced users familiar with working in a computer BIOS use the ARC utility tools.

Introduction to the ARC Utility

The ARC utility comprises these tools:

- **The Array Configuration Utility (ACU)**—Used to create, configure, and manage arrays, and initialize and rescan disk drives.
- **SerialSelect Utility (for SAS HostRAID controllers) or SATASelect Utility (for SATA HostRAID controllers)**—Used to change device and HostRAID controller settings.
- **Disk Utilities**—Used to format or verify disk drives (see [page 76](#)).

Running the ARC Utility

All the tools within the ARC utility are menu-based and instructions for completing tasks display on-screen. Menus can be navigated using the arrows, Enter, Esc, and other keys on your keyboard.

To run the Utility:

- 1 Start or restart your computer. When prompted, press **Ctrl+A**.

The ARC utility menu displays presenting these options:

- Array Configuration Utility (ACU)
- SerialSelect or SATASelect Utility (depending on whether you are using a SAS or a SATA HostRAID controller)
- Disk utilities

To select an option from this menu, or from any of the menus within the ARC utility setup, browse with the arrow keys, then press **Enter**. In some cases, selecting an options displays another menu. To return to the previous menu at any time, press **Esc**.

Creating and Managing Arrays

Before creating arrays, make sure the disks for the array are properly connected and installed in your system. Note that disks with no usable space are shown in gray and cannot be used.

Creating a New Array

To create an array:

- 1 Select **Create Array** from the main ACU menu.

Note: For more information about RAID levels and using disk drives to create arrays, see [Understanding RAID on page 64](#).

- 2 Select the disks for the new array, then press **Insert**. To deselect any disk, highlight the disk, then press **Delete**.
- 3 Press **Enter** when all disks for the new array are selected. The Array Properties menu displays.

Assigning Array Properties

Once the array is created and its properties are assigned, you cannot change the array properties using the ACU. Instead, use Adaptec Storage Manager. See [About Adaptec Storage Manager on page 51](#), for details.

To assign properties to the new array:

- 1 In the Array Properties menu, select an array type, then press **Enter**.
Only the available array types, RAID 0, 1, and 10 are displayed. RAID 0 and 1 requires two to four drives. RAID 10 requires a minimum of four disk drives.
- 2 (Optional). Type a label of no more than 15 characters for the array, then press **Enter**.
- 3 For RAID 0, select the desired stripe size. Available stripe sizes are 16, 32, and 64 KB (default).

Note: It is recommended that you do not change the default.

- 4 The options under **Create RAID Via** allows you to select between the different creation methods for RAID 0, 1, and 10. The following table gives examples of when each is appropriate.

RAID Level	Create RAID Via	When Appropriate
RAID 0	Quick Init	Creating a RAID 0 on new drives.
RAID 0	Migrate	Creating a RAID 0 and you want to preserve data on an existing drive. You will be asked to select the source drive. The contents of the source drive are preserved and any data on the new drive is lost.
RAID 1	Build	Creating a RAID 1 and you want to preserve data on an existing simple volume. You will be asked to select the source drive. The contents of the source drive are preserved and any data on the new drive is lost.
RAID 1, 10	Clear	Creating a RAID 1 or 10 on new drives, or when you want to ensure that the new array contains no existing data.
RAID 1, 10	Quick Init	Fastest way to create a RAID 1 or 10. Appropriate when using a new drive.

- Before adding a new drive to an array, back up any data contained on the new drive. Otherwise, all data will be lost.
- Only disk drives that were previously configured as simple volumes can be used for RAID 0 or 1 migration when the single/source drive has data on it. See [Configuring Disk Drives on page 73](#) to create a simple volume.
- If you stop the build or clear process on a RAID 1 from ACU, you can restart it by pressing **Ctrl+R**.
- A RAID 1 and 10 created using the Quick Init option may return some data mismatches if you later run a consistency check. This is normal and is not a cause for concern.
- If you stop the migration process on a RAID 0, you can restart it by pressing **Ctrl+R**.
- To modify the Write Cache setting for an array, press **Ctrl+W**.

- The ACU allows you to use drives of different sizes in a RAID 1 or RAID 0. However, during a build operation, only the smaller drive can be selected as the source drive.
 - When migrating from single volume to RAID 0, migrating from a larger drive to a smaller drive is allowed. However, the destination drive must be at least half the capacity of the source drive.
 - It is not recommend that you migrate or build an array on Windows dynamic disks (volumes), as it will result in data loss.
- 5 When you are finished, press **Done**.

Managing Arrays

Select the **Manage Arrays** option to perform these tasks:

- [Rebuilding Arrays](#) (next section)
- [Viewing Array Properties on page 71](#)
- [Deleting Arrays on page 72](#)
- [Enabling/Disabling Write Cache on page 72](#)

Rebuilding Arrays

Note: Rebuilding applies to Fault Tolerant arrays (RAID 1) only.

By replacing a failed drive of a RAID 1 array with a new drive, you can rebuild to get the array to Optimal status and assume fault tolerance. You can perform a rebuild in the following ways:

Note: If no spare exists and a hard disk drive fails, you need to create a spare before you can rebuild an array. See [Adding/Deleting Hot Spares on page 72](#) before continuing your rebuild.

- **System Shutdown Rebuild**

You can power off the computer and replace the failed drive with a new one (of equal or greater capacity). When the system is booted, you can assign the new drive as a spare, and this will start the Rebuild task. All the data from the good drive is copied to the new one, and the original RAID 1 array is recreated.
- **Manual Rebuild**
 - a** From the Main Menu, select **Manage Arrays**. From the List of Arrays, select the array you want to rebuild.
 - b** Press **Ctrl+R** to rebuild.

Viewing Array Properties

To view the properties of an existing array:

- 1 From the ACU menu, select **Manage Arrays**.
- 2 From the List of Arrays dialog box, select the array you want to view, then press **Enter**.

The Array Properties dialog box appears, showing detailed information on the array. The physical disks associated with the array are displayed here.

- 3 Press **Esc** to return to the previous menu.

Deleting Arrays

 **Caution:** Back up the data on an array before you delete it. Otherwise, all data on the array is lost. Deleted arrays cannot be restored.

To delete an existing array:

- 1 From the ACU menu, select **Manage Arrays**.
- 2 Select the array you wish to delete, then press **Delete**.
- 3 In the Array Properties dialog box, select **Delete**, then press **Enter**.

For RAID 1 and 10 arrays:

 **Warning:** Deleting the array will render array unusable. Do you want to delete the array? (Yes/No):

For RAID 0 arrays:

 **Warning:** Deleting the array will result in data loss! Do you want to delete the array? (Yes/No):

- 4 If you press **Yes**, select the member:
To delete the partition table, choose the member:
member #0, member #1, both, none
- 5 Press **Esc** to return to the previous menu.

Enabling/Disabling Write Cache

To Enable/Disable Write Cache for an array:

- 1 From the Main menu, select **Manage Arrays**.
- 2 From the List of Arrays, select the array you want to modify the Write Cache setting for, then press **Ctrl+W**. A confirmation dialog appears to modify setting. Press **Y** to change the current Write Cache setting.

Note: Write Cache is disabled by default when creating all array types. The disk operation may be very slow with Write Cache off.

Adding/Deleting Hot Spares

Select the **Add/Delete Hot Spares** option to add, delete, or view hot spares.

- 1 From the ACU menu, select **Add/Delete Hot Spares**.
- 2 Use the up and down arrow keys to highlight the disk you want to designate as a hot spare, then select **Insert>Enter**.
- 3 Press **Yes** when the following prompt is displayed:
Do you want to create spare? (Yes/No)
The Spare you have selected appears in the Selected Drive menu.

Managing Bootable Arrays and Devices

Select the **Manager Boot Unit** option to add or remove a bootable array or single drive.

- 1 From the ACU menu, select **Manage Boot Unit**.
- 2 Use the up and down arrow keys to highlight the array or single drive you want to designate as a bootable device, then select **Insert>Enter**.

Note: Adaptec 1225SA controller does not support bootable devices.

Configuring Disk Drives



Caution:

- If the drive is used in an array, you may not be able to use the array again. Do not configure a drive that is part of a boot array. To determine which drives are associated with a particular array, see [Viewing Array Properties on page 71](#).
- The partition table on the disk will be deleted when deleting a simple volume.

To configure drives:

Note: Configuring disk drives makes a simple volume. A simple volume can be managed like normal arrays by using the **Manage Arrays** option on your **Main** menu.

- 1 From the menu, select **Configure Drives**.
- 2 Use the up and down arrow keys to highlight the disk you wish to configure, then press **Insert**.
- 3 Repeat the previous step, if you want to add another drive to be configured.
- 4 Press **Enter**.
- 5 Read the warning message and ensure that you have selected the correct disk drives to configure. Type **Y** to continue.

ATAPI Support

The following devices are supported:

- The 1225SA and 1220SA supports detection of SATA ATAPI TAPE Drive and CDROM.
- The 1225SA and 1220SA supports booting from the ELTORITO bootable CD/DVD media.

If a bootable CD/DVD media is detected, that bootable media gets precedence in the booting order.

Using SerialSelect

The *SerialSelect* utility allows you to change the BIOS and SAS HostRAID controller and device settings without opening the computer cabinet.

For more information, see [SerialSelect Options on page 74](#).

To access *SerialSelect*:

- 1 Restart the computer, then press **Ctrl+A** when prompted to access the ARC utility.
- 2 If multiple HostRAID controllers are installed, select the HostRAID controller you want to configure, then press **Enter**.
- 3 From the ARC menu, select **SerialSelect Utility**.
- 4 To select a menu option, browse with the arrow keys to the option, then press **Enter**. In some cases, selecting an option displays another menu. You can return to the previous menu at any time by pressing **Esc**.
- 5 To restore the original *SerialSelect* default values, press **F6** from within the SAS Driver and Controller Configuration screens.
- 6 To exit *SerialSelect*, press **Esc** until a message prompts you to exit (if you changed any settings, you are prompted to save the changes before you exit).
- 7 At the prompt, select **Yes** to exit, then press any key to restart the computer. Any changes you made in *SerialSelect* take effect after the computer restarts.

SerialSelect Options

The following table lists the available and default settings for each *SerialSelect* option and the description of each option. The default settings are appropriate for most systems and appear in bold type in the table. Adaptec recommends that you do not change the settings.

SerialSelect Options	Available Settings	Description
Controller Configuration		
Runtime BIOS	Enabled Disabled Disabled:Scan bus	Controls the state of the BIOS at POST time. When Enabled , the HostRAID controller BIOS allows the controller to act as a bootable device. Disabling the BIOS allows another suitable HostRAID controller to act as the boot device.
BBS Support	Device Controller	When BBS support is set to Device base, the system's BIOS will list each connected bootable device to the HostRAID controller as an individual entry. When BBS support is set to Controller base, the system's BIOS will only list the HostRAID controller in the system boot order. This is useful in a multi-HostRAID controller configuration.
RAID Support	Enabled Disabled	When there are active arrays in the system, will not allow you to Disable RAID support.
POST Banner Display	Enabled Disabled	When Enabled , the Adaptec banner, version, and copyright is displayed. When Disabled, the Adaptec banner, version, and copyright is not displayed.
CTRL-A Message	Enabled Disabled	When set to Enabled , the SAS HostRAID controller BIOS displays the Press <Ctrl> <A> for ARC Utility message on your screen during system bootup. If this setting is disabled, you can still invoke the ARC utility by pressing Ctrl+A after the SAS HostRAID controller BIOS banner appears.

SerialSelect Options	Available Settings	Description
Physical Drives Display during Post	Enabled Disabled	When Enabled , connected physical devices are displayed during system POST. Displaying the devices adds a few seconds to the overall POST time.
PHY Configuration		
PHY Rate	Auto , 1.5, 3.0	The data transfer rate between the HostRAID controller and devices. The default setting is Automatic , which allows the SAS HostRAID controller to adjust the speed as needed.
SAS Address	0-F	Specifies the last digit of a 64-bit SAS address of the HostRAID controller, device, and each port using a globally unique worldwide name (WWN) identifier.
Controller Properties		
PCI Slot: Bus: Device:Function	None	Displays the path of the storage devices in a Host RAID controller.
Interrupt (IRQ) Channel	None	Displays interrupt
I/O Port Address	None	Displays I/O port address
Device ID	None	Displays device ID
Controller Serial Number	None	Displays controller serial number
Controller WWN	None	Displays the controller WWN

Using SATASelect

The *SATASelect* utility allows you to change the BIOS and SATA HostRAID controller and device settings without opening the computer cabinet.

To access *SATASelect*:

- 1 Restart the computer, then press **Ctrl+A** when prompted to access the ARC utility.
- 2 If multiple HostRAID controllers are installed, select the HostRAID controller you want to configure, then press **Enter**.
- 3 From the ARC menu, select **SATASelect Utility**.
- 4 To select a menu option, browse with the arrow keys to the option, then press **Enter**. In some cases, selecting an option displays another menu. You can return to the previous menu at any time by pressing **Esc**.
- 5 To restore the default *SATASelect* values, press **F6** from within the SATA Driver and Controller Configuration screen.
- 6 To exit *SATASelect*, press **Esc** until a message prompts you to exit (if you changed any settings, you are prompted to save the changes before you exit).
- 7 At the prompt, select **Yes** to exit, then press any key to restart the computer. Any changes you made in *SATASelect* take effect after the computer restarts.

SATASelect Options

The following table lists the available and default settings for each SATASelect option and the description of each option. The default settings are appropriate for most systems and appear in bold type in the table. Adaptec recommends that you do not change the settings.

SATASelect Options	Available Settings	Description
Controller Configuration		
Runtime BIOS	Enabled Disabled Disabled:Scan bus	Controls the state of the BIOS at POST time. When Enabled , the HostRAID controller BIOS allows the controller to act as a bootable device. Disabling the BIOS allows another suitable HostRAID controller to act as the boot device.
BBS Support	Device Controller	When BBS support is set to Device base, the system's BIOS will list each connected bootable device to the HostRAID controller as an individual entry. When BBS support is set to Controller base, the system's BIOS will only list the HostRAID controller in the system boot order. This is useful in a multi-HostRAID controller configuration.
Physical Drives Display during Post	Enabled Disabled	When Enabled , connected physical devices are displayed during system POST. Displaying the devices adds a few seconds to the overall POST time.
SATA Configuration		
Write Cache	Enabled Disabled	Enables or disables write cache on the on legacy and non-configured drives. Write cache enabled provides maximum performance. Default is Yes to enable.
DMA (1420SA only)	Enabled Disabled	Enables or disables the use of Direct Memory Access (DMA) mode for the drive. Enabled provides maximum performance. Default is Yes to enable.
Device Security Lock (1430SA & 1220SA Only)	Enabled Disabled	Enables or disables the device security lock option. When enabling this option, a Security Freeze Lock command is issued to the device.
SMART	Enabled Disabled	Enables or disables the predictive failure feature of the disk drive. When enabled the SMART status of the drive (Healthy or Failed) will be displayed along with the physical drive display during POST. If the drive does not support SMART, the SMART status is not displayed. Default is Yes to enable.
Allow Read Ahead	Enabled Disabled	Enables or disables the read ahead cache algorithm on the drive. Enabled provides maximum performance under most circumstances. Default is Yes to enable.

Formatting and Verifying Disk Drives

You can use the disk utilities to low-level format or verify your disk drives. (New disk drives are low-level formatted at the factory and do not need to be low-level formatted again.).

 **Caution:** Before you format a disk drive, back up all data. Formatting destroys all data on a disk drive.

To use the disk utilities:

- 1 Turn on your computer and press **Ctrl+A** when prompted to access the ARC utility.
- 2 From the ARC utility menu, select **Disk Utilities**.
- 3 Select the desired disk, then press **Enter**.
 - **Format Disk**—Simulates a low-level format of the disk drive by writing zeros to the entire disk. SATA drives are low-level formatted at the factory and do not need to be low-level formatted again.
 - ⚠ **Caution:** Formatting destroys all data on the disk. Be sure to back up your data before performing this operation.
 - **Verify Disk Media**—Scans the media of a disk drive for defects.

Locating Disk Drives

Note: This feature is only available with disk drives that have an activity LED.

You can use the Identify Drive feature to physically locate a disk drive by blinking the LED.

To locate a disk drive:

- 1 Start the ARC utility (see [page 69](#)).
- 2 Select the controller you want, then press **Enter**.
- 3 Select **Disk Utilities**.
- 4 Select the disk drive you want, then press **Enter**.
- 5 Select **Identify Drive**, then press **Enter**.
- 6 When you have finished locating your disk drive, press any key to stop the blinking.

Identifying Disk Drives

You can identify disk drives by viewing the list of disk drives on your system. Only physical drives that display during POST are shown.

To identify a disk drive:

- 1 Start the ARC utility (see [page 69](#)).
- 2 Select the controller you want, then press **Enter**.
- 3 Select **Disk Utilities**.

The Disk Utilities view will provide you with the following information:

Location	Model	Rev#	Speed	Size
CN1=DEV1 Box0=Slot0 Exp0=phy0	The manufacturer information.	The revision number of the disk drive.	The speed of the disk drive.	The size of the disk drive.

The location information of a disk drive is determined by three types of connections:

- Direct attached drives—The connection is determined by the cable connected to a device, for example CN1 (connector 1) is connected to DEV1 (device 1). For more information, see [Direct-Attach Connections on page 61](#).
- Storage Enclosure Processor (SEP) managed devices—The connection is determined by an active backplane. Box0 (enclosure 0) is connected to slot0 (disk drive slot 0 in the enclosure). For more information, see [Backplane Connections on page 61](#).
- Expanders—The connections is determined by an expander. Exp0 (expander 0) is connected to phy0 (phy 0 within a connector). For more information, see [SAS Expander Connections on page 61](#).

Note: Devices other than disk drives (CDROM, tape drives, etc...) are listed in order after your system disk drives.

Viewing the Event Log

The BIOS-based event log records all firmware events, such as configuration changes, array creation, and boot activity.

Some events are not stored indefinitely—the event log is cleared of any non-persistent events each time you restart your computer; additionally, once the log is full, new events overwrite old events.

To view the event log:

- 1 Start the utility (see [page 69](#)).
- 2 Select the controller you want, then press **Enter**.
- 3 When the utility menu appears, then press **Ctrl+P**.
- 4 Select **Controller Log Information**, then press **Enter**.



Using the Adaptec Flash Utility for DOS

In this Appendix...

Introduction	80
System Requirements	80
Compatibility Information	80
Before You Begin	80
Running the AFU	81
AFU Commands.....	82
Updating Flash Using AFU Command Line.....	85

This Appendix describes how to use the Adaptec Flash Utility (AFU), a text-based DOS utility that you can use to update, save, or verify the HostRAID controller's firmware BIOS.

 **Caution:** Although the AFU contains safeguards to prevent you from accidentally damaging your HostRAID controller's flash contents, it is still important to use the AFU carefully and correctly to avoid rendering your HostRAID controller inoperable. Adaptec recommends that only advanced users familiar with working in DOS use the AFU.

Introduction

The AFU is a text-based DOS utility used to update, save, or verify your HostRAID controller's firmware BIOS and Non-Volatile Random Access Memory (NVRAM).

The AFU is easy to use and contains safeguards to prevent you from accidentally damaging the HostRAID controller's flash contents. Still, you must be careful to use the AFU correctly, otherwise, you could render the HostRAID controller inoperable.

System Requirements

The requirements for AFU are as follows:

- MS-DOS version 5.0 or later. It cannot run from a DOS command prompt window under any version of Windows.

Note: You can't run the AFU from a DOS command prompt window under any version of Windows.

- At least 8 MB of extended memory.

Compatibility Information

The AFU has the following compatibility issues:

- Supports HIMEM.SYS and is compatible with other DOS drivers running under HIMEM.SYS (for example, SMARTDRV.SYS and SETVER.SYS).
- Does not support DOS extenders installed in memory, such as EMM386.SYS and DOS4GW.

Before You Begin

Before running the AFU, complete these tasks:

- *Obtaining the Firmware on page 80*
- *Creating the Firmware Kit On Floppy Disks on page 81*

Obtaining the Firmware

To obtain HostRAID controller firmware, go to:

The HostRAID Installation CD—Includes the AFU executable (AFU.exe) and a separate flash image. The flash image may comprise multiple User Flash Image (UFI) files.

The Adaptec Web site (www.adaptec.com)—Download a new firmware file to get the most recent version of AFU.

Creating the Firmware Kit On Floppy Disks

To create the firmware floppy disks:

- 1 Create a bootable MS-DOS floppy disk and copy these files to it:
 - AFU.exe
 - Axxxx01.ufi

where xxx is the model number of your controller.

Note: Most controller model numbers have a suffix. Check that the .ufi file is the correct file for your controller before copying.

- 2 Copy each additional Axxxx0x.ufi file to a separate floppy disk. (Some RAID controllers have one UFI file; some have two. Each goes onto its own floppy disk.

Running the AFU

You can run the AFU using:

- [Running the Menu-Based AFU](#) (next section)
- [Running the AFU from the Command Line](#) on page 82

Running the Menu-Based AFU

The easy way to run the AFU is to use its GUI. If you prefer to run the AFU from the command line, see [Running the AFU from the Command Line](#) on page 82.

To access the AFU:

- 1 Shut down your operating system and reboot to DOS from a bootable MS-DOS floppy disk or from a DOS partition on a bootable drive. You can use the drive connected to the HostRAID controller you are updating.

Note: When updating the HostRAID controller flash, controller activity is not possible. Before you can use the HostRAID controller again, complete the flash operation and restart the computer.

- 2 At the DOS command prompt (typically A:\>) type `AFU`, then press **Enter**.

The AFU's main menu is displayed.

- 3 Select **Select Controllers**, then select the Adaptec HostRAID controllers to be flashed. When selecting a single controller, the system automatically selects it. When selecting multiple controllers, use the spacebar, then press **Enter**.

- 4 Select **Select an Operation** and choose one of these options, then follow the on-screen instructions.
 - **Update**—Updates all the flash components on a HostRAID controller with the flash image data from a User Flash Image (UFI) file. The AFU updates the HostRAID controller's flash by reading UFI files and writing them to the controller's flash components.

Note: The UFI includes the HostRAID controller's type, thereby ensuring that the AFU uses the correct file.
 - **Save**—Updates and verifies the BIOS image of the HostRAID controller.
 - **Verify**—Reads the contents of a HostRAID controller's flash components and compares it to the contents of the specified UFI file.
 - **Version**—Displays version information about a HostRAID controller's flash components.
 - **List**—Lists all supported HostRAID controllers detected in your system.

Running the AFU from the Command Line

At the DOS command prompt (typically A:\>), type `AFU` followed by a command and any switches. The AFU processes the command, prompts you to insert additional floppy disks as needed, exits, and reports success or an error message code. The available commands are summarized in alphabetical order.

AFU Commands

You can manage your HostRAID controller's BIOS firmware using these commands:

- [HELP](#) (next section)
- [LIST](#) on page 83
- [SAVE](#) on page 83
- [UPDATE](#) on page 84
- [VERIFY](#) on page 84
- [VERSION](#) on page 85

HELP

The `HELP` command displays a summary of AFU functions and command switches.

Examples

The following are examples of command syntax that will work to get help:

```
A:\> AFU HELP
```

```
A:\> AFU /?
```

LIST

The `LIST` command displays the AFU-supported HostRAID controllers installed on your computer. Use this command to see which HostRAID controllers are installed, or to identify the ID numbers assigned to each physical controller.

You do not have to restart the computer after completing this command.

Example

This example shows a typical system response to a `LIST` command:

```
A:\> AFU LIST

Adaptec Flash Utility V1.0-0 B1406
(c)Adaptec Inc. 1999-2005. All Rights Reserved.
Controllers Detected and Recognized:
Controller #0 (03:01:00) Adaptec ASC-48300
```

SAVE

The `SAVE` command saves the contents of a HostRAID controller's flash in a UFI file. The name of the UFI file is based on the HostRAID controller type and cannot be changed.

Command Syntax

The command syntax for the `SAVE` command is as follows:

```
AFU SAVE [/C<Controller ID>] [/D <UFI File Path>]
```

Command Switches

The following switches are available:

- `/C <Controller ID>` is one or more HostRAID controller IDs representing the set of controllers on which to perform the specified command. The default is 0, which means that if the computer has multiple HostRAID controllers, the AFU defaults to controller 0 unless you specify otherwise.

To specify a single HostRAID controller ID, for example: `/C 0`

To specify multiple IDs separated by commas, for example: `/C 0,2`

To represent all HostRAID controllers: `ALL`

Note: If you are using multiple HostRAID controllers, you must specify the controller you want by using the `/C` switch; otherwise, the AFU displays an error message and exits. You cannot select `ALL` HostRAID controllers when specifying `SAVE`.

- `/D <UFI File Path>` specifies the path (drive and directory) where the UFI files are located. If you do not specify the `/D` switch, the AFU looks for, or creates, UFI files in the default location.

Note: You cannot specify the name of a UFI file, only its path. UFI filenames are predefined, based on the HostRAID controller type.

Examples

In the following example, the AFU saves flash contents from HostRAID controller 0 to a UFI file in the current default drive and directory:

```
A:\> AFU SAVE /C 0
```

In the following example, the AFU saves flash contents from Controller 1 to a UFI file in C:\UFI_FILES.

```
A:\> AFU SAVE /C 1 /D C:\UFI_FILES
```

UPDATE

The UPDATE command updates a HostRAID controller's flash components from the flash image data in a UFI file. You can use the UPDATE command to update a single HostRAID controller's flash components or to update multiple HostRAID controllers on your computer.

You must restart the computer following an UPDATE command.

Command Syntax

The command syntax for the UPDATE command is as follows:

```
AFU UPDATE [/C<Controller ID>] [/D <UFI File Path>]
```

Command Switches

For details on the /C and /D switches, see [SAVE on page 83](#).

Examples

The following example shows a typical system response after an update has been performed:

```
A:\> AFU UPDATE /C 0

Adaptec Flash Utility V1.0-0 B1406
(c)Adaptec Inc. 1999-2005. All Rights Reserved.
Updating Controller 0 (Adaptec ASC-48300)
Reading flash image file (Build 1406)
AFU is about to update firmware on controller(s) Adaptec ASC-48300
***PLEASE DO NOT REBOOT THE SYSTEM DURING THE UPDATE***
This might take a few minutes.
Writing Adaptec ASC-48300 (4MB) Flash Image to controller 0...OK.
Verifying...OK
Please restart the computer to allow firmware changes to take effect.
```

VERIFY

The VERIFY command compares the contents of each of the flash components on a HostRAID controller to the corresponding image in a UFI file and indicates whether they match. Use this command to determine whether a HostRAID controller's flash components are up-to-date when compared to a specific UFI file.

Command Syntax

The command syntax for the VERIFY command is as follows:

```
AFU VERIFY [/C<Controller ID>] [/D <UFI File Path>]
```

Command Switches

For details on the /C and /D switches, see [SAVE on page 83](#).

Example

The following example shows a typical system response after a `VERIFY` command has been performed:

```
A:\> AFU VERIFY /C 0
Adaptec Flash Utility V1.0-0 B1406
(c)Adaptec Inc. 1999-2005. All Rights Reserved.
Reading flash image file (Build 1406)
Controller #0: Adaptec ASC-48300
File: Checksum: 642C [VALID] (Build 1406)
File: Checksum: 642C [VALID] (Build 1406)
Verified Successfully
```

VERSION

The `VERSION` command displays version information about the flash components on a HostRAID controller.

Command Syntax

The command syntax for the `VERSION` command is as follows:

```
AFU VERSION [/C<Controller ID>]
```

Command Switches

For details on the `/C` switch, see [SAVE on page 83](#).

Example

The following example displays version information about all supported HostRAID controllers:

```
A:\> AFU VERSION /C 0
Adaptec Flash Utility V1.0-0 B1406
(c)Adaptec Inc. 1999-2005. All Rights Reserved.
Version Information for Controller #0 (Adaptec ASC-48300)
ROM: Build 1406 [VALID]
```

Updating Flash Using AFU Command Line

This section provides step-by-step instructions for updating the flash.

- 1 Create the firmware kit on floppy disks (see [page 81](#)).
- 2 Power off your computer, insert the first AFU floppy disk, then power on your computer.
If your computer isn't set up to boot from the bootable floppy disk, enter the system setup utility to change the setting.
- 3 At the DOS command, if you have multiple controllers and you don't know the number of the controller you want to update, type `AFU LIST`, then press **Enter**. Otherwise, skip to the next step.
- 4 At the DOS command, type `AFU` followed by a command (see [page 82](#)) and any switches you want.

5 Update the flash using the instructions suitable for your requirements:

- **To update a single HostRAID controller:**

```
AFU UPDATE /C <cont_number>
```

Where *<cont_number>* is the number of the RAID controller whose firmware you are updating. For example, to upgrade Controller 0, type `AFU UPDATE /C 0`

- **To update multiple HostRAID controllers:**

```
AFU UPDATE /C <cont_number_a>,<cont_number_b>
```

Where *<controller_number_a>* and *<controller_number_b>* are the numbers of the Adaptec RAID controllers whose firmware you are updating. For example, to upgrade controllers 0, 2, and 3, type `AFU UPDATE /C 0, 2, 3`.

- **To update all HostRAID controllers simultaneously:**

```
AFU UPDATE /C all
```

Note: The UFI file identifies the RAID controllers, so you don't have to worry about flashing the wrong controller.

6 When prompted, insert the first firmware disk into your floppy disk drive.

The AFU reads the first disk.

7 When prompted, remove the first firmware disk and insert the second firmware disk into your floppy disk drive.

8 Repeat [Step 7](#) until the flash update is complete.

HostRAID Controller LED and I2C Connector Reference



In this appendix...

Adaptec 58300 Activity LED Connector Specification.....	88
Adaptec 48300 Activity LED Connector Specification.....	88
Adaptec 44300 Activity LED Connector Specification.....	89
Adaptec 1430SA Activity LED and I2C Connector Specification.....	89
Adaptec 1420SA Activity LED and I2C Connector Specification.....	90
Adaptec 1220SA Activity LED Connector Specification	91
Adaptec 1225SA Activity LED Specification.....	91

This chapter provides a activity LED and I2C connector reference for HostRAID controllers.

Adaptec 58300 Activity LED Connector Specification

2220600-R	ASC-58300 RoHS Kit
-----------	--------------------

J3—Aggregate Activity LED Header

Pin Number	Signal	Description
1	BUSYLED-	Aggregate Cathode
2	+3.3V	Aggregate Anode

Note: Aggregate LED signals only.

There is *no* I2C function on this controller as all ports are external.

Adaptec 48300 Activity LED Connector Specification

2216400-R	ASC-48300 with I2C HR RoHS Kit
2254000-R	ASC-48300 I2C RoHS Single

J3—Aggregate Activity LED Header

Pin Number	Signal	Description
1	BUSYLED-	Aggregate Cathode
2	+3.3V	Aggregate Anode

Note: Aggregate LED signals only.

There is *no* separate I2C connector. I2C signals are contained within the side band signals of the SFF-8484 connector.

J4—SFF-8484 Connector

Pin Number	Signal	Description
14	I2C_CLK	SB0 - 2W_SCL
15	I2C_DAT	SB1- 2W_SDA
16	GND	SB2 - Ground
17	GND	SB3 - Ground
18	RST_OUT	SB4 - Reset
19	BKPL_ID	SB5 - Backplane Address

Adaptec 44300 Activity LED Connector Specification

2220300-R	ASC-44300 RoHS Kit
2253900-R	ASC-44300 RoHS Single

J3—Aggregate Activity LED Header

Pin Number	Signal	Description
1	BUSYLED-	Aggregate Cathode
2	+3.3V	Aggregate Anode

Note: Aggregate LED signals only.

There is *no* separate I2C connector. I2C signals are contained within the side band signals of the SFF-8484 connector.

J4—SFF-8484 Connector

Pin Number	Signal	Description
14	I2C_CLK	SB0 - 2W_SCL
15	I2C_DAT	SB1- 2W_SDA
16	GND	SB2 - Ground
17	GND	SB3 - Ground
18	RST_OUT	SB4 - Reset
19	BKPL_ID	SB5 - Backplane Address

Adaptec 1430SA Activity LED and I2C Connector Specification

2240900-R	AAR-1430SA RoHS Kit
2240900JA-R	AAR-1430SA RoHS Kit
2241000-R	AAR-1430SA RoHS Single

J1—LED Connector

Pin Number	Signal	Description
1	LED_OUT0-	PORT 0 Cathode
2	LED OUT 1-	PORT 1 Cathode
3	LED OUT 2-	PORT 2 Cathode
4	LED OUT 3-	PORT 3 Cathode

Note: Board circuitry supports common anode backplane implementations.

J2—I2C Connector

Pin Number	Signal	Description
1	TWSISDA	I2C Data
2	GND	Ground
3	TWSISCK	I2C Clock

J3—Aggregate LED Header

Pin Number	Signal	Description
1	LED_SUM	Aggregate Cathode
2	+3.3V	Aggregate Anode

J4—Activity LED Connector

Pin Number	Signal	Description	22-55-2081
1	ACT_LED3-	PORT 3 Cathode	2
2	+3.3V	PORT 3 Anode	1
3	ACT_LED2-	PORT 2 Cathode	4
4	+3.3V	PORT 2 Anode	3
5	ACT_LED1-	PORT 1 Cathode	6
6	+3.3V	PORT 1 Anode	5
7	ACT_LED0-	PORT 0 Cathode	8
8	+3.3V	PORT 0 Anode	7

Adaptec 1420SA Activity LED and I2C Connector Specification

2170200EU-R	AAR-1420SA/EFIGS RoHS KIT
2170200JA-R	AAR-1420SA/JA RoHS KIT
2170200-R	AAR-1420SA RoHS KIT
2170500-R	AAR-1420SA RoHS Single

J2—LED Connector

Pin Number	Signal	Description
1	LED OUT0-	PORT 0 Cathode
2	LED OUT 1-	PORT 1 Cathode
3	LED OUT 2-	PORT 2 Cathode
4	LED OUT 3-	PORT 3 Cathode

Note: Board circuitry supports common anode backplane implementations.

J7—Aggregate Activity LED Header

Pin Number	Signal	Description
1	LED_SUM	Aggregate Cathode
2	+3.3V	Aggregate Anode

J1—I2C Connector

Pin Number	Signal	Description
1	TWSISDA	I2C Data
2	GND	Ground
3	TWSISCK	I2C Clock

Adaptec 1220SA Activity LED Connector Specification

2232100-R	AAR-1220SA RoHS Kit
2232100JA-R	AAR-1220SA RoHS Kit

J1—Activity LED Connector

Pin Number	Signal	Description
1	ACT_LED1-	PORT 1 Cathode
2	+3.3V	PORT 1 Anode
3	ACT_LED0-	PORT 0 Cathode
4	+3.3V	PORT 0 Anode

Note: Board circuitry supports common anode backplane implementations.

Adaptec 1225SA Activity LED Specification

2257700-R	AAR-1225SA RoHS Kit
2257700JA-R	AAR-1225SA RoHS Kit
2257800-R	AAR-1225SA RoHS Single

J1—Activity LED Connector

Pin Number	Signal	Description
1	ACT_LED1-	PORT 1 Cathode
2	+3.3V	PORT 1 Anode
3	ACT_LED0-	PORT 0 Cathode
4	+3.3V	PORT 0 Anode

Note: Board circuitry supports common anode backplane implementations.

Safety Information



To ensure your personal safety and the safety of your equipment:

- Keep your work area and the computer clean and clear of debris.
- Before opening the system cabinet, unplug the power cord.

Electrostatic Discharge(ESD)

 **Caution:** ESD can damage electronic components when they are improperly handled, and can result in total or intermittent failures. Always follow ESD-prevention procedures when removing and replacing components.

To prevent ESD damage:

- Use an ESD wrist or ankle strap and ensure that it makes skin contact. Connect the equipment end of the strap to an unpainted metal surface on the chassis.
- If a wrist strap is not available, ground yourself by touching the metal chassis before handling the controller or any other part of the computer.
- Avoid touching the controller against your clothing. The wrist strap protects components from ESD on the body only.
- Handle the controller by its bracket or edges only. Avoid touching the printed circuit board or the connectors.
- Put the controller down only on an antistatic surface such as the bag supplied in your kit.
- If you are returning the controller to Adaptec, put it back in its antistatic bag immediately.

Technical Specifications



In this chapter...

- Environmental Specifications..... 94
- DC Power Requirements..... 94
- Current Requirements..... 94

Environmental Specifications

Ambient temperature without forced airflow	0°C to 40°C
Ambient temperature with forced airflow of atleast 200 CFM	0°C to 55°C
Relative humidity	10% to 90%, noncondensing
Altitude	up to 3,000 meters

Note: Forced airflow is recommended, but not required.

DC Power Requirements

PCI, PCI-X, PCIe	Ripple and noise	50mV peak-to-peak (max)
PCI, PCIX	DC Voltage	5V \pm 5%, 3.3V \pm 10%
PCIe	DC Voltage	3.3V \pm 10%

Current Requirements

Adaptec Model	Maximum Current (A)
ASC-58300	0.56A
ASC-48300	1.322A
ASC-44300	.445A
AAR-1430SA	1.5A
AAR-1420SA	1.5A
AAR-1220SA	1.5A
AAR-1225SA	1.5A

Glossary

A

activity

See [task](#).

ACU

Array Configuration Utility. An application used to create, configure, and manage arrays from the controller's BIOS or MS-DOS.

array

A logical disk created from available space and made up of one or more segments on one or more physical disks. Arrays are typically used to provide data redundancy or enhanced I/O performance. See [volume](#), [RAID 0](#), [RAID 1](#), [RAID 10](#). Also known as a container.

array initialization

See [configure](#).

ATA

AT Bus Attachment. Standard parallel interface to IDE hard disks typically used in desktop computers and some entry-level servers. Serial ATA (SATA), is a successor to parallel ATA, which is sometimes referred to as PATA.

available space/segment

Unused space on a configured disk from which logical devices (arrays) are created. When an array is deleted, the space that it used is returned to the available space pool.

B

background consistency check

Option that forces the controller to constantly check all portions of disks used by all arrays to see if the disks can return data from the blocks. See [consistency check command](#).

bad segment

Segment that is in an unknown state.

bootable array

Array configured as the boot device.

build

Background initialization of a redundant array. The array is accessible throughout. RAID 1 copies the contents of the primary drive to a secondary drive. See [clear](#).

bus

See [channel](#).

C**cache**

Fast-access memory on the controller that serves as intermediate storage for data that is read from, or written to, drives.

capacity

Total usable space available in megabytes or gigabytes.

channel

Any path, or bus, used for the transfer of data and the control of information between storage devices and a RAID controller. For SATA channels, each channel has a single drive capacity.

check point

A feature that enables you to exit the ACU when an operation is in progress and be able to continue without interruption. The driver then resumes the operation from where the BIOS left off and the BIOS resumes the operation where the driver left off.

chunk

See [stripe](#).

clear

Foreground initialization of a fault-tolerant array. A clear operation zeros all blocks of the array. The array is not accessible until the clear task is complete.

concatenation

Joining of physical or logical drives in sequential order.

configure

Process of preparing a disk for use by the controller. When a disk is configured, the controller records the RAID signature on the disk.

configured array

An array that is ready for data reads and writes. Arrays can be configured by build or clear.

consistency check command

Command that reads all the blocks of a RAID 1 to determine if the blocks are consistent. Any inconsistent blocks are fixed.

D**dead partition**

See [failed](#).

degraded

A redundant (for example, a RAID 1) array in which one or more members have failed. The data is intact but redundancy has been compromised. Any further failure would cause the array to fail and result in data loss.

disk

Physical disk drive. Randomly accessible, rewriteable data storage device. Also called hard disk.

disk ID

Unique disk identifier that consists of the channel number, SATA ID. For example, (channel:ID:LUN) 1:04:0. See [channel](#).

drive LED

Disk indicator LED that illuminates during read or write operations.

E**event**

Notification or alert from the system, indicating that a change has occurred.

event log

File used to maintain information about prior controller activities or errors.

event notification

Process for transmitting events.

F**failed**

State of a nonredundant array that has suffered a single drive failure, or a redundant array that has suffered multiple drive failures. A failed array is inaccessible and data is lost.

fault-tolerant array

Refers to an array that can continue to function after a disk drive failure without loss of data. Fault tolerant, or redundant arrays, include RAID 1 arrays. See [redundant](#).

foreign disk

Disk that has previously been configured on another Adaptec RAID controller. The RAID signature on the disk allows the RAID controller to identify whether or not the disk was configured on the controller it is currently connected to.

H**hard disk drive**

Basic unit of nonvolatile, nonremovable, magnetic storage media. See [disk](#).

hot spare

A spare hard disk that automatically replaces a failed hard disk on any array associated with any HBA.

hot swap

To remove a component from a system, and install a new component while the power is on and the system is running.

I**impacted**

An impacted array is one which has been created but for some reason the initial build operation did not complete. All member drives are present and operational, and all data written to the array is protected. To optimize the array, run a Verify with Fix Task.

initialize

See [configure](#).

L

legacy disk

Disk that contained a valid partition table when connected to the controller. The controller manages the disk as a legacy disk array where there is a one-to-one logical-to-physical mapping of array to disk.

logical device

Volume comprised of space from one or more physical drives and presented to the operating system as if it were a single storage unit.

low-level format

Process performed by the drive firmware that completely cleans any data off the hard disk.

M

mirrored array/mirroring

See [RAID 1](#), [RAID 10](#).

monitoring

Process of receiving, displaying, and logging system events.

N

Native Command Queuing

Allows disk drives to arrange commands into the most efficient order for optimum performance.

O

offline array

Array that can no longer be accessed.

optimal

The state of an array when it is fully operational. For redundant arrays, the entire array is protected.

P

partition

A section of a disk storage device created by the operating system disk management program, in which data and/or software programs are stored. Computers have a primary operating system partition that contains the special files needed to boot the computer. Each operating system partition is assigned a unique drive letter, such as C or D. A single disk device can have multiple partitions.

phantom object

Object that represents a component that cannot be configured by the controller management software; for example, a missing drive.

Q

quick init

An array configured using the Quick Init option is available immediately, with no on-going background controller activity. All data written to an array that has been quick configured is protected.

R

RAID

Redundant Array of Independent Disks (alternative definition Redundant Array of Inexpensive Disks).

RAID 0

A single-level array consisting of two or more equal-sized segments residing on different disks. RAID 0 distributes data evenly across its respective drives in equal-sized sections called stripes. RAID 0 arrays are not redundant.

RAID 1

Single-level array consisting of two equal segments residing on two different drives. Provides redundancy by storing identical copies on two drives. See [mirrored array/mirroring](#).

RAID 10

Spanned array consisting of two or more equal-sized RAID 1 arrays. Provides redundancy by striping and mirroring. Mirroring provides data protection, and striping improves performance. See [mirrored array/mirroring](#), [RAID 0](#).

RAID signature

The area on each disk reserved for use by the RAID controller.

RAID volume

Concatenates two or more arrays of the same type.

rebuild

Background regeneration of redundant data on a RAID 1.

redundant

The ability of an array to maintain operability when one or more hardware failures occur. RAID 1 is redundant. In the event of a drive failure, redundant arrays can be restored to normal operation by replacing the failed drive and rebuilding the array.

rescan

Process of updating the current screen to show all currently available resources.

S

Serial Attached SCSI (SAS)

An evolution of parallel SCSI to a point-to-point serial interface

Serial ATA (SATA)

A successor to ATA that uses a serial, instead of parallel, interface.

simple volume

A volume made up of disk space from a single disk. It can consist of a single region on a disk, or concatenated multiple regions of the same disk.

single-level array

Array created from one or more segments. See [volume](#), [RAID 0](#), [RAID 1](#), [RAID 10](#).

snapshot

Instantaneous read-only copy of an array at a precise point in time.

stripe

Contiguous set of data distributed across all the disks in an array. A striped array distributes data evenly across all members in equal-sized sections called stripes.

stripe size

The amount of data in each section of a striped array.

striped array

See [RAID 0](#), [RAID 10](#).

T**task**

An operation that occurs only on the RAID controller, asynchronous to all other operations; for example, initializing a disk or verifying an array. Some tasks can take an extended period of time, particularly if the RAID controller is also performing intensive data I/O while the task is running.

V**verify**

Low-level check that a drive, logical device, or hot spare is good. In a RAID 1, verify is a low-level check that contents of both members' segments are consistent and, optionally, corrects errors while assuming that the master drive is correct. In a simple volume, verify performs a low-level check that the whole drive can be read.

volume

See [simple volume](#).

Index

A

- ACU
 - creating arrays [69](#)
- Adaptec customer support [3](#)
- Adaptec Flash Utility. *See* AFU
- Adaptec RAID Configuration Utility. *See* HRCNF
- Adaptec Storage Manager
 - installing [51](#)
- AFU [80](#)
- Array Configuration Utility. *See* ACU
- arrays
 - creating (ACU) [69](#)
 - non-RAID [65](#)
 - RAID 1 [66](#)
 - RAID 10 [66](#)

B

- backplane connections [31, 61](#)

C

- connectors [77](#)
- controllers
 - event log [78](#)
 - flashing [55](#)
 - resetting [55](#)
- customer support [3](#)

D

- data striping [65](#)
- direct-attach connections [31, 61](#)
- disk drives
 - connecting to SAS controllers [30](#)
 - connecting to SATA controllers [32](#)
 - connections [77](#)

- failure recovery
 - multiple arrays [55](#)
 - multiple disk drives [55](#)
 - with hot spare [54](#)
 - without hot spare [54](#)
- recovering from failure [54](#)
- SAS identifiers [60](#)
- drivers
 - installing on Linux [48](#)
 - installing on NetWare [48](#)
 - installing on Windows [47](#)

E

- electrostatic discharge [92](#)
- end devices [58](#)
- event log [78](#)
- expander connections [61](#)
- expander devices [58](#)

F

- failed disk drives
 - multiple arrays [55](#)
 - multiple disk drives [55](#)
 - without hot spare [54](#)
- flashing controllers [55](#)

H

- hard disk, hard disk drive, hard drive. *See* disk drives

I

- installation
 - disk drives (SAS) [30](#)
 - disk drives (SATA) [32](#)
 - SAS backplane [31](#)

SAS direct-attach 31

L

links (SAS) 59

Linux

driver installation 48

N

NetWare

driver installation 48

non-RAID arrays 65

P

phys 59

R

RAID

definition 65

RAID 0 65

RAID 1 66

RAID 10 66

recovering from disk drive failure

Red Hat

driver installation 48

Redundant Array of Independent Disks. *See* RAID

replacing failed disk drives

resetting controllers 55

S

SAS

4-wide ports 60

backplane connections 31, 61

cables 60

comparison to parallel SCSI 62

connectors 60

controllers 58

description 58

direct-attach connections 31, 61

disk drive identifiers 60

end devices 58

expander connections 61

expander devices 58

fanout expanders 61

link speed 58

links 59

narrow connectors 60

narrow ports 59

phys 59

ports 59

SAS address 60

SAS devices 58

SAS domain 62

terminology 58

transceivers 59

wide connectors 60

wide ports 59

SAS controllers

connecting disk drives 30

SAS devices 58

SATA controllers

connecting disk drives 32

SATASelect

using settings 75

SCSI

comparison to SAS 62

Serial ATA. *See* SATA

Serial Attached SCSI. *See* SAS

SerialSelect

using settings 74

storage management

ACU 69

AFU 80

SATASelect 75

SerialSelect 73

storage space 12

stripe, definition 65

stripe-unit size

definition 65

performance tuning 65

SuSE

driver installation 48

T

technical support 3

Technical Support Identification (TSID) number 3

terminology 12

Adaptec Storage Manager 12

SAS 58

throughput 65

tools

ACU 69

AFU 80

SATASelect 75

SerialSelect utilities

SerialSelect 73

TSID Number

See Technical Support Identification Number

U

utilities

AFU 80

SATASelect [75](#)

W

Windows

driver installation [47](#)



Adaptec, Inc.
691 South Milpitas Boulevard
Milpitas, CA 95035 USA

©2007 Adaptec, Inc.
All rights reserved. Adaptec and the Adaptec logo are
trademarks of Adaptec, Inc. which may be
registered in some jurisdictions.

Part Number:CDP-00222-03-A, Rev A
GS 11/07

Free Manuals Download Website

<http://myh66.com>

<http://usermanuals.us>

<http://www.somanuals.com>

<http://www.4manuals.cc>

<http://www.manual-lib.com>

<http://www.404manual.com>

<http://www.luxmanual.com>

<http://aubethermostatmanual.com>

Golf course search by state

<http://golfingnear.com>

Email search by domain

<http://emailbydomain.com>

Auto manuals search

<http://auto.somanuals.com>

TV manuals search

<http://tv.somanuals.com>