

Aspire L3600
VeritonL460
Service Guide

Service guide files and updates are available on the AIPG/CSD web; for more information please refer to <http://csd.acer.com.tw>

PRINTED IN TAIWAN

Revision History

Please refer to the table below for the updates made on Aspire L3600 VeritonL460 service guide.

Date	Chapter	Updates

Copyright

Copyright © 2007 by Acer Incorporated. All rights reserved. No part of this publication may be reproduced, transmitted, transcribed, stored in a retrieval system, or translated into any language or computer language, in any form or by any means, electronic, mechanical, magnetic, optical, chemical, manual or otherwise, without the prior written permission of Acer Incorporated.

Disclaimer

The information in this guide is subject to change without notice.

Acer Incorporated makes no representations or warranties, either expressed or implied, with respect to the contents hereof and specifically disclaims any warranties of merchantability or fitness for any particular purpose. Any Acer Incorporated software described in this manual is sold or licensed "as is". Should the programs prove defective following their purchase, the buyer (and not Acer Incorporated, its distributor, or its dealer) assumes the entire cost of all necessary servicing, repair, and any incidental or consequential damages resulting from any defect in the software.

Acer is a registered trademark of Acer Corporation.

Intel is a registered trademark of Intel Corporation.

Pentium 4 and Celeron are trademarks of Intel Corporation.

Other brand and product names are trademarks and/or registered trademarks of their respective holders.

Conventions

The following conventions are used in this manual:

SCREEN MESSAGES	Denotes actual messages that appear on screen.
NOTE	Gives bits and pieces of additional information related to the current topic.
WARNING	Alerts you to any damage that might result from doing or not doing specific actions.
CAUTION	Gives precautionary measures to avoid possible hardware or software problems.
IMPORTANT	Remind you to do specific actions relevant to the accomplishment of procedures.

Preface

Before using this information and the product it supports, please read the following general information.

1. This Service Guide provides you with all technical information relating to the BASIC CONFIGURATION decided for Acer's "global" product offering. To better fit local market requirements and enhance product competitiveness, your regional office MAY have decided to extend the functionality of a machine (e.g. add-on card, modem, or extra memory capability). These LOCALIZED FEATURES will NOT be covered in this generic service guide. In such cases, please contact your regional offices or the responsible personnel/channel to provide you with further technical details.
2. Please note WHEN ORDERING FRU PARTS, that you should check the most up-to-date information available on your regional web or channel. If, for whatever reason, a part number change is made, it will not be noted in the printed Service Guide. For ACER-AUTHORIZED SERVICE PROVIDERS, your Acer office may have a DIFFERENT part number code to those given in the FRU list of this printed Service Guide. You MUST use the list provided by your regional Acer office to order FRU parts for repair and service of customer machines.

Chapter 1 System Specifications 1

Features.....	1
Main board Placement.....	14
Block Diagram.....	15
Aspire L3600 Front Panel.....	16
Aspire L3600 Rear Panel.....	17
Veriton L460 Front Panel.....	18
Veriton L460 Rear Panel.....	19
Hardware Specifications and Configurations.....	20
Power Management Function (ACPI support function).....	24

Chapter 2 System Utilities 25

Entering Setup.....	26
Product Information.....	28
Standard CMOS Features.....	29
Advanced BIOS Features.....	32
Integrated Peripherals.....	36
Power Management.....	43
PnP/PCI Configuration.....	46
PC Health Status.....	48
Frequency/Voltage Control.....	49
Load Default Settings.....	51
Set Supervisor/User Password.....	52
Save & Exit Setup.....	54
Exit Without Saving.....	55

Chapter 3 Machine Disassembly and Replacement 56

General Information.....	57
Disassembly Procedure.....	58
Aspire L3600 Disassembly Procedure.....	59
Veriton L460 Disassembly procedure.....	67

Chapter 4 Troubleshooting 75

Chapter 5 Jumper and Connector Information 76

Jumper Setting.....	76
---------------------	----

Chapter 6 FRU (Field Replaceable Unit) List 77

Exploded Diagram.....	78
Parts.....	82

System Specifications

Features

Operating System

- Microsoft Windows Vista (Home Basic, Home Premium, Business)

Processor

- Socket Type: Intel® Socket T LGA 775 pin
- Processor Type:
 - Pentium 4 / Pentium D / Pentium Dual Core / Core 2 Duo /
Wolfdale CPUs

Chipset

- North Bridge: Intel G31
- South Bridge: ICH7DH

PCB

- Form Factor: Micro ATX
- Dimension/Layer: 234 x172mm

Memory

- Memory Type: DDRII 667/800
- Support dual channel DDRII with maximum memory size up to
2GB
- DIMM Slot: 2
- Memory Max: 256MB, 512MB, 1GB DDRII 667/800 SDRAM
module.
- Capacity: Up to 256MB per DIMM with maximum memory size
up to 2 GB

Video

- D-sub output

-
- Support from Intel G31
 - DVI-D output
 - Transmitter: Chronitel CH7307C
 - Support dual view on D-sub+ DVI

Mini PCI Slots

- Slot Type: 3A
- PCI Slot Quantity: 1
- One mini-PCI slot with type 3A supported. Reserve pins for

Hybrid TV tuner card.

Pin#	Name	Description
21	SY_IN1	S-Video Y Signal Input
22	SC_IN1	S-Video C Signal Input
93	CVBS_IN1	Composite Video Input
112	AR_IN1	Stereo Audio Right Channel Input
121	AL_IN1	Stereo Audio Left Channel Input
98	AR_OUT1	Audio Right Channel Output
100	AL_OUT1	Audio Left Channel Output

- One mini-card slot is reserved for wireless LAN card.
- Mini-Card Slot Quantity: 1

IDE/SATA

- Slot Quantity: 1

- Transfer rate support:
 - PIO Mode: 0/1/2/3/4

 - ATA mode: 33/66/100

- Device Type support:
 - Combo/DVD Dual/DVD supermulti

- Connector Type: SATA IDE connector

- Connector Quantity: 2

- Storage Type support:
 - HDD

Audio

- Please refer to 6.9 Acer Audio spec

-
- Codec: Realtek ALC888S

 - Connectors support:
 - 6 audio in/out put port with auto-detected channel on rear.

 - Headphone and microphone on front panel.

 - SPDIF

 - MB header support:
 - 1 2*5 pin Intel FPIO header

 - Design Criteria:
 - Meet Microsoft Vista Premium requirement

LAN

- LAN Control: Intel 82573L GbE LAN controller

- Support WOL from S5

USB

- Controller: ICH7-DH

-
- Connectors Quantity: 8
 - Rear connectors: 4
 - On-board header: 2 (4 USB ports)
 - 2 2*5 Pin Intel FPIO header for front panel USB ports
 - Data transfer rate support:
 - USB 2.0/1.1

1394

- TI TSB43AB23PDTG4 is required.

BIOS

- SST 49LF004B FWH
- 4Mbit symmetrical Flash

Front I/O port

- VeritonL460
 - 4 USB ports
 - 1 headphone out (follow HD audio spec, meet Vista Premium)

criteria)

- 1 microphone in (follow HD audio spec, meet Vista Premium

criteria)

- Aspire L3600

- 2 USB Port

- 1 headphone out (follow HD audio spec, meet Vista Premium

criteria)

- 1 microphone in (follow HD audio spec, meet Vista Premium

criteria)

- 1 4-pin 1394 Port

- 1 4-in-1 card reader port (MS/MS Pro/MMC/SD/XD)

Rear I/O connectors

- Veriton L460

- 1 GigaLAN port

-
- 4 USB Ports
 - 1 D-sub + DVI monitor port
 - 6 Audio Jack port (follow HD audio spec, meet Vista

Premium criteria)

- Aspire L3600
- 1 GigaLAN port
- 4 USB Ports
- 1 D-sub + DVI monitor port
- 6 Audio Jack port (follow HD audio spec, meet Vista

Premium criteria)

- 1 1394 port 6 pin
- 1 SPDIF
- 2 Antenna input for cable and FM
- 1 8 pin mini-dip AV in

On-board connectors

- Processor Support
 - Socket 775
 - Intel Celeron /Pentium Dual Core / Core 2 Duo / Yorkfield /
Wolfdale CPUs
 - FSB 533/800/1066/1333 (TBD)MHz CPUs
 - Intel 2006 FMB (65W)
- Chipset
 - North bridge: Intel G31
 - South bridge: Intel ICH7-DH
- I/O Expansion Slots
 - One mini-PCI slot with type 3A supported. Reserve pins for
Hybrid TV tuner card.
 - One mini-card slot is reserved for wireless LAN card.

-
- Memory
 - Two DDRII so-DIMM sockets
 - 512MB, 1GB, DDRII 667/800 SDRAM module
 - Support dual channel DDRII memory bus

 - Onboard Devices
 - VGA graphics
 - Support integrated graphic display
 - Display output should support DVI and D-sub output.

 - Networking
 - Intel 82573L (Vidalia) GbE LAN solution
 - Port with Activity and Link indicators
 - Meet Intel Viiv technology requirement.

 - Audio system
 - Realtek ALC888S codec.

□ Compliance with HD audio and support UAA interface.

□ Stereo channel HD audio output in rear panel.

□ Audio solution should meet Vista Premium

requirement.

□ SPDIF coaxial output (Aspire L3600)

□ 2*5 pin Intel FPIO spec. Microphone In/ Headphone

Out pin connectors for front panel audio adapter.

□ USB

□ Two (2) USB ports. (Aspire L3600)

□ Four (4) USB ports on front panel. (Veriton L460)

□ Four (4) USB ports on rear panel

□ All ports should comply with USB SIG USB 1.1 and 2.0

spec

□ IEEE-1394a (Aspire L3600)

-
- TI TSB43AB23PDTG4 is required.

 - Super I/O controller support including:
 - ITE 8718 is recommended.

 - Controllable of fan speed on boot-up.

 - On-board storage
 - Two (2) ports serial-ATA available on board.

 - One (1) port PATA available on board.

 - Others
 - Front panel I/O connector

 - Clear CMOS Connector (3-pin)

-
- Plug and Play support

 - APM 1.2 support

 - Advanced Configuration and Power Interface (ACPI 2.0c or greater) support including the S1, S3, S4 and S5 states.

 - One GPIO pin for Acer One Button Recovery function.

AC Adapter

- Universal AC adapter, 90~264V AC, 47~63HZ

- 3-pin 135W with 19V DC output

Main board Placement

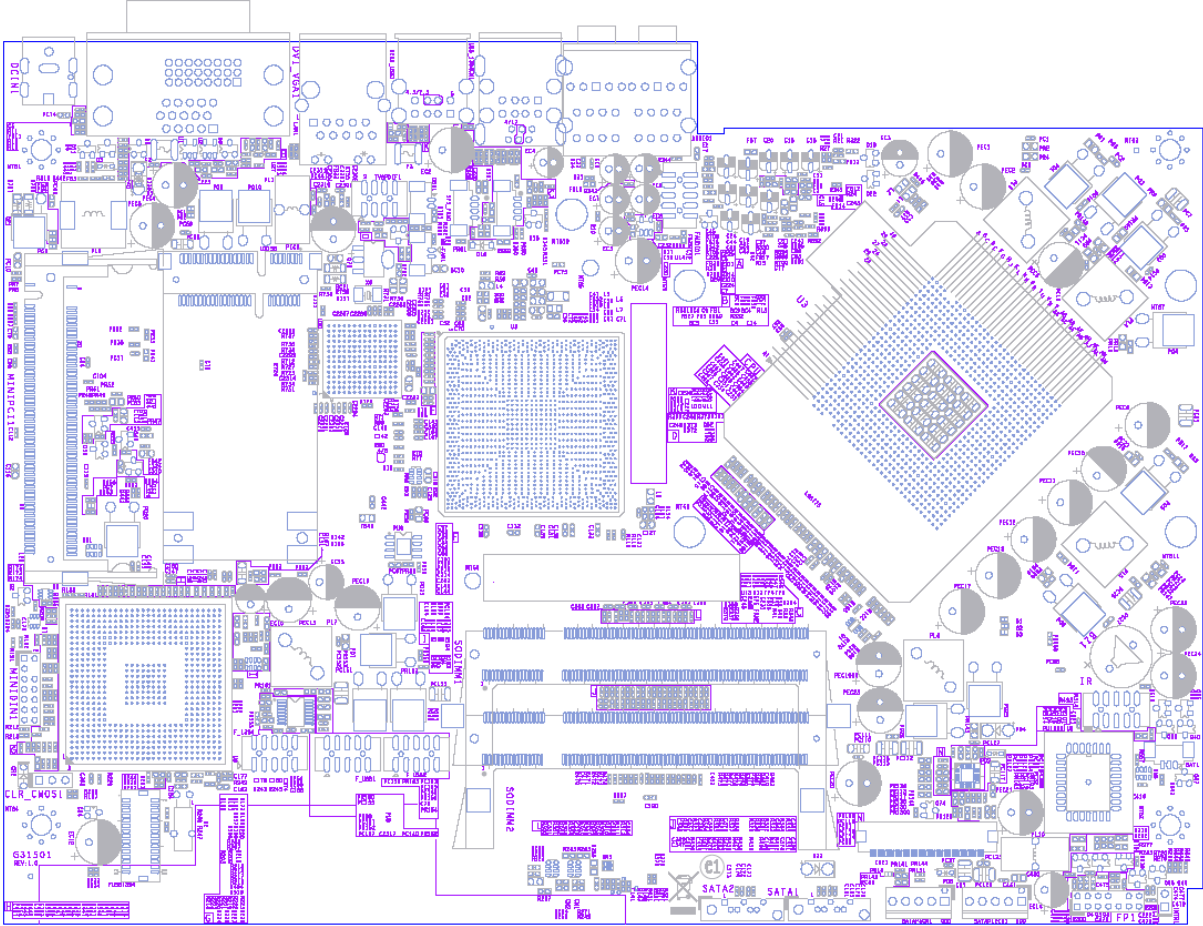

Block Diagram

Block Diagram

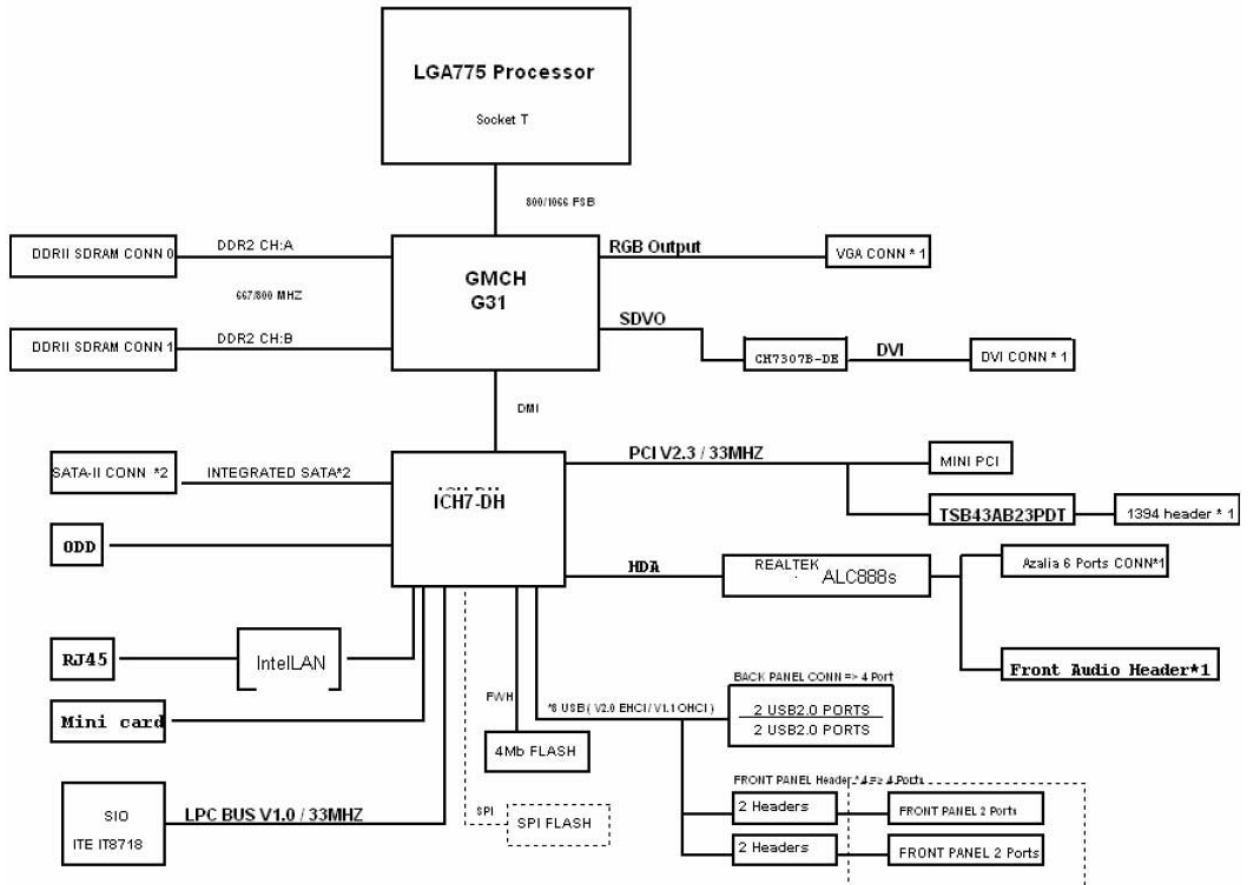

Aspire L3600 Front Panel

The computer's front panel consists of the following:

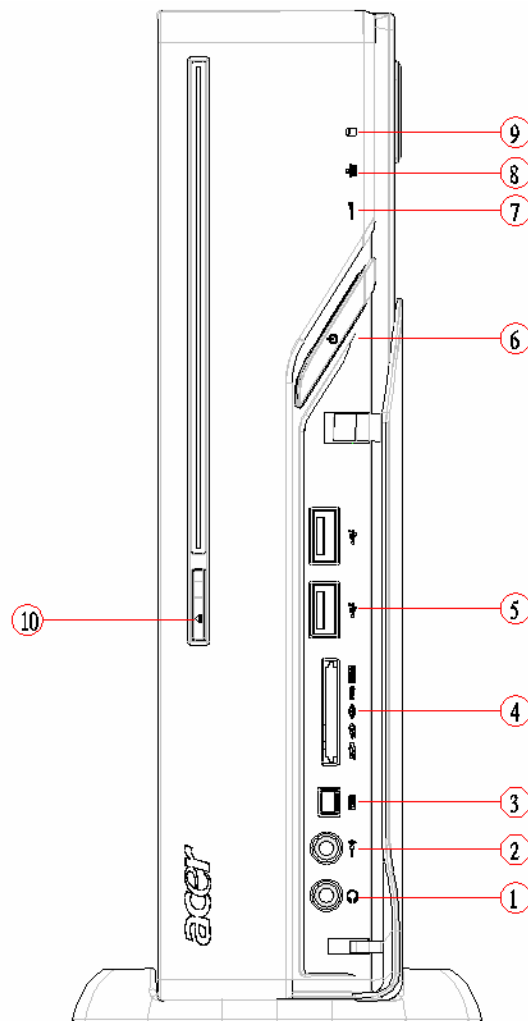

Label	Description
1	SPEAKER OUT
2	MIC PHONE
3	1394 PORTS
4	CARD-READER port
5	USB PORTS
6	POWER BUTTON
7	IR LED
8	LAN LED
9	HDD LED
10	ODD BUTTON

Aspire L3600 Rear Panel

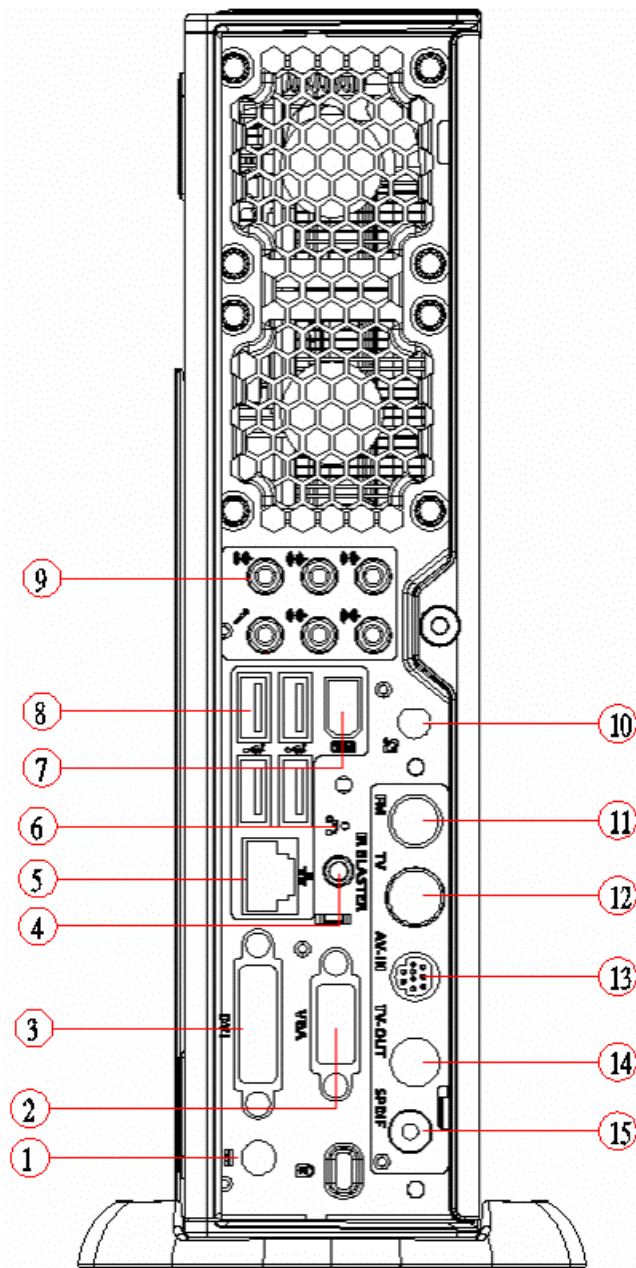

Label	Description	Label	Description
1	DC jack	9	6audio jacks
2	VGA	10	ANTENNA Port
3	DVII port	11	FM Port
4	IR-Blaster	12	TV Port
5	LAN PORT	13	AV IN
6	OBR	14	TV OUT
7	1394 Port	15	Spdif Port
8	USB PORTS		

VeritonL460 Front Panel

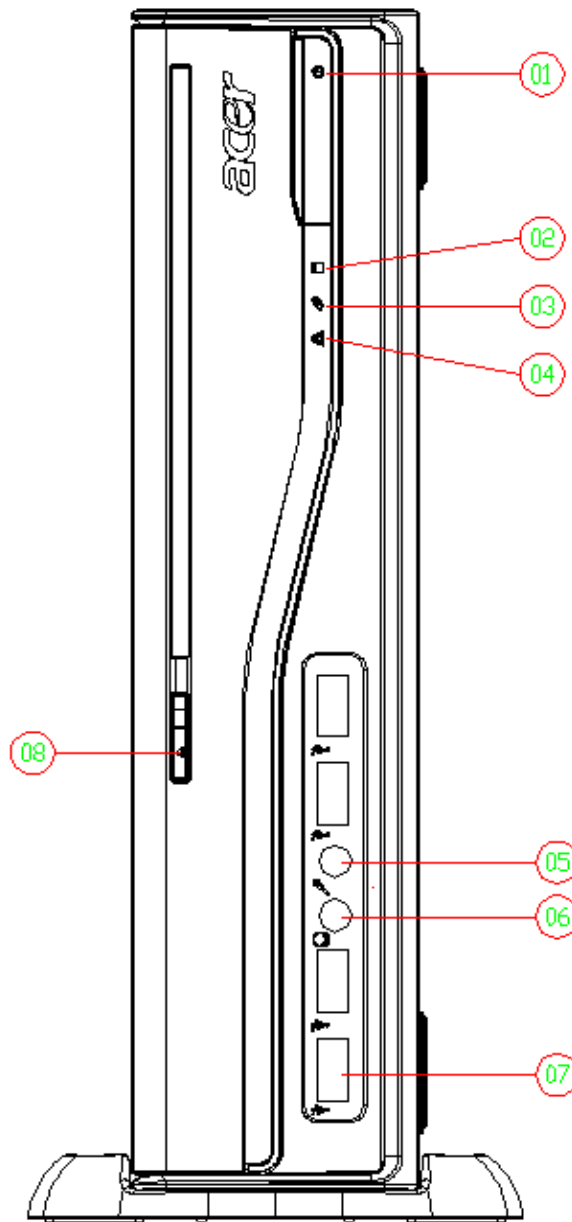

Label	Description
1	POWER BUTTON
2	HDD LED
3	HDD LED
4	ODD LED
5	SPEAKER OUT
6	MIC PHONE
7	USB PORTS
8	ODD BUTTON

VeritonL460 Rear Panel

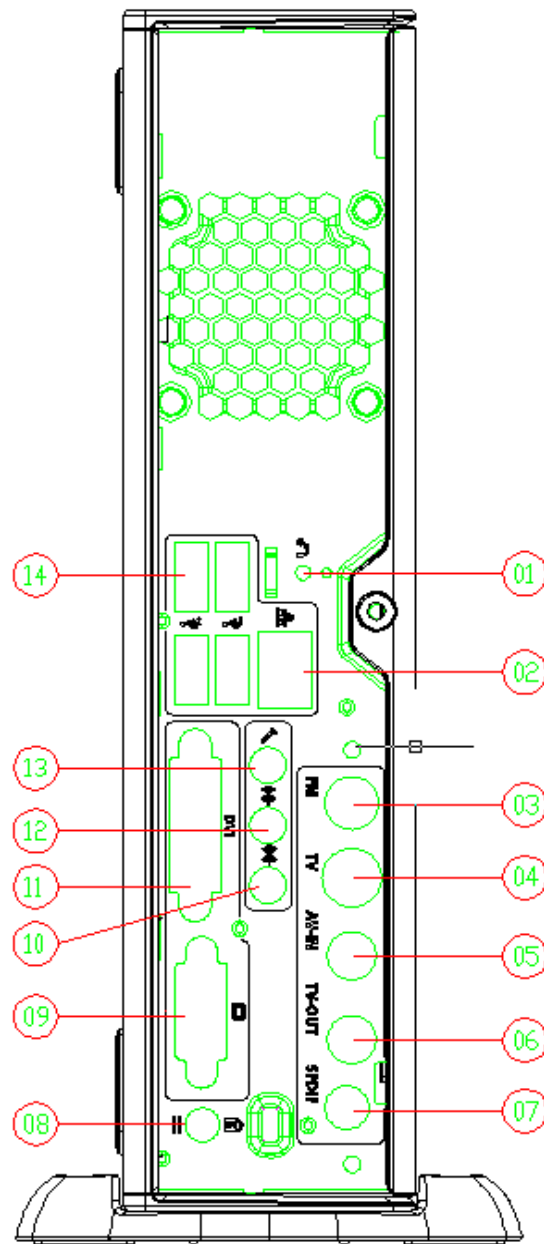

Label	Description	Label	Description
1	OBR	8	DC jack
2	LAN PORT	9	VGA
3	FM Port	10	LINE OUT
4	TV Port	11	DVII port
5	AV IN	12	LINE IN
6	TV OUT	13	MIC
7	Spdif Port	14	USB PORTS

Hardware Specifications and Configurations

Processor

Item	Specification
Type	Pentium 4 / Pentium D /Pentium Dual Core / Core 2 Duo / Wolfdale CPUs
Socket	LGA 775 pin
FSB	FSB 800/1066 MHz CPUs
Minimum operating speed	0 MHz (If Stop CPU Clock in Sleep State in BIOS Setup is set to Enabled.)

BIOS

Item	Specification
BIOS code programmer	The SST 49LF004B Firmware Hub (FWH) or supported alternative FWH will be implemented on the Beagle motherboard.
BIOS version	V2.4
BIOS ROM type	Symmetrical Flash
BIOS ROM size	4Mb
Device Boot Support	<ul style="list-style-type: none">- 1st priority: SATA HDD- 2nd priority: CD-ROM- 3rd priority: LAN- 4th priority: USB device
Support to LS-120 drive	YES
Support to BIOS boot block feature	YES

BIOS Hotkey List

Hotkey	Function	Description
Del	Enter BIOS Setup Utility	Press while the system is booting to enter BIOS Setup Utility.

Main Board Major Chips

Item	Specification
North Bridge	Intel G31
South Bridge	ICH7DH
APG controller	Integrated
Super I/O controller	IT8718F
Audio controller	Realtek / ALC888S-GR
LAN controller	Intel 82573L
HDD controller	ICH7DH

Memory Combinations

Slot	Memory	Total Memory
Slot 1	512MB, 1GB	512MB~2GB
Slot 2	512MB, 1GB	512MB~2GB
Maximum System Memory Supported		512MB~2GB

System Memory

Item	Specification
Memory slot number	2 slot
Support Memory size per socket	512MB/1GB
Support memory type	DDRII
Support memory interface	DDRII 667/800 SDRAM module
Support to parity check feature	Yes
Support to error correction code (ECC) feature	No
Memory module combinations	You can install memory modules in any combination as long as they match the above specifications.

Audio Interface

Item	Specification
Audio controller	ICH7DH
Audio controller type	Realtek ALC888S
Audio channel	codec 7.1
Audio function control	Enable/disable by BIOS Setup
Mono or stereo	Stereo
Compatibility	Sound Blaster Pro/16 compatible Mixed digital and analog high performance chip Enhanced stereo full duplex operation High performance audio accelerator and AC'97 support Full native DOS games compatibility Virtual FM enhances audio experience through real-time FM-to-Wavetable conversionMPU-401 (UART mode) interface for Wavetable synthesizers and MIDI devices Integrated dual game port Meets AC'97and WHQL specifications
Music synthesizer	Yes, internal FM synthesizer
Sampling rate	48 KHz (max.)
MPU-401 UART support	Yes
Microphone jack	Supported
Headphone jack	Supported

SATA Interface

Item	Specification
SATA controller	Super I/O ITE 8718
SATA controller resident bus	PCI bus
Number of SATA channel	SATA X 1
Support bootable CD-ROM	YES

USB Port

Item	Specification
Universal HCI	USB 2.0/1.1
USB Class	Support legacy keyboard for legacy mode
USB Connectors Quantity	Rear connectors: 4 On-board header: 2 (4 USB ports)

Environmental Requirements

Item	Specification
Temperature	
Operating	+5°C ~ +35°C
Non-operating	-20 ~ +60°C (Storage package)
Humidity	
Operating	15% to 80% RH
Non-operating	10% to 90% RH
Vibration	
Operating (unpacked)	5 ~ 500 Hz: 2.20g RMS random, 10 minutes per axis in all 3 axes 5 ~ 500 Hz: 1.09g RMS random, 1 hour per axis in all 3 axes

AC Adapter

- Universal AC adapter, 90~264V AC, 47~63HZ
- 3-pin 135W with 19V DC output

Power Management Function (ACPI support function)

Device Standby Mode

- Independent power management timer for hard disk drive devices (0-15 minutes, time step=1 minute).
- Hard disk drive goes into Standby mode (for ATA standard interface).
- Disable V-sync to control the VESA DPMS monitor.
- Resume method: device activated (Keyboard for DOS, keyboard & mouse for Windows).
- Resume recovery time: 3-5 sec.

Global Standby Mode

- Global power management timer (2-120 minutes, time step=10 minute).
- Hard disk drive goes into Standby mode (for ATA standard interface).
- Disable H-sync and V-sync signals to control the VESA DPMS monitor.
- Resume method: Return to original state by pushing external switch button, modem ring in, keyboard and mouse for APM mode.
- Resume recovery time: 7-10 sec.

Suspend Mode

- Independent power management timer (2-120 minutes, time step=10 minutes) or pushing external switch button.
- CPU goes into SMM.
- CPU asserts STPCLK# and goes into the Stop Grant State.
- LED on the panel turns amber colour.
- Hard disk drive goes into SLEEP mode (for ATA standard interface).
- Disable H-sync and V-sync signals to control the VESA DPMS monitor.
- Ultra I/O and VGA chip go into power saving mode.
- Resume method: Return to original state by pushing external switch button, modem ring in, keyboard and mouse for APM mode.
- Return to original state by pushing external switch button, modem ring in and USB keyboard for ACPI mode.

ACPI

- ACPI specification 1.0b.
- S0, S1, S3 and S5 sleep state support.
- On board device power management support.
- On board device configuration support.

System Utilities

The manufacturer or the dealer already configures most systems. There is no need to run Setup when starting the computer unless you get a Run Setup message.

The Setup program loads configuration values into the battery-backed nonvolatile memory called CMOS RAM.

This memory area is not part of the system RAM.

NOTE: If you repeatedly receive Run Setup messages, the battery may be bad/flat. In this case, the system cannot retain configuration values in CMOS.

Before you run Setup, make sure that you have saved all open files. The system reboots immediately after you exit Setup.

Entering Setup

Power on the computer and the system will start POST (Power On Self Test) process. When the message of “Press DEL to enter SETUP” appears on the screen, press the key of [Delete] to enter the setup menu.

NOTE: If the message disappears before you respond and you still wish to enter Setup, restart the system by turning it OFF and On. You may also restart the system by simultaneously pressing [Ctrl+ Alt+ Delete].

The Setup Utility main menu then appears:

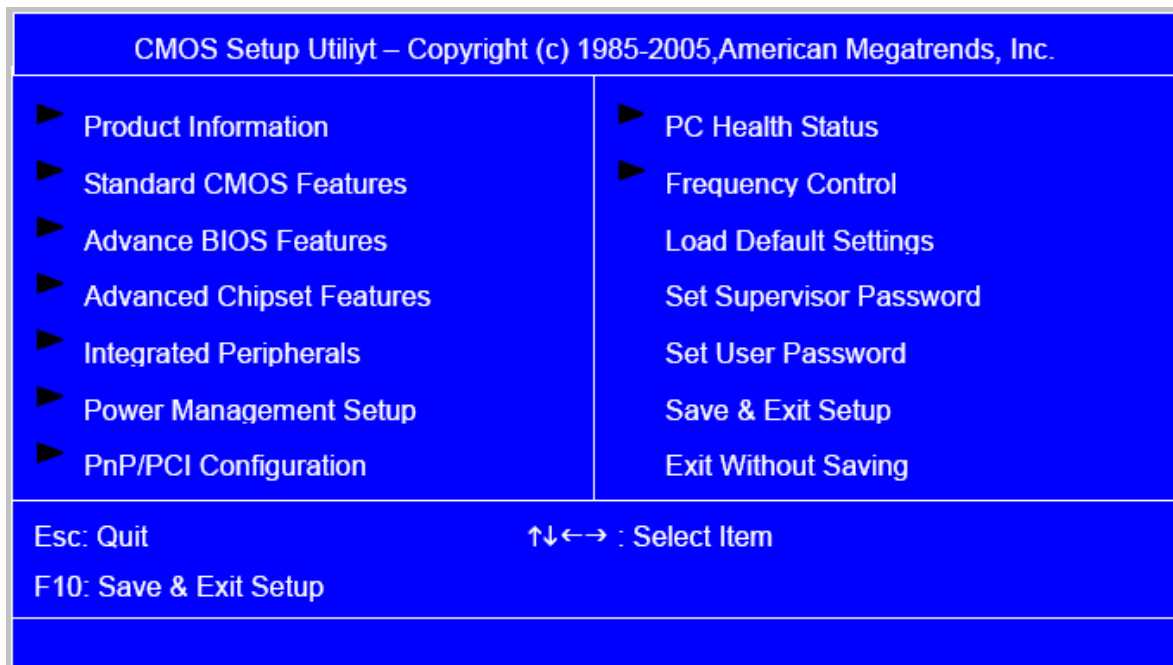

The items in the main menu are explained below:

Parameter	Description
Production Information	This page shows the relevant information of the main board
Standard CMOS Features	This setup page includes all the items in standard compatible BIOS
Advance BIOS Features	This setup page includes all the items of Award special enhanced features
Advance Chipset Features	This setup page includes all advanced chipset features
Integrated Peripherals	This setup page includes all onboard peripherals
Power Management Setup	This setup page includes all the items of Green function features
PnP/PCI Configuration	This setup page includes all configurations of PCI & PnP ISA resources
PC Health Status	This setup page is the System auto detect Temperature, voltage, and fan speed
Load Optimized Defaults	Load Optimized Settings Default Settings indicates the value of the system parameters which the system would be in best performance configuration
Set Supervisor Password	Change, set or disable password. It allows you to limit access to the system and Setup, or just to Setup
Set User Password	Change, set or disable password. It allows you to limit access to the System
Save & Exit Setup	Save CMOS value settings to CMOS and exit setup
Exit Without Saving	Abandon all CMOS value changes and exit setup

Product Information

The screen below appears if you select Product Information from the main menu: The Product Information menu contains general data about the system, such as the product name, serial number, BIOS version, etc. This information is necessary for troubleshooting (maybe required when asking for technical support).

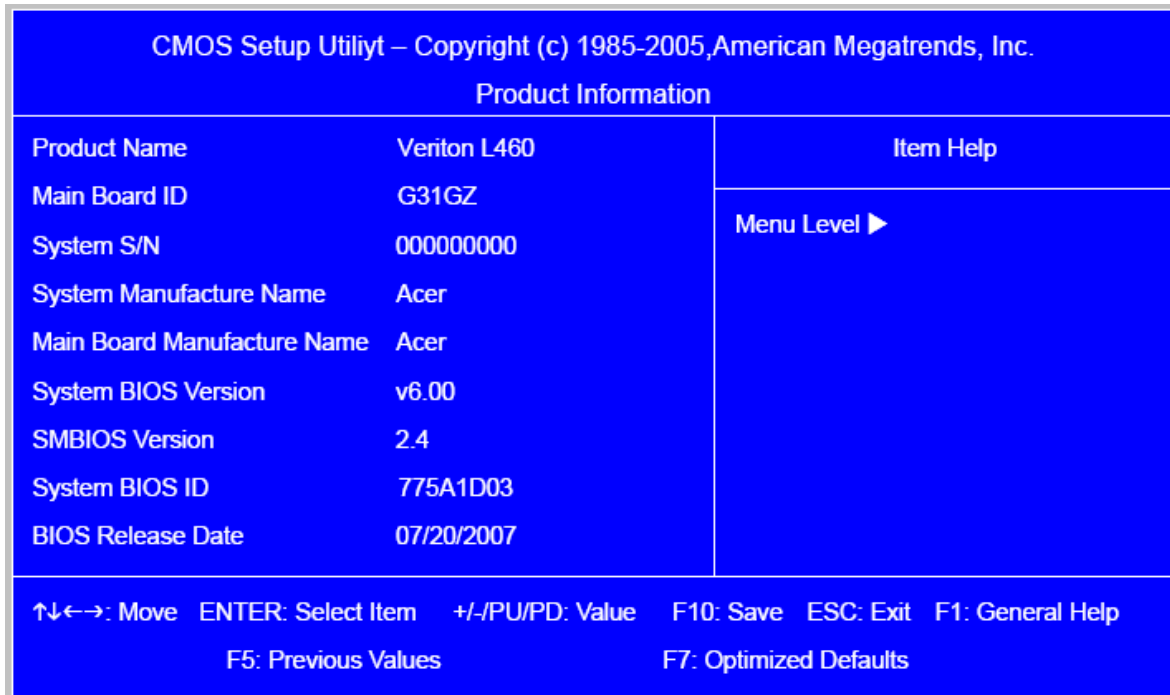

The following table describes the parameters found in this menu:

Parameter	Description
Production Name	This item lists the product name
System S/N	This item lists the system serial number
Main Board ID	This item lists the main board ID
Main Board S/N	This item lists the main board serial number
System BIOS Version	This item lists the system BIOS version
SMBIOS Version	This item lists the system SMBIOS version
System BIOS ID	This item lists the system BIOS ID
BIOS Release Date	This item lists the BIOS release date

Standard CMOS Setup

Select standard CMOS features from the main menu to configure some basic parameters in your system the following screen shows the standard CMOS features menu:

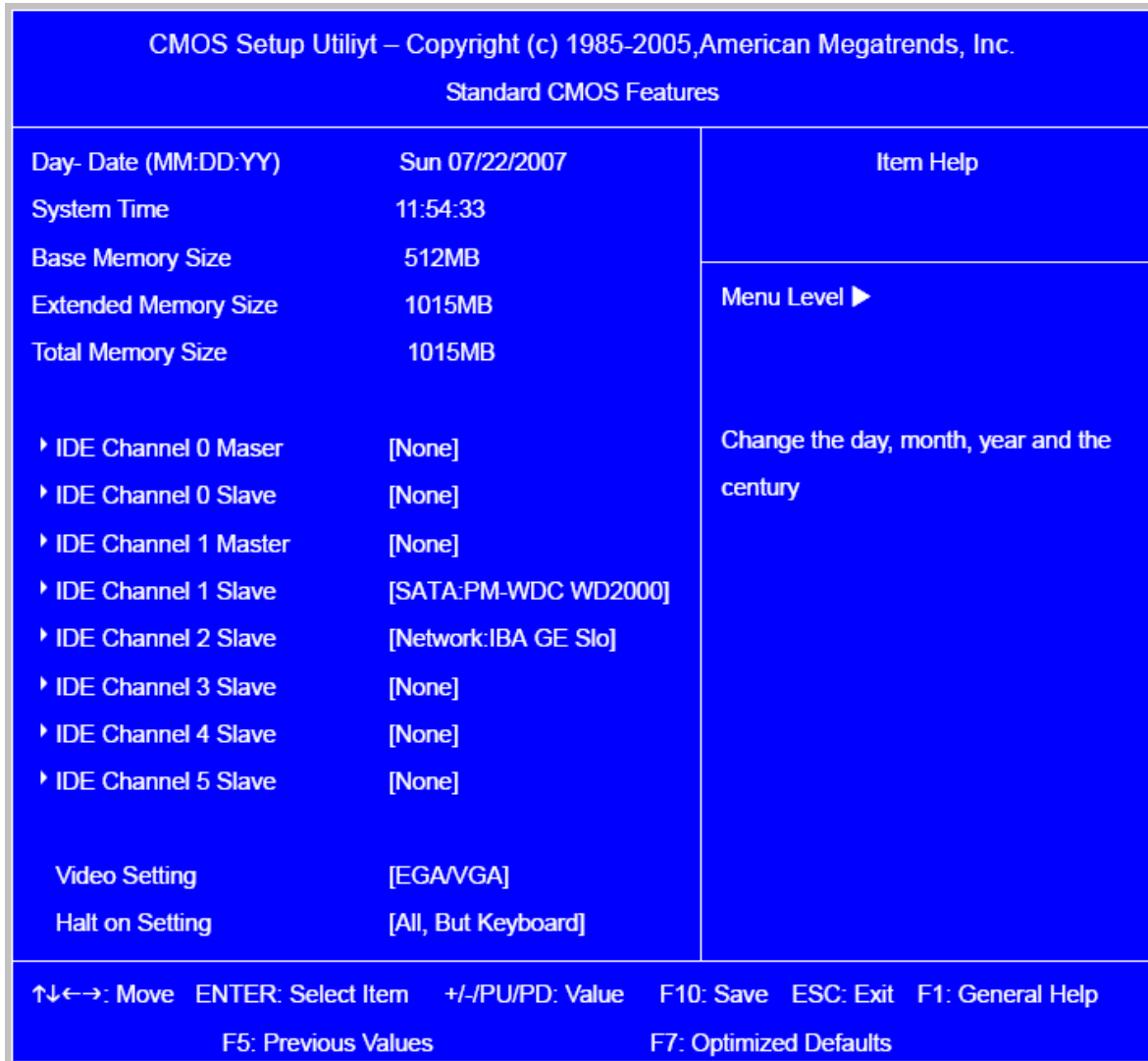

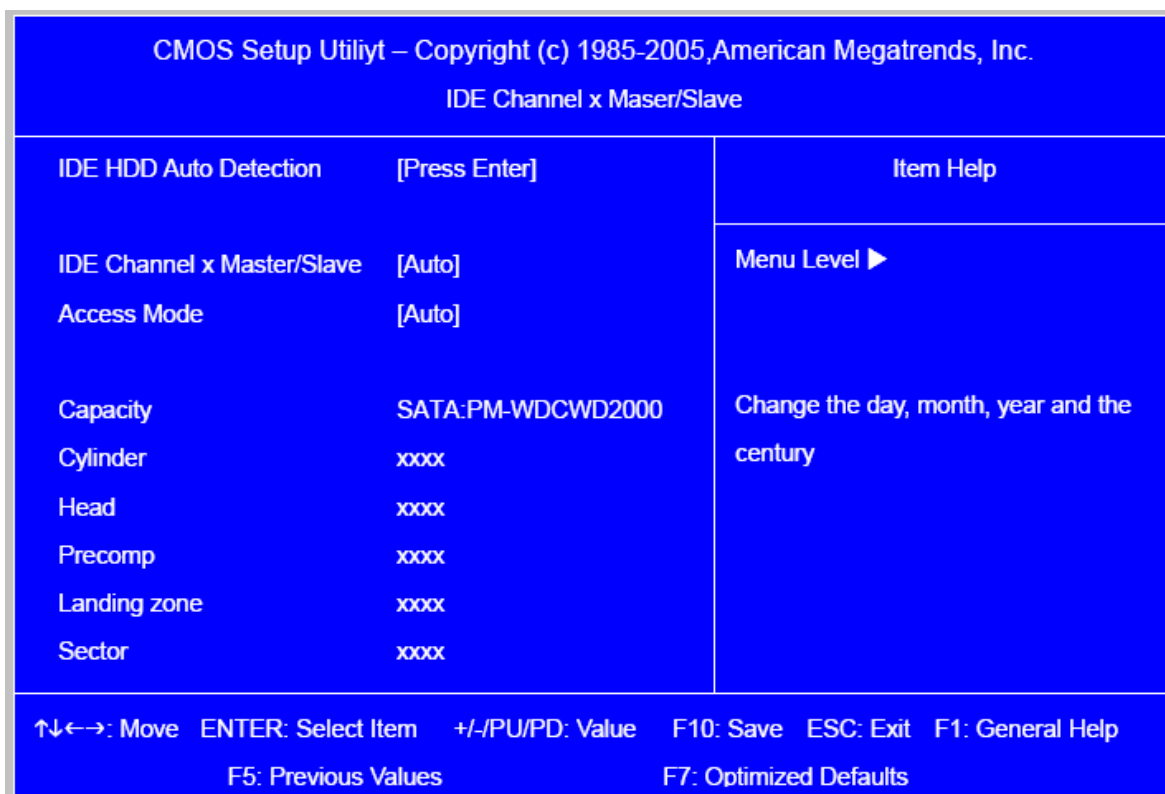

The following table describes the parameters found in this menu.

Parameter	Description	Options
Date	To set the date following the weekday-month-date-year format	Week: From [Sun.] to [Sat.], determined by BIOS and is display only Day: from [1] to [31] (or the maximum allowed in the month). Year: from 1999 to 2099
System Time	To set the time following the hour-minute-second format	The items format is [hour] [minute][second]. The time is calculated base on the 24-hour timer clock.
Base Memory Size	512MB for system base memory	

Parameter	Description	Options
Extended Memory Size	The BIOS determines how much extended memory is present during the POST. This is the amount of memory located above 1MB in the memory address map of CPU	
Total Memory Size	Total memory size for the system	
IDE Channel X Master IDE Channel X Slave	Hard disk drive connected to channel X master or slave port. To enter the IDE Master or Slave setup, press [Enter]. The IDE CD-ROM is always automatically detected	<p>[Enter] for detection options</p> <p>[Auto]: BIOS automatically detects IDE devices during POST (default)</p> <p>[None]: No IDE devices are used and the system will skip the automatic detection step and allow for faster system start up</p> <p>[Manual]: Manually input the correct settings</p> <p>[Access Mode]: To set the access mode for the hard drive.</p> <p>The four options are: CHS/LBA/Large/Auto (default: Auto) Cylinder: Number of cylinders Head: Number of heads Precomp: Write precomp Landing Zone: Landing Zone Sector: Number of sectors</p>
Video Setting	Select the type of primary video subsystem	
Halt on	This item enables use to select the situation if the BIOS stops the POST process and the notification	All Errors No Errors All, But Keyboard All, But Diskette All, But Disk/Key

Advanced Setup

The following screen shows the Advanced Setup:

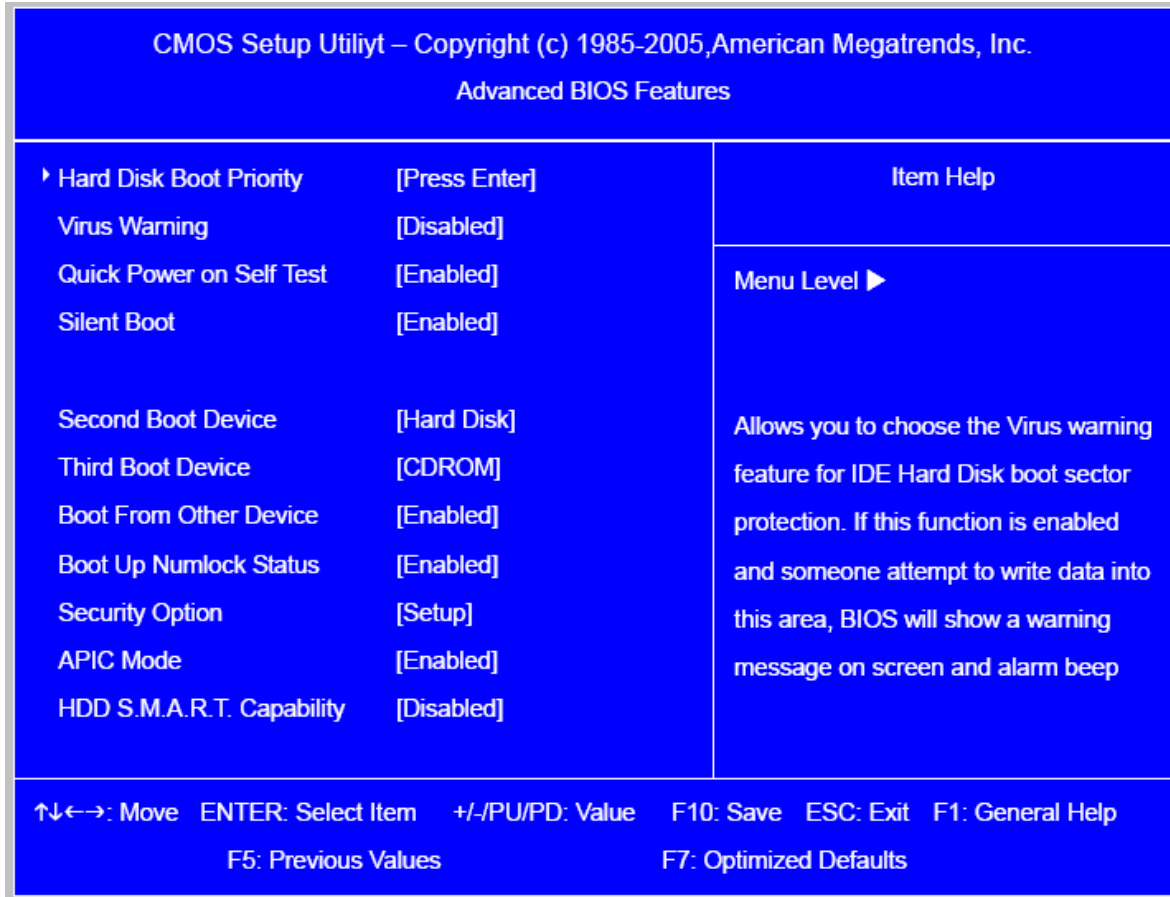

The following table describes the parameters found in this menu.

Parameter	Description	Options
Hard Disk Boot Priority	This features displays the Hard Disk Boot Device priority from high to low and allows users to set the Hard Disk Boot Device Priority. Press [Enter] to enter the setting screen. Use wory to select a device, then press <+> to move it up, or <-> to move it down the list. Press <ESC> to exit.	[Press Enter]

Parameter	Description	Options
Virus Warning	This feature allows you to enable the VIRUS warning function for IDE Hard Disk boot sector protection. If this function is enabled and there is someone attempts to write data to this area, BIOS will show a warning message on screen and the alarm will beep.	[Enabled], [Disabled]
Quick Power On Self Test	This feature allows the system to skip certain tests while booting. When this function is enabled, it will decrease the time needed to boot the system, which means to quick power on self-test function.	[Enabled], [Disabled]
Silent Boot	This feature allows you to enable or disable if the screen logo to display or not during POST	[Enabled], [Disabled]
First/Second/Third Boot Device	The item allows you to see the sequence of boot device where BIOS attempts to load the disk operation system.	[Floppy], [LS120], [Hard Disk], [CD-ROM], [ZIP], [USB-FDD], [USB-ZIP], [USB-CDROM], [USB-HDD], [LAN], [Disabled]
Boot From Other Devices	This item allows user to enable or disable to boot from other device	[Enabled], [Disabled]
Boot Up NumLock Status	This item allows user to enable or disable to set keyboard is number keys or arrow keys	[Enabled], [Disabled]
Security Option	This category allows you to limit access to the system and Setup, or just to Setup.	[System], [Setup]
APIC Mode	This option is used to set up enable or disable the APCI function	[Enabled], [Disabled]
HDD S.M.A.R.T Capability	S.M.A.R.T. which allows your hard disk to report any read/write errors and issue a warning when LDCM installed	[Enabled], [Disabled]

Advanced Chipset Setup

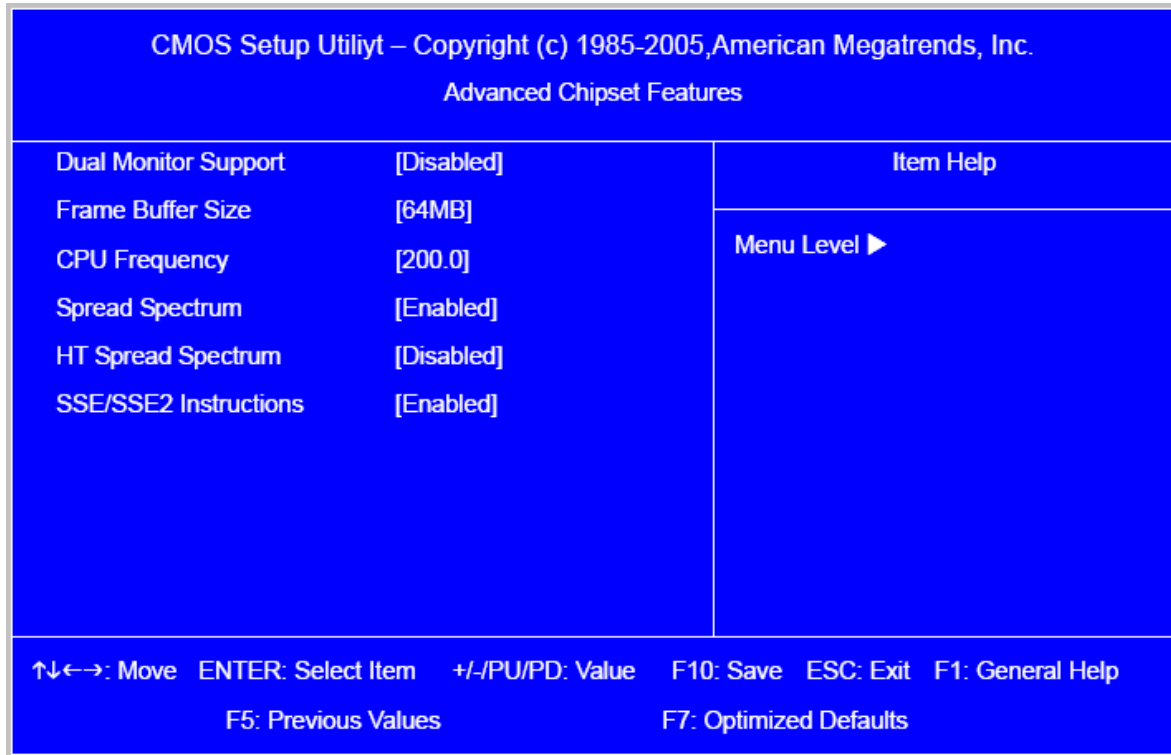

The following table describes the parameters found in this menu.

Parameter	Description	Options
Dual Monitor Support	This category allows you to enable or disable dual monitor support function	[Enabled], [Disabled]
Frame Buffer Size	This field displays how much frame buffer size of the system.	
CPU Frequency	This field allows you to determine CPU frequency of the system.	

Parameter	Description	Options
Spread Spectrum	When the system clock generator pulses, the extreme values of the pulse generate excess EMI. Enabling pulse spectrum spread modulation changes the extreme values from spikes to flat curves, thus reducing EMI. This benefit may in some case be outweighed by problems with timing-critical devices, such as a clock-sensitive SCSI device.	[Enabled], [Disabled]
HT Spread Spectrum	Enables or Disables HT Spread Spectrum. HT is Hyper Transport between CPU and North Bridge.	[Enabled], [Disabled]
SSE/SSE2 Instructions	<p>This feature controls the availability of the processor's SSE and SSE2 instruction sets. When enabled, the processor's SSE and SSE2 instruction sets are enabled. Software applications can make use of those instructions to better process large amounts of data quickly.</p> <p>When disabled, the processor's SSE and SSE2 instruction sets are disabled. Software applications will not be able to use those instructions to process multiple data elements simultaneously. However, the processor's MMX instruction set will still be available for use. It is highly recommended that you leave this BIOS feature at the default setting.</p>	[Enabled], [Disabled]

Integrated Peripherals

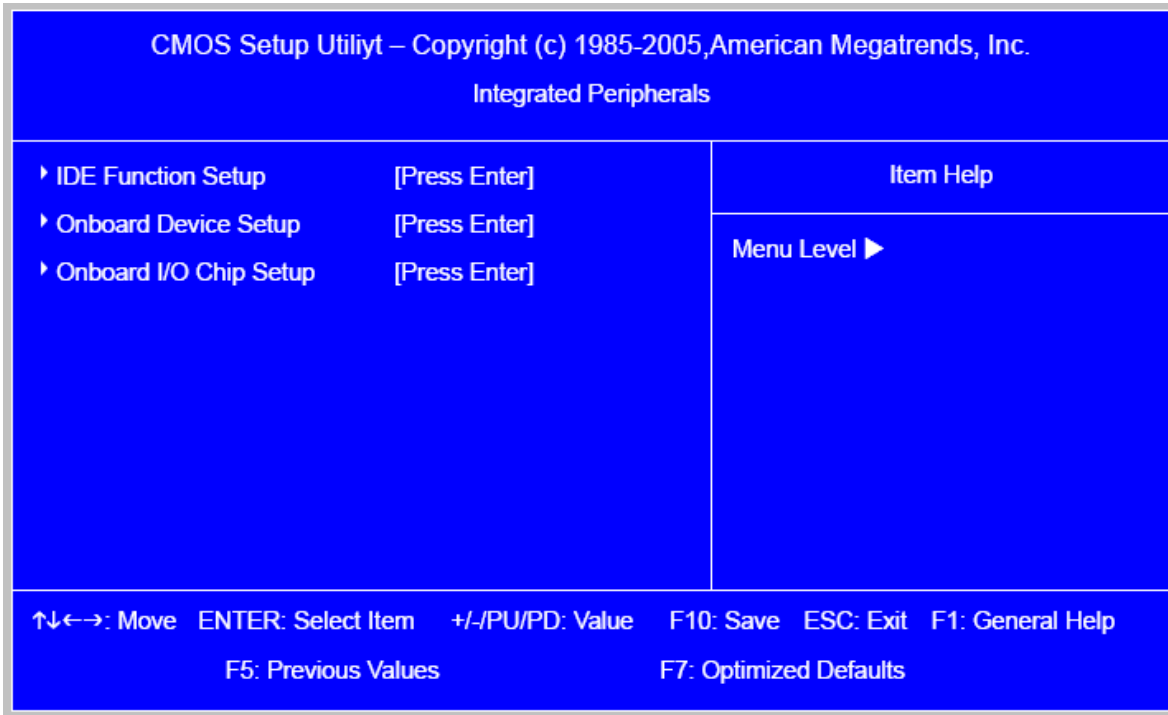

The following table describes the parameters found in this menu.

Parameter	Description	Options
IDE Function Setup	This page allows you to setup IDE function	[Press Enter]
Onboard Device Setup	This page allows you to setup onboard devices.	[Press Enter]
Onboard I/O Chip Setup	This page allows you to setup onboard I/O chip.	[Press Enter]

Integrated Peripherals-IDE Function Setup

CMOS Setup Utility – Copyright (c) 1985-2005, American Megatrends, Inc.

IDE Function Setup

OnChip IDE Channel0	[Enabled]	Item Help
Primary Master	PIO [Auto]	
Primary Slave	PIO [Auto]	
Primary Master	UDMA [Auto]	Menu Level ►
Primary Slave	UDMA [Auto]	
OnChip IDE Channel1	[Enabled]	
Primary Master	PIO [Auto]	
Primary Slave	PIO [Auto]	
Primary Master	UDMA [Auto]	
Primary Slave	UDMA [Auto]	
IDE DMA Transfer Access	[Enabled]	
SATA 1	[Enabled]	
SATA 2	[Enabled]	
IDE Prefetch Mode	[Enabled]	
IDE HDD Block Mode	[Enabled]	
SATA Port Speed Settings	[Auto]	

↑↓←→: Move ENTER: Select Item +/-/PU/PD: Value F10: Save ESC: Exit F1: General Help
 F5: Previous Values F7: Optimized Defaults

The following table describes the parameters found in this menu.

Parameter	Description	Options
IDE Primary/Secondary Master/Slave PIO	The four IDE PIO fields let you set a PIO mode (0-4) for each of the four IDE devices that the onboard IDE interface supports. Modes 0 through 4 provide increased performance. In Auto mode, the system automatically determines the best mode for each device.	
On-Chip IDE First/Second Channel	The Chipset contains a PCI IDE interface with support for two IDE channels. Select Enabled to activate the first and/or second IDE interface. Select Disabled to deactivate an interface, if you install a primary and/or secondary add-in IDE interface.	[Enabled], [Disabled]
IDE Primary/Secondary Master/Slave UDMA	UDMA (Ultra DMA) is a DMA data transfer protocol that utilized ATA transfer protocol that utilizes ATA commands and the ATA bus to allow DMA commands to transfer data at a maximum burst rate of 33 MB/s. When you select Auto in the four IDE UDMA fields (for each of up to four IDE devices that the internal PCI IDE interface supports), the system automatically determines the optimal data transfer rate for each IDE device.	
IDE DMA Transfer Access	This category allows you to enable or disable DMA transfer access of IDE device (or IDE HDD)	[Enabled], [Disabled]
SATA 1/2	Enable/Disable Serial-ATA 1 or Serial-ATA-2. SATA 1 control port 1 and 3, SATA 2 control port 2 and 4.	
IDE Prefetch Mode	The onboard IDE drive interfaces supports IDE prefetching, for faster drive accesses. If you install a primary and/or secondary add-in IDE interface, set this field to Disabled if the interface does not support prefetching.	

Parameter	Description	Options
IDE HDD Block Mode	Block mode is also called block transfer, multiple commands, or multiple sectors read/write. If your IDE hard drive supports block mode(most new drives do), select Enabled for automatic detection of the optimal number of block read/write per sector the drive can support.	[Enabled], [Disabled]
SATA PORT Speed Settings	This category allows you to determine the speed of SATA port.	[Auto],

Integrated Peripherals-Onboard Device Setup

CMOS Setup Utility – Copyright (c) 1985-2005, American Megatrends, Inc.		
Onboard Device Setup		
		Item Help
OnChip USB	[V1.1+V2.0]	Menu Level ►
USB Memory Type	[SHADOW]	
USB KB Legacy Support	[Enabled]	
USB Mouse Legacy Support	[Enabled]	
AC97 Audio	[Auto]	
MAC Lan	[Auto]	
MAC Lan Boot ROM	[Disabled]	
↑↓←→: Move ENTER: Select Item +/-/PU/PD: Value F10: Save ESC: Exit F1: General Help F5: Previous Values F7: Optimized Defaults		

The following table describes the parameters found in this menu.

Parameter	Description	Options
On Chip USB	This field allows you to determine on chip USB type or disable on chip USB.	[V1.1+V2.0], [V1.1]
UDB Memory Type	Use this item to change the type of USB memory to shadow or Base memory.	[Shadow], [Base Memory]
USB KB Legacy Support	This field enables or disables USB keyboard support function.	[Enabled], [Disabled]
USB Mouse Support	This field enables or disables USB mouse support function.	[Enabled], [Disabled]
AC 97 Audio	Change the on board Audio to auto or disabled	[Auto], [Disable]
MAC LAN	Enables or disables onboard LAN controller, If you wish to use the motherboard's onboard LAN controller, you should certainly enable this BIOS feature. You can disable this feature if you do not want to use the motherboard's onboard LAN controller. This may free up an IRQ for other devices to use. This is useful if your motherboard does not support APIC and have many devices that can not share IR Qs.	[Enabled], [Disabled]
MAC LAN Boot ROM	Enables or disables on board LAN boot ROM.	[Enabled], [Disabled]

Integrated Peripherals -Onboard I/O

Chip Setup

CMOS Setup Utility – Copyright (c) 1985-2005,American Megatrends, Inc.		
Onboard I/O Chip Setup		
Onboard FDC Controller	[Enabled]	Item Help
Onboard Serial Port 1	[3F8/IRQ4]	Menu Level ►
UART Mode Select	[IrDA]	
UR2 Duplex Mode	[Halt]	
Onboard Parallel Port	[378/IRQ7]	
Parallel Port Mode	[SPP]	
ECP Mode Use DMA	[3]	

↑↓←→: Move ENTER: Select Item +/-/PU/PD: Value F10: Save ESC: Exit F1: General Help
F5: Previous Values F7: Optimized Defaults

The following table describes the parameters found in this menu.

Parameter	Description	Options
Onboard FDC Controller	Select Enabled if your system has a floppy disk controller (FDC) installed on the system board and you wish to use it. If you install an add-in FDC or the system has no floppy drive, select Disabled in this field.	[Enabled]. [Disabled]
Onboard Serial Port 1	Select a logical COM port name and matching address for the serial port. Select an address and corresponding interrupt for the serial port.	
UR2 Duplex Mode	In an infrared port mode, this field appears. Full-duplex mode permits simultaneous two-direction transmission. Half-duplex mode permits transmission in one direction only at a time. Select the value required by the IR device connected to the IR port.	
Onboard Parallel Port	Select a logical LPI port address and corresponding interrupt for the physical parallel port.	[xxx+IRQx]
Parallel Port Mode	Select an operating mode for the onboard parallel (printer) port.	[Normal], [EPP], [EPP], [EPP+ECP]
ECP Mode used DMA	This item allows users to manually set the DMA channel for ECP mode	

Power Management

The Power Management menu lets you configure your system to most effectively save energy while operating in a manner consistent with your own style of computer use. The following screen shows the Power Management parameters and their default settings:

CMOS Setup Utility – Copyright (c) 1985-2005, American Megatrends, Inc.		
Power Management Setup		
		Item Help
ACPI Function	[Enabled]	
ACPI Suspend Type	[S3(STR)]	
Video off Method	[DPMS Support]	
HDD Power Down	[Disabled]	Menu Level ►
HDD Down In Suspend	[Disabled]	
Soft-Off by PWR-BTTN	[Delay 4 Sec]	
WOL (PME#) From Soft-Off	[Disabled]	
X WOR (R1#) From Soft-Off	Disabled	
USB Resume from S1/S3	[Disabled]	
Resume by Alarm	[Disabled]	
X Date of Month Alarm	0	
X Time(hh:mm:ss) Alarm	00:00:0	
POWER ON function	[BUTTON ONLY]	
PWRON After PWR-Fail	[Former-Sts]	

↑↓←→: Move ENTER: Select Item +/-/PU/PD: Value F10: Save ESC: Exit F1: General Help
F5: Previous Values F7: Optimized Defaults

The following table describes the parameters found in this menu.

Parameter	Description	Options
ACPI Function	This item allows you to enable or disable the ACPI function	[Enabled], [Disabled]
ACPI Suspend Type	This item specifies the power saving modes for ACPI function. S1 (POSP): The S1 sleep mode is a low power state.. In this state, no system context (SPU or chipset) is lost and hardware maintains all system context/ S3 (STR): The S3 sleep mode is s power-down state in which power is supplied only to essential components such as main memory and wake-capable devices and all system context is saved to main memory. The information stored in memory will be used to restore the PC to the previous state when an wake-up event occurs.	[S1 (POS)]: Set ACPI suspend type to S1/POS (Power On Suspend). [S3 (STR)]: Set ACPI suspend type to S3/STR
HDD Power Down	The setting controls how long a hard disk drive must be left idle before it spins down.	[Disabled], [Standby], [Suspend]
HDD Down In Suspend	Enables or Disables the functionality of HDD down in suspend	[Enabled], [Disabled]

Parameter	Description	Options
Soft-off by PWR/BTTN	When Enabled, turning the system off with the on/off button places the system in a very low-power-usage state, with only enough circuitry receiving power to detect power button activity or Resume by Ring activity.	[Instant-off]: Press down button then power off instantly [Delay 4 Sec.]: Press Power button 3 sec. to power off. Enter suspend if button is pressed less than 4 sec.
WOL (PME#) From Soft-Off	This category enables or disables wake-on-Lan from soft-off	[Enabled], [Disabled]
Resume by Alarm	You can set "Resume by Alarm" item to enabled and key in Date/Time to power on system.	[Disabled] [Enabled]: Enable alarm function to Power On system. If RTC Alarm Lead to Power On is Enabled, Date(of Month) Alarm: Everyday, 1~31 Time(hh:mm:ss) Alarm: (0~23):(0-59):(0~59)
POWER ON Function	Select the method to power on the system	[Button Only], [Keyboard 98], [Hot Key], [Mouse Left], [Mouse Right]
POWER After PWR-Fail	This field allows you to determine the power status to on/off or former-sts after the system	[FORMER-Sts], [On], [Off]

PCI/PnP Setup

CMOS Setup Utility – Copyright (c) 1985-2005, American Megatrends, Inc.

PnP/PCI Configuration

Init Display First	[PCIEx]	Item Help
Reset Configuration Data	[Disabled]	
Resources Controlled By	[Auto(ESCD0)]	Menu Level ▶
X IRQ Resources	Press Enter	
PCI/VGA Palette Snoop	[Disabled]	
** PCI Express relative items**		
Maximum Payload Size	[4096]	

↑↓←→: Move ENTER: Select Item +/-/PU/PD: Value F10: Save ESC: Exit F1: General Help
F5: Previous Values F7: Optimized Defaults

The following table describes the parameters found in this menu.

Parameter	Description	Options
Init Display First	Initialize the AGP video display before initializing any other display device on the system. Thus the AGP display becomes the primary display.	
Reset Configuration Data	Normally, you leave this field Disabled. Select Enabled to reset Extended System Configuration Data (ESCD) when you exit Setup if you have installed a new add-on and the system reconfiguration has caused such a serious conflict that the operating system cannot boot	[Enabled], [Disabled]
Resources Controlled By	This item allows user to assign PnP resource (I/O address, IRQ&DMA channels) for Plug and Play compatible devices automatically or manually	[Auto] [Manual]
IRQ Resources	When resource are controlled by manually, assign each system interrupt a type , depending on the type of device using the interrupt. Option: [PCI Device]: Assign this IRQ for PCI device. [Reserved]: Reserve this IRQ for other device.	[Press Enter]
PCI/VGA Palette Snoop	This option is only very rarely needed. It should be left at "Disabled" unless a video device specifically requires the setting enabled upon installation.	[Disabled], [Enabled]
Maximum Payload Size	This field displays maximum payload size of the system	[128-4096]
PCI 1/2 IRQ Assignment	This item allows user to assign PCI IRQ for device	[Auto], [3] , [4] , [5] , [6] , [7], [10] , [11] , [12] , [14] , [15]

PC Health Status

CMOS Setup Utility – Copyright (c) 1985-2005, American Megatrends, Inc.

PC Health Status

CPU Vcore	1.312V	Item Help
+3.30V	3.312V	
+5V	5.026V	
+12V	11.840V	Menu Level ►
+5USB	5.053V	
Voltage Battery	2.92V	
Current CPU Temperature	54°C/129°F	
Current SYSTEM Temperature	45°C/113°F	
CPU FAN Speed	0RPM	
System FAN Speed	0 RPM	

↑↓←→: Move ENTER: Select Item +/-/PU/PD: Value F10: Save ESC: Exit F1: General Help
F5: Previous Values F7: Optimized Defaults

The following table describes the parameters found in this menu:

Parameter	Description	Options
V core	Detect system's voltage status automatically	
CPU Temperature	Detect CPU Temperature automatically	
CPU/SYSTEM FAN Speed (RPM)	Detect CPU/SYSTEM Fan Speed Status automatically	
CPU Smart FAN Control	The item displays the system Smart Fan Function status. It is always enabled by system.	

Frequency/Voltage Control

CMOS Setup Utility - Copyright (C) 1985-2005,American Megatrends,Inc. Frequency/Voltage Control	
Manufacturer: Intel	Help Item
Ratio Status: Unlocked (Min:06,Max:10)	
Ratio Actual Value: 10	Options
CPU Frequency : 266MHz	Disabled
Auto Detect DIMM/PCI CLK Enabled	Enabled
Spread Spectrum Enabled	
↑↓←→ :Move Enter: Select +/-:Value F10:Save ESC:Exit F1:General Help F9:Optimized Defaults	

The following table describes the parameters found in this menu:

Parameter	Description	Options
Auto Detect DIMM/PCI CLK	This option allows you to enable/disable the feature of auto detecting the clock frequency of the installed PCI bus.	Enabled Disabled
Manufacturer	This item specifies CPU Manufacturer	Intel
CPU frequency	This item specifies CPU frequency	266MHz
Spread Spectrum	When the motherboard's clock generator pulses, the extreme values (spikes) of the pulses create EMI (Electromagnetic Interference). The spread Spectrum function reduces the EMI generated by modulating the pulses so that the spikes of the pulses are reduced to flatter curves. If you do not have any EMI problem, leave the setting at Disabled for optimal system stability and performance. But if you are plagued by EMI, setting to Enabled for EMI reduction. Remember to disable Spread Spectrum if you are overlooking because even a slight jitter can introduce a temporary boost in clock speed which may just cause your over locked processor to lock up.	Enabled

Load Default Settings

This option opens a dialog box that lets you install defaults for all appropriate items in the Setup Utility.

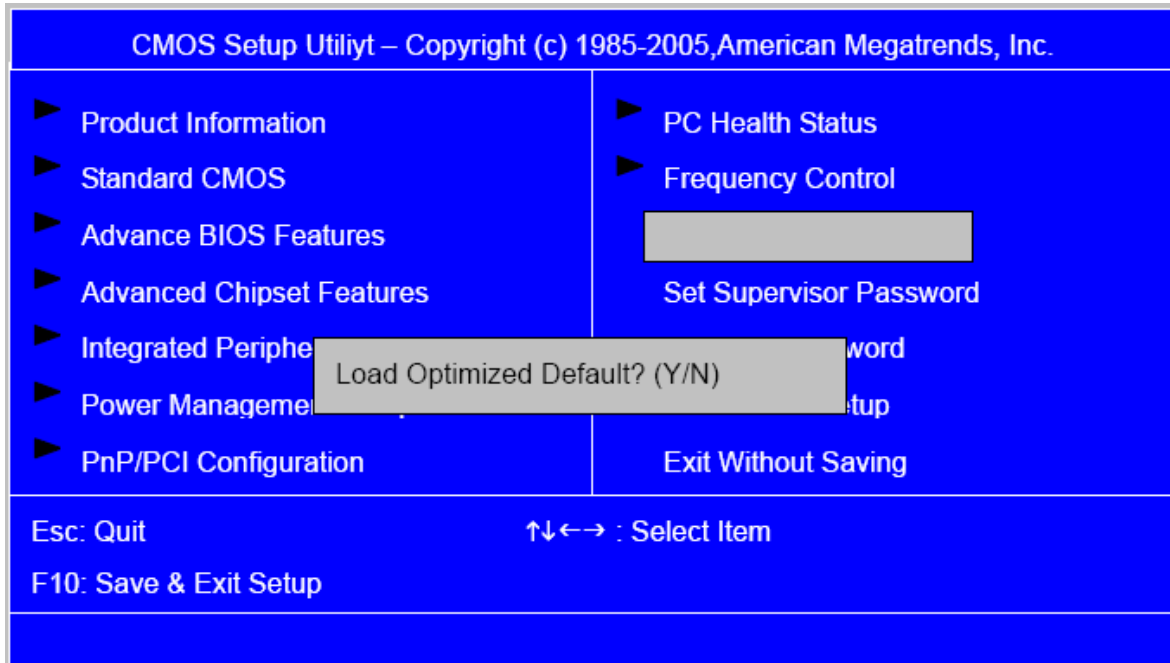

Parameter	Description	Options
Load Default Settings	Select the field loads the factory defaults for BIOS and Chipset Features, which the system automatically detects. This option opens a dialog box that lets you install optimized defaults for all appropriate items in the Setup Utility.	

Set Supervisor/User Password

When this function is selected, the following message appears at the center of the screen to assist you in creating a password.

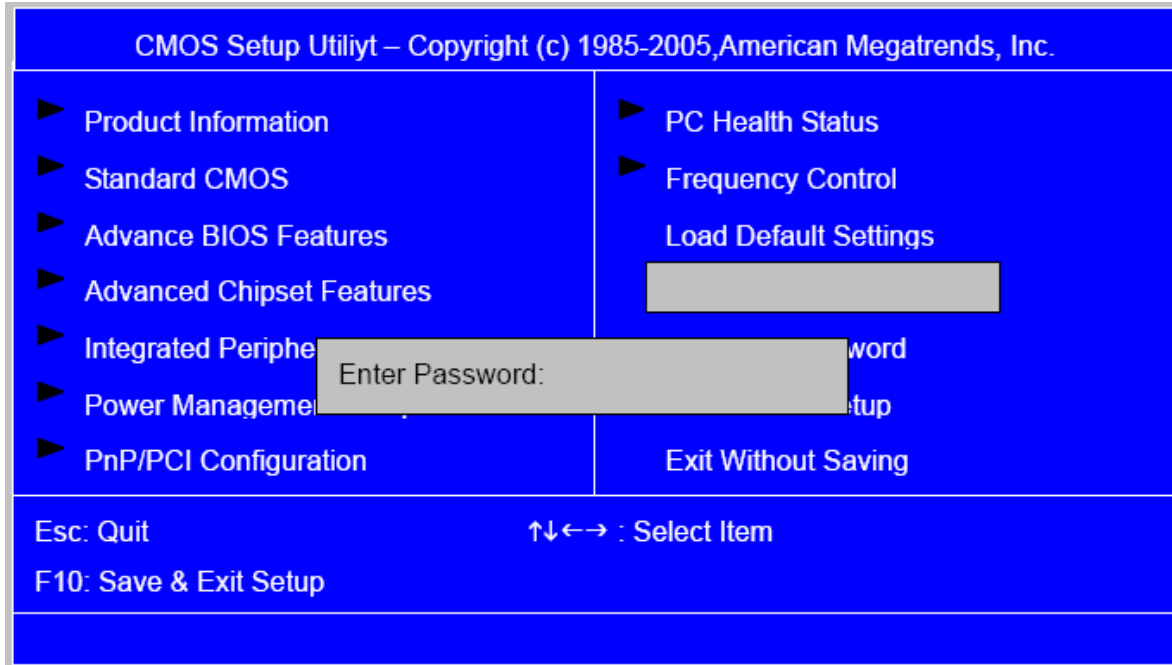

Parameter	Description	Options
Set Supervisor/User Password	<p>When this function is selected, the following message appears at the center of the screen to assist you in creating a password.</p> <p>ENTER PASSWORD</p> <p>Type the password, up to eight characters, and press<Enter>. The password typed now will clear any previously entered password from CMOS Memory. You will be asked to confirm the password. Type the password again and press <Enter>. You may also press<ESC> to abort the selection.</p> <p>PASSWORD DISABLED</p> <p>To disable password, just press<Enter> when you are prompted to enter password with empty. A message will confirm the password being disabled.</p> <p>If you have selected “System” in “Security Option” of “BIOS Feature Setup” menu, you will be prompted for the password every time the system reboots or any time you try to enter BIOS Setup. If you have selected “Setup” at “Security Option” from “BIOS Features Setup” menu, you will be prompted for the password only when you enter BIOS Setup.</p> <p>Supervisor Password has higher priority than User Password. You can use Supervisor Password when booting the system or entering BIOS Setup to modify all settings.</p>	

Save & Exit Setup

Highlight this item and press <Enter> to save the changes that you have made in the Setup Utility and exit the Setup Utility.

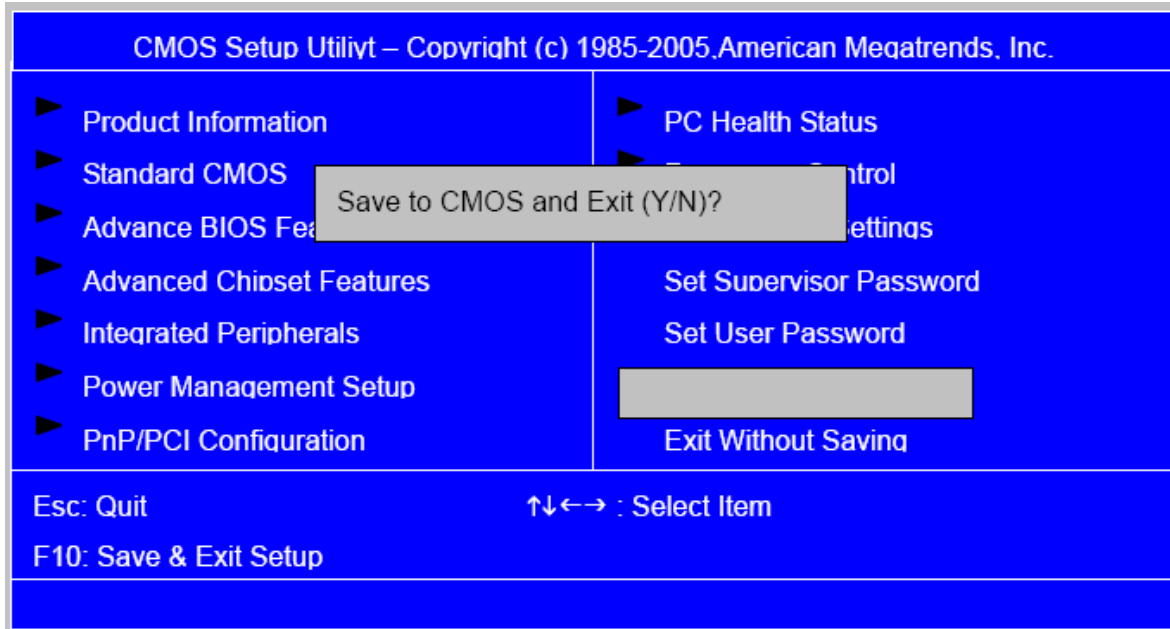

Parameter	Description	Options
Save & Exit Setup	Press <Enter> to save the changes that have made in the Setup Utility and exit the Setup Utility. Press<Y> to save and Exit or <N> to return to the main menu.	

Exit Without Saving

Highlight this item and press <Enter> to discard any changes that you have made in the Setup Utility and exit the Setup Utility.

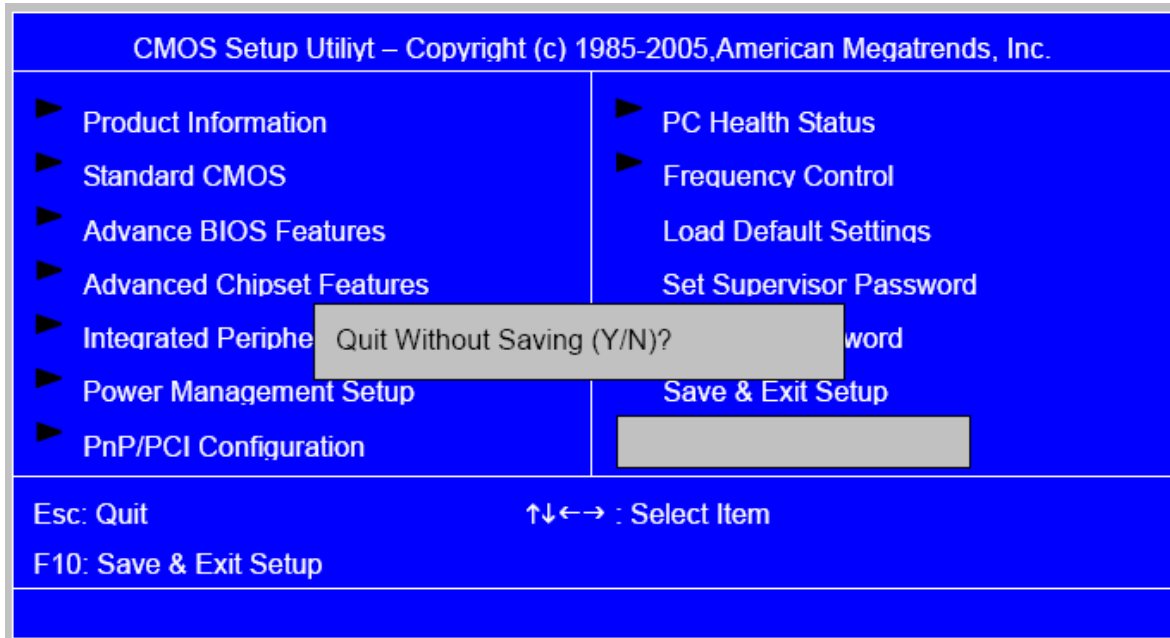

Parameter	Description	Options
Exit Without Saving	Press<Enter> to discard any changes and exit the Setup Utility	

Machine Disassembly and Replacement

To disassemble the computer, you need the following tools:

Wrist grounding strap and conductive mat for preventing electrostatic discharge.

Wire cutter.

Phillips screwdriver (may require different size).

NOTE: The screws for the different components vary in size. During the disassembly process, group the screws with the corresponding components to avoid mismatches when putting back the components.

General Information

Before You Begin

Before proceeding with the disassembly procedure, make sure that you do the following:

1. Turn off the power to the system and all peripherals.
2. Unplug the AC adapter and all power and signal cables from the system

Disassembly Procedure

This section tells you how to disassemble the system when you need to perform system service. Please also refer to the disassembly video, if available.

CAUTION: Before you proceed, make sure you have turned off the system and all peripherals connected to it.

Aspire M1620 Standard Disassembly Process

Opening the System

- 1 Place the system unit on a flat, steady surface.



- 2 Release the screw that shown below.



- 3 Remove the top cover.



4 As shown pull three button up.

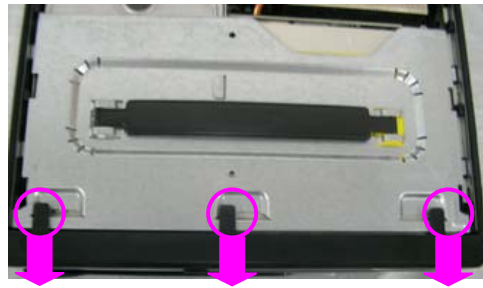

5. Take the belt shown as below.

Release this screw first



6. Detach ODD & HDD data and power cable.

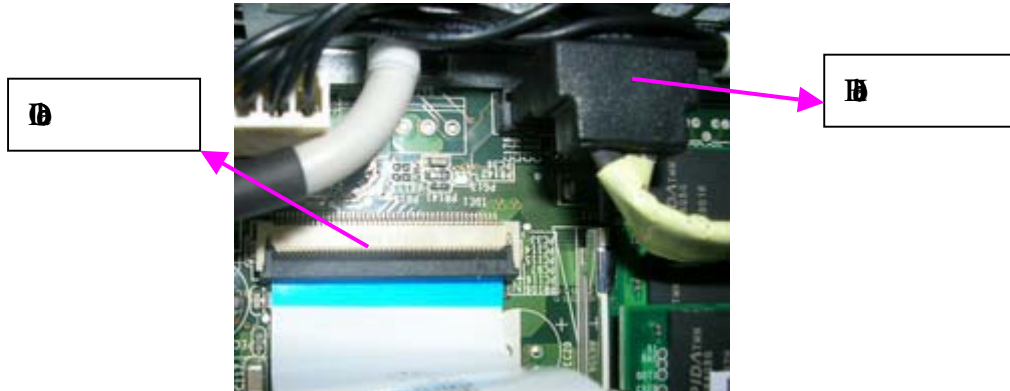

7. Detach HDD data and power cable.

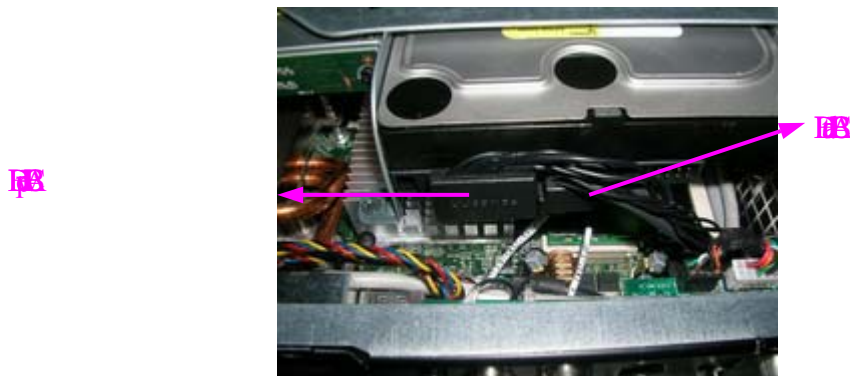

8 Detach HDD SATA Data and power cable attach to MB



9 Detach LED cable.



10 Release four screws as shown below and disconnect the CPU cools.

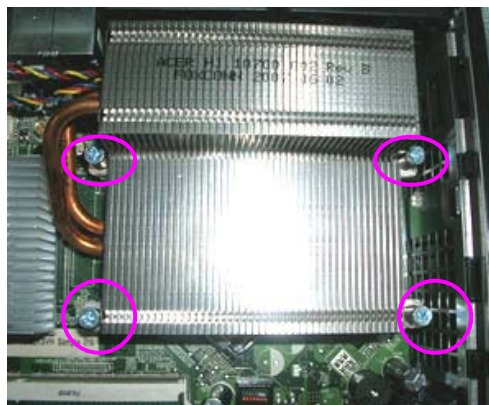

-
- 1 Disconnect the CPU.



- 2 Remove the Memory.

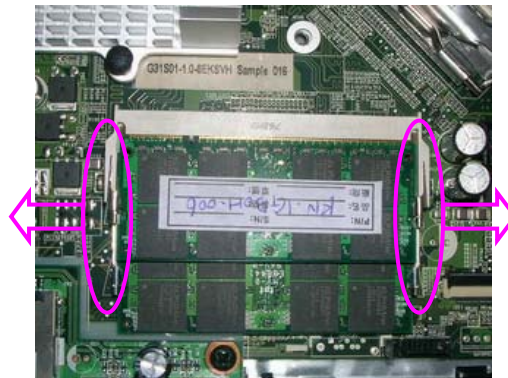

- 3 Remove the Video-in cable and TV-out cable.



- 4 Remove the Front audio cable.



5. Remove the Front card reader cable and Front audio cable.



16. Remove the Video-in cable.

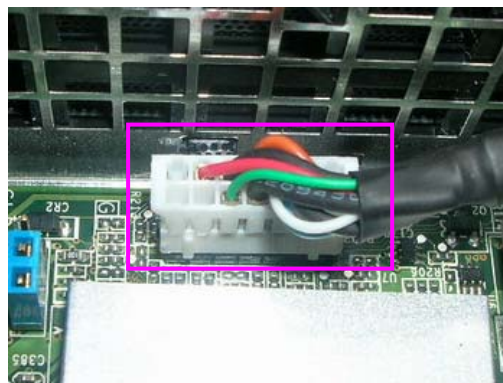

17. Remove the FM cable and TV cable.

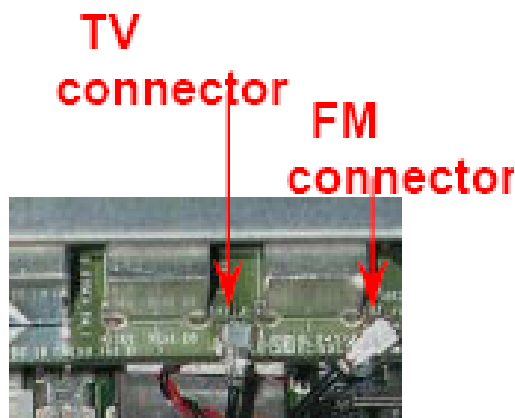
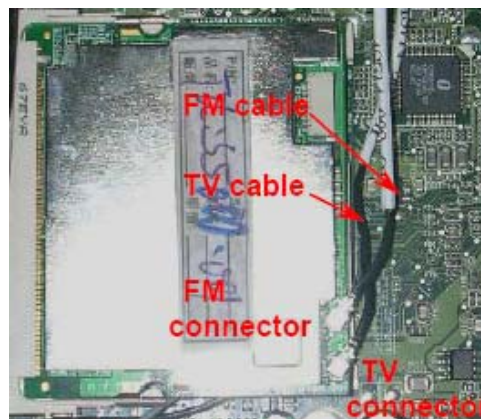

18.Remove the SYS_FAN A Cable A&B.

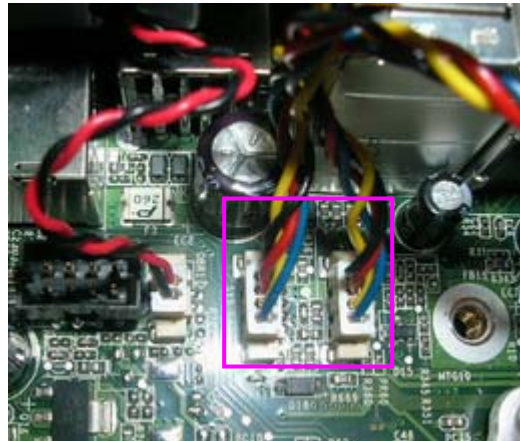

19.Release eight screws then remove the System FAN.



20.Remove the TV Card.



21. Remove the Wireless LAN Cable then release the LAN card.



22. Remove the Audio and Video Board.

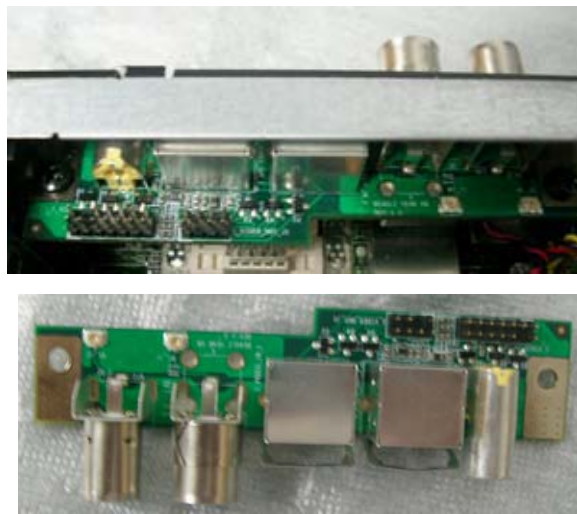

23. Remove USB & Audio module.



24.Remove the MB.

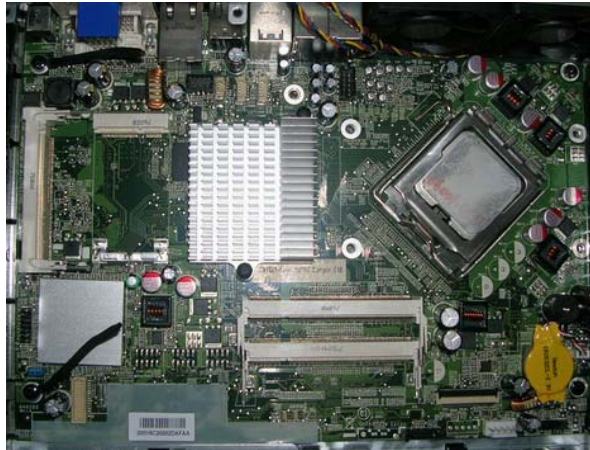

VeritonL460 Standard Disassembly Process

Opening the System

1. Place the system unit on a flat, steady surface.



2. Release the screw that shown below.



3. Remove the top cover.



4.As shown pull three button up.

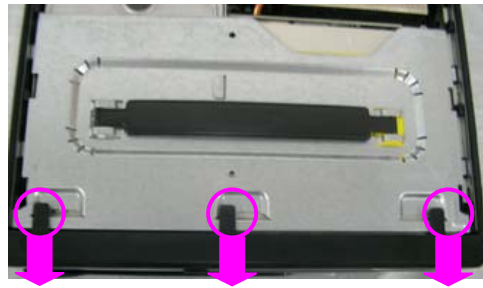

5.Take the belt shown as below.

Release this screw first



6.Detach ODD & HDD data and power cable.

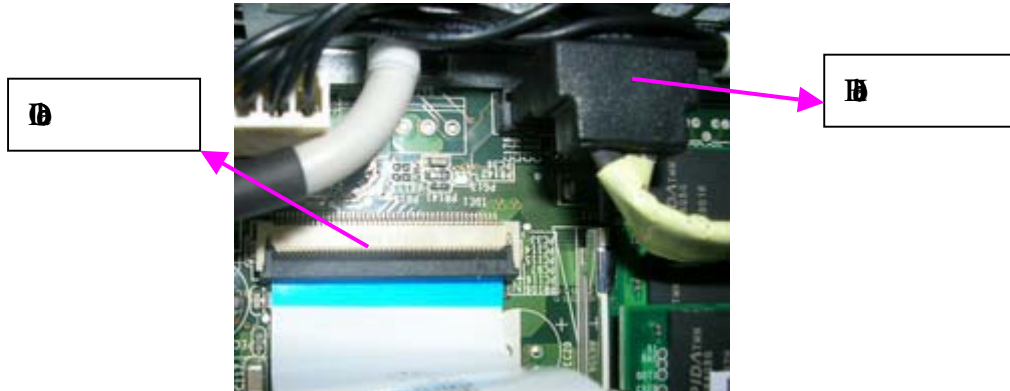

7.Detach HDD date and power cable.

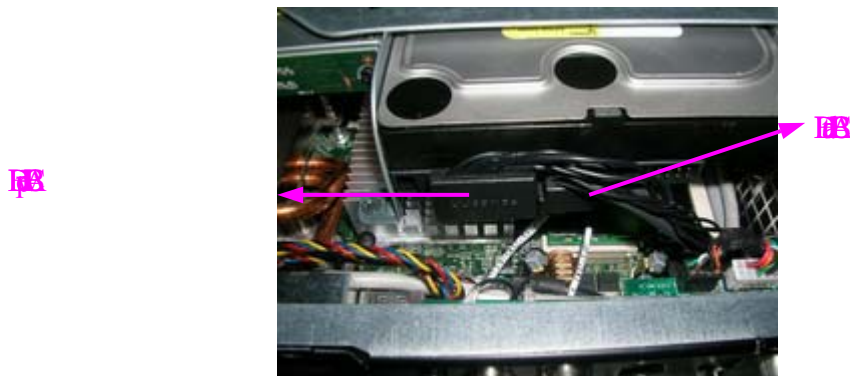

8. Detach HDD SATA Data and power cable attach to MB



9. Detach LED cable.



10. Release four screws as shown below and disconnect the CPU cools.

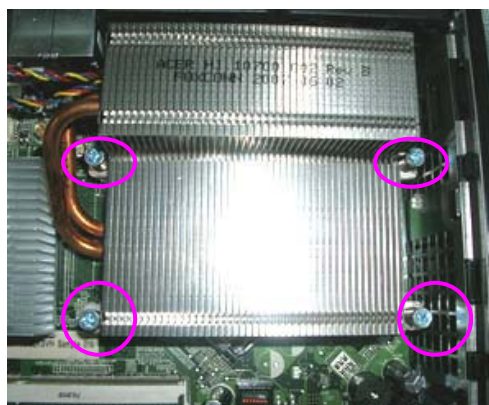

11. Disconnect the CPU.



12. Remove the Memory.

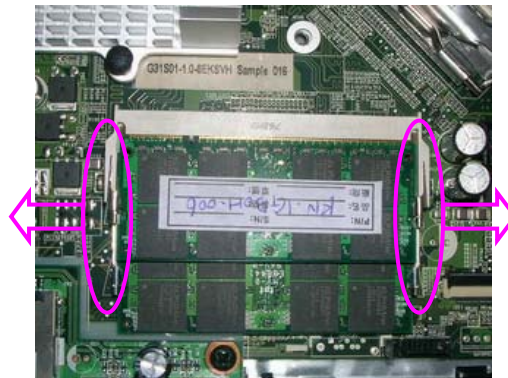

13. Remove the Video-in cable and TV-out cable.



14. Remove the Front audio cable.



15. Remove the Front card reader cable and Front audio cable.



16. Remove the Video-in cable.

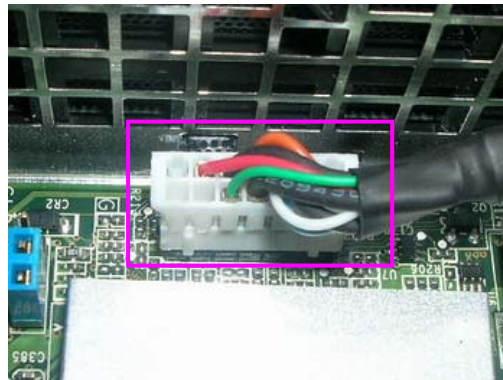

17. Remove the FM cable and TV cable.

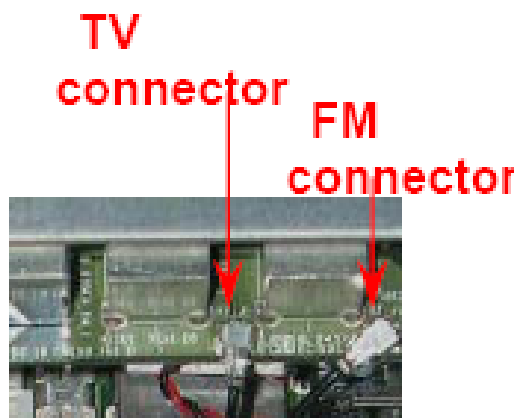
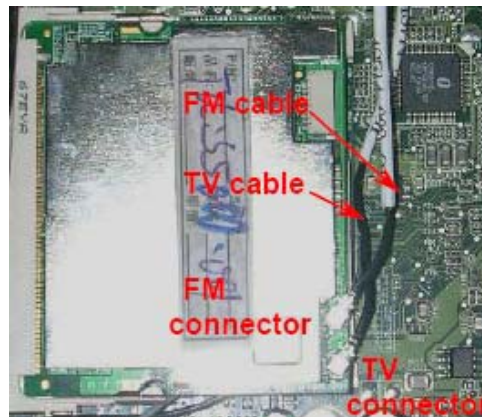

8 Remove the SYS_FAN A Cable A&B.

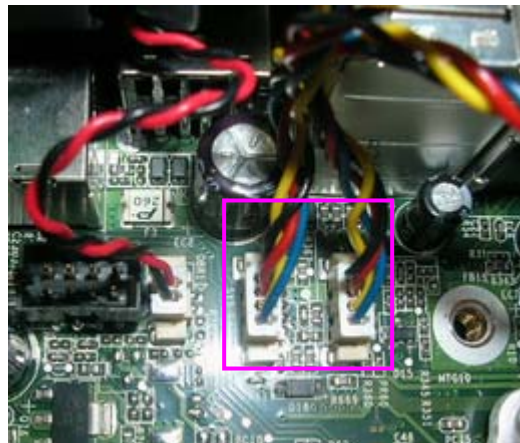

9 Release eight screws then remove the System FAN.



10 Remove the TV Card.



21. Remove the Wireless LAN Cable then release the LAN card.

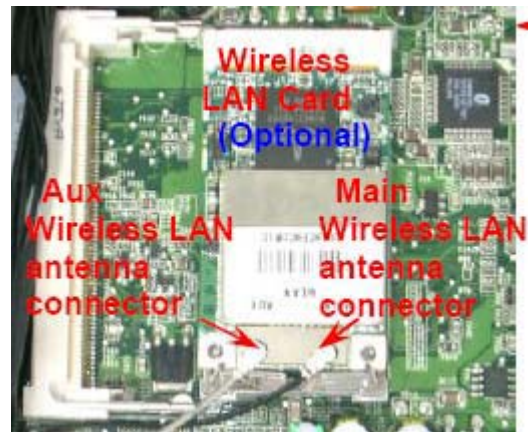

2 Remove the Audio and Video Board.

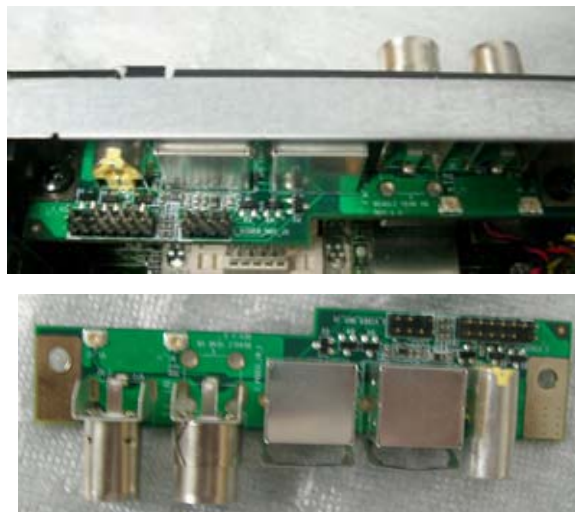

3 Remove USB & Audio module.



2 Remove the MB.

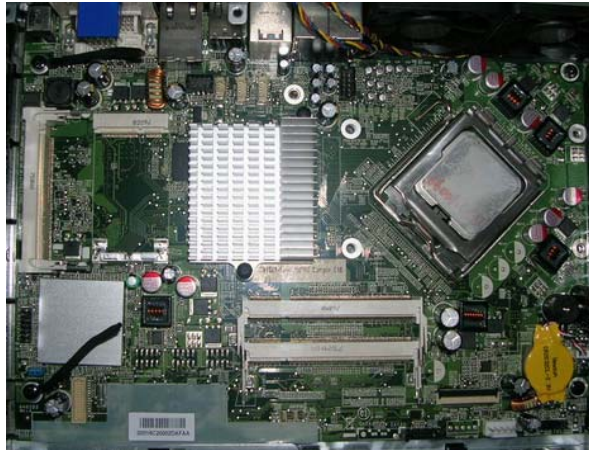

Troubleshooting

Please refer to generic troubleshooting guide for troubleshooting information relating to following topics:

- Power-On Self-Test (POST)
- POST Check Points
- POST Error Messages List
- Error Symptoms List

Jumper and Connector Information

Jumper Setting



This section explains how to set jumpers for correct configuration of the main board.

Setting Jumper

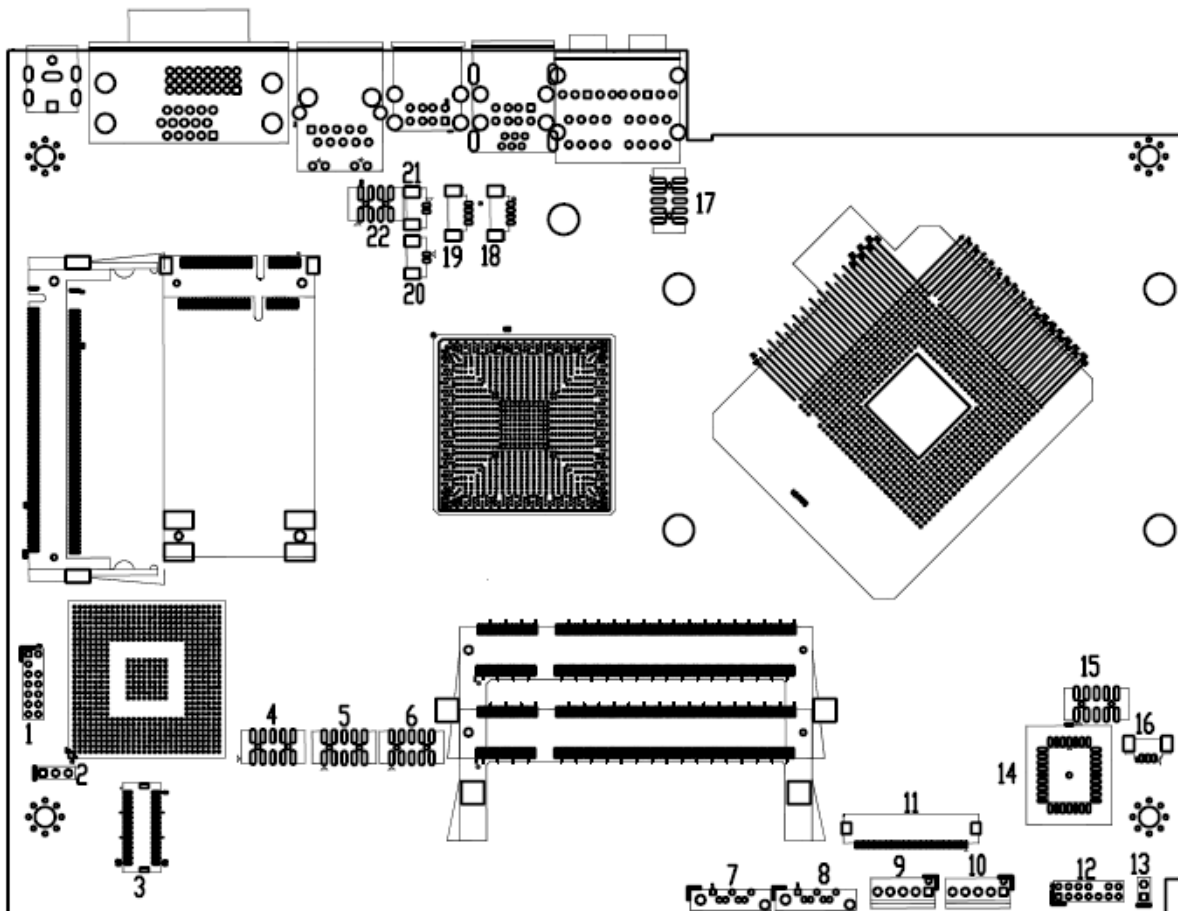
Use the motherboard jumpers to set system configuration options. Jumpers with more than one pin are numbered. When setting the jumpers, ensure that the jumper caps are placed on the correct pins.



1. Clear CMOS jumper(No.2)

jumper	symbol	Description	Function
 3 Pin		1-2 close	Clear CMOS
		2-3 close	Normal (Default)

MB On-Board Connectors		
No.	Connector marking	Description
1	MINIDIN1	SVIDEO Signal In header
2	CLR_CMOS1	Clear CMOS
3	FUSB1394	Front USB and 1394 header
4	F_1394_1	Front 1394 header
5	F_USB1	Front USB header 1
6	F_USB2	Front USB header 2
7	SATA2	SATA device connector 2
8	SATA1	SATA device connector 1
9	SATAP5CN1	ODD Power connector
10	SATAP12CN1	HDD Power connector
11	IDE1	IDE device connector
12	FP1	Front Panel Switch/LED
13	INTR1	Chassis Intruder
14	U9	BIOS Socket
15	IR	IR header
16	BAT1	Battery connector
17	FAUDIO1	Front Audio header
18	SYS_FAN2	SYS fan header2
19	SYS_FAN1	SYS fan header1
20	NB-FAN1	NB fan header
21	OBR1	One button recovery header
22	TVSPDIF1	SPDIF OUT header

FRU (Field Replaceable Unit) List

This chapter gives you the FRU (Field Replaceable Unit) listing in global configurations of **Aspire M5620 Veriton T551/M661/S661**. Refer to this chapter whenever ordering for parts to repair or for RMA (Return Merchandise Authorization).

NOTE: Please note WHEN ORDERING FRU PARTS, that you should check the most up-to-date information available on your regional web or channel (<http://aicsl.acer.com.tw/spl/>, if you do not own a specific account, you can still access the system with guest; guest). For whatever reasons a part number change is made, it will not be noted in the printed Service Guide. For ACER-AUTHORIZED SERVICE PROVIDERS, your Acer office may have a DIFFERENT part number code to those given in the FRU list of this printed Service Guide. You MUST use the local FRU list provided by your regional Acer office to order FRU parts for repair and service of customer machines.

Exploded Diagram

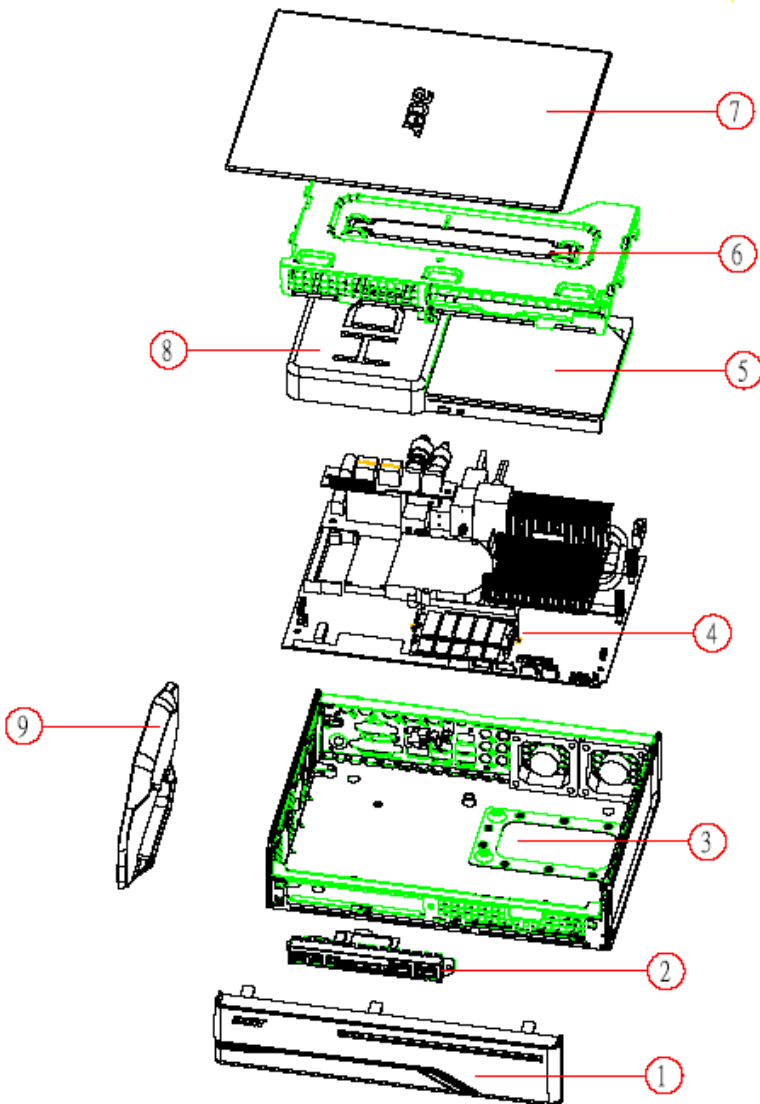

LABEL	DESCRIPTION
1	BEZEL
2	FRONT IO
3	CHASSIS
4	MOTHERBOARD
5	SLIM ODD
6	ODD AND HDD BRACKET
7	TOP COVER
8	HDD
9	PEDESTAL

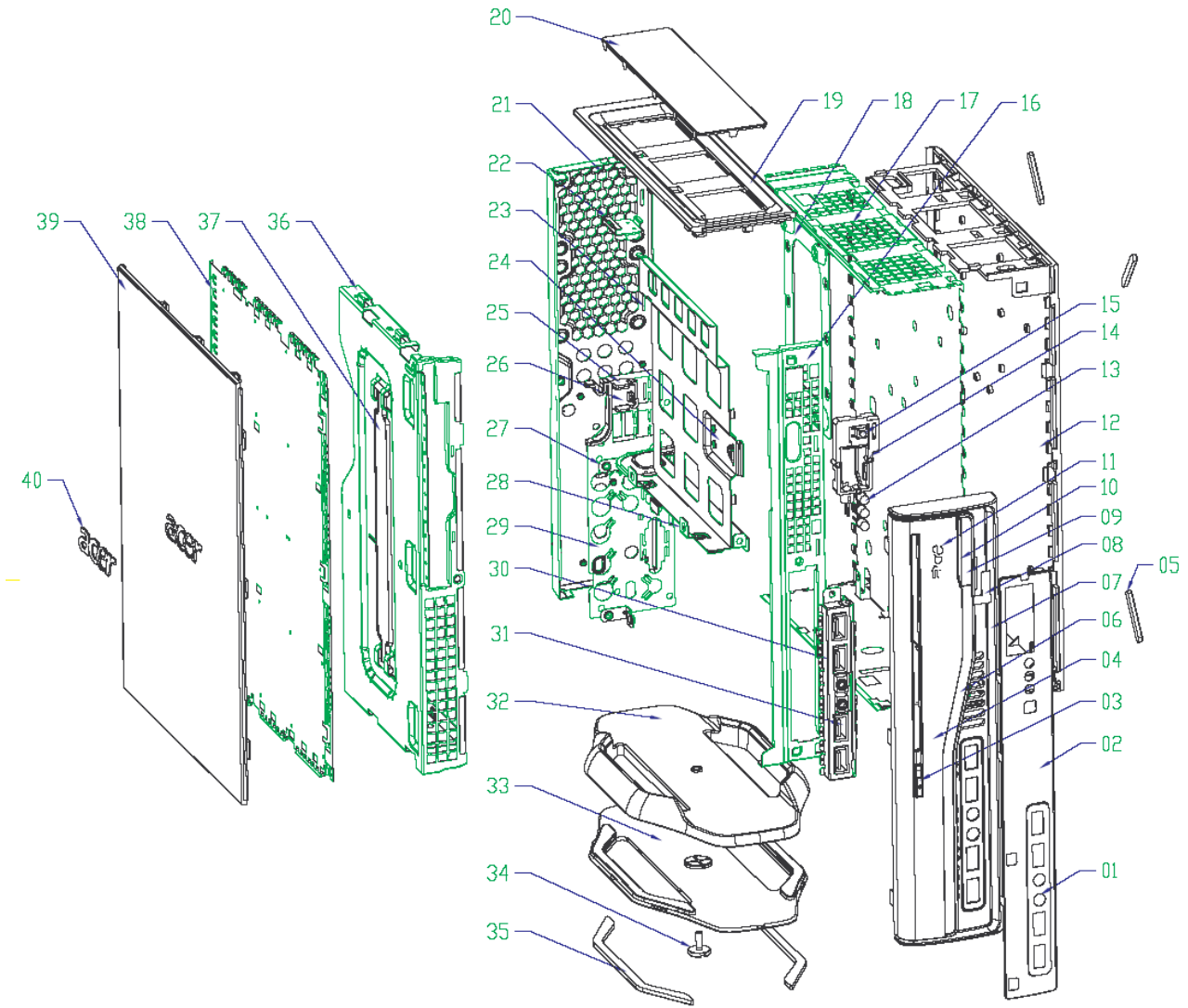

40	ACER_LOGO1	AL	1	
39	TOP_COVER	ABS	1	
38	TOP-SHIELD	SPTE	1	
37	HD_BKT_HANDLE	PP	1	
36	ODD-BKT	GI	1	
35	FOOT_PEDestal	RUBBER	2	
34	HUSKY_PEDestal_SCREW	GI01B	1	
33	HUSKY_PEDestal_COVER	ABS	1	
32	HUSKY_PEDestal	ABS	1	
31	USB_PCB_ASM	STANDARD	1	
30	SHEETMETAL-USB-BOX	GI	1	
29	SHEETMETAL-ID	SUS	1	
28	ODD-BKT-03	GI	1	
27	DAUGHTER-BOARD	GI	1	
26	DDR_PCB_ASM	STANDARD	1	
25	DDR_HOLDER	ABS	1	
24	SHEETMETAL+ODD-CLIP	SUS	1	
23	ODD-BKT-02	GI	1	
22	INTRUSION-BKT	GI	1	
21	ACERPOWER_BACK-ID	GI	1	
20	VENT-COVER-NEW	· 网	1	
19	SIDE_COVER	ABS	1	
18	MB_SUPPORT	GI	1	
17	BOTTOM-SHIELD	SPTE	1	
16	FRONT	ABS	1	
15	POWER_SWITCH_ASM	STANDARD	1	
14	SWITH-HOLDER	ABS	1	
13	LED	STANDARD	4	
12	HUSKY_U_BASE	ABS	1	
11	ACER_LOGO2	STANDARD	1	
10	POWER_MYLAR	PC	1	
9	LENS	PC	1	
8	HUSKY_LENS_MYLAR	PC	1	
7	HUSKY_BEZEL	ABS	1	
6	BEZEL_MYLAR	PC	1	
5	FOOT_U_BASE	RUBBER	4	
4	HUSKY-BEZEL-COVER	ABS	1	
3	BUtTON	ABS	1	
2	FAN_COVER	· 网	1	
1	USB_MYLAR	PC	1	
NO.	PART NAME	MATERIAL	QTY	REMARK

Free Manuals Download Website

<http://myh66.com>

<http://usermanuals.us>

<http://www.somanuals.com>

<http://www.4manuals.cc>

<http://www.manual-lib.com>

<http://www.404manual.com>

<http://www.luxmanual.com>

<http://aubethermostatmanual.com>

Golf course search by state

<http://golfingnear.com>

Email search by domain

<http://emailbydomain.com>

Auto manuals search

<http://auto.somanuals.com>

TV manuals search

<http://tv.somanuals.com>