

## Table of Contents

MPC-68K System Construction Example .....	2
MPC-68K Series ~16-Bit CPU Controller ~ .....	4
MPC-LNK .....	8
MPC-816 Series ~ 8-Bit CPU Controller ~ .....	10
MPC Peripherals ~ Common for MPC-68K and MPC-816 ~ .....	14
How to Deal with Noise .....	15
FTMW (FTM – Work Bench).....	16
List of Compatible Connectors .....	16
Request to Our Customers .....	17

# Please Try Controlling by MPC. Your “Device” will Change from That Day.

MPC uses the latest flash ROM! Equipped with an on-board ROM-conversion function, it is a board-type controller with complete protection against noise (RS-232C and pulse generation are also photo-isolated).

MPC is also equipped with complicated commands and functions.

However, multi-axis control is enabled immediately after the power is turned on, as there is simple support by a BASIC-like language.

## Programming Device

Your personal computer such as PC98, DOS/V, etc. can be used as is. The file format is in easily-editable ASCII data, which is supported by a terminal software “FTM” (its Windows version is also available).

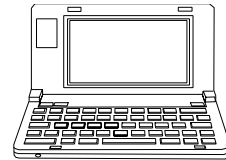

## Language

This is a BASIC-like interpreter. Even a beginner can program immediately. Also, abundant commands make it possible to write complicated applications. Also, although it's BASIC-like, it's a full-featured product equipped with multitasking.

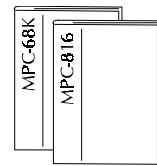

## I/O Control

Its dedicated I/O realizes 24~768-point control. Both bit processing and parallel processing are supported by dedicated commands, which allows a wide application.

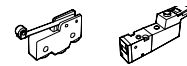

## Pulse Generation

MPC-816 and MPC-68K can control a stepping/servo motor of up to 50 and 400 kpps, respectively. Instead of simple support for one axis at a time, commands are prepared for even an XY-orthogonal 4-axis robot that includes palletizing. It can also deal with S-shape acceleration/deceleration.

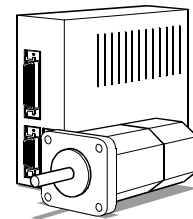

## Necessary Things for Startup

The following are initially necessary to MPC.

To be prepared by the customer:

A personal computer (PC98DOS, DOS/V, or Windows)

DC24V power (necessary for making MPC work)

Wiring sockets and contacts, a pressure-attaching tool (JAE product) or PS-50SEN-D4T1-1D, etc. Other necessary connectors depend on products. Please refer to the manual.

Connectors, socket, and contacts (in the case of individual wires)

Control contacts

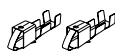

030-51304-001(JAE)

For socket housing(PS-D4C50)

Pressure-attaching tool

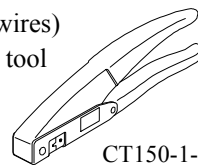

CT150-1-PSSF(JAE)

## Our Products

Cable set (for PC98 and DOS/V compatible machines)

FTM terminal software for programming (for PC98, DOS/V machines, and Windows)

Main unit (must contain MPC-816 or MPC-68K)

Manual (attached at the first purchase)

## Selection Guideline

MPC-816 series are inexpensive and compact for controlling up to 4 axes within 50 kpps and I/O 200 points. MPC-68K can be used for controlling multiple axes within 40 kpps and I/O 500 points. Both of them are equipped with RS-232C for the user. Also, MPC-68K can support complicated character processing by a high-level language. The MPC-816 interpreter (TNYFSC®) is a simple language, and the MPC-68K interpreter (ADVFSC®) is a full-featured BASIC language (computation is limited to 4-byte integers). Also, we have MPC-683 for large-scale high-speed processing and floating-point computation.

# MPC-68K System Construction Example

MPC is a BASIC-like multitasking interpreter, which is a FA controller capable of multiple-axis and communication processing as well as I/O of course.

Products of ACCEL are inside [ ].

**[Terminal software FTM, FTMW32]**  
 Programming & teaching personal computer  
 NEC 9801  
 Toshiba J3100  
 IBM PC/AT compatible machines  
 Windows 95, NT

**[MPC-68K (FSC)]**  
 Main CPU  
 RS-232C 3CH

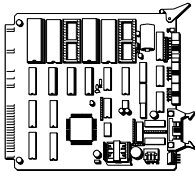

**[MPG-405]**  
 4-axis PG board  
 MAX 400 Kpps  
 Origin port

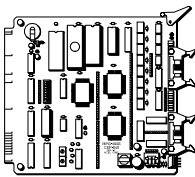

**[MPG-405]**

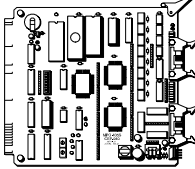

**[MPG-405]**

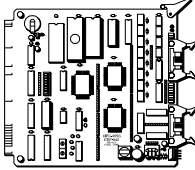

**[MIP-048]**  
 Input dedicated  
 48 points  
 Maximum 8 boards

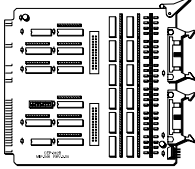

**[MOP-048]**  
 Output dedicated  
 48 points  
 Maximum 8 boards

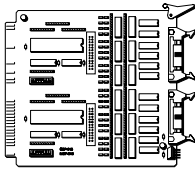

**[RACK-68K]**  
 6 slots  
 Maximum 3 boards  
 Connecting possible

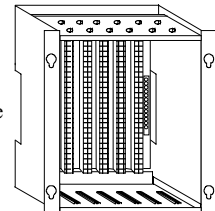

**[Cable DOS/V 98]**  
 RS-232C CH1

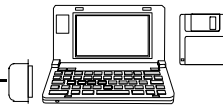

RS-232C CH2 Touch panel

RS-232C CH0 Image processing device

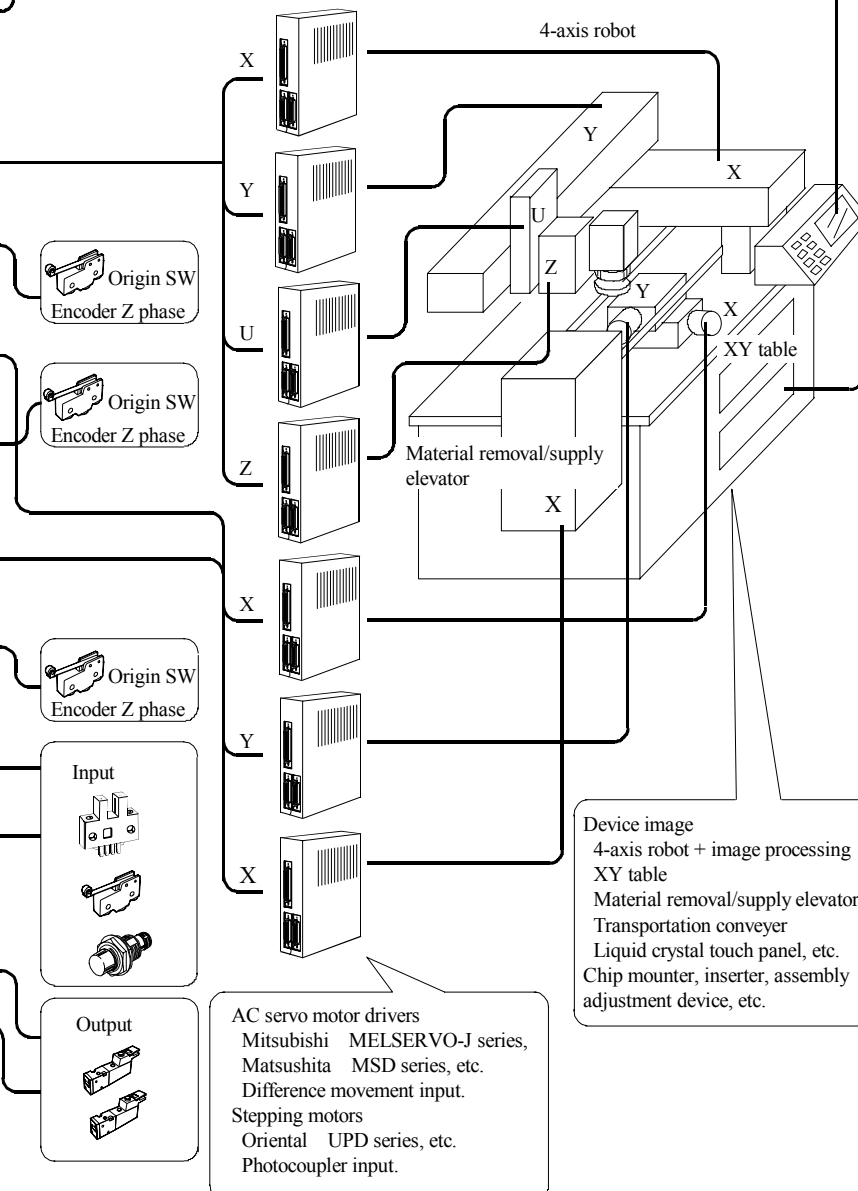

**Device image**  
 4-axis robot + image processing  
 XY table  
 Material removal/supply elevator  
 Transportation conveyer  
 Liquid crystal touch panel, etc.  
 Chip mounter, inserter, assembly adjustment device, etc.

AC servo motor drivers  
 Mitsubishi MELSERVO-J series,  
 Matsushita MSD series, etc.  
 Difference movement input.  
 Stepping motors  
 Oriental UPD series, etc.  
 Photocoupler input.

\* Connecting two slots or more may require a terminator-compatible board MBK-68K.

DC 12V ~ DC 24V is supplied to each board of the MPC series, RS-ISO, and PIF-422.  
 For the details of MPC program and hardware, see the "USER'S MANUAL". Consultation on the MPC construction is available. Feel free to contact us.

## MPC-68K Expandability

! Supported

### MBK-68

! Display during program execution (7SEG)  
! Touch panel support

### MRS-402

! Communication with RS-232 function  
\* TCP/IP support  
\* User customizable

### MPC-SLINK

! Wiring-saving system, SLINK  
(Two 128-point modules loaded)

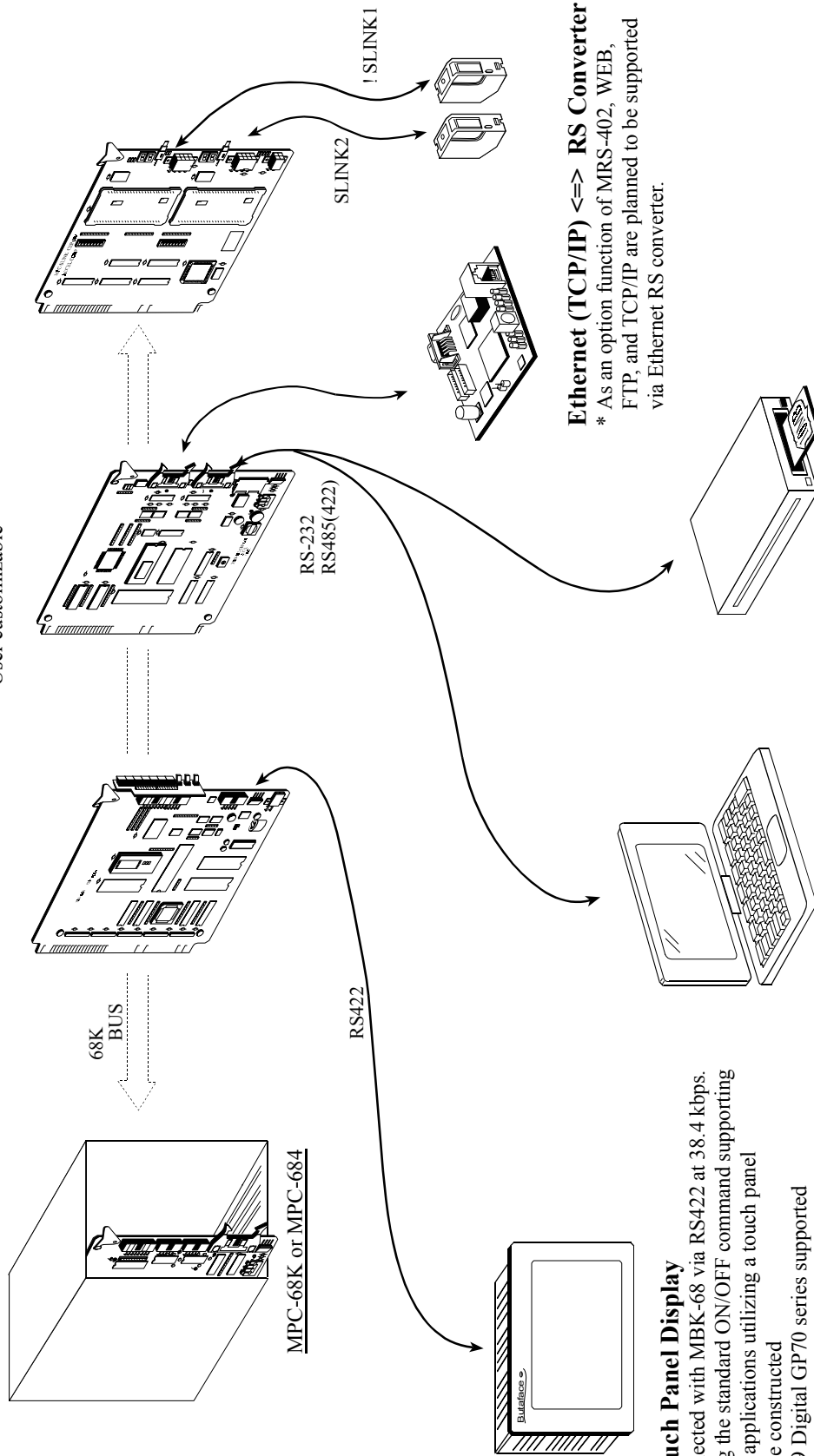

### Touch Panel Display

Connected with MBK-68 via RS422 at 38.4 kbps.  
Using the standard ON/OFF command supporting 68K, applications utilizing a touch panel can be constructed  
! 98/9 Digital GP70 series supported

### Ethernet (TCP/IP) <=> RS Converter

\* As an option function of MRS-402, WEB, FTP, and TCP/IP are planned to be supported via Ethernet RS converter.

# MPC-68K Series ~16-Bit CPU Controller ~

## MPC-684

### High-Speed CPU Board

### 4 Outputs, 8 Inputs

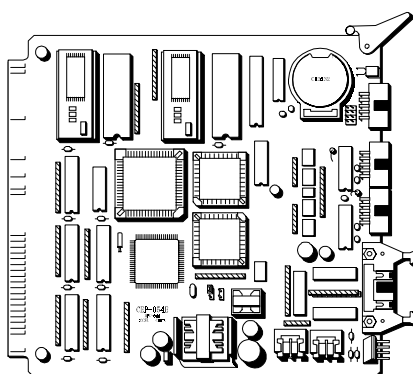

[Characteristics]

This is a high-speed CPU board equipped with two RS-232C channel. By its installed interpreter (ADVFS<sup>®</sup>), programming is possible in a BASIC-like environment. MPC-683 supports an execution speed more than twice as fast as 68K, and floating-point computation.

[Specification]

Power source: DC 12V~24V battery retained for 5 years (w/o external power supply at room temperature).

- (1) CPU: MC68340 20M clock. 4M SRAM\*2 + 4M FROM\*2.  
Control I/O: 8-point photocoupler input (4-point open collector output).  
RS232c: 2CH
- (2) Self-consumed current: 500 mA (1A power source installed)

[Option] MC688XXFN-25 Coprocessor (for floating point calculations)

- |               |                                  |     |    |
|---------------|----------------------------------|-----|----|
| [Accessories] | (1) Power connector (H4P-SHF-AA) | JST | *1 |
|               | (2) Contacts (BHF-001T-0.8SS)    | JST | *4 |

## MPC-68K

### Main CPU Board

### 4 Outputs, 8 Inputs

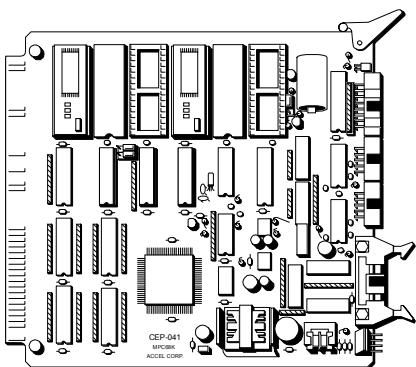

[Characteristics]

This is a CPU board equipped with two RS-232C channels. By its installed interpreter (ADVFS<sup>®</sup>), programming is possible in a BASIC-like environment. In spite of its compactness, it is equipped with two 4M-bit flash ROMs, and its program area of about 10000 steps can be used by an actual machine without any procedure such as ROM conversion or compiling. It can also be used as a pulse generator by itself. Its bus is C-bus-based, so an I/O board for 98 can also be directly used.

- (1) [Specification]  
Power source: DC 12V~24V battery retained for 5 years (w/o external power supply at room temperature).
- (2) CPU: TMP68301F-16 16 MHz. 1M SRAM\*4 + 4M FROM\*2.  
Control I/O: 4-point open collector output. 8-point photocoupler input.  
RS232c: Photoisolated, user 2CH.  
Self-consumed current: 250 mA (1A power source installed)

- |               |                                  |     |    |
|---------------|----------------------------------|-----|----|
| [Accessories] | (1) Power connector (H4P-SHF-AA) | JST | *1 |
|               | (2) Contacts (BHF-001T-0.8SS)    | JST | *4 |

## MPG-405

### High-Speed S-Shape Acceleration/Deceleration PG Board (400K)

### 4-Axis Output, 8-Origin Input

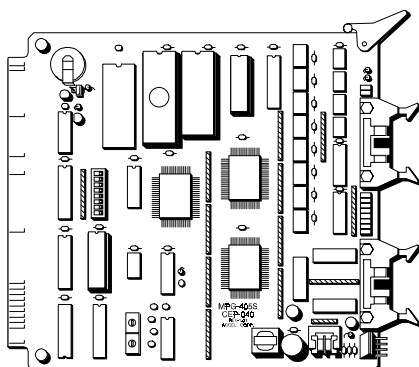

[Characteristics]

This is a dedicated pulse-generation board equipped with the maximum pulse rate of 400 kpps (two-axis linear interpolation). It is an upper-compatible board that can replace MPG-68K. Because it uses dedicated pulse generation (except GO, RM, DEFTBL, XPLS, and WPLS), DDA computation, and counter IC, high-speed pulse generation and arc interpolation have become possible. The arc interpolation is up to 200 Kpps. Also, because it is equipped with an S-shape acceleration/deceleration function, vibration prevention of the device is also effective.

- (1) [Specification]  
Power source: DC 12V~24V battery retained for 5 years (w/o external power supply at room temperature).
- (2) CPU: TMP84C015BF, KM3701, X3202, etc.  
Pulse output: 4-axis/RS422 specification (photoisolated).  
Consumed current: 180 mA

- |               |                                   |        |    |
|---------------|-----------------------------------|--------|----|
| [Accessories] | (1) Power connector (H4P-SHF-AA)  | JST    | *1 |
|               | (2) Contacts (BHF-001T-0.8SS)     | JST    | *4 |
|               | (3) Connector (HIF-3BA-16D-2.54R) | Hirose | *1 |

## MPG-68K

### PG Board (100K)

### 4-Axis Output, 8-Origin Input

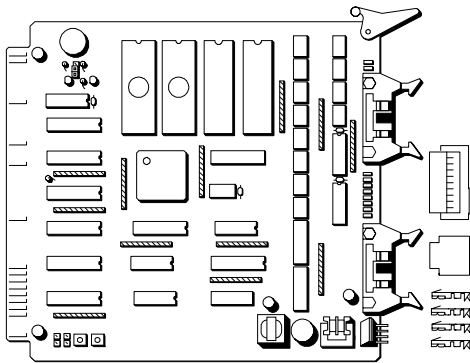

#### [Characteristics]

This is a board equipped with 4-axis simultaneous-control pulse generation. By an interpreter (ADVFS<sup>®</sup>) installed on MPC-68K, programming is possible in a BASIC-like environment. The maximum pulse rate is 100 kpps (for 3-axis simultaneous interpolation). One MPC-68K can support about three MPG-68K boards. If a power source unit (MPS-324) is added, about six boards can be supported.

#### (3) [Specification]

Power source: DC 12V~24V (for I/O control). Battery retained for 5 years (w/o external power supply at room temperature).

(1)

Pulse output: 4-axis/RS422 specification (photoisolated).

CPU: TMP68301F-16 16MHz. 1M SRAM\*2 + 1M PROM\*2.

(2)

Control I/O: 4-axis output, 8-point origin sensor input.

Consumed current: 150 mA

#### [Accessories]

(1) Power connector (H4P-SHF-AA)	JST	*1
(2) Contacts (BHF-001T-0.8SS)	JST	*4
(3) Connector (HIF-3BA-16D-2.54R)	Hirose	*1

## MOP-048

### 48-Point Transistor Output Board

### 48 Outputs

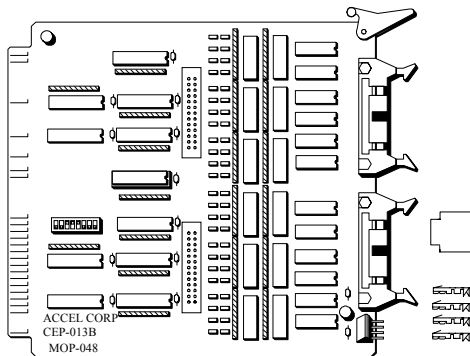

#### [Characteristics]

This is a dedicated output board equipped with 48-point output. Each output is equipped with an LED monitor. The output interface is an open collector output using a TD62004, where the control current is 100 mA per one output. Therefore, relays and compact solenoids for air-pressure control can be connected as they are. Also, because it functions even with 5 V, it can be used as a TTL output interface. Addresses can be specified by DIP switches (full decoding). MPC-68K supports up to eight MOP boards.

(1)

#### [Specification]

Power source: DC 5V~24V (for I/O control). 48-point open collector output.

(2)

Consumed current: 80 mA

#### [Accessories]

(1) Power connector (H4P-SHF-AA)	JST	*1
(2) Contacts (BHF-001T-0.8SS)	JST	*4

## MIP-048

### 48-Point Photocoupler Input Board

### 48 Inputs

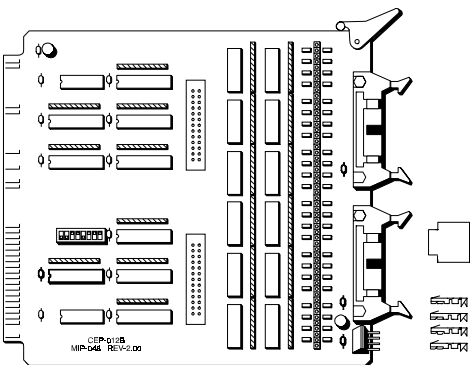

#### [Characteristics]

This is a dedicated input board equipped with 48-point input. Each input is equipped with an LED monitor. The input interface is a photocoupler input using a TLP-521, where the control current is 2 mA per one input. Also, because it functions even with 5 V if the resistor array is exchanged, it can be used as a TTL input interface. Addresses can be specified by DIP switches (full decoding). MPC-68K supports up to eight MIP boards. MIP-048 is equipped with a resistor socket for two-line sensor compatibility.

(1)

#### [Specification]

Power source: DC (5V) 12V~24V (for I/O control). 48-point optocoupler input.

\* If used with DC 5V, the resistor array needs to be replaced.

(2)

Consumed current: 30 mA

#### [Accessories]

(1) Power connector (H4P-SHF-AA)	JST	*1
(2) Contacts (BHF-001T-0.8SS)	JST	*4

\* Current values indicate standard consumed current TYP values. Please keep 20~50 % room in designing.

\* Current values indicate consumed current of the internal DC 5V power source, and the maximum current values with all I/Os ON for the I/O boards.

\* [ ] Current values indicate externally-supplied DC 24V current, and the minimum current values with all I/Os OFF.

## IOP-048

### 24-Point Photocoupler Input Board / 24-Point Transistor Output Board

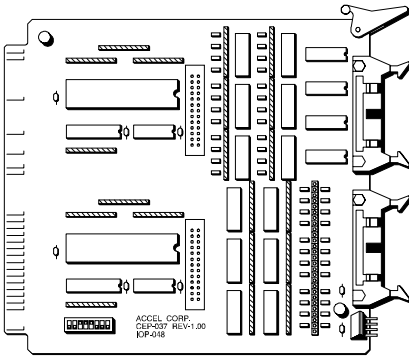

#### [Characteristics]

This is a dedicated input/output board equipped with 24-points for each input and output. Each input/output is equipped with an LED monitor. The input and output interfaces have equivalent specifications with MOP and MIP, respectively.

#### [Specification]

Power source: DC (5V) 12V~24V (for I/O control).

24-point optocoupler input. 24-point open collector output.

\* If used with DC 5V, the resistor array needs to be replaced.

Consumed current: 50 mA

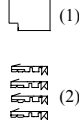

[Accessories]	(1) Power connector (H4P-SHF-AA)	JST	*1
	(2) Contacts (BHF-001T-0.8SS)	JST	*4

## MPG-3202

### S-Shape-Compatible PG Board & Encoder Counter Board

(2-Axis)

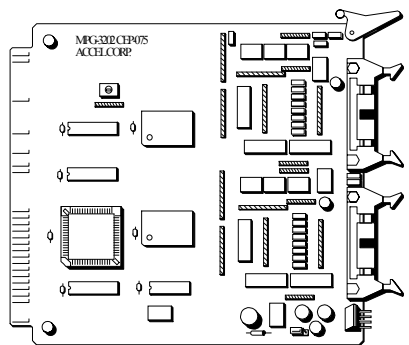

#### [Characteristics]

A general-use PG board loaded with pulse generation and counter ICs that can support two axes. Interface of the pulse output and the encoder is RS-422 specification that can deal with high-speed (1M pps) pulse output and input. The mounted PGIC is X3202 that can deal with the S shape and is equipped with various intelligent functions.

#### [Specification]

Power source: DC 12V~24V

Pulse output: Differential pulse output \*2 axes / RS-422 specification \* 2 axes

Encoder input: Differential pulse input (A-B phase encoding) \* 2 axes

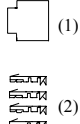

[Accessories]	(1) Power connector (H4P-SHF-AA)	JST	*1
	(2) Contacts (BHF-001T-0.8SS)	JST	*4

## MRS-402

### RS-232 Expansion Board

RS-232C

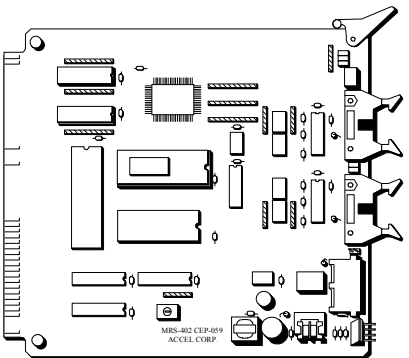

#### [Characteristics]

This is a 2CH RS-232C(RS-485) expansion board, of which up to two can be installed. Because it is an intelligent design by dual-port RAM, it does not provide burden on the CPU. The interface is photo-isolated, and the modem control terminal is RTS×CTS only. Software support is dealt with in a similar way to the standard commands and functions, assigned to #3~#6.

#### [Specification]

RS-232 standard interface. Input buffer 1K byte.

Consumed current: 50 mA

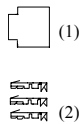

[Accessories]	(1) Power connector (H4P-SHF-AA)	JST	*1
	(2) Contacts (BHF-001T-0.8SS)	JST	*4

## MPS-324

### 3A Power Source Board

4(8)-Point Relay Output

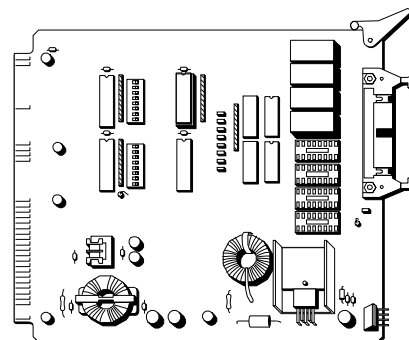

#### [Characteristics]

Although MPC-68K is equipped with a 1 A power source, when the system scale becomes large, it becomes short of current. In a large-scale system, this MPS-324 is used. The supplied current is 3 A. Also, MPS-324 is equipped with a 4-point relay output circuit (4 more relays can be further added). A PC98-bus compatible DC ±12 V DC-DC converter can be installed on the board. By this, peripheral boards for 98 requiring ±12 V power source can be used.

#### [Specification]

Power source: DC 24V±10%. 4(8)-point relay output.

Consumed current: 3 A supply

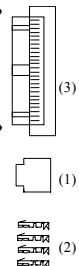

[Accessories]	(1) Power connector (H4P-SHF-AA)	JST	*1
	(2) Contacts (BHF-001T-0.8SS)	JST	*4
	(3) Connector (HIF-3BA-34D-2.54R)	Hirose	*1

## MBK-68

### Multifunction Board

RS-422 \* 2CH

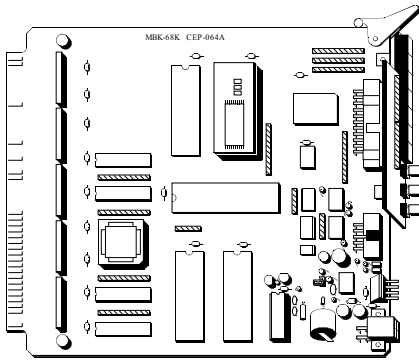

#### [Characteristics]

MBK-68 is a function-addition board of MPC-68K and MPC-683. The following functions are added. Please insert this board to the right end of the rack (on the opposite side of CPU). Bus terminator is added, making a large-scale system more reliable. Display of the statement number during execution is added. 7 SEG display. Digital Corp GP70 Series can be connected. Other supports are under evaluation. Large-scale data arrays can be dealt with by 68K and 683 interpreters. Battery backup function is added to MPC-683.

#### [Specification]

Consumed current: 200 mA. Photo-isolated RS422.

[Accessories]	(1) Power connector (H4P-SHF-AA)	JST	*1
	(2) Contacts (BHF-001T-0.8SS)	JST	*4

## MPC-SLINK

### Slink I/O Board

MAX 256 \* 2 (I/O)

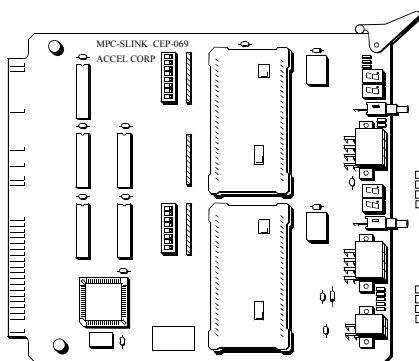

#### [Characteristics]

MPC-SLINK is a board which supports the Sanks SLINK system. It is equipped with two host module made by Sanks as a default (maximum 512 points). Also, up to two MPC-SLINK boards are supported by 68K. Assigned I/O area starts at 2000.

#### [Specification]

Consumed current: 200 mA (per module). SLINK specification follows that of Sanks.

(1) [Accessories]	(1) Housing (5557-08R)	Molex	*2
-------------------	------------------------	-------	----

#### [Compatible parts]

Please purchase upon necessity.

Pressure-attaching tool (57027-5000 (Molex))	Extracting tool (57031-6000 (Molex))
Contacts (5556TL (Molex))	Housing (5557-04R (Molex))

## RACK-68K6

### 6-Slot Rack

## RACK-68K3

### 3-Slot Rack

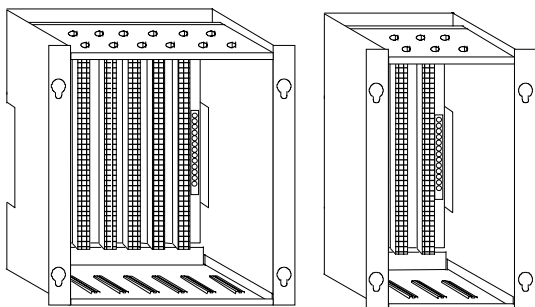

#### [Characteristics]

These are board racks dedicated to MPC-68K. Their design is highly condensed with a board pitch of 20 mm. A mounting flange attached as a default is attachable toward any of the top, bottom, front, and back direction. RACK-68K has a 3-slot and a 6-slot version. Also, by a connection kit sold separately, up to three racks can be connected, constructing a system with maximum of 18 slots. The 6-slot rack can be arranged on either the left or the right side, but the 3-slot rack can only be arranged on the right side. Because the bus construction is based on PC98 I/O bus, various kinds of commercial I/O boards for 98 can be used.

#### [Specification]

PC98 I/O bus standard, 20 mm pitch, 6 slots.

[Accessories]	Screws (M3*4)	Rack assembly use	* 16
	Screws (M3*12)	For attaching the bus	* 4

## ADP-68K

### Connection Kit

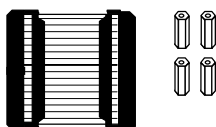

#### [Characteristics]

This is a connection kit for said racks. By this, RACK-68K can be expanded up to 18 slots. The components are spacers and a 50-pin flat cable. Only the I/O bus signal is connected by the 50-pin flat cable. By this connection kit, racks can be mechanically and electrically (conduction-wise) connected to an arbitrary size, but the reliability will decrease if the bus-signal width exceeds 50 cm.

[Accessories]	Screws (M3*4)	*8
	Spacers (SP-17)	*4



# MPC-LNK

MPCLNK is a network board with an objective of sharing memory data and bit-unit information. By using MPCLNK, connected equipment (personal computers and MPC-68K) can share 249-byte memory. Also, because a function is included for transferring data by block to a specified address, individual communications that used to be performed by RS-232C etc. are supported together by MPCLNK. The number of connectable units is up to 16. When MPCLNK and LNK-048 are combined, one unit of MPCLNK and up to 15 units of LNK-048 are connectable.

The response speed is within 10 msec for transferring a shared variable from #1 to any other, and is the number of connection \* 10 msec for changing a shared variable of #2-#15 except #1 or for the input status of LNK-048 to be returned to #1. In the case of up to five-unit connection which is a default factory ship-out condition, the response speed is within 50 msec.

As for the distance of the communication cable, because it is based on RS-485 standard, the connection will have no problem up to several hundred meters. Also, the communication interface is isolated by a pulse transformer, preventing noise trouble etc. that occurs when used by different power sources.

## Connection Method

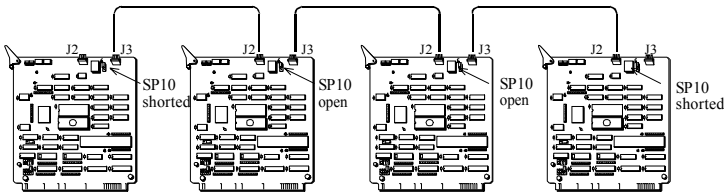

Because MPCLNK adopted an interface based on RS-485, it can be easily connected via twisted-pair cables. Two connectors and a short pin for a terminator belong to MPCLNK, and they are connected as in the figure. What should be kept in mind is for the connection to be in a cascade as in the figure and to set the terminator ON (the short pin is shorted) for the MPCLNKs at the ends.

## PC (AT, 98) + LNK-048

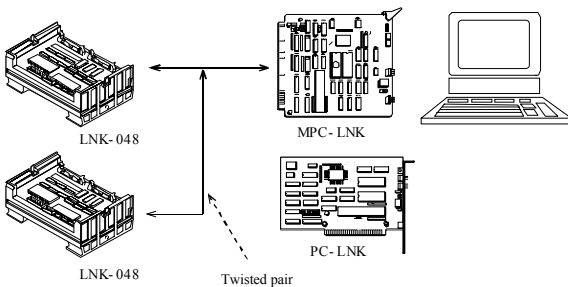

This is a remote IO for a personal computer. One LNK-048 is equipped with 24-point input and 24-point output, and can perform reading of input from the host side and control of the output port. The host needs one MPCLNK, and the I/O unit and MPCLNK are connected via a twisted-pair cable. Because communication is done through an RS-485 interface, connection of plural LNK-048 is simple by multiple-drop bus connections of a twisted pair. Control and reading of the IO are performed via the UMB area of the personal computer (this is because MPCLNK works as a memory installed in the UMB area). Writing into the UMB area is reflected as is by the output port of LNK-048, and the input content of LNK-048 is reflected as is by the specified memory of the UMB. Therefore, the I/O can be directly controlled using application software for DOS/WINDOWS etc.

## MPC-68K + LNK-048

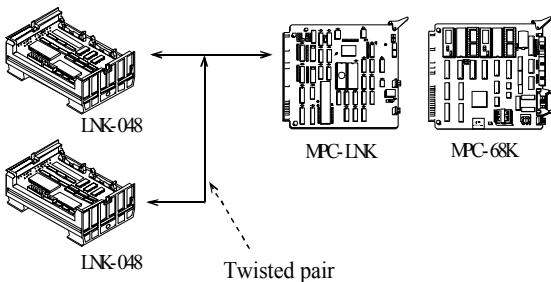

LNK-048 is a remote IO of MPC-68K. One LNK-048 is equipped with 24-point input and 24-point output, and can perform reading of input from the 68K side and control of the output port. The host needs one MPCLNK, and the I/O unit and MPCLNK are connected via a twisted-pair cable. Because communication is done through RS-485 interface, connection of plural LNK-048 is simple by multiple-drop bus connections of a twisted pair. For control and reading of IO, the IO commands such as ON/OFF, SW(), etc. of MPC-68K are available.

## LNK-048 + LNK-048

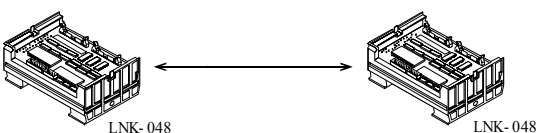

By using LNK-048 one on one, the I/O condition can be transmitted as it is to a distant place. The 24-point input content to one is reflected by the output of the other. Connection of LNK-048 is by one twisted pair, withstanding even a distance of several hundred meters (in the case of an RS-485 standard cable). Also, if the IO link destination is fixed, two or more LNK-048 can be IO-connected (customization will be necessary).

# MPC-LNK, PC-LNK

## Communication Board

(98 C-Bus Standard) / PC-LNK (ISA)

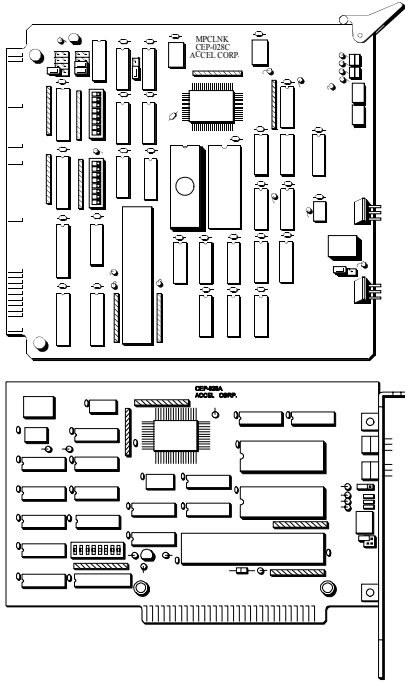

### [Characteristics]

MPC-LNK (PC-LNK) is a data network connecting our MPC-68K, NEC PC98 series, and DOS/V machines. Unlike networks by other specifications, it does not let the host generate interruptions or consume system memory. MPC-LNK itself becomes a RAM board connected via communication, both the connected 68K and personal computer having shared variables usable in common.

- (1) The connection interface uses RS-485 (750 kpps SDLC standard), where a network can be easily constructed by a twisted-pair multiple drop (the maximum connection length is 1.2 km according to the RS-485 specification). MPC-LNK can be utilized not only as a pure 68K network but also as a data exchange network for personal computers using libraries.
- (2)

### Shared variables

These are common variables of 249 bytes which all MPC-LNK can refer to. Shared variables are refreshed every 24 sec and can be changed or referred to at real time. The content set by the #1 station circulates to the whole every 10 msec, and the content changed by the #2 or latter station is reflected by the whole every  $n * 10$  msec ( $n$  is the number of MPC-LNKs connected to the network, whose default value is 5). Also, 68K deals with them as 125 word-type variables.

### Mail forwarding

All the connected MPC-LNKs can perform block transfers by 250-byte units. In forwarding mail, the receipt status, forwarding, and read-out by the recipient can be confirmed.

[Specification]	Communication	RS-485/SDLC standard 750 kpps. SN75176B used. Pulse transformer isolated.
	Cable	Shielded twisted pair to be used (60 nF/km)
	Bus I/F	MPCLNK: 68K system bus / PC-98 expansion bus standard (full decoding). PC-LNK: ISA bus. Installed in the UMB area as memory.
	Address	68K: 1000H, 2000H fixed (I/O area). PC98 / DOS/V: C0000H~ (expanded ROM area 0~BFFH exclusive).
	Memory	Shared variables        249 bytes Send-mail buffer        250 bytes Receive-mail buffer    250 bytes
	Consumed current	150 mA

[Accessories]	(1) Power connectors (H4P-SHF-AA)	JST	*2
	(2) Contacts (BHF-001T-0.8SS)	JST	*6

# LNK-048

## Remote IO Unit

24-Point Output / 24-Point Input

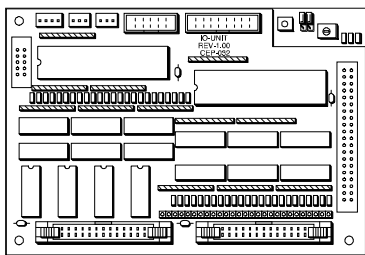

### [Characteristics]

Remote IO can be used in a MPC-68K system equipped with MPCLNK. LNK-048 is equipped with 24-point input and 24-point output, and can monitor the status of a sensor distant from the host or control the actuator. Also, if used as an IO etc. for a control BOX of an apparatus, because the host and LNK-048 can be connected via a twisted pair, it will also become a wiring-saving system.

Also, it can be used as a remote IO of a personal computer equipped with MPCLNK or PCLNK (PCM-95W03, with a case).

[Specification]	Communication:	RS-485/SDLC standard 750 kpps. SN75176B used. Pulse transformer isolated.
-----------------	----------------	--

Cable: Shielded twisted pair to be used (60 nF/km)

Power source: DC 24V ± 10%

Consumed current: 150 mA

[Accessories]	(1) Power connector (H4P-SHF-AA)	JST	*1
	(2) Power connectors (H3P-SHF-AA)	JST	*2
	(3) Contacts (BHF-001T-0.8SS)	JST	*10

\* MPC-LNK model will be modified due to production discontinuation of its component ICs within coming years. Although the new series and old series cannot be combined, they can be used in the same software environment. Please take note of this.

# MPC-816 Series ~ 8-Bit CPU Controller ~

## MPC-816K

### Main CPU Board

8 Outputs, 16 Inputs

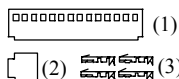
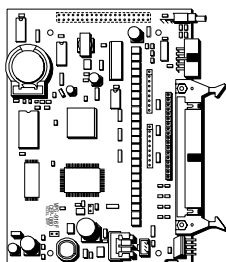

#### [Characteristics]

This is a CPU board equipped with the I/O for control. By its installed interpreter (TNYFSC), programming is possible in a BASIC-like environment. In spite of its compactness, it is equipped with 2M-bit flash ROM, and its program area of about 2000 steps can be used without any procedure such as ROM conversion or compiling. Also, a user RS-232C (isolated) is equipped, making it applicable to communication-involving use.

#### [Specification]

Power source: DC 12V~24V battery-retained for 7 years (w/o external power supply at room temperature).

CPU: KL5C80A16, 7.37 MHz, 1M SRAM + 2M FROM.

Control I/O: 8-point open collector output, 16-point photocoupler input.

Self-consumed current: 110 mA (380 mA power source installed)

#### [Accessories]

(1) Housing (PS-D4C50)	JAE	*1
(2) Power connector (H4P-SHF-AA)	JST	*1
(3) Contacts (BHF-001T-0.8SS)	JST	*4

## MIF-816K

### Bus Interface Board

8 Outputs, 16 Inputs

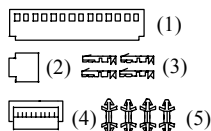
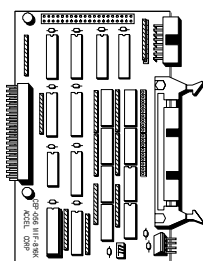

#### [Characteristics]

This is the first expansion board of MPC-816. It is a bus interface of expanded I/O: MIO-816 and also equipped with the control I/O at the same time. Also, a 16-pin connector J5 becomes a pulse output port if the Z version is selected on MPC-816, enabling simple control of a pulse motor, etc. Also, MPC-SET (EX) is the set of MPC-816 and MIF-816 being packed in a case.

#### [Specification]

Power source: DC 12V~24V (for I/O control).

Control I/O: 8-point open collector output, 16-point photocoupler input, 4-axis pulse output port.

Consumed current: 30 mA

#### [Accessories]

(1) Housing (PS-D4C50)	JAE	*1
(2) Power connector (H4P-SHF-AA)	JST	*1
(3) Contacts (BHF-001T-0.8SS)	JST	*4
(4) Connector (HIF-3BA-16D-2.54R)	Hirose	*1
(5) Spacers (MSPLS-7)		*4

## MIF-816AD

### Bus Interface Board with AD/DA

8 Outputs and 12 Inputs

3CH A/D 1CH D/A

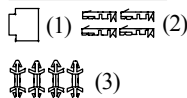
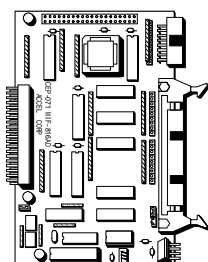

#### [Characteristics]

This is the first expansion board of MPC-816 and has almost the same specification with MIF-816. Differences from MIF-816 are that it is equipped with a 12-bit A/D and D/A converter and that J5 has no ZCW and ZCCW output. It is best for small-scale analog test output circuits.

#### [Specification]

Power source: DC 12V~24V (for I/O control). DC 5V (for A/D and D/A). Internal V can be also used.

Control I/O: 8-point open collector output. 12-point photocoupler input.

3-axis pulse port (w/o ZCW and ZCCW). 3-CH analog input. 1-CH analog output.

Consumed current: 260 mA (150 mA if A/D and D/A are externally supplied.)

#### [Accessories]

(1) Power connector (H4P-SHF-AA)	JST	*1
(2) Contacts (BHF-001T-0.8SS)	JST	*4
(3) Spacers (MSPLS-7)		*4

## MBK-816

### Touch-Panel Interface Board

RS-422(485) 2CH

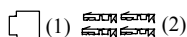
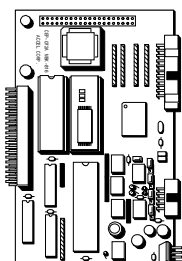

#### [Characteristics]

This is an I/F board for a touch panel display for MPC-816. It is compatible with Memo-Link of Digital Corp. as of March 99, and it can be interfaced with the panel by using only ON/OFF/SW() commands from the MPC-816 side.

#### [Specification]

Power source: DC 12V~24V (for panel communication)

Control I/O: RS-422(485) 2CH

Consumed current: 200 mA

#### [Accessories]

(1) Power connector (H4P-SHF-AA)	JST	*1
(2) Contacts (BHF-001T-0.8SS)	JST	*4

## MPC-816XC

### Compact Controller

8 Outputs, 16 Inputs

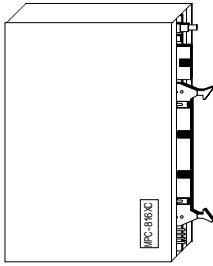

[Characteristics]

This is a single MPC-816 stored in a case. Please use it when you use one CPU board installed directly in an apparatus. Refer to MPC-816K for the specification details.

[Accessories]	(1) Housing (PS-D4C50)	JAE	*1
	(2) Power connector (H4P-SHF-AA)	JST	*1
	(3) Contacts (BHF-001T-0.8SS)	JST	*4

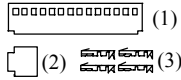

## MPC-SET (EX)

### Compact Controller

16 Outputs, 32 Inputs

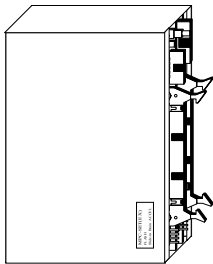

[Characteristics]

This is a combination of MPC-816 and MIF-816 stored in a case. It can be used also as a controller with 16-point output and 32-point input. Also, because simple pulses can be generated (max 60 Kpps) from J5 of MIF, it can be used also as a positioning device. Refer to MPC-816K and MIF-816K for the specification details.

[Accessories]	(1) Housing (PS-D4C50)	JAE	*2
	(2) Power connector (H4P-SHF-AA)	JST	*1
	(3) Contacts (BHF-001T-0.8SS)	JST	*4
	(4) Connector (HIF-3BA-16D-2.54R)	Hirose	*1

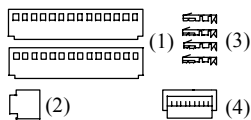

## MIO-816K

### Expanded I/O Board

8 Outputs, 16 Inputs

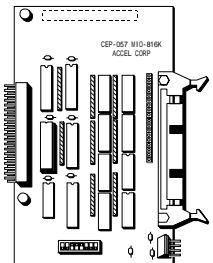

[Characteristics]

This is an expanded I/O board for MPC. Expansion is possible up to 11 boards. Because all the I/Os are isolated by photocouplers, noise resistivity is high, and each I/O can be used by power sources different from the others. Also, by installing a J2 connector by the user, a small-scale system can be constructed in combination with MPC-816 without using MIF-816.

[Specification]

Power source: DC 12V~24V (for I/O control).  
Control I/O: 8-point open collector output, 16-point photocoupler input.  
Consumed current: 50 mA.

[Accessories]	(1) Housing (PS-D4C50)	JAE	*1
	(2) Power connector (H4P-SHF-AA)	JST	*1
	(3) Contacts (BHF-001T-0.8SS)	JST	*4

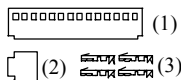

## MIO-248K

### Expanded I/O Board

24 Outputs, 8 Inputs

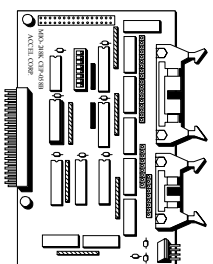

[Characteristics]

This is an expanded I/O board for MPC. Expansion is possible up to 11 boards. Because all the I/Os are isolated by photocouplers, noise resistivity is high, and each I/O can be used by power sources different from the others. Also, because it is designed to be compatible with DC 5V, it can also be used as a TTL interface. When used with 5V, a resistor array is added to the SIP socket.

[Specification]

Power source: DC 5V~24V (for I/O control).  
Control I/O: 24-point TLP627 photocoupler open collector output, 8-point photocoupler input.  
Consumed current: 110 mA.

[Accessories]	(1) Housing (PS-D4C50)	JAE	*1
	(2) Power connector (H4P-SHF-AA)	JST	*1
	(3) Contacts (BHF-001T-0.8SS)	JST	*4

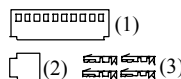

## MPG-301

### One-Axis Pulse Generation Encoder Counter Board 1M PPS 1-axis pulse output 1M PPS encoder input, etc.

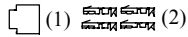
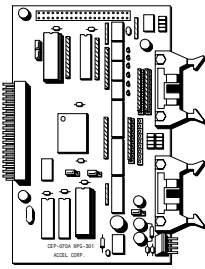

#### [Characteristics]

MPG-301 is a pulse-generation multifunction board which is loaded with one Kyopal X3202 and let MPC816 directly operate the IC register. It is capable of flexible control such as changing pulse rate during pulse generation, referring to the present position, S-shape acceleration/deceleration, etc.

#### [Specification]

Power source: DC 12V~24V

Control I/O: One-axis RS422 driver pulse output. One-axis RS422 encoder input.  
Z-phase input, limit input, etc.

Consumed current: 150 mA

#### [Accessories]

(1) Power connector (H4P-SHF-AA)	JST	*1
(2) Contacts (BHF-001T-0.8SS)	JST	*4

## MPG-303

### PG Board

### 2-Axis + 2-Axis Pulse Generation

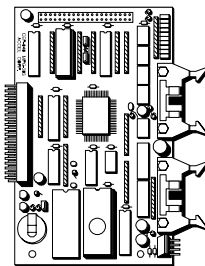

#### [Characteristics]

This is a pulse-generation board based on 2-axis linear interpolation. It is supported by the commands of TNYFSC interpreter installed in MPC-816. Also, MPC-816 supports three MPG-303 boards. In the standard P version, MODE 5 and MODE 6 are used. The maximum pulse rate is 50 kpps. As for the output axis, two axes can be used at an exclusive time from either the XY or ZU axis.

#### [Specification]

Power source: DC 5V~24V (for I/O control).

Control I/O: 4-axis pulse output port (photo-isolated, open collector).  
8-point origin-returning sensor.

Maximum pulse rate: 50 kpps CW/CCW2 pulse method.

Consumed current: 80 mA

#### [Accessories]

(1) Connector (HIF-3BA-16D-2.54R)	Hirose	*2
(2) Power connector (H4P-SHF-AA)	JST	*1
(3) Contacts (BHF-001T-0.8SS)	JST	*4

## MCT-801 (Conserved Item)

### Counter Board

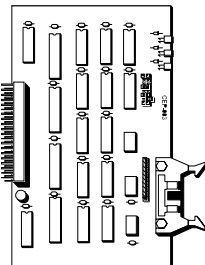

#### [Characteristics]

This is a 24-bit up-down counter equipped with an encoder/decoder. It deals with both encoder input and pulse input. The input interface is optoisolated. Although a rotary encoder with 12V power is assumed in the ship-out setting, it can deal with DC 5V and DC 24V by changing the resistor array. Up to two MCT-801s can be used in one system.

#### [Specification]

A-B-phase phase encoder input / Up-down pulse input

Compatible with 500 kpps. Power source: DC 5V ~ DC 24V

Consumed current: 20 mA

#### [Accessories]

(1) Connector (PS-16SEN-D4P1-1)	JAE	*1
---------------------------------	-----	----

## MCD-001 (Conserved Item)

### Data Memory Card

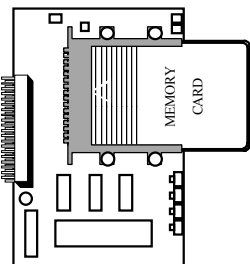

(1)

#### [Characteristics]

This is an interface board for supporting a memory card (32 kbyte) made by Fujisoku. When MCD-001 is used, an array of 10921 is extended as M() on the memory card. By utilizing this numerical data area, switching is performed of the model that used the IC card, storing a large amount of data, etc. Also, MCD-001 is equipped with four digi-switches, enabling a read-out of values by the commands. MPC-816 supports one MCD-001.

#### [Specification]

IC card: Made by Fujisoku (BS32D1-A)

Consumed current: 10 mA

#### [Accessories]

(1) Memory card (BS32D1-A)		*1
----------------------------	--	----

## RACK-SET (A)

### 4-Board Construction Rack Set

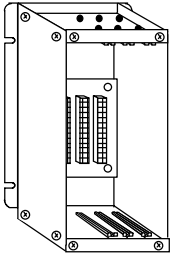

[Characteristics]

This is a rack set for MPC-816. It deals with a 4-board construction system. MPC-SET (A) is a rack set with MPC-816 and MIF-816 added.

[Construction]

RACK (A) main body, BUS board A, Rack flange.

[Accessories] Screws (M3 \* 4) For assembling rack \*16

## RACK-SET (B)

### 8-Board Construction Rack Set

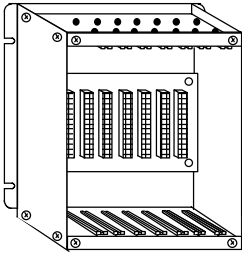

[Characteristics]

This is a rack set for MPC-816. It deals with an 8-board construction system. MPC-SET (B) is a rack set with MPC-816 and MIF-816 added.

[Construction]

RACK (B) main body, BUS board B, Rack flange.

[Accessories] Screws (M3 \* 4) For assembling rack \*16

## RACK-SET (C)

### 16-Board Construction Rack Set

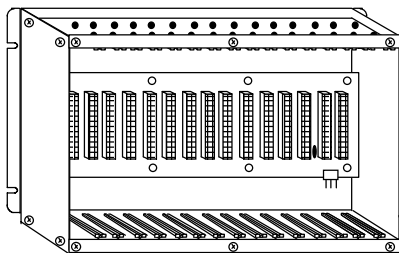

[Characteristics]

This is a rack set for MPC-816. It deals with a 16-board construction system. Please be careful about the power source capacity for a 16-board full system. The current-supply capacity of MPC-816 is up to 380 mA including 816. If a power shortage is anticipated, please remove JP1 on MPC-816 and supply DC 5V directly to the bus board. MPC-SET (C) is a rack set with MPC-816 and MIF-816 added.

[Construction]

RACK (C) main body, BUS board A, Rack flange.

[Accessories] Screws (M3 \* 4) For assembling rack \*20

## ADP-325

### Metal Fittings for Compact Boards

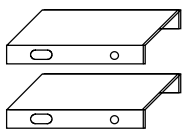

[Characteristics]

These are metal fittings for compact boards with a PCB width of 70 mm. A commercial I/O board for Z80 can be inserted into the RACK by these. As for the way of attaching it, remove the guide rail, install the metal fittings, and put back the guide rail.

[Construction] U-shape metal fittings \*2, Fitting machine screws \*4.

## Flange H / Flange D

### Metal Fittings

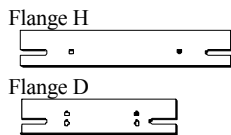

[Characteristics]

Metal fittings for MPC-SET (EX) and MPC\_816XC. The H type is for a back-face installation, and the D type is for a bottom-face installation.

[Construction] Metal fitting \*1, Machine screws \*2.

# MPC Peripherals ~ Common for MPC-68K and MPC-816 ~

## Cable DOS/V 98

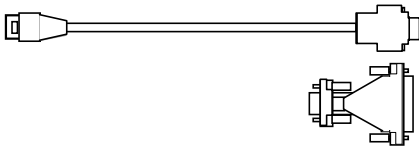

**[Characteristics]**

This is a cable of our company brand to connect MPC and a personal computer. Although the basic cable is for DOS/V, because a 25-pin conversion connector is included, it can also be used for PC98.

## FTM

**(FTM98 / FTMDOSV / FTMWIN)**

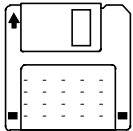

**[Characteristics]**

MPC terminal software "FTMW32", 816/68K command references, Communication program development support tools, etc. are included.

**[Construction]** Setup Disk (3.5" 1.44 MB format).

\* Other than these, there are FTM versions for NEC98DOS, DOS/V, and English Windows. Please refer to our Business or Technical Department.

## IOD-024

**I/O Relay Box**

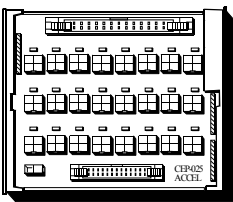

**[Characteristics]**

Because the I/O connector of MPC is compact and has high density, wiring work in a large-scale system is troublesome, and because there is no display of the I/O, debugging is laborious. IOD-024 connects to the I/O connector of MPC via a flat cable, and branches it point by point to a relay connector. Also, because each point is equipped with an LED, wiring debugging and system maintenance become easy. Also, interfacing a sensor containing a two-line amplifier can be done easily.

(With a case PCML-95W02)

**[Specification]**

Input: 26-pin/50-pin flat cable.  
Output: Molex 5557-04R + 5556TL

**[Compatible parts]** Please purchase upon necessity.

Pressure-attaching tool (57027-5000 (Molex))      Extracting tool (57031-6000 (Molex))  
Contacts (5556TL (Molex))      Housing (5557-04R (Molex))  
Housing (5557-02R (Molex))

## PIF-422

**Pulse-Signal Conversion Interface**

**(Conversion into RS-422 or TTL)**

## PIF-400

**Pulse-Signal Conversion Interface**

**(DC 24V Open Collector)**

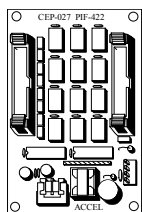

**[Characteristics]**

In MIF-816 and MPC-68K, the pulse-signal output is not isolated. Therefore, if a driver is directly connected, noise may cause the controller to stall. When a high-noise driver such as an AC servo is connected, please use one of the above conversion interfaces depending on the kind of interface. Although PIF-422 is an RS-422 output, if an SG terminal is connected together, it can deal with 5V TTL-level signals.

(A case sold separately: PCML-60S02)

**[Specification]**

Power source: DC 12V~24V  
Input: TLP-552  
Output: SN75158P (for 4 axes) (PIF-422)  
DC 24V open collector (PIF-400)  
Consumed current: [70 mA] (PIF-422)  
[30 mA] (PIF-400)

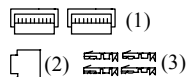

**[Accessories]**

(1) Connector (HIF-3BA-16D-2.54R)	Hirose	*2
(2) Power connector (H4P-SHF-AA)	JST	*1
(3) Contacts (BHF-001T-0.8SS)	JST	*4

# How to Deal with Noise

Control involving position determination control internally deals with signals of several msec. Because this signal is at a similar level to a noise signal, no matter what control device is used, reliability and accuracy cannot be obtained without any noise countermeasures. When making a device containing a position-determination control, please keep the following in mind.

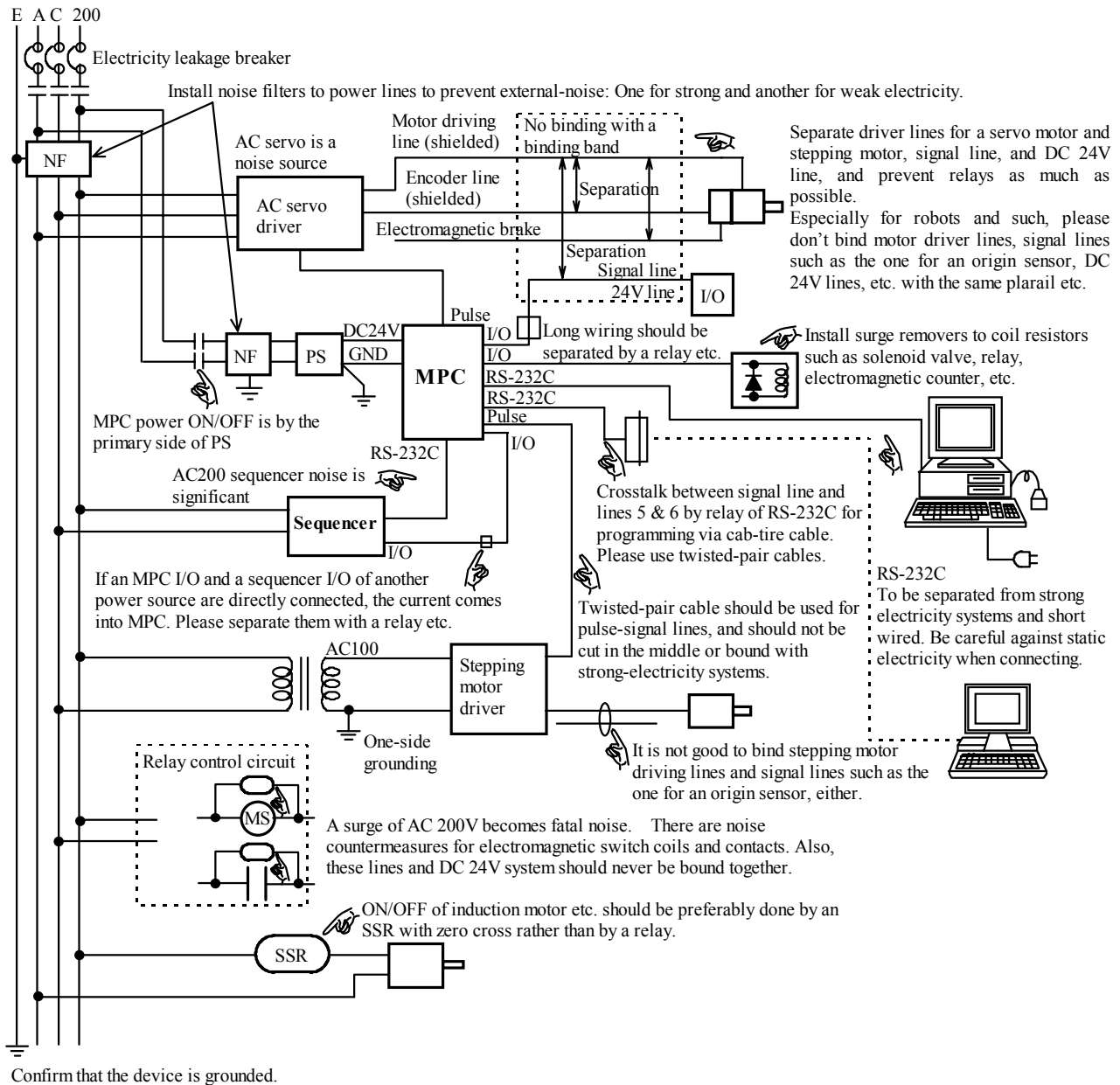

If there is a device which stalls too frequently or produces motor position errors, there must be a clear noise source. The points are the surge based on control by coils and contacts (relay circuit) and driving lines of various large-scale motors. They become fatal noise in 200V systems and a strong noise source even in DC 24V systems.

There are plenty of coils that can become a noise source such as coils in conductors, strong AC 200V buzzers, coil noise of solenoid valves, etc. The first things to do in noise troubles are to look for coils and reevaluating power lines.

## Parts on the Black List

Electromagnetically contacting parts: Noise countermeasures to coils and contacts.

AC motor: Drive by SSR. Power line wiring.

AC/DC solenoid: Noise measure to coils and contacts.

200V and 100V buzzers: Electromagnetic wave measure (distance and shielding).

Servo motor: Wiring of power line and signal lines (wire material, length, relay, and binding).



## FTMW (FTM – Work Bench)

FTMW is a programming tool for MPC-816 and MPC-68K, equipped with all the functions necessary for program development and maintenance.

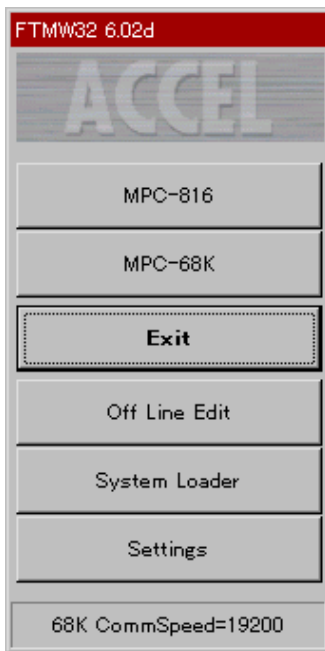

<- MPC-816 direct connection.

<- MPC-68K direct connection.

<- FTM Work Bench ends.

<- Dedicated editor starts (programming is possible away from the apparatus).

<- MPC system data are updated. Used for version upgrading.

<- Various kinds of settings are done. Absolutely necessary for program loading especially in 68k.

The dedicated editor is a specialized editor for MPC programming, equipped with reserved word management, simple help with command format, etc. It allows efficient development of MPC programs even off-line.

Accel publishes the latest version of the above FTMW and MPC system data on our web side. By this, users can always use MPC equipped with the latest software and latest functions (using the system loader).

<http://accelpmc.com>

## List of Compatible Connectors

26-Pin I/O Connector	
<b>Hirose</b> Individual wires Housing HIF3BA-26D-2.54C Contacts HIF3-2226SCA (AWG#22~#26) Pressure welding HIF3BA-26D-2.54R	<b>JAE</b> Individual wires Housing PS-D4C16 Contacts 030-51304-001 (AWG#24~#28) Pressure welding PS-16SEN-D4P1-1C (Closed-end type)
16-Pin Connector for Pulse Port	
<b>Hirose</b> Individual wires Housing HIF3BA-16D-2.54C Contacts HIF3-2226SCA (AWG#22~#26) Pressure welding HIF3BA-16D-2.54R	<b>JAE</b> Individual wires Housing PS-D4C16 Contacts 030-51304-001 (AWG#24~#28) Pressure welding PS-16SEN-D4P1-1C (Closed-end type)
10-Pin Connector for RS-232C Port	
<b>Hirose</b> Individual wires Housing HIF3BA-10D-2.54C Contacts HIF3-2226SCA (AWG#22~#26) Pressure welding HIF3BA-10D-2.54R	<b>JAE</b> Individual wires Housing PS-D4C10 (key at one part) Contacts 030-51304-001 (AWG#24~#28) Manual pressure-attaching tool CT150-1-PSSF (AWG#24~#28) Pressure welding PS-10SEN-D4P1-1C (Closed-end type)

# Request to Our Customers

## Concerning the application range of our products

All of our products use general-use components. Therefore, please refrain from using them for fields requiring high reliability and for the purposes dealing with human life.

## Product warranty period

We maintain or exchange for free our product which broke naturally during normal use only within one year after its shipment. If there is clear maintenance or exchange of a naturally broken product, please send the product to us.

## On-site service and field costs and expanded damage

Our maintenance service is limited to inside our HQ. We will not accept any payment request of a maintenance cost which seems to be caused by on-site maintenance by our employee or our product. If you request for our employee to be sent, we will charge for the maintenance cost set separately. Our products are half products whose specific purpose or usage environment cannot be limited. We cannot compensate for any damage caused by using our product, either.

## Shipment to a distant place

When shipping any device using our product to a distance place such as overseas, a specific procedure regulated by the Trade Administration Order is necessary. Because we have necessary materials for the procedure, please request them when you export our product. Also, because we cannot support the maintenance of any product shipped to a distance place as stated above, please place the responsibility of maintenance upon the user.

## Reliability of battery backup

Although the nominal life of a lithium battery is more than five years, there are very rare instances where the battery life becomes significantly short due to defects of the battery maker or others. Also, retaining data by a battery is not perfect in principle. Although there is an extremely low probability, data can be lost (lightning, photographic strobe, and exposure to radiant rays). Also, there are instances where data are lost due to dew forming during normal transportation, and due to vibrations and extreme humidity occurring during export/import. When there is worry of program loss or when moving to a distant place where there is no technical staff to perform proper maintenance, please convert the program to a ROM. We cannot be responsible for the program loss.

## Abolishment of Freon

Accompanying the abolishment of Freon, cleaning of our products is gradually shifting to the no-cleaning method. When a board looks like it is not clean, we have been using a non-cleaning type flux. There is no influence on the specification and performance. Because this is a measure from the standpoint of environmental protection, we ask for your understanding.

## Specification change

Since 1996, there has been production discontinuation of 80-system ICs such as 8255 and 8251 one after another. Although we have been changing designs and taking measures each time to keep the compatibility current, part of normally-unused functions etc. may be changed. Please understand this in advance.

## Flash ROM

In November 1996, we adopted flash ROMs. The number of warranted rewriting of a flash ROM is 100,000 times, and the data retaining period is 10 years (same specification as EPROM). Also, because flash ROM may be damaged if the power is cut off while its contents are being erased or rewritten, please use it in a stable power environment during a time of maintenance.

\* Standards and specifications may be changed without prior announcement.

MPC series is our original product. All rights concerning MPC belongs to Accel Corp.

ADVFSC, TNYFSC, and MPC-LNK are trademarks of Accel Corporation.

## MPC-SERIES General Catalog

June, 2000	Revision version 5
Publisher	Ryuichi Yokota
Publishing house	Accel Corporation Tohbu Bldg 5F, 16-32 Nakamachi, Chino City, Nagano 391-0005 TEL 0266 (72) 8465 FAX 0266 (72) 8436 NIFTY-SERVE JDA02023 E-mail: webmaster@accelmpc.com http://accelmpc.com
Planning & Editing	Free System

## Free Manuals Download Website

<http://myh66.com>

<http://usermanuals.us>

<http://www.somanuals.com>

<http://www.4manuals.cc>

<http://www.manual-lib.com>

<http://www.404manual.com>

<http://www.luxmanual.com>

<http://aubethermostatmanual.com>

Golf course search by state

<http://golfingnear.com>

Email search by domain

<http://emailbydomain.com>

Auto manuals search

<http://auto.somanuals.com>

TV manuals search

<http://tv.somanuals.com>