

## Scanner Parts

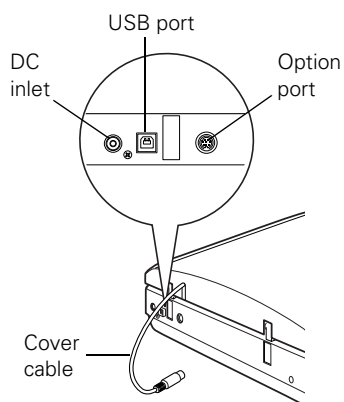

## Option

The Multi Photo Feeder (part number B12B813372) lets you load up to 24 photos or business cards and scan them automatically. See the on-screen *Reference Guide* for instructions.

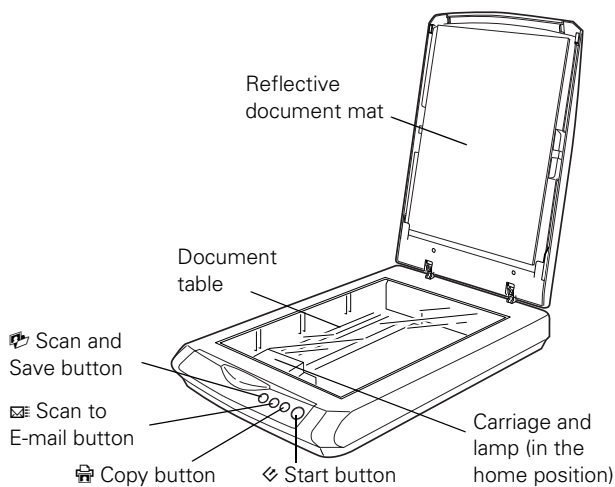
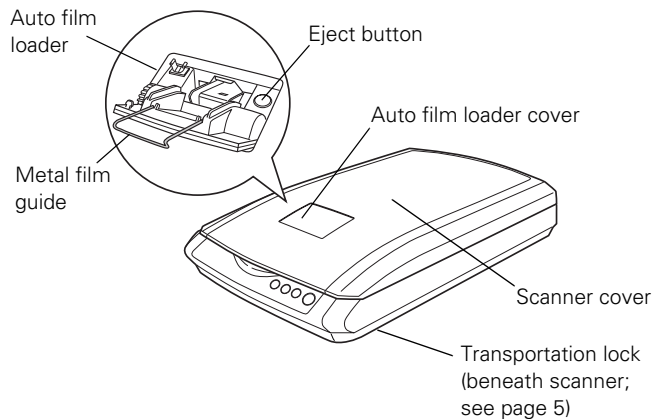
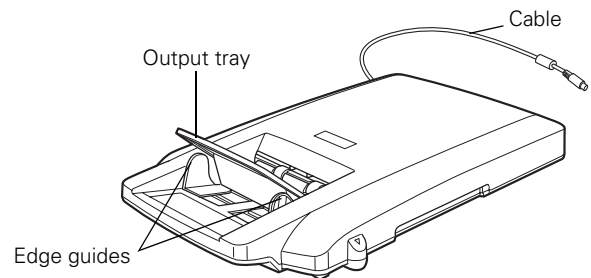

## Scanner Specifications

### Basic Specifications

Scanner type	Flatbed, color
Photoelectric device	Color CCD line sensor
Effective pixels	20,400 × 28,080 pixels at 2400 dpi
Document size	8.5 × 1.7 inches (216 × 297 mm) Letter size or A4 (reading area can be specified from software)
Scanning resolution	2400 dpi (main scan) 4800 dpi with Micro Step (sub scan)
Output resolution	50 dpi to 12800 dpi (50 to 6400 dpi in 1 dpi increments, and 12800 dpi. 12800 dpi performed with zoom function.)
Color separation	RGB color filters on CCD
Image data	16 bits per pixel per color internal 1, 8, and 16 bits per pixel per color external
Line art settings	Adjustable threshold
Gamma correction	1 type for user-defined
Interface	USB 2.0 Hi-Speed (Type B connector)
Light source	White cold cathode fluorescent lamp
Dimensions	Width: 10.8 inches (275 mm) Depth: 16.5 inches (419 mm) Height: 3.4 inches (86 mm)
Weight	Approx. 7.0 lb (3.2 kg)

## Electrical

Input voltage	AC 100 to 120 V
Rated frequency	50 to 60 Hz
Rated current	1.0 A
Power consumption	19.0 W operating (with AFL) 13.0 W standby mode 5.5 W sleep mode (with AFL)

## Environmental

Temperature	Operation: 41 to 95 °F (5 to 35 °C) Storage: -13 to 140 °F (-25 to 60 °C)
Humidity (without condensation)	Operation: 10 to 80% Storage: 10 to 85%
Operating conditions	Ordinary office or home conditions. Extreme dust should be avoided. Operation under direct sunlight or near a strong light source should be avoided.

## Safety Approval

EMC	FCC Part 15 Subpart B Class B CSA C108.8 Class B
-----	---

## USB Interface

Interface type	Universal Serial Bus Specification Revision 2.0
Electrical standard	Full Speed mode (12 Mb/s) and Hi-Speed mode (480 Mb/s) of Universal Serial Bus Specification Revision 2.0.
Connector type	One receptacle (Type B)

## Transparency Unit

Supplied voltage	DC 24.0 to 26.4 V
Rated current	0.5 A
35 mm film types	Strip: two to six 35 mm frames Readable width × length: 1.142 × 9.134 inches (29 × 232 mm)
	Slide: one 35 mm slide

## AC Adapter

Input	AC 100 to 120 V, 50 to 60 Hz
Output	DC 24.0 to 26.4 V, 1.4 A
Temperature	41 to 95 °F (5 to 35 °C)

## Scanning and Restoring Photos

If you have faded photos, slides, or negatives, you can use the Color Restoration setting in your software to bring them back to life.

Start EPSON Scan and select **Home Mode** or **Professional Mode** in the Mode box at the top of the screen.

Select your settings and click the **Preview** button at the bottom of the screen.

Select the **Color Restoration** checkbox. (In Home Mode, click the **Image Adjustments** button first. In Professional Mode, scroll to the bottom of the screen.)

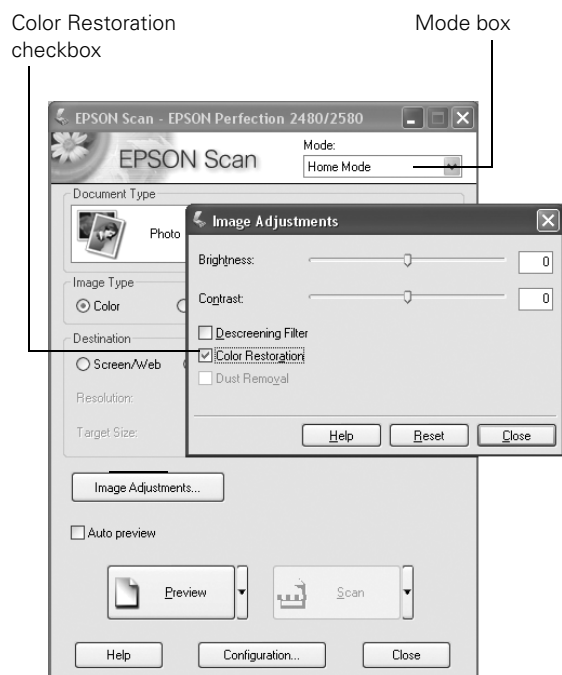

For detailed steps, see the on-screen *Reference Guide*.

**Note:** You can also use the Color Restoration feature in the EPSON Smart Panel copy utility. See the on-screen help in the copy utility for details.

## Using EPSON Smart Panel

To open EPSON Smart Panel, press the  Start button on your scanner or select EPSON Smart Panel on your desktop.

**Note:** In Windows, if you see a message when you press the  Start button, select EPSON Smart Panel, click Always use this program for this action, then click OK.

EPSON Smart Panel opens on your computer.



For details on using EPSON Smart Panel, click the ? button.

## Scanning Film and Slides

The top of the Perfection 2580 Photo scanner cover has an automatic film loader that lets you load 35 mm negatives without even opening the cover. You can use the slide holder to scan a 35 mm slide from the scanner glass.

**Tip:** Make sure your negatives or slides are dust-free for the best scan. You can also select the Dust Removal setting in EPSON Scan to improve your scan.   Dust Removal

Before scanning negatives or a slide, lift the scanner cover all the way up and slide the reflective document mat up and off of the scanner cover.

**Note:** Make sure the transparency unit cable is connected to the back of the scanner.

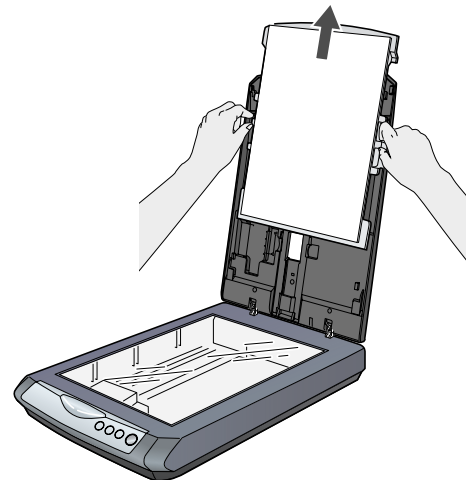

## Scanning 35 mm Negatives

1. Close the scanner cover.
2. Press and release the back of the auto film loader cover to open it.

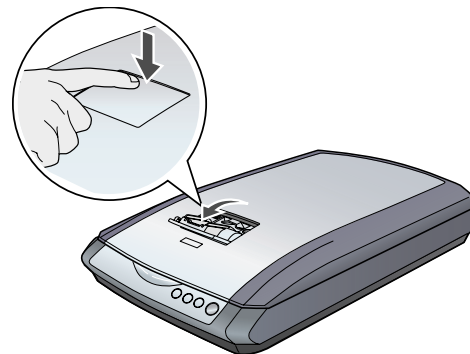

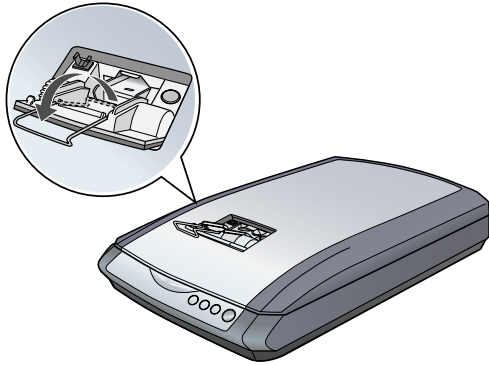

3. Flip out the metal film guide and press it down until it clicks into place.

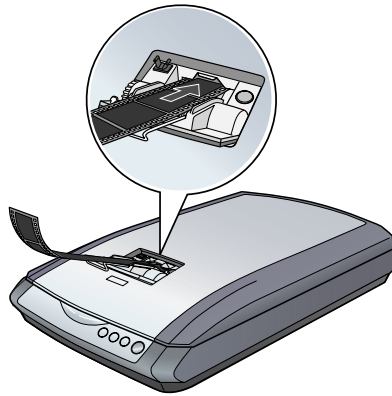

**Caution:** Before loading a film strip, make sure it contains at least 2 photos, but no more than 6. Don't load folded, creased, curled, or sticky film into the auto film loader or it may damage the film or your scanner.

4. Place the film strip in the film loader with the shiny base side facing down. Your images and any wording on the film strip should appear backward on the side that faces up.



5. Slowly slide the film into the loader. Let go of the film when the scanner begins to automatically feed it into position.
6. To scan each frame in your film strip as a separate image, press the  Scan and Save button or open EPSON Smart Panel and select **Scan and Save**. This scans each frame using ideal settings in Full Auto Mode and opens each one separately in ArcSoft PhotoImpression for viewing, editing, and printing. See your on-screen *Reference Guide* and Smart Panel help for instructions on selecting scan modes and complete scanning details.

7. When you finish scanning the film strip, press the Eject button inside the auto film loader to eject the film. Wait for the  Start light to stay on green, then remove the film strip.

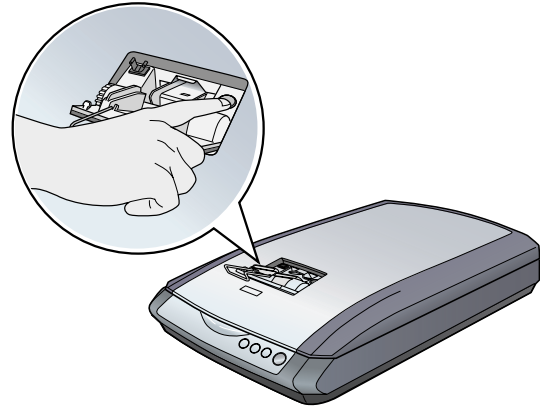

**Caution:** Don't turn off the scanner with a film strip loaded in the auto film loader. Never pull film out of the loader by force.

8. Flip the film guide back inside the auto film loader and press it down until it clicks into place.
9. Close the auto film loader cover.
10. Replace the document mat before you resume scanning reflective (paper) documents.

### Scanning a Slide

1. Make sure you removed the reflective document mat, as described in the previous column.
2. Place the slide holder on the top of the scanner glass so that the tab labelled "D" fits into the area labelled "D" on the document table.

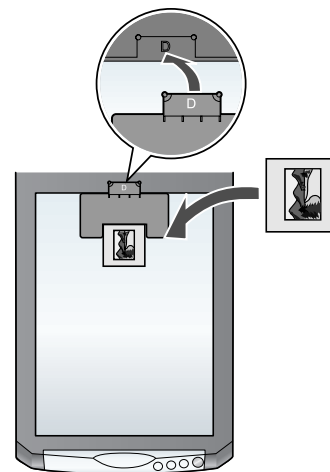

- Place a 35 mm slide into the holder with its shiny base side facing down. Your image should appear backwards on the side that faces up.

Place the top of the image toward the left side of the scanner.

- Close the scanner cover.
- To scan your slide, press the  Scan and Save button or open EPSON Smart Panel and select **Scan and Save**. This scans your slide using ideal settings in Full Auto Mode and opens it in ArcSoft PhotoImpression for viewing, editing, and printing. See your on-screen *Reference Guide* and Smart Panel help for instructions on selecting scan modes and complete scanning details.
- When you're finished scanning, you can store the slide holder in the scanner cover. Slide the holder into the cover, then replace the document mat.

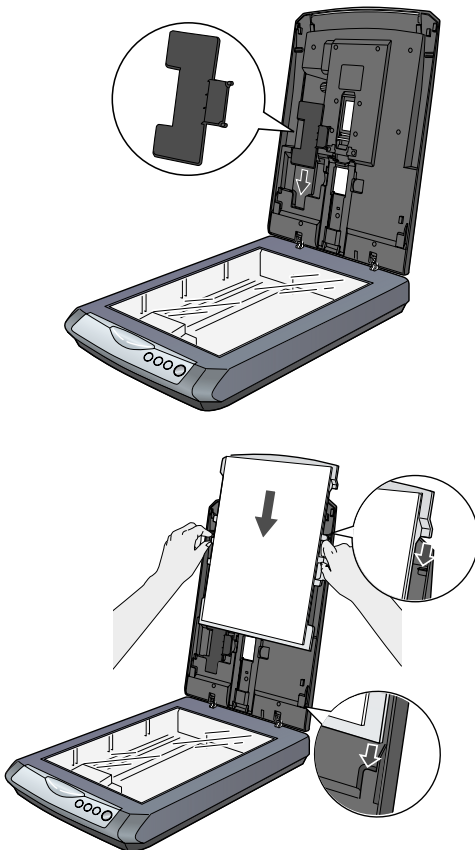

## Start Light

The scanner's  Start light indicates the scanner status.

 Start light	Scanner status
Flashing green	Warming up or scanning.
Green	Ready to scan.
Flashing red	Make sure the transportation lock is unlocked. Try restarting your computer and unplugging the scanner. Wait 10 seconds, then plug the scanner back in. Film may be jammed in the auto film loader. Disconnect the scanner from the computer, wait 10 seconds, and connect it to the computer again to see if the film ejects on its own. If film is still jammed, see your on-screen <i>Reference Guide</i> . If the red light is still flashing, contact your dealer or Epson.
Off	Make sure your scanner is connected to your computer and plugged into a power source.

## Transporting the Scanner

Before transporting the scanner for a long distance or storing it for an extended period of time, you need to lock the scanner's carriage to prevent damage.

- Plug in the scanner, connect it to your computer, and wait until the carriage moves to the home position (position nearest the buttons). While the  Start light is green, unplug the scanner.
- If the cover cable is attached, disconnect it.

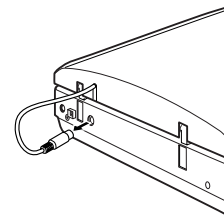

3. To lock the transportation lock, lift the scanner and slide the lock to the locked position. This secures the carriage.

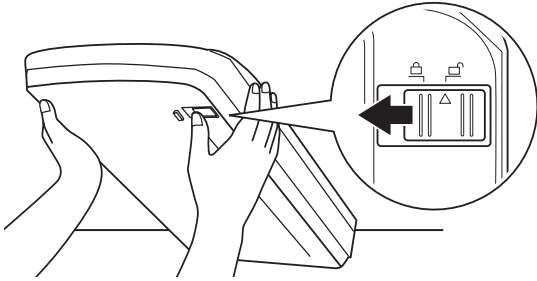

**Caution:** Do not turn the scanner over; this may damage it.

4. Attach the protective materials and repack the scanner in its original box.

---

## Related Documentation

---

CPD-17962	Epson Perfection 2480/2580 Photo <i>Start Here</i> sheet
CPD-17964	Epson Perfection 2480/2580 Photo Scanner Software CD-ROM
CPD-17965	Epson Perfection 2480/2580 Photo <i>Notices</i> booklet
—	Epson Perfection 2480/2580 Photo <i>Reference Guide</i> (HTML)

## Free Manuals Download Website

<http://myh66.com>

<http://usermanuals.us>

<http://www.somanuals.com>

<http://www.4manuals.cc>

<http://www.manual-lib.com>

<http://www.404manual.com>

<http://www.luxmanual.com>

<http://aubethermostatmanual.com>

Golf course search by state

<http://golfingnear.com>

Email search by domain

<http://emailbydomain.com>

Auto manuals search

<http://auto.somanuals.com>

TV manuals search

<http://tv.somanuals.com>