

# DENON

## DVD SURROUND SYSTEM

# D-M71DVS

## DVD SURROUND RECEIVER

# ADV-M71

## OPERATING INSTRUCTIONS

## MODE D'EMPLOI

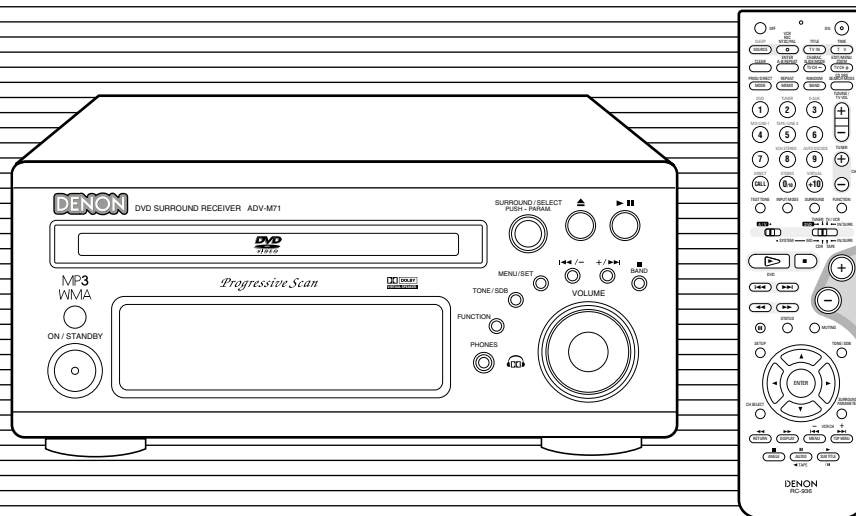

FOR ENGLISH READERS PAGE 4 ~ PAGE 111

- We greatly appreciate your purchase of this unit.
- To be sure you take maximum advantage of all the features this unit has to offer, read these instructions carefully and use the set properly. Be sure to keep this manual for future reference should any questions or problems arise.

"SERIAL NO. \_\_\_\_\_

PLEASE RECORD UNIT SERIAL NUMBER ATTACHED TO THE REAR OF THE CABINET FOR FUTURE REFERENCE"

POUR LES LECTEURS FRANCAIS PAGE 112 ~ PAGE 219

- Nous vous remercions pour l'achat de cet appareil.
- Pour être sûr de profiter au maximum de toutes les caractéristiques qu'offre cet appareil, lire avec soin ces instructions et bien utiliser l'appareil. Toujours conserver ce mode d'emploi pour s'y référer ultérieurement en cas de question ou de problème.

"NO. DE SERIE \_\_\_\_\_

PRIERE DE NOTER LE NUMERO DE SERIE DE L'APPAREIL INSCRIT A L'ARRIERE DU COFFRET DE FAÇON A POUVOIR LE CONSULTER EN CAS DE PROBLEME."

## ■ SAFETY PRECAUTIONS

### WARNING:

**TO PREVENT FIRE OR SHOCK HAZARD, DO NOT EXPOSE THIS APPLIANCE TO RAIN OR MOISTURE.**



**CAUTION**  
**RISK OF ELECTRIC SHOCK**  
**DO NOT OPEN**



### CAUTION:

**TO REDUCE THE RISK OF ELECTRIC SHOCK, DO NOT REMOVE COVER (OR BACK). NO USER-SERVICEABLE PARTS INSIDE. REFER SERVICING TO QUALIFIED SERVICE PERSONNEL.**



The lightning flash with arrowhead symbol, within an equilateral triangle, is intended to alert the user to the presence of uninsulated "dangerous voltage" within the product's enclosure that may be of sufficient magnitude to constitute a risk of electric shock to persons.



The exclamation point within an equilateral triangle is intended to alert the user to the presence of important operating and maintenance (servicing) instructions in the literature accompanying the appliance.

### CAUTION

TO PREVENT ELECTRIC SHOCK, MATCH WIDE BLADE OF PLUG TO WIDE SLOT, FULLY INSERT.

### ATTENTION

POUR ÉVITER LES CHOCS ÉLECTRIQUES, INTERODUIRE LA LAME LA PLUS LARGE DE LA FICHE DANS LA BORNE CORRESPONDANTE DE LA PRISE ET POUSSER JUSQU' AU FOND.

This device complies with Part 15 of the FCC Rules. Operation is subject to the following two conditions: (1) This device may not cause harmful interference, and (2) this device must accept any interference received, including interference that may cause undesired operation.

This Class B digital apparatus meets all requirements of the Canadian Interference-Causing Equipment Regulations.

Cet appareil numérique de la classe B respecte toutes les exigences du Règlement sur le matériel brouilleur du Canada.

### CAUTION:

#### 1. Handle the power supply cord carefully

Do not damage or deform the power supply cord. If it is damaged or deformed, it may cause electric shock or malfunction when used. When removing from wall outlet, be sure to remove by holding the plug attachment and not by pulling the cord.

#### 2. Do not open the top cover

In order to prevent electric shock, do not open the top cover.

#### 3. Do not place anything inside

Do not place metal objects or spill liquid inside the DVD video player. Electric shock or malfunction may result.

#### NOTE:

This DVD video player uses the semiconductor laser. To allow you to enjoy music at a stable operation, it is recommended to use this in a room of 5 °C (41 °F) ~ 35 °C (95 °F).

### Copyrights

■ It is prohibited by law to reproduce, broadcast, rent or play discs in public without the consent of the copyright holder.

## ■ NOTE ON USE / OBSERVATIONS RELATIVES A L'UTILISATION



- Avoid high temperatures. Allow for sufficient heat dispersion when installed on a rack.
- Eviter des températures élevées. Tenir compte d'une dispersion de chaleur suffisante lors de l'installation sur une étagère.



- Handle the power cord carefully. Hold the plug when unplugging the cord.
- Manipuler le cordon d'alimentation avec précaution. Tenir la prise lors du débranchement du cordon.

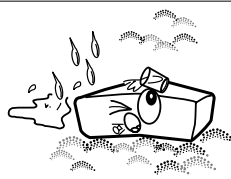

- Keep the set free from moisture, water, and dust.
- Protéger l'appareil contre l'humidité, l'eau et la poussière.



- Unplug the power cord when not using the set for long periods of time.
- Débrancher le cordon d'alimentation lorsque l'appareil n'est pas utilisé pendant de longues périodes.



\*(For sets with ventilation holes)

- Do not obstruct the ventilation holes.
- Ne pas obstruer les trous d'aération.



- Do not let foreign objects in the set.
- Ne pas laisser des objets étrangers dans l'appareil.



- Do not let insecticides, benzene, and thinner come in contact with the set.
- Ne pas mettre en contact des insecticides, du benzène et un diluant avec l'appareil.



- Never disassemble or modify the set in any way.
- Ne jamais démonter ou modifier l'appareil d'une manière ou d'une autre.

# SAFETY INSTRUCTIONS

1. Read Instructions – All the safety and operating instructions should be read before the product is operated.
2. Retain Instructions – The safety and operating instructions should be retained for future reference.
3. Heed Warnings – All warnings on the product and in the operating instructions should be adhered to.
4. Follow Instructions – All operating and use instructions should be followed.
5. Cleaning – Unplug this product from the wall outlet before cleaning. Do not use liquid cleaners or aerosol cleaners.
6. Attachments – Do not use attachments not recommended by the product manufacturer as they may cause hazards.
7. Water and Moisture – Do not use this product near water – for example, near a bath tub, wash bowl, kitchen sink, or laundry tub; in a wet basement; or near a swimming pool; and the like.
8. Accessories – Do not place this product on an unstable cart, stand, tripod, bracket, or table. The product may fall, causing serious injury to a child or adult, and serious damage to the product. Use only with a cart, stand, tripod, bracket, or table recommended by the manufacturer, or sold with the product. Any mounting of the product should follow the manufacturer's instructions, and should use a mounting accessory recommended by the manufacturer.
9. A product and cart combination should be moved with care. Quick stops, excessive force, and uneven surfaces may cause the product and cart combination to overturn.
10. Ventilation – Slots and openings in the cabinet are provided for ventilation and to ensure reliable operation of the product and to protect it from overheating, and these openings must not be blocked or covered. The openings should never be blocked by placing the product on a bed, sofa, rug, or other similar surface. This product should not be placed in a built-in installation such as a bookcase or rack unless proper ventilation is provided or the manufacturer's instructions have been adhered to.
11. Power Sources – This product should be operated only from the type of power source indicated on the marking label. If you are not sure of the type of power supply to your home, consult your product dealer or local power company. For products intended to operate from battery power, or other sources, refer to the operating instructions.
12. Grounding or Polarization – This product may be equipped with a polarized alternating-current line plug (a plug having one blade wider than the other). This plug will fit into the power outlet only one way. This is a safety feature. If you are unable to insert the plug fully into the outlet, try reversing the plug. If the plug should still fail to fit, contact your electrician to replace your obsolete outlet. Do not defeat the safety purpose of the polarized plug.



13. Power-Cord Protection – Power-supply cords should be routed so that they are not likely to be walked on or pinched by items placed upon or against them, paying particular attention to cords at plugs, convenience receptacles, and the point where they exit from the product.
15. Outdoor Antenna Grounding – If an outside antenna or cable system is connected to the product, be sure the antenna or cable system is grounded so as to provide some protection against voltage surges and built-up static charges. Article 810 of the National Electrical Code, ANSI/NFPA 70, provides information with regard to proper grounding of the mast and supporting structure, grounding of the lead-in wire to an antenna discharge unit, size of grounding conductors, location of antenna-discharge unit, connection to grounding electrodes, and requirements for the grounding electrode. See Figure A.
16. Lightning – For added protection for this product during a lightning storm, or when it is left unattended and unused for long periods of time, unplug it from the wall outlet and disconnect the antenna or cable system. This will prevent damage to the product due to lightning and power-line surges.
17. Power Lines – An outside antenna system should not be located in the vicinity of overhead power lines or other electric light or power circuits, or where it can fall into such power lines or circuits. When installing an outside antenna system, extreme care should be taken to keep from touching such power lines or circuits as contact with them might be fatal.
18. Overloading – Do not overload wall outlets, extension cords, or integral convenience receptacles as this can result in a risk of fire or electric shock.
19. Object and Liquid Entry – Never push objects of any kind into this product through openings as they may touch dangerous voltage points or short-out parts that could result in a fire or electric shock. Never spill liquid of any kind on the product.
20. Servicing – Do not attempt to service this product yourself as opening or removing covers may expose you to dangerous voltage or other hazards. Refer all servicing to qualified service personnel.
21. Damage Requiring Service – Unplug this product from the wall outlet and refer servicing to qualified service personnel under the following conditions:
  - a) When the power-supply cord or plug is damaged,
  - b) If liquid has been spilled, or objects have fallen into the product,
  - c) If the product has been exposed to rain or water,
  - d) If the product does not operate normally by following the operating instructions. Adjust only those controls that are covered by the operating instructions as an improper adjustment of other controls may result in damage and will often require extensive work by a qualified technician to restore the product to its normal operation,
  - e) If the product has been dropped or damaged in any way, and
  - f) When the product exhibits a distinct change in performance – this indicates a need for service.
22. Replacement Parts – When replacement parts are required, be sure the service technician has used replacement parts specified by the manufacturer or have the same characteristics as the original part. Unauthorized substitutions may result in fire, electric shock, or other hazards.
23. Safety Check – Upon completion of any service or repairs to this product, ask the service technician to perform safety checks to determine that the product is in proper operating condition.
24. Wall or Ceiling Mounting – The product should be mounted to a wall or ceiling only as recommended by the manufacturer.
25. Heat – The product should be situated away from heat sources such as radiators, heat registers, stoves, or other products (including amplifiers) that produce heat.

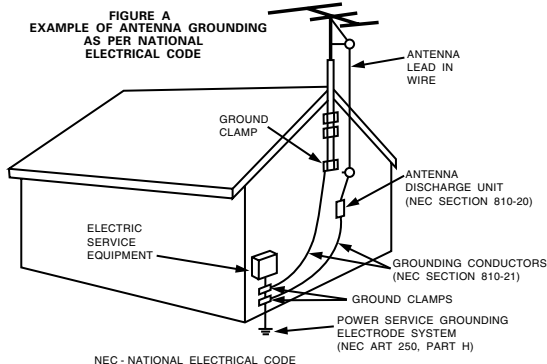

## ■ INTRODUCTION

Thank you for choosing the DENON ADV-M71 DVD Surround Receiver. This remarkable component has been engineered to provide superb surround sound listening with home theater sources such as DVD, as well as providing outstanding high fidelity reproduction of your favorite music sources. As this product is provided with an immense array of features, we recommend that before you begin hookup and operation that you review the contents of this manual before proceeding.

## TABLE OF CONTENTS

<b>1</b> BEFORE USING .....4	<b>13</b> DOLBY / DTS SURROUND.....46~48
<b>2</b> CAUTIONS ON INSTALLATION .....4, 5	<b>14</b> SURROUND PLAYBACK.....49~61
<b>3</b> CAUTIONS ON HANDLING .....5	<b>15</b> LISTENING TO THE RADIO.....62~64
<b>4</b> FEATURES .....5, 6	<b>16</b> ON-SCREEN DISPLAY .....65
<b>5</b> DISCS .....6	<b>17</b> USING THE ON-SCREEN DISPLAY .....66~83
<b>6</b> CAUTIONS ON HANDLING DISCS.....7	<b>18</b> USING THE TIMER .....84~90
<b>7</b> CONNECTIONS .....8~15	<b>19</b> CHANGING THE DEFAULT SETTINGS (DVD).....91~103
<b>8</b> PART NAMES AND FUNCTIONS .....16~20	<b>20</b> SYSTEM FUNCTION.....104~107
<b>9</b> REMOTE CONTROL UNIT.....21~28	<b>21</b> LAST FUNCTION MEMORY .....108
<b>10</b> SETTING UP THE SYSTEM .....29~38	<b>22</b> INITIALIZATION OF THE MICROPROCESSOR .....108
<b>11</b> PLAY BACK.....38~43	<b>23</b> TROUBLESHOOTING .....109, 110
<b>12</b> OPERATING THE SURROUND FUNCTIONS.....43~45	<b>24</b> SPECIFICATIONS .....111

## ■ ACCESSORIES

### ADV-M71

Check that the following parts are included in addition to the main unit:

- |                                 |   |                              |                                      |
|---------------------------------|---|------------------------------|--------------------------------------|
| ① Operating instructions .....1 | ② Warranty ( for North America model only ).....1 | ③ Service station list.....1 | ④ Remote control unit (RC-936).....1 |
| ⑤ R6P/AA batteries .....2       | ⑥ AM loop antenna.....1                           | ⑦ FM indoor antenna.....1    |                                      |

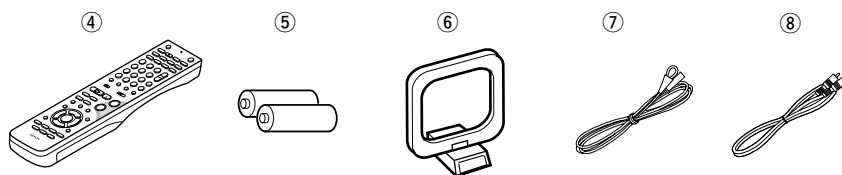

### SC-U71 [D-M71DVS only]

- ① Connecting cable (Approx. 3 m) ..... 2

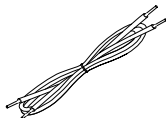

## 1 BEFORE USING

Pay attention to the following before using this unit:

### • Moving the set

To prevent short circuits or damaged wires in the connection cords, always unplug the power cord and disconnect the connection cords between all other audio components when moving the set.

### • Before turning the power switch on

Check once again that all connections are proper and that there are not problems with the connection cords. Always set the power switch to the standby position before connecting and disconnecting connection cords.

### • Store this instructions in a safe place.

After reading, store this instructions along with the warranty in a safe place.

### • Note that the illustrations in this instructions may differ from the actual set for explanation purposes.

## 2 CAUTIONS ON INSTALLATION

### (1) DVD SURROUND RECEIVER UNIT

Noise or disturbance of the picture may be generated if this unit or any other electronic equipment using microprocessors is used near a tuner or TV.

If this happens, take the following steps:

- Install this unit as far as possible from the tuner or TV.
- Set the antenna wires from the tuner or TV away from this unit's power cord and input/output connection cords.
- Noise or disturbance tends to occur particularly when using indoor antennas or 300 Ω/ohms feeder wires. **We recommend using outdoor antennas and 75 Ω/ohms coaxial cables.**

**For heat dispersal, leave at least 10 cm/4 inch of space between the top, back and sides of this unit and the wall or other components.**

### (2) SPEAKER UNIT (D-M71DVS only)

**The tone character produced by speaker systems depends on such factors as the size and type of room, the method of installation, etc. Pay attention to the following points when installing the speaker systems.**

- If the bass sound is overemphasized when the speaker systems are installed directly on the floor, set them on concrete blocks or other hard stands.
- Note that howling may be produced if the speaker systems are placed on the same stand or shelf as a record player.
- If there are walls or glass doors behind or in front of the speaker systems, use heavy curtains, etc., to prevent resonance and reflection.

- This is an anti-magnet type speaker system which can be used near television sets, etc., but with some TV sets the colors may become blotchy. If this happens, turn off the TV's power, wait 15 to 30 minutes, and turn the power back on. The TV's self demagnetizing circuit will improve the picture. If the colors are still blotchy, move the speaker systems further away from the TV.
- Also note that if there is a magnet or any device generating magnetic force nearby, interaction between this device and the speaker systems can cause the colors on the TV to become blotchy.

**WARNING**

- For your safety, do not put anything nor lean yourself on the loudspeakers.
- Do not push the loudspeaker from aside to protect it from tipping that may cause serious accident.
- Fix speaker cables to prevent being caught on it and making loudspeakers tipping down.

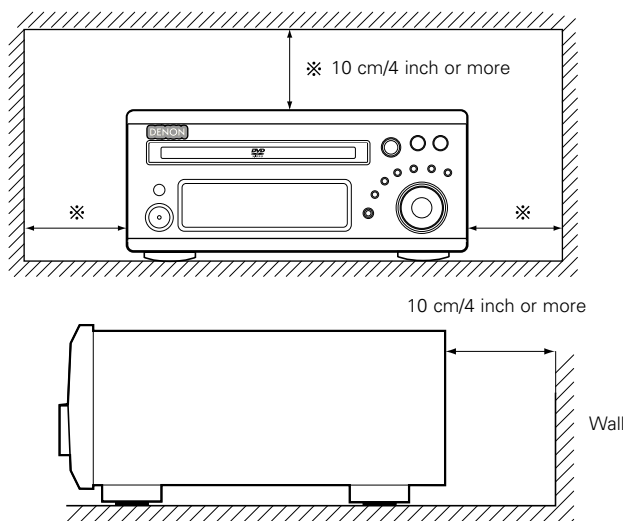
**3 CAUTIONS ON HANDLING****(1) DVD SURROUND RECEIVER UNIT**

- **Switching the input function when input jacks are not connected**

A clicking noise may be produced if the input function is switched when nothing is connected to the input jacks. If this happens, either turn down the MASTER VOLUME control or connect components to the input jacks.

- **Muting of PRE OUT jacks, HEADPHONE jack and SPEAKER terminals**

The PRE OUT jacks, HEADPHONE jacks and SPEAKER terminals include a muting circuit. Because of this, the output signals are greatly reduced for several seconds after the power switch is turned on or input function, surround mode or any other-set-up is changed. If the volume is turned up during this time, the output will be very high after the muting circuit stops functioning. Always wait until the muting circuit turns off before adjusting the volume.

- **Whenever the power switch is in the STANDBY state, the apparatus is still connected on AC line voltage. Please be sure to unplug the cord when you leave home for, say, a vacation.**

**(2) SPEAKER UNIT [D-M71DVS only]**

- Avoid placing the speaker systems in places exposed to direct sunlight for long periods of time or near heaters or other heating equipment.
- Placing in humid or dusty places may result in damage.
- Exposing the cabinet to insecticides or wiping it with benzene, thinner or other solvents may result in damage or discoloration to the finish. Use a soft cloth or silicone cloth to wipe any dirt off the cabinet. Use cloths containing chemical substances with care.
- Do not apply inputs exceeding the speaker system's max. input (the input which can be applied a short period of time with regular program sources).
- The output terminals may differ depending on the amplifier being used. Consult the amplifier's instructions.
- Clipping or other problems may occur in the output waveform when using the speaker systems with a high output and the amplifier's tone controls set to the maximum. Avoid using them under these conditions.
- Never play such special signals as a tape recorder's fast-forwarding signals or sine waves continuously.
- When moving the speaker systems, be careful not to apply excess force to the speaker nets. Doing so could damage the speaker units.

**4 FEATURES**

**The ADV-M71 combines an AV amplifier and DVD player, the core components of a home theater system, into a single compact, stylish body. The system takes up little space, and the aluminum front panel and half mirror of the display make for an elegant design that blends in nicely with the décor in your room.**

**1. 2-channel power amplifier with Dolby Virtual Speaker compatibility**

The ADV-M71 is equipped with two 35W (6 Ω/ohms 1kHz, T.H.D. 10%) power amplifiers that make it compatible with new Dolby Virtual Speaker technology for recreating a 5.1-channel environment virtually using a 2-channel configuration. (Dolby Virtual Speaker is a proprietary technology of Dolby Laboratories.) A high performance digital signal processor enables playback of Dolby Digital and DTS multi-channel surround signals in the Dolby Virtual Speaker mode. Surround sound can be achieved with the Dolby Virtual Speaker mode for CDs and other 2-channel sources in combination with the Dolby Pro Logic II decoder.

**2. 3.1-channel pre-out terminals allowing expansion into a 5.1-channel surround system**

When used in combination with a commercially available subwoofer with built-in amplifier and power amplifier, the ADV-M71 can be expanded into a 5.1-channel surround system. The ADV-M71 not only recreates an accurate sound field for multi-channel sources, it is also compatible with wide mode playback in the Dolby Virtual Speaker mode.

**3. Dolby Pro Logic II decoder for expanding sound field playback**

The ADV-M71 is equipped with a Dolby Pro Logic II decoder for expanding sound field playback for Dolby Surround and stereo music sources.

**4. DENON's unique sound field simulation using the DSP**

The ADV-M71 is compatible with the Rock Arena, Jazz Club and Video Game modes with a 2-channel configuration. In a 5.1-channel configuration, it is also compatible with the 5-Channel Stereo, Mono Movie and Matrix modes.

**5. High performance DVD drive for progressive image output compatibility**

The ADV-M71 is compatible with various functions offered by DVD sources, including multiple audio (up to 8 languages), multiple subtitle (up to 32 languages), multiple angle playback, viewing restriction, etc.

**6. Quick setup and on-screen display compatibility**

DVDs can be enjoyed simply by selecting the TV and speaker configuration to be used. Even with a 5.1-channel speaker configuration, standard parameters can be set automatically simply by selecting the size of the room in which the system is being used and the listening position. The system can be set up using an on-screen display function.

**5 DISCS**

- The types of discs listed on the table below can be used on the ADV-M71. The marks are indicated on the disc labels or jackets.

Usable discs	Mark (logo)	Recorded signals	Disc size
DVD video DVD audio (NOTE 1)		Digital audio + digital video (MPEG2)	12 cm
			8 cm
Video CD		Digital audio + digital video (MPEG1)	12 cm
			8 cm
CD CD-R CD-RW (NOTE 2)		Digital audio MP3 WMA Digital picture (JPEG)	12 cm
			8 cm
Picture CD		Digital picture (JPEG)	12 cm
FUJICOLOR CD		Digital picture (JPEG)	12 cm

**Disc terminology**

**Titles and chapters (DVD-videos)**

DVD-videos are divided into several large sections called "titles" and smaller sections called "chapters". Numbers are allotted to these sections. These numbers are called "title numbers" and "chapter numbers".

For example:

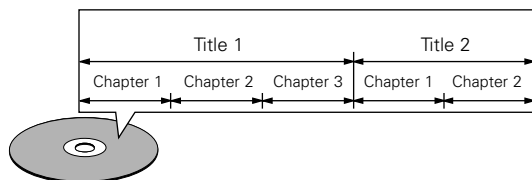

**Tracks (video and music CDs)**

Video and music CDs are divided into sections called "tracks". Numbers are allotted to these sections. These numbers are called "track numbers".

**7. Remote control unit with preset memory function**

The ADV-M71 comes with a remote control unit equipped with a preset memory function including the remote control operation codes for D-M31 series cassette decks and DENON remote control compatible components as well as the remote control operation codes of other major brands of TVs and video decks.

**8. Convenient system functions**

When system connections are made with a D-M31 series cassette deck, such system functions as auto function selection, synchronized recording and timer recording/playback can be performed easily.

For example:

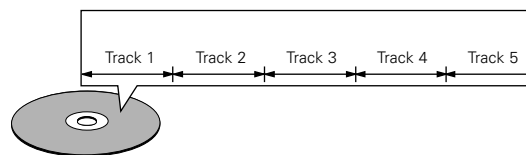

**The following types of discs cannot be played on the ADV-M71:**

- DVDs with region numbers other than "1" or "ALL"
- DVD audio discs (NOTE 1)
- DVD+R/+RW
- DVD-ROM/RAMs
- CVD
- SVCD
- CD-ROMs (Only MP3/WMA file can be played)
- VSDs
- CDVs (Only the audio part can be played.)
- CD-Gs (Only the audio is output.)
- Photo CDs (NEVER play such discs on the ADV-M71)

※ If you attempt to play photo CDs, the data on the disc may be damaged.

NOTE 1: Video part which based on DVD-video specification only can be played.

NOTE 2: According to recording quality, some CD-R/RW cannot be played.

**Playback control (video CDs)**

Video CDs including the words "playback control" on the disc or jacket are equipped with a function for displaying menus on the TV screen for selecting the desired position, displaying information, etc., in dialog fashion.

In this manual, playing video CDs using such menus is referred to "menu playback".

Video CDs with playback control can be used on the ADV-M71.

**NOTE:**

- This DVD video player is designed and manufactured to respond to the Region Management Information that is recorded on a DVD disc. If the Region number described on the DVD disc does not correspond to the Region number of this DVD video player, this DVD video player cannot play this disc. The Region number for this DVD video player is 1.



## 6 CAUTIONS ON HANDLING DISCS

### Discs

Only the discs including the marks shown on page 6 can be played on the ADV-M71.

Note, however, that discs with special shapes (heart-shaped discs, hexagonal discs, etc.) cannot be played on the ADV-M71. Do not attempt to play such discs, as they may damage the player.

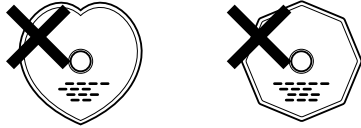

### Holding Discs

Avoid touching the surface of discs when loading and unloading them.

Be careful not to get fingerprints on the signal surface (the side which shines in rainbow colors).

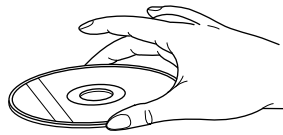

### Cleaning Discs

- Fingerprints or dirt on the disc may lower sound and picture quality or cause breaks in playback. Wipe off fingerprints or dirt.
- Use a commercially available disc cleaning set or a soft cloth to wipe off fingerprints or dirt.

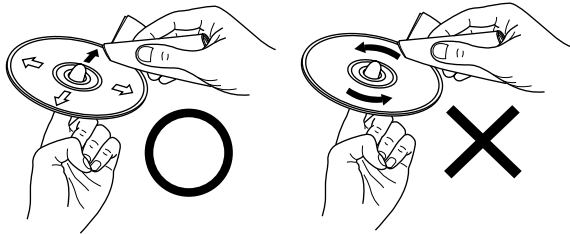

Wipe gently from the middle outwards.

Do not wipe with a circular motion.

#### NOTE:

- Do not use record spray or antistatic. Also do not use volatile chemicals such as benzene or thinner.

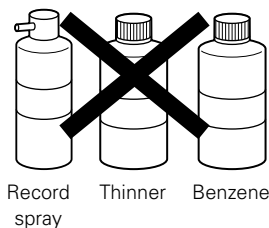

Record spray Thinner Benzene

### Cautions on Handling Discs

- Do not get fingerprints, grease or dirt on discs.
- Be especially careful not to scratch discs when removing them from their cases.
- Do not bend discs.
- Do not heat discs.
- Do not enlarge the center hole.
- Do not write on the labeled (printed) side with a ball-point pen or a pencil.
- Water droplets may form on the surface if the disc is moved suddenly from a cold place to a warm one. Do not use a hairdryer, etc., to dry the disc.

### Cautions on Storing Discs

- Always eject discs after playing them.
- Keep discs in their cases to protect them from dust, scratches and warping.
- Do not put discs in the following places:
  1. Places exposed to direct sunlight for long periods of time
  2. Humid or dusty places
  3. Places exposed to heat from heaters, etc.

### Cautions on Loading Discs

- Only load one disc at a time. Loading one disc on top of another may result in damage or scratch the discs.
- Load 8 cm discs securely in the disc guide, without using an adapter. If the disc is not properly loaded, it may slip out of the guide and block the disc tray.
- Be careful not to let your fingers get caught when the disc tray is closing.
- Do not place anything but discs in the disc tray.
- Do not load cracked or warped discs or discs that have been fixed with adhesive, etc.
- Do not use discs on which the adhesive part of cellophane tape or glue used to attach the label is exposed, or discs with traces of tape or labels that have been peeled off. Such discs may get stuck inside the player, resulting in damage.

## 7 CONNECTIONS

- Do not plug in the AC cord until all connections have been completed.
- Be sure to connect the left and right channels properly (left with left, right with right).
- Insert the plugs securely. Incomplete connections will result in the generation of noise.

- Note that binding pin plug cords together with AC cords or placing them near a power transformer will result in generating hum or other noise.
- Noise or humming may be generated if a connected audio equipment is used independently without turning the power of this unit on. If this happens, turn on the power of the this unit.

### (1) Connecting the audio components (D-M31 series)

- The ADV-M71 can be used connected in a system with the D-M31 series cassette deck (DRR-M31).
- For instructions on operating the separately sold cassette deck (DRR-M31), refer to their respective operating instructions.
- Only the DRR-M31 cassette deck can be connected directly to the ADV-M71 using system connections.

**NOTE:**

- This system includes digital circuitry which may cause interference such as color blotching or changes in the color on TVs. If this happens, move the system and the TV as far apart as possible.

**Connecting the speaker systems**

Connect the speaker system for the left channel (the left side as seen from the front) to the L terminals, the speaker system for the right channel to the R terminals. Refer to the instructions supplied with the speaker system for details. Be sure to use speaker systems with an impedance of 6 Ω/ohms or greater.

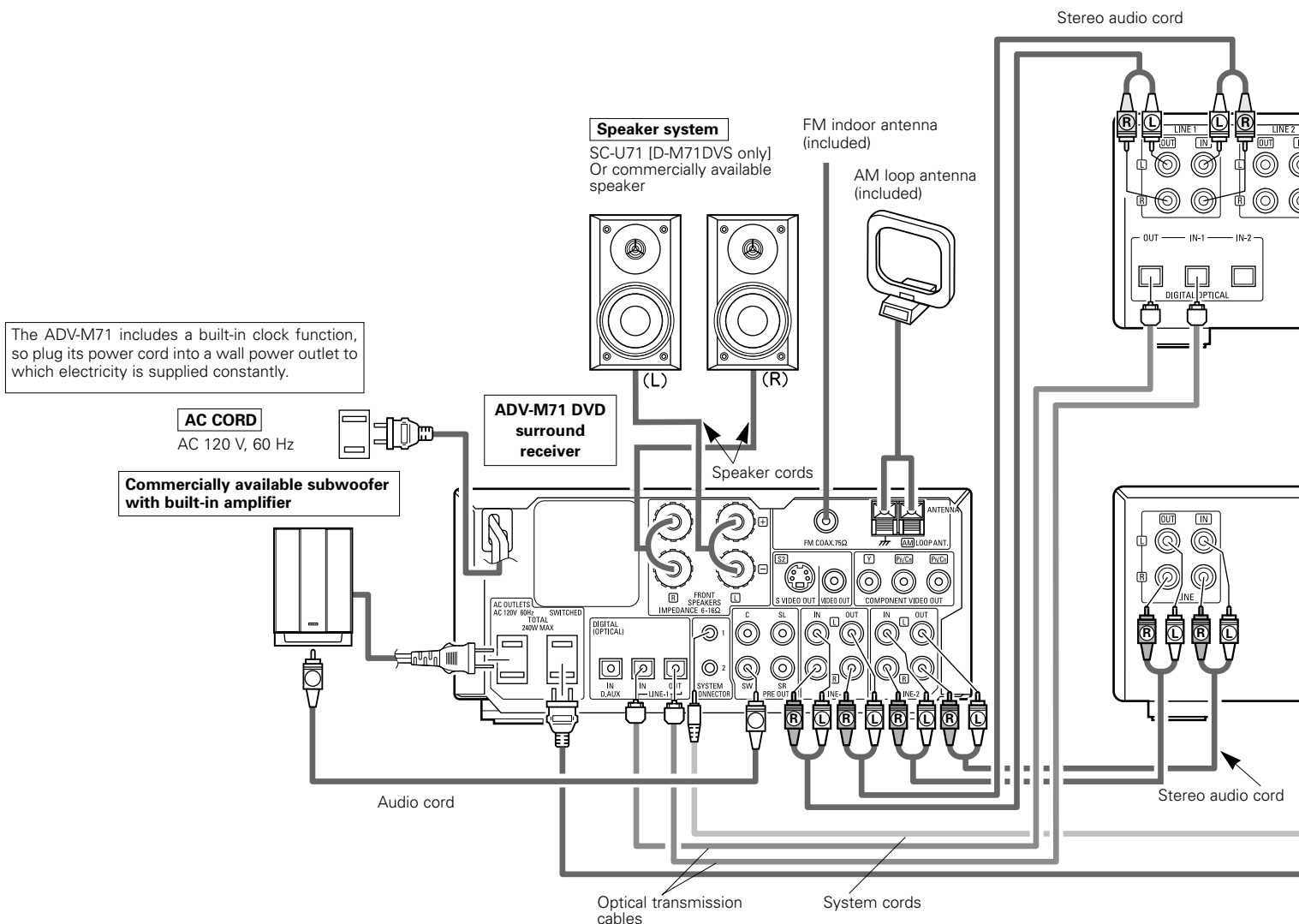



**CAUTION:**

- Only one cassette deck can be connected to the ADV-M71 using system connections. System operations cannot be performed properly if two cassette decks are connected using system connections.
- Whenever the power operation switch is in the STANDBY position, the unit is still connected to AC line voltage.
- Please be sure to unplug the power cord when you leave home for, e.g., a vacation, etc.

**Note to CATV system installer:**

This reminder is provided to call the CATV system installer's attention to Article 820-40 of the NEC which provides guidelines for proper grounding and, in particular, specifies that the cable ground shall be connected to the grounding system of the building, as close to the point of cable entry as practical.

**System operations**

Such system operations as the timer and the auto power on functions, as well as remote control operations cannot be performed unless all the RCA pin-plug cords and system connector cords are connected between the units, so be sure to make all the connections properly as shown in the diagram. Also, disconnecting system connectors while the system is operating may result in malfunctions. Be sure to unplug the power cord before changing connections.

**NOTES:**

- Do not plug the power cord into the power outlet until all connections are completed. Be sure to interconnect the channels (L to L (white) and R to R (red)) properly, as shown on the diagram.
- Use the AC OUTLET for audio equipment only. Do not use them for hair driers, etc.
- Insert the plugs securely. Incomplete connections may result in noise.
- Be sure to connect the speaker cords between the speaker terminals and the speaker systems with the same polarities ( + to +, - to - ). If the polarities are switched, the sound at the center will be weak, the position of the different instruments will be unclear, and the stereo effect will be lost.
- After unplugging the power cord, wait about 5 seconds before plugging it back in.
- Note that setting the connection cords (pin-plug cords) next to the power cords may result in humming or other noise.

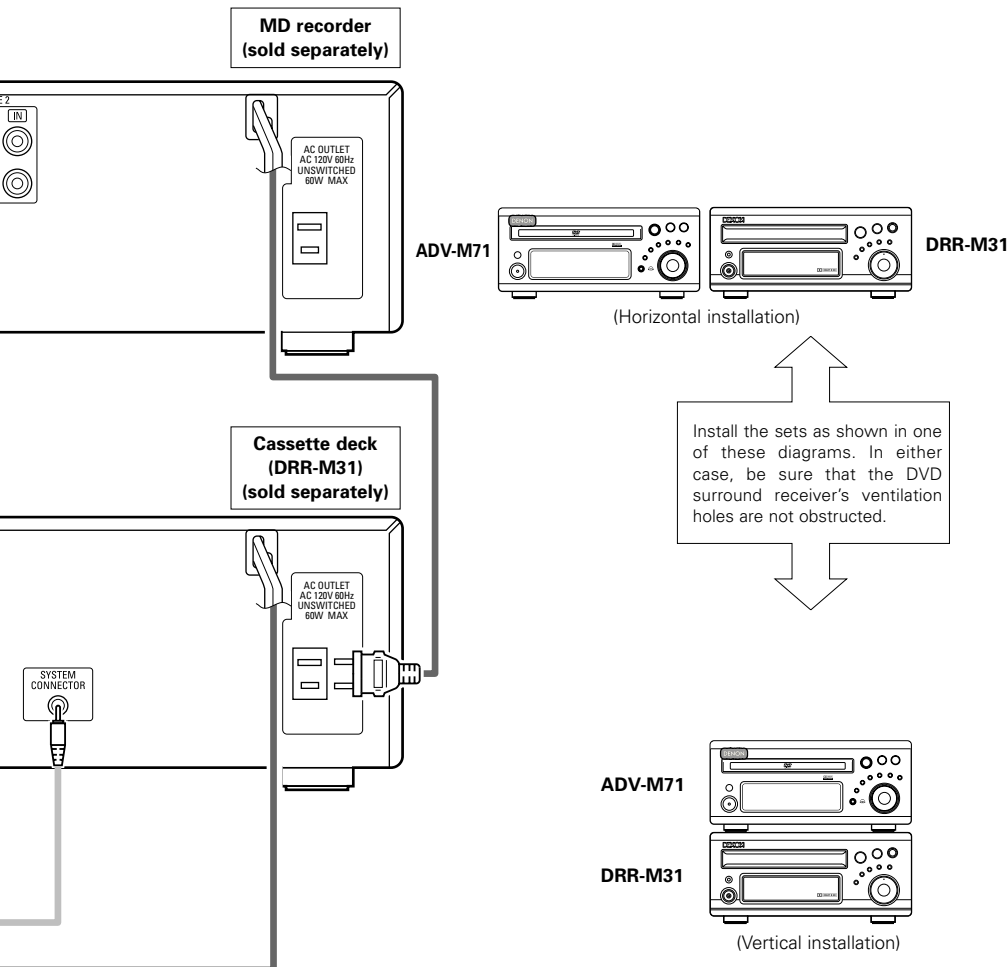

## (2) Connecting the PRE OUT terminals (only with multi-channel settings)

- When used in combination with a commercially available subwoofer with built-in amplifier and power amplifier, the ADV-M71 can be expanded into a 5.1-channel surround system.
- When making connections, also refer to the operating instructions of the other components.
- To make the 5.1-channel setting, set the speakers to "5.1 CH SURROUND" in the quick system setup and select "Room Setting" and "Listening Position". (See pages 31 to 32.)

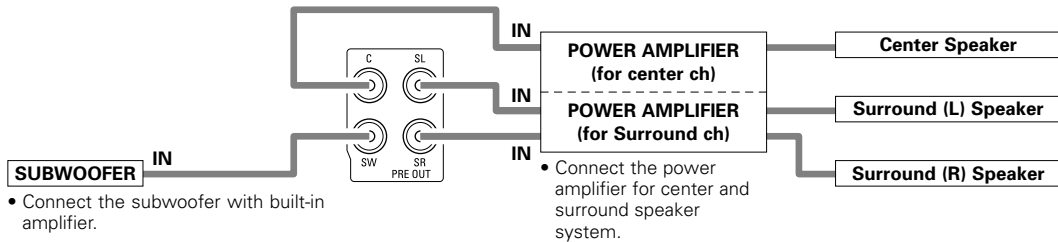

## (3) Connecting the Audio Signals of a Digital Satellite Tuner and VCR

- Connect the video signals directly to the TV and switch the picture on the TV.
- When making connections, also refer to the operating instructions of the other components.

### Connection to the optical digital input terminal

- Only audio signals are input to the optical digital input terminal.
- Use a commercially available optical transmission cable for connection to the optical transmission terminal (OPTICAL).

Digital satellite/cable tuner

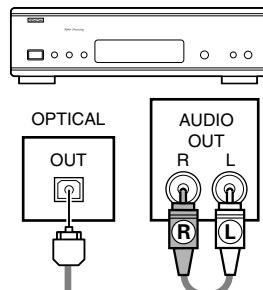

### Connection of a digital satellite/cable tuner

- For tuners equipped with an optical digital output terminal, connect the digital output terminal to the DIGITAL D.AUX IN terminal on the ADV-M71 using an optical transmission cable.
- To connect the audio output terminals, use whatever of the ADV-M71's LINE-1 or LINE-2 terminals are open.

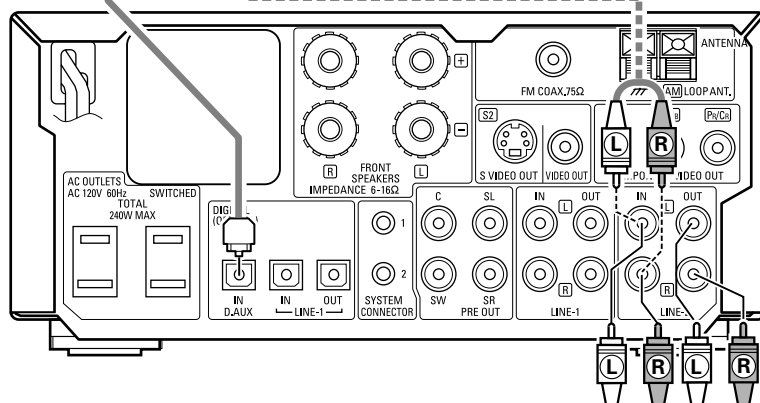

### Connection of a video deck

- Connect the video deck's audio output and audio input terminals to whatever of the ADV-M71's LINE-1 or LINE-2 terminals are open using pin-plug cords.

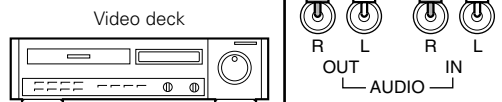

## (4) Connecting a TV

- When making connections, also refer to the operating instructions of the TV.

### S VIDEO TV

#### S VIDEO OUT

- Connect the TV's S video input (S-VIDEO INPUT) to the [S-VIDEO] OUT jack using a S jack connection cord.

#### VIDEO OUT

- Connect the TV's video input (VIDEO INPUT) to the VIDEO jack using a video connection cord.

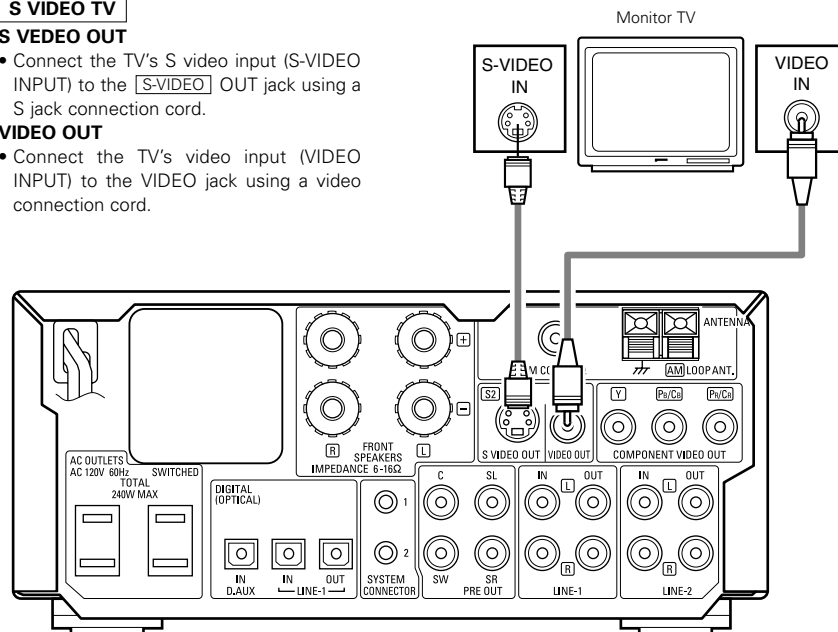

### NOTES:

- Connect this unit video outputs to the TV either directly. Do not connect it via a VCR (video cassette recorder). Some discs contain copy prohibit signals. If such discs are played via a VCR, the copy prohibit system may cause disturbance in the picture.
- Set the "TV TYPE" in "VIDEO SETUP" in "DVD SETUP" to comply with your TV's video format. When the TV is NTSC formatted set to NTSC.
- When "PROGRESSIVE" is set, no video signals are output from the VIDEO OUT or S-VIDEO OUT terminals. Set "INTERLACED" if you want to use the VIDEO OUT or S-VIDEO OUT signals. (Refer to page 39)

**(5) Connecting the antenna terminals**

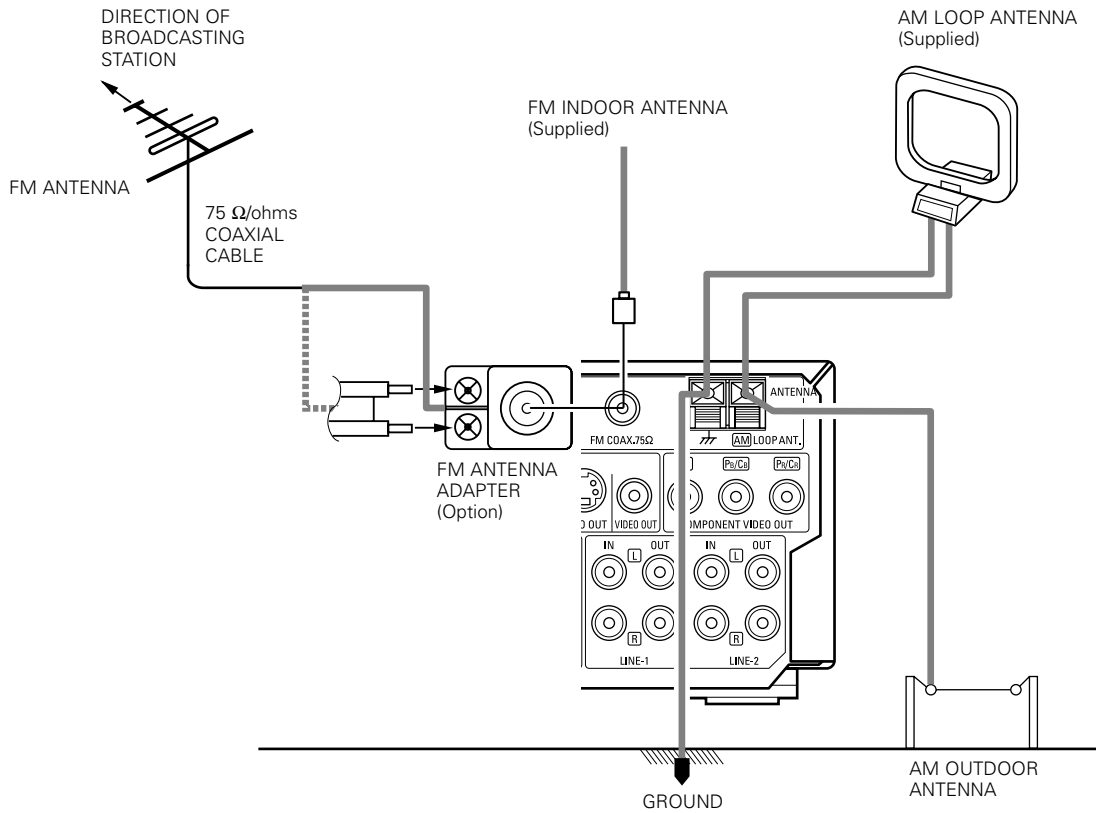

- An F-type FM antenna cable plug can be connected directly.
- If the FM antenna cable's plug is not of the F-type, connect using the F-type antenna adapter (Option).

**AM loop antenna assembly**

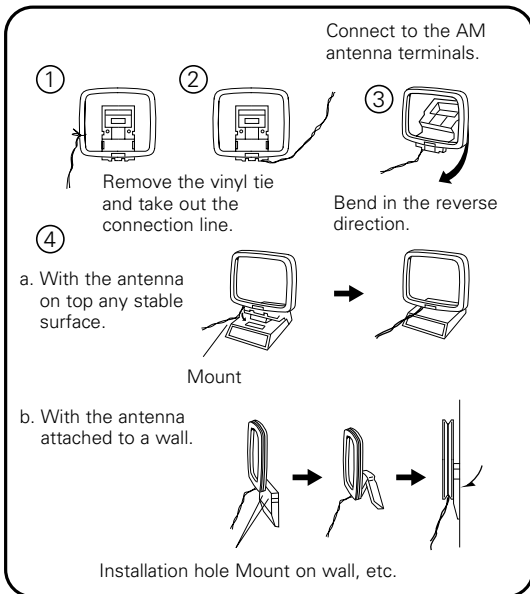

**Connection of AM antennas**

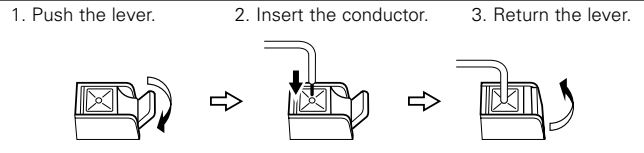

**Note to CATV system installer:**  
 This reminder is provided to call the CATV system installer's attention to Article 820-40 of the NEC which provides guidelines for proper grounding and, in particular, specifies that the cable ground shall be connected to the grounding system of the building, as close to the point of cable entry as practical.

- NOTES:**
- Do not connect two FM antennas simultaneously.
  - Even if an external AM antenna is used, do not disconnect the AM loop antenna.
  - Make sure AM loop antenna lead terminals do not touch metal parts of the panel.

## (6) Connecting to a TV or Monitor Equipped with Component Input Connectors.

- When making connections, also refer to the operating instructions of the other components.
- The video signals input to the VIDEO input (yellow) and S-Video input jacks are not output to the color difference (component) video jacks.

### Color component output connectors (PR/CR, PB/CB and Y)

The red (PR/CR), blue (PB/CB) and brightness (Y) signals are output independently, achieving more faithful reproduction of the colors.

- The color component input connectors may be marked differently on some TVs or monitors (PR, PB and Y/R-Y, B-Y and Y/CR, CB and Y, etc.). For details, refer to the TV's operating instructions.

**Connect in this way if your TV is compatible with Progressive Scan.**

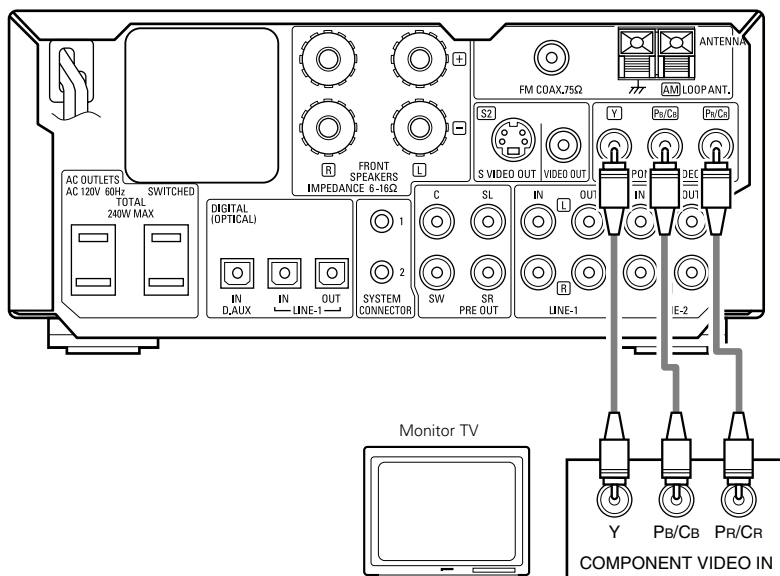

### Connecting a monitor TV

#### COMPONENT VIDEO OUT jack

- Connect the TV's color difference (component) video input jacks (COMPONENT VIDEO INPUT) to the COMPONENT VIDEO OUT jack using 75 Ω/ohms coaxial video pin-plug cords.

### NOTES:

- Use the three commercially available video cords to connect the ADV-M71's color component output connectors to the TV or monitor.
- Set the "TV TYPE" in "VIDEO SETUP" in "DVD SETUP" to comply with your TV's video format. When the TV is NTSC formatted set to NTSC.
- About selecting the video output "INTERLACED" or "PROGRESSIVE", refer to page 39.

CONSUMERS SHOULD NOTE THAT NOT ALL HIGH DEFINITION TELEVISION SETS ARE FULLY COMPATIBLE WITH THIS PRODUCT AND MAY CAUSE ARTIFACTS TO BE DISPLAYED IN THE PICTURE. IN CASE OF 525 PROGRESSIVE SCAN PICTURE PROBLEMS, IT IS RECOMMENDED THAT THE USER SWITCH THE CONNECTION TO THE "STANDARD DEFINITION" OUTPUT.

**(7) Sound output from this unit digital and analog audio output connectors**

**■ When a disc is played on the ADV-M71 (DIGITAL OUT)**

		Settings	Refer to page	Digital audio data output	
Audio recording format					
DVD video DVD audio (video part only)	Dolby Digital	Digital out : Normal	98	Dolby Digital bitstream	
		Digital out : PCM conversion		2 channels PCM data (48 kHz/16bit)	
	DTS	Digital out : Normal		DTS bitstream	
		Digital out : PCM conversion		2 channels PCM data (48 kHz/16bit)	
	Linear PCM	48 kHz	LPCM conversion mode : OFF	98	48 kHz/16 ~24 bit PCM
			LPCM conversion mode : ON		48 kHz/16 bit PCM
		96 kHz	LPCM conversion mode : ON		48 kHz/16 bit PCM
		CP : ON	LPCM conversion mode : OFF		48 kHz/16 bit PCM (when copy-protected)
		CP : OFF	LPCM conversion mode : OFF		96 kHz PCM (when not copy-protected)
	Video CD	MPEG 1			44.1 kHz/16 bit PCM
Music CD	Linear PCM		44.1 kHz/16 bit PCM		
MP3/WMA CD	MP3/WMA		32 ~ 48 kHz/16 bit PCM		

- Linear PCM audio is the signal recording format used for music CDs. While the signals are recorded at 44.1 kHz/16 bit for music CDs, for DVDs they are recorded at 48 kHz/16 bit to 96 kHz/24 bit, providing higher sound quality than music CDs.

**■ About the LINE-1 and LINE-2 analog recording outputs**

**When the DVD or the D.AUX digital input is selected:**

- Dolby Digital, DTS, AAC and PCM digital signals are automatically converted to 2-channel stereo signals before being output (except when in the Dolby Headphone mode) and can be recorded in analog. (For what happens in the Dolby Headphone mode, see 3 below.)

**When TUNER, LINE-1 or LINE-2 is selected:**

- The selected analog audio signals from the tuner or from the device connected to the LINE-1 or LINE-2 analog input terminals (IN) are output unchanged, regardless of the ADV-M71's input mode or surround mode. (The same is true for the device connected to the D.AUX terminals when "LINE-2" under "[10] SETTING UP THE SYSTEM – (3) Detailed system setup – [5] Function settings" is set to "D.AUX".)

**Recording output during playback of a DVD, D.AUX or LINE-1 digital input source in the Dolby Headphone mode:**

- In the Dolby Headphone mode with a DVD or a digital input selected, the Dolby Headphone mode analog audio signals currently being played are output and can be recorded in analog. (See pages 57 and 58.)

**Cautions during analog recording of DVDs or digital input sources:**

- Do not switch the ADV-M71's input mode, surround mode or surround parameters during recording. Doing so will interrupt the sound being recorded.  
We recommend setting the surround mode to "STEREO" or "DIRECT".
- When using headphones, recording is automatically performed in the Dolby Headphone mode. Do not disconnect the headphones or switch the headphones mode during recording.

## (8) Speaker system connections

**Be sure to turn the amplifier's power off when connecting the speaker systems.**

- Use the included cables to connect the input terminals on the back of the speaker systems (see diagram) to the amplifier's speaker output terminals. Connect the speaker system for the left channel amplifier's "L" terminals, the one for the right channel to the amplifier's "R" terminals, matching the polarities ("⊕" and "⊖" marks). Inverting the polarities will result in unnatural sound, with the phase off or no low bass sound. Also check that all two terminal knobs are tightly fastened.

### Connections

(The red terminals on the right side are the "⊕" terminals, the black ones on the left side the "⊖" terminals.)

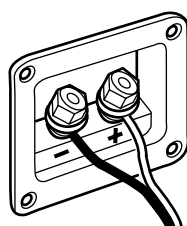

Loosen the terminals knobs, insert the cables' core wires, then tighten the knobs.

Connect to amplifier's "⊕" side. (Copper color)

Connect to amplifier's "⊖" side. (Silver color)

**NOTE:**  
Make sure the core wires do not touch each other.

### Connecting the speaker cords

Use the included connection cords to connect the input terminals on the backs of the speaker systems (see the diagram at the right) to the ADV-M71's speaker output terminals.

- Connect the speaker system for the left channel to the "L" terminals, the speaker system for the right channel to the "R" terminals, and be sure the polarities ("+" and "-") are properly interconnected.
- Note that if the polarities are inverted, the phase may be off and the bass sound may be missing, resulting in an unnatural sound. Also check that both the speaker terminal's screws are tightly screwed.

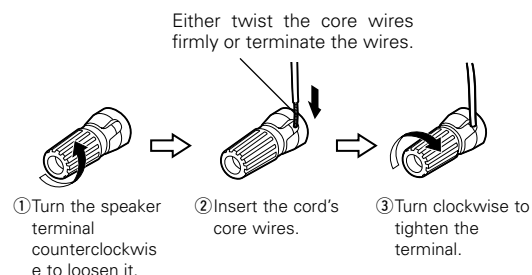

### Connecting banana plugs

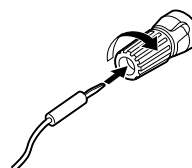

When using banana plugs, turn clockwise to tighten the terminal before inserting.

## Protector circuit

- This unit is equipped with a high-speed protection circuit. The purpose of this circuit is to protect the speakers under circumstances such as when the output of the power amplifier is inadvertently short-circuited and a large current flows, when the temperature surrounding the unit becomes unusually high, or when the unit is used at high output over a long period which results in an extreme temperature rise. When the protection circuit is activated, the speaker output is cut off and the power supply indicator LED flashes. Should this occur, please follow these steps: be sure to switch off the power of this unit, check whether there are any faults with the wiring of the speaker cables or input cables, and wait for the unit to cool down if it is very hot. Improve the ventilation condition around the unit and switch the power back on. If the protection circuit is activated again even though there are no problems with the wiring or the ventilation around the unit, switch off the power and contact a DENON service center.

## Note on speaker impedance

- The protector circuit may be activated if the set is played for long periods of time at high volumes when speakers with an impedance lower than the specified impedance (for example speakers with an impedance of lower than 4 Ω/ohms) are connected. If the protector circuit is activated, the speaker output is cut off. Turn off the set's power, wait for the set to cool down, improve the ventilation around the set, then turn the power back on.

## Cautions on connecting

- With this unit's speaker outputs, signals with the reverse phase of the "+" side output terminal's signals are also output from the "-" side output terminal. Do not connect to a device for switching between multiple speakers (a speaker selector or audio channel selector) or connect in ways other than described in this manual. Doing so will result in damage.

## (8) Removing the speaker net (D-M71DVS only)

- The net on the front of the speaker system is detachable.
- To remove it, grasp it on both sides and pull it towards you.
- To attach the net, line up the plastic pieces holes out of the net with the sticking in the cabinet and press in.

## 8 PART NAMES AND FUNCTIONS

### Front Panel

- For details on the functions of these parts, refer to the pages given in parentheses ( ).

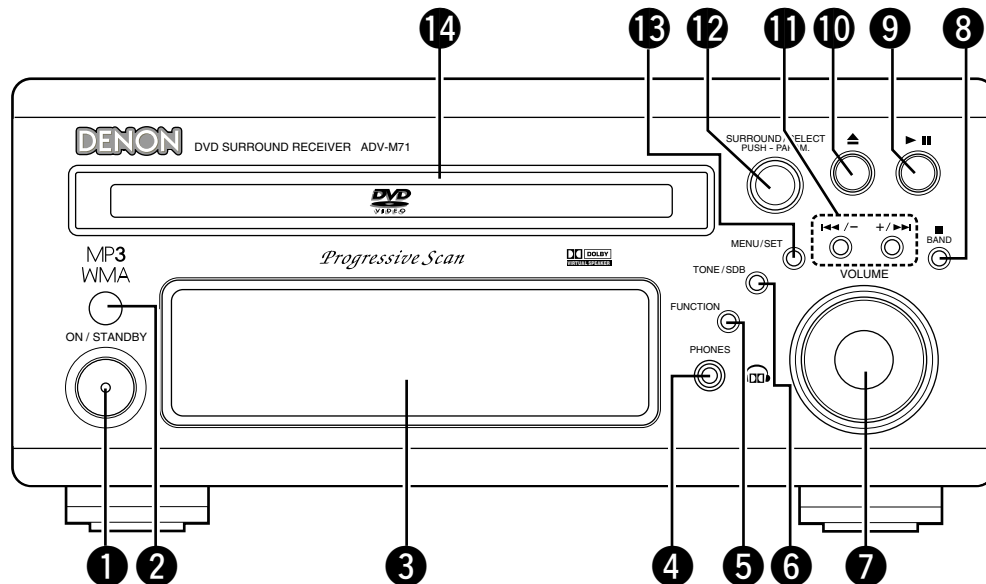

- |   |   |
|---|---|
| 1 Power button (ON/STANDBY).....(30)                  | 8 Stop/band button ( ■ BAND).....(41, 62)                                   |
| 2 Remote control sensor.....(21)                      | 9 Play/pause button ( ▶ /   ).....(40)                                      |
| 3 Display   | 10 Open/close button ( ▲ ) .....(40)  |
| 4 Headphones jack (PHONES) .....(57)                  | 11 Skip backward and forward buttons<br>( ◀◀ / - and + / ▶▶ ) .....(42, 62) |
| 5 Function selector (FUNCTION).....(43)               | 12 Surround/select knob (SURROUND/SELECT) .....(49)                         |
| 6 Tone/super dynamic bass button (TONE/SDB) .....(45) | Surround parameter button (PARAMETER) .....(50)                             |
| 7 Volume control (VOLUME) .....(41)                   | 13 Menu/set button (MENU/SET) .....(64)                                     |
|   | 14 Disc holder .....(39)  |



## Remote control unit

- For details on the functions of these parts, refer to the pages given in parentheses ( ).
- Some of the buttons on the remote control unit have some functions. The functions are switched using the remote control mode selector switches.

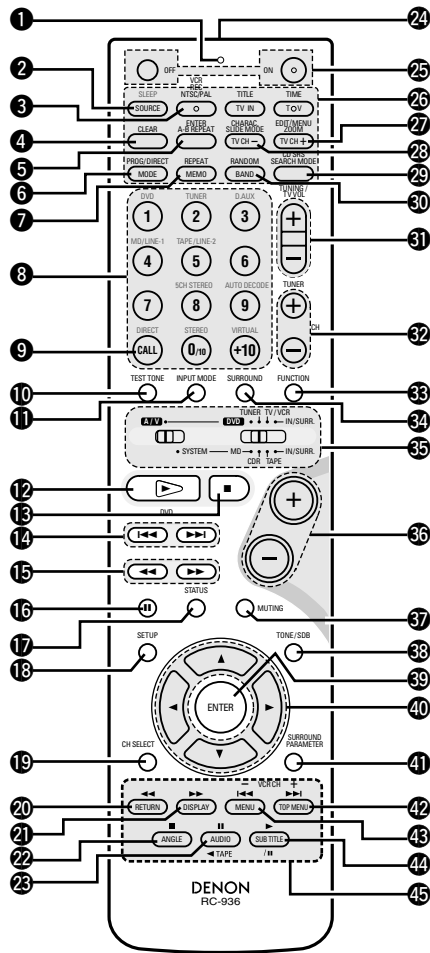

- 1 Transmission indicator
- 2 Sleep timer button .....(90)
- 3 NTSC/PAL button .....(11)
- 4 Clear button.....(70)
- 5 A-B repeat button.....(69)
- 6 Program/direct.....(70)
- 7 Repeat button.....(68)
- 8 Input source/surround mode selector button
- \* System buttons .....(19, 20, 22, 23, 28)

- 9 Call button .....(70)
- 10 Test tone button .....(36)
- 11 Input mode selector button.....(43)
- 12 DVD play button .....(40)
- 13 DVD stop button .....(41)
- 14 DVD skip buttons .....(42)
- 15 DVD search buttons .....(42, 43)
- 16 DVD pause button.....(42)
- 17 Status button.....(44)
- 18 Setup button.....(30)
- 19 Channel select button .....(36)
- 20 Return button .....(41)
- 21 Display button .....(66)
- 22 Angle button.....(80)
- 23 Audio selector button.....(78)
- 24 Remote control signal transmission window .....(21)
- 25 Power button.....(30)
- 26 \* System buttons.....(19, 22)
- 27 Zoom button.....(83)
- 28 Slide mode button.....(77)
- 29 Search mode button.....(42)
- 30 Random button.....(71)
- 31 Tuner tuning +/- buttons .....(62)
- 32 Tuner preset +/- buttons.....(64)
- 33 Function selector button .....(43)
- 34 Surround mode selector button .....(44)
- 35 Mode selector switches.....(18, 19)
- 36 Main volume control buttons .....(41)
- 37 Muting button.....(45)
- 38 Tone/SDB button .....(45)
- 39 Enter button .....(29)
- 40 Cursor button .....(29)
- 41 Surround parameter button .....(49)
- 42 Top menu button.....(81)
- 43 Menu button.....(82)
- 44 Subtitle button.....(79)
- 45 \* System buttons.....(19, 22, 28)

- For details on the function and operation of the various parts, refer to the pages indicated in (parentheses).
- Buttons indicated   are DVD control buttons and can be operated when the remote control mode selector switch is set to the **A/V** and **DVD** position.
- The functions of the system buttons (\*) are switched using the remote control mode selector switch.

## Names and functions of remote control unit buttons on the ADV-M71

- Buttons in sections ① ~ ③ can be operated regardless of the position of mode switches 1 and 2.
- Consider **A/V** and **DVD** as standard positions, and switch as necessary to operate.

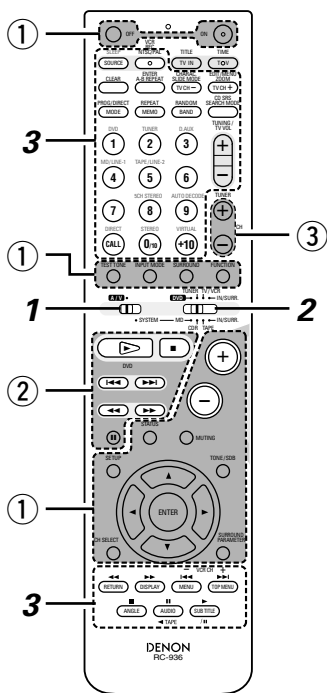

- ① Surround amplifier control buttons
- ON : Turns the ADV-M71's power on.
  - OFF : Turns the ADV-M71's power off.
  - FUNCTION : Function selection (in order)
  - SURROUND : Surround mode selection
  - INPUT MODE : Input mode selection
  - TEST TONE : Test tone on/off
  - + : Main volume up
  - : Main volume down
  - MUTING : Muting on/off
  - STATUS : Status display selection
  - TONE/SDB : Tone/SDB selection and setting
  - SURROUND : Surround parameter selection and setting
  - PARAMETER
  - SET UP : Setup mode on/off
  - CH SELECT : Channel level selection and setting
  - ▲, ▼, ◀, ▶ : Cursor up, down, left and right
  - ENTER : Enter setting

- ② DVD control buttons
- ▶ : Play (auto power on and auto function selection)
  - : Stop
  - ◀, ▶ : Skip (cueing)
  - ◀◀, ▶▶ : Search (fast-reverse and fast-forward)
  - ⏸ : Pause and frame-by-frame

- ③ Tuner control buttons
- CH +/- : Preset channel up/down (auto power on and auto function selection)

**1** Set mode switch 1 to the "A/V" position.

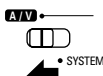

**2** Set mode switch 2 to the position of the function you want to operate (DVD, TUNER or IN/SURR).

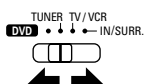

### 3 Operate the ADV-M71.

#### [1] Surround amplifier system buttons (Operated with mode switch 2 set to "IN/SURR.")

- These operations are possible with mode switch 1 at any position.  
The operations in gray print can be performed.

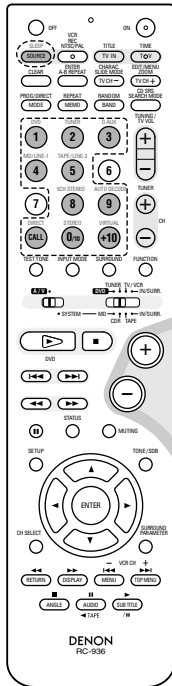

- SLEEP : Sleep on/off
- DVD : Function DVD
- TUNER : Function TUNER
- D.AUX : Function D.AUX
- MD/LINE-1 : Function MD/LINE-1
- TAPE/LINE-2 : Function TAPE/LINE-2
- 5CH STEREO : 5-channel stereo surround mode  
(when "5.1CH" selected in setup)
- AUTO DECODE : 2-channel mode switching when auto  
decode surround mode set  
(when "5.1CH" selected in setup)
- VIRTUAL : 2-channel mode switching when Dolby  
Virtual Speaker or Dolby VS surround mode  
set
- STEREO : Stereo mode
- DIRECT : Direct mode

#### [2] DVD system buttons (Operated with mode switch 2 set to "DVD")

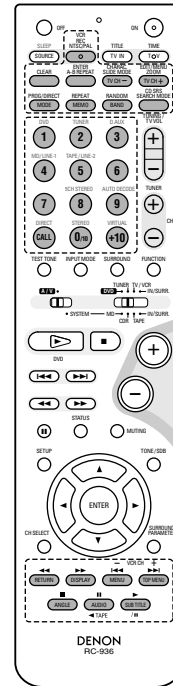

- NTSC/PAL : NTSC/PAL selection
- ZOOM : Zoom on/off
- SLIDE MODE : JPEG image slide mode selection
- A-B REPEAT : A-B repeat playback setting
- CLEAR : Program clear
- SEARCH MODE : Title and chapter search selection
- RANDOM : Random play on/off
- REPEAT : Repeat play setting
- PROG/DIRECT : Program/direct play selection
- CALL : Program call
- 0 ~ 9, +10 : Number buttons
- TOP MENU : Top menu call
- MENU : Menu call
- DISPLAY : Display call/selection
- RETURN : Menu return
- SUBTITLE : Subtitle language selection
- AUDIO : Audio language selection
- ANGLE : Angle selection

**3** [3] Tuner system buttons  
(Operated with mode switch 2 set to "TUNER")

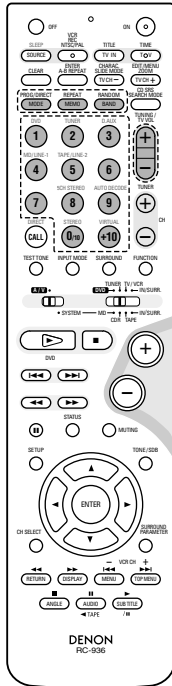

- BAND : FM/AM band selection
- MEMO : Preset memory
- MODE : FM auto/mono mode selection
- TUNER +/- : Tuning up/down
- 1 ~ 10, +10 : Preset channel number buttons

## 9 REMOTE CONTROL UNIT

- The included remote control unit (RC-936) can be used to operate not only this unit but other remote control compatible DENON components as well. In addition, the memory contains the control signals for other remote control units, so it can be used to operate non-DENON remote control compatible products.

### (1) Inserting the batteries

- Remove the remote control unit's rear cover.

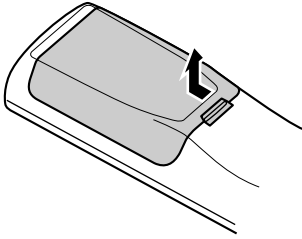

- Set three R6P/AA batteries in the battery compartment in the indicated direction.

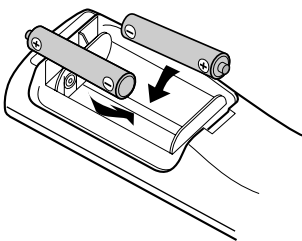

- Put the rear cover back on.

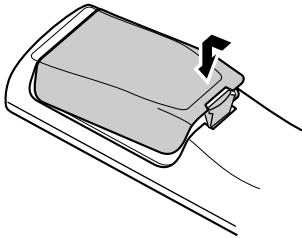

#### Notes on Batteries

- Use R6P/AA batteries in the remote control unit.
- The batteries should be replaced with new ones approximately once a year, though this depends on the frequency of usage.
- Even if less than a year has passed, replace the batteries with new ones if the set does not operate even when the remote control unit is operated nearby the set. (The included battery is only for verifying operation. Replace it with a new battery as soon as possible.)
- When inserting the batteries, be sure to do so in the proper direction, following the "⊕" and "⊖" marks in the battery compartment.
- To prevent damage or leakage of battery fluid:
  - Do not use a new battery together with an old one.
  - Do not use two different types of batteries.
  - Do not short-circuit, disassemble, heat or dispose of batteries in flames.
- Remove the batteries from the remote control unit when you do not plan to use it for an extended period of time.
- If the battery fluid should leak, carefully wipe the fluid off the inside of the battery compartment and insert new batteries.
- When replacing the batteries, have the new batteries ready and insert them as quickly as possible.

### (2) Using the remote control unit

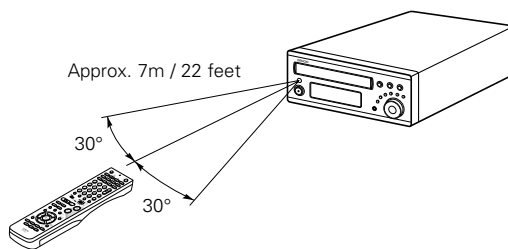

- Point the remote control unit at the remote sensor on the main unit as shown on the diagram.
- The remote control unit can be used from a straight distance of approximately 7 meters/22 feet from the main unit, but this distance will be shorter if there are obstacles in the way or if the remote control unit is not pointed directly at the remote sensor.
- The remote control unit can be operated at a horizontal angle of up to 30 degrees with respect to the remote sensor.

#### NOTES:

- It may be difficult to operate the remote control unit if the remote sensor is exposed to direct sunlight or strong artificial light.
- Do not press buttons on the main unit and remote control unit simultaneously. Doing so may result in malfunction.
- Neon signs or other devices emitting pulse-type noise nearby may result in malfunction, so keep the set as far away from such devices as possible.

- The included remote control unit (RC-936) can be used to operate not only the ADV-M71 but also to perform system operations for the D-M31 series and to operate other remote control compatible DENON products. In addition, the remote control operation codes of other major brands of TVs and video decks are also stored in the remote control unit, so the unit can be used to operate these TVs and video decks as well.

**(3) Operating DENON audio components**

- Turn on the power of all the components before operating them.
- Depending on the model and year of make of your component, some of the keys may not work.

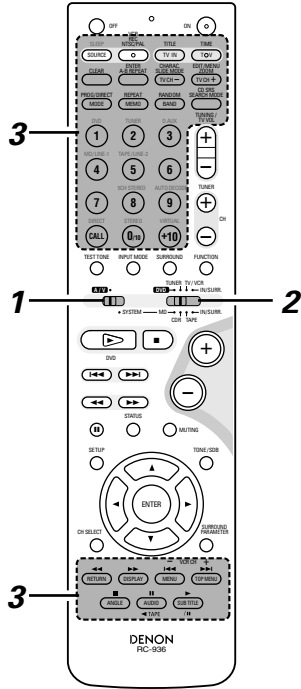

**1** Set mode switch 1 to the "SYSTEM" position. (Blue print)

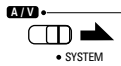

**2** Set mode switch 2 to the position for the component to be operated (MD, CDR or TAPE). (Blue print)



**3** Operate the audio component.  
 • For details, refer to the component's operating instructions.  
 ※ Operation may not be possible for some models.

**3 [1] CD recorder system buttons**  
 (operated with mode switch 2 set to "CDR")

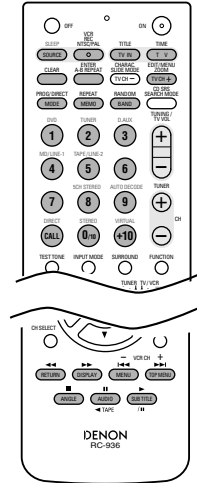

- TIME : Disc time display
- TITLE : Name display and selection of characters when inputting names
- REC : Recording
- SOURCE : CD recorder power on/off
- EDIT/MENU : Menu selection
- ENTER : Entering of menu items
- CLEAR : Program clearing
- RANDOM : Random play on/off
- REPEAT : Repeat play setting
- PROG/DIRECT : Program/direct playback selection
- CALL : Program calling
- 1~10, +10 : Track number selection
- ◀◀, ▶▶ : Auto search (cueing)
- ◀◀, ▶▶ : Manual search (fast-reverse and fast-forward)
- ▶ / || : Play (play/pause, auto power on and auto function selection with the CDR-M30)
- || : Pause
- : Stop

**[2] Tape deck system button**  
 (operated with mode switch 2 set to "TAPE")

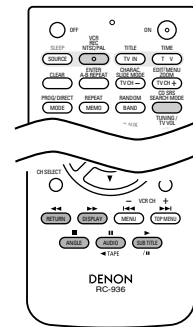

- REC : Recording
- CD SRS : CD synchronized recording (DRR-M31 system function)
- ◀◀, ▶▶ : Rewind and fast-forward
- ▶ : Forward direction play
- ◀ TAPE : Reverse direction play (◀ and ▶: auto power on and auto function selection with the DRR-M31)

### (4) TV and video deck preset memories

- Components of other brands can be operated with the included remote control unit by storing their codes in the preset memory. Note that depending on the model some operations may not be possible and some buttons may not operate properly.

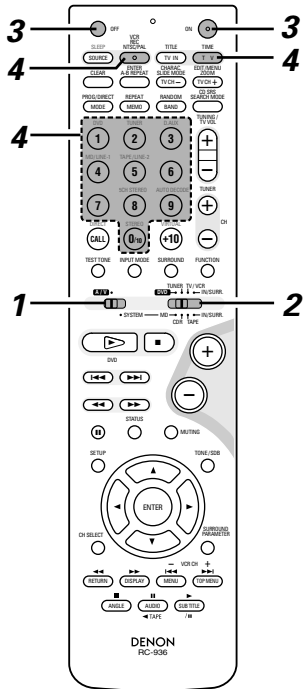

**4** Press the TV button to preset a TV, the VCR button to preset a video deck, then input the 3-digit number corresponding to the brand of the component whose signals are to be stored in the preset memory (refer to the tables of remote control codes on pages 24 to 27).

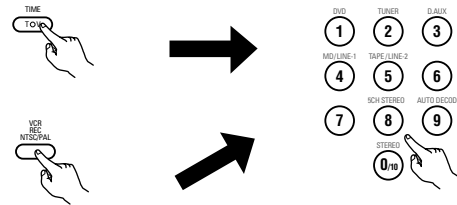

**NOTES:**

- When buttons are pressed while setting the preset memory, their signals are sent from the remote control transmitter, so cover the remote control sensor when setting the preset memory to prevent accidental operation.
- Depending on the model and year of make, some of the remote control codes for the brands included on the tables may not operate properly.
- For some brands there are multiple types of remote control codes. If an operation does not work, try changing to one of the other codes.

■ Not set upon shipment from the factory.

- 1** Set mode switch 1 to the "AV" position.
- 2** Set mode switch 2 to the "TV/VCR" position.
- 3** Press the power ON button and the OFF button simultaneously.

  - The transmission LED (indicator) flashes.

## Combinations of preset codes for different brands

TV	
Admiral	045, 121
Adventura	122
Aiko	054
Akai	016, 027, 046
Alleron	062
A-Mark	007
Amtron	061
Anam	006, 007, 036
Anam National	061, 147
AOC	003, 007, 033, 038, 039, 047, 048, 049, 133
Archer	007
Audiovox	007, 061
Bauer	155
Belcor	047
Bell & Howell	045, 118
Bradford	061
Brockwood	003, 047
Candle	003, 030, 031, 032, 038, 047, 049, 050, 122
Capehart	003
Celebrity	046
Circuit City	003
Citizen	029, 030, 031, 032, 034, 038, 047, 049, 050, 054, 061, 095, 122, 123
Concerto	031, 047, 049
Colortyme	003, 047, 049, 135
Contec	013, 051, 052, 061
Cony	051, 052, 061
Craig	004, 061
Crown	029
Curtis Mathes	029, 034, 038, 044, 047, 049, 053, 095, 118
Daewoo	027, 029, 039, 048, 049, 054, 055, 106, 107, 137
Daytron	003, 049
Dimensia	044
Dixi	007, 015, 027
Electroband	046
Electrohome	029, 056, 057, 058, 147
Elta	027
Emerson	029, 051, 059, 060, 061, 062, 118, 123, 124, 139, 148
Envision	038
Etron	027
Fisher	014, 021, 063, 064, 065, 118
Formenti	155
Fortress	012
Fujitsu	004, 062
Funai	004, 062
Futuretech	004
GE	020, 036, 037, 040, 044, 058, 066, 088, 119, 120, 125, 147
Goldstar	015, 029, 031, 039, 048, 051, 056, 057, 067, 068, 069, 116, 165
Grundy	062
Hitachi	029, 031, 051, 052, 070, 111, 112, 113, 124, 134
Hitachi Pay TV	151
Infinity	017, 071
Janeil	122
JBL	017, 071
JC Penny	020, 034, 039, 040, 041, 044, 048, 050, 058, 066, 069, 076, 088, 090, 095, 125, 136, 159
JCB	046
JVC	019, 051, 052, 072, 073, 091, 117, 126
Kawasho	018, 046
Kenwood	038, 056, 057
Kloss	010, 032
Kloss Novabeam	005, 122, 127, 131
KTV	074, 123
Loewe	071
Logik	144
Luxman	031
LXI	008, 014, 017, 024, 040, 044, 063, 071, 075, 076, 077, 118, 125
Magnavox	005, 010, 017, 030, 033, 038, 050, 056, 071, 078, 079, 085, 089, 108, 109, 110, 127, 131, 132, 145
Marantz	015, 017, 071, 080
Matsui	027
Memorex	014, 027, 045, 083, 118, 144
Metz	160, 161, 162, 163, 164
MGA	001, 039, 048, 056, 057, 058, 065, 081, 083
Midland	125
Minutz	066
Mitsubishi	001, 016, 039, 048, 056, 057, 058, 065, 081, 082, 083, 105
Montgomery Ward	011, 020, 144, 145, 146
Motorola	121, 147
MTC	031, 034, 039, 048, 095
NAD	008, 075, 076, 128
National	002, 036, 061, 147



National Quenties	002	Sharp	011, 012, 013, 026, 093, 099, 100, 104, 121
NEC	031, 038, 039, 048, 057, 084, 086, 135, 147	Siemens	013
Nikko	054	Signature	045, 144
NTC	054	Simpson	050
Optimus	128	Sony	043, 046, 138, 146, 150
Optonica	011, 012, 093, 121	Soundesign	030, 050, 062
Orion	004, 139	Spectricon	007, 033
Panasonic	002, 009, 017, 036, 037, 071, 141, 143, 147	Squareview	004
Philco	005, 010, 030, 050, 051, 056, 079, 085, 127, 131, 132, 145, 147	Supre-Macy	032, 122
Philips	005, 015, 017, 050, 051, 056, 078, 087, 088, 089, 131, 132, 147	Supreme	046
Pioneer	124, 128, 142	Sylvania	005, 010, 017, 030, 078, 079, 085, 089, 101, 127, 131, 132, 145, 155
Portland	054	Symphonic	004, 148
Price Club	095	Tandy	012, 121
Proscan	040, 044, 125	Tatung	036, 124
Proton	035, 051, 092, 129	Technics	037
Pulsar	042	Teknika	001, 030, 032, 034, 052, 054, 078, 083, 095, 144, 156, 157
Quasar	036, 037, 074, 141	Tera	035, 129
Radio Shack	011, 044, 063, 093, 118	Toshiba	008, 014, 034, 063, 075, 076, 095, 097, 136, 158, 159
RCA	040, 044, 125, 130, 137, 151, 152	Universal	020, 066, 088
Realistic	014, 063, 093, 118	Victor	019, 073, 126
Saisho	027	Video Concepts	016
Samsung	003, 015, 034, 053, 055, 057, 094, 095, 136, 153	Viking	032, 122
Sansui	139	Wards	005, 045, 066, 078, 085, 088, 089, 093, 102, 103, 131, 132, 148
Sanyo	013, 014, 021, 022, 063, 064, 081, 096	Zenith	042, 114, 115, 140, 144, 149
SBR	015	Zonda	007
Schneider	015		
Scott	062		
Sears	008, 014, 021, 022, 023, 024, 025, 040, 052, 057, 062, 063, 064, 065, 073, 075, 076, 097, 098, 125, 159		

<b>VCR</b>	
Admiral	081
Aiko	095
Aiwa	009
Akai	026, 027, 070, 072, 082, 083, 084
Alba	055
Amstrad	009
ASA	042
Asha	087
Audio Dynamic	005, 085
Audiovox	088
Beaumarck	087
Broksonic	086, 093
Calix	088
Candle	006, 087, 088, 089, 090
Canon	049, 057
Capehart	025, 055, 056, 071
Carver	015
CCE	095
Citizen	006, 007, 087, 088, 089, 090, 095
Craig	007, 087, 088, 091, 115
Curtis Mathes	006, 049, 073, 080, 087, 090, 092
Cybernex	087
Daewoo	025, 055, 059, 074, 089, 093, 095, 096
Daytron	025, 055
DBX	005, 085
Dumont	053
Dynatech	009
Electrohome	001, 088, 097
Electroponic	088
Emerson	001, 009, 017, 027, 086, 088, 089, 092, 093, 097, 100, 101, 102, 103, 104, 117
Fisher	009, 028, 031, 053, 054, 091, 098, 099, 115
GE	007, 011, 049, 050, 051, 052, 073, 080, 087
Go Video	047, 048
Goldstar	006, 012, 062, 088, 129
Gradiente	094
Grundig	042
Harley Davidson	094
Harman Kardon	040, 062
Hi-Q	091
Hitachi	009, 013, 023, 026, 058, 108, 109, 110, 111
JC Penny	004, 005, 007, 023, 028, 049, 062, 085, 087, 088
Jensen	013, 026
JVC	004, 005, 006, 026, 029, 043, 044, 045, 046, 085
Kenwood	004, 005, 006, 026, 029, 033, 045, 085, 090
Kodak	088
Lloyd	009, 094
LXI	088
Magnavox	015, 016, 042, 049, 063, 106
Magnin	087
Marantz	004, 005, 006, 015, 042, 049, 085, 090
Marta	088
MEI	049
Memorex	009, 033, 049, 053, 060, 081, 087, 088, 091, 094, 115
Metz	123, 124, 125, 126, 127, 128
MGA	001, 017, 027, 041, 097
MGN Technology	087
Midland	011
Minolta	013, 023
Mitsubishi	001, 003, 008, 013, 014, 017, 027, 029, 039, 040, 041, 045, 097
Motorola	081
Montgomery Ward	001, 002, 007, 009, 049, 063, 081, 115, 117
MTC	009, 087, 094
Multitech	007, 009, 011, 087, 090, 094
NAD	038
NEC	004, 005, 006, 018, 026, 029, 045, 061, 062, 085
Nikko	088
Noblex	087
Optimus	081, 088
Optonica	021
Panasonic	024, 049, 064, 066, 067, 068, 069, 107
Perdio	009
Pentax	006, 013, 023, 058, 090
Philco	015, 016, 049
Philips	015, 021, 042, 049, 105
Pilot	088
Pioneer	005, 013, 029, 036, 037, 038, 045, 085
Portland	025, 055, 090
Proscan	063, 080
Pulsar	060
Quartz	033
Quasar	034, 035, 049
Radio Shack	001, 002, 021, 081, 087, 088, 091, 094, 097, 098, 115
Radix	088

Randex	088	Symphonic	009, 094
RCA	007, 013, 019, 023, 058, 063, 064, 065, 073, 080, 082, 087	Tandy	009
Realistic	009, 021, 031, 033, 049, 053, 081, 087, 088, 091, 094, 097, 098	Tashiko	009, 088
Ricoh	055	Tatung	004, 026, 030
Salora	033, 041	Teac	004, 009, 026, 094
Samsung	007, 011, 051, 059, 070, 083, 087, 089, 113	Technics	024, 049
Sanky	081	Teknika	009, 010, 022, 049, 088, 094
Sansui	005, 026, 029, 045, 061, 085, 114	TMK	087, 092
Sanyo	032, 033, 053, 087, 091, 115, 116	Toshiba	013, 017, 020, 041, 059, 089, 098, 099, 117
SBR	042	Totevision	007, 087, 088
Scott	017, 020, 086, 089, 093, 117	Unirech	087
Sears	013, 023, 028, 031, 033, 053, 054, 088, 091, 098, 099, 115	Vecrtor Research	005, 062, 085, 089, 090
Sentra	055	Victor	005, 045, 046, 085
Sharp	001, 002, 021, 097	Video Concepts	005, 027, 085, 089, 090
Shogun	087	Videosonic	007, 087
Sony	075, 076, 077, 078, 079, 121, 122	Wards	013, 021, 023, 087, 088, 089, 091, 094, 097, 118, 119, 120
STS	023	XR-1000	094
Sylvania	009, 015, 016, 017, 041, 049, 094	Yamaha	004, 005, 006, 026, 062, 085
		Zenith	060, 078, 079

**(5) Operating the TV/video deck after storing its remote control signals in the preset memory**

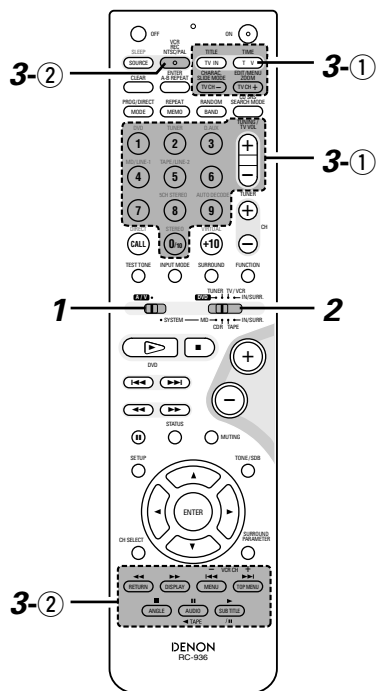

**3** Monitor TV (TV) and video deck (VCR) system buttons

① TV system buttons

- TV : Power on/off
- 0~9 : Channel numbers
- TV IN : TV input switching
- TV VOL +, - : Volume up/down
- TV CH +, - : Channel switching

② Video deck system buttons

- VCR : Power on/off
- VCR CH +, - : Channel switching
- ◀▶ : Manual search (fast-forward and fast-backward)
- ▶ : Play
- ⏸ : Pause
- : Stop

**1** Set mode switch 1 to the "A/V" position.

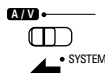

**2** Set mode switch 2 to the "TV/VCR" position.



**3** Operate the video component.  
 • For details, refer to the component's operating instructions.  
 ※ It may not be possible to operate some models.

**NOTE:**

- The TV's "TV (POWER)" and "TV IN" buttons can be operated as long as mode switch 1 is set to the "A/V" position, regardless of the position of mode switch 2.

# 10 SETTING UP THE SYSTEM

## (1) System setup items

- Once all connections with other AV components have been completed as described in "CONNECTIONS" (see pages 8 to 15), make the various settings described below on the monitor screen using the ADV-M71's on-screen display function.
- Use the following buttons to set up the system:

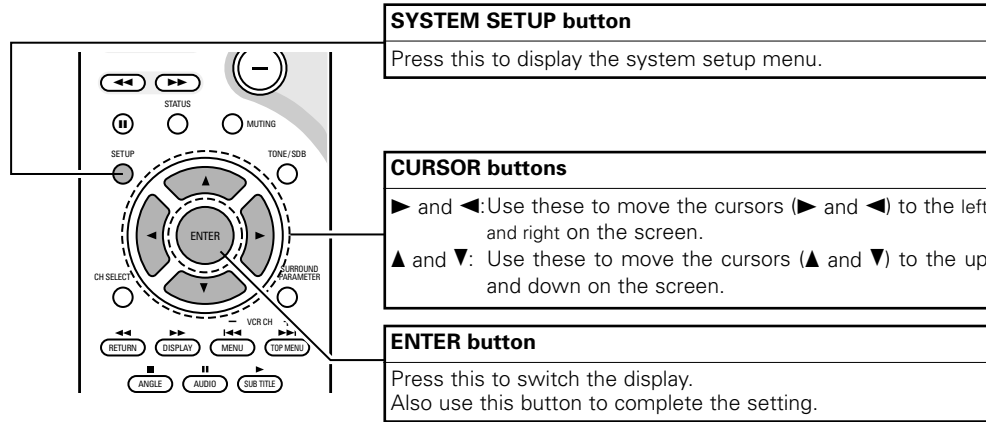

### System setup items and default values (set upon shipment from the factory)

Setup		Default settings				
Quick set up	Set the screen size and the speaker system.	TV Aspect		Speaker		
		4:3 PS		2CH Virtual & SW		
System Setup	Speaker Configuration	Front Sp.	Center Sp.	Surround Sp.	Sub Woofer	
		Small	" _ "	" _ "	Yes	
	Sw Freq. = 150 Hz / SW mode = None					
	Delay Time	Front & Subwoofer		Center	Surround	
		9ft (2.7m)		" _ "	" _ "	
Channel Level	Front L	Center	Front R	Surround R	Surround L	Sub Woofer
	0 dB	" _ "	0 dB	" _ "	" _ "	0 dB
DVD auto power off setting	The power automatically switches to standby if no operation is performed for 30 minutes while in the stop mode with the function set to DVD.	power does not turn off automatically				
Function Setting	Set the LINE-1 and LINE-2 function names and turn the analog recording output (REC OUT) on or off.	LINE-1	LINE-2	REC OUT		
		MD	TAPE	ON		
DVD Setup	Disc Setup	Dialog	Subtitle	Disc Menu		
		English	OFF	English		
	OSD Setup	Wall Paper				
		Blue				
	Video Setup	TV Aspect	TV Type	Video Mode	Black level	
		4 : 3 PS	NTSC	AUTO	LIGHTER	
	Audio Setup	Digital Out		LPCM Select		
Normal		OFF				
Ratings	Rating Level		Pass Word Change			
	No Limit		0000 (Default)			
Other Setup	Closed Caption		Slide Show			
	OFF		5SEC			

## (2) Quick setup procedure

- Refer to "Connections" (pages 8 to 15) and check that all the connections are correct.

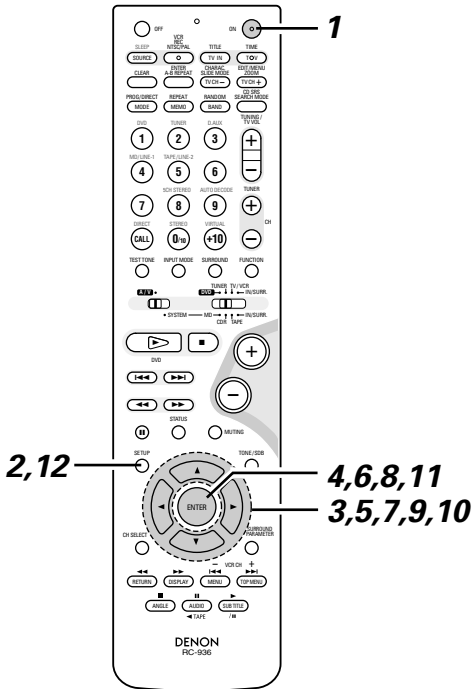
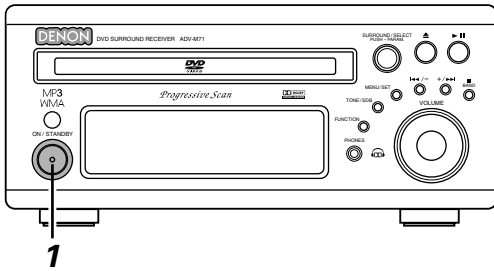

- 1 Turn on the power.
  - The power indicator (LED) lights green, the power turns on and the display lights.



Main unit



Remote control unit

- ※ Several seconds are required from the time the power button is pressed until the power turns on. This is due to the built-in muting circuit that turns off (mutes) the sound when the power is turned on and off. The power indicator flashes green while the muting circuit is activated.
- ※ Even when the power button has been pressed again and the power has been set to the standby mode, power is still supplied to some circuits. When leaving home or traveling, be sure to unplug the power cord from the power outlet. In the standby mode, the power indicator is lit red. The indicator is orange when the timer is set.

- 2 Press the SETUP button to display the setup screen.



Remote control unit

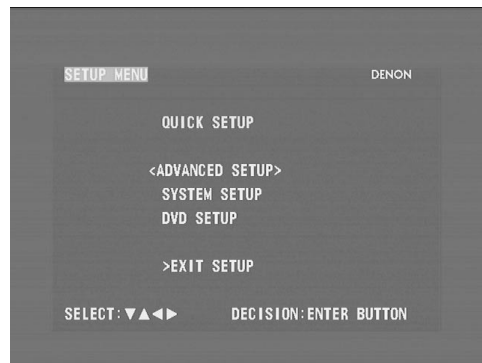

- 3 Use the ▲ and ▼ cursor buttons to select "Quick System Setup".
  - The selected item is displayed in yellow.



Remote control unit

- 4** Press the ENTER button to display the menu's setting screen.  
 ※ On the setting screen, the selected item is displayed in yellow and the values of the other items are displayed in green.



Remote control unit

**[1] TV screen size setting**

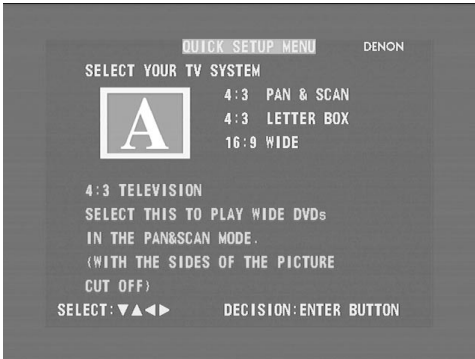

- The currently set value is displayed in yellow.

- 5** Use the ▲ and ▼ cursor buttons to select the desired TV screen size and display type.  
 ※ The selected TV screen size is displayed in yellow and the description is displayed in green.



Remote control unit

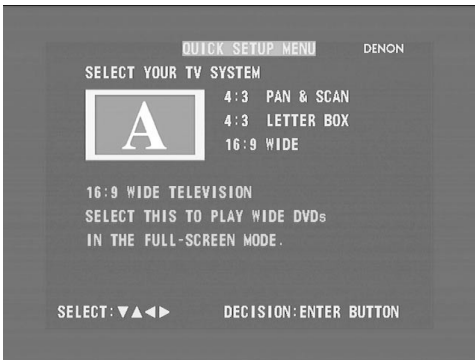

- 6** Press the ENTER button to set the selected setting.  
 • The screen shown below appears.



Remote control unit

**6 [2] Speaker system settings**



- "Return" is displayed in yellow.
- The currently set value is displayed in green.
- If you do not want to change the setting, press the ENTER button at "Return". The screen in step 2 reappears.
- To change the setting, proceed to step 7 below.

- 7** Use the ▲ and ▼ cursor buttons to select the speaker system to be used.



Remote control unit

- 8** Press the ENTER button to set the selected setting.  
 • For settings other than "5.1-channel surround", the setup screen in step 2 reappears.  
 →The setup mode is quit in step 12.  
 ※ The setup mode can also be quit by using the ▲ and ▼ cursor buttons at the setup screen to select "EXIT SETUP" then pressing the ENTER button.  
 • If "5.1-channel surround" is selected, the screen shown below appears.



Remote control unit

**[3] Room and listening position settings**

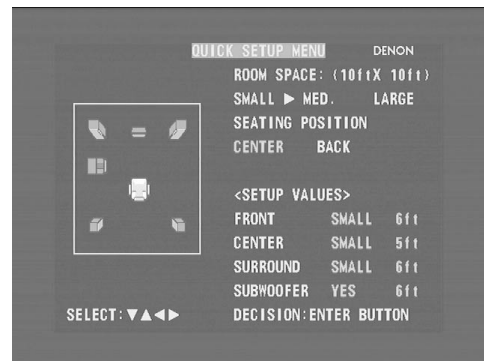

- The currently set value is displayed in green.

- 9** Use the ▲ and ▼ cursor buttons to select “Room Settings”, then use the ◀ and ▶ cursor buttons to set the size of the room.
- The set size is displayed in yellow.

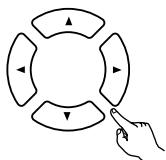

Remote control unit

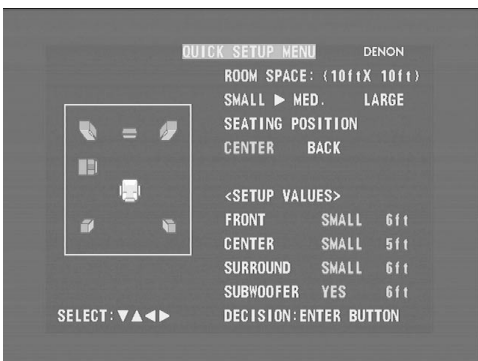

- 10** Use the ▲ and ▼ cursor buttons to select “Listening Position”, then use the ◀ and ▶ cursor buttons to set the position.
- The set position is displayed in yellow.

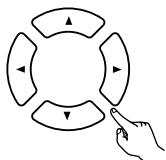

Remote control unit

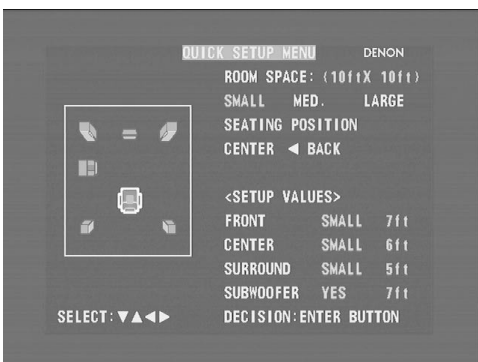

- 11** Press the ENTER button to end the settings.
- The screen in step 2 reappears.



Remote control unit

- 12** Press the SETUP button to quit the setup mode.
- ※ The setup mode can also be quit by using use the ▲ and ▼ cursor buttons at the setup screen to select “EXIT SETUP” then pressing the ENTER button.



Remote control unit

**About the speaker system settings**

- ◎ **2CH VIRTUAL**  
Select this when only using with the two speakers for the front channels.
- ◎ **2CH VIRTUAL & SW**  
Select this when using two speakers for the front channels and a subwoofer with built-in amplifier.
  - Settings
 

Front	:	Small
Subwoofer	:	Yes
Subwoofer frequency	:	150 Hz

 ※ Set the front speakers and subwoofer at equal distances.
- ◎ **5.1CH SURROUND**  
Select this when using two speakers for the front channels, a center speaker, two speakers for the surround channels and a subwoofer with built-in amplifier.
  - Settings
 

Front	:	Small	9ft (2.7m)
Center	:	Small	8ft (2.4m)
Surround	:	Small	7ft (2.1m)
Subwoofer	:	Yes	9ft (2.7m)
Subwoofer frequency	:	150 Hz	

 ※ The room setting is set to “MED.”, the listening position to “BACK”.

**NOTE:**

- The speaker system is set to “2CH VIRTUAL & SW” upon shipment from the factory. It is not possible to achieve the normal bass sound using this setting but with only speakers for the two front channels. If only using speakers for the two front channels, change the setting to “2CH VIRTUAL”.



### (3) Detailed system setup (changing the system settings)

- The quick system settings and original settings set upon shipment from the factory are changed using the system setting changing menu. The settings are stored in the memory until they are changed the next time, and remain valid even when the power is turned off.

#### [1] Speaker settings (type of speaker and whether or not the speaker is connected)

- The output component of the different channels and properties are adjusted automatically according to the combination of speakers actually used.

**1** Press the SETUP button to display the setup screen.



Remote control unit



**3**

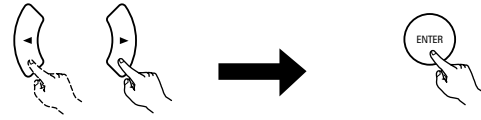

Remote control unit

Remote control unit

- When the cursor is at a tag icon on the system setting changing menu screen, the settings screen can also be selected by pressing the ▼ cursor button. You can return to the tag icon by pressing the ▲ cursor button.

- The speaker settings screen in step 4 appears.

**2** Use the ▲ and ▼ cursor buttons to select "SYSTEM SETUP" under "<ADVANCED SETUP>", then press the ENTER button.

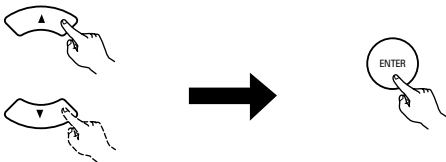

Remote control unit

Remote control unit

**4** Use the ▲, ▼, ◀ and ▶ cursor buttons to select whether or not the various speakers are connected, their size and other parameters.

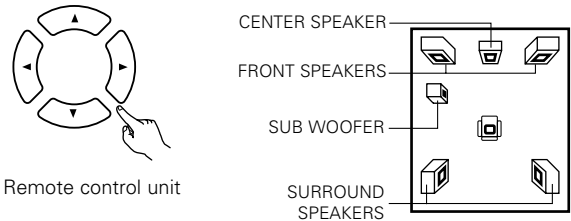

Remote control unit

- The item currently being set is displayed in yellow, and the setting values for other items are displayed in green.

**3** At the system setting changing menu, use the ◀ and ▶ cursor buttons to select the "SPEAKER CONFIGURATION" tag icon, then press the ENTER button.

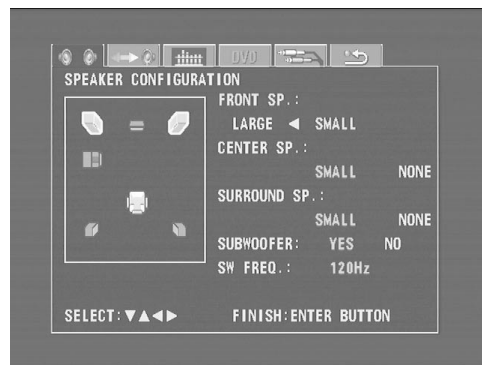
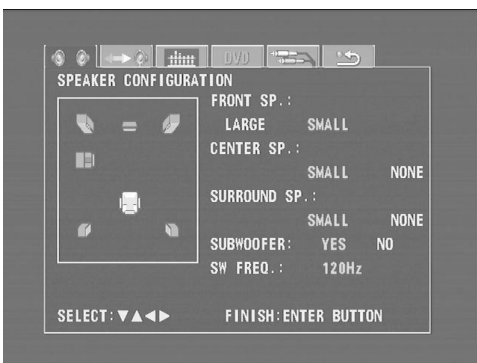

**5** Press the ENTER button to enter the settings.

- The next screen in the system setting changing menu appears.



Remote control unit

**NOTE:**

- Select the speaker size not by the physical size of the speaker but by the speaker's capacity to reproduce low frequencies of 100 Hz or less. If you do not know, determine the best setting by comparing the sound when the setting is set to "Small" and "Large", keeping the volume low enough to prevent damage to the speaker.

**NOTE:**

- Select "Large" or "Small" not according to the actual size of the speaker but according to the speaker's capacity for playing low frequency (approximately 100 Hz and below) signals. If you do not know, try comparing the sound at both settings (setting the volume to a level low enough so as not to damage the speakers) to determine the proper setting.

**Parameters**

Large..... Select this when using speakers that can fully reproduce low sounds of below 100 Hz.

Small..... Select this when using speakers that do not provide sufficient volume for playing low frequencies of 100 Hz and less. When this setting is made, frequencies below the frequency set at the subwoofer frequency setting are assigned to the subwoofer.

None..... Select this when no speakers are installed.

Yes/No.... Select "Yes" when a subwoofer is installed, "No" when a subwoofer is not installed.

※ If the subwoofer has sufficient low frequency playback capacity, good sound can be achieved even when "Small" is set for the front, center and surround speakers.

※ For the majority of speaker system configurations, using the SMALL setting for all five main speakers and Subwoofer On with a connected subwoofer will yield the best results.

**Subwoofer (SW FREQ.) frequency**

- For the subwoofer frequency at the speaker setting screen, set the bass crossover frequency for playback from the subwoofer.
- Select "80 Hz", "120 Hz", "150 Hz" or "180 Hz" (-6 dB for each). Bass sound below these frequencies is played from the subwoofer.  
(This is set to "150 Hz" by factory default.)

**Assignment of low frequencies**

- In the Dolby Digital, Dolby Pro Logic II, DTS, and virtual surround modes, the low frequency signals for channels whose speaker settings are set to "Small" are assigned to the subwoofer. The low frequencies of channels set to "Large" are played from those channels.  
(If set to "120 Hz", channels set to "Small" play sounds of 120 Hz and greater, while bass frequencies of under 120 Hz are played from the subwoofer.)
- In surround modes other than the ones listed above, low frequencies below the frequency set at the subwoofer frequency setting are played from the subwoofer regardless of whether the speakers are set to "Large" or "Small".
- Set the subwoofer frequency according to the low frequency playback abilities of your speakers and subwoofer.

**Subwoofer mode**

- The subwoofer mode setting is only valid when "LARGE" is set for the front speakers and "YES" is set for the subwoofer in the "SPEAKER CONFIGURATION" settings.
- When the "LFE+MAIN" playback mode is selected, the low frequency signal range of channels set to "LARGE" are produced simultaneously from those channels and the subwoofer channel. In this playback mode, the low frequency range expand more uniformly through the room, but depending on the size and shape of the room, interference may result in a decrease of the actual volume of the low frequency range.
- Selection of the "LFE" play mode will play the low frequency signal range of the channel selected with "LARGE" from that channel only. Therefore, the low frequency signal range that are played from the subwoofer channel are only the low frequency signal range of LFE (only during Dolby Digital or DTS signal playback) and the channel specified as "SMALL" in the setup menu.
- Select the play mode that provides bass reproduction with body.
- When the subwoofer is set to "YES", bass sound is output from the subwoofer regardless of the subwoofer mode setting in surround modes other than Dolby/DTS.

**[2] Delay time (distance setting)**

- Input the distances from the listening position and the various speakers to set the surround delay time.
- Upon shipment from the factory default the delay time is set to the default values in step 3 below.

**Preparation:**

Measure the distance from the listening position to the various speakers.

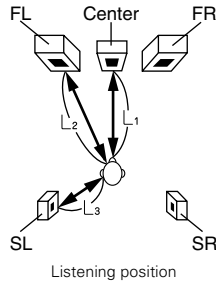

- L1: Distance between center speaker and listening position
- L2: Distance between front speakers and listening position
- L3: Distance between surround speakers and listening position

**1** If you are not at the system setting changing menu screen, read step 1 and 2 on page 33.

**2** At the system setting changing menu screen, use the ◀ and ▶ cursor buttons to select "DELAY TIME (Distance)", then press the ENTER button.

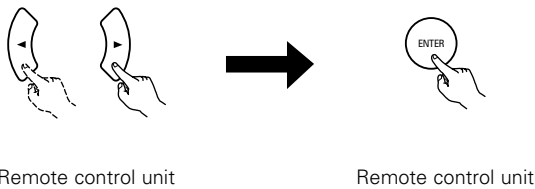

- The delay time setting screen appears.

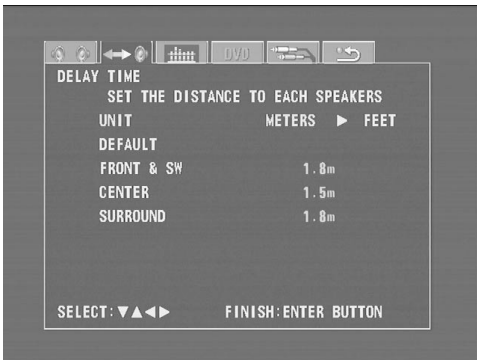

- The unit for the distance can be switched between "m" (meters) and "ft" (feet) using the ◀ and ▶ cursor buttons. If you do not want to change the unit, press the ▼ cursor button to proceed to the next step.

**3** At "Default Value", select "Yes" to set the delay times for the different speakers to the default values.

- Yes: The values are set to the defaults.
- No: The current settings are retained.

**4** Use the ▲ and ▼ cursor buttons to select the speaker, then use the ◀ and ▶ cursor buttons to set the distance between the speaker and the listening position.

- The distance changes by 0.1 meters (or 1 foot when the unit is set to feet) each time the ◀ and ▶ cursor button is pressed. Select the value closest to the measured distance.

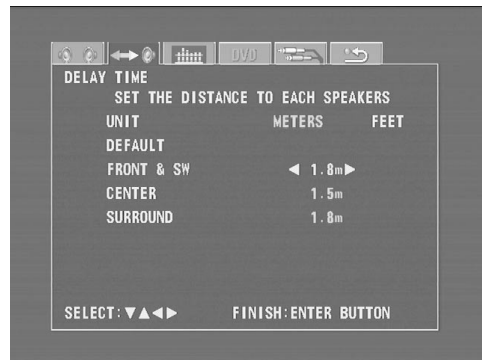

※ Make sure the difference in the distances set for the various speakers is no greater than 3.0 meters (10 feet). If an inappropriate distance is set, "CAUTION: OUT OF SETTING RANGE" is displayed. Change the position of the speaker and make the setting over.

**5** Press the ENTER button to enter the settings.

- The next screen in the system setting changing menu appears.



Remote control unit

**[3] Adjusting the channel level**

- Adjust so that the playback levels of the different channels are equal.
- Make this adjustment by listening to the test tones output from the speakers at the listening position.
- By factory default all the levels of all the channels are set to 0 dB.
- This adjustment can also be made directly from the remote control unit. (CH SELECT Button)

**1** If you are not at the system setting changing menu screen, read step 1 and 2 on page 33.

**2** At the system setting changing menu screen, use the ◀ and ▶ cursor buttons to select "Channel Level Adjustment", then press the ENTER button.

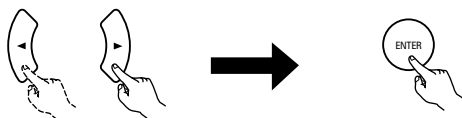

Remote control unit                      Remote control unit

- The channel level adjustment screen appears.

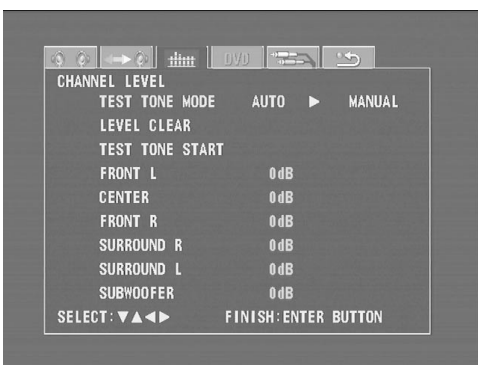

**3** Use the ◀ and ▶ cursor buttons to select "Auto" or "Manual" for the "Test Tone" mode.

- The selected setting is displayed in yellow.

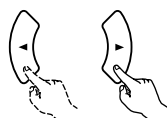

Remote control unit

- ◎ Auto: Adjust the levels listening to test tones automatically output from the different speakers.
- ◎ Manual: Select the speakers from which the test tones are output when adjusting the levels.
- ※ Detailed settings can be made when this is set to "Manual" first.

**4** When "Yes" is selected at "Level Clear", the level settings for all the speakers are set to 0 dB.

- ◎ Yes: The level settings for all the speakers are set to 0 dB.
- ◎ No: The currently set level settings are retained.

**5 Adjust the channel levels in the test tone mode.**

Use the ▲ and ▼ cursor buttons to select the "Test Tone Start" mode, then use the ◀ cursor button to select "Yes". The test tone is output.

- ※ Use the MASTER VOLUME control on the main unit or the VOLUME buttons on the remote control unit to adjust the volume of the test tone to a level at which it is easy to make this adjustment.

**6** ① When "Auto" is selected at "Test Tone":

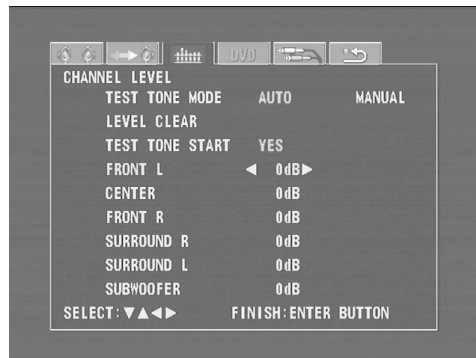

- Test tones are automatically output from the speakers at intervals of 4 seconds for two of the cycles shown below, then at intervals of 2 seconds from the third cycle on.

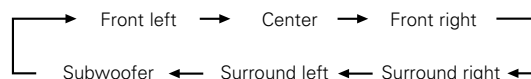

Use the ◀ and ▶ cursor buttons to adjust the channel levels so that the volume of the test tones output from the different speakers sounds the same.

- The level changes in units of 1 dB each time the ◀ and ▶ cursor button is pressed. The level can be adjusted in the range -12 dB to +12 dB.

② When "Manual" is selected at "Test Tone":



Use the ▲ and ▼ cursor buttons to select the speaker from which the test tone is to be output, then use the ◀ and ▶ cursor buttons to adjust the channel levels so that the volume of the test tones output from the different speakers sounds the same.

- The level changes in units of 1 dB each time the ◀ and ▶ cursor button is pressed. The level can be adjusted in the range -12 dB to +12 dB.

- 7** Press the ENTER button to enter the settings.
- The next screen in the system setting changing menu appears.
- 
- Remote control unit

- 4** Press the ENTER button to enter the settings.
- The next screen in the system setting changing menu appears.
- 
- Remote control unit

※ To cancel the settings after the adjustments have been made  
 Display the channel level adjustment screen, then use the ▲, ▼, ◀ and ▶ cursor buttons to select "Level Clear" and select "Yes".  
 The level settings for all the speakers are set to 0 dB.

**NOTE:**

When the channel levels are adjusted at the channel level settings, the adjusted values are applied to all playback modes.

**[4] DVD Auto Power Off setting**

- The ADV-M71 is equipped with a function for automatically setting the power to the standby mode if no operation is performed for 30 minutes when the function is set to DVD. Here set whether to use this function or not.
- By factory default this is set to "No".

- 1** If you are not at the system setting changing menu screen, read step 1 and 2 on page 33.

- 2** At the system setting changing menu screen, use the ◀ and ▶ cursor buttons to select "DVD AUTO POWER OFF", then press the ENTER button.

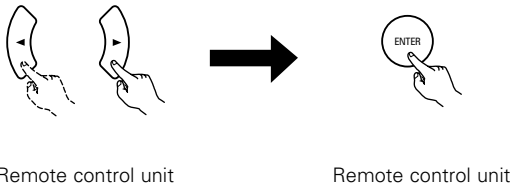

Remote control unit                      Remote control unit

- The DVD auto power off setting screen appears.



- 3** Use the ◀ and ▶ cursor buttons to select the "Auto Power Off" mode.

- Yes: The function for automatically turning the power off when the function is set to DVD is activated.
- No: The auto power off function is not activated.

**[5] Function settings**

- Set the LINE-1 and LINE-2 function names and turn the analog recording output (REC OUT) on or off.
- When used in combination with the D-M31 series, set according to the components being used and make system connections for convenient system functions.
- It is also possible to assign the D.AUX digital input to LINE-2.

- 1** If you are not at the system setting changing menu screen, read step 1 and 2 on page 33.

- 2** At the system setting changing menu screen, use the ◀ and ▶ cursor buttons to select "FUNCTION ASSIGNMENT", then press the ENTER button.

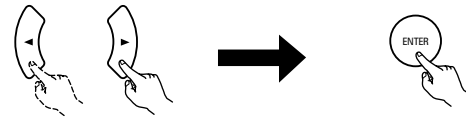

Remote control unit                      Remote control unit

- The input function setting screen appears.



- 3** Use the ▲ and ▼ cursor buttons to select the item to be set, then use the ◀ and ▶ cursor buttons to make the settings.

- LINE-1 Function name selection ("MD" by default)

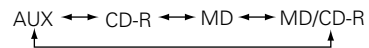

- LINE-2 Function name selection ("TAPE" by default)



- LINE-1/LINE-2 REC OUT

- Set whether to turn the recording output during playback in the Dolby Virtual Speaker mode when the function set to DVD or the D.AUX exclusive digital input on or off.
- On: The signals are output in stereo. (Factory default)
- Off: The signals are not output. (Recording is not possible.)

- 4** Press the ENTER button to enter the settings.
- The next screen in the system setting changing menu appears.



Remote control unit

**Input function settings**

- LINE-1 and LINE-2 can be set as described below.
  - LINE-1 : "MD", "CD-R", "MD/CD-R" or "AUX" can be selected. ("MD/CD-R" can only be set when a system MD recorder, cassette deck and CD recorder are all connected and system operations are being used.)
  - LINE-2 : This can be set to "TAPE", "MD", "AUX" or "D.AUX". (Set "D.AUX" to use the D.AUX digital input in combination with the LINE-2 analog input.)
- The setting for LINE-1 has priority. Once a function is set for LINE-1, it is not possible to set the same function for LINE-2. (For example, if "MD" is selected for LINE-1, "MD" is no longer offered as one of the choices for LINE-2.)

**LINE-1/LINE-2 analog recording output setting**

- Normally set this to "On".
- With the DVD or D.AUX exclusive digital input function, set this to "Off" if noise is generated when playing sources with high bit rates in the Dolby Virtual Speaker mode.
- This setting is only valid in the Dolby Virtual Speaker mode for the DVD or D.AUX exclusive digital input function. (In surround modes other than the Dolby Virtual Speaker mode and with other input functions, analog recording signals are output, regardless of this setting.)
- Analog recording is not possible when this is set to "Off". To record, use a mode other than the Dolby Virtual Speaker mode (stereo, for example).

**(4) After changing the system settings**

- This completes the procedure for changing the system settings. Once the speaker settings, delay times and channel levels have been set, there is no need to change the settings again unless the connected AV components or speakers are changed or the speakers are moved to different positions.
- DVD auto power off and function settings as necessary.

- 1** At the system setting changing menu screen, press the SETUP button.
- The new settings are entered and the on-screen display turns off.



Remote control unit

※ The setup procedure can be quit at any point by pressing this button.

**NOTE:**

- When system settings have been changed with the system setting changing menu and a speaker system is selected with the quick system settings, the speaker settings and delay time settings are changed to the values preset for the quick system settings.

**11 PLAY BACK**

**(1) Before Operating**

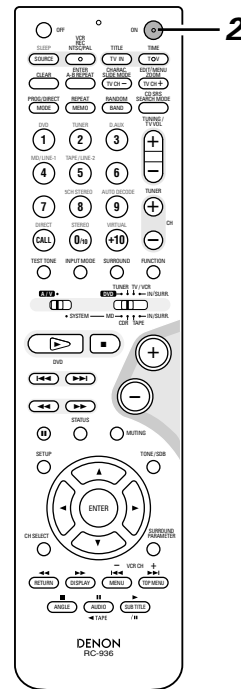
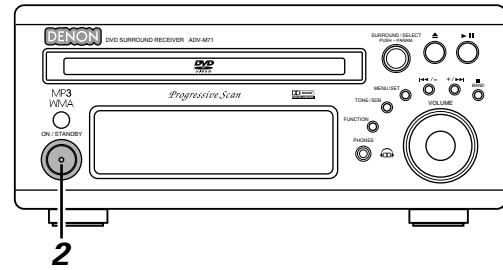

- 1** Refer to "CONNECTIONS" (pages 8 to 15) and check that all connections are correct.

- 2** Turn on the power. Press the POWER button.

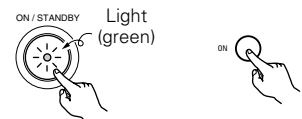

Main unit

Remote control unit

When pressed, the power turns on and the display lights. The sound is muted for several seconds, after which the unit operates normally. When pressed again, the power turns off, the standby mode is set and the display turns off. Whenever the ON/STANDBY button is in the STANDBY state, the apparatus is still connected on AC line voltage. Please be sure to unplug the cord when you leave home for, say, a vacation.

**(2) Loading Disc**

■ Set discs in the disc tray with the labeled (printed) side facing up.

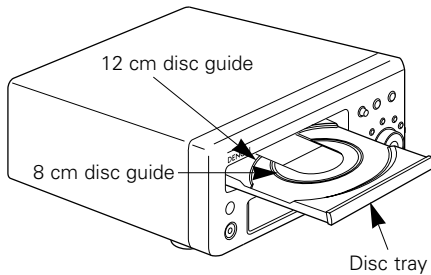

**NOTE:**

- Do not move the this unit while a disc is playing. Doing so may scratch the disc.

**(1) Opening and Closing the Disc Tray**

- ① Turn on the power.
- ② Press the OPEN/CLOSE button.

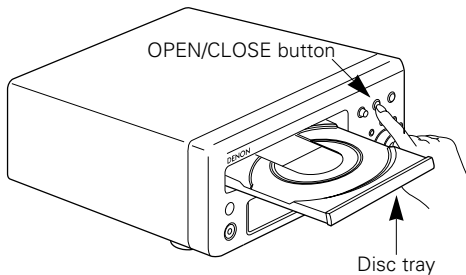

**NOTES:**

- Even when the power is in the standby mode, when the OPEN/CLOSE button is pressed, the ADV-M71's power turns on and the disc tray operates. (Auto power on function)
- Even if the function is set to something other than DVD, when the OPEN/CLOSE button is pressed, the function switches to DVD and the disc tray operates. (Auto function select function)
- Do not strike on the button with a pencil, etc.

**(2) Loading Discs**

- Pick up the disc carefully so as not to touch the signal surface and hold it with the labeled side facing up.
- With the disc tray fully open, set the disc in the disc tray.
- Set 12 cm discs in the outer tray guide (Figure 1), 8 cm discs in the inner tray guide (Figure 2).
- Press the OPEN/CLOSE button. The disc is automatically loaded.
- The disc tray can also be closed automatically to load the disc by pressing the PLAY button.

**Figure 1**

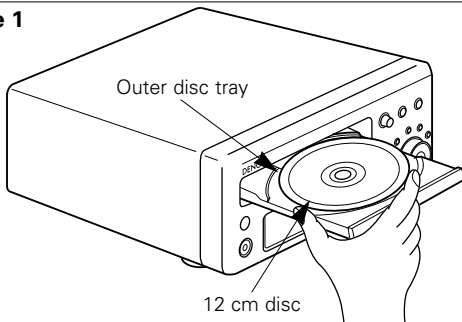

**Figure 2**

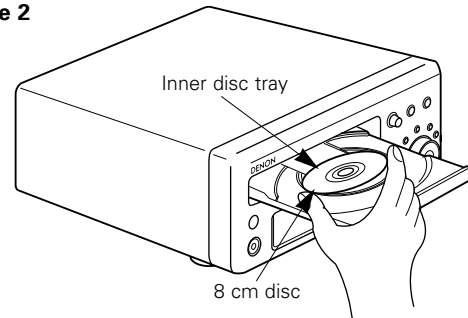

**NOTES:**

- If a foreign object is caught in the disc tray during closing, simply press the OPEN/CLOSE button again and the tray will open.
- Do not press the disc tray in by hand when the power is off. Doing so will damage it.
- Do not place foreign objects in the disc tray. Doing so will damage it.

**(3) Selecting the video output**

- Factory default: interlace, 525i.
- When a TV compatible with progressive 525p inputs is connected, the setting can be switched using the operation described below.

**1**

With the function set to "DVD", press the MENU/SET button for at least 2 seconds.

- The current setting ("INTERLACED" or "PROGRESSIVE") is displayed after "VIDEO OUT".

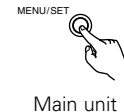

Main unit

**2**

Turn the surround/select control while the setting is displayed to switch it.

- The setting switches alternately between "INTERLACED" and "PROGRESSIVE".
- The normal display reappears if no operation is performed for several seconds.



Main unit

**NOTE:**

- When "PROGRESSIVE" is set, no video signals are output from the VIDEO OUT or S-VIDEO OUT terminals. Set "INTERLACED" if you want to use the VIDEO OUT or S-VIDEO OUT signals.

**(3) Playback**

**IMPORTANT SETUP INFORMATION**

**This set has the following presettings:**

“DISC SETUP”, “OSD SETUP”, “VIDEO SETUP”, “AUDIO SETUP”, “RATINGS”, and “OTHER SETUP”.

These presettings have been preset upon shipment from the factory. If you wish to change them to suit your specific purposes, refer to pages 91 to 103.

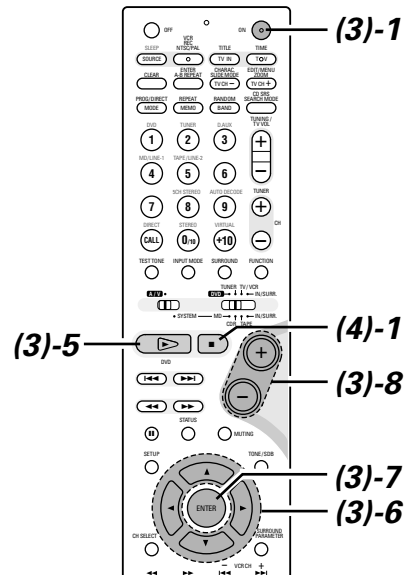
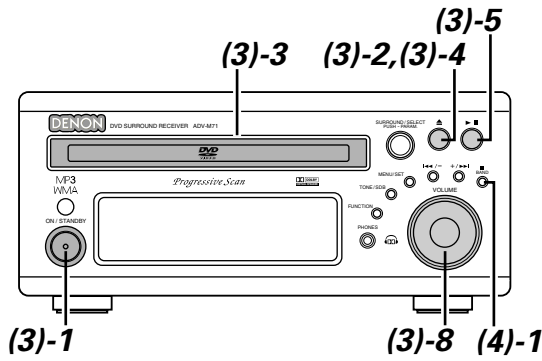

- 1** Turn on the power.
  - Press the power button, the power indicator lights and the power turns on.



Main unit



Remote control unit

- 2** Press the OPEN/CLOSE button to open the disc tray.



Main unit

- 3** Set the disc in the disc tray.

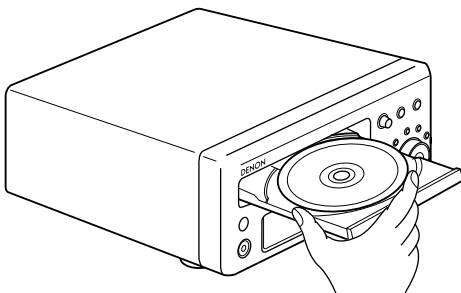

- 4** Press the OPEN/CLOSE button.

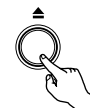

Main unit

- 5** Press the PLAY button.
  - For many interactive DVDs and video CDs with playback control, a menu screen appears. In this case use the procedure in step 6 to select the desired item.



Main unit



Remote control unit

Example: For DVDs with menu screens

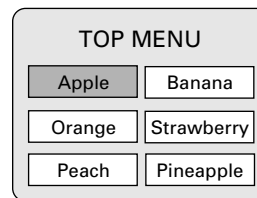

Example: For video CDs with playback control

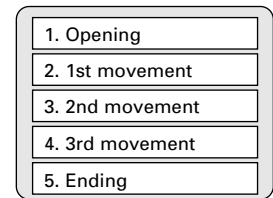



- 6** Use the cursor buttons (▲, ▼, ◀ and ▶) to select the desired item.
- For some discs there is a second menu screen. If so, press the ►► button to display the next menu screen. (See the disc's jacket.)
- ※ The cursor buttons (▲, ▼, ◀ and ▶) do not work for video CDs. Use the number buttons to select the desired item.

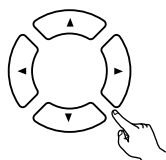

Remote control unit

- 7** Press the ENTER button.
- The desired item is selected and playback starts.
  - You can return to the menu screen by pressing the TOP MENU button while the DVD is playing, though this depends on the disc.
  - Press the RETURN button during playback of a video CD to return to the menu screen.



Remote control unit

Example: When "Apple" is selected

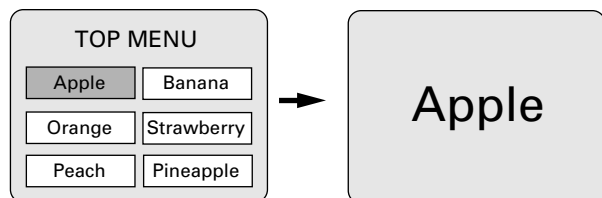

- 8** Either turn the main unit's main volume control or use the main volume control buttons on the remote control unit to adjust the volume.

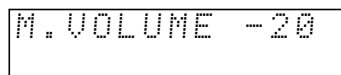

The volume is shown on the display.

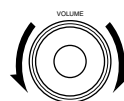

Main unit

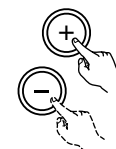

Remote control unit

- ※ For detailed instructions on operations for the surround modes and surround parameters, see "12 Operating the Surround Functions" on pages 43 to 61.
- In the "AUTO" input mode, the signals of the disc being played are identified, Dolby Digital, DTS or PCM decoding is selected automatically and the disc is played.
  - In the Dolby Virtual Speaker surround mode, the signals of the disc being played are automatically decoded in Dolby Digital or DTS then played in the Dolby Virtual Speaker surround mode.
  - In the "AUTO DECODE" surround mode when a 5.1-channel speaker system is set, the signals of the disc being played are identified and automatically decoded in Dolby Digital, DTS or Auto Stereo and the disc is played.

**NOTES:**

- If appears on the TV screen while buttons are being operated, that operation is not possible on the ADV-M71 or with that disc.
- Set the disc in the disc guide.
- Only set one disc in the tray.
- The disc keeps turning while the menu screen is displayed on the TV screen.

**(4) Stopping Playback**

- 1** During playback, press the STOP button on the main unit or the remote control unit, playback stops and wall paper is displayed.
- <Resume play memory function (DVD only)>
- With the ADV-M71, when the STOP button is pressed, that position is stored in the memory. At this time, "▶" flashes on the display. When the PLAY button is pressed after pressing the STOP button, playback resumes from the position at which it was stopped. The resume play memory function is canceled if the disc tray is opened or the STOP button is pressed a second time.

**About the DVD standby function**

When the ADV-M71's function is set to DVD, the DVD standby mode is set automatically if the disc remains in the stop mode for approximately 10 minutes.

- In the DVD standby mode, the DVD section's power is off and output of the video signals is also off. The ADV-M71's display reads "DVD standby" at this time.
- When in the DVD standby mode, the power of the sections other than the DVD section is on and function switching and other operations can be performed on the main unit and remote control unit. When a DVD control button (the play/pause and button open/close buttons on the main unit, the play button on the remote control unit, etc.) is operated, the DVD section's power turns on automatically and disc playback and opening/closing of the disc holder can be performed.



Main unit



Remote control unit

- ※ The resume play memory function only works for discs for which the elapsed time is shown on the display during playback.

**Auto power off function.**

- The ADV-M71 is equipped with a function that automatically switches the power to standby if no operation is performed for 30 minutes while in the stop mode with the function set to DVD.
- This function is set to off upon shipment from the factory. If you wish to turn it on, set the "DVD AUTO POWER OFF" setting to "YES" as described on page 37.

**NOTE:**

- The DVD standby function only turns off the power of the DVD section. It is different from the DVD auto power off function set with the system settings in Setup in that the DVD section remains functional.

### (5) Playing Still Pictures (Pausing)

- 1 During playback, press the **⏸** button on the main unit or the **⏸** button on the remote control unit.
  - Press the **▶** button to resume normal playback.

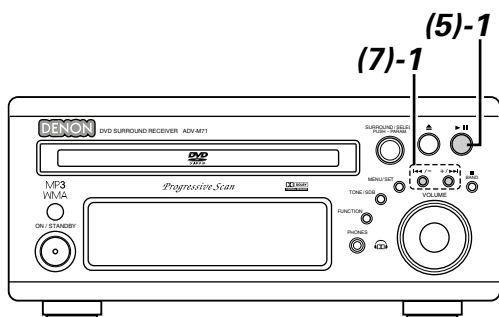

Main unit



Remote control unit

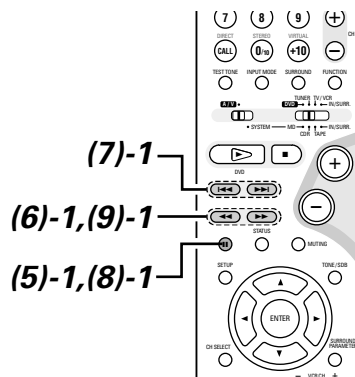

### (6) Forward / Reverse Searching

- 1 During playback, press one of the **◀◀** / **▶▶** buttons on the remote control unit.
  - ◀◀** : Reverse direction
  - ▶▶** : Forward direction
  - When pressed again, the search speed increases (DVD, VIDEO CD in seven steps, CD in four steps).
  - Press the **▶** button to resume normal playback.



Remote control unit

**NOTE:**

- In some cases the menu screen may reappear when one of the **◀◀** / **▶▶** buttons is pressed during menu playback on a video CD.

### (7) Skipping to the Beginning of Chapters or Tracks

- 1 During playback, press one of the skip buttons on the main unit or the remote control unit.
  - ◀◀** / **◀** : Reverse direction (PREVIOUS)
  - ▶** / **▶▶** : Forward direction (NEXT)
  - A number of chapters or tracks equal to the number of times the button is pressed is skipped.
  - When the skip back button is pressed once, the pickup returns to the beginning of the currently playing chapter or track.



Main unit



Remote control unit

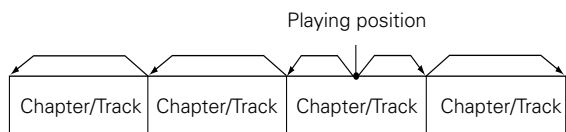

Reverse direction ← → Forward direction (direction of playback)

**NOTE:**

- In some cases the menu screen may reappear when one of the **◀◀** / **▶▶** buttons is pressed during menu playback on a video CD.

**Searching using the number buttons**

- ① During playback, press the search mode button on the remote control unit.
  - The mode switches as shown below each time the button is pressed:  
 For DVDs : Title ← → Chapter  
 For CDs and video CDs : Track (no switching)
  - ※ The search mode set by pressing the search mode button is stored in the memory until the power is turned off.
- ② Use the number buttons on the remote control unit to input the number of the title, chapter or track to be played.
  - ※ Some DVDs or video CDs may be designed to operate in special ways and will not operate as described here.

### (8) Playing Frame by Frame (for DVDs and video CDs only)

- 1 During playback, press the **⏸** button on the remote control unit.
  - The picture moves forward one frame each time the button is pressed.
  - Press the **▶** button to resume normal playback.



Remote control unit

**(9) Slow Playback (for DVDs and video CDs only)**

- In the still mode, press one of the ◀◀ / ▶▶ buttons on the remote control unit.
  - ◀◀ : Reverse direction
  - ▶▶ : Forward direction
  - When pressed again, the slow play speed increases. (Four step) (Three step on video CDs)
  - Press the PLAY button to resume normal playback.



Remote control unit

**NOTE:**

- Reverse slow play is not possible on video CDs.

**12 OPERATING THE SURROUND FUNCTIONS**

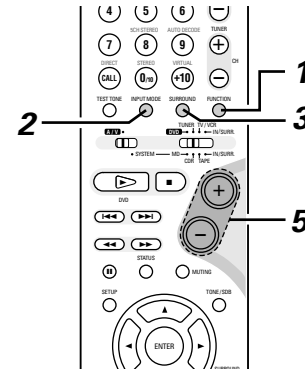
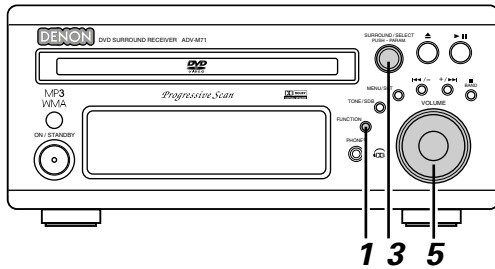

**Input mode setting**

- Press the FUNCTION button to select the input function to be played.



Main unit



Remote control unit

- The function switches as shown below.
- Factory default (LINE 1) = MD, (LINE 2) = TAPE

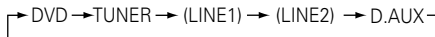

- When DVD, D.AUX or (LINE1) = MD was selected as the input function, press the remote control unit's INPUT MODE button to select the input mode.



Remote control unit

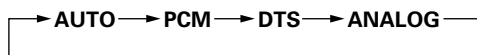

- "ANALOG" cannot be selected when DVD or D.AUX was selected as the input function.
- "ANALOG" can be selected when "LINE-2" is set to "D.AUX" at "FUNCTION ASSIGNMENT" under "SYSTEM SETUP" in the detailed settings.

**Input mode selection function**

- The input mode can be selected when the input function is set to DVD, D.AUX or (LINE1) = MD.
- Different input modes can be selected for each input function. The selected input mode is stored in the memory for the individual input functions.
- When the input function is set to something other than the above, "ANALOG ONLY" is displayed and the input mode cannot be selected.

① AUTO (auto mode)

In this mode, the type of signal being input to the digital and analog input terminals is detected and the program in the set's surround decoder is switched automatically to play the signals for the selected input function.

The presence or absence of digital signals is detected, the signals input to the digital input are identified and decoding and playback are performed automatically in DTS, Dolby Digital or PCM (2 channel stereo) format.

If no digital signal (LINE1) = MD is being input, the analog input jacks are selected.

Use this mode to play Dolby Digital signals.

② PCM (exclusive PCM signal playback mode)

Decoding and playback are only performed when PCM signals are being input.

③ DTS (exclusive DTS signal playback mode)

Decoding and playback are only performed when DTS signals are being input.

④ ANALOG (exclusive analog audio signal playback mode)

The signals input to the analog input jacks are played. (This cannot be selected in the DVD mode.)

※ The input mode automatically switches to "AUTO" if you switch the input function to DVD from anything other than DVD.

- 3** Either turn the SURROUND/SELECT dial or press the SURROUND button on the remote control unit to select the surround mode.



Main unit



Remote control unit

- The function switches as shown below.
- The function only changes in the “→” direction when operated from the remote control unit.

DOLBY VS ↔ STEREO ↔ DIRECT ↔ \*AUTO DECODE  
 ↔ \*5CH STEREO ↔ \*MONO MOVIE ↔ ROCK ARENA  
 ↔ JAZZ CLUB ↔ VIDEO GAME ↔ \*MATRIX  
 ↔ DOLBY VS ---

- The modes marked “\*” can be selected when “5.1-channel surround” is selected in the quick system setup.

- 4** Start playback on the selected component.
- For operating instructions, refer to the component’s manual.

- 5** Either turn the MASTER VOLUME dial on the main unit or use the VOLUME buttons on the remote control unit to adjust the volume.

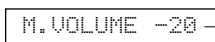

The volume level is displayed on the display.

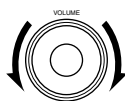

Main unit

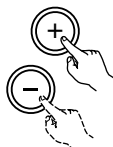

Remote control unit

- The volume can be adjusted within the range -60 to 0 to +18 dB. Note that depending on the input signal, surround mode, speaker settings and channel level setting, it may not be possible to adjust the volume up to +18 dB.

**■ To check the currently playing program source, etc.**  
 Press the MENU/SET button. Display “STATUS” then turn the SURROUND/SELECT control.



Main unit



Main unit



Remote control unit

※ To perform this operation on the remote control unit, press the STATUS button.

The current program source and surround settings are shown on the display each time the button is pressed or turned. (When the function is set to DVD, the information is also displayed on the TV screen.)

**Input mode display**

- In the AUTO mode
- In the DIGITAL PCM mode
- In the DIGITAL DTS mode
- In the ANALOG mode

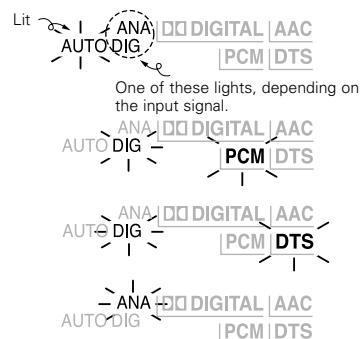

**Input signal display**

- DOLBY DIGITAL
- DTS
- PCM

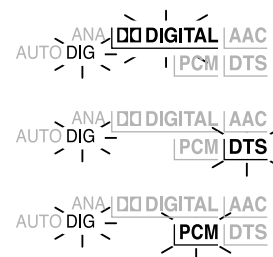

- “DIG” lights when digital signals are input properly. If “DIG” is flashing, check whether the connections are proper and whether the input component’s power is on.

**Input mode when playing CD sources**

- When playing CDs containing recordings of live concerts, etc., in the “AUTO” mode, the sound may be slightly broken at the beginning. If this happens, switch to the “PCM” mode.

**Input mode when playing DTS sources**

- If DTS-compatible CDs are played in the “PCM” mode, noise is output because DTS playback is not possible. To play a DTS-compatible source, be sure to set the input mode to “AUTO” or “DTS”.
- Noise may be generated at the beginning of playback and while searching during DTS playback in the AUTO mode. If so, play in the DTS mode.

**After starting playback**

**[1] Adjusting the sound quality (TONE/SDB)**

The TONE/SDB function will not work in the direct mode.

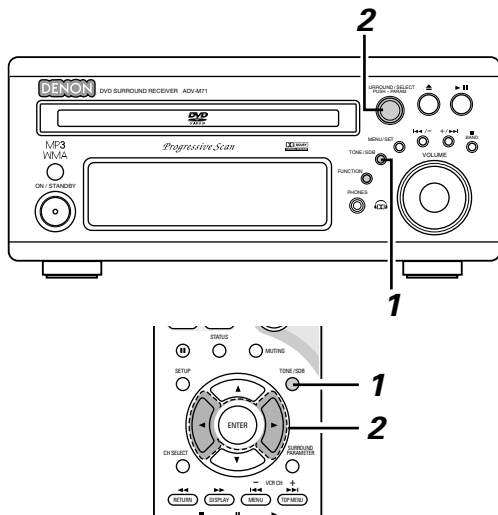

- 1** Press the TONE/SDB button.
- The tone switches as follows each time the TONE/SDB button is pressed.



Main unit



Remote control unit

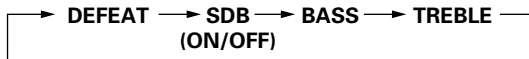

- 2** With the name of the volume to be adjusted selected, turn the SURROUND/SELECT knob or cursor button ( ◀, ▶ ) to adjust the level.



Main unit

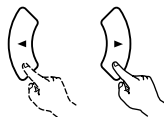

Remote control unit

**DEFEAT**

- The signals do not pass through the SDB, bass and treble adjustment circuits, providing higher quality sound.

**SDB**

- Either turn the FUNCTION / SELECT dial or use the ( ◀, ▶ ) cursor buttons to select "ON" or "OFF".

**BASS, TREBLE**

- To increase the bass or treble: Turn the control clockwise or press the cursor button. (The bass or treble sound can be increased to up to +10 dB in steps of 2 dB.)
- To decrease the bass or treble: Turn the control clockwise or press the cursor button. (The bass or treble sound can be decreased to up to -10 dB in steps of 2 dB.)

※ When TONE/SDB is displayed, the item can be switched using the ▲ and ▼ buttons on the remote control unit.

※ If no operation is performed within 4 seconds, the display switches back to what was previously displayed.

**[2] Turning the sound off temporarily (MUTING)**

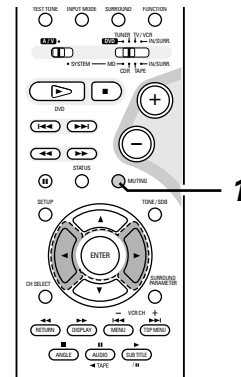

- 1** Use this to turn off the audio output temporarily. Press the MUTING button.
- ※ Cancelling MUTING mode. Press the MUTING button again.



Remote control unit

**NOTES:**

- The mute mode is canceled when the main unit's main volume control or one of the main volume control buttons on the remote control unit is operated.
- The setting is canceled if the set's power is turned off.

## 13 DOLBY / DTS SURROUND

### Surround

This unit is equipped with a digital signal processing circuit that lets you play program sources in the surround mode to achieve the same sense of presence as in a movie theater.

#### Dolby Surround

##### (1) Dolby Digital (Dolby Surround AC-3)

Dolby Digital is the multi-channel digital signal format developed by Dolby Laboratories.



Dolby Digital consists of up to "5.1" channels - front left, front right, center, surround left, surround right, and an additional channel exclusively reserved for additional deep bass sound effects (the Low Frequency Effects – LFE – channel, also called the ".1" channel, containing bass frequencies of up to 120 Hz).

Unlike the analog Dolby Pro Logic format, Dolby Digital's main channels can all contain full range sound information, from the lowest bass, up to the highest frequencies – 22 kHz. The signals within each channel are distinct from the others, allowing pinpoint sound imaging, and Dolby Digital offers tremendous dynamic range from the most powerful sound effects to the quietest, softest sounds, free from noise and distortion.

#### ■ Dolby Digital and Dolby Pro Logic

Comparison of home surround systems	Dolby Digital	Dolby Pro Logic
No. recorded channels (elements)	5.1 ch	2 ch
No. playback channels	5.1 ch	4 ch
Playback channels (max.)	L, R, C, SL, SR, SW	L, R, C, S (SW - recommended)
Audio processing	Digital discrete processing Dolby Digital (AC-3) encoding/decoding	Analog matrix processing Dolby Surround
High frequency playback limit of surround channel	20 kHz	7 kHz

#### ■ Dolby Digital compatible media and playback methods

Marks indicating Dolby Digital compatibility:  and .

The following are general examples. Also refer to the player's operating instructions.

Media	Dolby Digital output jacks	Playback method (reference page)
LD (VDP)	Coaxial Dolby Digital RF output jack ※ 1	Set the input mode to "AUTO". (Page 43, 44)
DVD	Optical or coaxial digital output (same as for PCM) ※ 2	Set the input mode to "AUTO". (Page 43, 44)
Others (satellite broadcasts, CATV, etc.)	Optical or coaxial digital output (same as for PCM)	Set the input mode to "AUTO". (Page 43, 44)

※ 1 Use a commercially available adapter to connect Dolby Digital RF (AC-3RF) output signals to the digital input terminals. (Refer to the adapter's operating instructions.)

Please refer to the instruction manual of the adapter when making connection.

※ 2 To play in Dolby Digital Surround on the ADV-M71, set "DVD SUTUP" – "AUDIO SETUP" – "DIGITAL OUT" to "Normal" in the setup. (The factory default is "Normal".)

##### (2) Dolby Pro Logic II

- Dolby Pro Logic II is a new multi-channel playback format developed by Dolby Laboratories using feedback logic steering technology and offering improvements over conventional Dolby Pro Logic circuits.
- Dolby Pro Logic II can be used to decode not only sources recorded in Dolby Surround (※) but also regular stereo sources into five channels (front left, front right, center, surround left and surround right) to achieve surround sound.
- Whereas with conventional Dolby Pro Logic the surround channel playback frequency band was limited, Dolby Pro Logic II offers a wider band range (20 Hz to 20 kHz or greater). In addition, the surround channels were monaural (the surround left and right channels were the same) with previous Dolby Pro Logic, but Dolby Pro Logic II they are played as stereo signals.
- Various parameters can be set according to the type of source and the contents, so it is possible to achieve optimum decoding (see page 59).

※ Sources recorded in Dolby Surround

These are sources in which three or more channels of surround have been recorded as two channels of signals using Dolby Surround encoding technology.

Dolby Surround is used for the sound tracks of movies recorded on DVDs, LDs and video cassettes to be played on stereo VCRs, as well as for the stereo broadcast signals of FM radio, TV, satellite broadcasts and cable TV.

Decoding these signals with Dolby Pro Logic makes it possible to achieve multi-channel surround playback. The signals can also be played on ordinary stereo equipment, in which case they provide normal stereo sound.

There are two types of DVD Dolby surround recording signals.

- 2-channel PCM stereo signals
- 2-channel Dolby Digital signals

Regardless of the signal being played, when the 2-channel decode mode is set to the "Pro Logic II" mode in the "AUTO DECODE" mode, the surround mode is automatically set to "Dolby Pro Logic II".

■ Sources recorded in Dolby Surround are indicated with the logo mark shown below.

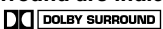
Dolby Surround support mark: 

Manufactured under license from Dolby Laboratories.  
 "Dolby", "Pro Logic" and the double-D symbol are trademarks of Dolby Laboratories.

## DTS Digital Surround



Digital Theater Surround (also called simply DTS) is a multi-channel digital signal format developed by Digital Theater Systems. DTS offers the same "5.1" playback channels as Dolby Digital (front left, front right and center, surround left and surround right) as well as the stereo 2-channel mode. The signals for the different channels are fully independent, eliminating the risk of deterioration of sound quality due to interference between signals, crosstalk, etc.

DTS features a relatively higher bit rate as compared to Dolby Digital (1234 kbps for CDs and LDs, 1536 kbps for DVDs) so it operates with a relatively low compression rate. Because of this the amount of data is great, and when DTS playback is used in movie theaters, a separate CD-ROM synchronized with the film is played.

With LDs and DVDs, there is of course no need for an extra disc; the pictures and sound can be recorded simultaneously on the same disc, so the discs can be handled in the same way as discs with other formats.

Other media include CDs recorded in DTS. These are the same discs as conventional CDs (recorded in 2 channels) but include 5.1 channel surround signals. They do not include images, but they do permit surround playback on the ADV-M71 and on CD players. DTS surround track playback offers the same intricate, grand sound as in a movie theater, right in your own listening room.

■ DTS compatible media and playback methods

Marks indicating DTS compatibility:  and .

The following are general examples. Also refer to the player's operating instructions.

Media	DTS Digital output jacks	Playback method (reference page)
CD	Optical or coaxial digital output (same as for PCM) ※ 2	Set the input mode to "AUTO" or "DTS" (page 43, 44). Never set the mode to "ANALOG" or "PCM". ※ 1
LD (VDP)	Optical or coaxial digital output (same as for PCM) ※ 2	Set the input mode to "AUTO" or "DTS" (page 43, 44). Never set the mode to "ANALOG" or "PCM". ※ 1
DVD	Optical or coaxial digital output (same as for PCM) ※ 3	Set the input mode to "AUTO" or "DTS" (page 43, 44).

- ※ 1 DTS signals are recorded in the same way on CDs and LDs as PCM signals. Because of this, the un-decoded DTS signals are output as random "hissy" noise from the CD or LD player's analog outputs. If this noise is played with the amplifier set at a very high volume, it may possibly cause damage to the speakers. To avoid this, be sure to switch the input mode to "AUTO" or "DTS" before playing CDs or LDs recorded in DTS. Also, never switch the input mode to "ANALOG" or "PCM" during playback. The same is true when playing CDs and LDs recorded in DTS on the ADV-M71 or on LD/DVD compatible players. With DVDs, the DTS signals are recorded with a special recording method so there is no problem. For DVDs, the DTS signals are recorded in a special way so this problem does not occur.
- ※ 2 The signals provided at the digital outputs of a CD or LD player may undergo some sort of internal signal processing (output level adjustment, sampling frequency conversion, etc.). In this case the DTS-encoded signals may be processed erroneously, in which case they cannot be decoded by this unit, or may only produce noise. Before playing DTS signals for the first time, turn down the master volume to a low level, start playing the DTS disc, then check whether the DTS indicator on this unit (see page 44) lights before turning up the master volume.
- ※ 3 To play in DTS Digital Surround on the ADV-M71, set "DVD SETUP" — "AUDIO SETUP" — "DIGITAL OUT" to "Normal" in the setup. (The factory default is "Normal".)

"DTS" and "DTS Digital Surround" are registered trademarks of Digital Theater Systems, Inc.

## Dolby Virtual Speaker

Dolby Virtual Speaker technology uses proprietary technology of Dolby Laboratories to create a virtual surround sound field using only two speakers for the front channels, allowing the user to experience sound as if surround speakers were actually being used.

### ■ Features of Dolby Virtual Speaker sound

- ⊙ Accurate surrounding sound field positioning  
The virtual surround speakers are positioned at 105° to the left and 105° to the right.
- ⊙ Multi-channel programs played according to the producer's intentions  
The sound of the different channels is played in the position set upon mixing. For example, sound set at the rear left is heard from the rear left.
- ⊙ Stereo programs played in surround  
The Dolby Pro Logic II circuit is used together with the Dolby Virtual Speaker circuitry to create a rich virtual surround sound field with stereo programs as well.
- ⊙ Selecting the listening mode  
Two listening modes are provided: Reference and Wide.



With the ADV-M71, playback in the Dolby Virtual Speaker mode is possible with other speaker configurations as well.

- 3 speakers (2 front channels + center) : Reference/Wide modes
- 4 speakers (2 front channels + 2 surround channels) : Wide mode
- 5 speakers (2 front channels + center + 2 surround channels) : Wide mode

## Dolby Headphone

Dolby Headphone is a 3D sound technology developed jointly by Dolby Laboratories and Lake Technology of Australia achieving surround sound with regular headphones.

Normally when using headphones all the sounds are sounded in the head, making it uncomfortable to listen with headphones for long periods of time. Dolby Headphone simulates speaker playback in a room and positions the sound sources to the front or the sides, outside of the head, achieving a powerful sound similar to that of a movie theater or home theater. This technology is aimed mainly at multi-channel audio or video equipment including Dolby Digital or Dolby Pro Logic Surround decoding functions and operates inside a high performance digital signal processing chip (DSP).

The Dolby Headphone mode can be used not only with multi-channel sources but also with stereo programs.



# 14 SURROUND PLAYBACK

## (1) Playing in the Dolby Virtual Speaker mode

- The Dolby Virtual Speaker mode is a mode using 3D sound technology from Dolby Laboratories to achieve multi-channel surround sound using only two speakers for the front channels.
- With two speakers for the front channels, one of two modes can be selected: Reference or Wide.
- The Dolby Virtual Speaker mode can be used not only with Dolby Digital and DTS multi-channel sources but also with 2-channel sources. With 2-channel sources, one of two 2-channel modes can be selected: Virtual 1 (Dolby Pro Logic II Cinema) and Virtual 2 (Dolby Pro Logic).
- With a multi-channel speaker configuration (for example 5.1 channels), the Dolby Virtual Speaker mode provides different effects according to the speaker configuration.

### [1] Playing Dolby Digital and DTS surround sound (with digital inputs only)

- Applicable sources
  - Digital input (LINE-1 and D.AUX functions, including DVD playback discs)
    - Dolby Digital multi-channel sources
    - DTS sources

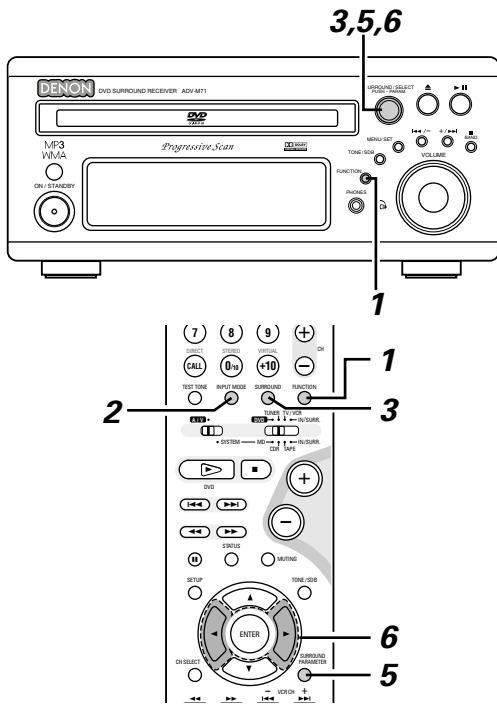

**1** Select the digital input function (DVD or LINE-1 or D.AUX digital input).



**2** Set the input mode to "AUTO".  
 ※ DTS sources can also be played with the input mode set to "DTS".

Remote control unit

**3** Set the surround mode to "DOLBY VIRTUAL SPEAKER".



• In the Dolby Virtual Speaker mode, this indicator lights.

Lit

**4** Play a program source including the or mark.

- The Dolby Digital indicator lights when playing Dolby Digital sources.
- The DTS indicator lights when playing DTS sources.

※ This switches automatically according to the format of the playback source.

**5** Display the surround parameters for that source.  
 ※ When the function is set to DVD, this is displayed on the screen as well.



# 6

Select and set the surround parameters. (On the remote control unit, use the ◀, ▶ cursor buttons to set the parameters.)



Main unit

※ If nothing is done for 6 seconds from when the parameter is displayed, the normal display reappears.

◎ Setting the DOLBY VS mode

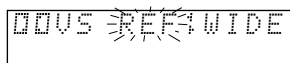

※ The selected mode flashes.  
 ※ The mode is not displayed if it cannot be selected.

◎ D.COMP. setting

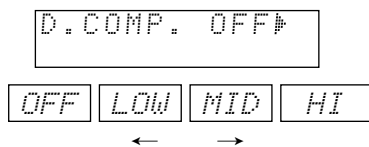

◎ Setting the LFE level

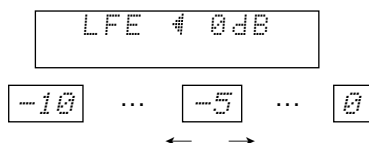

※ The LFE level can be adjusted in steps of 1 dB between -10 dB and 0 dB.

◎ DEFAULT setting

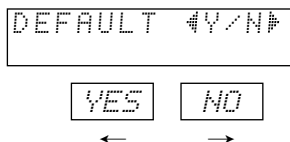

※ When "YES" is selected, the settings are restored to the factory defaults.

- ※ When the surround parameters are displayed, use the ▲ and ▼ cursor buttons on the remote control unit to switch to previous or following items.
- ※ Once the surround parameters have been set, stop operating the buttons. After several seconds, the normal display reappears and the settings are automatically entered.

## Surround parameters (1)

### DOLBY VS (Dolby Virtual Speaker mode)

- REF (Reference mode)  
This is the standard mode.
- WIDE (Wide mode)  
This mode expands the front channel sound field.

### D.COMP. (Dynamic range compression)

- This parameter adjusts the dynamic range of the Dolby Digital sound. When listening with the volume turned relatively low, at night for example, set this to the "HI" side to lower the peak of the sound and amplify the quieter sounds, narrowing the dynamic range and making the sound easier to listen to. Set to "OFF" to turn this function off.

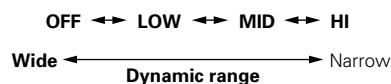

### LFE (Low Frequency Effect):

- Program source and adjustment range
  1. Dolby Digital : -10 dB to 0 dB
  2. DTS Surround : -10 dB to 0 dB
- When Dolby Digital encoded software is played, it is recommended that the LFE LEVEL be set to 0 dB for correct Dolby Digital playback.
- When DTS encoded movie software is played, it is recommended that the LFE LEVEL be set to 0 dB for correct DTS playback.
- When DTS encoded music software is played, it is recommended that the LFE LEVEL be set to -10 dB for correct DTS playback.

**[2] 2-channel mode settings**

- When 2-channel signals are input, one of two playback modes can be selected and set according to the 2-channel mode setting, Virtual 1 or Virtual 2. (The Virtual 1 mode is set by factory default.)
- Virtual 1 : 2-channel sources are played in virtual surround using Dolby Pro Logic II Cinema processing.  
 Virtual 2 : 2-channel sources are played in virtual surround using Dolby Pro Logic processing.

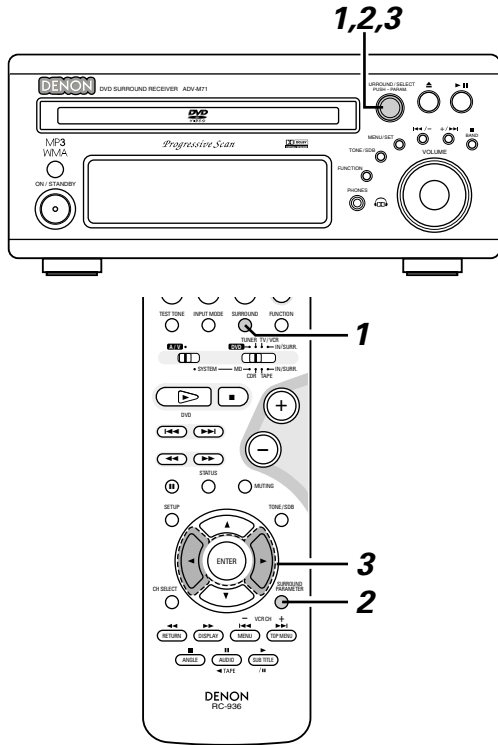

**NOTES:**

- The 2-channel mode cannot be set when Dolby Digital or DTS 5.1-channel signals.
- The 2-channel mode is set and stored in the memory individually for the different functions.

**1** Set the surround mode to “DOLBY VIRTUAL SPEAKER” (“DOLBY VS”).

- The normal display reappears after the surround mode is displayed.



Main unit



Remote control unit

**2** Press the SURROUND PARAMETER button and select the 2-channel mode.



Main unit

※ This can be selected if there is no digital input signal, if the digital input is a PCM or Dolby Digital 2-channel signal and if the input is analog.



Remote control unit

**3** Turn the SURROUND/SELECT control on the main unit or use the ◀ and ▶ cursor buttons on the remote control unit to select the desired 2-channel mode.



Main unit

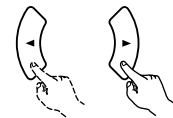

Remote control unit

**VIRTUAL 1 ↔ VIRTUAL 2**

※ Once the surround parameters have been set, stop operating the buttons. After several seconds, the normal display reappears and the settings are automatically entered

### Surround parameters (2)

#### 1. VIRTUAL1 (Virtual 1 mode)

In this mode, 2-channel sources are played with Dolby Pro Logic II Cinema processing. This mode is suited for playing movie sources recorded in Dolby Surround and regular stereo sources.

#### 2. VIRTUAL2 (Virtual 2 mode)

In this mode, 2-channel sources are played with Dolby Pro Logic processing. This mode is compatible with regular Dolby Pro Logic playback. With it, the recorded playback image of sources recorded in Dolby Surround is recreated faithfully.

**NOTE:**

- If noise is generated for interactive and other high bit rate sources when playing DVDs or D.AUX digital input signals in the Dolby Virtual Speaker mode, set "LINE-1/LINE-2 REC OUT" under "[5] Function settings" at "SYSTEM SETUP" on pages 37 and 38 to "Off".  
(When this is done, analog recording in the Dolby Virtual Speaker mode is not possible.)

## (2) Playing in the DENON original surround modes

- This unit is equipped with a high performance DSP (Digital Signal Processor) which uses digital signal processing to synthetically recreate the sound field. One of 6 preset surround modes can be selected according to the program source and the parameters can be adjusted according to the conditions in the listening room to achieve a more realistic, powerful sound. These surround modes can also be used for program sources not recorded in Dolby Surround Pro Logic or Dolby Digital.

* 1	MONO MOVIE (NOTE 1)	Select this when watching monaural movies for a greater sense of expansion.
2	ROCK ARENA	Use this mode to achieve the feeling of a live concert in an arena with reflected sounds coming from all directions.
3	JAZZ CLUB	This mode creates the sound field of a live house with a low ceiling and hard walls. This mode gives jazz a very vivid realism.
4	VIDEO GAME	Use this to enjoy video game sources.
* 5	MATRIX	Select this to emphasize the sense of expansion for music sources recorded in stereo. Signals consisting of the difference component of the input signals (the component that provides the sense of expansion) processed for delay are output from the surround channel.
* 6	5CH STEREO	In this mode, the signals of the front left channel are output from the left surround channel, the signals of the front right channel are output from the right surround channel, and the same (in-phase) component of the left and right channels is output from the center channel. This mode provides all speaker surround sound, but without directional steering effects, and works with any stereo program source.

- ※ Surround modes indicated "\*" can be selected when the speaker setting is set to 5.1 channels.
- ※ Depending on the source being played, the effect may not be very strong.

In such cases, try other surround modes without paying too much attention to their names and choose the one you feel is best.

NOTE 1: When playing sources recorded in monaural, the sound is one-sided if only one channel (left or right) is input, so input signals to both channels.

#### Personal Memory Plus

This set is equipped with a personal memorize function that automatically memorizes the surround modes and input modes selected for the input different sources. When the input source is switched, the modes set for that source last time it was used are automatically recalled.

- Settings automatically stored in the memory for the individual input functions using the Personal Memory Plus function:
  - ① Surround mode (including 2-channel decode mode and Dolby Pro Logic II mode settings)
  - ② Input mode selection function

※ The surround parameters, TONE/SDB control settings and playback level balance for the different output channels are memorized for each surround mode.

[1] DSP Surround simulation

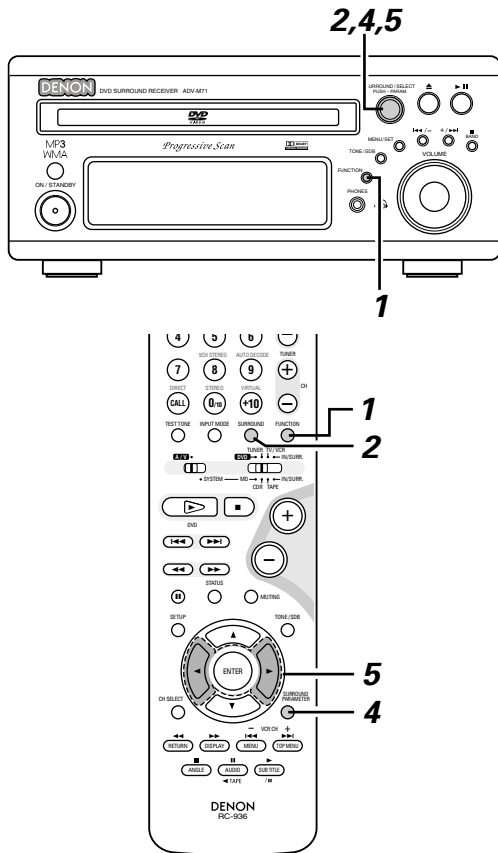

**1** Select the input source.

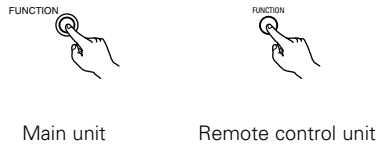

**2** Select the surround mode for the input channel.



- The surround mode switches in the following order each time the SURROUND MODE button is pressed:

**DOLBY VS ↔ STEREO ↔ DIRECT ↔ \*AUTO DECODE**  
**↔ \*5CH STEREO ↔ \*MONO MOVIE ↔ ROCK ARENA**  
**↔ JAZZ CLUB ↔ VIDEO GAME ↔ \*MATRIX**  
**↔ DOLBY VS ---**

- The modes marked "\*" can be selected when "5.1-channel surround" is selected in the quick system setup.

**3** Play a program source.

- Refer to instruction manual for handling.

**4** To enter the surround parameter setting mode, press the SURROUND mode.

- The surround parameter switches in the following order each time the SURROUND button is pressed for the different surround modes.



Remote control unit

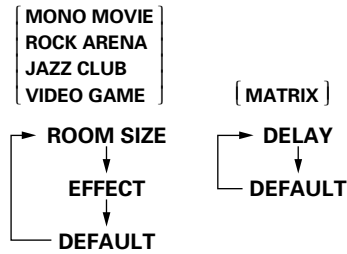

\* There is no 5-channel stereo mode.

**5** Display the parameter you want to adjust.

- Use the cursor buttons (▲, ▼) to select the surround parameter.



Main unit

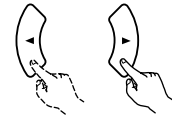

Remote control unit

- ROOM SIZE setting

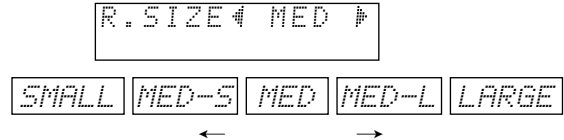

- EFFECT LEVEL setting

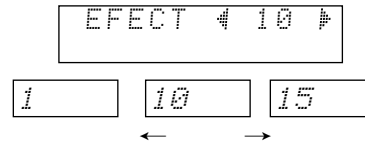

- DELAY TIME setting

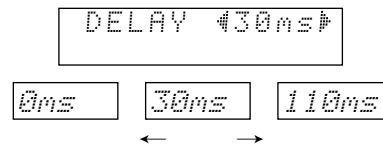

## 5

- DEFAULT setting

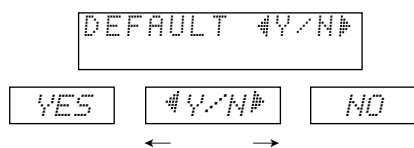

- ※ When "YES" is selected, the settings are reset to their factory default values.

- ※ Stop operating buttons once the surround parameter settings have been completed. After several seconds the normal display reappears and the settings are automatically set.

### Surround parameters (3)

#### ROOM SIZE:

- This sets the size of the sound field.  
There are five settings: "SMALL", "MED-S" (medium-small), "MED", "MED-L" (medium-large) and "LARGE". "SMALL" recreates a small sound field, "LARGE" a large sound field.

#### EFFECT LEVEL:

- This sets the strength of the surround effect.  
The level can be set in 15 steps from 1 to 15. Lower the level if the sound seems distorted.

#### DELAY TIME:

- In the MATRIX mode only, the delay time can be set within the range of 0 to 110 ms.

■ Table of Surround Mode Parameters (1)

Surround Mode DVS: Dolby Virtual Speaker DHP: Dolby Headphone		Presence/absence of signals and controllability in the various modes			
		Channel output			
		FRONT L/R	CENTER	SURROUND L/R	SUB-WOOFER
DVS	REFERENCE	○	⊙	×	⊙
	WIDE	○	⊙	⊙	⊙
DHP	DH1	○ (H/P ONLY)	×	×	×
	DH2	○ (H/P ONLY)	×	×	×
	DH3	○ (H/P ONLY)	×	×	×
	BYPASS	○ (H/P ONLY)	×	×	×
STEREO		○	×	×	⊙
DIRECT		○	×	×	⊙
AUTO DECODE	DOLBY DIGITAL	○	⊙	⊙	⊙
	DTS SURROUND	○	⊙	⊙	⊙
	DOLBY PL II	○	⊙	⊙	⊙
	AUTO STEREO	○	×	×	⊙
5CH STEREO		○	⊙	⊙	⊙
MONO MOVIE		○	⊙	⊙	⊙
ROCK ARENA		○	⊙	⊙	⊙
JAZZ CLUB		○	⊙	⊙	⊙
VIDEO GAME		○	⊙	⊙	⊙
MATRIX		○	⊙	⊙	⊙

■ Table of Surround Mode Parameters (2)

Surround Mode DVS: Dolby Virtual Speaker DHP: Dolby Headphone		Presence/absence of signals and controllability in the various modes						
		Playback signals and surround modes for the various input functions						
		DVD / D.AUX / MD / LINE1					(D.AUX / L2) MD / LINE1	TAPE / LINE2 / TUNER
		When playing Dolby Digital signals		When playing DTS signals		When playing PCM signals	When playing analog signals	When playing analog signals
		2-channel	Multi-channel	2-channel	Multi-channel	2-channel	2-channel	2-channel
DVS	REFERENCE	●PL II	○	●PL II	○	●PL II	●PL II	●PL II
	WIDE	●PL II	○	●PL II	○	●PL II	●PL II	●PL II
DHP	DH1	●PL II	○	●PL II	○	●PL II	●PL II	●PL II
	DH2	●PL II	○	●PL II	○	●PL II	●PL II	●PL II
	DH3	●PL II	○	●PL II	○	●PL II	●PL II	●PL II
	BYPASS	○	○ D.MIX	○	○ D.MIX	○	○	○
STEREO		○	○ D.MIX	○	○ D.MIX	○	○	○
DIRECT		○	○ D.MIX	○	○ D.MIX	○	○	○
AUTO DECODE	DOLBY DIGITAL	○	○	×	×	×	×	×
	DTS SURROUND	×	×	×	○	×	×	×
	DOLBY PL II	●PL II	×	●PL II	×	●PL II	●PL II	●PL II
	AUTO STEREO	●	×	●	×	●	●	×
5CH STEREO		○	○	○	○	○	○	○
MONO MOVIE		○	○	○	○	○	○	○
ROCK ARENA		○	○	○	○	○	○	○
JAZZ CLUB		○	○	○	○	○	○	○
VIDEO GAME		○	○	○	○	○	○	○
MATRIX		○	○	○	○	○	○	○

- ⊙ : Can be either present or absent, depending on speaker configuration setting.
- : Only usable when center or surround speakers set to be used with the speaker configuration setting.
- : Signal present or controllable.
- : Can be selected with 2-channel decode mode.
- ×
- D.MIX: Compatible with down-mixing.
- PL II: Compatible with PL II processing.

■ Table of Surround Mode Parameters (3)

Surround Mode DVS: Dolby Virtual Speaker DHP: Dolby Headphone		Presence/absence of signals and controllability in the various modes					
		Surround parameter – default value indicated in (parentheses)					
		SDB	TONE CONTROL	2ch DECODE MODE	Pro Logic II Music mode only		
PANORAMA	DIMENSION				CENTER WIDTH		
DVS	REFERENCE	○ (OFF)	○ (OFF)	○ (VIRTUAL1)	×	×	×
	WIDE	○ (OFF)	○ (OFF)		×	×	×
DHP	DH1	○ (OFF)	○ (OFF)	○ *2 (CINEMA)	×	×	×
	DH2	○ (OFF)	○ (OFF)		×	×	×
	DH3	○ (OFF)	○ (OFF)		×	×	×
	BYPASS	○ (OFF)	○ (OFF)		×	×	×
STEREO		○ (OFF)	○ (OFF)	×	×	×	×
DIRECT		×	×	×	×	×	×
AUTO DECODE	DOLBY DIGITAL	○ (OFF)	○ (OFF)	○ *1 (AUTO STEREO)	×	×	×
	DTS SURROUND	○ (OFF)	○ (OFF)		×	×	×
	DOLBY PL II	○ (OFF)	○ (OFF)		○ (OFF)	○ (3)	○ (3)
	AUTO STEREO	○ (OFF)	○ (OFF)		×	×	×
5CH STEREO		○ (OFF)	○ (OFF)	×	×	×	×
MONO MOVIE		○ (OFF)	○ (OFF)	×	×	×	×
ROCK ARENA		○ (OFF)	○ (OFF)	×	×	×	×
JAZZ CLUB		○ (OFF)	○ (OFF)	×	×	×	×
VIDEO GAME		○ (OFF)	○ (OFF)	×	×	×	×
MATRIX		○ (OFF)	○ (OFF)	×	×	×	×

■ Table of Surround Mode Parameters (4)

Surround Mode DVS: Dolby Virtual Speaker DHP: Dolby Headphone		Presence/absence of signals and controllability in the various modes				
		Surround parameter – default value indicated in (parentheses)				
		ROOM SIZE	EFFECT LEVEL	DELAY TIME	Dolby Digital/DTS signal	
D. COMP.	LFE					
DVS	REFERENCE	×	×	×	○ (OFF)	○ (0dB)
	WIDE	×	×	×	○ (OFF)	○ (0dB)
DHP	DH1	×	×	×	○ (OFF)	○ (0dB)
	DH2	×	×	×	○ (OFF)	○ (0dB)
	DH3	×	×	×	○ (OFF)	○ (0dB)
	BYPASS	×	×	×	○ (OFF)	○ (0dB)
STEREO		×	×	×	○ (OFF)	○ (0dB)
DIRECT		×	×	×	○ (OFF)	○ (0dB)
AUTO DECODE	DOLBY DIGITAL	×	×	×	○ (OFF)	○ (0dB)
	DTS SURROUND	×	×	×	○ (OFF)	○ (0dB)
	DOLBY PL II	×	×	×	○ (OFF)	○ (0dB)
	AUTO STEREO	×	×	×	×	×
5CH STEREO		×	×	×	○ (OFF)	○ (0dB)
MONO MOVIE		○ (MEDIUM)	○ (10)	×	○ (OFF)	○ (0dB)
ROCK ARENA		○ (MEDIUM)	○ (10)	×	○ (OFF)	○ (0dB)
JAZZ CLUB		○ (MEDIUM)	○ (10)	×	○ (OFF)	○ (0dB)
VIDEO GAME		○ (MEDIUM)	○ (10)	×	○ (OFF)	○ (0dB)
MATRIX		×	×	○ (30ms)	○ (OFF)	○ (0dB)

■ : Only usable when center or surround speakers set to be used with the speaker configuration setting.

○ : Signal present or controllable.

× : No signal or not controllable.

\*1 : Auto Stereo mode or Dolby PL II mode (Cinema, Music or Dolby PL mode) selectable.

\*2 : Dolby PL II mode (Cinema, Music or Music 2 mode) selectable.

D.MIX: Compatible with down-mixing.

( ) : Parameter's default value



### (3) Playback using the Dolby Headphone mode

- The ADV-M71 is equipped with the Dolby Headphone mode, a technology developed jointly by Dolby Laboratories and Lake Technology for achieving 3D sound over regular headphones.
- The Dolby Headphone mode is set when headphones are connected to the ADV-M71's headphones jack.
- There are actually four Dolby Headphone modes creating different sound field effects: DH1, DH2, DH3 and Bypass (normal stereo playback).
- The Dolby Headphone mode is compatible with Dolby Digital and DTS multi-channel sources. With 2-channel sources, playback in the Cinema, Music 1 and Music 2 modes can be selected with the 2-channel mode setting.

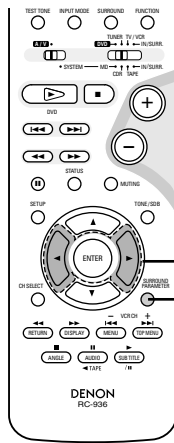
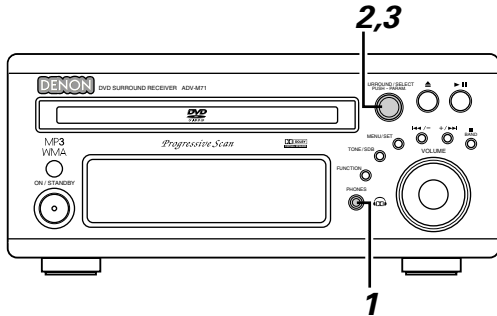

- 1** Connect headphones (sold separately) to the headphones jack.
- When headphones are plugged in, the output to the speakers is automatically turned off and no sound is produced from the speakers.

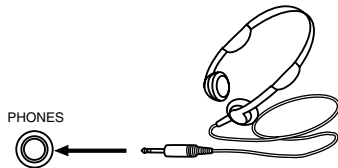

- 2** Press the surround parameter button and display the surround parameters.
- ※ When the function is set to DVD, this is also shown on the display.

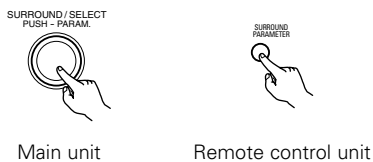

- 3** Set the various surround parameters.
- ※ If nothing is done for 6 seconds from when the parameter is displayed, the normal display reappears.

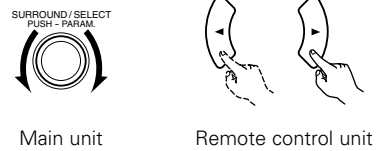

- Dolby H mode setting

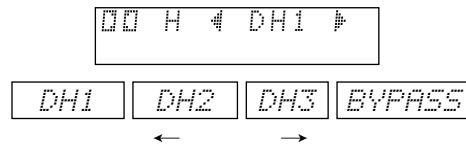

- 2-channel mode setting

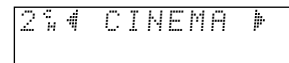

- The mode switches as shown below each time a button is operated.



- ※ Can be selected when there is no signal or when playing a 2-channel source.
- There are also the same parameters as those described under "(2) Playing in the Dolby Virtual Speaker mode", namely:
- D.COMP. setting
  - LFE level setting
  - DEFAULT setting

- ※ When the surround parameters are displayed, use the ▲ and ▼ cursor buttons on the remote control unit to switch to previous or following items.

### Surround parameters (4)

#### DOLBY H (Dolby Headphone modes)

- DH1 .....Reference room  
(small room with little reverberation)
- DH2 .....Live room  
(room with more reverberation than DH1)
- DH3 .....Large room  
(Larger room than DH1. Use this mode to achieve a sense of distance and diffusion of the sound.)
- BYPASS .....Stereo playback.

#### 2-channel modes

These can be selected when playing 2-channel sources (analog, PCM, etc.). The signals are processed by one of the following decoders to achieve multiple channels then played in the Dolby Headphone mode.

In the Bypass mode, these are not displayed.

- CINEMA .....Dolby Pro Logic II Cinema mode
- MUSIC1 .....Dolby Pro Logic II Music mode
- MUSIC2 .....Signals played in the Dolby Headphone mode with 2 channels.

#### ■ Recording

When playing digital input sources, including function DVDs, signals encoded in the Dolby Headphone mode are output from the recording output terminals and can be recorded on other recording devices.

- ① Connect headphones to the headphones jack.
- ② Signals encoded in the Dolby Headphone mode are output from the recording output terminals (in analog).
- ③ Select the parameters, set the desired mode and start recording.

#### NOTES:

- Dolby Headphone processing makes the analog recording output level lower than the normal stereo recording output level.
- Do not change the parameters or unplug the headphones during recording. Doing so will cause interruptions in the recorded sound.
- Dolby Headphone signals cannot be recorded during playback of analog sources. The analog input signals are output as such from the recording output terminals.

### (4) Playing in the Auto Decode Mode (only with multi-channel speaker settings)

- The auto decode mode can be selected when the ADV-M71 is used in combination with a subwoofer with built-in amplifier and power amplifier, center or surround speaker system and a multi-channel speaker configuration (5.1 channels, etc.) is set.
- To make the 5.1-channel setting, set the speakers to "5.1CH SURROUND" in the quick system setup and select "Room Setting" and "Listening Position". (See pages 31 to 32.)
- In the auto decode mode, multi-channel playback of multi-channel sources (Dolby Digital or DTS) can be performed automatically according to the format of the input signals.
- For 2-channel sources as well, playback is possible in the Auto Stereo, Dolby Pro Logic II Cinema, Dolby Pro Logic II Music or Dolby Pro Logic mode, as set by the 2-channel mode setting. (Two channels of stereo signals are played in the Auto Stereo mode. In other modes playback is multi-channel.)

#### [1] Dolby Digital and DTS surround playback (for digital inputs only)

- The applicable sources and procedures are the same as those described at "[1] Playing Dolby Digital and DTS surround sound" under "(1) Playing in the Dolby Virtual Speaker mode".
- At step 3, set the surround mode to "AUTO DECODE". The sound is played according to the format of the input signals.
- At step 6 there are no Dolby Virtual Speaker mode surround parameters.

#### [2] 2-channel mode setting

- With the auto decode mode, one of four multi-channel playback modes, namely stereo 2-channel playback in the Auto Stereo mode (factory default), Dolby Pro Logic II Cinema, Dolby Pro Logic II Music and Dolby Pro Logic, can be selected and set for 2-channel sources.
- ※ "Auto Stereo" mode cannot be selected for with functions only analog inputs (TUNER, LINE-2, etc.). To play such signals in stereo, set the surround mode to "STEREO". (See page 44.)
- Operations are the same as those described at "[2] 2-channel mode settings" under "(1) Playing in the Dolby Virtual Speaker mode" on page 51.
- At step 1, set the surround mode to "AUTO DECODE".
- The 2-channel modes selectable at step 3 are as follows:

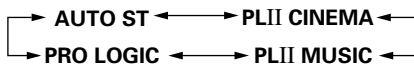

- ※ Auto Stereo can be selected when the function is set to DVD, LINE-1 or D.AUX.
- For the 2-channel mode surround parameters in the auto decode mode, refer to "Surround parameters (5)" (auto decode 2-channel mode).

## Surround parameters (5) (2-channel mode)

### AUTO-ST (auto stereo) mode

2-channel sources are played in 2-channel stereo.

When this mode is selected in the auto decode mode, multi-channel sources (DVD, BS digital, etc.) are played in the multi-channel mode, while 2-channel sources (CDs, etc.) are automatically played in stereo.

### PLII CINEMA / PLII MUSIC / PRO LOGIC mode

Even 2-channel sources undergo Dolby Pro Logic II processing and are played in the multi-channel mode.

Dolby Digital Pro-Logic II processing is applied to 2-channel sources as well to play them in the multi-channel mode.

When this mode is selected in the auto decode mode, multi-channel sources (DVD, BS digital, etc.) are played in the multi-channel mode, and 2-channel sources (CDs, etc.) are also automatically processed with Dolby Digital Pro-Logic II and played in the multi-channel mode.

- **PLII CINEMA (Dolby Pro Logic II CINEMA) mode**

This mode is suited for playing movies recorded in Dolby Surround as well as regular sources recorded in stereo. A high precision decoder decodes the signals into 5 channels, resulting in uniform 360 degree surround sound even with 2-channel sources.

The MUSIC mode may be more effective for sources containing a high ratio of stereo music. Try both and choose the most effective mode.

- **PLII MUSIC (Dolby Pro Logic II MUSIC) mode**

This mode is suited for surround playback of stereo music signals. The inverted phase signals (the reverberation component of the music signals contains a high ratio of these) are played from the surround channel, and at the same time the frequency response of the surround channel is optimized to achieve a natural sound with a sense of expansion.

With music signals, the sound field expansion differs greatly according to the type of music, the recording conditions (live, etc.) and the contents of the signal source. Because of this, the MUSIC mode includes optional parameters for further adjusting the sound field.

- **PANORAMA**

The front stereo sound field image is extended to the surround channel.

This is effective if under normal conditions the stereo image is narrow and the surround effect seems weak.

- **DIMENSION**

This shifts the center of the sound field image to the front or surround side.

The playback balance of the different channels can be adjusted regardless of the amount of reverberation component in the source. If the sound field image is biased towards the front or surround side, this optional parameter can be used to correct it.

- **CENTER WIDTH**

This adjusts the method of playback of the center signal component from the center channel only to the front channel only.

When the center channel is played in a way prioritizing separation, the position of the front channel sound field is clearer but the overall sound field image concentrates at the center and the relationship between the different channels seems weaker. This parameter can be adjusted to improve the sense of stability of the sound field image and achieve natural horizontal expansion.

- **PRO LOGIC (Dolby Pro Logic) mode**

This is the conventional Dolby Pro Logic compatible mode. In this mode sources recorded in Dolby Surround are decoded with a playback image faithful to the original recording.

- In the auto decode mode, the play mode switches automatically as shown below according to the content of the disc being played or program being received. (When the input mode is set to "AUTO" and the 2-channel mode is set to "AUTO ST")

Source	Content	Play mode
DVD	5.1/6.1-channel Dolby Digital	5.1-channel playback
	2-channel Dolby Digital (including 2-channel Dolby Surround)	Stereo playback (※)
	5.1/6.1-channel DTS digital	5.1-channel playback
CD	PCM stereo	Stereo playback (※)

(※) To play 2-channel surround (Dolby Surround) or stereo sources in the 5.1-channel surround mode, set the 2-channel mode to something other than "AUTO ST".

**[3] Setting the parameters in the PLII Cinema, PLII Music and Pro Logic modes**

- When PLII Cinema, PLII Music or Pro Logic is selected for the 2-channel mode, detailed parameters can be set for each of these modes. PLII Music mode: Make the settings using the procedure below.
- Program sources including the  **DOLBY SURROUND** mark and CDs and other 2-channel sources are decoded with Dolby Pro Logic II processing and played in the multi-channel mode.
  - PLII Cinema mode: This mode is suited for movies and other Dolby Surround programs.
  - PLII Music mode: This mode is suited for stereo music programs.
  - Pro Logic compatible mode: This is the original Dolby Surround Pro Logic mode.

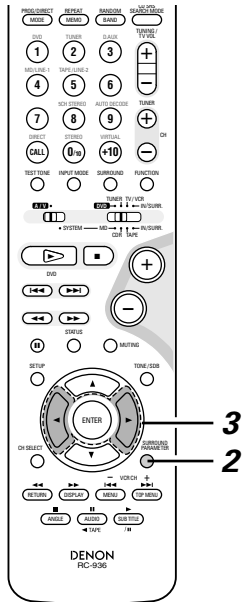

**1** Select "PLII C", "PLII M" or "PRO LOGIC" for the 2-channel mode setting.

**2** Set the surround parameters for the selected mode.  
 • The parameters switch as shown below each time one of the buttons is pressed.

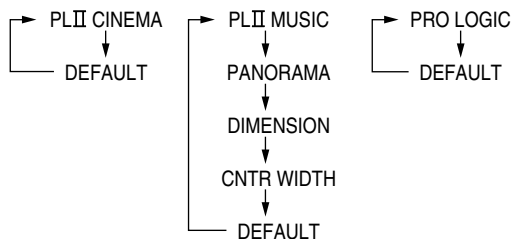

**3** Set the various surround parameters.



• Panorama setting

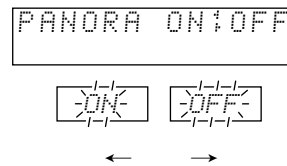

※ The selected setting flashes.

• Dimension setting

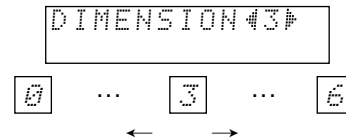

• Center Width setting

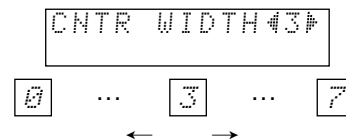

• Default setting

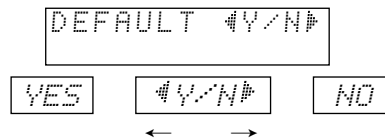

※ When "YES" is selected, the settings are restored to the factory defaults.

- Once the surround parameters have been set, stop operating the buttons. After several seconds, the normal display reappears and the settings are automatically entered.
- This completes the setting of the parameters.

**NOTES:**

- The 2-channel mode is set and stored in the memory individually for the different functions.

**[4] Playing in the Dolby Pro Logic II mode (all functions)**

- The source is played according to the settings that have been made for the 2-channel mode and the parameters in the PLII Cinema, PLII Music and Pro Logic modes.
- Applicable sources
  - Digital input signals (LINE-1 and D.AUX functions, including DVD playback discs)
    - Dolby Digital 2-channel sources
    - PCM 2-channel sources
  - 2-channel analog input signals (TUNER, LINE-1 and LINE-2)

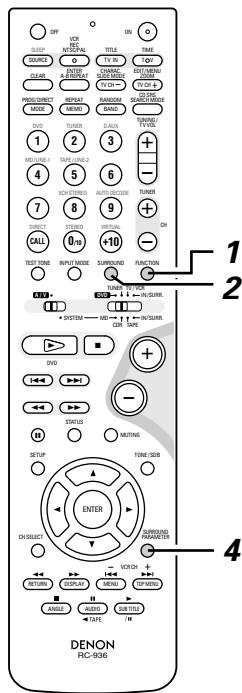
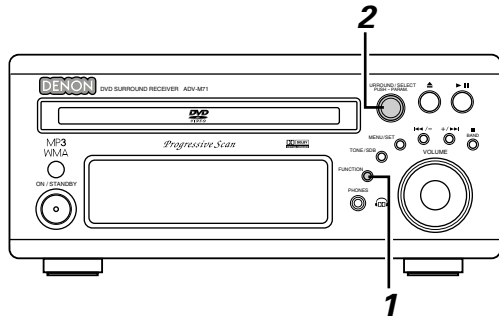

**1** Select the input function.

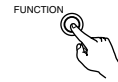

Main unit



Remote control unit

※ In the “DTS” input mode with the function set to a digital input (DVD, LINE-1 or D.AUX), it is not possible to play in the Dolby Pro Logic II mode.

**2** Set the surround mode to “AUTO DECODE”.



Main unit



Remote control unit

**3** Play a program source including the **DOLBY SURROUND** mark or a 2-channel source.

- The source is played according to the Dolby Pro Logic II mode settings.
- In the Cinema and Music modes, the Dolby Pro Logic II indicator lights.

**PRO LOGIC II** Lit

- In the Dolby Pro Logic mode, the Dolby Pro Logic indicator lights

**PRO LOGIC** Lit

**4** Set the surround parameters according to the selected mode.

※ Refer to steps 1 to 3 under “Setting the parameters in the PLII Cinema, PLII Music and Pro Logic modes” (page 60).



Remote control unit

# 15 LISTENING TO THE RADIO

## (1) Tuning

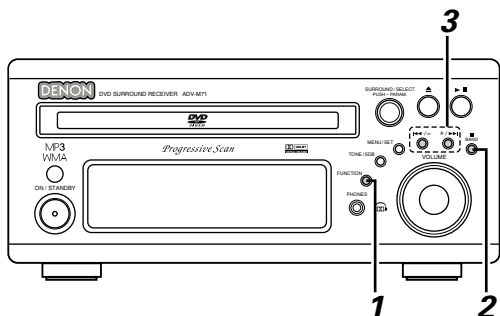

**Set the remote control selector switches to A/V and TUNER.**

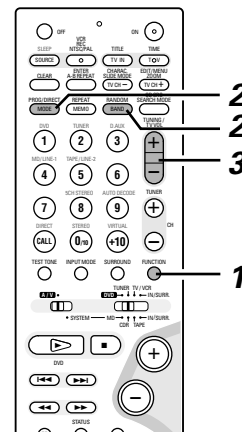
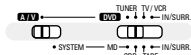

Example: Tuning in FM/AM stations

**1** Press the FUNCTION button and select "TUNER".



Main unit



Remote control unit

**2** Select "FM" or "AM".

- The selected "FM AUTO", "FM MONO" or "AM" is displayed.
- When using the remote control, the mode button is used to select FM AUTO and MONO.



Main unit



Remote control unit

**3** Adjust the receiving frequency.

- When a station is received, the "TUNED" indication will light.



Main unit



Remote control unit

**NOTES:**

A humming sound may be heard when using a TV nearby while receiving AM programs. If this happens, move the system as far from the TV as possible.

**Auto tuning**

- When one of the Tuning +/- button is pressed, the frequency changes in steps of 0.2 MHz in the FM band, 10 kHz in the AM band.
- If one of the Tuning +/- button is held for over 1 second, the frequency continues to change when the button is released (auto tuning) and stops when a station is tuned in. Tuning will not stop at stations whose reception is poor.
- To stop the auto tuning function, press the Tuning +/- button once.

**FM Stereo Reception**

- When a program being broadcast in "FM AUTO" is received, the "ST" indicator lights and the program is received in stereo.
- If reception is poor and there is much noise in the stereo signals, press the BAND or MODE button to set the FM MONO mode.

**About the tuning mode and the preset mode**

- The function of the "-" and "+" buttons on the main unit can be switched so that they can be used for either tuning (selecting the reception frequency) or for selecting preset stations.

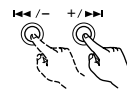

Main unit

- The buttons are set to the tuning mode upon shipment. The mode can be switched to the preset mode by pressing the "+" button while pressing in the BAND button. (When this is done, "PRESET" is flashes for approximately 5 seconds.)



Main unit

- Press the "-" button while pressing in the BAND button to switch to the tuning mode. (When this is done, "TUNING" is flashes for approximately 5 seconds.)

**(2) Presetting stations that have been tuned in and giving names to stations (remote control unit only)**

- A total of 40 stations (including both FM and AM stations) can be preset.
- Preset stations can be given names with up to 8 characters (letters, numbers and symbols).
- Preset stations using the including remote control unit.

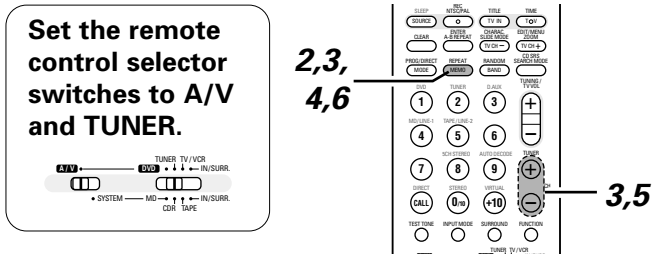

**1** Tune in the station you want to preset.

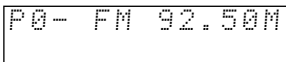

**2** Press the MEMO button twice in a row.  
 • The name input mode is set.

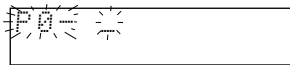

Remote control unit

**3** Use the "+" and "-" preset buttons to select the character, then press the MEMO button to input that character.



Remote control unit

- When the "+" TUNING button or the MEMO button is pressed, the selected character is entered, the cursor moves to the next position and the next character can be input.
- Use the "-" TUNING button to move back to the previous position. Use this to correct characters that have already been input.

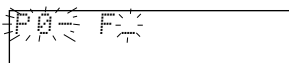
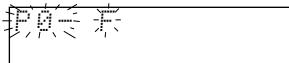

Remote control unit

**4** Press the MEMO button twice in a row to enter the station name you have input.

- The preset number indicator, "P", flashes.



Remote control unit

**5** Use the "+" and "-" preset buttons to select the preset number.

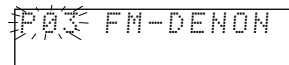

Remote control unit

- ※ The preset number can also be input directly using the +10 and 1 to 10 buttons on the numeric keypad.

**6** Press the MEMO button to enter the preset number.  
 • The preset number, band and reception frequency are displayed, then the station name appears.

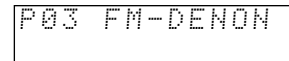
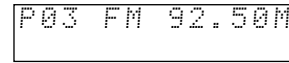

Remote control unit

- ※ To stop in the middle of the procedure, press the MODE button before pressing the MEMO button at step 4. Everything you have input is cleared.



- ※ To clear a station name that has been set in the memory, call out that station, set the name input mode in step 2, then press the MODE button. The station name is cleared and the preset channel frequency is displayed.

Remote control unit

- ※ If you only want to preset a station, press the MEMO button once while the station is tuned in. The preset number indicator, "P", flashes, and the preset number input mode is set. Use the "+" and "-" preset buttons to select the preset number then press the MEMO button again to store that station at the selected number. (The number can also be specified directly using the +10 and 1 to 10 buttons on the numeric keypad.)



Remote control unit



Remote control unit

### (3) Auto tuner presets

Use this to automatically search for FM broadcasts and store up to 40 stations at preset channels 1 to 40.

**NOTE:**

- If an FM station cannot be preset automatically due to poor reception, use the "Manual tuning" operation to tune in the station, then preset it using the manual "Preset memory" operation.

**1** Using the TUNER function, press and hold the MENU/SET button of the main unit for 2 seconds or longer.

- "AUTO PRESET?" and "-: NO/+ : START" will alternately appear on the display of the main unit.
- Press the TUNING - button to cancel.



MENU/SET  
Main unit

**2** Use the TUNING + button to select "START". "SEARCH" flashes on the display and searching begins. "COMPLETED" appears once searching is completed.



+ / >>>  
Main unit

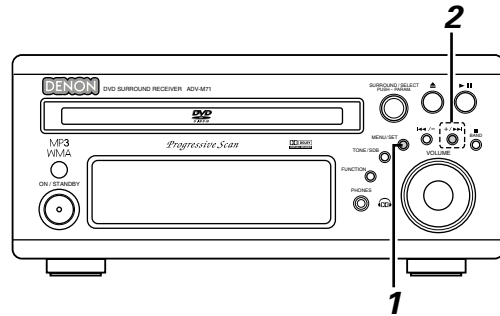

### (4) Listening to preset stations

Example: Listening to the station preset at number P03 (This operation is only possible from the remote control unit.)

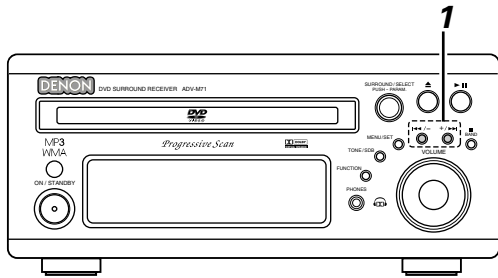

**1** Use the "+" and "-" preset buttons to select preset number "3" or press the "3" button on the numeric keypad to display preset number "P03".

- ※ The "+" and "-" buttons on the main unit can be selected when the preset mode has been set.

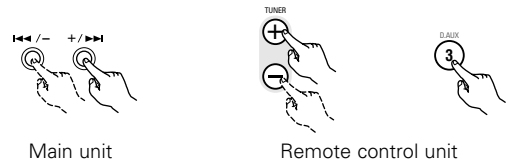

**Set the remote control selector switches to A/V and TUNER.**

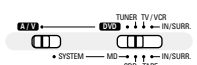
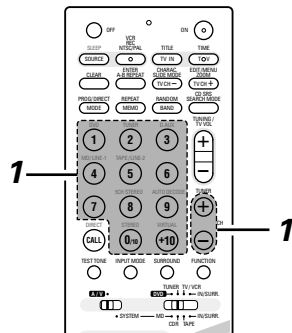
- ※ The functions of the "+" and "-" buttons on the main unit change according to whether the tuning or preset mode is set. When the tuning mode is set, you can switch to the preset mode by pressing the "+" button while pressing the BAND button.



- ※ The preset buttons on the remote control unit (TUNER CH "+" and "-") can be used at any time.



## 16 ON-SCREEN DISPLAY

The ADV-M71 is equipped with an on-screen display ("OSD") function that displays various types of information on the surround functions and the disc on the screen when the function is set to DVD.

### ① Setup screen

- This is used to select the speaker system being used (quick system setting) and to change the function of the ADV-M71 and various settings when playing discs (system setting change and DVD setting change).
- The setup screen can be used regardless of the currently set function.

### ② Display of disc information

- When the function is set to DVD, the OSD displays information on the disc and appears when various playback functions are operated.

### ③ Display of surround function

- When the function is set to DVD, information on the surround amplifier is also displayed and can be operated.

The OSD for the surround function (AV OSD) can be turned on and off.

(The OSD for the setup screen and DVD disc information cannot be set to "OFF".)

※ Set to "ON" upon shipment from the factory.

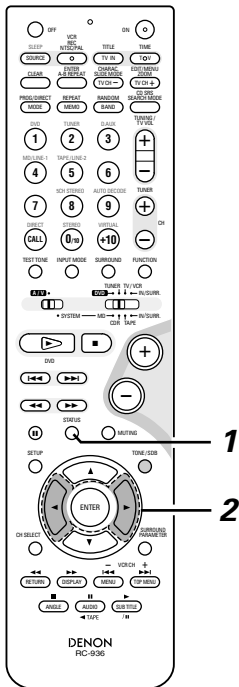
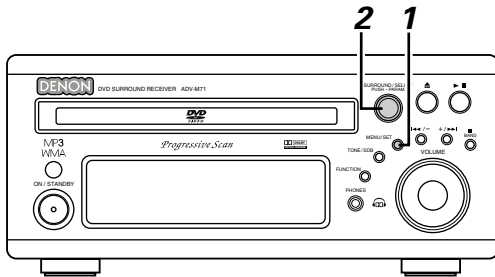

## 1

With the function set to DVD, press the STATUS button of the remote control for at least 2 seconds.

Press in the MENU/SET button on the main unit, then press the MENU/SET button again for at least 2 seconds while "STATUS" is displayed.

- "AV OSD ON ◀▶ OFF" is displayed.



Main unit



Remote control unit

## 2

Turn the AV OSD on or off.



Main unit

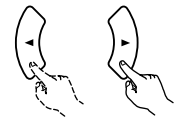

Remote control unit

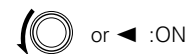

◀ : ON

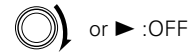

▶ : OFF

※ After several seconds, the display turns off and the setting is made.

### NOTES:

- Depending on the disc being played, the picture may be disturbed when the OSD turns on. This is not a malfunction. If this should happen, set the AV OSD to "OFF".
- The OSD is also output to the VCR video output terminals. Do not perform setup or OSD operations while recording with a video deck.

# 17 USING THE ON-SCREEN DISPLAY

## (1) Operating using the disc information OSD

- Use this function to display and change information on the disc (titles, chapters, time, etc.)

**Set the remote control selector switches to A/V and DVD.**

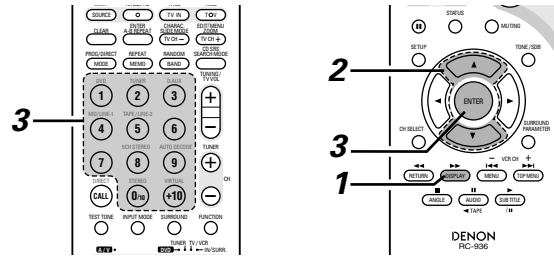
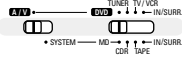

- In the play mode, press the DISPLAY button.
  - The On-Screen Display appears.
  - The picture on the TV screen switches each time the button is pressed.
  - The items displayed differ from disc to disc.



Remote control unit

**Example: For DVDs**

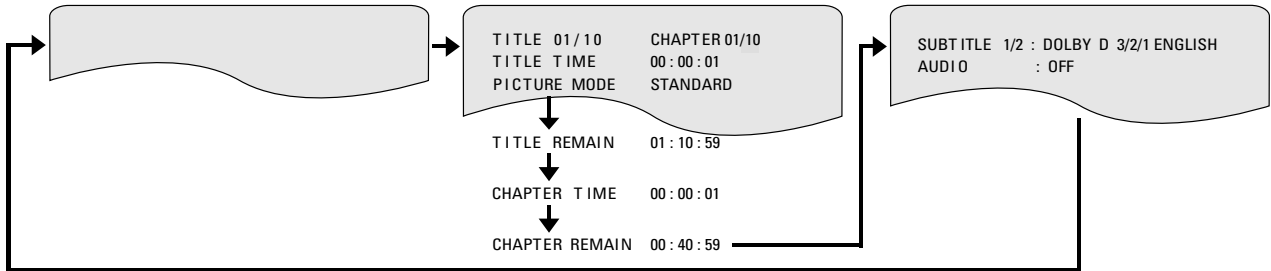

**Example: For video and music CDs**

- For the on-screen display for video CDs and music CDs, only the disc time changes.

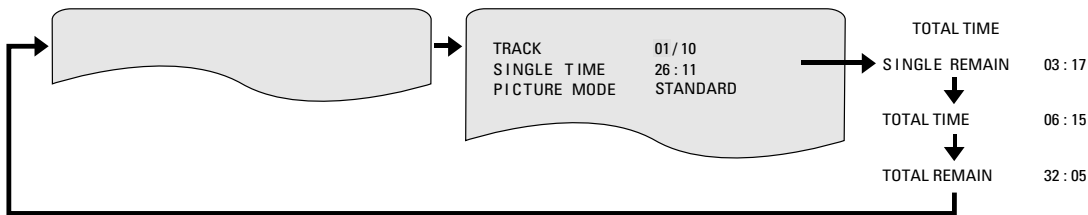

- Use the  $\blacktriangle$  and  $\blacktriangledown$  cursor buttons to select the item you wish to change.
  - The selected item is displayed with a yellow frame.

- For DVDs
  - "TITLE", "CHAPTER", "TITLE ELAPSED" can be selected.
- For video and music CDs
  - "TRACK" can be selected.



Remote control unit

- Changing the elapsed time
  - Input using the number buttons, then press the ENTER button.

Example: For 1 minute 26 seconds → "00126"

- Changing the title, track or chapter
  - For DVDs
    - Input using the number buttons, then press the ENTER button. (For some discs it is not possible to change the title or chapter.)
  - For video and music CDs
    - Input using the number buttons. Playback starts from that track.

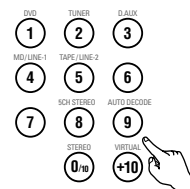

Remote control unit

## (2) Adjusting the picture quality

- The quality of the picture when playing discs can be adjusted.

**Set the remote control selector switches to A/V and DVD.**

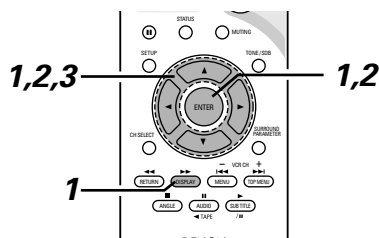

**1** When playing a disc with the function set to DVD, press the DISPLAY button to turn on the on-screen display, use the ▲ and ▼ cursor buttons to select "PICTURE MODE", then press the ENTER button.

- The picture quality adjustment screen appears.
- The on-screen display also turns on when the DISPLAY button is pressed in the stop mode.

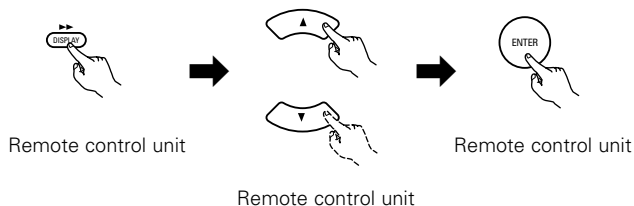

**2** Use the ◀ and ▶ cursor buttons to select the item, then press the ENTER button.

**Standard:**

Both the picture quality and functions are set back to the standard settings set upon shipment from the factory.

**Anime:**

This sets a brighter more vivid picture quality.

**Cinema:**

This sets a mellower picture quality.

**Memory 1 to 3:**

Picture quality settings you have adjusted can be stored at three memory positions. (Set at step 3)



**3** Selecting and adjusting the picture quality  
Use the ◀ and ▶ cursor buttons to select the picture quality item, then use the ▲ and ▼ cursor buttons to adjust the value.

- All the adjustments are stored in the memory.

**Contrast (-6 to +6) (factory default: 0):**

This adjusts the contrast between light and dark portions of the picture.

**Brightness (0 to +12) (factory default: 0):**

This adjust the brightness (vividness) of the picture.

**Color density (-6 to +6) (factory default: 0):**

This adjusts the color density.

**Hue (-6 to +6) (factory default: 0):**

This adjusts the balance between green and red. (This setting does not affect progressive scan outputs.)

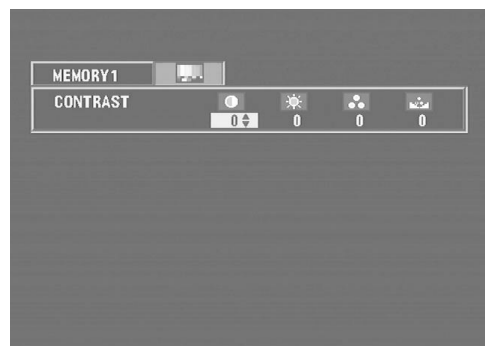
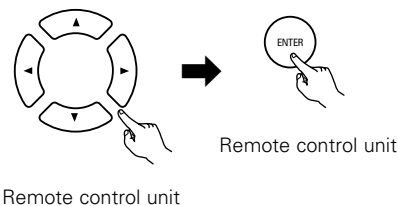

※ To complete the picture quality adjustment:  
Press the DISPLAY button again.

**NOTE:**

- Depending on the disc being played, the picture or sound may be disturbed when the on-screen display is displayed. This is not a malfunction.

### (3) Playing Repeatedly

■ Use this function to play your favourite audio or video sections repeatedly.

**Set the remote control selector switches to A/V and DVD.**

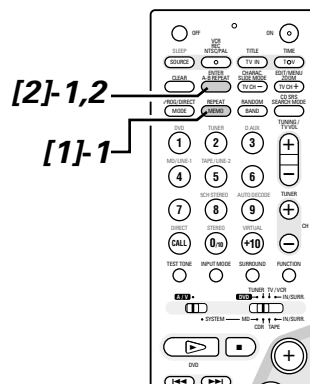
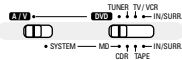

#### [1] Playing Repeatedly (Repeat Playback)

- 1** In the play mode, press the REPEAT button.
- The display on the TV screen switches each time the button is pressed, and the corresponding repeat play or stop mode is set.
  - ※ lights on the display when the repeat play mode is set. "ALL" lights when the all repeat play mode is set.



Remote control unit

① For DVDs

- Normal playback



- Chapter repeated



- Title repeated



- Repeat playback cancelled

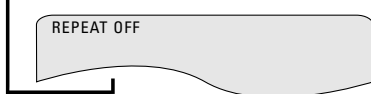

② For video and music CDs

- Normal playback



- Track repeated



- Entire disc repeated

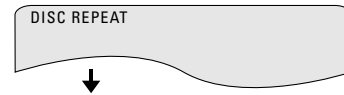

- Repeat playback cancelled



※ To return to normal playback:  
Return to normal playback by pressing the REPEAT button until "REPEAT OFF" appears on the TV screen.

**[2] Playing a Certain Section Repeatedly (A-B Repeat Playback)**

- 1** During playback, press the A-B REPEAT button.
- This sets start point A.

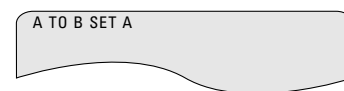

Remote control unit

- 2** Press the A-B REPEAT button again.
- This sets end point B, and repeat playback of the A-B section starts.



Remote control unit

※ To return to normal playback:

Press the A-B REPEAT button until "A TO B CANCELLED" appears on the TV screen.

**NOTES:**

- Repeat playback may not work for some DVDs.
- The repeat playback and A-B repeat playback functions will not work for DVDs and video CDs for which the elapsed time is not shown on the display during playback.
- In some cases, subtitles may not be displayed near the A and B points during A-B repeat playback.

## (4) Playing Tracks in the Desired Order

- Use this function with video and music CDs to play the tracks in the desired order.
- This function does not affect with DVD.

**Set the remote control selector switches to A/V and DVD.**

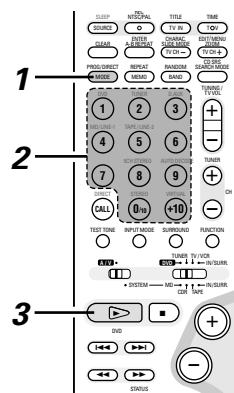
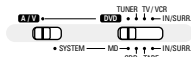

- 1 Press the PROG/DIRECT button once in the stop mode.
  - The program selection screen appears.

- 2 Use the number buttons to select the number you want to program.
  - Up to 20 tracks can be programmed.

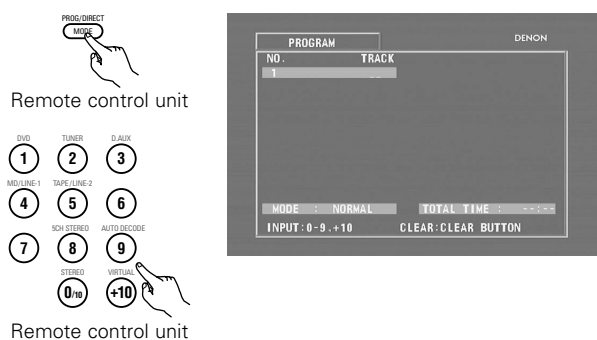

### Example: To program tracks 5 and 12

Press number button "5".

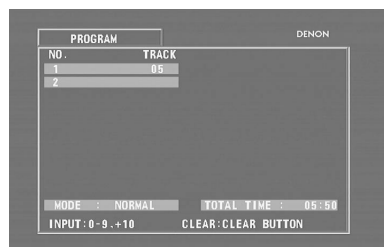

Press number button "+10".

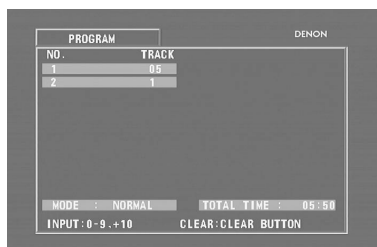

Press number button "2".

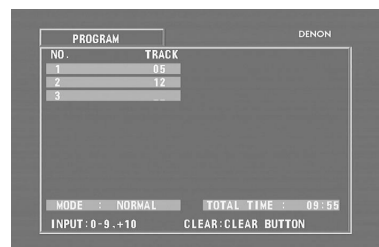

- 3 Press the play button.
  - The tracks start playing in the programmed order.



Remote control unit

- ※ To return to normal playback: Press the stop button to stop programmed playback, then press the PROG/DIRECT button. When the play button is next pressed, normal playback begins from the beginning of the disc.
- ※ Clearing individual tracks from the program: Press the stop button to stop programmed playback. Now press the CLEAR button to clear the last track programmed.
- ※ Clearing the entire program: The entire program is cleared when the power is turned off or the disc is unloaded. The entire program can also be cleared by pressing the stop button to stop programmed playback then pressing the PROG/DIRECT button.
- ※ Checking the programmed tracks: Press the CALL button to display the programmed tracks in steps.

## (5) Playing Tracks in the Random Order

- Use this function with video and music CDs to play the tracks in random order.
- This function does not affect with DVD.

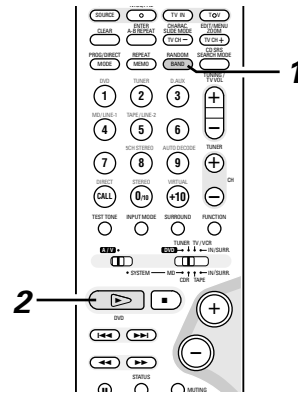
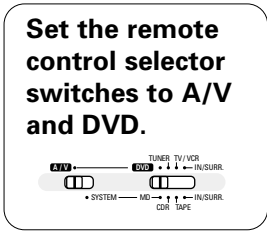

- 1** In the stop mode, press the RANDOM button.
- The random play screen appears.

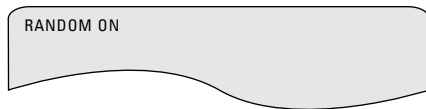

Remote control unit

- 2** Press the PLAY button.
- The tracks start playing in random order.



Main unit

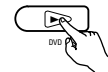

Remote control unit

- Random playback is not possible for some discs.
- ※ To return to normal playback:  
Press the STOP (■) button to stop random playback, then press the RANDOM button once.

## (6) MP3 WMA Playback

### [1] Listening to Recorded MP3 CD/CD-R/CD-RW

■ There are many music distribution sites on the internet from which music files in MP3 format can be downloaded. Music downloaded as instructed on the site and written onto a CD-R/RW disc can be played on the ADV-M71.

If music recorded on commercially available music CDs is converted on a computer into MP3 files using an MP3 encoder (conversion software), the data on a 12 cm CD is reduced into about 1/10 the amount of the original data. Thus, when written in MP3 format, the data of about 10 music CDs can fit onto a single CD-R/RW disc. A single CD-R/RW disc can contain over 100 tracks.

※ Values when 5-minute tracks are converted with a standard bit rate of 128 kbps into MP3 files and using a CD-R/RW disc with a capacity of 650 MB.

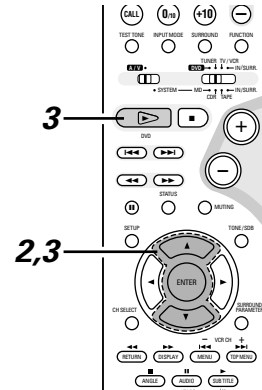
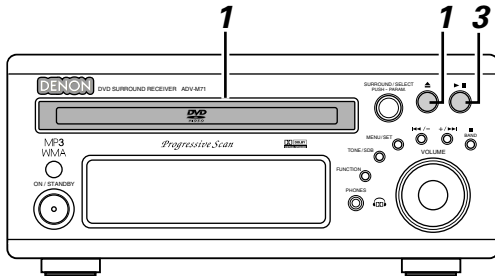

**1** Load the CD-R/RW disc on which the MP3 format music files have been written into this unit. (See page 39.)

- When the disc is loaded in the ADV-M71, the disc information screen appears.
- If there are multiple folders, proceed to step 2.
- If there are no folders on the disc (if the disc only contains MP3 files), proceed to step 3.

※ All the folders recorded on the disc are displayed. (The folders are not displayed by layer.)

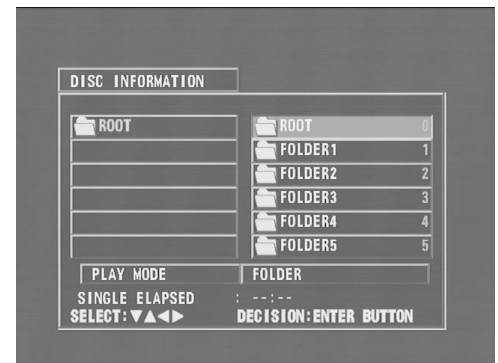

**2** Use the ▲ and ▼ cursor buttons to select the folder containing the file(s) you want to play, then press the ENTER button.

※ **To change the folder**

Use the ▲ cursor button to select "ROOT" at the upper right of the screen, then press the ENTER button. The screen in step 1 reappears. Select the desired folder.

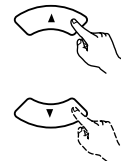

Remote control unit



Remote control unit

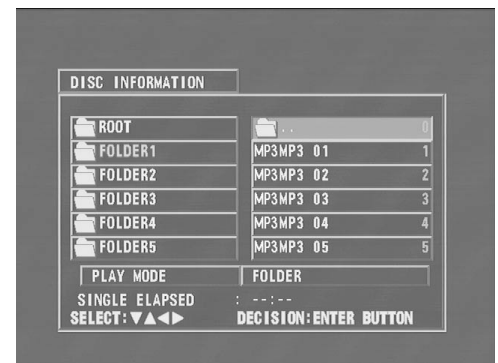



**3** Use the ▲ and ▼ cursor buttons to select the MP3 file you want to play, then press the PLAY (▶) button or ENTER button.

- Playback starts.

※ The display can be switched between the single elapsed time and the single remaining time by pressing the DISPLAY button.

※ Programmed playback is not possible with MP3 discs.

※ **To change the MP3 file**

Press the STOP button, then use the ▲ and ▼ cursor buttons to reselect the desired MP3 file.

※ **To set the random play mode**

In the stop mode, press the RANDOM button.

Then press the PLAY (▶) button or ENTER button.

※ **To set the repeat mode**

The repeat mode changes each time the REPEAT button is pressed.

NORMAL → TRACK REPEAT → FOLDER REPEAT



※ **To return to the initial disc information screen**

Press the STOP (■) button, use the ▲ cursor button to select "ROOT" at the upper right of the screen, then press the ENTER button.

The screen in step 1 reappears.

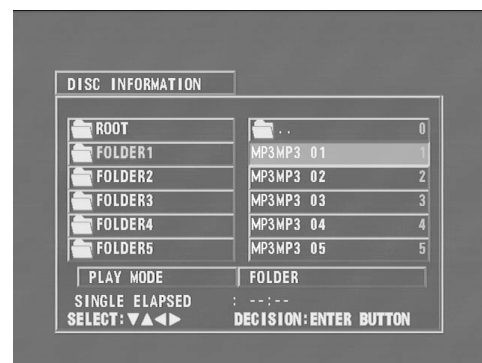
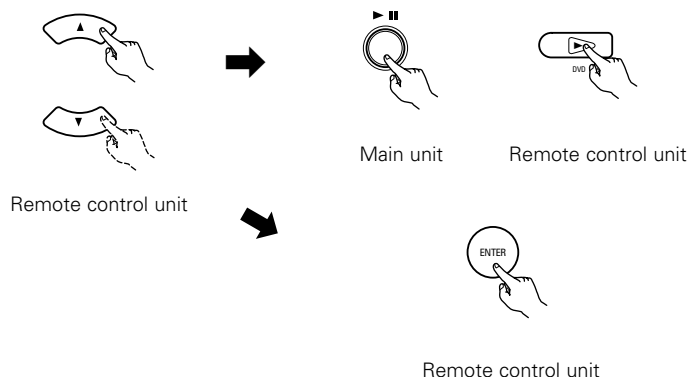

**NOTES:**

- The ADV-M71 is compatible with the "MPEG-1 Audio Layer 3" standards (sampling frequency of 32, 44.1 or 48 kHz). It is not compatible with such other standards as "MPEG-2 Audio Layer 3", "MPEG-2.5 Audio Layer 3", MP1, MP2, etc.
- It may not be possible to play some CD-R/RW discs due to disc properties, dirt, warping, etc.
- The digital signals output when playing MP3 files are MP3 signals converted into PCM, regardless of whether the audio output presenting is set to "normal" or "PCM conversion". The signals are output with the same sampling frequency as that of the music source.
- In general, the higher an MP3 file's bit rate, the better the sound quality. On the ADV-M71, we recommend using MP3 files recorded with bit rates of 128 kbps or greater.
- MP3 files may not be played in the expected order, since the writing software may change the position of the folders and the order of the files when writing them on the CD-R/RW.
- Manual search and programmed playback are not possible with MP3 discs.
- When writing MP3 files on CD-R/RW discs, select "ISO9660 level 1" as the writing software format. This may not be possible with some types of writing software. For details, refer to the writing software's usage instructions.
- With the ADV-M71 it is possible to display folder names and file names on the screen like titles. The ADV-M71 can display up to 11 characters, consisting of numbers, capital letters, and the "\_" (underscore) mark.
- If recorded in a format other than "ISO9660 level 1", normal display and playback may not be possible. In addition, folder and file names including other symbols will not be displayed properly.
- Be sure to add the extension ".MP3" to MP3 files. Files cannot be played if they have any extension other than ".MP3" or if they have no extension. (with Macintosh computers, MP3 files can be played by adding the extension ".MP3" after the file name consisting of up to 8 capital or numbers and recording the files on the CD-R/RW.)
- Do not apply stickers, tape, etc., to either the label side or the signal side of CD-R/RW discs. If adhesive gets on the surface of a disc, the disc may get stuck inside the ADV-M71 and be impossible to eject.
- The ADV-M71 is not compatible with packet write software.
- The ADV-M71 is not compatible with ID3-Tag.
- The ADV-M71 is not compatible with play lists.

**[2] Listening to Recorded WMA (Windows Media Audio) CD-R/CD-RW**

- This unit can play CD-R/RW music files that have been recorded in the WMA (Windows Media Audio)\* audio compression format.



Windows Media, and the Windows logo are trademarks, or registered trademarks of Microsoft Corporation in the United States and/or other countries.

- ※ WMA (Windows Media Audio): New audio coding of Microsoft Corporation (U.S.A.)
  - Uses of recordings you have made other than for your personal enjoyment are not permitted under the Copyright Law without permission of the copyright holder.
- The method of playback is the same as "[1] Listening to Recorded MP3 CD/CD-R/CD-RW" on Pages 72 and 73.
  - In the file display of the disc information screen, WMA files will be displayed with the "WMA" icon instead of the "MP3" icon. (Files for which the "WMA" icon is not displayed cannot be played.)

**NOTES:**

- Files recorded with a sampling frequency (fs) of 32, 44.1, and 48 kHz are supported.
- Programmed playback cannot be performed with WMA files.
- The digital output at the time of WMA file playback is converted to PCM regardless of the initial settings.
- Please use discs that have been recorded in conformity with the ISO 9660 level 1/level 2 CD-ROM file system. (Extended formats are excluded.)
- Copyright protected files cannot be played. Also note that depending on the writing software and conditions, playback might not be possible, or the files might not be displayed properly.
- Playback of the CD-R/RW might not be possible depending on the disc characteristics, soiling, scratches, and other factors.
- Bit rates of 64 k to 160 kbps are supported for WMA files that have an extension of ".wma" or ".WMA".
- This unit can display the folder names and file names on the screen. Up to 11 half-width alphanumeric upper case characters and symbols (including the underscore symbol) can be displayed.
- While in the stop condition, the DISPLAY button of the remote control can be used to switch and display the title names and the artist names. (One folder has a capacity of up to 99 files.)
- Recorded discs with no more than 99 files per folder are recommended. Multiple folder configurations are possible; however, depending on the configuration, playback of all the folders and files might not be possible.
- Multi-session discs and CD-R/RW that have not been finalized can also be played back; however, playback of discs that have had session closure within 10 sessions or have been finalized is recommended.
- Direct track selection using the remote control numerical keys (0 to 9, and +10) can specify up to 179 tracks (179 files) per folder. When 179 tracks are exceeded, while the unit is stopped use the cursor buttons at the disc information screen to select the files, and use the play button of the ENTER button to play.

**(7) Playing still picture files (JPEG format)**

- JPEG files stored on Kodak picture CDs, CD-Rs and CD-RWs can be played as a slide show and enjoyed on the ADV-M71.

**[1] Playing Kodak picture CDs/FUJICOLOR CDs**

- Playing Picture CDs and Fujicolor CDs

The ADV-M71 can play Kodak Picture CDs and Fuji Film Fujicolor CDs, so you can view the photographs stored on them on a TV screen. (Picture CDs and Fujicolor CDs are CDs containing photographs taken on conventional silver film cameras which have been converted into digital data. For details on Picture CDs, please contact a store providing Kodak development services. For details on Fujicolor CDs, please contact a store providing Fuji Film development services.)

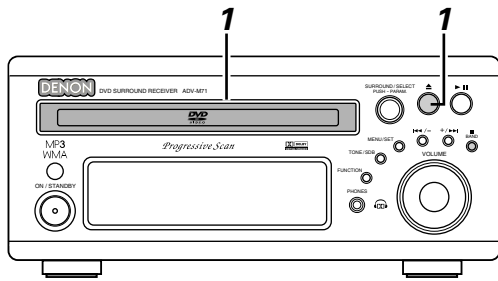

**Set the remote control selector switches to A/V and DVD.**

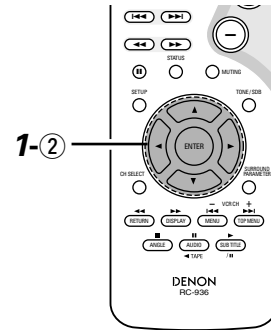

- 1** Load the Picture CDs or Fujicolor CDs into the set.
- For Picture CDs:  
Playback of the still pictures starts automatically when the disc is loaded.
  - For Fujicolor CDs:  
When the disc is loaded, up to 9 photos are automatically displayed on the screen. Use the remote control unit's cursor buttons (◀, ▶, ▲ and ▼) to select the photo you want to play, then press the ENTER button to start playback.

※ Press the stop button to stop playback.



Main unit

For Fujicolor CDs:

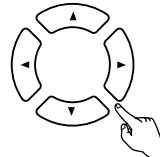

Main unit



Remote control unit

- "KODAK" is the registered trademark of Eastman kodak Co.
- "FUJICOLOR CD" is the registered trademark of Fuji Photo Film Co.,Ltd.

[2] Playing still pictures stored on CD-Rs/RWs

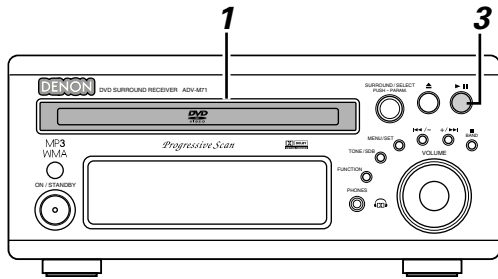

**Set the remote control selector switches to A/V and DVD.**

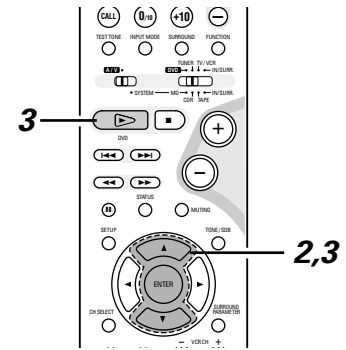

- 1** Load the CD-R/RW on which the still pictures have been written into the ADV-M71.
- When the disc is loaded in the ADV-M71, the disc information screen appears.
  - If there are multiple folders, proceed to step 2.
  - If there are no folders on the disc, proceed to step 3.

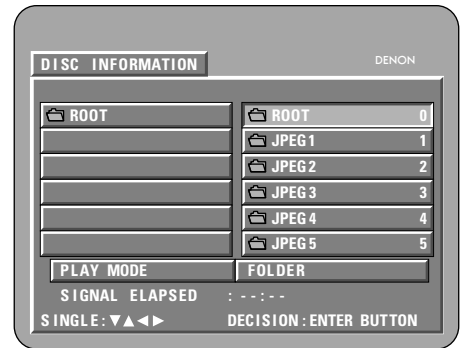

- 2** Use the ▲ and ▼ cursor buttons to select the folder containing the file(s) you want to play, then press the ENTER button.
- ※ **To change the folder**  
Use the ▲ cursor button to select "ROOT" at the upper right of the screen, then press the ENTER button. The screen in step 1 reappears. Select the desired folder.

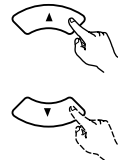

Remote control unit



Remote control unit

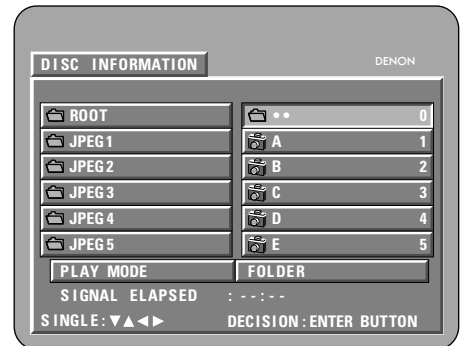

- 3** Use the ▲ and ▼ cursor buttons on the remote control unit to select the still picture file from which you want to start the slide show, then press the PLAY button or the ENTER button on the remote control unit.
- The slide show starts.
  - Only the still picture files in the selected folder are played.
- ※ Once all the still picture files in the folder have been played, the disc information screen reappears.

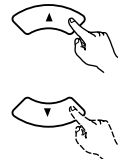

Remote control unit

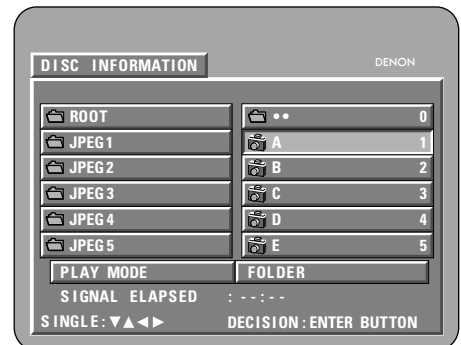

Main unit

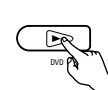

Remote control unit

- ※ To view several of the still pictures stored on the disc at once:
  - Press the STOP button to display up to 9 still pictures at once.
  - To select and view a still picture (to start the slide show from a specific still picture), use the cursor buttons (▼, ▲, ◀ and ▶) to select the desired still picture, then press the ENTER button.
- ※ To temporarily stop the slide show:
  - Press the PAUSE button.
  - To resume the slide show, press the PLAY button.
- ※ To cue a still picture you want to view (from which you want to start the slide show):
  - During the slide show, press one of the SKIP (I◀◀,▶▶I) buttons. Press the SKIP I◀◀ button to cue back to the previous still picture, the SKIP ▶▶I button to cue ahead to the next still picture.
- ※ Flipping and rotating still pictures:
  - Use the cursor buttons (▼, ▲, ◀ and ▶) to flip the still picture.
    - ▲ cursor button: The currently displayed still picture is flipped vertically.
    - ▼ cursor button: The currently displayed still picture is flipped horizontally.
    - ◀ cursor button: The currently displayed still picture is rotate 90° counterclockwise.
    - ▶ cursor button: The currently displayed still picture is rotate 90° clockwise.
- ※ Play the image in the zoom mode.
  - When the ZOOM button is pressed while playing a JPEG image ("ZOOM ON" is displayed on the screen at this time) zoom in and zoom out using the search keys.
    - (◀◀: zoom out, ▶▶: zoom in)
  - When the image is zoomed, use the cursor buttons (▼, ▲, ◀ and ▶) to move the zoomed picture.
  - Continuous playback (SLIDE SHOW) is not possible in the zoom mode.
- ※ The way of switching to the next image during continuous JPEG image playback (SLIDE SHOW) can be selected.
  - Press the SLIDE MODE button on the remote control unit.
  - Select from SLIDE SHOW MODE 1 to MODE 11, MODE RAND and MODE NONE.

#### Special play modes for MP3/WMA and JPEG files

Use the ◀ and ▶ cursor buttons to select the play mode, the ▲ and ▼ cursor buttons to select the special play mode.

- FOLDER (the MP3/WMA and JPEG files in the folder are played in order starting from the selected file)
- FOLDER REPEAT (all the MP3/WMA and JPEG files in the folder are played repeatedly starting from the selected file)
- DISC (all the MP3/WMA and JPEG files on the disc are played in order starting from the selected file)
- DISC REPEAT (all the MP3/WMA and JPEG files on the disc are played repeatedly starting from the selected file)
- RANDOM ON (all the MP3/WMA and JPEG files in the folder are played in random order starting from the selected file)
- TRACK REPEAT (the select MP3/WMA or JPEG file is played repeatedly)

#### NOTES:

- The ADV-M71 is compatible with image data stored in JPEG format, but Denon does not guarantee that all image data stored in JPEG format can be viewed.
- Pictures with resolutions of up to 2048 x 1536 pixels can be displayed.
- It may not be possible to play some CD-Rs/RWs due to disc properties, dirt, scratches, etc.
- When storing JPEG files on the CD-R/RW, set the writing program to store the files in the "ISO9660 level 1" format.
- Be sure to give JPEG files the extension ".JPG" and ".JPE". Files with other extensions or with no extensions cannot be viewed on the ADV-M71.
- Do not apply stickers, tape, etc., to either the label side or the signal side of CD-R/RW discs. If adhesive gets on the surface of a disc, the disc may get stuck inside the ADV-M71 and be impossible to eject.
- Do not play CD-R/RW discs containing any files other than music CD files (in CDA format), MP3/WMA and JPEG files. Doing so may result in malfunction or damage, depending on the type of file.
- JPEG files written using Macintosh computers cannot be played.

## (8) Using the Multiple Audio, Subtitle and Angle Functions

### [1] Switching the Audio Language (Multiple Audio Function)

- With DVDs containing multiple audio language signals, the audio language can be switched during playback.

**Set the remote control selector switches to A/V and DVD.**

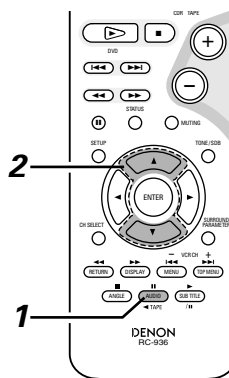
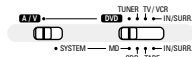

- 1** During playback, press the AUDIO button.
- The current audio language number is displayed.



AUDIO 1/3:DOLBY D3/2/.1 ENG

Remote control unit

- 2** Use the ▲ and ▼ cursor buttons to select the desired language.
- The display turns off when the AUDIO button is pressed.



AUDIO 2/3:DOLBY D3/2/.1 FRA

Remote control unit

#### NOTES:

- With some discs it is not possible to change the audio language during playback. In such cases, select from the DVD menu. (See page 93.)
- If the desired language is not set after pressing the ▲ and ▼ cursor buttons several times, the disc does not include that language.
- The language selected in the default settings is set when the power is turned on and when the disc is replaced.

**[2] Switching the Subtitle Language (Multiple Subtitle Function)**

■ With DVDs containing multiple subtitle language signals, the subtitle language can be switched during playback.

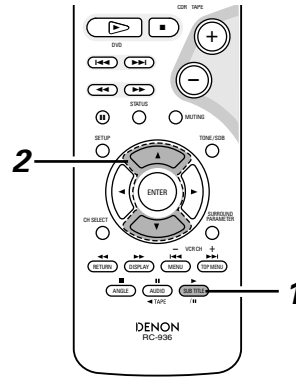
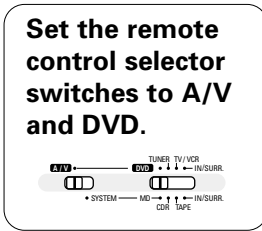

- 1** During playback, press the SUBTITLE button.
- The current subtitle language number is displayed.

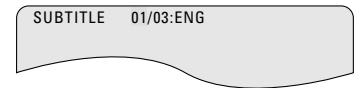

Remote control unit

- 2** Use the ▲ and ▼ cursor buttons to select the desired language.
- The display turns off when the SUBTITLE button is pressed.

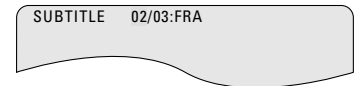
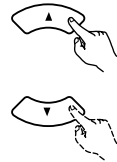

Remote control unit

**NOTES:**

- If the desired language is not set after pressing the ▲ and ▼ cursor buttons several times, the disc does not include that language.
- The subtitle language set with the default settings is set when the power is turned on and when the disc is replaced. If that language is not included on the disc, the disc's default language is set.
- When the subtitle language is changed, several seconds may be required for the new language to appear.
- When a disc supporting the closed caption is played, the subtitle and the closed caption may overlap each other on the TV monitor. In this case, turn the subtitle off.

**[3] Switching the Angle (Multiple Angle Function)**

■ With DVDs containing multiple angle signals, the angle can be switched during playback.

**Set the remote control selector switches to A/V and DVD.**

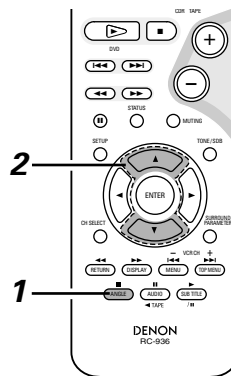

- 1** During playback, press the ANGLE button.
- The current angle number is displayed.

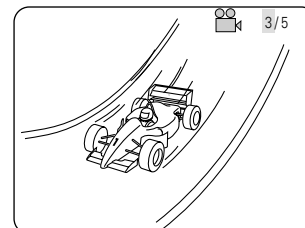
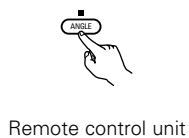

- 2** Use the ▲ and ▼ cursor buttons to select the desired angle.
- The display turns off when the ANGLE button is pressed.

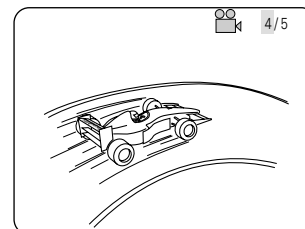
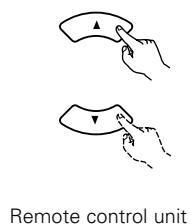

**NOTES:**

- The multiple angle function only works with discs on which multiple angles are recorded.
- At scenes where multiple angles are recorded, the angle can be switched.



## (9) Using the Menus

### [1] Using the Top Menu

■ For DVDs containing multiple titles, the desired title can be selected and played from the top menu.

**Set the remote control selector switches to A/V and DVD.**

The diagram shows two selector switches. The first switch is labeled 'TUNER TV/VCR' and has 'A/V' selected. The second switch is labeled 'IN-SURR.' and has 'DVD' selected.

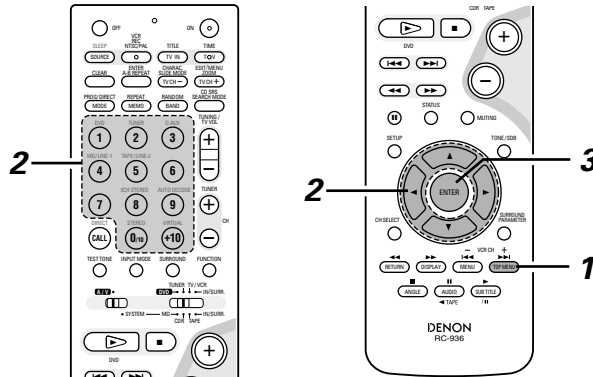

- 1** During playback, press the TOP MENU button.
- The top menu appears.

Example:



Remote control unit

**TOP MENU**

Apple	Banana
Orange	Strawberry
Peach	Pineapple

- 2** Use the cursor or number buttons to select the desired title.
- If you select the title number using the number buttons, skip step 3 below.

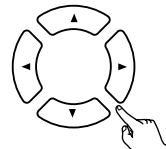

Remote control unit

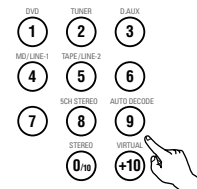

Remote control unit

Example:  
When "Orange" is selected

**TOP MENU**

Apple	Banana
<b>Orange</b>	Strawberry
Peach	Pineapple

- 3** Press the ENTER button.
- Playback starts.
  - Playback also starts if the PLAY (▶) button is pressed.



Remote control unit

**[2] Using the DVD Menu**

■ Some DVDs include special menus called DVD menus.

For example, DVDs with complex contents may contain guide menus, and DVDs with multiple languages may contain audio and subtitle language menus.

These menus are called "DVD menus".

Here we describe the general procedure for using DVD menus.

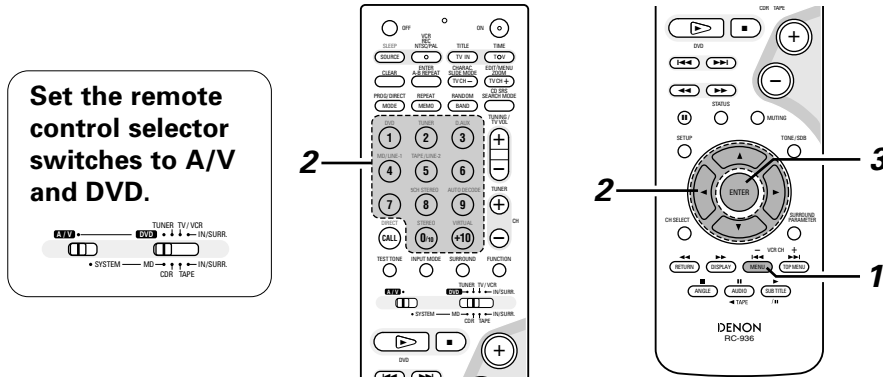

- 1** During playback, press the MENU button.
- The DVD menu appears.

Example:



Remote control unit

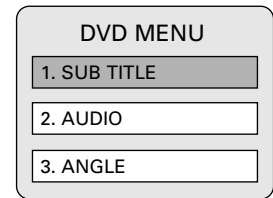

- 2** Use the cursor or number buttons to select the desired item.
- If you select the item using the number buttons, skip step 3 below.

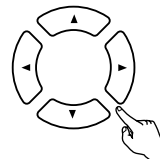

Remote control unit

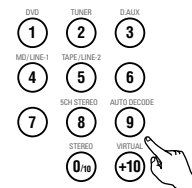

Remote control unit

Example:  
"AUDIO" is selected



- 3** Press the ENTER button.
- The selected item is set.
  - If more menus appear, repeat steps 2 and 3.



Remote control unit

**(10) Playing in the zoom mode**

**Set the remote control selector switches to A/V and DVD.**

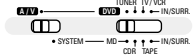

TUNER TV/VCR  
 IN-SURR  
 SYSTEM SD IN-SURR CDR TAPE

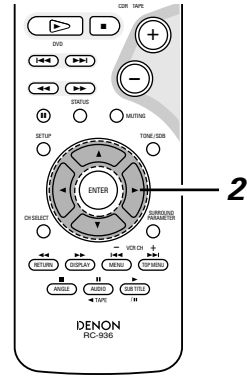
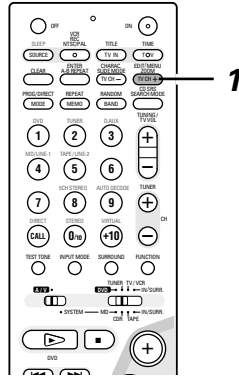

- 1** In the play or pause mode, press the ZOOM button.
- The zoom rate increases each time the ZOOM button is pressed.
- For DVD video discs and video CDs:  
 OFF → x1.5 → x2 → x4 → OFF



Remote control unit

- 2** Use the cursor buttons (▼, ▲, ◀ and ▶) to move the zoomed picture.

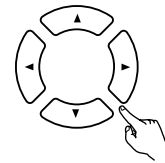

Remote control unit

**NOTES:**

- Zooming is not possible with some discs.
- The zoom function may not work properly at some scenes.
- Zooming is not possible at the top menu or the menu screen.

## 18 USING THE TIMER

■ Timer and system operations are possible once the setup procedure has been completed.

### (1) Setting the clock (12-hour display)

Example: Setting the current time to "7:30 p.m."

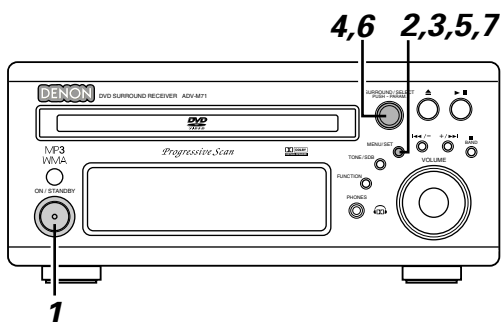

**1** Turn on the power.



Main unit

**2** Press the MENU/SET button to display "Time".

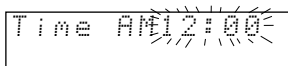

Main unit

- If the time has not yet been set or if there has been a power shortage, the time display flashes.
- If the time has been set, the current time is displayed.

**3** Press the MENU/SET button and hold it in for over 2 seconds.

- The hours position flashes.

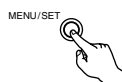
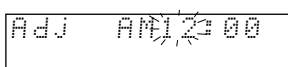

Main unit

**4** Turn the SURROUND/SELECT knob to set the hours.

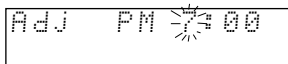

Main unit

**5** Press the MENU/SET button.

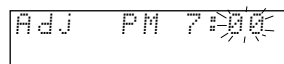

Main unit

**6** Turn the SURROUND/SELECT knob to move to the minutes position.

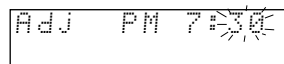

Main unit

**7** Press the MENU/SET button at the sound of a time signal, etc.

- The "30" in the minutes place stops flashing and the current time is displayed.

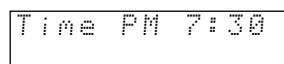

Main unit

- ※ To check the current time when the regular display is displayed, press the MENU/SET button once. The current time remains displayed until some other operation is performed.
- ※ The time can be displayed by pressing the MENU/SET button when the power is in the standby mode. (When this is done, the set is no longer in the low power consumption standby mode.) When pressed twice while the time is displayed, the display turns off and the set is put back in the low power consumption standby mode.
- ※ The current time can also be set when the power is in the standby mode by pressing the MENU/SET button to display the time then performing steps 3 to 7.
- ※ The clock runs by synchronizing with the power supply frequency. The time may be off by 2 to 3 minutes per month. If so, reset the time.

### Before setting the timer

- Be sure to set the current time. If the current time is not set, the timer standby indicator does not light and the timer will not function.
- Be sure to preset the broadcast station before setting the timer. (See page 63.)
- Everyday timer: The power is switched on and off (standby) once at the same time each day.  
Once timer: The power is switched on and off (standby) at the specified time once only.  
Sleep timer: The power can be set to turn off in 120 minutes, 90 minutes, or between 60 and 10 minutes in 10 minute steps.
- If the times set for the everyday timer, once timer and sleep timer overlap, the sleep timer has priority. The once time has priority if the everyday timer and once timer times overlap.
- It is not possible to set the timer start and stop times to the same time.

**(2) Setting the everyday timer and once timer**

- Be sure to set the current time before setting the timer. (See page 84.)
- Use the everyday timer to switch the power on and off (standby) once at the same time each day.  
Use the once timer to switch the power on and off (standby) at the specified time once only.
- With the ADV-M71 it is possible to play the tuner, a DVD or a CD with the timer.
- It is possible to play a DVD, CD, tape, the tuner, MD or the device connected to the AUX terminals with the timer and to record the tuner or the device connected to the AUX terminals onto an MD recorder or cassette deck using the timer.
- ※ Timer playback is not possible for some DVDs. (Most DVDs stop at the menu screen.)

Example 1: Listening to preset station "3" (FM 92.5 MHz) from p.m.12:35 to p.m.12:56 with the everyday timer

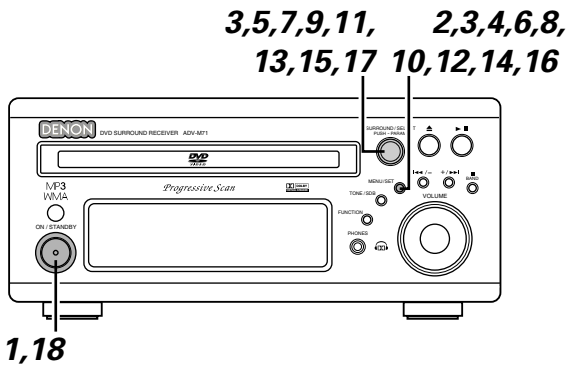

**1** Turn on the power.



Main unit

**2** Press the MENU/SET button to display "TIMER".

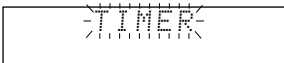

Main unit

**3** Turn the SURROUND/SELECT knob to display "EVERYDAY", then press the MENU/SET button.

- The display switches as follows each time the SURROUND/SELECT knob is turned:

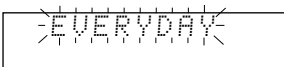

Main unit

- ※ The display switches as follows each time the SURROUND/SELECT knob is turned:

ONCE ↔ EVERYDAY



Main unit

**4** Press the MENU/SET button.

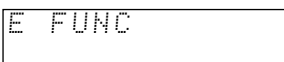

Main unit

**5** Turn the SURROUND/SELECT knob and set the function to "TUNER".

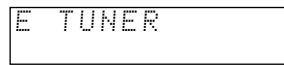

Main unit

- ※ The function switches as shown below each time the surround button is pressed. Functions marked "\*" differ according to whether "LINE-1" or "LINE-2" is set.

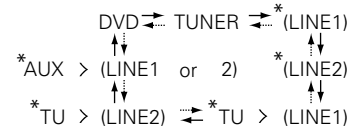

- :Clockwise turn
- ← :Counterclockwise turn

**6** Press the MENU/SET button.



Main unit

**7** Turn the SURROUND/SELECT knob and select preset number "P03".

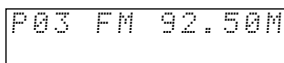

Main unit

- 8** Press the MENU/SET button.
- The data for the selected station is stored in the memory and the unit is set to the timer start time setting mode.
- "E" and "on" are displayed.

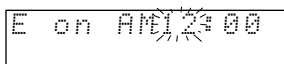

Main unit

**9** <Setting the timer start time>  
Turn the SURROUND/SELECT knob to set the hours place to "PM12".

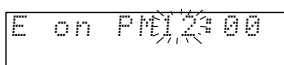

Main unit

- 10** Press the MENU/SET button.
- The "PM12" in the hours place is stored in the memory.

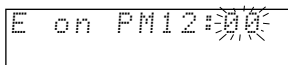

Main unit

- 11** Turn the SURROUND/SELECT knob and set the minutes place to "35".

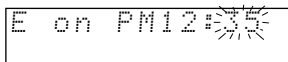

Main unit

- 12** Press the MENU/SET button.
- The start time is stored in the memory and the unit is set to the timer stop time setting mode.
  - "E" and "off" light.

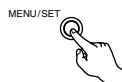
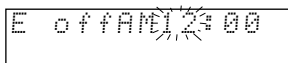

Main unit

- 13** <Setting the timer stop time>  
Turn the SURROUND/SELECT knob to set the hours place to "PM12".

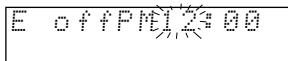

Main unit

- 14** Press the MENU/SET button.
- The "PM12" in the hours place is stored in the memory.

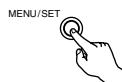
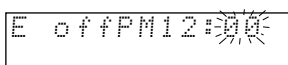

Main unit

- 15** Turn the SURROUND/SELECT knob and set the minutes place to "56".

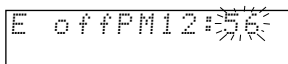

Main unit

- 16** Press the MENU/SET button.
- The stop time is stored in the memory.



Main unit

- 17** Turn the SURROUND/SELECT knob to display "Eon".
- The everyday timer is turned on and the timer standby indicator ☹ lights. This completes the setting of the timer.



Main unit

For more details, see "Turning the everyday timer and once timer on and off" on page 85.

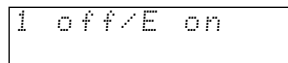

- 18** Turn off the power.
- The standby mode is set. (The power indicator turns orange.)
  - When the timer start time is reached, the timer operates.



Main unit

※ If you make a mistake when setting the timer

- Press the stop button at any point between steps 4 and 15. (The display returns to as it was in step 3.)
- Press the MENU/SET button repeatedly to display the item you want to correct, then correct the item.
- After correcting the item, press the MENU/SET button again repeatedly to proceed to step 18 and complete the setting of the timer.



Main unit

**NOTE:**

- The timer standby indicator ☹ does not light if the current time has not been set. Set the current time before setting the timer. (See page 84.)

Example 2: Listening to a CD with the once timer

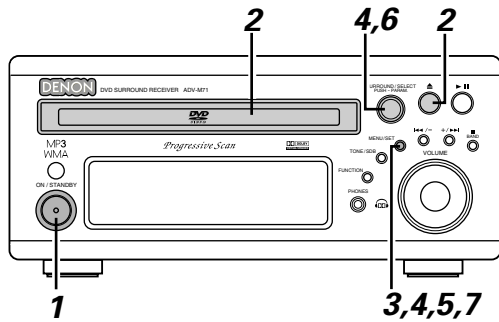

**1** Turn on the power.

Main unit

**2** Open the disc holder, load the CD, then close the disc holder.

Main unit

**3** Press the MENU/SET button to display "TIMER".

Main unit

**4** Turn the SURROUND/SELECT knob to display "ONCE", then press the MENU/SET button.

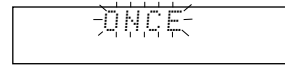

※ The display switches as follows each time the SURROUND/SELECT knob is turned:

ONCE ↔ EVERYDAY

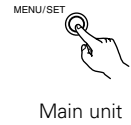

**5** Press the MENU/SET button.

- The once timer time setting mode is set.
- "1" (once) lights.

Main unit

**6** Turn the SURROUND/SELECT knob and set the function to "DVD".

Main unit

**7** Press the MENU/SET button.

- Timer function, "DVD", is stored in the memory.

Main unit

**8** Now follow steps 9 to 18 under "Setting the everyday timer and once timer" (pages 85 and 86).

- "1" and "on" light when setting the start time.
- "1" and "off" light when setting the stop time.
- Turn the once timer on at step 17.

- Timer playback and recording can be performed when system connections are made between the ADV-M71 and the D-M31 series cassette deck (DRR-M31). (Both the everyday and once timer can be used.)
  - Timer playback of the cassette deck (when TAPE is set for LINE-2)
  - Timer playback of the device connected to the AUX input terminals (when AUX is set for LINE-1 or LINE-2)
  - Timer recording of radio programs from the ADV-M71 onto the cassette deck (when TAPE is set for LINE-1)
  - Timer recording from the device connected to the AUX input terminals onto the cassette deck (when AUX is set for LINE-1 and TAPE is set for LINE-2)
- ※ Timer recording onto the device connected to the AUX input terminals is not possible. The timer function changes automatically according to the function set for LINE-1 and LINE-2.

**NOTE:**

- For timer recording and playback using the device connected to the AUX input terminals, note that the ADV-M71 cannot control the power of the device or playback operations on it. Make the settings accordingly.

### (3) Turning the everyday timer and once timer on and off

- After the timer has been set using the procedure described under “(2) Setting the everyday timer and once timer” (pages 85 to 86), turn the everyday timer and/or once timer on so that the set operations will be performed.

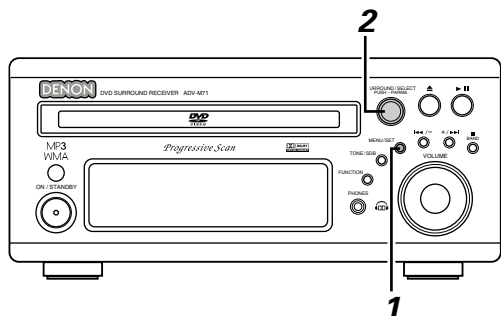

**1** Press the MENU/SET button to set the timer standby setting mode.

- The current settings are displayed.

1 on/E on



Main unit

**2** Turn the SURROUND/SELECT knob and select the timer to be operated.

- The display switches as follows each time the SURROUND/SELECT knob is turned:



Main unit

1 on/E on	Both the once timer and everyday timer are activated.
↓	
1 off/E on	Only the everyday timer is activated.
↓	
1 on/E off	Only the once timer is activated.
↓	
1 off/E off	Neither the once timer nor the everyday timer are activated.

- When either the once or everyday timer is activated, the timer standby indicator lights. The display returns to normal about 4 seconds after the timer standby indicator is displayed.

※ The timer operation is performed when the SURROUND/SELECT knob has been turned and the timer standby indicator has been lit.

※ If you do not want the timer to operate, turn the SURROUND/SELECT knob to turn the timer standby indicator off.



Main unit

- If only the once timer is set, the setting changes as shown below each time the SURROUND/SELECT knob is turned.

1 on/E off ↔ 1 off/E off



Main unit

- If only the everyday timer is set, the setting changes as follows:

1 off/E on ↔ 1 off/E off

**NOTES:**

- The timer standby indicator does not light if the current time has not been set. Set the current time before setting the timer. (See page 84.)
- If the times set for the everyday timer and once timer overlap, the once time has priority.
- Be sure to set the power to the standby mode when you want the timer to operate.



#### (4) Everyday timer and once timer priority

- If the times set for the everyday timer and once timer overlap, the once time has priority.

#### (5) About the everyday timer and once timer

##### ■ Checking the timer settings

- Use the same procedure as when setting the timer to check the timer settings.
  - ① Press the MENU/SET button to display "TIMER".
  - ② Turn the SURROUND/SELECT knob to display "EVERYDAY" or "ONCE".
  - ③ The display switches between the set function, start time, stop time and timer standby indicator each time the MENU/SET button is pressed.
  - ④ The display returns to as it was before the everyday timer or once timer was set about 4 seconds after the timer standby indicator is displayed.

##### ■ Changing the timer settings

- Reset the timer from the start using the desired settings.  
The new settings overwrite the previous settings.
- To change a setting during the process of setting the timer, press the stop button (■) to return to the "EVERYDAY" or "ONCE" display, then redo the operation from there.

##### ■ Clearing the timer settings

- ① Press the MENU/SET button to display "TIMER".
- ② Turn the SURROUND/SELECT knob to display "EVERYDAY" or "ONCE" (the timer whose settings you want to clear).
- ③ While "EVERYDAY" or "ONCE" is displayed, press the stop button (■) and hold it in for at least 2 seconds. Those timer settings are cleared.

##### ■ Quitting the timer setting (turning the operation of the timer off)

- Operate as described under "(3) Turning the everyday timer and once timer on and off" (page 85) and change the setting to the mode in which neither the once timer nor the everyday timer are activated ("1off/Eoff").

##### ■ If there is a power failure)

- If there is a power failure or the power cord is unplugged from the power outlet, the time display flashes when the power comes back on.  
Reset the current time.
- The once timer settings are deleted. Remake the settings.
- If the everyday timer settings and the tuner presets have been deleted, reset them.

**(6) Setting the sleep timer (remote control unit only)**

- The included remote control unit can be used to turn the power to the standby mode after a maximum of 120 minutes. (Sleep timer)
- Use this function to automatically switch the power to the standby mode after a specific amount of time (minutes).

Example: To set the power to the standby mode in 50 minutes according to the clock. Be sure to correct the current time setting.

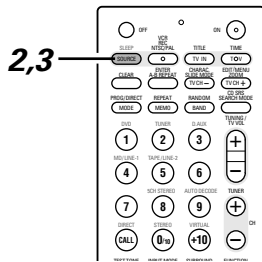
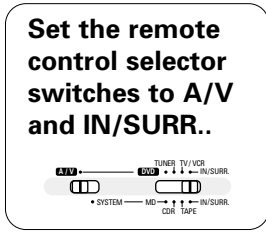

**1** Select and play the desired function.

**2** Press the SLEEP button.

- "120" is displayed and the "SLEEP" indicator flashes.

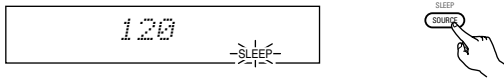

Remote control unit

※ The display switches as follows each time the SLEEP button is pressed:

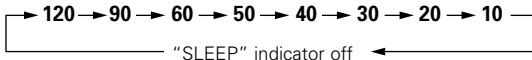

**3** When the "SLEEP" indicator is flashing, press the SLEEP button again until "50" is displayed.

- "50" is displayed and the "SLEEP" indicator flashes.

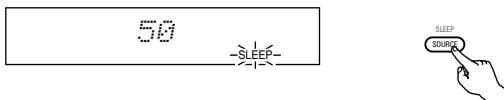

Remote control unit

- After 4 seconds, the display returns to as it was before the sleep timer was set, and the "SLEEP" indicator stops flashing, remaining lit. (This completes the sleep timer setting.)

**4** The power is set to the standby mode 50 minutes later.

※ To turn the sleep timer off, press the SLEEP button repeatedly until the "SLEEP" indicator turns off. The sleep timer can also be turned off by press the power button on the main unit or the remote control unit to turn the entire system's power to the standby mode.



Remote control unit



Main unit



Remote control unit

**NOTES:**

- If the SLEEP button is pressed while the sleep timer is operating, the setting returns to 120 minutes. Make the setting over.
- If the sleep timer and everyday timer settings overlap, the sleep timer has priority.

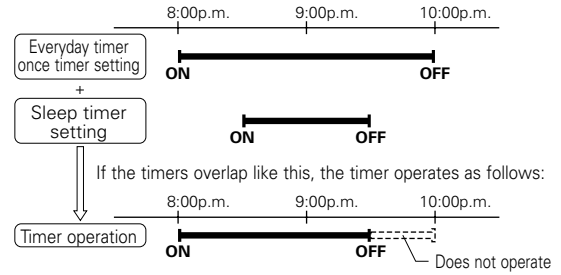

- Also, the everyday timer will not operate if its start time is set within the time during which the sleep timer is operating.

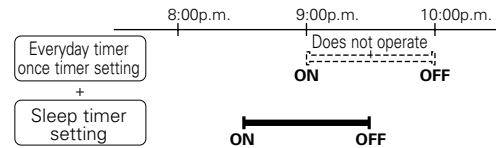

- The remaining time of the sleep timer can be checked with the STATUS button.

## 19 CHANGING THE DEFAULT SETTINGS (DVD)

- The initial setting that was set prior to shipping from the factory can be changed.  
The setting contents are maintained until they are next changed even when the power is switched off.

- 1 In the stop mode, press the SETUP button.  
At the Setup Menu, use the ▲ and ▼ cursor buttons to select "DVD SETUP" and press the ENTER button.

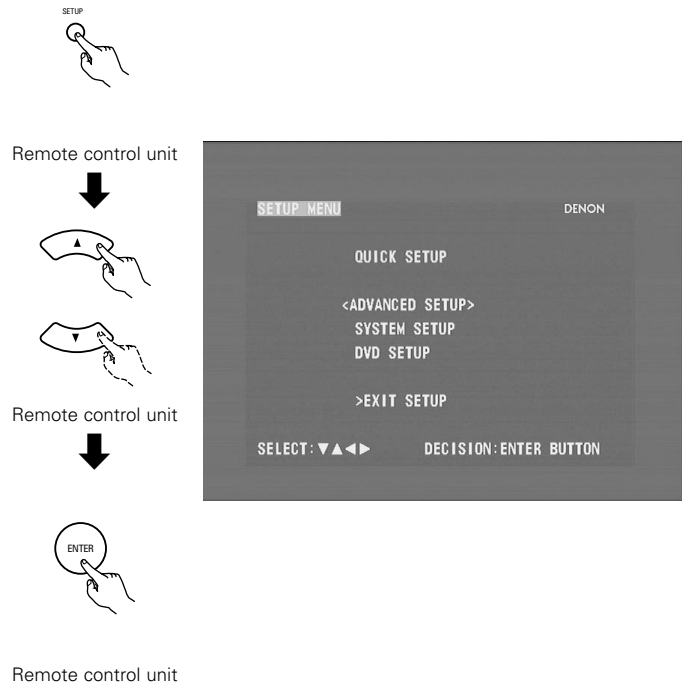

- 2 The setup (default settings) screen "DVD SETUP MENU" appears.

- **DISC SETUP**  
Use this to set the language to be used when playing the disc.  
If the set language is not offered on that disc, the discs default language is set.
- **OSD SETUP**  
Use this to set the wall paper color.
- **VIDEO SETUP**  
Use this to set this unit screen mode.  
(TV aspect and TV type.)
- **AUDIO SETUP**  
Use this to set this unit audio output mode.  
(Digital and LPCM output settings.)
- **RATINGS**  
Use this to disable playback of adult DVDs so that children cannot watch them. Note that playback of adult DVDs cannot be disabled if the rating level is not recorded on the DVD, but that it is possible to disable playback of all DVDs.
- **OTHER SETUP**  
Closed captions (subtitles) and the time interval for playing still pictures can be set.

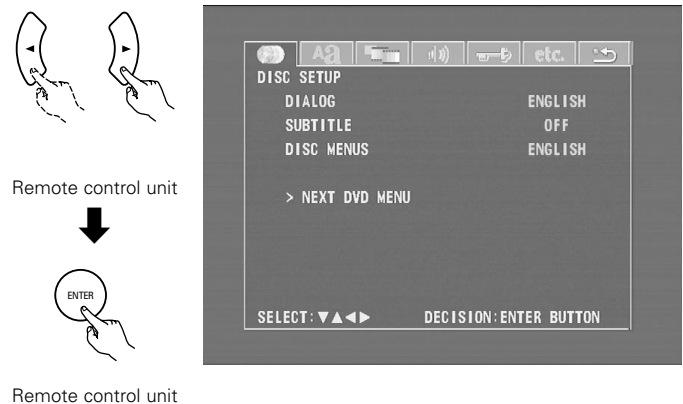

Use the ◀ and ▶ cursor buttons to select the desired setting item, then press the ENTER button.

※ **To exit the DVD setup mode**

Use the ◀ and ▶ cursor buttons to select "EXIT SETUP", then press the ENTER button. It is also possible to quit by pressing the SETUP button on the remote control unit.

**(1) "DISC SETUP" is selected****1**

See page 91.

**2****3**

Use the ◀ and ▶ cursor buttons to select the "DISC SETUP", then press the ENTER button.

- **DIALOG**

Use this to set the language of the sound output from the speakers.

- **SUBTITLE**

Use this to set the language of the subtitles displayed on the TV.

- **DISC MENUS**

Use this to set the language of the menus recorded on the disc (top menu, etc.).

※ **To exit the disc setup mode**

Use the ▲ and ▼ cursor buttons to select "> NEXT DVD MENU", then press the ENTER button.

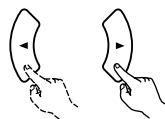

Remote control unit



Remote control unit

**4**

Use the ▲ and ▼ cursor buttons to select the desired setting, then press the ENTER button.

■ **When "DIALOG" is selected:**

- **ENGLISH (Factory default)**

Select this when you want to play the DVD with the sound in English.

- **FRENCH**

Select this when you want to play the DVD with the sound in French.

- **SPANISH**

Select this when you want to play the DVD with the sound in Spanish.

- **GERMAN**

Select this when you want to play the DVD with the sound in German.

- **JAPANESE**

Select this when you want to play the DVD with the sound in Japanese.

- **OTHERS**

The sound is played in the language input with the number buttons. (See the table of language numbers on page 94.)



Remote control unit



Remote control unit



# 4

※ **To exit the dialog mode**  
Press the ENTER button, you can go back to the previous screen.

■ **When “SUBTITLE” is selected:**

- **OFF (Factory default)**  
Select this if you do not want to display the subtitles. (For some discs it is not possible to turn off the subtitle display.)
- **ENGLISH**  
Select this when you want to play the DVD with the subtitles in English.
- **FRENCH**  
Select this when you want to play the DVD with the subtitles in French.
- **SPANISH**  
Select this when you want to play the DVD with the subtitles in Spanish.
- **GERMAN**  
Select this when you want to play the DVD with the subtitles in German.
- **JAPANESE**  
Select this when you want to play the DVD with the subtitles in Japanese.
- **OTHERS**  
Subtitles are played in the language input with the number buttons. (See the table of language numbers on page 94.)

※ **To exit the subtitle mode**  
Press the ENTER button, you can go back to the previous screen.

■ **When “DISC MENUS” is selected:**

- **ENGLISH (Factory default)**  
Select this when you want to display the menus in English.
- **FRENCH**  
Select this when you want to display the menus in French.
- **SPANISH**  
Select this when you want to display the menus in Spanish.
- **GERMAN**  
Select this when you want to display the menus in German.
- **JAPANESE**  
Select this when you want to display the menus in Japanese.
- **OTHERS**  
The menu screen is played in the language input with the number buttons. (See the table of language numbers on page 94.)

※ **To exit the disc menus mode**  
Press the ENTER button, you can go back to the previous screen.

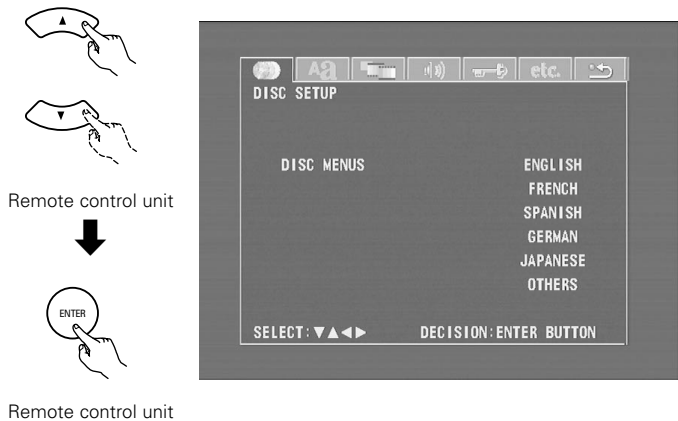
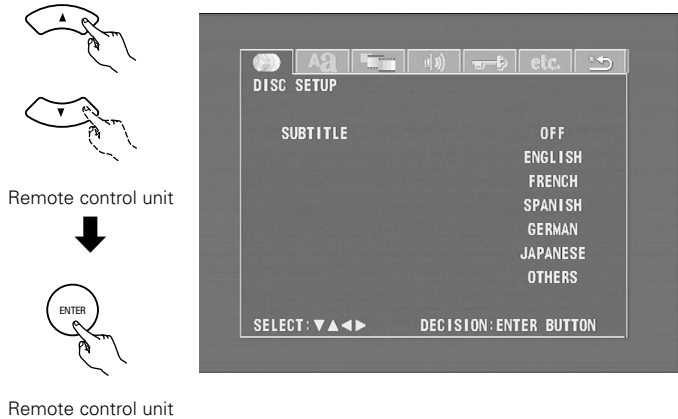

## Language code list

Code	Language	Code	Language	Code	Language	Code	Language
<b>6565</b>	Afar	<b>7079</b>	Faroese	<b>7678</b>	Lingala	<b>8375</b>	Slovak
<b>6566</b>	Abkhazian	<b>7082</b>	French	<b>7679</b>	Laothian	<b>8376</b>	Slovenian
<b>6570</b>	Afrikaans	<b>7089</b>	Frisian	<b>7684</b>	Lithuanian	<b>8377</b>	Samoan
<b>6577</b>	Ameharic	<b>7165</b>	Irish, Scots	<b>7686</b>	Latvian, Lettish	<b>8378</b>	Shona
<b>6582</b>	Arabic	<b>7168</b>	Gaelic	<b>7771</b>	Malagasy	<b>8379</b>	Somali
<b>6583</b>	Assamese	<b>7176</b>	Galician	<b>7773</b>	Maori	<b>8381</b>	Albanian
<b>6588</b>	Aymara	<b>7178</b>	Guarani	<b>7775</b>	Macedonish	<b>8382</b>	Serbian
<b>6590</b>	Azerbaijani	<b>7185</b>	Gujarati	<b>7776</b>	Malayalam	<b>8385</b>	Sundanese
<b>6665</b>	Bashkir	<b>7265</b>	Hausa	<b>7778</b>	Mongolian	<b>8386</b>	Swedish
<b>6669</b>	Byelorussian	<b>7273</b>	Hindi	<b>7779</b>	Moldavian	<b>8387</b>	Swahili
<b>6671</b>	Bulgarian	<b>7282</b>	Croatian	<b>7782</b>	Marathi	<b>8465</b>	Tamil
<b>6672</b>	Bihari	<b>7285</b>	Hungarian	<b>7783</b>	Malay	<b>8469</b>	Telugu
<b>6678</b>	Bengali; Bangla	<b>7289</b>	Armenian	<b>7784</b>	Maltese	<b>8471</b>	Tajik
<b>6679</b>	Tibetan	<b>7365</b>	Interlingua	<b>7789</b>	Burmese	<b>8472</b>	Thai
<b>6682</b>	Breton	<b>7378</b>	Indonesian	<b>7865</b>	Nauru	<b>8473</b>	Tigrinya
<b>6765</b>	Catalan	<b>7383</b>	Icelandic	<b>7869</b>	Nepali	<b>8475</b>	Turkmen
<b>6779</b>	Corsican	<b>7384</b>	Italian	<b>7876</b>	Dutch	<b>8476</b>	Tagalog
<b>6783</b>	Czech	<b>7387</b>	Hebrew	<b>7879</b>	Norwegian	<b>8479</b>	Tonga
<b>6789</b>	Welsh	<b>7465</b>	Japanese	<b>7982</b>	Oriya	<b>8482</b>	Turkish
<b>6865</b>	Danish	<b>7473</b>	Yiddish	<b>8065</b>	Panjabi	<b>8484</b>	Tatar
<b>6869</b>	German	<b>7487</b>	Javanese	<b>8076</b>	Polish	<b>8487</b>	Twi
<b>6890</b>	Bhutani	<b>7565</b>	Georgian	<b>8083</b>	Pashto, Pushto	<b>8575</b>	Ukrainian
<b>6976</b>	Greek	<b>7575</b>	Kazakh	<b>8084</b>	Portuguese	<b>8582</b>	Urdu
<b>6978</b>	English	<b>7576</b>	Greenlandic	<b>8185</b>	Quechua	<b>8590</b>	Uzbek
<b>6979</b>	Esperanto	<b>7577</b>	Cambodian	<b>8277</b>	Rhaeto-Romance	<b>8673</b>	Vietnamese
<b>6983</b>	Spanish	<b>7578</b>	Kannada	<b>8279</b>	Romanian	<b>8679</b>	Volapük
<b>6984</b>	Estonian	<b>7579</b>	Korean	<b>8285</b>	Russian	<b>8779</b>	Wolof
<b>6985</b>	Basque	<b>7583</b>	Kashmiri	<b>8365</b>	Sanskrit	<b>8872</b>	Xhosa
<b>7065</b>	Persian	<b>7585</b>	Kurdish	<b>8368</b>	Sindhi	<b>8979</b>	Yoruba
<b>7073</b>	Finnish	<b>7589</b>	Kirghiz	<b>8372</b>	Serbo-Croatian	<b>9072</b>	Chinese
<b>7074</b>	Fiji	<b>7665</b>	Latin	<b>8373</b>	Singhalese	<b>9085</b>	Zulu

**(2) When "OSD SETUP" is selected****1**

If you are not at the DVD setting screen, read steps 1 and 2 on page 91.

**2****3**

Use the ◀ and ▶ cursor buttons to select the "OSD SETUP" tag icon, then press the ENTER button.

- **WALL PAPER**

The image displayed when in the stop mode or when playing a CD can be selected.

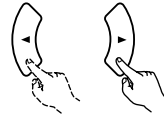

Remote control unit



Remote control unit

**4**

Use the ▲ and ▼ cursor buttons to select the setting to be set, then press the ENTER button.

- **When "WALL PAPER" has been selected**

- Use the ▲ and ▼ cursor buttons to select the wallpaper.

- **BLUE (Factory default)**

The wallpaper is set to blue.

- **GRAY**

The wallpaper is set to gray.

- **BLACK**

The wallpaper is set to black.

- **PICTURE**

The wallpaper is set to a picture.

- ※ **To complete the "WALL PAPER" setting**

Press the ENTER button.



Remote control unit



Remote control unit

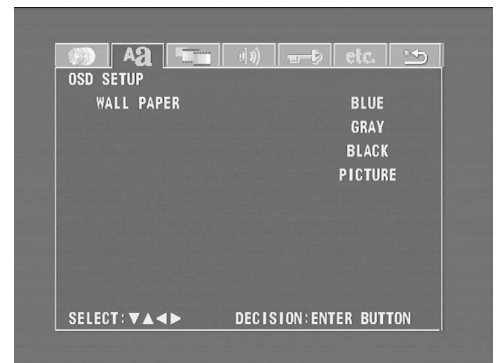

**(3) "VIDEO SETUP" is selected**

**1**

See page 91.

**2**

**3**

Use the ◀ and ▶ cursor buttons to select the "VIDEO SETUP", then press the ENTER button.

• **TV ASPECT**

Use this to set the shape of your TV's screen.

• **TV TYPE**

Use this to set your TV's video format (NTSC, PAL or MULTI).

• **VIDEO MODE**

Use this to select the video mode. (AUTO, FILM, VIDEO)

• **BLACK LEVEL**

The picture's black level can be set to "lighter" or "darker".

※ **To exit the video setup mode**

Use the ▲ and ▼ cursor buttons to select "> NEXT DVD MENU", then press the ENTER button.

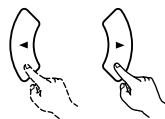

Remote control unit



Remote control unit



**4**

Use the ▲ and ▼ cursor buttons to select the desired setting, then press the ENTER button.

■ **When "TV ASPECT" is selected:**

• **4:3 PS (Factory default)**

Select this to play wide DVDs in the pan & scan mode (with the sides of the picture cut off). Discs for which pan & scan is not specified are played in the letter box mode.

• **4:3 LB**

Select this to play wide DVDs in the letter box mode (with black strips at the top and bottom).

• **WIDE (16:9)**

Select this to play wide DVDs in the full-screen mode.

※ **To exit the TV aspect mode**

Press the ENTER button, you can go back to the previous screen.



Remote control unit



Remote control unit

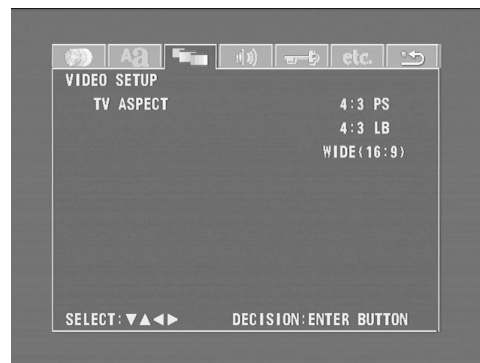



4

■ When “TV TYPE” is selected:

• **NTSC (Factory default)**

Select this when your TV’s video format is NTSC.  
If NTSC is selected, output format is fixed to NTSC.

• **PAL**

Select this when your TV’s video format is PAL.  
If PAL is selected, output format is fixed to PAL.

• **MULTI**

Select this when your TV is compatible with both the NTSC and PAL formats.  
NTSC signals are output from the video output jacks when discs recorded in NTSC format are played, and PAL signals are output from the video output jacks when discs recorded in PAL format are played.

※ **To exit the TV type mode**

Press the ENTER button, you can go back to the previous screen.

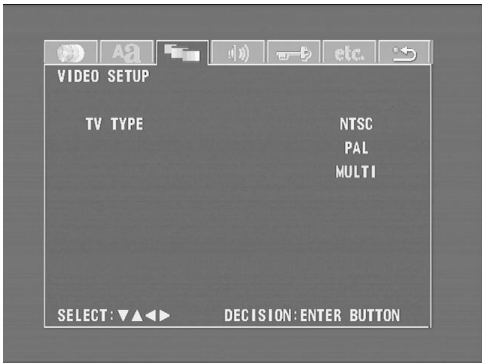
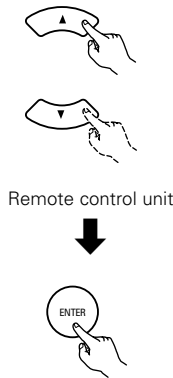

■ When “VIDEO MODE” has been selected (see the note below)

• Use the ▲ and ▼ cursor buttons to select the video mode to be set.

• **AUTO (Factory default)**

The mode is selected by identifying the type of material (film or video flag) from the disc.

• **FILM**

This setting is suited for playing film material discs or video material discs recorded with progressive scanning.

• **VIDEO**

This setting is suited for playing video material discs.

※ **To complete the “VIDEO MODE” setting**

Press the ENTER button.

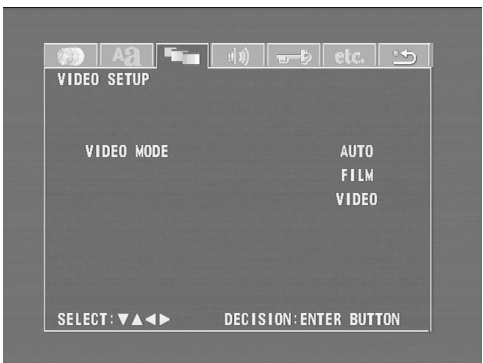
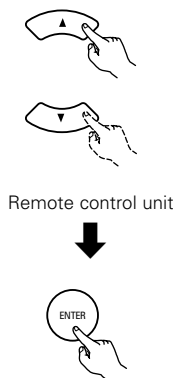

■ When “BLACK LEVEL” has been selected

• Use the ▲ and ▼ cursor buttons to select the black level.

• **DARKER**

This sets the black level of the output signals to the standard level.

• **LIGHTER (Factory default)**

This raises the standard level for the black level. Set this if the picture displayed on the TV is extremely dark.

※ **To complete the “BLACK LEVEL” setting**

Press the ENTER button.

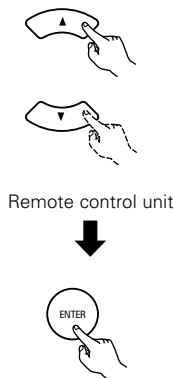

**NOTE:**

- For the component output only, it is possible to switch between interlace image output and progressive image output. It is not possible to specify progressive image output for the Video output connectors or S-Video output connector.

■ **Note on when “VIDEO MODE” is selected**

- Some discs may not be identified properly (for example discs including both film and video materials). For such discs, try changing the video mode setting.
- When certain DVD video discs are played, noise in the form of stripes may appear or the picture may be blurred. In such cases, try changing the video mode setting.

**(4) "AUDIO SETUP" is selected****1**

— See page 91.

**2****3**

Use the ◀ and ▶ cursor buttons to select the "AUDIO SETUP", then press the ENTER button.

- **DIGITAL OUT**

Use this to select the digital output's signal format.

- **LPCM (44.1 kHz / 48 kHz)**

Use this to set the digital audio output when playing DVDs recorded in linear PCM audio.

※ **To exit the audio setup mode**

Use the ▲ and ▼ cursor buttons to select "> NEXT DVD MENU", then press the ENTER button.

- The screen returns to as it was in step 2.

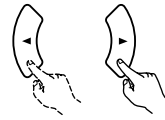

Remote control unit



Remote control unit

**4**

Use the ▲ and ▼ cursor buttons to select the desired setting, then press the ENTER button.

■ **When "DIGITAL OUT" is selected.**

- **NORMAL (Factory default)**

Make the selection when playing back in surround playback a DVD that has been recorded with Dolby Digital or DTS on this unit.

The Dolby Digital or DTS digital signal is also output from the digital output jacks.

- **PCM**

DVDs that were recorded in Dolby Digital DTS are converted to linear PCM 48 kHz/16 bit (2 channels). Make the selection when making a digital recording.

※ **To exit the digital out mode**

Press the ENTER button, you can go back to the previous screen.



Remote control unit



Remote control unit



## 4 ■ "LPCM SELECT (96 kHz → 48 kHz)" is selected.

### • OFF (Factory default)

Make the selection when playing back to a decoder DVDs that were recorded with this unit using linear PCM 48 kHz/20/24 bit and 96 kHz modes. Note that DVDs with Copyright Protection are converted to 48 kHz/16 bits and played back.

The same signal is output from the digital output jacks.

### • ON

DVDs that were recorded with linear PCM 48 kHz/20/24 bit and 96 kHz modes are all converted to 48 kHz/16 bits. Make this selection at the time of digital recording.

### ※ To exit the LPCM select mode

Press the ENTER button, you can go back to the previous screen.

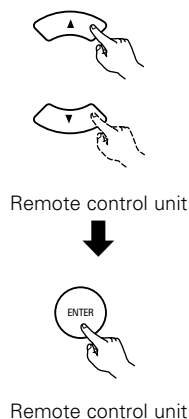

### NOTES:

- When playing Dolby Digital/DTS surround DVDs or 96 kHz linear PCM DVDs on the ADV-M71, be sure to set "Digital Output" to "Normal" and "LPCM Conversion Mode" to "Do Not Convert".
- When and only when you want to output the signals of the Dolby Digital/DTS surround DVD being played on the ADV-M71 to a digital PCM device, set "Digital Output" to "PCM Conversion".  
With this setting, DVDs cannot be played on the ADV-M71 in the Dolby Digital/DTS surround mode. (The surround mode is set to the mode in which PCM 2-channel signals can be played.)
- When and only when you want to make a digital recording of the signals of a 48 kHz/20-bit/24-bit or 96 kHz linear PCM DVD being played on the ADV-M71 onto a digital recorder, set the "LPCM Conversion" to "Convert".  
With this setting it is not possible to decode and play 48 kHz/20-bit/24-bit or 96 kHz linear PCM signals on the ADV-M71 during recording. (Decoding and playback is in 48 kHz/16-bit linear PCM format.)

**(5) "RATINGS" is selected****1**

See page 91.

**2****3**

Use the ◀ and ▶ cursor buttons to select the "RATINGS", then press the ENTER button.

- **RATING LEVEL**

Use this to restrict playback of adult DVDs you do not want children to view. Note that even with adult DVDs, viewing cannot be restricted unless the restriction level is recorded on the disc.

It is however possible to disable playback of all DVDs.

- **PASSWORD**

Use this to change the password.

The set's password is set to "0000" by default.

※ **To exit the rating setup mode**

Use the ▲ and ▼ cursor buttons to select "> NEXT DVD MENU", then press the ENTER button.

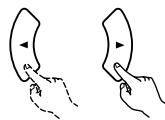

Remote control unit



Remote control unit

**4**

Use the ▲ and ▼ cursor buttons to select the desired setting, then press the ENTER button.

■ **When "RATING LEVEL" is selected.**

- **Level 0 (LOCK ALL)**

Select this to disable playback of all DVDs.

Use this for example to disable playback of adult DVDs on which the rating level is not recorded.

- **Level 1**

Select this to play only DVDs for children. (Adult and general audience DVDs cannot be played.)

- **Level 2 to Level 7**

Select this to play DVDs for general audiences and children. Adult DVDs cannot be played.

- **NO LIMIT (Factory default)**

Select this to play all DVDs.



Remote control unit



Remote control unit



**4** Use the number buttons to input a 4-digit password, then press the ENTER button.

- ※ Be sure to set the DVD mode using the remote control mode selector buttons.
- ※ The set's password is set to "0000" by default.
- ※ Do not forget the password.
- ※ The setting cannot be changed without inputting the correct password.

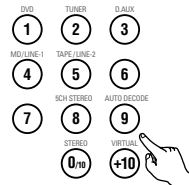

Remote control unit



Remote control unit



- ※ When the password has been forgotten or when a RATING LEVEL setting change is suspended, press the ENTER button several times and terminate the rating setup mode.

**■ When "PASSWORD CHANGE" is selected.**

Use the number buttons to input a 4-digit password, then press the ENTER button.

- ※ Be sure to set the DVD mode using the remote control mode selector buttons.
- ※ Do not forget the password.
- ※ The setting cannot be changed without inputting the correct password.
- ※ The set's password is set to "0000" by default.

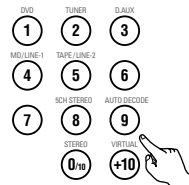

Remote control unit



**(6) "OTHER SETUP" is selected****NOTES:**

- An English caption decoder is required to display English captions.
- DVDs with caption signals are indicated by the  mark.  
English captions cannot be displayed when playing DVDs which do not contain caption signals.
- The characters in which the captions are displayed (capital letters, small letters, italics, etc.) depend on the DVD and cannot be selected with this unit.

**1**

See page 91.

**2****3**

Use the ◀ and ▶ cursor buttons to select the "OTHER SETUP", then press the ENTER button.

- **CAPTIONS**

Set whether or not to display the closed captions (subtitles) recorded on the DVD. (A caption decoder (commercially available) is required to display captions.)

- **SLIDE SHOW**

Set the time interval for switching to the next still image (in JPEG format) when playing slides.

※ **To exit the other setup mode**

Use the ▲ and ▼ cursor buttons to select "> NEXT DVD MENU", then press the ENTER button.

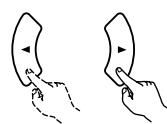

Remote control unit



Remote control unit

**4**

Use the ▲ and ▼ cursor buttons to select the desired setting, then press the ENTER button.

■ **When "CAPTIONS" is selected:**

- **OFF (Factory default)**

Select this when you do not want to display the captions on the screen when playing DVDs containing English captions.

- **ON**

Select this to display the captions on the screen when playing DVDs containing English captions.

※ **To exit the captions mode**

Press the ENTER button, you can go back to the previous screen.



Remote control unit



Remote control unit



4

■ When "SLIDE SHOW" has been selected

- Use the ▲ and ▼ cursor buttons to set the time.
  - The interval can be set from 5 to 15 seconds in steps of 1 second.

(Factory default: 5 seconds)

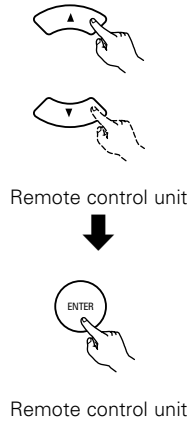

## 20 SYSTEM FUNCTIONS

- Making system connections between the ADV-M71 and the D-M31 series cassette deck (DRR-M31) makes operation even easier. (For instructions on connections, refer to “Connecting to D-M31 Series System Components” on pages 8 to 9.)
- System functions will not work properly if the input/output function settings are not right for the connected components. Be sure to set the input/output functions for the components being used. (See page 37.) The setting contents are maintained until they are next changed even when the power is switched off.

### (1) Auto power on function

- When the play/pause button on the main unit (▶/||) or the DVD play button on the remote control unit (▶) is pressed while the power is in the standby mode, the ADV-M71's power turns on automatically, and if a disc is loaded in the ADV-M71 the disc is played.

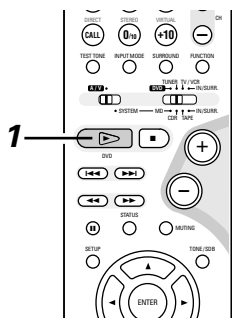
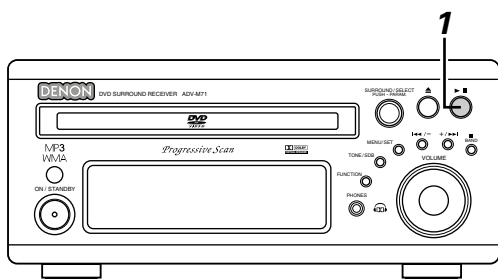

**1** When the ADV-M71 is in the standby mode, the power can be turned on simply by pressing the play/pause button on the main unit or the DVD play button on the remote control unit. If a disc is loaded, playback starts.



Main unit

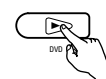

Remote control unit

※ The auto power on function also turns the power on when the disc holder is opened while the ADV-M71 is in the standby mode.



Main unit

- To listen to a radio program, simply press one of the tuner preset buttons (“+” or “-”) on the remote control unit. The power turns on and a station is tuned in.
- The power on function works in the same way when system connections are made with the D-M31 series cassette deck (DRR-M31). For details, refer to the respective component's operating instructions.

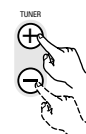

Remote control unit

### (2) Auto function selection

- At the touch of a button, the function switches automatically to “DVD” and disc playback begins.

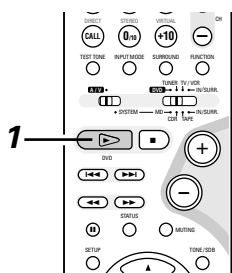
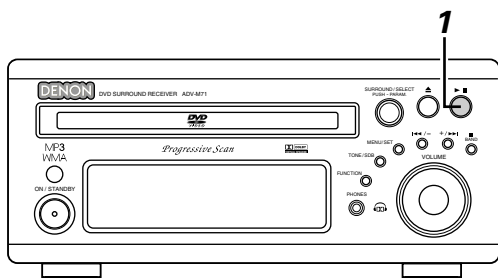

**1** Press the play/pause button on the ADV-M71 or the DVD play button on the remote control unit while a component than the DRR-M31 (cassette deck) is playing.

- Playback on the other component stops, the ADV-M71's function switches to “DVD” and if a disc is loaded playback of the disc starts.



Main unit

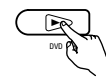

Remote control unit

- To listen to a radio program, simply press one of the tuner preset buttons (“+” or “-”) on the remote control unit.
- Auto function selection works in the same way when system connections are made with the D-M31 series cassette deck (DRR-M31). For details, refer to the respective component's operating instructions.
- Auto function selection does not work for components connected using the AUX or D.AUX input/output terminals.



Remote control unit



**(3) CD → TAPE recording (when the ADV-M71 and DRR-M31 are connected with a system cord)**

- CDs can easily be recorded onto cassette tapes.

Main unit (ADV-M71)

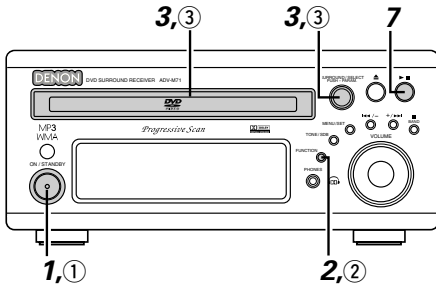

Cassette deck (DRR-M31)

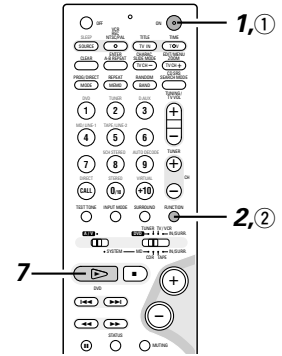
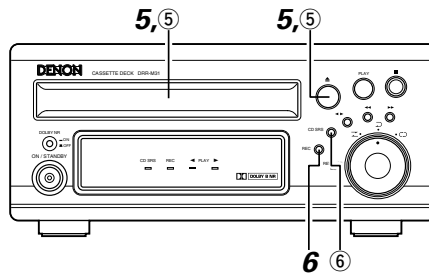

**[1] Synchronized recording function**

**1** Turn on the ADV-M71's power.

- The system's power turns on.

ADV-M71 Remote control unit

**2** Press the FUNCTION button and switch the function to "DVD".

ADV-M71 Remote control unit

**3** Open the ADV-M71's disc holder, load the CD, then close the disc holder.

ADV-M71

**4** Check that the total number of tracks and total playing time on the CD appear on the display.

Example: For a CD with a total of 16 tracks and a total playing time of 53 minutes, 20 seconds

**5** Open the cassette holder, load the cassette tape onto which you want to record, then close the cassette holder.

DRR-M31

**6** Press the recording button on the cassette deck once to set the recording standby mode.

DRR-M31

**7** Press the play/pause button on the ADV-M71 or the play button on the remote control unit.

- Recording of the CD starts automatically.

ADV-M71 Remote control unit

**[2] Synchronized CD recording**

**1** ~ **5** Perform the same operations as for steps 1 to 5 above.

**6** Press the CD synchronized recording button on the cassette deck.

- Recording of the CD starts automatically.

DRR-M31

- ※ Once all the tracks on the CD have been played, both the ADV-M71 and cassette deck are automatically set to the stop mode.
- ※ Even if the entire CD has not yet been played, both the ADV-M71 and cassette deck are automatically set to the stop mode once the cassette tape is full.
- ※ To stop synchronized recording, press the stop button (■) on the ADV-M71 or the cassette deck.

**NOTES:**

- Synchronized recording does not work when the ADV-M71 is set to a function other than DVD.
- Synchronized recording does not work when in the programmed play mode. When in the random play or repeat play mode, the respective mode is canceled when synchronized recording starts.

※ The recording standby mode is set once playback of the CD ends.

**(4) Edited recording (when the ADV-M71 and DRR-M31 are connected with a system cord)**

- The tracks on the CD can be automatically divided into sides A and B for recording according to the length of the cassette tape (tape time). (For CDs only)
- Edited recording is possible for CDs containing up to 25 tracks. For CDs with 26 tracks or more, editing is not possible.

Example: Recording a CD with 16 tracks and a total playing time of 56 minutes onto a C-60 (60-minute) cassette tape

Main unit ADV-M71

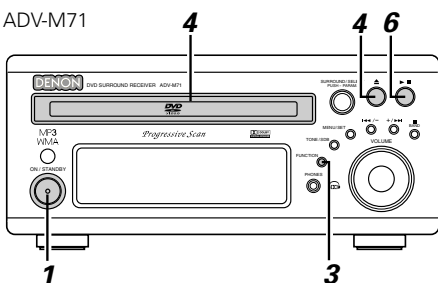

Cassette deck (DRR-M31)

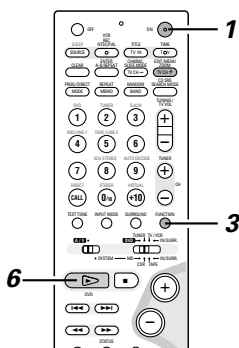
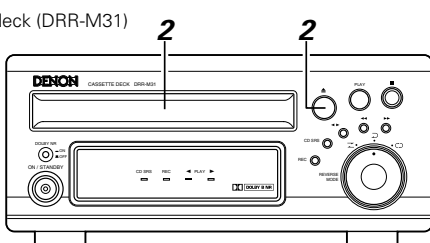

- 1** Turn on the ADV-M71's power.
- The system's power turns on.

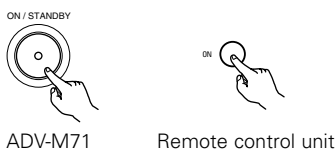

- 2** Open the cassette holder, load the cassette tape onto which you want to record, then close the cassette holder.
- ※ Load the cassette tape with side A facing up.

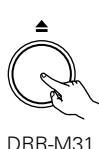

- 3** Press the FUNCTION button and switch the function to "DVD".



- 4** Open the ADV-M71's disc holder, load the CD, then close the disc holder.

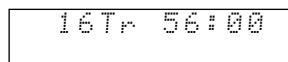

- 5** Press the MENU button on the remote control unit and set the length of the cassette tape onto which you are going to record.



- For example, for a 60-minute cassette tape, press the edit button twice. (The length of the cassette tape is the total time for sides A and B.)

Remote control unit

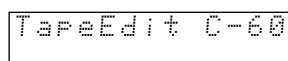

※ The display switches as follows each time the MENU button is pressed.



About 4 seconds after setting the length of the cassette tape, the numbers of the tracks to be recorded on side A and the remaining time for side A on the cassette tape are displayed.  
(Ex.: When tracks 1 to 9 will be recorded on side A and the remaining time for side A is 2 minutes 40 seconds)

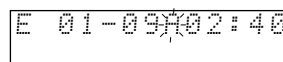

After this, the display switches every few seconds between the numbers of the tracks and remaining time for side B and the numbers of the tracks and remaining time for side A.  
(Ex.: When tracks 10 to 16 will be recorded on side B and the remaining time for side B is 1 minute 20 seconds)

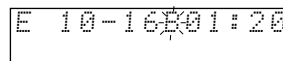

※ If "OVER" is displayed for the remaining time, it is not possible to record all the tracks. Change the cassette tape length.

※ To set the cassette tape length to anything other than 46, 60 or 90, use the numeric keypad and +10 button on the remote control unit while " [C---] " is displayed to input the time. The time can be set to up to 99 minutes. The time is input in the same way as when searching for CD tracks directly.

[Example:] To set the time to 54 minutes

While " [C---] " is displayed, press [ +10 ], [ +10 ], [ +10 ], [ +10 ], [ +10 ], 4.

**6** Press the play/pause button on the ADV-M71 or the DVD play button on the remote control unit.

- Playback of the CD and recording onto the cassette tape start simultaneously.



ADV-M71

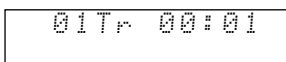

Remote control unit

※ To quit the edited recording function, press the ADV-M71's stop button.



ADV-M71



Remote control unit

#### NOTES:

- The edited recording function cannot be used with CDs containing 26 tracks or more.
- Load the cassette tape onto which you want to record into the cassette deck's cassette tray with side A facing up before performing the edited recording procedure. The tape is automatically wound to the beginning of the recordable section before recording starts.
- When using an already recorded cassette tape for edited recording, if the tape is longer than the set time, recording stops in the middle of side B and the previous recording remains on the rest of the tape. Because of this, erase the cassette tape before using it.
- If the cassette deck's reverse mode is set to  $\Sigma$  when using the edited recording function, recording will stop after side A. Set the cassette deck's reverse mode to  $\curvearrowright$ .
- Because the tracks are divided into sides A and B, it may not be possible to record all the tracks from the CD onto the cassette tape, even if the tape is slightly longer than the CD's total playing time.
- The  $\blacktriangleright\blacktriangleleft$ ,  $\blacktriangleleft\blacktriangleleft$ ,  $\blacktriangleright\blacktriangleright$  and  $\blacktriangleleft\blacktriangleleft$  buttons do not work during edited recording.

#### ■ About synchronized recording onto the cassette deck (DRR-M31)

- Synchronized recording is possible with discs other than CDs (DVDs, video CDs, discs containing MP3 or WMA files, etc.).
- For digital and analog recording during disc playback, see page 14.
- The synchronized recording function may not work properly for some discs. If so, record the disc manually by setting the recording mode after start playback of the disc.
- The CD SRS function and the function for edited recording onto tapes only works with CDs.

## 21 LAST FUNCTION MEMORY

- This unit is equipped with a last function memory which stores the input and output setting conditions as they were immediately before the power is switched off. This function eliminates the need to perform complicated resets when the power is switched on.
- The unit is also equipped with a back-up memory. This function provides memory storage when the power switch is off and with the power cord disconnected.

## 22 INITIALIZATION OF THE MICROPROCESSOR

When the indication of the display is not normal or when the operation of the unit does not shows the reasonable result, the initialization of the microprocessor is required by the following procedure.

- 1 Press the power button to set the standby mode, then unplug the set's power cord from the wall power outlet.

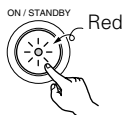

- 2 Hold the following PLAY/PAUSE (▶/⏸) button and STOP (■) button after 30 second, and plug the AC cord into the outlet.

- 3 Check that the entire display is flashing with an interval of about 1 second, and release your fingers from the 2 buttons and the microprocessor will be initialized.

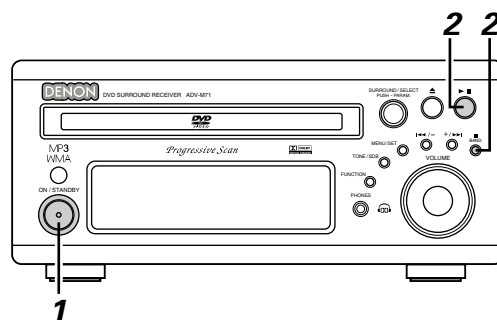

### NOTES:

- If step 3 does not work, start over from step 1.
- If the microprocessor is reset, all the buttons and the setup settings are reset to the factory default values.

## 23 TROUBLESHOOTING

### Check again before assuming the player is malfunctioning

- Are all the connections correct ?
- Are you following the instructions in the manual ?
- Are the speakers and other components operating properly ?

If this unit does not seem to be functioning properly, check the table below. If this does not solve the problem, this unit may be damaged. Turn off the power, unplug the power cord from the power outlet, and contact your store of purchase or nearest Denon sales office.

	Symptom	Cause	Measures	Page
Common problems when listening to the discs, tapes and FM broadcasts, etc.	DISPLAY not lit and sound not produced when power switch set to on.	<ul style="list-style-type: none"> <li>• Power cord not plugged in securely.</li> </ul>	<ul style="list-style-type: none"> <li>• Check the insertion of the power cord plug.</li> </ul>	8
	DISPLAY lit but sound not produced.	<ul style="list-style-type: none"> <li>• Speaker cords not securely connected.</li> <li>• Improper position of the audio function button.</li> <li>• Volume control set to minimum.</li> <li>• MUTING is on.</li> <li>• Digital signals not input Digital input selected.</li> </ul>	<ul style="list-style-type: none"> <li>• Connect securely.</li> <li>• Set to a suitable position.</li> <li>• Turn volume up to suitable level.</li> <li>• Switch off MUTING.</li> <li>• Input digital signals or select input jacks to which digital signals are being input.</li> </ul>	8
				43
				41
				45 46
Monitor doesn't display an image.	<ul style="list-style-type: none"> <li>• Connections between the video output jack of this unit and the input connector of the monitor are incomplete.</li> <li>• The input setting of the monitor TV is different.</li> <li>• When "PROGRESSIVE" is set, no video signals are output from the VIDEO OUT or S-VIDEO OUT terminals.</li> </ul>	<ul style="list-style-type: none"> <li>• Check whether the connections are correct.</li> <li>• Set the input switching of the TV to the jack to which the video input is connected.</li> <li>• Set "INTERLACED" if you want to use the VIDEO OUT or S-VIDEO OUT signals.</li> </ul>	11	
			—	
			39	
The program cannot be copied from DVD to the VCR.	<ul style="list-style-type: none"> <li>• Almost all movie software contains a copy prevention signal.</li> </ul>	<ul style="list-style-type: none"> <li>• A copy cannot be made.</li> </ul>	—	
The subwoofer does not produce sound.	<ul style="list-style-type: none"> <li>• Power is not being supplied to the subwoofer.</li> <li>• The subwoofer setting is made to "No" in the setup.</li> <li>• The output of the subwoofer has not been connected.</li> </ul>	<ul style="list-style-type: none"> <li>• Switch on the power of the subwoofer.</li> <li>• Change the setting to "Subwoofer" in the setup.</li> <li>• Make the proper connections.</li> </ul>	—	
			29	
			8	
Remote control unit	This unit does not operate properly when remote control unit is used.	<ul style="list-style-type: none"> <li>• Batteries dead.</li> <li>• Remote control unit too far from this unit.</li> <li>• Obstacle between this unit and remote control unit.</li> <li>• Different button is being pressed.</li> <li>• ⊕ and ⊖ ends of battery inserted in reverse.</li> <li>• The mode selection of the remote control is not properly selected. The DVD mode, AV mode, or audio mode is not properly selected.</li> </ul>	<ul style="list-style-type: none"> <li>• Replace with new batteries.</li> <li>• Move closer.</li> <li>• Remove obstacle.</li> <li>• Press the proper button.</li> <li>• Insert batteries properly.</li> <li>• Press the remote control mode selection button for the item you wish to operate. To operate this unit, use with the DVD mode.</li> </ul>	21
				21
				21
				17
				21
				22

	Symptom	Check	Page	
DVD operation	Playback does not start when PLAY button is pressed. Playback stops immediately.	<ul style="list-style-type: none"> <li>• Is there condensation on the disc or player ? (Let stand for 1 or 2 hours.)</li> <li>• Discs other than DVDs, video CDs and music CDs cannot be played.</li> <li>• Disc is dirty. Wipe off the dirt.</li> </ul>	— 6 7	
	Menu playback of video CD's is not possible.	<ul style="list-style-type: none"> <li>• Menu playback is not possible with anything but video CDs with playback control.</li> </ul>	—	
	Picture is disturbed during the search operation.	<ul style="list-style-type: none"> <li>• Some disturbance is normal.</li> </ul>	—	
	Buttons do not operate.	<ul style="list-style-type: none"> <li>• Some operations are disabled for some discs.</li> </ul>	41	
	No subtitles are displayed.	<ul style="list-style-type: none"> <li>• Subtitles are not displayed for DVDs not containing subtitles.</li> <li>• Subtitles are turned off. Turn the subtitles setting on.</li> </ul>	— 92, 93	
	Audio (or subtitle) language does not switch.	<ul style="list-style-type: none"> <li>• The audio (or subtitle) language does not switch for discs which do not include multiple audio (or subtitle) languages.</li> <li>• For some discs the audio (or subtitle) language cannot be switched when the operation to switch it is performed, but can be switched on the menu screens.</li> </ul>	92 92	
	Angle does not switch.	<ul style="list-style-type: none"> <li>• The angle cannot be switched for DVDs which do not contain multiple angles. In some cases multiple angles are only recorded for specific scenes.</li> </ul>	80	
	Playback does not start when the title is selected.	<ul style="list-style-type: none"> <li>• Check the "RATINGS SETUP" setting.</li> </ul>	100, 101	
	The password for rating level has been forgotten. <b>Reset all the DVD setting to Factory Preset.</b>	<ul style="list-style-type: none"> <li>• While the player is in the stop mode, hold the FUNCTION button and the MENU/SET button down simultaneously for longer than 3 seconds (until "INITIALIZE" disappears from the TV monitor). The lock will be released and the DVD all default settings and picture settings will return to the default values.</li> </ul>	100, 101	
	The disc is not played with the audio or subtitle language set as the default setting.	<ul style="list-style-type: none"> <li>• The disc does not play with the selected audio or subtitle language if that audio or subtitle language is not included on that DVD.</li> </ul>	92	
	Picture is not displayed in 4:3 (or 16:9).	<ul style="list-style-type: none"> <li>• Set the "TV ASPECT" default setting to the proper setting for the connected TV.</li> </ul>	96	
Menu screen messages for the desired language do not display.	<ul style="list-style-type: none"> <li>• Check the default setting for the disc language's menu language.</li> </ul>	93, 94		
Tuner	Continuous noise is heard when receiving FM programs	<ul style="list-style-type: none"> <li>• Antenna cable is not properly connected.</li> </ul>	<ul style="list-style-type: none"> <li>• Connect the antenna cable properly.</li> <li>• Connect an outdoor antenna.</li> </ul>	12
	Hissing or continuous noise is heard when receiving AM programs	<ul style="list-style-type: none"> <li>• This may be noise from a TV or interference from a radio station.</li> </ul>	<ul style="list-style-type: none"> <li>• Turn off the TV.</li> <li>• Change the position and direction of the AM loop antenna.</li> </ul>	12
	Humming noise is heard when receiving AM programs	<ul style="list-style-type: none"> <li>• The radio waves transmitted over the power cord are being modulated.</li> </ul>	<ul style="list-style-type: none"> <li>• Unplug the power cord, flip the plug over in the opposite direction, then plug the cord back in.</li> </ul>	12

## 24 SPECIFICATIONS

■ <b>Audio Section</b>			
• <b>Power Amplifier Section</b>			
Rated output:	Front:	20 W + 20 W (8 Ω/ohm load, 20 Hz to 20 kHz, T.H.D. 0.08%)	
Practical maximum output:	Front:	35 W + 35 W (6 Ω/ohm load, 1 kHz) *(EIAJ)	
Output terminals:	Speaker impedance: 6 to 16 Ω/ohms		
• <b>Analog Section</b>			
Input sensitivity/Input impedance:	200 mV/47 kΩ/kohms		
Frequency response:	10 Hz to 50 kHz: +0, -3 dB (2 Channel setting, direct mode)		
Signal-to-noise ratio:	98 dB (Direct mode)		
Rated output:	0.6 V (Preamplifier output)		
■ <b>Tuner Section</b>			
Reception frequency range:	FM: 87.5 MHz to 107.9 MHz AM: 520 kHz to 1710 kHz		
Receiving sensitivity:	FM:	1.5 μV/75 Ω/ohms AM: 20 μV	
FM stereo separation:	35 dB (1 kHz)		
• <b>Digital Section</b>			
Digital input/output:	Format — Digital audio interface		
■ <b>Video Section</b>			
• <b>Standard Video Jack</b>			
Output level/impedance:	1 Vp-p/75 Ω/ohms		
• <b>S-video Connector</b>			
Output level/impedance:	Y (Brightness) signal — 1 Vp-p/ 75 Ω/ohms C (Color) signal — 0.286 Vp-p/75 Ω/ohms		
• <b>Color Difference (Component) Video Connector:</b>			
Output level/impedance:	Y (Brightness) signal — 1 Vp-p/75 Ω/ohms Cb/Pb (Blue) signal — 0.7 Vp-p/75 Ω/ohms Cr/Pr (Red) signal — 0.7 Vp-p/75 Ω/ohms		
■ <b>DVD Section</b>			
Signal Format:	NTSC/PAL		
Supported Discs:	(1) DVD-VIDEO discs 12 cm single side 1 layer, 12 cm single side 2 layers, 12 cm both sides 2 layers (single side 1 layer), 8 cm single side 1 layer, 8 cm single side 2 layers, 8 cm both sides 2 layers (single side 1 layer) (2) CompactDisc (CD-DA, VIDEO CD) 12 cm discs, 8 cm discs Output level: 1.2 Vrms (LINE-1, LINE-2 OUT)		
■ <b>Analog Audio Output:</b>			
■ <b>Clock/Timer Section</b>			
Clock method:	Power line frequency synchronized method		
Timer:	Everyday/Once timer: One system each Sleep timer: 120 minutes, maximum		
■ <b>General</b>			
Power supply:	120 V AC, 60 Hz		
Power consumption:	75 W (At standby: Approximately 0.7 W)		
Maximum external dimensions:	210 (W) x 95 (H) x 367 (D) mm (including feet, knobs, and connectors)		
Weight:	3.5 kg		
■ <b>Remote Control Unit</b>			
Remote control method:	RC-936 IR pulse method		
Power supply:	3 V DC, using two AA batteries		
■ <b>Speakers SC-U71 [D-M71 DVS only]</b>			
Type:	2-way, 2-speakers Low-leakage-flux	Max. input:	80 watts (IEC)
Speakers:	12 cm cone bass-mid x 1 2.5 cm dome high range x 1	Frequency range:	55 Hz ~ 30 kHz
Input impedance:	6 Ω/ohms	Sensitivity:	88 dB (1m . 1watt)
		Dimensions:	162(W) x 270(H) x 240(D)mm
		Mass:	3.4 kg (one unit)

\* For improvement purposes, specifications and design are subject to change without notice.

\* (EIAJ) : Standards established by the Japan Electronics and Information Technology Industries Association (JEITA).

**DENON,Ltd.**

16-11, YUSHIMA 3-CHOME, BUNKYO-KU, TOKYO 113-0034, JAPAN  
Telephone: (03) 3837-5321



## Free Manuals Download Website

<http://myh66.com>

<http://usermanuals.us>

<http://www.somanuals.com>

<http://www.4manuals.cc>

<http://www.manual-lib.com>

<http://www.404manual.com>

<http://www.luxmanual.com>

<http://aubethermostatmanual.com>

Golf course search by state

<http://golfingnear.com>

Email search by domain

<http://emailbydomain.com>

Auto manuals search

<http://auto.somanuals.com>

TV manuals search

<http://tv.somanuals.com>