

DENON

AV SURROUND RECEIVER

AVR-3805

OPERATING INSTRUCTIONS

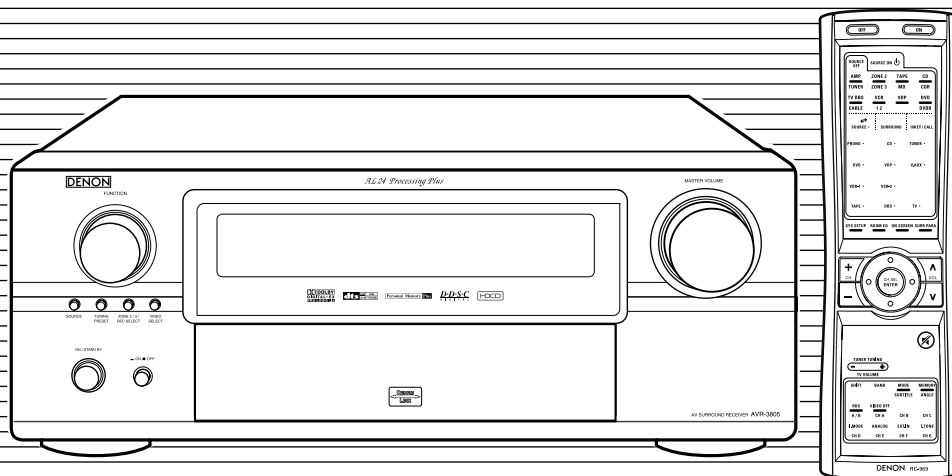

- We greatly appreciate your purchase of the AVR-3805.
- To be sure you take maximum advantage of all the features the AVR-3805 has to offer, read these instructions carefully and use the set properly. Be sure to keep this manual for future reference, should any questions or problems arise.

"SERIAL NO. _____
PLEASE RECORD UNIT SERIAL NUMBER ATTACHED TO THE REAR OF THE
CABINET FOR FUTURE REFERENCE"

SAFETY PRECAUTIONS

WARNING:

TO PREVENT FIRE OR SHOCK HAZARD, DO NOT EXPOSE THIS APPLIANCE TO RAIN OR MOISTURE.



**CAUTION
RISK OF ELECTRIC SHOCK
DO NOT OPEN**



CAUTION: TO REDUCE THE RISK OF ELECTRIC SHOCK, DO NOT REMOVE COVER (OR BACK). NO USER-SERVICEABLE PARTS INSIDE. REFER SERVICING TO QUALIFIED SERVICE PERSONNEL.



The lightning flash with arrowhead symbol, within an equilateral triangle, is intended to alert the user to the presence of uninsulated "dangerous voltage" within the product's enclosure that may be of sufficient magnitude to constitute a risk of electric shock to persons.



The exclamation point within an equilateral triangle is intended to alert the user to the presence of important operating and maintenance (servicing) instructions in the literature accompanying the appliance.

CAUTION

TO PREVENT ELECTRIC SHOCK, MATCH WIDE BLADE OF PLUG TO WIDE SLOT, FULLY INSERT.

ATTENTION

POUR ÉVITER LES CHOCS ÉLECTRIQUES, INTRODUIRE LA LAME LA PLUS LARGE DE LA FICHE DANS LA BORNE CORRESPONDANTE DE LA PRISE ET POUSSER JUSQU' AU FOND.

This device complies with Part 15 of the FCC Rules. Operation is subject to the following two conditions: (1) This device may not cause harmful interference, and (2) this device must accept any interference received, including interference that may cause undesired operation.

This Class B digital apparatus meets all requirements of the Canadian Interference-Causing Equipment Regulations.

Cet appareil numérique de la classe B respecte toutes les exigences du Règlement sur le matériel brouilleur du Canada.

NOTE ON USE / OBSERVATIONS RELATIVES A L'UTILISATION

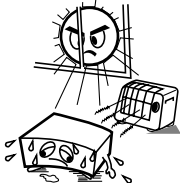

- Avoid high temperatures. Allow for sufficient heat dispersion when installed on a rack.
- Éviter des températures élevées. Tenir compte d'une dispersion de chaleur suffisante lors de l'installation sur une étagère.

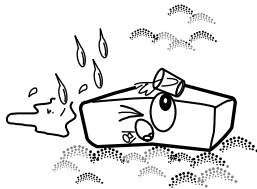

- Keep the set free from moisture, water, and dust.
- Protéger l'appareil contre l'humidité, l'eau et la poussière.



- Do not let foreign objects in the set.
- Ne pas laisser des objets étrangers dans l'appareil.

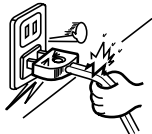

- Handle the power cord carefully. Hold the plug when unplugging the cord.
- Manipuler le cordon d'alimentation avec précaution. Tenir la prise lors du débranchement du cordon.

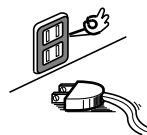

- Unplug the power cord when not using the set for long periods of time.
- Débrancher le cordon d'alimentation lorsque l'appareil n'est pas utilisé pendant de longues périodes.

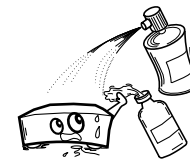

- Do not let insecticides, benzene, and thinner come in contact with the set.
- Ne pas mettre en contact des insecticides, du benzène et un diluant avec l'appareil.



* (For sets with ventilation holes)

- Do not obstruct the ventilation holes.
- Ne pas obstruer les trous d'aération.



- Never disassemble or modify the set in any way.
- Ne jamais démonter ou modifier l'appareil d'une manière ou d'une autre.

SAFETY INSTRUCTIONS

1. Read Instructions – All the safety and operating instructions should be read before the product is operated.
2. Retain Instructions – The safety and operating instructions should be retained for future reference.
3. Heed Warnings – All warnings on the product and in the operating instructions should be adhered to.
4. Follow Instructions – All operating and use instructions should be followed.
5. Cleaning – Unplug this product from the wall outlet before cleaning. Do not use liquid cleaners or aerosol cleaners.
6. Attachments – Do not use attachments not recommended by the product manufacturer as they may cause hazards.
7. Water and Moisture – Do not use this product near water – for example, near a bath tub, wash bowl, kitchen sink, or laundry tub; in a wet basement; or near a swimming pool; and the like.
8. Accessories – Do not place this product on an unstable cart, stand, tripod, bracket, or table. The product may fall, causing serious injury to a child or adult, and serious damage to the product. Use only with a cart, stand, tripod, bracket, or table recommended by the manufacturer, or sold with the product. Any mounting of the product should follow the manufacturer's instructions, and should use a mounting accessory recommended by the manufacturer.
9. A product and cart combination should be moved with care. Quick stops, excessive force, and uneven surfaces may cause the product and cart combination to overturn.
10. Ventilation – Slots and openings in the cabinet are provided for ventilation and to ensure reliable operation of the product and to protect it from overheating, and these openings must not be blocked or covered. The openings should never be blocked by placing the product on a bed, sofa, rug, or other similar surface. This product should not be placed in a built-in installation such as a bookcase or rack unless proper ventilation is provided or the manufacturer's instructions have been adhered to.
11. Power Sources – This product should be operated only from the type of power source indicated on the marking label. If you are not sure of the type of power supply to your home, consult your product dealer or local power company. For products intended to operate from battery power, or other sources, refer to the operating instructions.
12. Grounding or Polarization – This product may be equipped with a polarized alternating-current line plug (a plug having one blade wider than the other). This plug will fit into the power outlet only one way. This is a safety feature. If you are unable to insert the plug fully into the outlet, try reversing the plug. If the plug should still fail to fit, contact your electrician to replace your obsolete outlet. Do not defeat the safety purpose of the polarized plug.



13. Power-Cord Protection – Power-supply cords should be routed so that they are not likely to be walked on or pinched by items placed upon or against them, paying particular attention to cords at plugs, convenience receptacles, and the point where they exit from the product.
15. Outdoor Antenna Grounding – If an outside antenna or cable system is connected to the product, be sure the antenna or cable system is grounded so as to provide some protection against voltage surges and built-up static charges. Article 810 of the National Electrical Code, ANSI/NFPA 70, provides information with regard to proper grounding of the mast and supporting structure, grounding of the lead-in wire to an antenna discharge unit, size of grounding conductors, location of antenna-discharge unit, connection to grounding electrodes, and requirements for the grounding electrode. See Figure A.
16. Lightning – For added protection for this product during a lightning storm, or when it is left unattended and unused for long periods of time, unplug it from the wall outlet and disconnect the antenna or cable system. This will prevent damage to the product due to lightning and power-line surges.
17. Power Lines – An outside antenna system should not be located in the vicinity of overhead power lines or other electric light or power circuits, or where it can fall into such power lines or circuits. When installing an outside antenna system, extreme care should be taken to keep from touching such power lines or circuits as contact with them might be fatal.
18. Overloading – Do not overload wall outlets, extension cords, or integral convenience receptacles as this can result in a risk of fire or electric shock.
19. Object and Liquid Entry – Never push objects of any kind into this product through openings as they may touch dangerous voltage points or short-out parts that could result in a fire or electric shock. Never spill liquid of any kind on the product.
20. Servicing – Do not attempt to service this product yourself as opening or removing covers may expose you to dangerous voltage or other hazards. Refer all servicing to qualified service personnel.
21. Damage Requiring Service – Unplug this product from the wall outlet and refer servicing to qualified service personnel under the following conditions:
 - a) When the power-supply cord or plug is damaged,
 - b) If liquid has been spilled, or objects have fallen into the product,
 - c) If the product has been exposed to rain or water,
 - d) If the product does not operate normally by following the operating instructions. Adjust only those controls that are covered by the operating instructions as an improper adjustment of other controls may result in damage and will often require extensive work by a qualified technician to restore the product to its normal operation,
 - e) If the product has been dropped or damaged in any way, and
 - f) When the product exhibits a distinct change in performance – this indicates a need for service.
22. Replacement Parts – When replacement parts are required, be sure the service technician has used replacement parts specified by the manufacturer or have the same characteristics as the original part. Unauthorized substitutions may result in fire, electric shock, or other hazards.
23. Safety Check – Upon completion of any service or repairs to this product, ask the service technician to perform safety checks to determine that the product is in proper operating condition.
24. Wall or Ceiling Mounting – The product should be mounted to a wall or ceiling only as recommended by the manufacturer.
25. Heat – The product should be situated away from heat sources such as radiators, heat registers, stoves, or other products (including amplifiers) that produce heat.

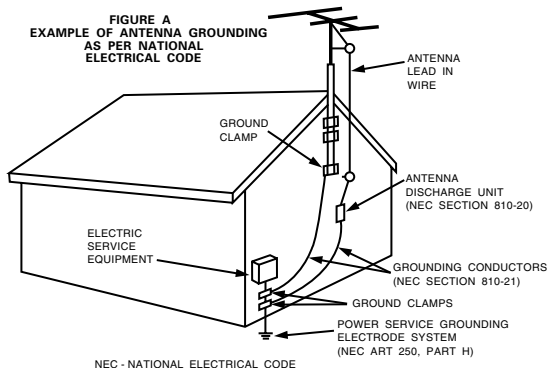

■ INTRODUCTION

Thank you for choosing the DENON AVR-3805 Digital A / V Surround Receiver. This remarkable component has been engineered to provide superb surround sound listening with home theater sources such as DVD, as well as providing outstanding high fidelity reproduction of your favorite music sources.

As this product is provided with an immense array of features, we recommend that before you begin hookup and operation that you review the contents of this manual before proceeding.

TABLE OF CONTENTS

1 Before Using4	10 Multi Zone.....69~71
2 Cautions on Installation.....4	11 Surround72~79
3 Cautions on Handling5	12 DSP Surround Simulation80~84
4 Features5, 6	13 Listening to the Radio.....85~87
5 Connections7~16	14 Last Function Memory.....87
6 Part Names and Functions17~19	15 Initialization of the Microprocessor87
7 Setting up the system20~49	16 Troubleshooting.....88
8 Remote Control Unit.....50~61	17 Additional Information.....89~100
9 Operation62~68	18 Specifications101

■ ACCESSORIES

Check that the following parts are included in addition to the main unit:

- | | | | |
|--------------------------------|---|------------------------------|--------------------------------------|
| ① Operating instructions.....1 | ② Warranty (for North America model only).....1 | ③ Service station list.....1 | ④ Remote control unit (RC-969).....1 |
| ⑤ R03/AAA batteries4 | ⑥ AM loop antenna.....1 | ⑦ FM indoor antenna...1 | |

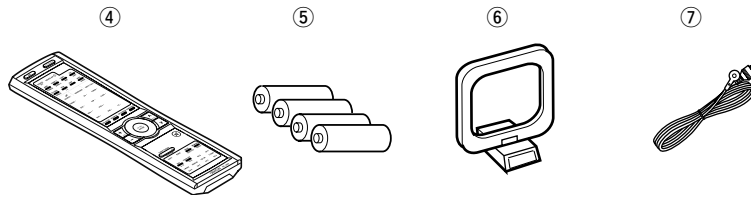

1 BEFORE USING

Pay attention to the following before using this unit:

• Moving the set

To prevent short circuits or damaged wires in the connection cords, always unplug the power cord and disconnect the connection cords between all other audio components when moving the set.

• Before turning the power switch on

Check once again that all connections are proper and that there are not problems with the connection cords. Always set the power switch to the standby position before connecting and disconnecting connection cords.

• Store this instructions in a safe place.

After reading, store this instructions along with the warranty in a safe place.

• Note that the illustrations in this instructions may differ from the actual set for explanation purposes.

2 CAUTIONS ON INSTALLATION

Noise or disturbance of the picture may be generated if this unit or any other electronic equipment using microprocessors is used near a tuner or TV.

If this happens, take the following steps:

- Install this unit as far as possible from the tuner or TV.
- Set the antenna wires from the tuner or TV away from this unit's power cord and input/output connection cords.
- Noise or disturbance tends to occur particularly when using indoor antennas or 300 Ω/ohms feeder wires. **We recommend using outdoor antennas and 75 Ω/ohms coaxial cables.**

For heat dispersal, leave at least 4 inch/10 cm of space between the top, back and sides of this unit and the wall or other components.

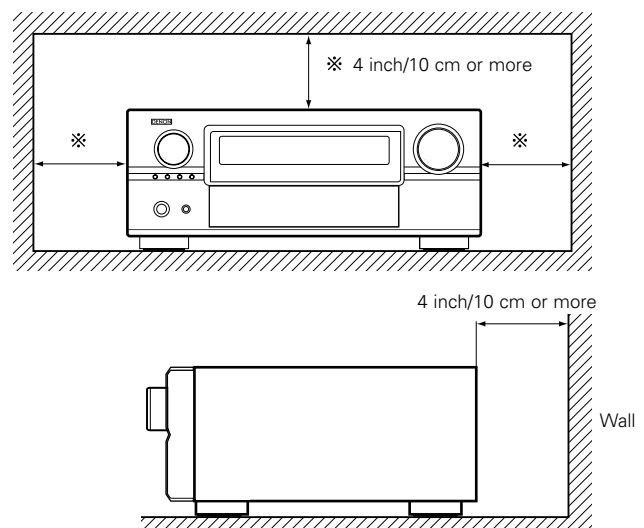

3 CAUTIONS ON HANDLING

- **Switching the input function when input jacks are not connected**
A clicking noise may be produced if the input function is switched when nothing is connected to the input jacks. If this happens, either turn down the MASTER VOLUME control or connect components to the input jacks.
- **Muting of PRE OUT jacks, HEADPHONE jack and SPEAKER terminals**
The PRE OUT jacks, HEADPHONE jack and SPEAKER terminals include a muting circuit. Because of this, the output signals are greatly reduced for several seconds after the power switch is turned on or input function, surround mode or any other-set-up is changed. If the volume is turned up during this time, the output will be very high after the muting circuit stops functioning. Always wait until the muting circuit turns off before adjusting the volume.

4 FEATURES

1. Dolby Digital

Using advanced digital processing algorithms, Dolby Digital provides up to 5.1 channels of wide-range, high fidelity surround sound. Dolby Digital is the default digital audio delivery system for DVD and North American DTV.

2. Dolby Pro Logic IIx compatibility

Dolby Pro Logic IIx furthers the matrix decoding technology of Dolby Pro Logic II to decode audio signals recorded on two channels into up to 7.1 playback channels, including the surround back channel. Dolby Pro Logic IIx also allows 5.1-channel sources to be played in up to 7.1 channels.

The mode can be selected according to the source. The Music mode is best suited for playing music, the Cinema mode for playing movies, and the Game mode for playing games. The Game mode can only be used with 2-channel audio sources.

3. Dolby Pro Logic II Game mode compatibility

In addition to the previously offered Music and Cinema modes, the AVR-3805 also offers a Game mode optimum for games.

4. DTS (Digital Theater Systems)

DTS provides up to 5.1 channels of wide-range, high fidelity surround sound, from sources such as laser disc, DVD and specially-encoded music discs.

5. DTS-ES Extended Surround and DTS Neo:6

The AVR-3805 can be decoded with DTS-ES Extended Surround, a multi-channel format developed by Digital Theater Systems Inc. The AVR-3805 can be also decoded with DTS Neo:6, a surround mode allowing 6.1 channels playback of regular stereo sources.

6. DTS 96/24 compatibility

The AVR-3805 can be decoded with sources recorded in DTS 96/24, a multi-channel digital signal format developed by Digital Theater Systems Inc.

DTS 96/24 sources can be played in the multi-channel mode on the AVR-3805 with high sound quality of 96 kHz/24 bits or 88.2 kHz/24 bits.

7. HDCD decoder equipped

Connection with a player that supports HDCD playback allows the features of HDCD to be extracted, namely the characteristics of high resolution and low distortion, and fusion with the digital technology that is contained in the AVR-3805 allows for the exhibition of the high sound quality of HDCD.

8. DENON LINK

The connection of one cable to our DVD player, which supports digital transfer, permits the digital transfer of DVD audio, and DVD multi-channel audio for an enjoyable experience of higher sound quality digital sound with low transfer losses.

9. NEW D.D.S.C-Digital

New 32-bit floating point DSP is used for digital transfer processing. Furthermore, operation of D/A and DIR at up to 192 kHz supports the digital transfer of DVD audio by DENON LINK.

- **Whenever the unit is in the STANDBY state, the apparatus is still connected on AC line voltage.**
Please be sure to turn the power off (■off) when you leave home for, say, a vacation.

10.AL24 Processing for All Channels

DENON has further developed its proprietary AL24 Processing, an analog waveform reproduction technology, to support the 192-kHz sampling frequency of DVD-Audio,AL24 Processing Plus, thoroughly suppresses quantization noise associated with D/A conversion of LPCM signals to reproduce the low-level signals with optimum clarity that will bring out all the delicate nuances of the signals with optimum clarity that will bring out all the delicate nuances of the music.

Equipped for not only the front left and right channels but also for the surround left and right, center and subwoofer channels.

11.Auto Setup/Room EQ

Use of the optional microphone for setup applications measures the presence of speakers, the distance to the speakers, and other information, and permits automatic setup. The characteristics of each speaker can also be corrected.

Auto setup requires an optional microphone for setup use.

12.Dual Surround Speaker Mode

Provides for the first time the ability to optimize surround sound reproduction using two different types of surround sound speakers as well as two different surround speaker positions:

(1) Movie Surround

Motion picture soundtracks use the surround channel(s) to provide the ambient elements of the acoustic environment they want the audience to realize. This is best accomplished by the use of specially-designed surround speakers that offer a wide diffusion pattern (bipolar dispersion) or by using surround speakers that provide broad dispersion with a minimum of on-axis localization (dipolar dispersion). Side wall mounting (closer to the ceiling) of the surround speakers provides the greatest envelopment, minimizing localization of direct sound from the speakers.

(2) Music Surround

With full range discrete surround channels, as well as three discrete full range front channels, digital formats such as Dolby and DTS offer thrilling surround sound music listening. Producers of multi-channel discrete digital music recordings almost always favor the use of direct radiating (monopolar) surround speakers, placed in the rear corners of the room, since that is how they configure their studios during the mixing/creation process.

The DENON AVR-3805 provides the ability to connect two different sets of surround speakers, and place them in the appropriate locations in your AV theater room, so that you can enjoy both movie soundtracks and music listening, with optimum results and no compromise.

13.Multi Zone Music Entertainment System

Multi Source Function:

This unit's Multi Source function lets you select different audio sources for listening. Different sources can thus be enjoyed in the main room (MAIN) and the subroom (ZONE2 and ZONE3) simultaneously.

14.Future Sound Format Upgrade Capability via Eight Channel Inputs & Outputs

For future multi-channel audio format(s), the AVR-3805 is provided with 7.1 channel (seven main channels, plus one low frequency effects channel) inputs, along with a full set of 7.1 channel pre-amp outputs, controlled by the 8 channel master volume control. This assures future upgrade possibilities for any future multi-channel sound format.

15.Front input Terminal

The unit is equipped with a Front Input connector for the convenient connection of a video camera or other equipment.

16.Video Conversion Function

The AVR-3805 is equipped with a function for up-converting video signals.

Because of this, the AVR-3805's MONITOR OUT jack can be connected to the monitor (TV) with a set of cables offering a higher quality connection, regardless of how the player and the AVR-3805's video input jacks are connected.

17.Component Video Switching

In addition to composite video and "S" video switching, the AVR-3805 provides 3 sets of component video (Y, Pb/Cb, Pr/Cr) inputs, and one set of component video outputs to the television, for superior picture quality.

18.TRIGGER OUT

AVR-3805 is equipped with 2 systems of 12V TRIGGER OUT connections. Each output can be activated upon the selection of assigned. Main Zone inputs or zone2 inputs or zone3 inputs.

19.RS-232C Terminal

Includes a RS-232C port to support an AMX, Crestron integrated control system.

20.AC INLET

Detachable AC CORD is used.

21.Auto Surround Mode

This function stores the surround mode last used for an input signal in the memory and automatically sets that surround mode the next time that signal is input.

22.EL Foil Remote

An EL Foil remote with improved operational qualities is used which displays only the keys required by the device.

23.Large-sized fluorescent display

A large-sized fluorescent display is used which also permits a check of the input/output channels.

24.Audio delay

This is a function for delaying the audio signal with respect to the video signal. (0 to 200 msec)

25.Preset Memory Tuning

56-Station AM/FM Random Preset Memory tuning.

5 CONNECTIONS

- Do not plug in the AC cord until all connections have been completed.
- Be sure to connect the left and right channels properly (left with left, right with right).
- Insert the plugs securely. Incomplete connections will result in the generation of noise.
- **Use the AC OUTLETS for audio equipment only. Do not use them for hair driers, etc.**

- Note that binding pin plug cords together with AC cords or placing them near a power transformer will result in generating hum or other noise.
- Noise or humming may be generated if a connected audio equipment is used independently without turning the power of this unit on. If this happens, turn on the power of the this unit.

Connecting the audio components

- When making connections, also refer to the operating instructions of the other components.

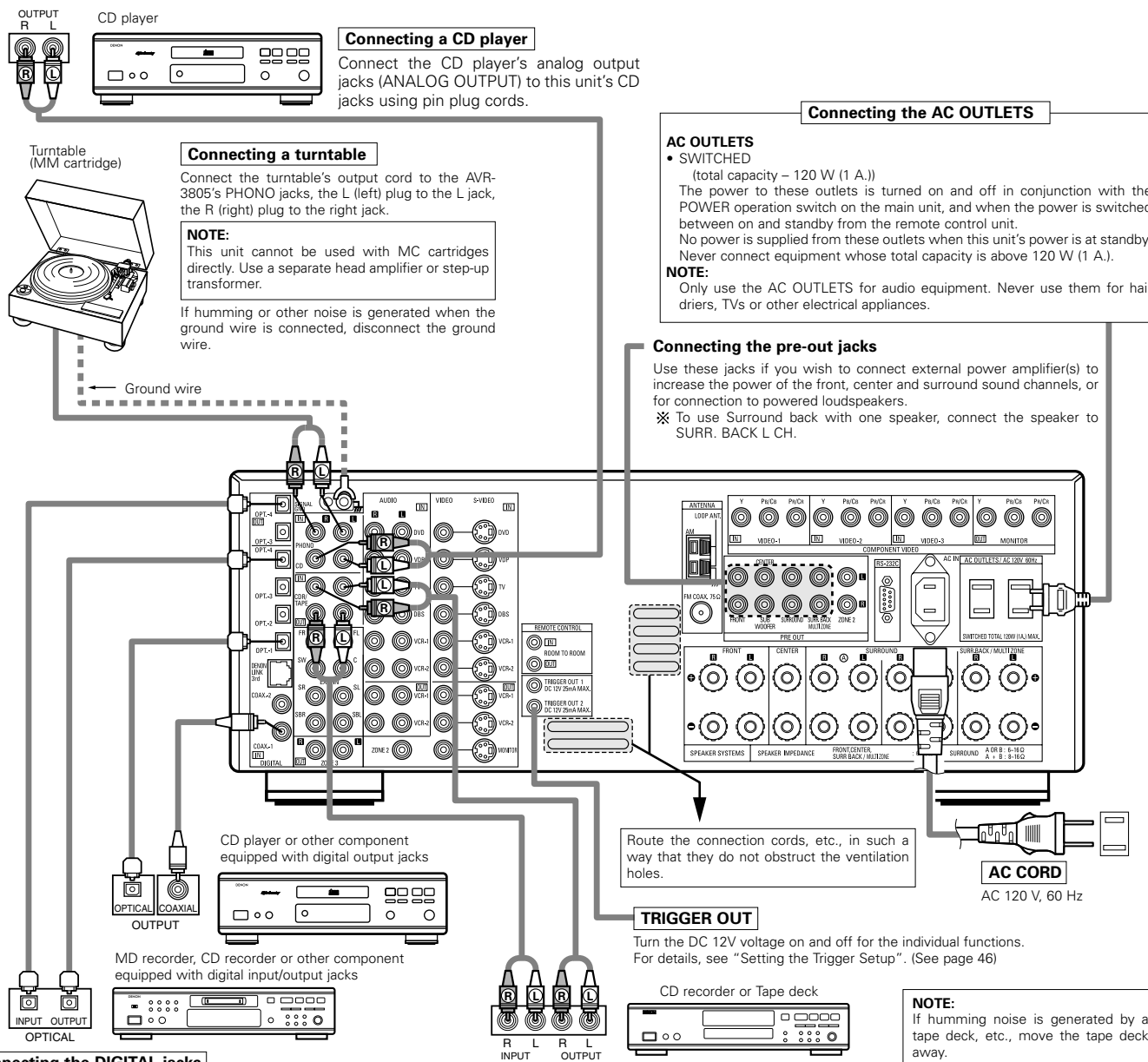

Connecting the video components

- To connect the video signal, connect using a 75 Ω/ohms video signal cable cord. Using an improper cable can result in a drop in video quality.
- When making connections, also refer to the operating instructions of the other components.
- The AVR-3805 is equipped with a function for up-converting video signals.
- The signal connected to the video signal terminal is output to the S-Video and component video monitor out terminals.
- The REC OUT terminals have no conversion function, so when recording only connect the video terminals.

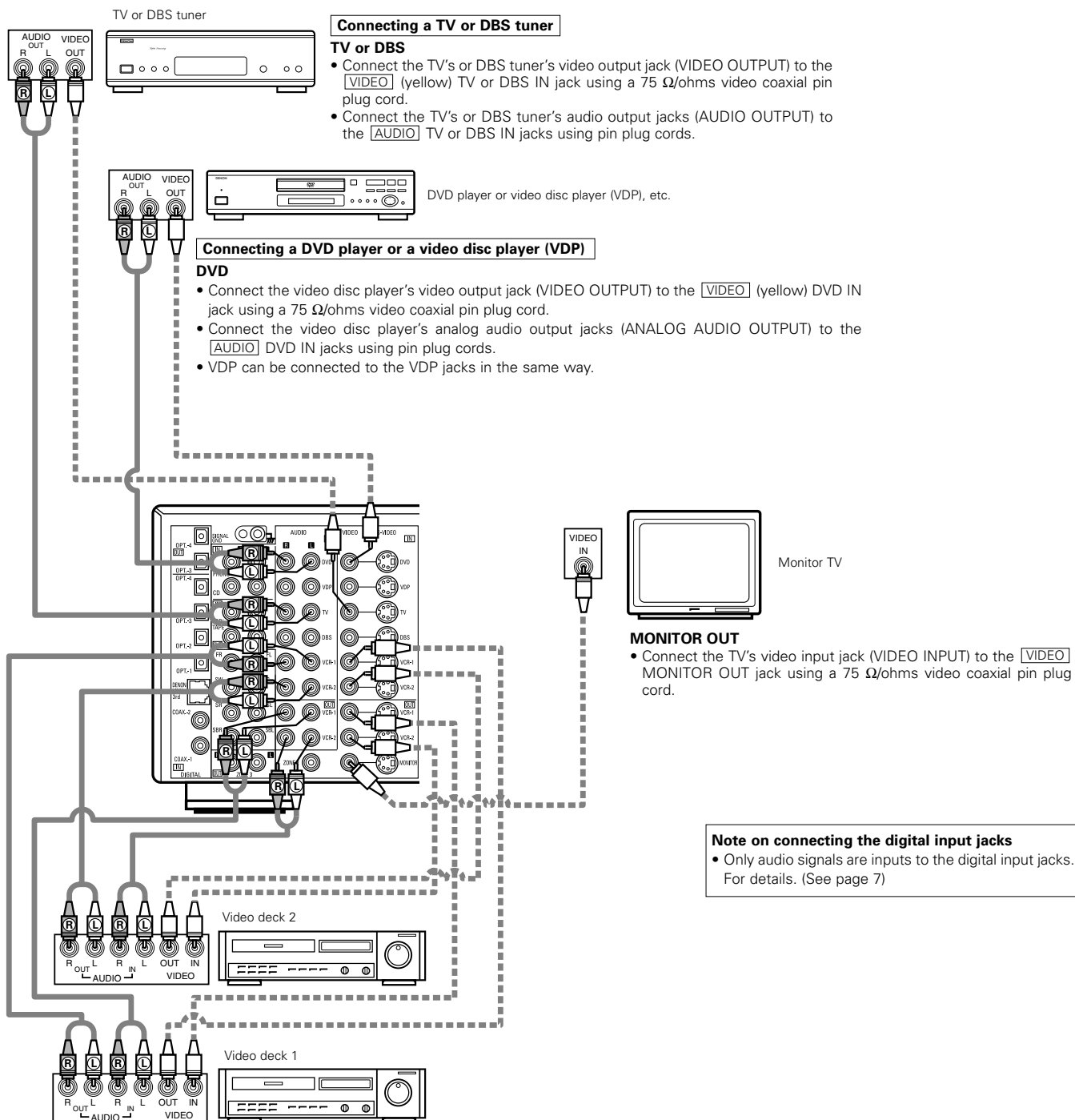

Connecting a video decks

- There are two sets of video deck (VCR) jacks, so two video decks can be connected for simultaneous recording or video copying.

Video input/output connections:

- Connect the video deck's video output jack (VIDEO OUT) to the **VIDEO** (yellow) VCR-1 IN jack, and the video deck's video input jack (VIDEO IN) to the **VIDEO** (yellow) VCR-1 OUT jack using 75 Ω/ohms video coaxial pin plug cords.

Connecting the audio output jacks

- Connect the video deck's audio output jacks (AUDIO OUT) to the **AUDIO** VCR-1 IN jacks, and the video deck's audio input jacks (AUDIO IN) to the **AUDIO** VCR-1 OUT jacks using pin plug cords.

※ Connect the second video deck to the VCR-2 jacks in the same way.

Connecting the video components equipped with S-Video jacks

- When making connections, also refer to the operating instructions of the other components.
- **A note on the S input jacks**
The input selectors for the S inputs and Video inputs work in conjunction with each other.
- The AVR-3805 is equipped with a function for converting video signals.
- The signal connected to the S-Video signal terminal is output to the composite video and component video monitor out terminals.
- The REC OUT terminals have no conversion function, so when recording only connect the S-Video terminals.

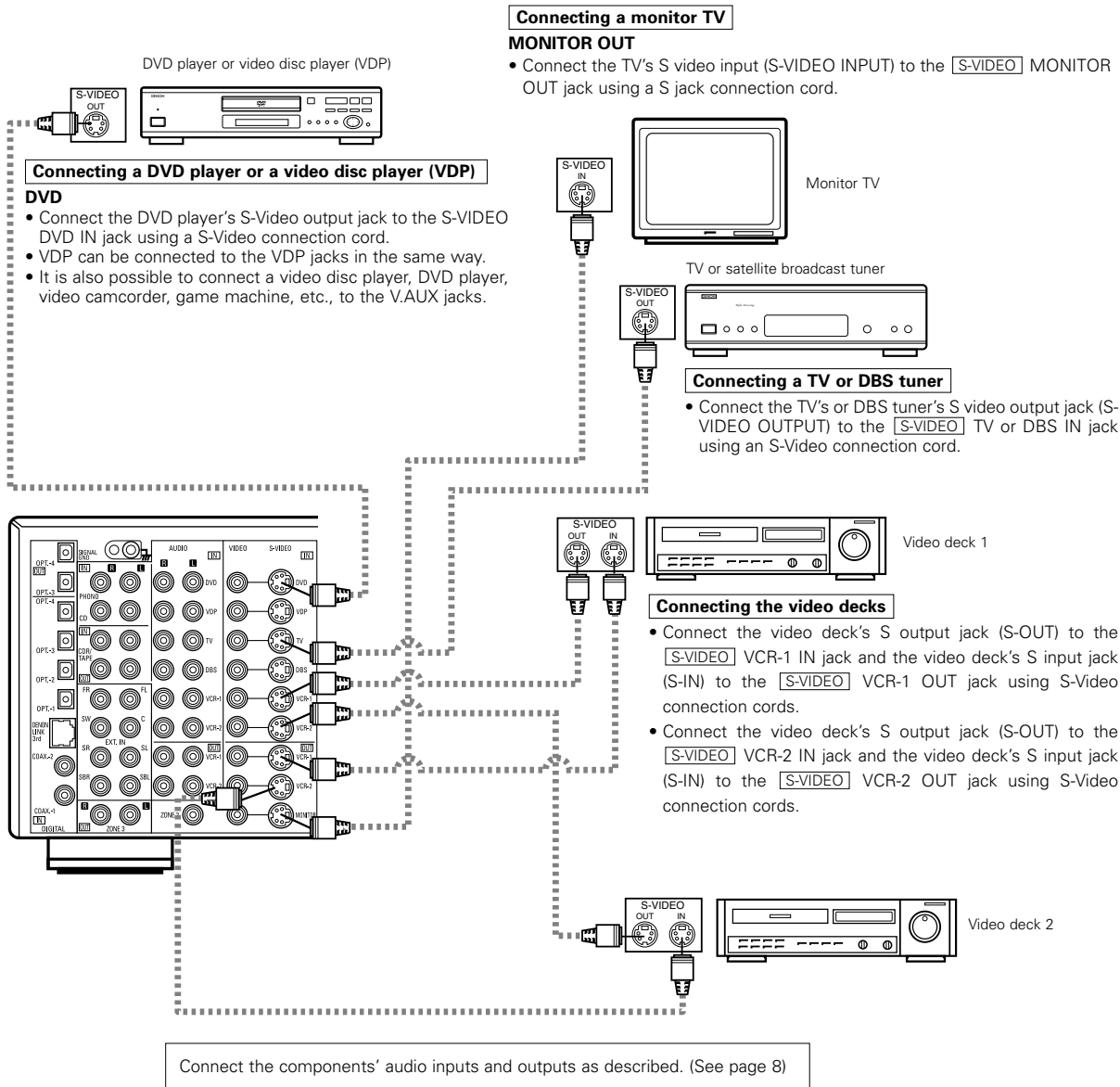

Connecting the video component equipped with Color Difference (Component - Y, Pr/Cr, Pb/Cb) Video jacks

- When making connections, also refer to the operating instructions of the other components.
- The signals input to the color difference (component) video jacks are not outputs to the VIDEO output jack (yellow) or the S-Video output jack.
- Some video sources with component video outputs are labeled Y, Cb, Cr, or Y, Pb, Pr, or Y, R-Y, B-Y. These terms all refer to component video color difference output.
- The function assigned to the component video input can be changed at the system setup. For details, see "Setting the Video Input Mode". (See page 41)

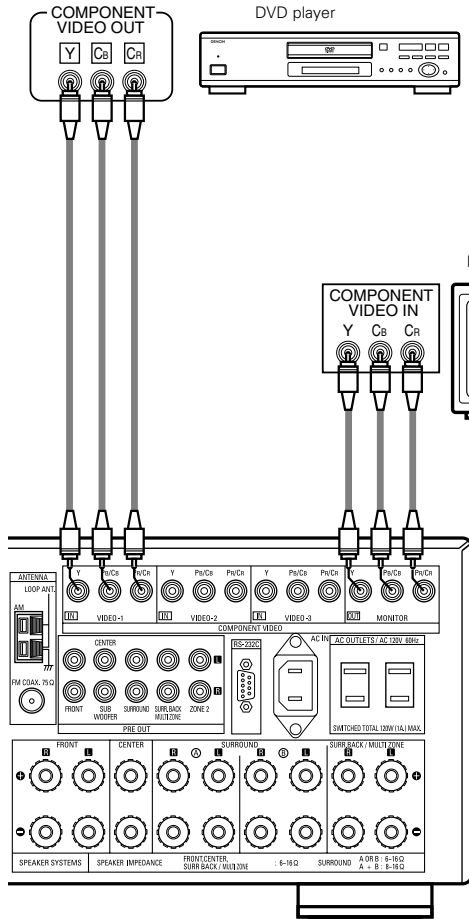

Connecting a DVD player

DVD IN jacks

- Connect the DVD player's color difference (component) video output jacks (COMPONENT VIDEO OUTPUT) to the COMPONENT VIDEO-1 IN jack using 75 Ω/ohms coaxial video pin-plug cords.
- In the same way, another video source with component video outputs such as a TV/DBS tuner, etc., can be connected to the VIDEO-2 color difference (component) video jacks.

Connecting a monitor TV

MONITOR OUT jack

- Connect the TV's color difference (component) video input jacks (COMPONENT VIDEO INPUT) to the COMPONENT MONITOR OUT jack using 75 Ω/ohms coaxial video pin-plug cords.

- The color difference input jacks may be indicated differently on some TVs, monitors or video components ("Cr, Cb and Y", "R-Y, B-Y and Y", "Pr, Pb and Y", etc.). For details, carefully read the operating instructions included with the TV or other component.

MONITOR OUT jacks

The AVR-3805 is equipped with a function for up-converting video signals.

Because of this, the AVR-3805's MONITOR OUT jack can be connected to the monitor (TV) with a set of cables offering a higher quality connection, regardless of how the player and the AVR-3805's video input jacks are connected.

Generally speaking, connections using the component video jacks offer the highest quality playback, followed by connections using the S-Video jacks, then connections using the regular video jacks (yellow).

NOTE:

Down-converting from the component video signal to the S-Video and composite video signal is not possible, so when not using the component video monitor output terminal connect the player using the S-Video or composite video input terminal.

Cautions on the video conversion function:

When the component video terminals are used to connect the AVR-3805 with a TV (or monitor, projector, etc.) and the video (yellow) or S video terminals are used to connect the AVR-3805 with a VTR, depending on the combination of the TV and VTR the picture may flicker in the horizontal direction, be distorted, be out of sync or not display at all when playing video tapes.

If this happens, connect a commercially available video stabilizer, etc., with a TBC (time base corrector) function between the AVR-3805 and the VTR, or if your VTR has a TBC function, turn it on.

The Video Conversion Function

With the AVR-3805, the Video signal and the S-video signal which were inputted are converted mutually. And also the Video signal and the S-Video signal which were inputted are converted into a higher quality.

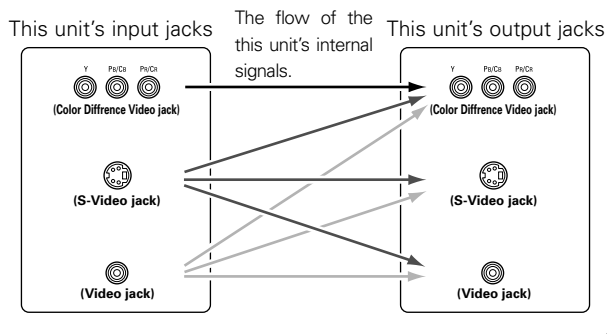

Connecting the MULTI ZONE jacks

※ For instructions on operations using the MULTI ZONE FUNCTIONS. (See page 69 ~ 71)

[1] ZONE 2 preout CONNECTIONS

- If another power amplifier or pre-main (integrated) amplifier is connected, the ZONE2 preout (variable/fixed level) jacks can be used to play a different program source in ZONE2 the same time. (See page 71)
- The ZONE2 video out is only for the ZONE2.

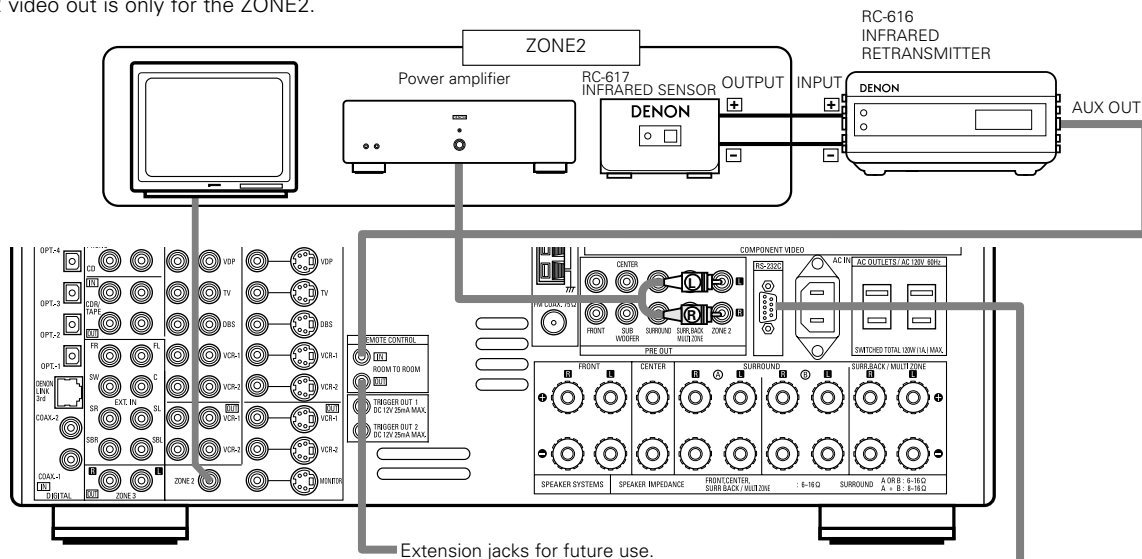

CONTROL terminal

Perform the following operation before using an external controller connected to the RS-232C terminal:

1. Press the ON/STANDBY button on the main unit and set the unit to the operating mode.
2. Perform the operation to turn off the power from the external control.
3. Check that the product has been set to the standby mode.

After checking the above, check the connections of the external controller. Operation is possible.

[2] ZONE 3 FIXEDOUT CONNECTIONS

- If another pre-main (integrated) amplifier is connected, the ZONE3 Fixed-OUT jacks can be used to play a different program source in ZONE3 the same time. (See page 71)

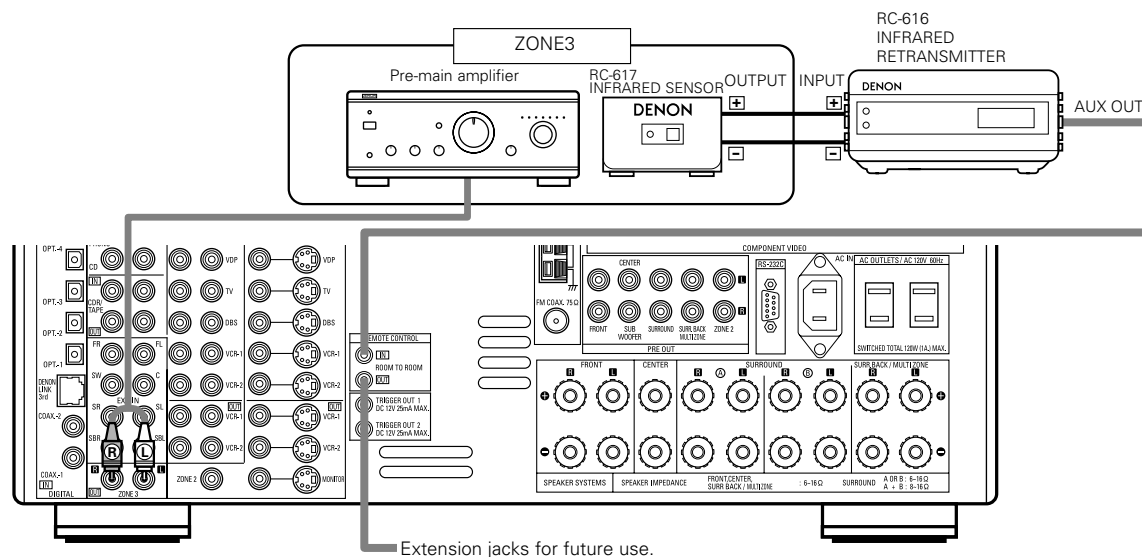

[3] ZONE2/ZONE3 SPEAKER OUT and PREOUT CONNECTIONS

- If another power amplifier or pre-main (integrated) amplifier is connected, the ZONE2/ZONE3 output terminals can be used to play a different program source in ZONE2/ZONE3 the same time.
- ZONE2/ZONE3 SPEAKER OUT can be used when "ZONE2/ZONE3" is selected at System Setup Menu "Power Amp Assign". In this case, Surround Back Speaker OUT cannot be used for MAIN ZONE. (See page 45)

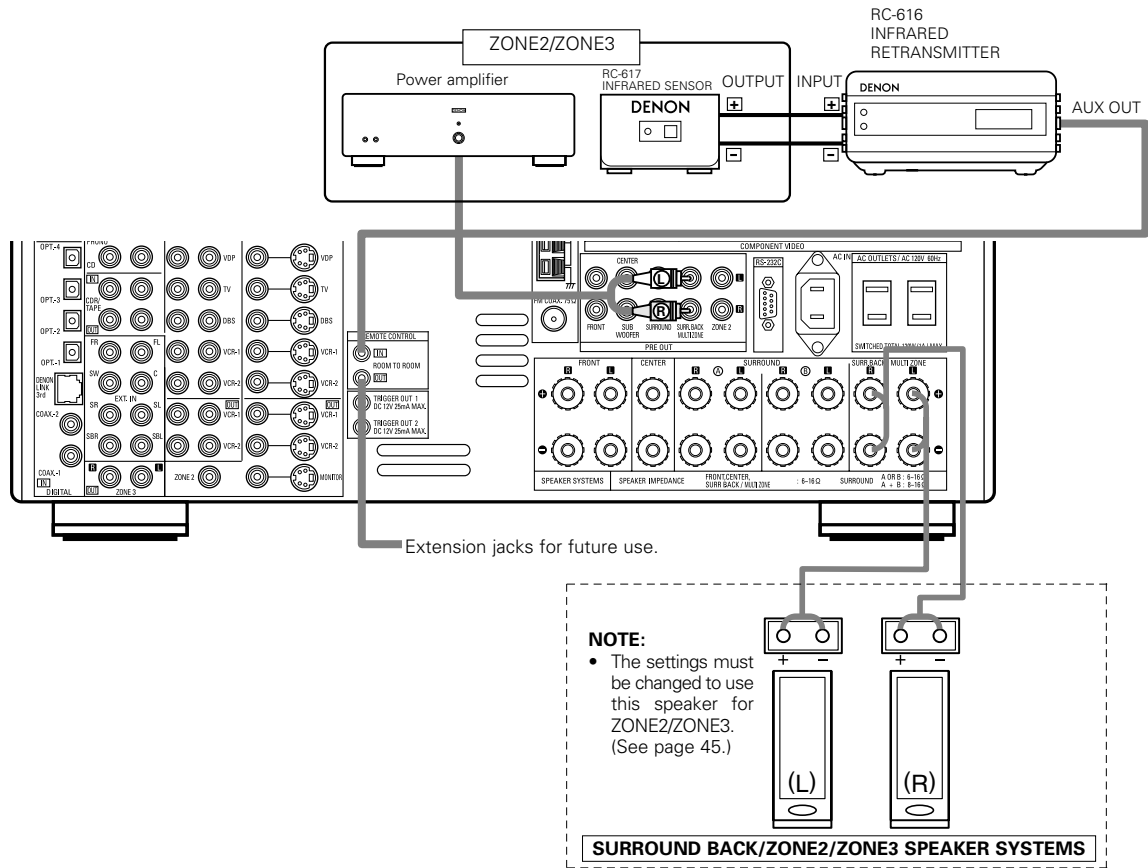

Connecting the video component equipped with V. AUX jacks

To connect the video signal, connect using a 75 Ω/ohms video signal cable cord.

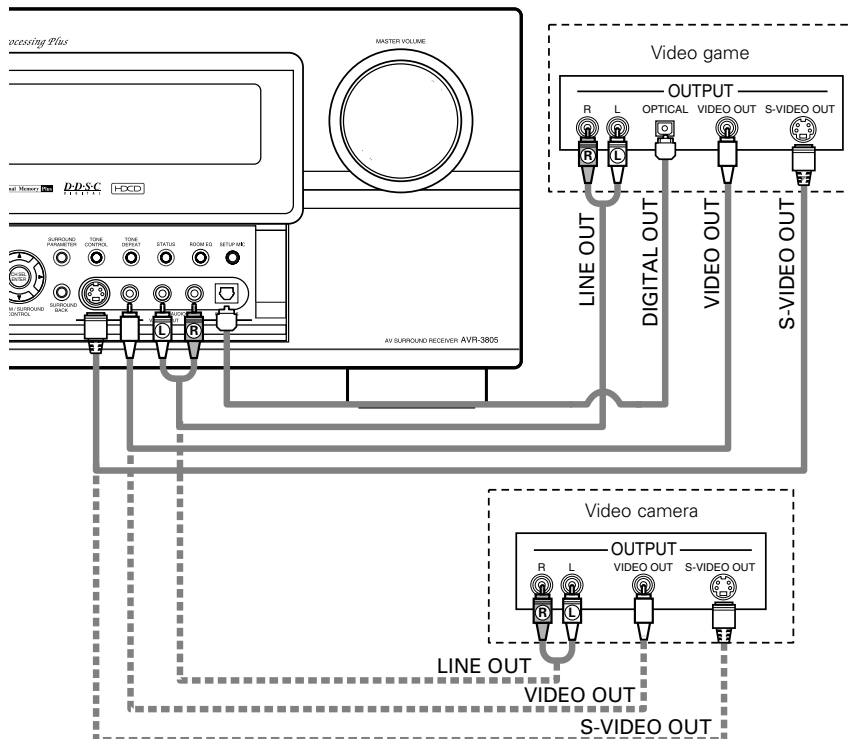

Connecting a Video game component

- Connect the Video game component's output jacks to this unit's V. AUX INPUT jacks.

Connecting a video camera component

- Connect the video camera component's output jacks to this unit's V. AUX INPUT jacks.

DENON LINK connections

High quality digital sound with reduced digital signal transfer loss can be enjoyed by connecting a separately sold DENON LINK compatible DVD Player.

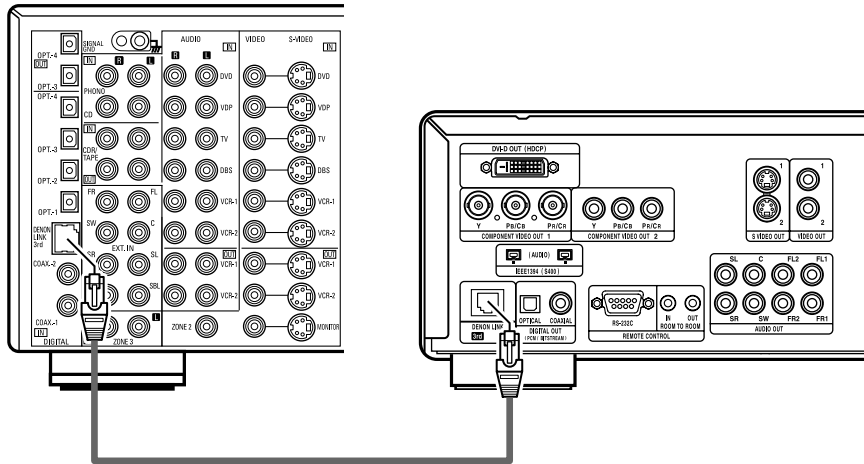

■ Playback using the DENON Link connector

Digital transfer and multi-channel playback of DVD audio discs and other multi-channel sources is possible by connecting the AVR-3805 to a Denon DVD player equipped with a DENON LINK connector using the connection cable included with the DVD player.

■ DENON LINK Setting

When a DENON DVD player and the DENON LINK have been connected, be sure to make a setting to "DENON LINK" with the System Setup Digital In Assignment. (See page 39)

- Select the input for the playback of signals that cannot be transferred by DENON LINK.
- When the input mode is AUTO and DENON LINK has become unlocked, the unit automatically changes over to the set connector (ANALOG or EXT. IN).

1

Select the digital input jack to be assigned to the input source.

① Select input source.

② Select input jack.

(Remote control unit) (Main unit)

(Remote control unit) (Main unit)

3-1. Digital In Assign

<input type="checkbox"/> CD]: COAX1	<input type="checkbox"/> VCR2]: OFF
<input checked="" type="checkbox"/> DVD]: DLINK	<input type="checkbox"/> TAPE]: OPT4
<input type="checkbox"/> VDP]: OPT1	
<input type="checkbox"/> TV]: OFF	
<input type="checkbox"/> DBS]: OPT2	DLINK
<input type="checkbox"/> VAUX]: OPT5	No Signal
<input type="checkbox"/> VCR1]: OPT3	◀EXT. IN▶
	Default [Yes]

3 /

*Digital In
DVD : ◀DLINK▶

2

① Select DLINK setting.

② Select input signal.

(Remote control unit) (Main unit)

(Remote control unit) (Main unit)

3-1. Digital In Assign

<input type="checkbox"/> CD]: COAX1	<input type="checkbox"/> VCR2]: OFF
<input type="checkbox"/> DVD]: DLINK	<input type="checkbox"/> TAPE]: OPT4
<input type="checkbox"/> VDP]: OPT1	
<input type="checkbox"/> TV]: OFF	
<input type="checkbox"/> DBS]: OPT2	DLINK
<input type="checkbox"/> VAUX]: OPT5	No Signal
<input type="checkbox"/> VCR1]: OPT3	◀EXT. IN▶
	Default [Yes]

3 /

*Digital In
NoSig.: ◀EXT. IN▶

14

Speaker system connections

- Connect the speaker terminals with the speakers making sure that like polarities are matched (⊕ with ⊕, ⊖ with ⊖). Mismatching of polarities will result in weak central sound, unclear orientation of the various instruments, and the sense of direction of the stereo being impaired.
- When making connections, take care that none of the individual conductors of the speaker cord come in contact with adjacent terminals, with other speaker cord conductors, or with the rear panel.

NOTE:
NEVER touch the speaker terminals when the power is on.
Doing so could result in electric shocks.

Speaker Impedance

- Speakers with an impedance of from 6 to 16 Ω/ohms can be connected for use as front and center speakers.
- Speakers with an impedance of 6 to 16 Ω/ohms can be connected for use as surround speakers.
- Be careful when using two pairs of surround speakers (A + B) at the same time, since use of speakers with an impedance of less than 8 Ω/ohms will lead to damage.
- The protector circuit may be activated if the set is played for long periods of time at high volumes when speakers with an impedance lower than the specified impedance are connected.

Connection the speaker terminals

1. Loosen by turning counterclockwise

2. Insert the cord.

3. Tighten by turning clockwise.

Either tightly twist or terminate the core wires.

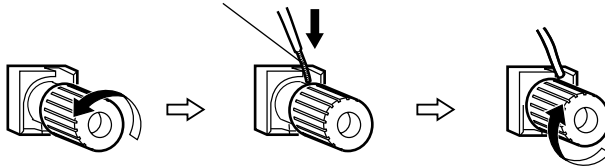

Connecting banana plugs

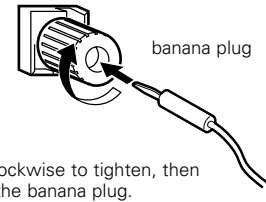

Connections

- When making connections, also refer to the operating instructions of the other components.

Connection jack for subwoofer with built-in amplifier (super woofer), etc.

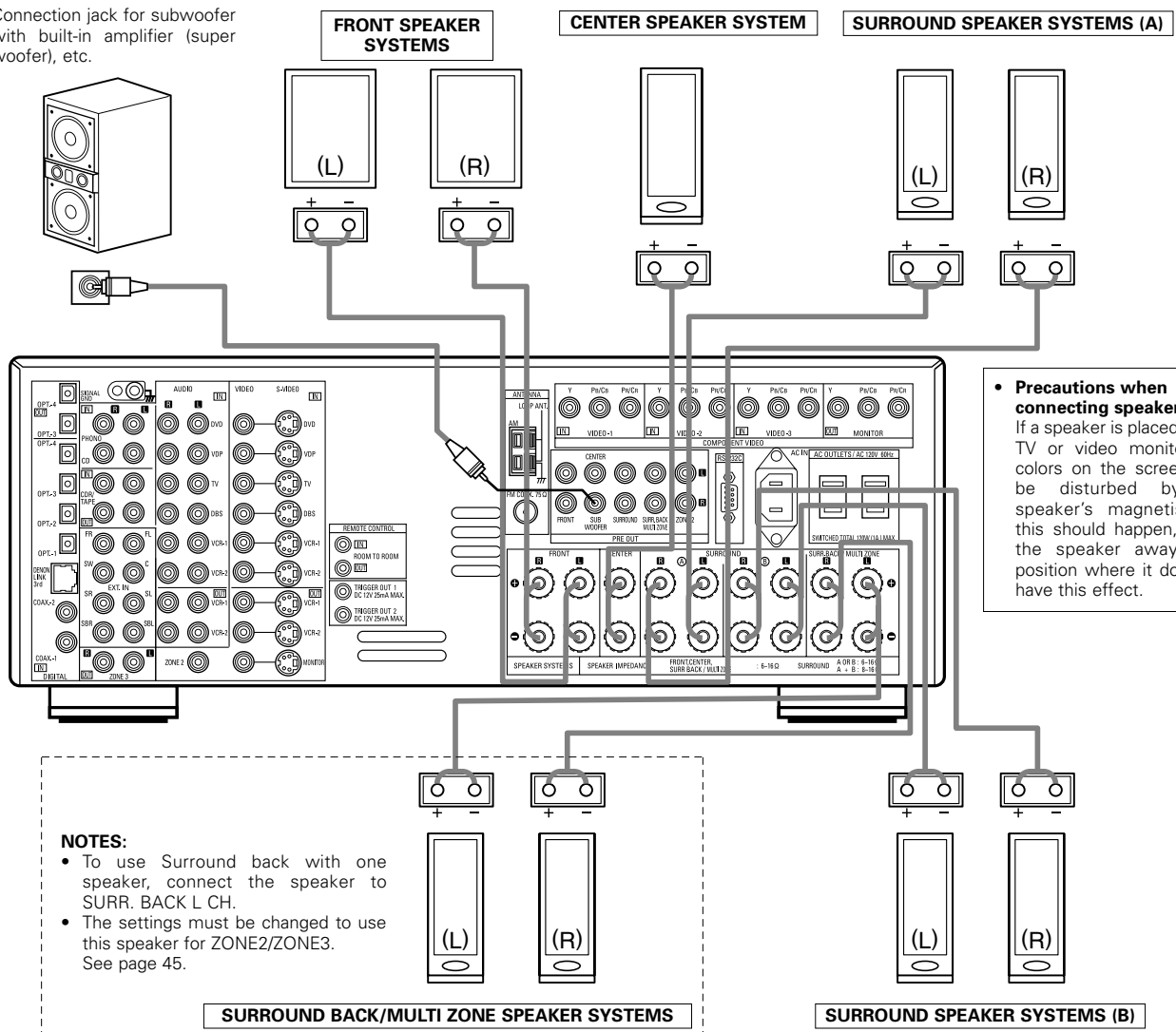

Protector circuit

- This unit is equipped with a high-speed protection circuit. The purpose of this circuit is to protect the speakers under circumstances such as when the output of the power amplifier is inadvertently short-circuited and a large current flows, when the temperature surrounding the unit becomes unusually high, or when the unit is used at high output over a long period which results in an extreme temperature rise.

When the protection circuit is activated, the speaker output is cut off and the power supply indicator LED flashes. Should this occur, please follow these steps: be sure to switch off the power of this unit, check whether there are any faults with the wiring of the speaker cables or input cables, and wait for the unit to cool down if it is very hot. Improve the ventilation condition around the unit and switch the power back on.

If the protection circuit is activated again even though there are no problems with the wiring or the ventilation around the unit, switch off the power and contact a DENON service center.

Note on speaker impedance

- The protector circuit may be activated if the set is played for long periods of time at high volumes when speakers with an impedance lower than the specified impedance (for example speakers with an impedance of lower than 4 Ω /ohms) are connected. If the protector circuit is activated, the speaker output is cut off. Turn off the set's power, wait for the set to cool down, improve the ventilation around the set, then turn the power back on.

6 PART NAMES AND FUNCTIONS

Front Panel

- For details on the functions of these parts, refer to the pages given in parentheses ().

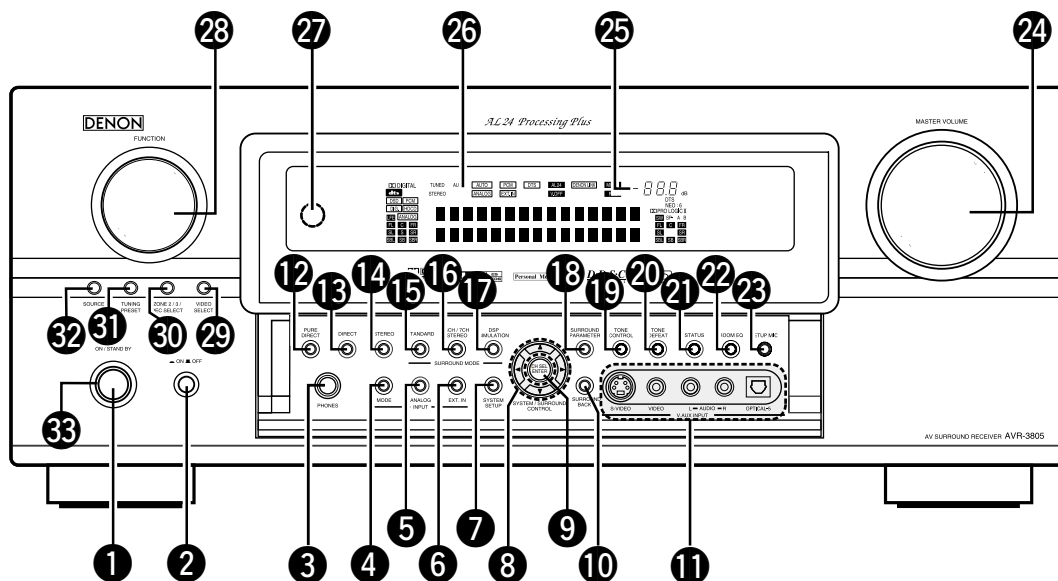

- | | |
|--|---|
| 1 Power ON/STANDBY switch.....(62) | 17 DSP SIMULATION button.....(80, 81) |
| 2 Power switch.....(62, 87) | 18 SURROUND PARAMETER button.....(74 ~ 78) |
| 3 Headphone jack (PHONES).....(67) | 19 TONE CONTROL button.....(67, 82, 83) |
| 4 INPUT MODE button.....(63) | 20 TONE DEFEAT button.....(67) |
| 5 ANALOG button.....(63) | 21 STATUS button.....(68) |
| 6 EXT. IN button.....(63, 65) | 22 ROOM EQ button.....(28) |
| 7 SYSTEM SETUP button.....(22, 49, 78) | 23 SETUP MIC jack.....(23) |
| 8 CURSOR button | 24 MASTER VOLUME control.....(64) |
| 9 CH SELECT/ENTER button | 25 MASTER VOLUME indicator.....(64) |
| 10 SURROUND BACK button.....(76) | 26 Display |
| 11 V.AUX input jacks.....(13) | 27 Remote control sensor (REMOTE SENSOR).....(50) |
| 12 PURE DIRECT button.....(66) | 28 FUNCTION knob.....(63, 67, 68, 71, 87) |
| 13 DIRECT button.....(66) | 29 VIDEO SELECT button.....(67) |
| 14 STEREO button.....(66) | 30 ZONE2/3/REC SELECT button.....(68, 71) |
| 15 STANDARD button.....(73 ~ 77) | 31 TUNING PRESET button.....(87) |
| 16 5CH/7CH STEREO button.....(80) | 32 SOURCE button.....(63, 67) |
| | 33 POWER indicator.....(62) |

Display

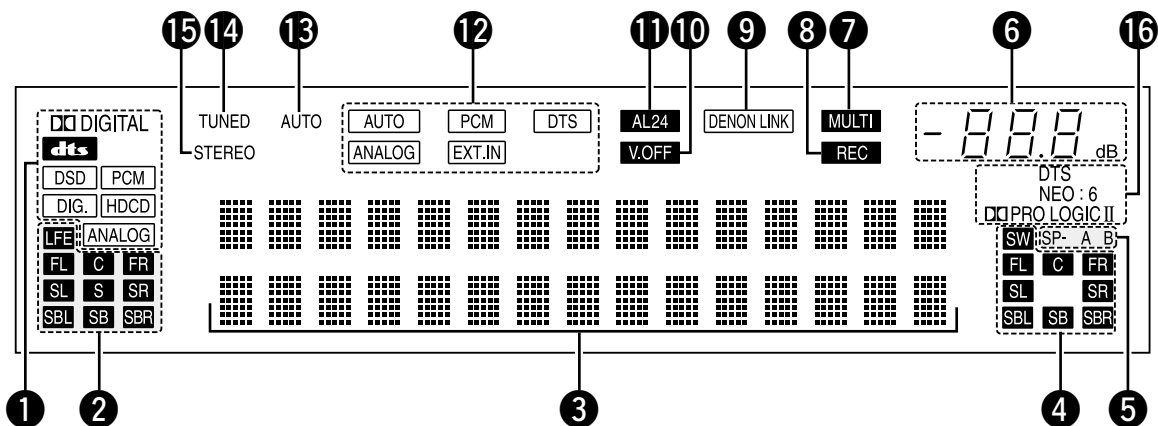

- 1** INPUT SIGNAL indicator
The respective indicator will light corresponding to the input signal.
- 2** INPUT SIGNAL CHANNEL indicator
The channels included in the input source will light.
- 3** Information display
This displays the surround mode, function name or setting value, etc.
- 4** Output signal channel indicator
The audio channels output from this unit will light.
- 5** SPEAKER indicator
This lights corresponding to the settings of the surround speakers of the various surround modes.
- 6** MASTER VOLUME indicator
This displays the volume level.
The Setup item number is displayed in System Setup.
- 7** MULTI(ZONE) indicator
ZONE2 mode is selected in ZONE2/REC SELECT.
- 8** REC OUT SOURCE indicator.
REC OUT mode is selected in ZONE2/REC SELECT.
- 9** DENON LINK indicator
This lights during playback in a DENON LINK connection.
- 10** V.OFF indicator
This lights when the operation of the video circuit has been turned off.
- 11** AL24 indicator
The AL24 indicator lights when the PURE DIRECT, DIRECT, STEREO, MULTI PURE DIRECT, MULTI CH DIRECT, MULTI CH IN mode is selected in the PCM input signal.
- 12** Input mode indicator
This lights corresponding to the setting of the INPUT mode.
- 13** AUTO indicator
This lights when the broadcast station is selected in the AUTO tuning mode.
- 14** TUNED indicator
This lights when an FM/AM broadcast has been received.
- 15** STEREO indicator
This lights when an FM stereo broadcast has been received.
- 16** Decoder indicator
This lights when each decoder is operating.

Remote control unit

- For details on the functions of these parts, refer to the pages given in parentheses ().

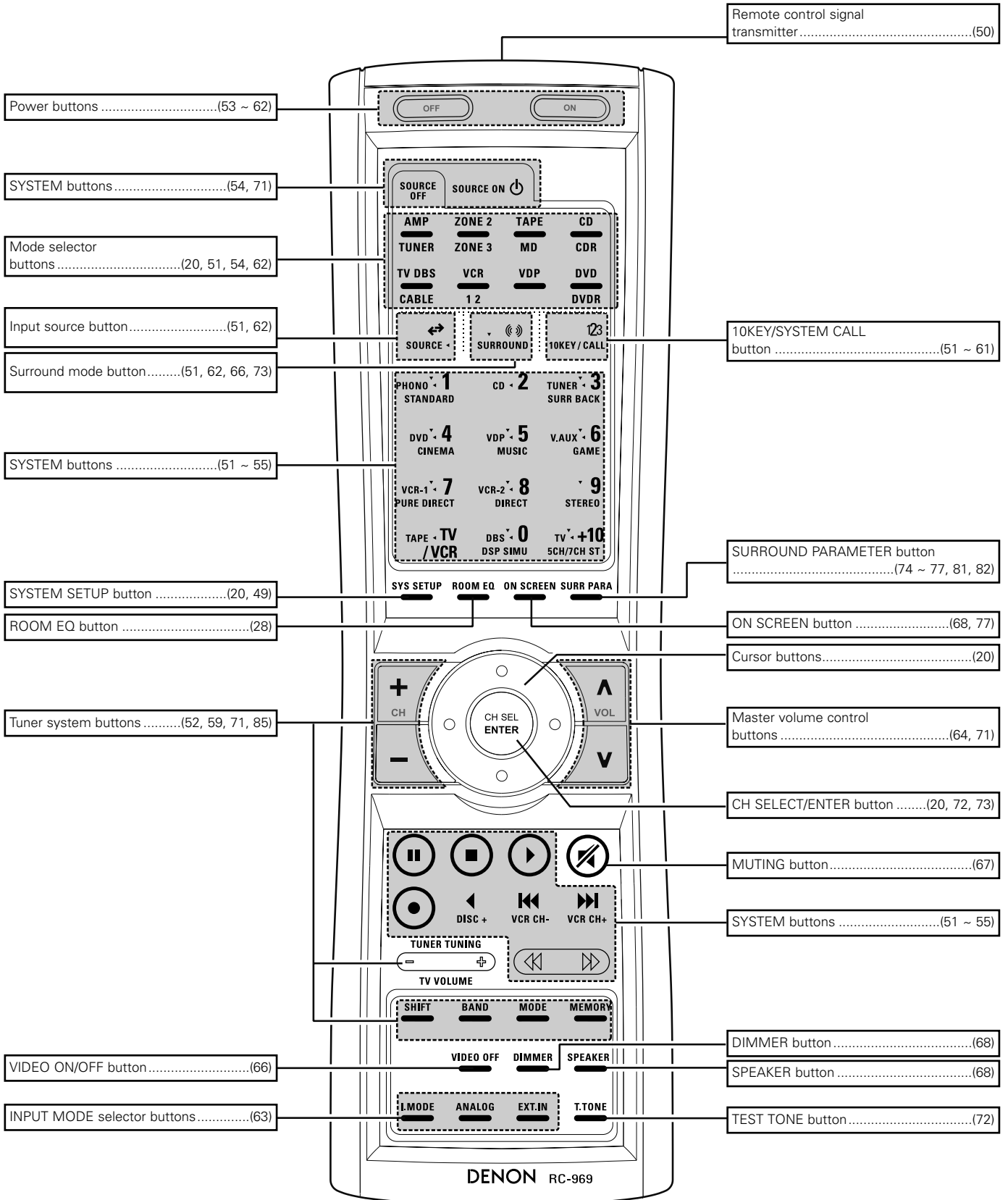

7 SETTING UP THE SYSTEM

- Once all connections with other AV components have been completed as described in "CONNECTIONS" (see pages 7 to 16), make the various settings described below on the monitor screen using the AVR-3805's on-screen display function. These settings are required to set up the listening room's AV system centered around the AVR-3805.

Use the following buttons to set up the system

- Use the following buttons to set up the system.

- 1 Check that the remote control unit set to AMP mode.

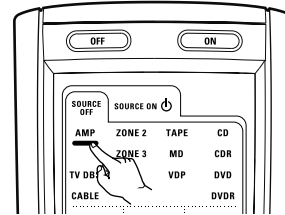

- 2

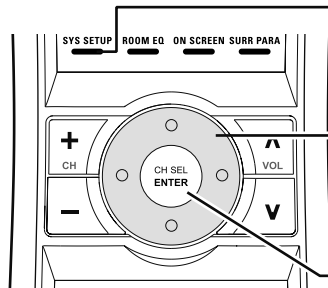

- SYSTEM SETUP button**
Press this to display the system setup menu.
- CURSOR buttons**
Use these to move the cursors the left, right, up and down on the screen
- ENTER button**
Press this to switch the display. Also use this button to complete the setting.

- System setup items and default values (set upon shipment from the factory)

1. Auto Setup/Room EQ

Auto Setup/Room EQ				Default settings
1	Auto Setup	Power Amp Assignment	Set this to switch the surround back channel's power amplifier for use for zone2 or zone3.	SURROUND BACK
2	Manual EQ Setup		This parameter is for optimizing the Room EQ with which the audio signals are produced from the speakers.	All Channel and Frequency=0dB
3	Room EQ Setup		Set the Room EQ setting with All or Assign for each surround mode.	All
4	Direct Mode Setup		Set the ON/OFF setting of Room EQ, in the case of the surround mode is in Direct or Pure Direct.	OFF
5	Mic Input Select		Set this to switch the Mic Input jack for use for Mic or V.Aux L-channel input jack.	Mic

2. Speaker Setup

Speaker Setup				Default settings							
1	Speaker Configuration	Input the combination of speakers in your system and their corresponding sizes (SMALL for regular speakers, LARGE for full-size, full-range) to automatically set the composition of the signals output from the speakers and the frequency response.	Surround mode	Front Sp.	Center Sp.	Subwoofer	Surround Sp. A / B	Surround Back Sp.	Surround speaker		
				Large	Small	Yes	Small	Small / 2spkr			
2	Delay Time	This parameter is for optimizing the timing with which the audio signals are produced from the speakers and subwoofer according to the listening position.	Surround speaker	Front L & R	Center	Subwoofer	Surround L & R	SBL & SBR			
				12 ft (3.6 m)	12 ft (3.6 m)	12 ft (3.6 m)	10 ft (3.0 m)	10 ft (3.0 m)			
3	Channel Level	This adjusts the volume of the signals output from the speakers and subwoofer for the different channels in order to obtain optimum effects.	Surround speaker	Front L	Front R	Center	Surround L	Surround R	Surround Back L	Surround Back R	Subwoofer
				0 dB	0 dB	0 dB	0 dB	0 dB	0 dB	0 dB	0 dB
4	Crossover Frequency	Set the frequency (Hz) below which the bass so of the various speaker is to be output from the subwoofer.		80Hz							
5	Subwoofer mode	This selects the subwoofer speaker for playing deep bass signals.		LFE							
6	(Surround Speaker Setting)	Use this function when using multiple surround speaker combinations for more ideal surround sound. Once the combinations of surround speakers to be used for the different surround modes are preset, the surround speakers are selected automatically according to the surround mode.	Surround speaker	DOLBY/DTS CINEMA	DOLBY/DTS MUSIC	DOLBY/PL IIX GAME	WIDE SCREEN	5CH/7CH STEREO	DSP SIMULATION	MULTI CH MODE	EXT.IN
				A	A	A	A	A	A	A	A

3. Input Setup

Input Setup				Default settings								
1	Digital In Assignment	This assigns the digital input jacks for the different input sources.	Input source	CD	DVD	VDP	TV	DBS	V. AUX	VCR-1	VCR-2	CDR/TAPE
			Digital inputs	COAX1	COAX2	OPT1	OFF	OPT2	OPT5	OPT3	OFF	OPT4
2	Ext. In Subwoofer Level	Set the Ext. In Subwoofer terminal playback level.	Subwoofer = +15 dB									
3	Component In Assign	This assigns the color difference (component) video input jacks for the different input sources.	DVD	VDP	TV	DBS	VCR-1	VCR-2	V. AUX	—	—	
			VIDEO1	NONE	VIDEO2	VIDEO3	NONE	NONE	NONE	—	—	
4	Video Input Mode	Set the input signal to be output from the monitor output terminal.	AUTO									
5	Auto Tuner Presets	FM stations are received automatically and stored in the memory.	A1 ~ A8	87.5/89.1/98.1/107.9/90.1/90.1/90.1/90.1 MHz								
			B1 ~ B8	520/600/1000/1400/1500/1710 kHz/90.1/90.1 MHz								
			C1 ~ C8	90.1 MHz								
			D1 ~ D8	90.1 MHz								
			E1 ~ E8	90.1 MHz								
			F1 ~ F8	90.1 MHz								
			G1 ~ G8	90.1 MHz								

4. Advanced Playback

Advanced Playback			Default settings			
1	Audio Delay	Set the audio delay to delay time the sound and synchronize it with the picture.	0 ms			
2	Dolby Digital Setup	Turn the audio compression on or off when down-mixing Dolby Digital signals.	OFF			
3	Auto Surround Mode	Set the Auto surround mode function.	Auto Surround Mode = ON			

5. Option Setup

Option Setup			Default settings									
1	Power AMP Assignment	Set this to switch the surround back channel's power amplifier for use for zone2 or zone3.	Surround Back									
2	Zone2 vol. Level	This sets the output level the zone2 output jacks. This menu is not displayed, when "ZONE2" is selected at Option Setup "Power Amp Assign".	Variable									
3	Trigger Out1 Setup	Set the Trigger Out1 output for the each input sources.	ZONE=MAIN									
			PHONO	CD	TUNER	CDR/TAPE	DVD	VDP	TV	DBS	VCR-1	VCR-2
			OFF	OFF	OFF	OFF	ON	ON	ON	ON	ON	ON
4	Trigger Out2 Setup	Set the Trigger Out2 output for the each input sources.	ZONE=2									
			PHONO	CD	TUNER	CDR/TAPE	DVD	VDP	TV	DBS	VCR-1	VCR-2
			ON	ON	ON	ON	ON	ON	ON	ON	ON	ON
5	Muting Level	This sets the amount of attenuation at audio output muting.	--dB(minimum)									
6	On Screen Display	This sets whether or not to display the on-screen display that appears on the monitor screen when the controls on the remote control unit or main unit are operated. A setting to prevent flickering.	On Screen Display = ON / Mode 1									
7	Setup Lock	Set whether or not to lock the system setup settings so that they cannot be changed.	Setup Lock = OFF									

NOTES:

- The on-screen display signals are output with priority to the S-VIDEO MONITOR OUT jack during playback of a video component. For example, if the TV monitor is connected to both the AVR-3805's S-Video and video monitor output jacks and signals are input to the AVR-3805 from a video source (VDP, etc.) connected to both the S-Video and video input jacks, the on-screen display signals are output with priority to the S-Video monitor output. If you wish to output the signals to the video monitor output jack, do not connect a cord to the S-VIDEO MONITOR OUT jack. (For details, see page 49.)
- The AVR-3805's on-screen display function is designed for use with high resolution monitor TVs, so it may be difficult to read small characters on TVs with small screens or low resolutions.
- The setup menu is not displayed when headphone are being used.

• **Speaker system layout**

Basic system layout

- The following is an example of the basic layout for a system consisting of eight speaker systems and a television monitor:

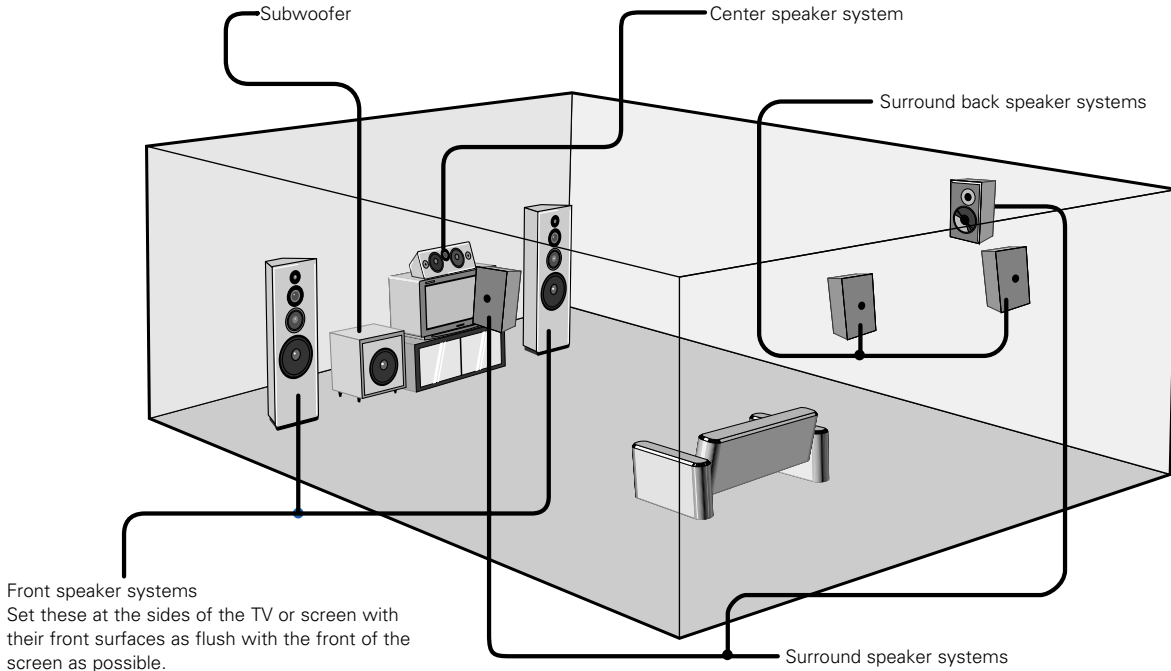

With the AVR-3805 it is also possible to use the surround speaker selector function to choose the best layout for a variety of sources and surround modes.

Using A only

Using B only

• **Surround speaker selector function**

This function makes it possible to achieve the optimum sound fields for different sources by switching between two systems of surround speakers (A and B).

※ SB: SURROUND BACK SPEAKER

Before setting up the system

1 Check that all the connections are correct, then turn on the main unit's power. Setup will not be possible when the unit is set to Pure Direct ON, the Video Off mode, or when the headphones are plugged in. Therefore, please cancel the mode or reverse the condition.

2 Display the System Setup Menu.

(Remote control unit)

(Main unit)

```

*System Setup
Auto Set/RoomEQ
    
```

System Setup Menu

- 1. Auto Setup/Room EQ
- 2. Speaker Setup
- 3. Input Setup
- 4. Advanced Playback
- 5. Option setup

Exit

NOTES:

- The System Setup menu composition is of a layered design that includes the related items below the large table title as contained in the tables of Pages 20 and 21.
- Wherever your position in System Setup, one more press of the System Setup button permits a move to one level higher.

Auto setup/Room EQ

The Auto Setup function of this unit performs an analysis of the speaker system and measures the acoustic characteristics of your room to permit an appropriate automatic setting.

※ When performing Auto Setup, an optional microphone is required for the setup.

■ Measurement and setting details

- ① : This sets the speaker connection mode, polarity, and bass reproduction ability.
- ② : This sets the optimum delay time from each speaker corresponding to the listening position.
- ③ : This sets the volume that is output from each speaker.
- ④ : This sets the frequency response of each speaker.

NOTE:

- A loud test tone is output during the measurement. Please consider this should you be planning night time measurements, and consider not allowing small children into the listening room at this time.

Connecting the microphone for Auto Setup

- 1 Connect the optional microphone for Auto Setup to the Setup Mic connector on the front panel of the unit.

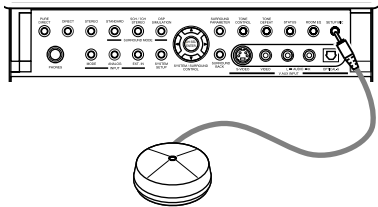

NOTES:

- The optional standard microphone is DENON DM-S305 sold separately.
- When using other microphone see page 30.

- 2 Place the microphone for Auto Setup at the actual listening position which will be at the same height as your ears. Use a tripod or level surface at positioning.

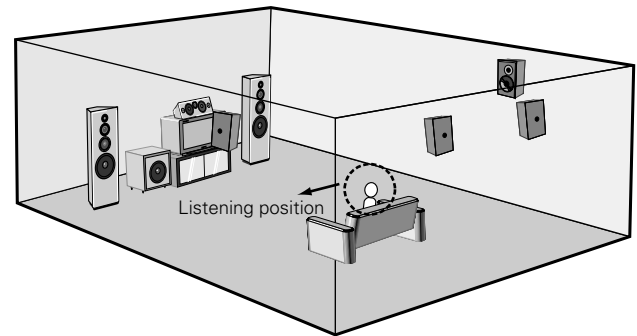

1 Setting the Auto Setup / Room EQ

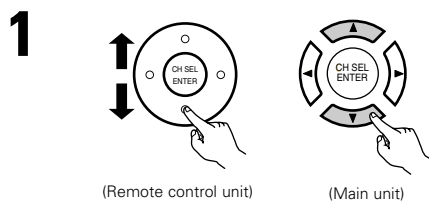

Select "Auto Setup / Room EQ" at the System Setup Menu.

```
*System Setup
Auto Set/RoomEQ
```

System Setup Menu

- 1. Auto Setup/Room EQ
- 2. Speaker Setup
- 3. Input Setup
- 4. Advanced Playback
- 5. Option setup

Exit

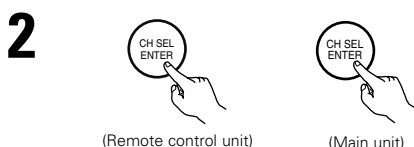

Display the Auto Setup / Room EQ menu.

1-1 Setting the Auto Setup

1

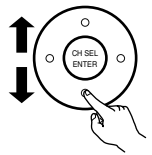

(Remote control unit)

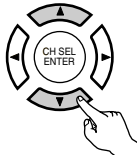

(Main unit)

Select "Auto Setup" at the Auto Setup / Room EQ Menu.

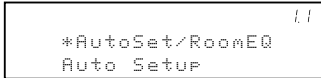

1. Auto Setup/Room EQ

- 1. Auto Setup
- 2. Manual EQ Setup
- 3. Room EQ Setup
- 4. Direct Mode Setup
- 5. Mic Input Select
- 6. EQ Parameter check

Exit

2



(Remote control unit)



(Main unit)

Display the Auto Setup screen.

3

Check the "Power Amp Assign" setting.

- When "Surround Back" is selected, the test tone during Auto Setup will be output from the Surround Back speaker.
- When "ZONE2" or "ZONE3" is selected, change the setting to "ZONE2" or "ZONE3". The test tone during Auto Setup is set so that it will not be output to ZONE2 or ZONE3 (Another room).

① Select the Power Amp Assign setting.

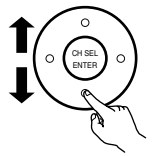

(Remote control unit)



(Main unit)

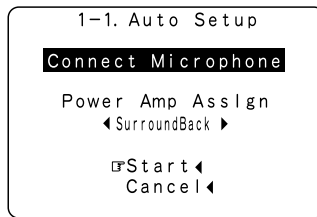

② Select "Surround Back", "ZONE2" or "ZONE3".

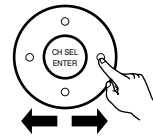

(Remote control unit)



(Main unit)

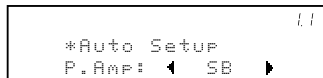

NOTE:

- When "ZONE2" or "ZONE3" is selected at System Setup Menu "Power Amp Assign", surround back speaker is not displayed as the target of setup in "2-1.setting the type of speakers". The results is reflected in "5-1.Power Amp Assign".

4

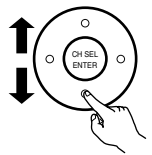

(Remote control unit)



(Main unit)

① Select the "Start".

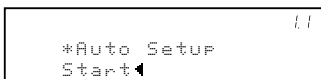

② Press the Cursor left button.



(Remote control unit)



(Main unit)

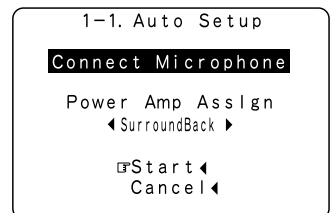

5

Start the measurements.
Measurement of each channel is performed as follows.
Display

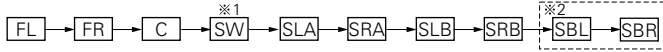

- ※1 Subwoofer speaker is measured twice.
- ※2 When "ZONE2" or "ZONE3" is selected, this is not displayed.
After each channel is measured, "Calculating" appears.
The display switches to Auto Setup check screen automatically.

NOTES:

- Measurement is canceled when MASTER VOLUME is operated while the Auto Setup is performed.
- Set the volume to halfway and set the crossover frequency to the maximum or Low pass filter off if your subwoofer speaker can adjust the output volume and the crossover frequency.

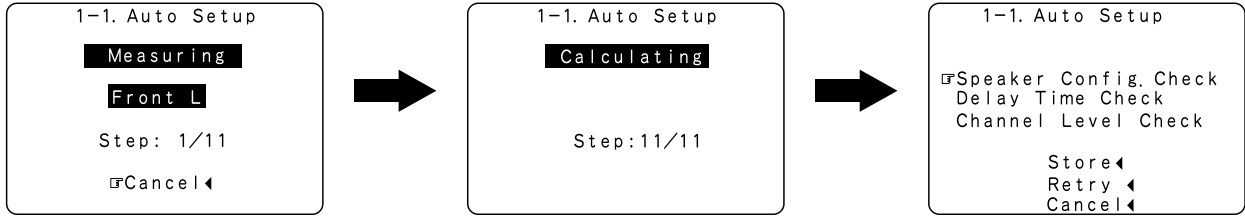

About automatic retry

Remeasurement starts automatically to receive proper result of measurement.
Remeasurement is performed to 2 times, and "Retry1" or "Retry2" is displayed on screen during remeasurement.

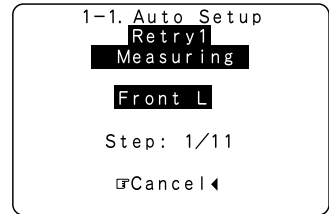

About the error message

These error screens will be displayed when performing the measurements of Auto Setup/Room EQ and the automatic measurements can not be completed because of the speaker arrangement, measurement environment, or other factors. Please check the following matters, reset the pertinent items, and measure again.

When there is too much noise in the room, the speakers may not be detected properly. Should this happen, perform the measurements when the noise level is low, or switch off the power of the equipment that is producing the noise for the duration of the measurements.

- ① This screen will be displayed when the speakers required for producing suitable reproduction have not been detected.
 - The front L and front R speakers were not properly detected.
 - Only one channel of the surround (A) and surround (B) speakers was detected.
 - Sound was output from the R channel when only one surround back speaker was connected.
 - The surround back or the surround (B) speaker was detected, but the surround (A) speaker was not detected.

Check that the pertinent speakers are properly connected. (see page 15)

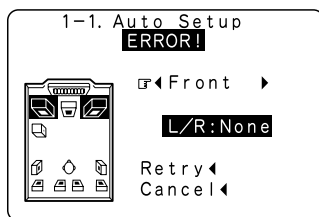

- ② This screen will be displayed when the speaker polarity is connected in reverse.

Check the polarity of the pertinent speakers.

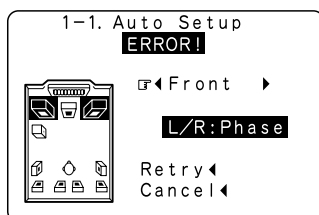

- ③ This screen will be displayed when accurate measurements cannot be made due to the input level to the microphone being too high.

**Set up the speakers so that their position is farther away from the listening position.
Lower the volume of the subwoofer speaker.**



- ④ This screen will be displayed when the measurement microphone is not connected, or when all of the speakers have not been detected.

**Connect the measurement microphone to the microphone connector.
Check the speaker connections.**



Check of the measurement results

1

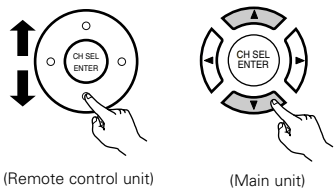

Select the items.
The measurement results of each item can be checked here.

```
*Auto Setup
SP Config.Check
```

```
1-1. Auto Setup
Speaker Config. Check
Delay Time Check
Channel Level Check

Store
Retry
Cancel
```

2

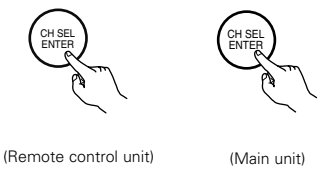

Press the ENTER button and display the verification screen.

NOTE:

- When measurements have been made using the measurement microphone, speakers with a built-in filter such as subwoofers might be set with a value that differs from the physical distance because of the internal electrical delay.

[Speaker Config. Check]

[Delay Time Check]

[Channel Level Check]

Speaker Config. Check

Front Sp.
 Large Small
 Center Sp.
 Large Small None
 Subwoofer
 Yes No

Delay Time Check

FL 12.0ft
 FR 12.0ft
 Center 12.0ft
 Subwoofer 12.0ft

Channel Level Check

FL 0.0dB
 FR 0.0dB
 Center 0.0dB
 Subwoofer 0.0dB

Speaker Config. Check

Surround
 Sp. A Large Small None
 Sp. B Large Small None
 Sp. Back Small None
 2spkrs 1spkrs

Delay Time Check

SL A 10.0ft
 SR A 10.0ft
 SL B 10.0ft
 SR B 10.0ft
 SBL 10.0ft
 SBR 10.0ft

Channel Level Check

SL A 0.0dB
 SR A 0.0dB
 SL B 0.0dB
 SR B 0.0dB
 SBL 0.0dB
 SBR 0.0dB

3

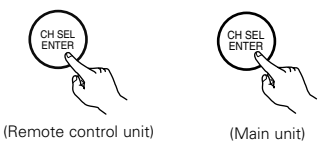

If the check ends, press the ENTER button again.

4

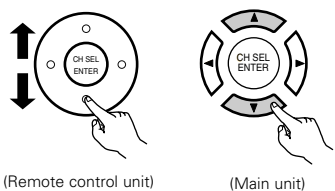

Select from the following three items based on the measurement results.

- Set with the checked measurement value.
- Perform the measurement again.
- Cancel the checked measurement value.

```
*Auto Setup
Store
```

```
1. Auto Setup

Speaker Config. Check
Delay Time Check
Channel Level Check

Store
Retry
Cancel
```

5

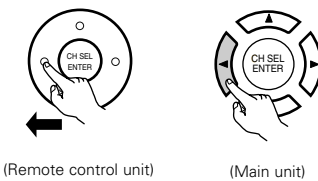

When the "Store" is selected, all parameters are stored up.
When the "Retry" is selected, it measures again.

```
1-1. Auto Setup

Parameter Storing
```

1-2 Setting the Manual EQ Setup

Adjust the tone of the various speakers except subwoofer speaker while listening to the sound (music).

1

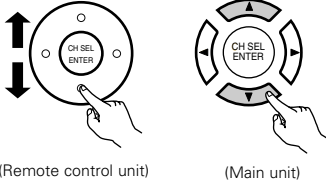

(Remote control unit) (Main unit)

Select "Manual EQ Setup" at the Auto Setup / Room EQ Menu.

```
*AutoSet/RoomEQ
Manual EQ Setup
```

1. Auto Setup/Room EQ

1. Auto Setup

2. Manual EQ Setup

3. Room EQ Setup

4. Direct Mode Setup

5. Mic Input Select

6. EQ Parameter check

Exit

2

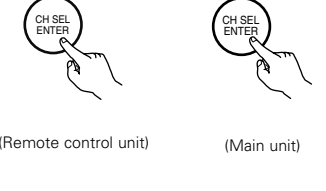

(Remote control unit) (Main unit)

Display the Manual EQ Setup screen.

```
*ManualEQ Setup
Channel : FL
```

1-2. Manual EQ Setup

Front L

63Hz	0.0dB
125Hz	0.0dB
250Hz	0.0dB
500Hz	0.0dB
1kHz	0.0dB
2kHz	0.0dB
4kHz	0.0dB
8kHz	0.0dB

3

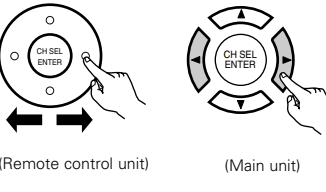

(Remote control unit) (Main unit)

Select the speaker to be set.
The display changes as follows.

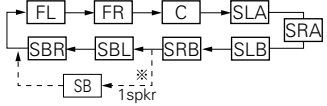

```
*ManualEQ Setup
Channel : FL
```

1-2. Manual EQ Setup

Front L

63Hz	0.0dB
125Hz	0.0dB
250Hz	0.0dB
500Hz	0.0dB
1kHz	0.0dB
2kHz	0.0dB
4kHz	0.0dB
8kHz	0.0dB

Flashing

※ When the surround back speaker setting is set to "1spkr" at "Speaker Configuration", this is set to "SB".

4

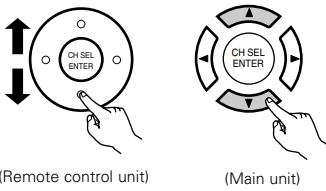

(Remote control unit) (Main unit)

Select the frequency

```
*ManualEQ Setup
63Hz : 0.0dB
```

Manual EQ Setup

Front L

63Hz	0.0dB
125Hz	0.0dB
250Hz	0.0dB
500Hz	0.0dB
1kHz	0.0dB
2kHz	0.0dB
4kHz	0.0dB
8kHz	0.0dB

5

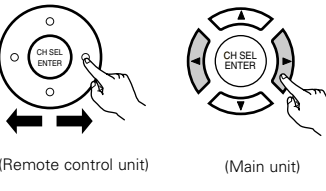

(Remote control unit) (Main unit)

Use the cursor left and right buttons to adjust the Gain level.

- Each frequency can be adjusted the range from -6dB to +6dB in 0.5dB step.

6



(Remote control unit) (Main unit)

Enter the setting.
The Auto Setup / Room EQ Menu reappears.

1-3 Setting the Room EQ Setup

Select the setting of an Equalizer that has been set with Auto Setup or Manual EQ.

1

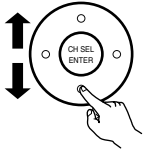

(Remote control unit)



(Main unit)

Select "Room EQ Setup" at the Auto Setup / Room EQ Menu.

```
*AutoSet/RoomEQ 13
Room EQ Setup
```

```
1. Auto Setup/Room EQ
2. Manual EQ Setup
3. Room EQ Setup
4. Direct Mode Setup
5. Mic Input Select
6. EQ Parameter check
Exit
```

2



(Remote control unit)



(Main unit)

Display the Room EQ Setup screen.

```
*Room EQ Setup 13
SurMode: ALL▶
```

```
1-3. Room EQ Setup
Relation To
The Surround Mode
ALL◀▶Assign
```

3

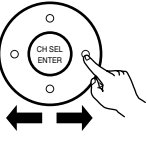

(Remote control unit)



(Main unit)

Select All or Assign.

- All :The Equalizer to all Surround mode is set as once.
- Assign :The Equalizer to each surround mode is to set individually.

4

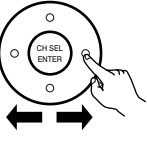

(Remote control unit)



(Main unit)

When the All is selected and press the ENTER button, display the Select the EQ Curve screen.

Select the Equalizer setting.

- OFF :The Equalizer is not used.
- Normal :Adjust the frequency response of all speaker suitable for general surround system.
- Flat :Adjust the frequency response of all speakers flat. This is suitable for music reproduction like ITU-R speaker setting.
- Front :Adjusts the characteristics of each speaker to the characteristics of the front speakers.
- Manual :Selects the setting value that was set in the Manual EQ setup

```
1-3. Room EQ Setup
Select the EQ Curve
Room EQ ◀Normal▶
```

```
*Room EQ Setup 13
RoomEQ ◀Normal▶
```

Whenever the Room EQ button on Main unit or Remote control unit is pressed, the display switches as shown below.

```
OFF → Normal → Front
      ↑         ↓
      Manual ← Flat ←
```



(Remote control unit)



(Main unit)

NOTES:

- The Equalizer setting of Normal, Flat and Front can be selected after performing the Auto Setup.
- When the speaker set as "None" with the Auto Setup is change to on manually, the equalizer of "Normal", "Front" and "Flat" cannot be used.
- The Equalizer setting can be selected directly by ROOM EQ button in Main unit or Remote control unit.
- When headphone is connected, the Room EQ cannot be used.

5

Enter the setting.
The Auto Setup / Room EQ Menu reappears.

1-4 Setting the Direct Mode

Perform the ON/OFF setting of Room EQ when the surround mode is Direct or Pure Direct.

1

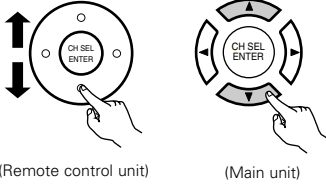

(Remote control unit) (Main unit)

Select "Direct Mode Setup" at the Auto Setup / Room EQ Menu.

```
*AutoSet/RoomEQ
Direct Mode
```

1. Auto Setup/Room EQ

1. Auto Setup
2. Manual EQ Setup
3. Room EQ Setup
4. Direct Mode Setup
5. Mic Input Select
6. EQ Parameter check

Exit

2

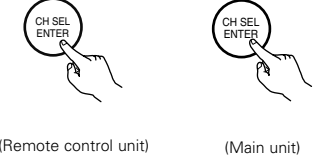

(Remote control unit) (Main unit)

Display the Direct Mode Setup screen.

```
*Direct Mode
Room EQ : OFF
```

1-4. Direct Mode Setup

DIRECT/PURE DIRECT

Room EQ ON OFF

3

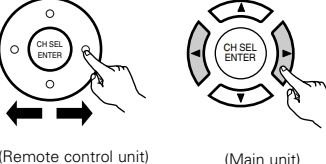

(Remote control unit) (Main unit)

Select ON or OFF.

4



(Remote control unit) (Main unit)

Enter the setting .
The Auto Setup / Room EQ Menu reappears.

1-5 Setting the MIC Input Select

Sets whether the setup microphone is connected to the PIN JACK connector or the MINI JACK connector.

※ Please ask the DENON Authorized Service Center about the usable microphone other than the option setup.

1

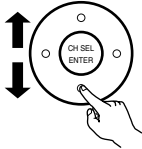

(Remote control unit)



(Main unit)

Select "Mic Input Select" at the Auto Setup / Room EQ Menu.

```
*AutoSet/RoomEQ 15
Mic In Select
```

1. Auto Setup/Room EQ

1. Auto Setup

2. Manual EQ Setup

3. Room EQ Setup

4. Direct Mode Setup

5. Mic Input Select

6. EQ Parameter check

Exit

2



(Remote control unit)



(Main unit)

Display the Mic Input Select screen.

3

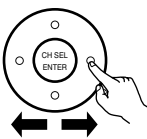

(Remote control unit)



(Main unit)

Select the Mic input jack or V.AUX L jack.

```
*Mic In Select 15
Mic
```

1-5. Mic Input Select

Mic ◀ : ▶ V.AUX L

4



(Remote control unit)



(Main unit)

Enter The setting.
The Auto Setup / Room EQ Menu reappears.

1-6 Check the EQ parameter

- The frequency characteristic of each speaker is rectified and the tone of the speaker is unified. The EQ parameters that were set in Auto Setup can be checked. This item is automatically displayed, after the measurement result of the "Auto Setup/Room EQ" is decided.

1

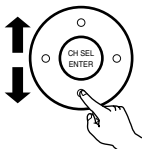

(Remote control unit)



(Main unit)

Select "EQ parameter check" at the Auto Setup / Room EQ Menu.

2



(Remote control unit)



(Main unit)

Display the EQ Parameter check screen.

1-6. EQ Parameter Check

1: Normal

2: Front

3: Flat

Exit

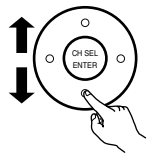
3

(Remote control unit)



(Main unit)

Select the Equalizer curve.

4

Display the parameter screen.

1: Normal	EQ	Front L
Freq	Gain	Q
57Hz	-1.0dB	0.1
110Hz	0.0dB	0.5
250Hz	+0.5dB	0.1
510Hz	+1.0dB	1.3
1.1kHz	0.0dB	2.1
2.6kHz	0.0dB	0.5
4.8kHz	0.0dB	0.1
10kHz	+3.0dB	0.1

5

Select the speaker channel.

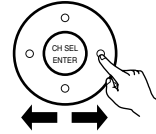

(Remote control unit)

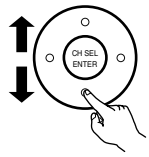

(Main unit)

6

(Remote control unit)



(Main unit)

If the check ends, select "Exit" and press the ENTER button. The Auto Setup Menu reappears.



(Remote control unit)



(Main unit)

1. Auto Setup/Room EQ
1. Auto Setup
2. Manual EQ Setup
3. Room EQ Setup
4. Direct Mode Setup
5. Mic Input Select
6. EQ Parameter check
Exit

7

(Remote control unit)



(Main unit)

Enter the Setting.
Select "Exit" and press the ENTER button at the Auto Setup / Room EQ Menu screen.
The System Setup Menu reappears.

2

Setting the Speaker Setup

- Cross over Frequency and Subwoofer Mode Setup is not displayed when not using a subwoofer.
- Surround Sp setup is displayed when using both surround speakers A and B.

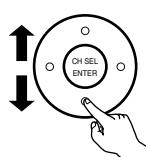
1

(Remote control unit)



(Main unit)

Select "Speaker Setup" at the System Setup Menu .

*System Setup	2
Speaker Setup	

System Setup Menu

1. Auto Setup/Room EQ
2. Speaker Setup
3. Input Setup
4. Advanced Playback
5. Option Setup
Exit

2

(Remote control unit)



(Main unit)

Display the Speaker Setup Menu screen.

2. Speaker Setup
1. Speaker Config.
2. Delay Time
3. Channel Level
4. Crossover Frequency
5. Subwoofer Mode Setup
6. Surround Sp Setup
Exit

2-1 Setting the type of speakers

- The composition of the signals output to each channels and the frequency response are adjusted automatically according to the combination of speakers actually being used.

1

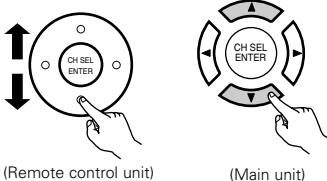

(Remote control unit) (Main unit)

Select "Speaker Configuration" at the Speaker Setup Menu.

```
*Speaker Setup
Speaker Config. 2/1
```

2. Speaker Setup

1. Speaker Config.
2. Delay Time
3. Channel Level
4. Crossover Frequency
5. Subwoofer Mode Setup
6. Surround Sp Setup

Exit

2

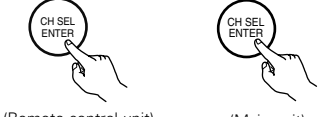

(Remote control unit) (Main unit)

Display the speaker configuration screen as below.

3

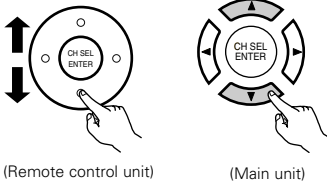

(Remote control unit) (Main unit)

Set whether speakers are connected or not and, if so, their size parameters.

① Select the speaker

2-1. Speaker Config.

FrontSp. Large Small

Center Sp. Large Small None

Subwoofer Yes No

2-1. Speaker Config.

Surround

Sp. A Large Small None

Sp. B Large Small None

Sp. Back Small None

2spkr 1spkr

```
*Speaker Config
FrontSp: Large
```

② Select the parameter

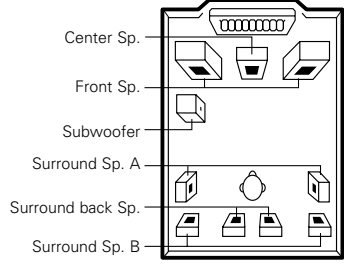

4

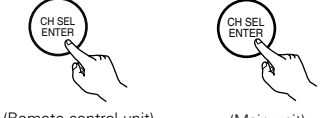

(Remote control unit) (Main unit)

ENTER the setting.
The Speaker Setup Menu reappears.

NOTE:

- Select "Large" or "Small" not according to the actual size of the speaker but according to the speaker's capacity for playing low frequency (bass sound below the frequency set for the Crossover Frequency) signals. If you do not know, try comparing the sound at both settings (setting the volume to a level low enough so as not to damage the speakers) to determine the proper setting.

Parameters

- Large.....Select this when using speakers that have sufficient performance for reproducing bass sound below the frequency set for the Crossover Frequency mode.
- Small.....Select this when using speakers that do not have sufficient performance for reproducing bass sound below the frequency set for the Crossover Frequency mode. When this is set, bass sound with a frequency below the frequency set for the Crossover Frequency mode is sent to the subwoofer.
- None.....Select this when no speakers are installed.
- Yes/No.....Select "Yes" when a subwoofer is installed, "No" when a subwoofer is not installed.
- 2spkr/1spkr.....Set the number of speakers to be used for the surround back channel.

- ※ If the subwoofer has sufficient low frequency playback capacity, good sound can be achieved even when "Small" is set for the front, center and surround speakers.

2-2 Setting the Delay Time

- Input the distance between the listening position and each speakers to set the delay time for the surround playback.
- The delay time can be set separately for surround speakers A and B.

Preparations:

Measure the distances between the listening position and the speakers (L1 to L5 on the diagram at the right).

- L1: Distance between center speaker and listening position
- L2: Distance between front speakers and listening position
- L3: Distance between surround speakers and listening position
- L4: Distance between surround back speakers and listening position
- L5: Distance between subwoofer and listening position

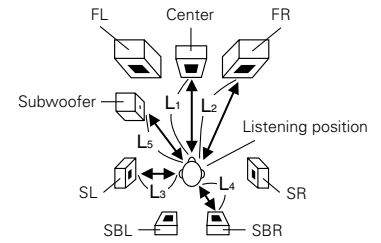

1

(Remote control unit)

(Main unit)

Select "Delay Time" at the Speaker Setup Menu.

*Speaker Setup 2.2
Delay Time

2. Speaker Setup

1. Speaker Config.

2. Delay Time

3. Channel Level

4. Crossover Frequency

5. Subwoofer Mode Setup

6. Surround Sp Setup

Exit

2

(Remote control unit)

(Main unit)

Display the Delay Time screen.

*Delay Time 2.2
Meters ◀ : ▶ Feet

2-2. Delay Time

Set The Distance To Each Speakers

Do You Prefer In Meters? / In Feet?

Meters ◀ : ▶ Feet

3

(Remote control unit)

(Main unit)

Select the desired unit, meters or feet.

2-2. Delay Time

Set The Distance To Each Speakers

Do You Prefer In Meters? / In Feet?

Meters ◀ : ▶ **Feet**

Example: When "Feet" is selected

4

Once "Meters" or "Feet" is selected in step 3, the Delay Time screen appears automatically.

*Delay Time 2.2
FL : ◀ 12.0 ft ▶

2-2. Delay Time

Step ◀ 1 ft ▶
Default Yes

FL ◀ 12.0 ft ▶

FR 12.0 ft

Center 12.0 ft

Subwoofer 12.0 ft

2-2. Delay Time

SL A ◀ 10.0 ft ▶

SR A 10.0 ft

SL B 10.0 ft

SR B 10.0 ft

SBL 10.0 ft

SBR 10.0 ft

5

(Remote control unit)

(Main unit)

Select the speaker to be set.
The picture of the speaker selected blinks.

33

6

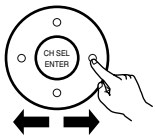

(Remote control unit)



(Main unit)

Set the distance between the center speaker and listening position. The distance changes in units of 0.1 foot (0.03 meters) each time the button is pressed. Select the value closest to the measured distance.

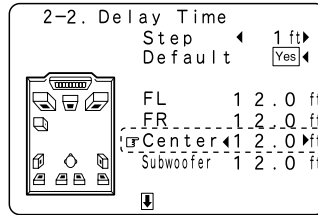

Example: When the distance is set to 12 feet for the center speaker

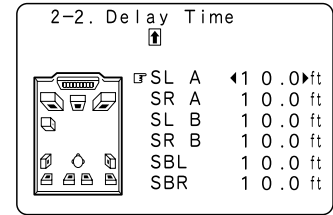

※ If "Yes" is selected for "Default", the settings are automatically reset to the default values.

Please note that the difference of distance for every speaker should be 20 ft (6.0 m) or less. If you set an invalid distance, a CAUTION notice, such as screen right will appear. In this case, please relocate the blinking speaker(s) so that its distance is no larger than the value shown in highlighted line.

※ When "Step" is selected, you can select the unit of "1ft (0.1m)" or "0.1ft (0.01m)".

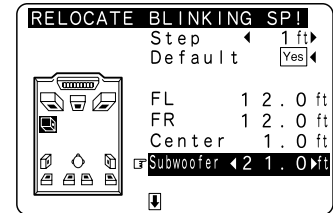

7



(Remote control unit)



(Main unit)

Enter the setting. The Speaker Setup Menu reappears. The AVR-3805 automatically sets the optimum surround delay time for the listening room.

NOTE:

- If the distance unit is changed after the delay time is set, the settings are reset to the factory default values (see page 20).

2-3 Setting the Channel Level

- Use this setting to adjust so that the playback level between the different channels is equal.
- From the listening position, listen to the test tones produced from the speakers to adjust the level.
- The level can also be adjusted directly from the remote control unit. (For details, see page 72.)
- When both surround speakers A and B are used, their playback levels can be adjusted separately.

1

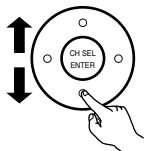

(Remote control unit)



(Main unit)

Select "Channel Level" at the Speaker Setup Menu.

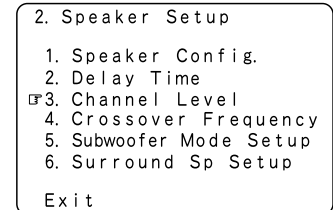
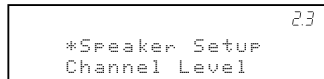

2



(Remote control unit)



(Main unit)

Display the Channel Level screen.

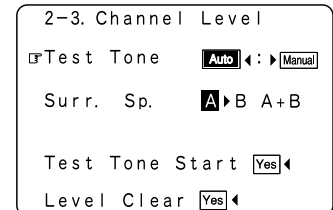
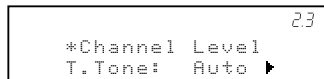

3

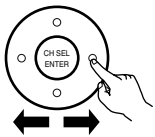

(Remote control unit)

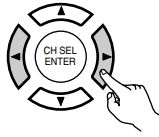

(Main unit)

Select the mode.
Select "Auto" or "Manual".

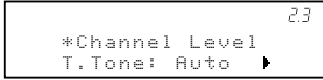

- Auto:
Adjust the level while listening to the test tones produced automatically from each speaker.
- Manual:
Select the speaker from which you want to produce the test tone to adjust the level.

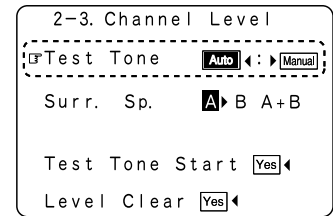

Example: When the "Auto" mode is selected

4

① Select "Surr. Sp.".

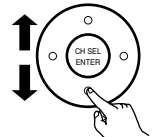

(Remote control unit)



(Main unit)

② Select the surround speaker(s) from which you want to produce the test tone (A, B or A+B).

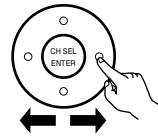

(Remote control unit)



(Main unit)

- Surr. Sp.: A
Adjusts the balance of the playback level between the channels when using surround speaker A.
- Surr. Sp.: B
Adjusts the balance of the playback level between the channels when using surround speaker B.
- Surr. Sp.: A+B
Adjusts the balance of the playback level between the channels when using surround speakers A and B at the same time.

The "Surr. Sp." can only be selected when both surround speakers A and B have been selected at the System Setup Menu (when both A and B have been set to "Large" or "Small").

5

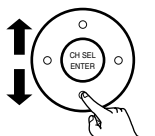

(Remote control unit)

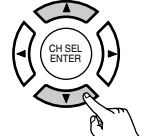

(Main unit)

Select "Test Tone Start".

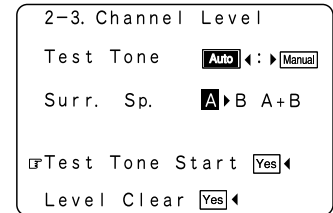
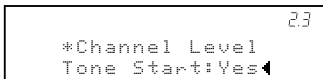

6

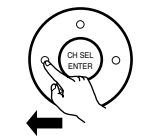

(Remote control unit)



(Main unit)

Select "Yes".

7

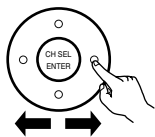

(Remote control unit)

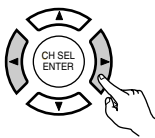

(Main unit)

- a. When the "Auto" mode is selected:
Test tones are automatically emitted from each speaker.
The test tones are emitted from each speaker in the following order, at 4-second intervals the first time and second time around, 2-second intervals the third time around and on:

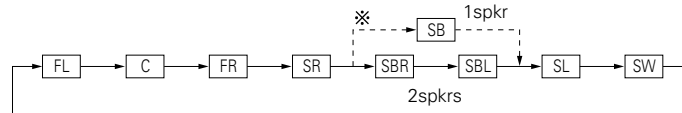

※ When the surround back speaker setting is set to "1spkr" for "Speaker Configuration", this is set to "SB".

Use the CURSOR left and right buttons to adjust all the speakers to the same volume.
The volume can be adjusted between -12 dB and +12 dB in units of 0.5 dB.

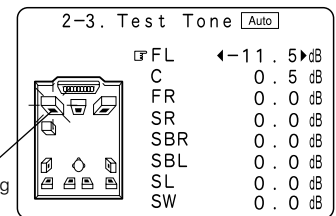

Flashing

Example: When the volume is set to -11.5 dB while the test tone is being produced from the Front Lch speaker

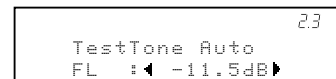

b. When the "Manual" mode is selected :

① Select the speaker.

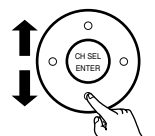

(Remote control unit)

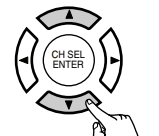

(Main unit)

② Adjust all the speakers to the same volume.

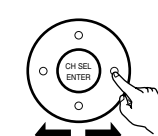

(Remote control unit)

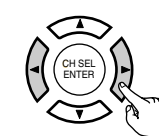

(Main unit)

8



(Remote control unit)



(Main unit)

Enter the setting.
The "Channel Level" screen reappears.

※ To cancel the settings, **press the CURSOR down** to select "Level Clear" and "Yes" on the "Channel Level" screen, then make the settings again.

The level of each channel should be adjusted to 75 dB (C-weighted, slow meter mode) on a sound level meter at the listening position. If a sound level meter is not available adjust the channels by ear so the sound levels are the same. Because adjusting the subwoofer level test tone by ear is difficult, use a well known music selection and adjust for natural balance.

NOTE: When adjusting the level of an active subwoofer system, you may also need to adjust the subwoofer's own volume control.

※ When you adjust the channel levels while in the SYSTEM SETUP CHANNEL LEVEL mode, the channel level adjustments made will affect all surround modes. Consider this mode a Master Channel Level adjustment mode.

※ After you have completed the SYSTEM SETUP CHANNEL LEVEL adjustments, you can then activate the individual surround modes and adjust channel levels that will be remembered for each of those modes. Then, whenever you activate a particular surround sound mode, your preferred channel level adjustments for just that mode will be recalled. Check the instructions for adjusting channel levels within each surround mode. (See page 72)

※ You can adjust the channel levels for each of the following surround modes: PURE DIRECT/DIRECT, STEREO, DOLBY/DTS SURROUND, 5/7 CH STEREO, WIDE SCREEN, SUPER STADIUM, ROCK ARENA, JAZZ CLUB, CLASSIC CONCERT, MONO MOVIE, VIDEO GAME, MATRIX and VIRTUAL.

※ When using either surround speakers A or B, or when using surround speakers A and B at the same time, be sure to adjust the balance of playback levels between each channel for the various selections of "A or B" and "A and B".

2-4 Setting the crossover frequency

- Set the crossover frequency mode according to the speaker system being used.

1

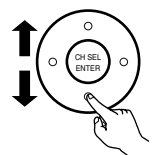

(Remote control unit)



(Main unit)

Select the "Crossover Frequency" at the Speaker Setup Menu.

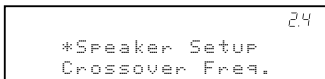

2. Speaker Setup

1. Speaker Config.
2. Delay Time
3. Channel Level
4. Crossover Frequency
5. Subwoofer Mode Setup
6. Surround Sp Setup

Exit

2



(Remote control unit)



(Main unit)

Display the Crossover Frequency screen.

3

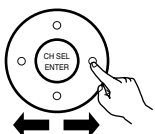

(Remote control unit)



(Main unit)

Select the frequency.

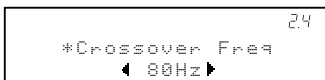

- 40 / 60 / 80 / 100 / 120 / 150 / 200 / 250 Hz can be selected.

2-4. Crossover Frequency

◀ 80 Hz ▶

4



(Remote control unit)



(Main unit)

Enter the setting.
The Speaker Setup Menu reappears.

2-5 Setting the low frequency distribution

This screen is not displayed when not using a subwoofer and all speakers are set to small size .

- Set the subwoofer mode according to the speaker system being used.

1

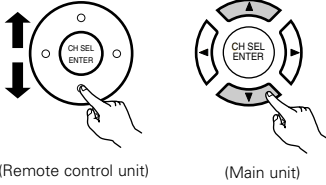

(Remote control unit) (Main unit)

Select the "Subwoofer Mode" at the Speaker Setup Menu.

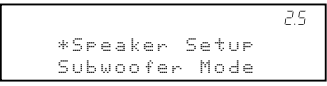

2. Speaker Setup

1. Speaker Config.
2. Delay Time
3. Channel Level
4. Crossover Frequency
5. Subwoofer Mode Setup
6. Surround Sp Setup

Exit

2

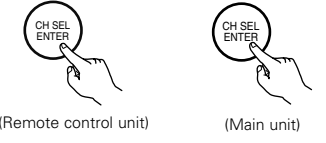

(Remote control unit) (Main unit)

Display the Subwoofer mode screen.

3

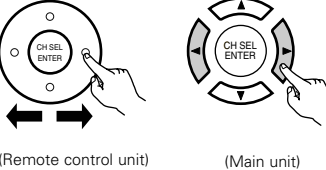

(Remote control unit) (Main unit)

Select the setting.

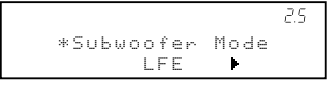

2-5. Subwoofer Mode

LFE ◀ ▶ LFE
+ Main

4

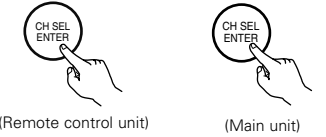

(Remote control unit) (Main unit)

Enter the setting.
The Speaker Setup Menu reappears.

NOTES:

— Assignment of low frequency signal range (2-1) —

- The only signals produced from the subwoofer channel are LFE signals (during playback of Dolby Digital or DTS signals) and the low frequency signal range of channels set to "SMALL" in the setup menu. The low frequency signal range of channels set to "LARGE" are produced from those channels.

— Crossover Frequency (2-4) —

- When "Subwoofer" is set to "Yes" at the "Speaker Configuration Setting", set the frequency (Hz) below which the bass sound of the various speakers is to be output from the subwoofer (the crossover frequency).
- For speakers set to "Small", sound with a frequency below the crossover frequency is cut, and the cut bass sound is output from the subwoofer instead.
- (When the subwoofer set to "NO", the bass sound is output from the speaker set as "Large".)

NOTE: For ordinary speaker systems, we recommend setting the crossover frequency to 80 Hz. When using small speakers, however, setting the crossover frequency to a high frequency may improve frequency response for frequencies near the crossover frequency.

— Subwoofer mode (2-5) —

- The subwoofer mode setting is only valid when "LARGE" is set for the front speakers and "YES" is set for the subwoofer in the "Setting the type of speakers". (see page 31).
- When the "LFE+MAIN" playback mode is selected, the low frequency signal range of channels set to "LARGE" are produced simultaneously from those channels and the subwoofer channel.
In this playback mode, the low frequency range expand more uniformly through the room, but depending on the size and shape of the room, interference may result in a decrease of the actual volume of the low frequency range.
- Selection of the "LFE" play mode will play the low frequency signal range of the channel selected with "LARGE" from that channel only. Therefore, the low frequency signal range that are played from the subwoofer channel are only the low frequency signal range of LFE (only during Dolby Digital or DTS signal playback) and the channel specified as "SMALL" in the setup menu.
- Select the play mode that provides bass reproduction with quantity.
- When the subwoofer is set to "Yes", bass sound is output from the subwoofer regardless of the subwoofer mode setting in surround modes other than Dolby/DTS.
- In surround modes other than Dolby Digital and DTS, if the subwoofer is set to "YES", the low frequency portion is always output to the subwoofer channel. For details, refer to "Surround Modes and Parameters". (See page 83)

2-6 Selecting the Surround Speakers for the different surround modes

This Menu is displayed when both surround speakers A and B are used.

- At this screen preset the surround speakers to be used in each surround modes.

1

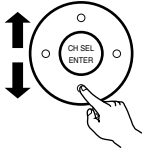

(Remote control unit)



(Main unit)

Select "Surround Sp Setup" at the Speaker Setup Menu.

```

2.5
*Speaker Setup
Surround Sp Setup
    
```

```

2. Speaker Setup
1. Speaker Config.
2. Delay Time
3. Channel Level
4. Crossover Frequency
5. Subwoofer Mode Setup
▣6. Surround Sp Setup
Exit
    
```

2



(Remote control unit)



(Main unit)

Display the Surround Sp Setup screen.

3

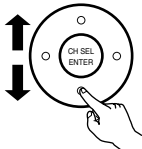

(Remote control unit)



(Main unit)

① To select the surround mode
When either "Large" or "Small" has been set for both speakers A and B on the System Setup Menu (when using both A and B surround speakers), the surround speaker setting screen appears. Select the surround speakers to be used in each surround mode.

```

2-6. Surround Sp Setup
▣ DOLBY/DTS CINEMA ◀ A ▶
DOLBY/DTS MUSIC A
DOLBY PLIIx GAME A
5/7CH STEREO A
DSP SIMULATION A
MULTI CH MODE A
EXT. IN A
    
```

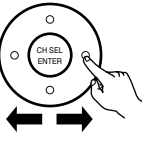

(Remote control unit)

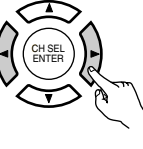

(Main unit)

② To select the surround speaker
 A : When surround speakers A is used.
 B : When surround speakers B is used.
 A+B : When both surround speakers A and B are used.

```

2.5
*Surround Sp Setup
CINEMA : ◀ A ▶
    
```

4



(Remote control unit)



(Main unit)

Enter the setting.
At the "2.Speaker Setup" screen, select "Exit" and press the ENTER button.
The System Setup Menu reappears.

※ Speaker type setting when using both surround speakers A and B

If "Small" is set for either surround speakers A or B, the output is the same as when "Small" is set for both A and B.

3 Setting the Input Setup

1

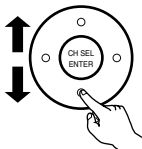

(Remote control unit)



(Main unit)

At the System Setup Menu select "Input Setup".

```

3
*System Setup
Input Setup
    
```

```

System Setup Menu
1. Auto Setup/Room EQ
2. Speaker Setup
▣3. Input Setup
4. Advanced Playback
5. Option setup
Exit
    
```

2



(Remote control unit)



(Main unit)

Display the Input Setup Menu screen.

3-1 Setting the Digital In Assignment

- This setting assigns the digital input jacks of the AVR-3805 for the different input sources.

1

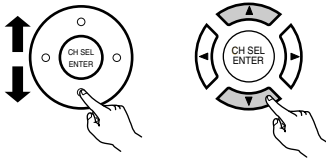

(Remote control unit) (Main unit)

At the Input Setup Menu select "Digital In Assignment".

```
*Input Setup 31
Digital In
```

3. Input Setup

1. Digital In Assign

2. Ext. In Subwoofer Level

3. Component In Assign

4. Video Input Mode

5. Auto Tuner Presets

Exit

2

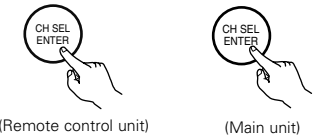

(Remote control unit) (Main unit)

Display the Digital Inputs screen.

```
*Digital In 31
CD : <COAX1>
```

3-1. Digital In Assign

CD : <COAX1> VCR2 : OFF

DVD : COAX2 TAPE : OPT 4

VDP : OPT 1

TV : OFF

DBS : OPT 2

VAUX : OPT 5

VCR1 : OPT 3

Default Yes

3

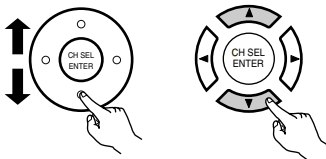

(Remote control unit) (Main unit)

Select the digital input jack to be assigned to the input source.

① Select the input source

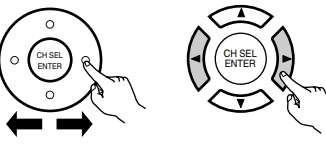

(Remote control unit) (Main unit)

② Select the digital input jack

Select "OFF" for input sources for which no digital input jacks are used.

* If "Yes" is selected for "Default", the settings are automatically reset to the default values.

4

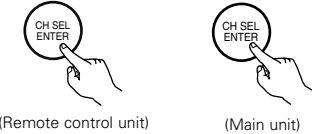

(Remote control unit) (Main unit)

Enter the setting.

The Input Setup Menu reappears.

NOTES:

- The OPTICAL 3, 4 jacks on the AVR-3805's rear panel are equipped with an optical digital output jack for recording digital signals on a CD recorder, MD recorder or other digital recorder. Use this for digital recording between a digital audio source (stereo - 2 channel) and a digital audio recorder.
- Do not connect the output of the component connected to the OPTICAL 3, 4 OUT jack on the AVR-3805's rear panel to any jack other than the OPTICAL 3, 4 IN jack.
- "PHONO" and "TUNER" cannot be selected on the Digital In Assignment.

Refer to "DENON LINK connections". (See page 14)

3-2 Setting the Ext. In Subwoofer Level

- Set the method of playback of the analog input signal connected to the Ext.In Subwoofer.

1

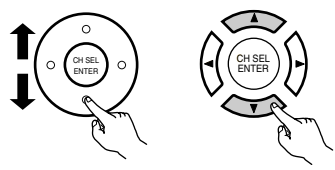

(Remote control unit) (Main unit)

Select "Ext.In Subwoofer Level" at the Input Setup Menu.

```

3.2
*Input Setup
Ext.In SW Lev.
    
```

```

3. Input Setup
 1. Digital In Assign
 2. Ext. In Subwoofer Level
 3. Component In Assign
 4. Video Input Mode
 5. Auto Tuner Presets

Exit
    
```

2

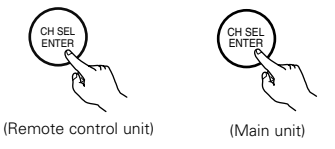

(Remote control unit) (Main unit)

Display to the Ext.In Subwoofer Level screen.

```

3.2
*Ext. In SW Lev.
SW Lev.: ◀+15dB
    
```

```

3-2. Ext. In Subwoofer Level

Subwoofer Level ◀+15dB
    
```

3

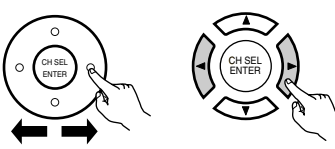

(Remote control unit) (Main unit)

Select the desired setting.

Select according to the specifications of the player being used. Also refer to the player's operating instructions.
+15dB (default) recommended. (0, +5, +10 or +15 can be selected.)

4

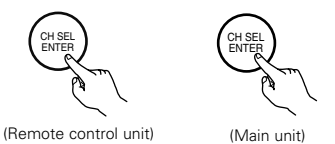

(Remote control unit) (Main unit)

Enter the setting.
The Input Setup Menu reappears.

3-3 Setting the Component In Assign

- This setting assigns the color difference (component) video input jacks of the AVR-3805 for the different input sources.

1

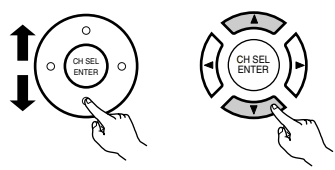

(Remote control unit) (Main unit)

Select "Video Setup" at the Input Setup Menu.

```

3.3
*Input Setup
Component In
    
```

```

3. Input Setup
 1. Digital In Assign
 2. Ext. In Subwoofer Level
 3. Component In Assign
 4. Video Input Mode
 5. Auto Tuner Presets

Exit
    
```

2

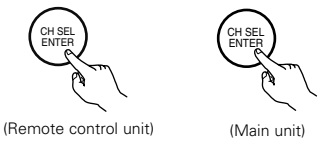

(Remote control unit) (Main unit)

Display the Component In Assign screen.

```

3.3
*Component In
DVD : ◀ V1 ▶
    
```

```

3-3. Component In Assign

DVD: ◀ VIDEO 1 ▶
VDP: NONE
TV: VIDEO 2
DBS: VIDEO 3
VCR1: NONE
VCR2: NONE
VAUX: NONE
Default Yes◀
    
```

3 Select the component (Y, Pb/Cb and Pr/Cr) video input terminal to be assigned to the input source.

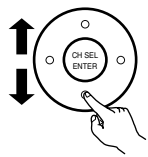

(Remote control unit)



(Main unit)

① Select the source selection.

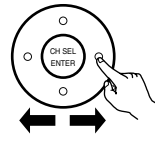

(Remote control unit)



(Main unit)

② Select the component video input terminal.

Select "NONE" for sources for which the component (Y, Pb/Cb and Pr/Cr) video input is not to be used.

※ When the default, "Yes", is selected, the settings are reset to the factory defaults.

4 Enter the setting.
The Input Setup Menu reappears.



(Remote control unit)



(Main unit)

3-4 Setting the Video Input Mode

1 Select "Video Input Mode" at the Input Setup Menu .

(Remote control unit)

(Main unit)

```

34
*Input Setup
Video In Mode
    
```

```

3. Input Setup
1. Digital In Assign
2. Ext. In Subwoofer Level
3. Component In Assign
4. Video Input Mode
5. Auto Tuner Presets
Exit
    
```

2 Display the Video Input Mode screen.

(Remote control unit)

(Main unit)

```

34
*Video In Mode
DVD : <Auto>
    
```

```

3-4. Video Input Mode
DVD : <AUTO>
VDP : AUTO
TV : AUTO
DBS : AUTO
VCR1 : AUTO
VCR2 : AUTO
VAUX : AUTO
Default Yes<
    
```

3 ① Select the input source for which you want to set the Video Input Mode. ② Select the mode as below.

→AUTO ↔ COMPONENT ↔ Svideo ↔ Video←

The details in each mode are as follows.

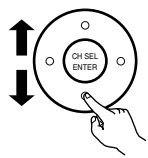

(Remote control unit)



(Main unit)

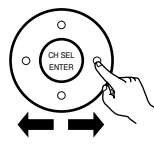

(Remote control unit)



(Main unit)

- AUTO: When there are multiple input signals, the input signals are detected and the input signal to be output from the video monitor output terminal is selected automatically in the following order: component video, S-Video, composite video.
- Component: The signal connected to the component video terminal is always played.
Video conversion is not conducted, so no image is output from the monitor output terminal when there is no input signal to the component terminal.
- S-Video: The signal connected to the S-Video terminal is always played.
The S-Video input signal is converted and output from the composite and component monitor output terminal.
- Video: The signal connected to the composite video terminal is always played.
The composite video input signal is up-converted and output from the S-Video and component monitor output terminals.

NOTE:

Down-converting from the component video signal to the S-Video and composite video signal is not possible, so when not using the component video monitor output terminal connect the player using the S-Video or composite video input terminal.

Cautions on the video conversion function:

When the component video terminals are used to connect the AVR-3805 with a TV (or monitor, projector, etc.) and the video (yellow) or S video terminals are used to connect the AVR-3805 with a VTR, depending on the combination of the TV and VTR the picture may flicker in the horizontal direction, be distorted, be out of sync or not display at all when playing video tapes.

If this happens, connect a commercially available video stabilizer, etc., with a TBC (time base corrector) function between the AVR-3805 and the VTR, or if your VTR has a TBC function, turn it on.

4

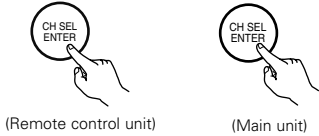

Enter the setting.
The System Setup Menu reappears.

3-5 Auto Tuner Presets

Use this to automatically search for FM broadcasts and store up to 56 stations at preset channels A1 to 8, B1 to 8, C1 to 8, D1 to 8, E1 to 8, F1 to 8 and G1 to 8.

NOTE:

- If an FM station cannot be preset automatically due to poor reception, use the "Manual tuning" operation to tune in the station, then preset it using the manual "Preset memory" operation.

1

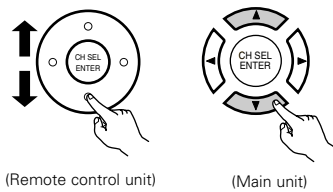

Select "Auto Tuner Presets" at the Input Setup Menu.

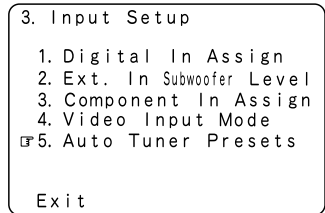
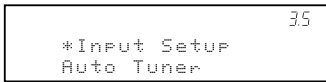

2

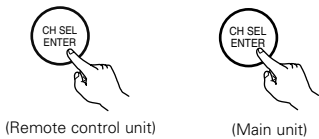

Display the Auto Preset Memory screen.

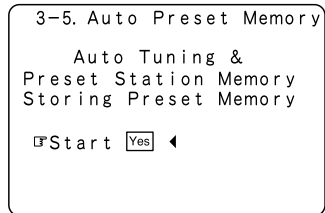
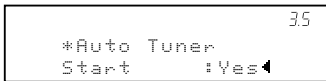

3

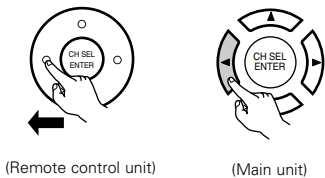

Press the CURSOR left button to select "Yes".
"Search" flashes on the screen and searching begins.
"Completed" appears once searching is completed.
The display automatically switches to screen.

4

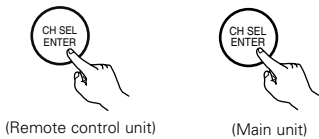

Enter the setting.
The Input Setup Menu reappears.

4

Setting the Advanced Playback

1

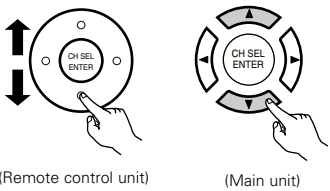

(Remote control unit) (Main unit)

Select "Advanced Play back" at the System Setup Menu.

```
*System Setup
Advanced Play
```

System Setup Menu

1. Auto Setup/Room EQ
2. Speaker Setup
3. Input Setup
4. Advanced Playback
5. Option setup

Exit

2

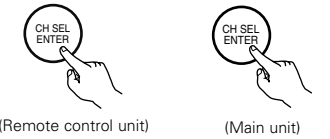

(Remote control unit) (Main unit)

Display the Advanced Playback Menu screen.

4-1 Setting the Audio Delay

This function allows you to adjust the time delay of the video and audio signals and store these settings for the different input sources. The setting is made while watching a DVD or other software, so it is not made here. By default, this is not displayed when no digital signals are being input. For instructions on making the setting, refer to page 63.

NOTE:

The audio delay setting does not apply when it plays in the EXT. IN mode or in the analog input direct mode or stereo mode (TONE DEFEAT "ON").

4-2 Setting the Dolby Digital Setup

Sets the down-mixing method when not using a center speaker or surround speakers.

OFF: The dynamic range is not compressed.

ON: The dynamic range is compressed automatically according to the combination of speakers being used.

1

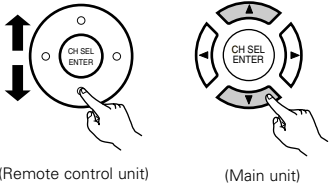

(Remote control unit) (Main unit)

Select "Dolby Digital Setup" at the Advanced Playback Menu.

```
*Advanced Play
Dolby D Setup
```

4. Advanced Playback

1. Audio Delay
2. Dolby Digital Setup
3. Auto Surround Mode

Exit

2

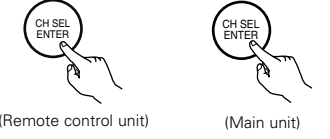

(Remote control unit) (Main unit)

Press the ENTER button.
Display the Dolby Digital Setup screen.

3

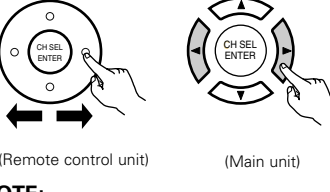

(Remote control unit) (Main unit)

Select "ON" if you want to use the Compression, "OFF" if you do not want to use it.

```
*Dolby D Setup
Comp. : OFF
```

4-2. Dolby Digital
Downmix Option Setup

Compression

ON OFF

NOTE:
When a center speaker or surround speakers, are not used the sound is played from the front speakers. Set "Compression" to "ON" if it seems that sound is distorted because the input level exceeds the allowable input for the front speakers.

4

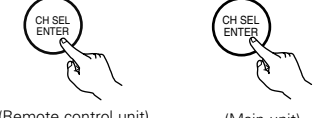

(Remote control unit) (Main unit)

Enter the setting.
The Advanced Playback Menu reappears.

4-3 Setting the Auto Surround Mode

The surround mode used at last for the three types of input signals shown below is stored in the memory, and the signal is automatically played with that surround mode the next time it is input.

Note that the surround mode setting is also stored separately for the different input sources.

- ① Analog and PCM 2-channel signals
- ② 2-channel signals of Dolby Digital, DTS or other multi-channel format
- ③ Multi-channel signals of Dolby Digital, DTS or other multi-channel format

※ During playback in the PURE DIRECT mode, the surround mode does not change even if the input signal is changed.

1

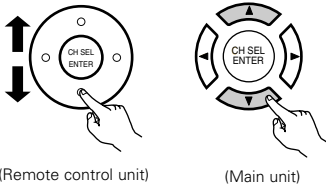

(Remote control unit) (Main unit)

Select "Auto Surround Mode" at the Advanced Playback Menu.

4.3

*Advanced Play
Auto Surround

4. Advanced Playback

1. Audio Delay
2. Dolby Digital Setup
3. Auto Surround Mode

Exit

2

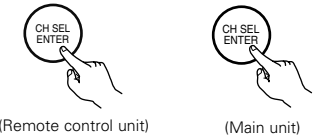

(Remote control unit) (Main unit)

Press the ENTER button.
Display the Auto Surround Mode screen.

3

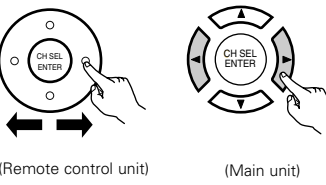

(Remote control unit) (Main unit)

Select "ON" if you want to use the auto surround mode, "OFF" if you do not want to use it.

4.3

*Auto Surround
ON/OFF: ON ▶

4-3. Auto Surround Mode

ON ◀ ▶ OFF

4

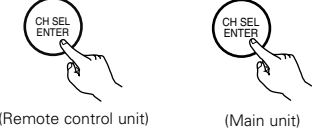

(Remote control unit) (Main unit)

Enter the setting.
The Advanced Playback Menu reappears.

5 Setting the Option Setup

1

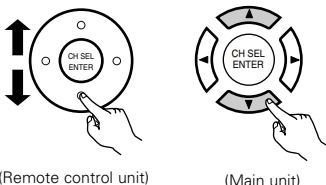

(Remote control unit) (Main unit)

Select "Option Setup" at the System Setup Menu.

5

*System Setup
Option Setup

System Setup Menu

1. Auto Setup/Room EQ
2. Speaker Setup
3. Input Setup
4. Advanced Playback
5. Option setup

Exit

2



(Remote control unit) (Main unit)

Display the Option Setup Menu Screen.

5-1 Setting the Power Amplifier Assignment

Make this setting to switch the power amplifier for the surround back channel to ZONE2 or ZONE3.

If ZONE2/3 is selected, the signal that selected at ZONE2/3 is output at "SURR. BACK/MULTI ZONE PREOUT" terminals.

1

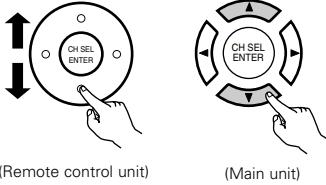

(Remote control unit) (Main unit)

Select "Power Amp Assignment" at the Option Setup Menu.

```
*Option Setup      5.1
P.AMP Assign
```

5. Option Setup

1. Power Amp Assign
2. Zone2 Vol. Level
3. Trigger Out 1 Setup
4. Trigger Out 2 Setup
5. Muting Level
6. On Screen Display
7. Setup Lock
- Exit

2

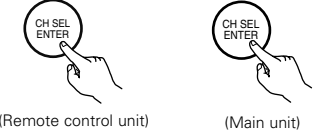

(Remote control unit) (Main unit)

Press the ENTER button.
Display the Power Amp Assign screen.

3

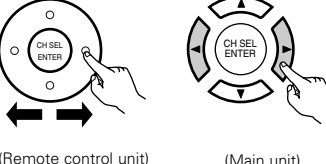

(Remote control unit) (Main unit)

Select "Surround Back" to use as the surround back channel, "Zone2" to use as Zone2 out, Zone3 to use as Zone3 out.

```
*P.AMP Assign      4.4
S.Back
```

5-1. Power Amp Assign

Surroundback ▶ Zone2 Zone3

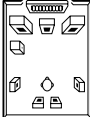

5-1. Power Amp Assign

Surroundback ◀ Zone2 ▶ Zone3

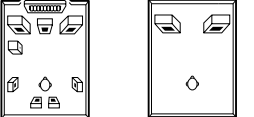

5-1. Power Amp Assign

Surroundback Zone2 ◀ Zone3

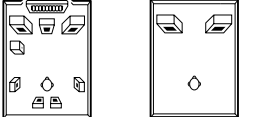

When "Surround Back" is selected
When "Zone2" is selected
When "Zone3" is selected

4

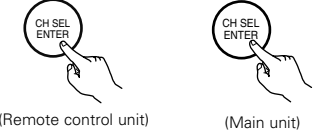

(Remote control unit) (Main unit)

Enter the setting.
The Option Setup Menu reappear.

5-2 Setting the Zone2 vol. Level

Set the Zone2 pre-out output level adjustment.

1

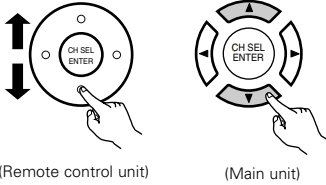

(Remote control unit) (Main unit)

At the Option Setup Menu select "Zone2 vol.Level".

```
*Option Setup      5.2
Zone2 Vol.Level
```

5. Option Setup

1. Power Amp Assign
2. Zone2 Vol. Level
3. Trigger Out 1 Setup
4. Trigger Out 2 Setup
5. Muting Level
6. On Screen Display
7. Setup Lock
- Exit

2

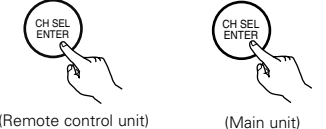

(Remote control unit) (Main unit)

Display the Zone2 vol. Level screen.

3

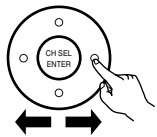

(Remote control unit)

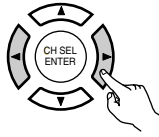

(Main unit)

Select the desired setting.

Variable:

The level can be adjusted freely using the buttons on the remote control unit.

0 dB, -40 dB:

The output level is fixed at the set level and the volume can no longer be adjusted.

NOTE:

- When "ZONE2" is selected at System Setup Menu "5-1. Power amp Assign", the Zone2 vol. Level is all set to "variable" including preout level and this menu is not displayed.

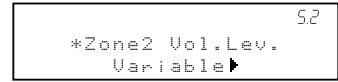
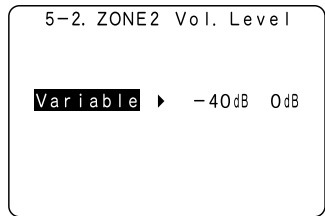

4



(Remote control unit)



(Main unit)

Enter the setting.

The Option Setup Menu reappears.

5-3, 5-4 Setting the Trigger Out Setup

- Set the Trigger Out output 1 for the different input sources.

1

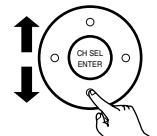

(Remote control unit)

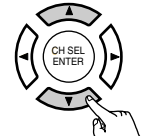

(Main unit)

Select "Trigger Out 1 Setup" at the Option Setup Menu.

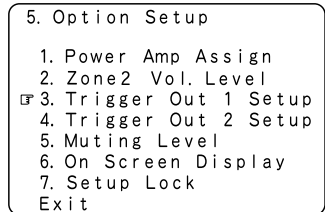
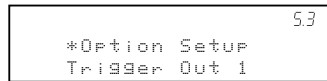

2



(Remote control unit)



(Main unit)

Display to the Trigger Out 1 Setup screen.

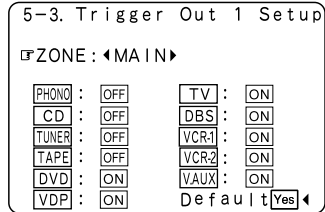
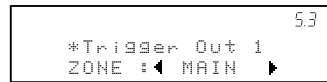

3

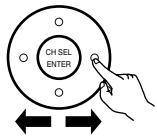

(Remote control unit)

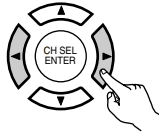

(Main unit)

Select the Zone (MAIN, Zone2 and Zone3).

4

① Select the input source.

② Select "ON" or "OFF".

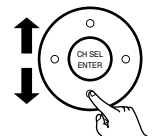

(Remote control unit)



(Main unit)

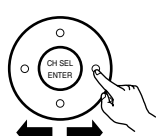

(Remote control unit)



(Main unit)

5



(Remote control unit)



(Main unit)

Enter the setting

The Option Setup Menu reappears.

※ Set the Trigger out 2 Setup in the same way.

5-5 Setting the Muting Level

- This sets the amount of attenuation at audio output muting.

1

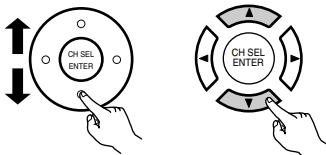

(Remote control unit) (Main unit)

Select "Muting Level" at the Option Setup Menu .



5. Option Setup

1. Power Amp Assign
2. Zone2 Vol. Level
3. Trigger Out 1 Setup
4. Trigger Out 2 Setup
5. Muting Level
6. On Screen Display
7. Setup Lock
- Exit

2



(Remote control unit) (Main unit)

Display the Muting Level screen.

3

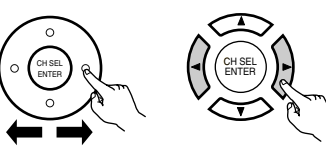

(Remote control unit) (Main unit)

Select the desired setting.



5-5. Muting Level

---dB ▶ - 4 0dB - 2 0dB

- 20 dB: It is turned down the volume to -20 dB from the present level.
- 40 dB: It is turned down the volume to -40 dB from the present level.

4



(Remote control unit) (Main unit)

Enter the setting.
The Option Setup Menu reappears.

5-6 Setting the On Screen Display (OSD)

- Use this to turn the on-screen display (messages other than the menu screens) on or off.
- Sets the on-screen display's display mode.
 - Mode 1: Prevents flickering of the on-screen display when there is no video signal.
 - Mode 2: Flickering is not prevented.
 Use this mode if the on-screen display does not appear in the mode 1, as may happen according to the TV being used.

1

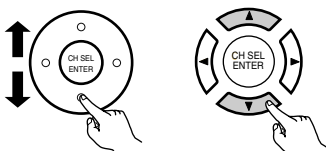

(Remote control unit) (Main unit)

Select "On Screen Display" at the Option Setup Menu.

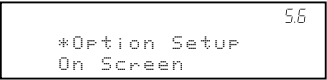

5. Option Setup

1. Power Amp Assign
2. Zone2 Vol. Level
3. Trigger Out 1 Setup
4. Trigger Out 2 Setup
5. Muting Level
6. On Screen Display
7. Setup Lock
- Exit

2



(Remote control unit) (Main unit)

Display the On screen display setup screen.

3

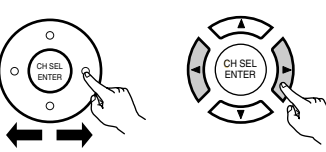

(Remote control unit) (Main unit)

Select "ON" or "OFF".

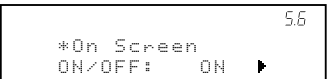

5-6. On Screen Display

ON ◀ ▶ OFF

Mode 1 ◀ ▶ Mode 2

4

① Select the On Screen Display mode.

② Select "Mode1" or "Mode2".

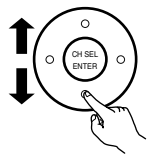

(Remote control unit)



(Main unit)

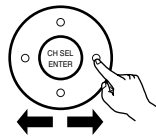

(Remote control unit)



(Main unit)

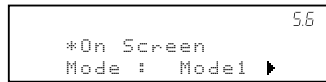
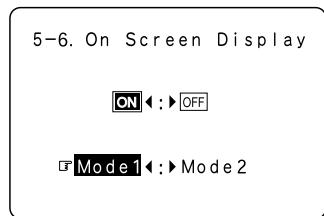

5



(Remote control unit)



(Main unit)

Enter the setting.
The Option Setup Menu reappears.

5-7 Protecting the setting

The system setup settings can be locked so that they cannot be changed easily.

1

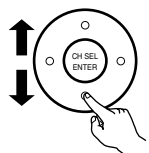

(Remote control unit)



(Main unit)

Select "Setup Lock" at the Option Setup Menu.

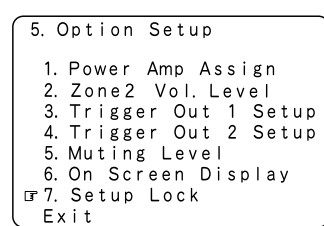
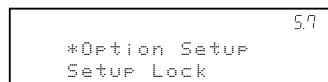

2



(Remote control unit)



(Main unit)

Display the Setup Lock screen.

3



(Remote control unit)



(Main unit)

Select "ON", to lock the system setup settings.

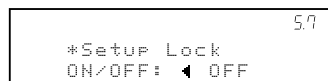

4



(Remote control unit)



(Main unit)

Press the "ENTER" button to finalize the setting and exit the Option setup mode.
When the setup lock function is activated, the settings listed below cannot be changed, and "Setup Locked" is displayed when related buttons are operated.

- System setup settings
- Surround parameter settings
- Tone control settings
- Channel level settings (including test tones)

To unlock, press the System Setup button again and display the Setup Lock screen, then select "OFF" and press "ENTER".

※ System setup is complete. Once these settings are made, there is no need to change them unless different AV components are connected or the speakers are repositioned.

After completing system setup

This button can be pressed at any time during the system setup process to complete the process.

1

SYS SETUP



(Remote control unit)



(Main unit)

Press the SYSTEM SETUP button at the System Setup Menu.

※ The changed settings are entered and the on-screen display turns off.

• On-screen display signals

	Signals input to the AVR-3805		On-screen display signal output		
	VIDEO signal input jack (yellow)	S-video signal input jack	Video signal output to VIDEO MONITOR OUT jack (yellow)	Video signal output to S-Video MONITOR OUT jack	Video signal output to Color Difference (Component) Video MONITOR OUT jack
1	×	×	○	○	○
2	○	×	○	○	○
3	×	○	○	○	○
4	○	○	×	○	○

(○: Signal ×: No signal)

(○: On-screen signals output ×: On-screen signals not output)

NOTE:

- When a component video signal is input and when the "Video Input Mode" is set to the component fixed mode at Input setup, the on-screen display is only displayed when the System Setup, Surround Parameters and On Screen buttons are operated.

8 REMOTE CONTROL UNIT

- The included remote control unit (RC-969) can be used to operate not only the AVR-3805 but other remote control compatible DENON components as well. In addition, the memory contains the control signals for other remote control units, so it can be used to operate non-Denon remote control compatible products.

Inserting the batteries

- ① Remove the remote control unit's rear cover.

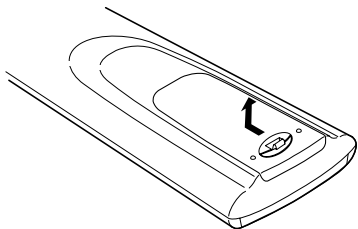

- ② Set three R03/AAA batteries in the battery compartment in the indicated direction.

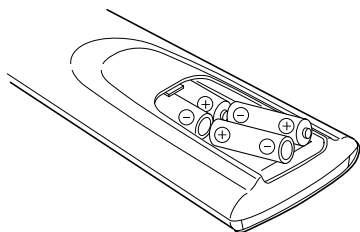

- ③ Put the rear cover back on.

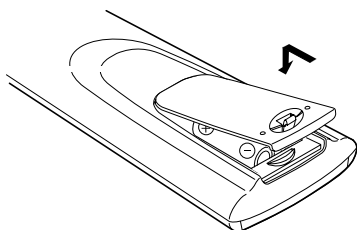

Notes on Batteries

- Use R03/AAA batteries in the remote control unit.
- The batteries should be replaced with new ones approximately once a year, though this depends on the frequency of usage.
- Even if less than a year has passed, replace the batteries with new ones if the set does not operate even when the remote control unit is operated nearby the set. (The included battery is only for verifying operation. Replace it with a new battery as soon as possible.)
- When inserting the batteries, be sure to do so in the proper direction, following the “+” and “-” marks in the battery compartment.
- To prevent damage or leakage of battery fluid:
 - Do not use a new battery together with an old one.
 - Do not use two different types of batteries.
 - Do not short-circuit, disassemble, heat or dispose of batteries in flames.
- Remove the batteries from the remote control unit when you do not plan to use it for an extended period of time.
- If the battery fluid should leak, carefully wipe the fluid off the inside of the battery compartment and insert new batteries.
- When replacing the batteries, have the new batteries ready and insert them as quickly as possible.

Using the remote control unit

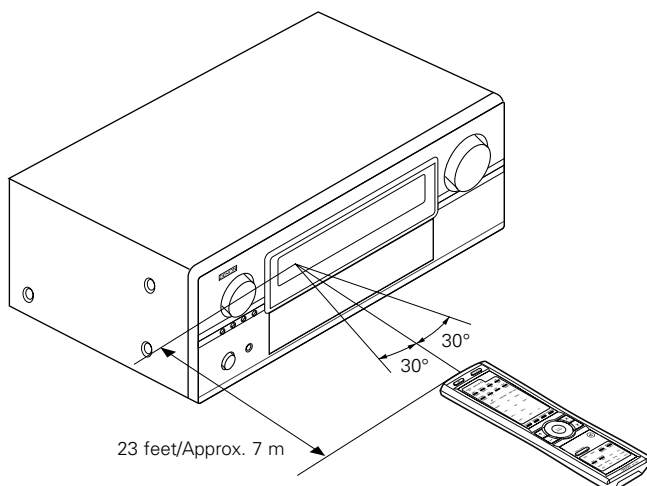

- Point the remote control unit at the remote sensor on the main unit as shown on the diagram.
- The remote control unit can be used from a straight distance of approximately 23 feet / 7 meters from the main unit, but this distance will be shorter if there are obstacles in the way or if the remote control unit is not pointed directly at the remote sensor.
- The remote control unit can be operated at a horizontal angle of up to 30 degrees with respect to the remote sensor.

NOTES:

- It may be difficult to operate the remote control unit if the remote sensor is exposed to direct sunlight or strong artificial light.
- Do not press buttons on the main unit and remote control unit simultaneously. Doing so may result in malfunction.
- Neon signs or other devices emitting pulse-type noise nearby may result in malfunction, so keep the set as far away from such devices as possible.

Operating DENON audio components

1 Use the mode selector buttons to select the component you want to operate.

※ The function switches as shown below each time one of the mode buttons is pressed.

- AMP/TUNER : AMP, TUNER
- ZONE2/ZONE3 : ZONE2, ZONE3
- TAPE/MD : TAPE, MD
- CD/CDR : CD, CDR
- TV/DBS/CABLE : TV, DBS, CABLE
- VCR1/VCR2 : VCR1, VCR2
- VDP : VDP
- DVD/DVDR : DVD, DVDR

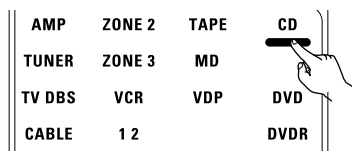

Example: Select "AMP" mode. Select "TUNER" mode.

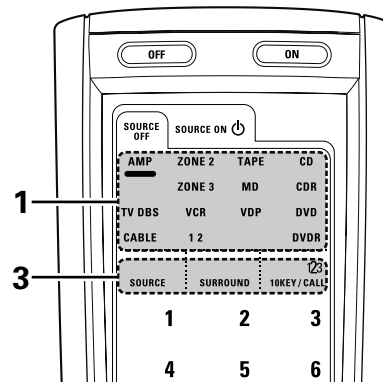
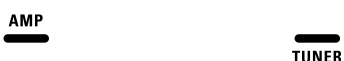

2 Operate the audio component.

- For details, refer to the component's operating instructions.
- ※ It may not be possible to operate some models.

3 [SOURCE MENU]

- Operate the source.

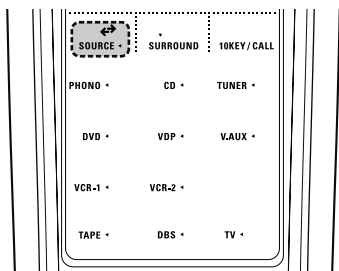

[SURROUND MENU]

- Operate the surround mode.

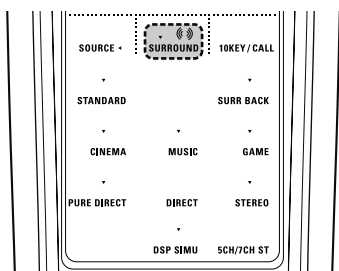

[10KEY / SYSTEM CALL MENU]

- Operate the 10KEY or SYSTEM CALL mode.

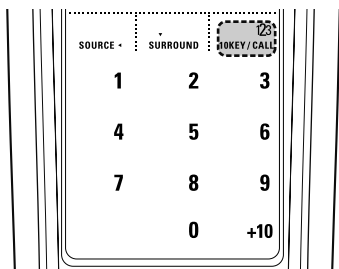

1. CD player (CD) system buttons

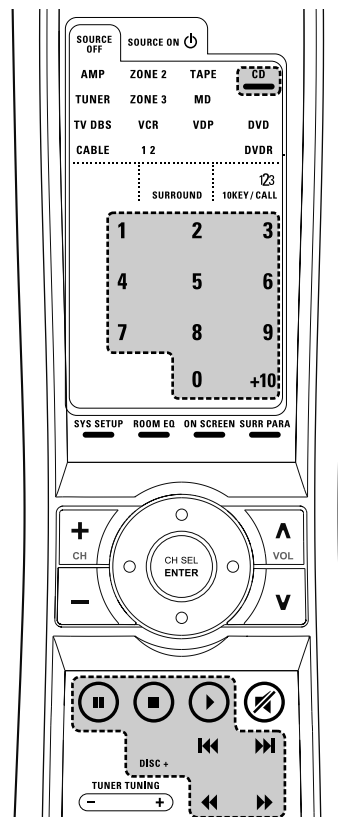

- ◀▶ : Manual search (forward and reverse)
- : Stop
- ▶ : Play
- ◀▶▶ : Auto search (to beginning of track)
- ⏸ : Pause
- DISC SKIP + : (for CD changers only)
- 0~9, +10 : 10 Key

2. TAPE deck (TAPE) system buttons

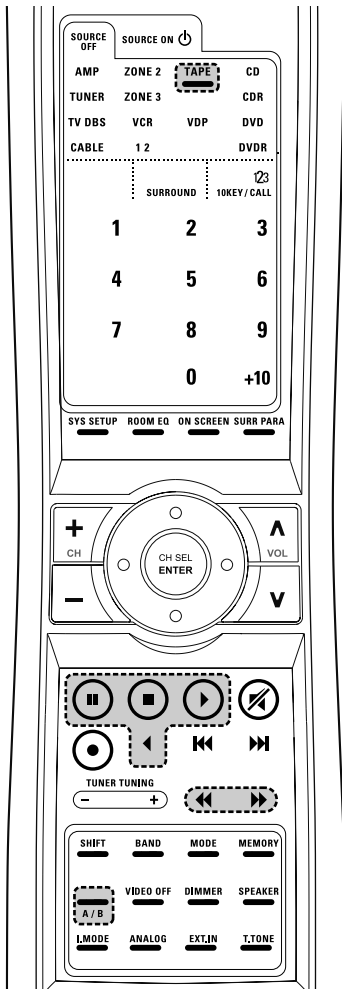

- : Rewind
- : Fast forward
- : Stop
- : Forward Play
- : Pause
- : Reverse Play
- A/B : Switch between sides A and B

3. MD recorder (MD), CD recorder (CDR) system buttons

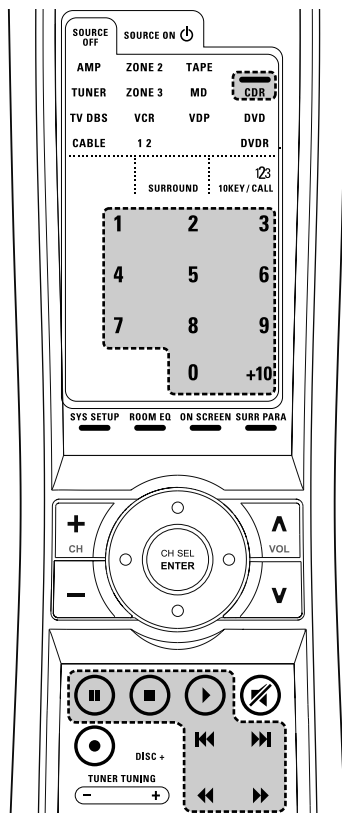

- : Manual search (forward and reverse)
- : Stop
- : Play
- : Auto search (to beginning of track)
- : Pause
- 0~9, +10 : 10 Key

4. Tuner system buttons

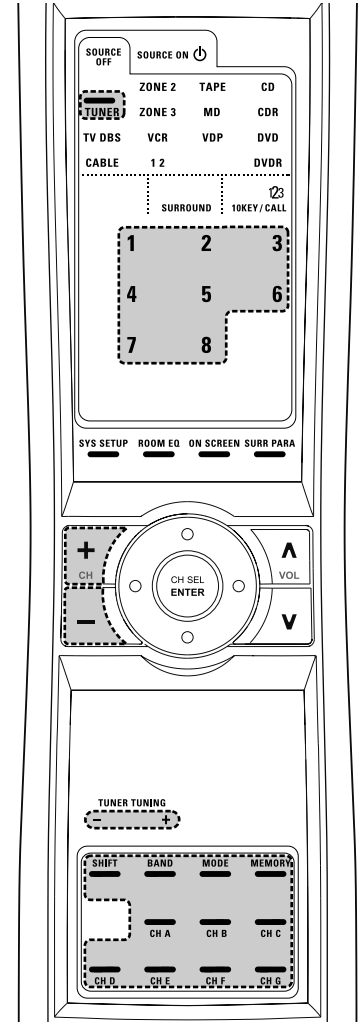

- TUNING +, - : Tuning up/down
- BAND : Switch between AM and FM bands
- MODE : Switch between AUTO and MANUAL
- MEMORY : Preset memory
- SHIFT : Switch preset channel range
- CHANNEL +, - : Preset channel up/down
- CHA~G : Preset channel range
- 1~8 : Preset channel

Preset memory

The included remote control unit can be used to operate devices of different brands by registering the preset number corresponding to the brand of your device.

For some models the remote control unit or the device may not operate properly. In this case, use the learning function (page 56) to store your device's remote control signals in the included remote control unit.

For instructions on resetting the preset memory, see page 60.

- 1** Press the power ON button and the OFF button at the same time.



- 2** Press the "1" button to select preset memory.

• Setup List

- 1 : Preset memory
- 2 : Learning setup
- 3 : System call
- 4 : Punch through
- 5 : Light setup
- 6 : Reset

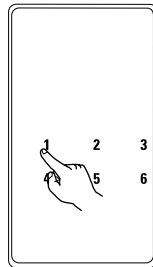

- 3** Press the Mode button for the component you want to preset, then press ENTER button.

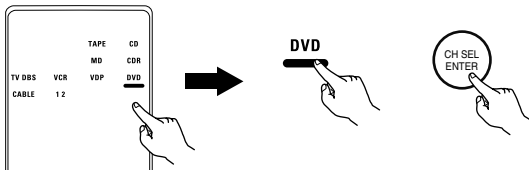

- 4** Referring to the included List of Preset Codes, use the number buttons to input the preset code (a 4-digit number) for the manufacturer of the component whose signals you want to store in the memory.

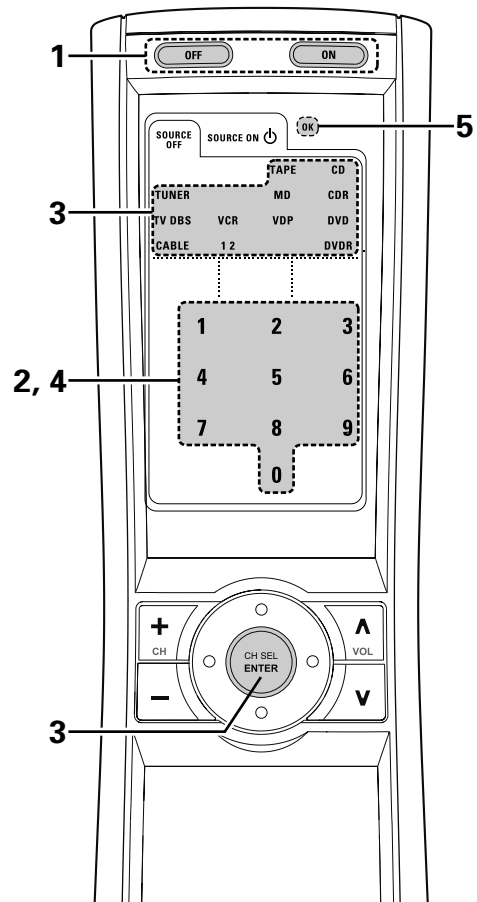
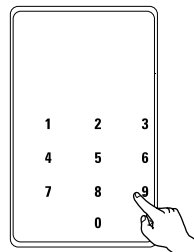

- 5** "OK" is displayed when the signals are registered and the mode is terminated.

"FAIL" is displayed when the signals are not registered, repeat steps 1 to 5.

- 6** To store the codes of another component in the memory, repeat steps 1 to 5.

NOTES:

- Depending on the model and year of manufacture, this function cannot be used for some models, even if the your device is listed on the included list of preset codes.
- Some manufacturers use more than one type of remote control code. Refer to the included list of preset codes to change the number and check it out.

The preset codes are as follows upon shipment from the factory and after resetting:

TV, VCR1	HITACHI
CD, MD, TAPE, CDR, VDP, DVD, DVDR.....	DENON
VCR2, DBS.....	SONY
CABLE.....	ABC

Operating a component stored in the preset memory

1 Press the mode selector button for the component you want to operate.

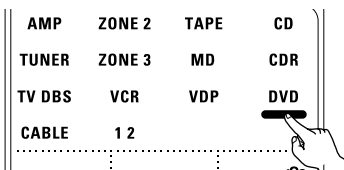

NOTE:

- For the DVD player remote control buttons, function names may differ according to manufacturer. Compare with the remote control operation of the various components.

2 Operate the component.

- For details, refer to the component's operating instructions.
- ※ Some models cannot be operated with this remote control unit.

1. Digital video disc player (DVD), Digital video disc recorder (DVD R) system buttons

- SOURCE ON : Power on
- SOURCE OFF : Power off (DENON DVD only)
- ◀▶ : Manual search (forward and reverse)
- : Stop
- ▶ : Play
- ◀▶▶ : Auto search (to beginning of track)
- ⏸ : Pause
- DISC SKIP + : Disk skip (for DVD changers only)
- SETUP : Setup
- TOP MENU : Top menu
- MENU : Menu
- RETURN : Return
- ▲▼◀▶ : Cursor up,down,left and right
- ENTER : Enter
- AUDIO : Switch the audio language
- DISPLAY : Display
- SUBTITLE : Switch the subtitle
- ANGLE : Switch the angle
- 0-9, +10 : 10 key

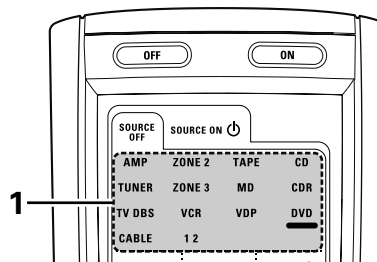
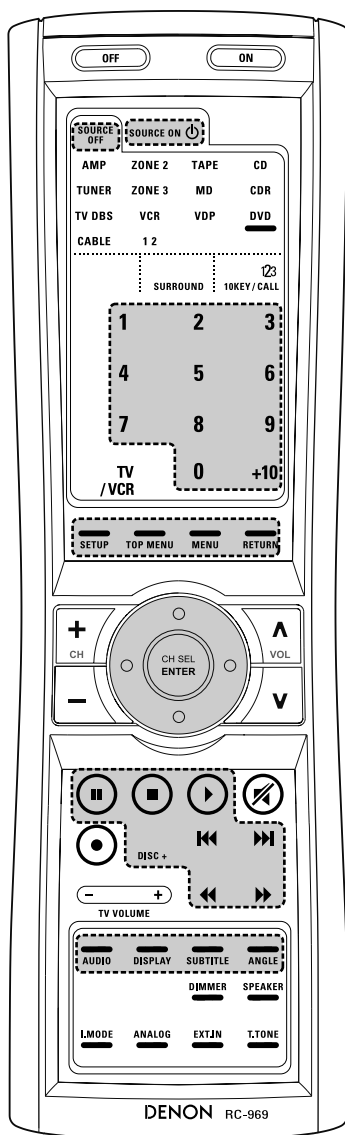

2. Video disc player (VDP) system buttons

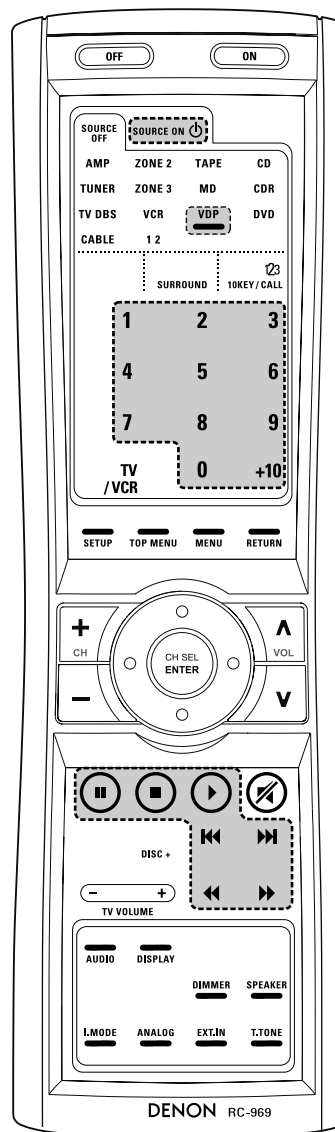

- SOURCE ON : Power on/Standby
- ◀▶ : Manual search (forward and reverse)
- : Stop
- ▶ : Play
- ◀▶▶ : Auto search (cue)
- ⏸ : Pause
- 0-9, +10 : 10 key

3. Video deck (VCR-1/VCR-2) system buttons

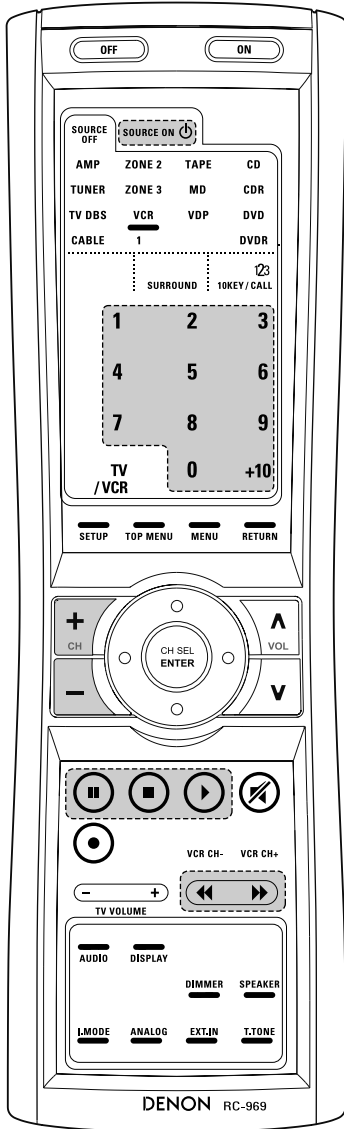

4. Monitor TV (TV), digital broadcast satellite (DBS) tuner and cable (CABLE) system buttons

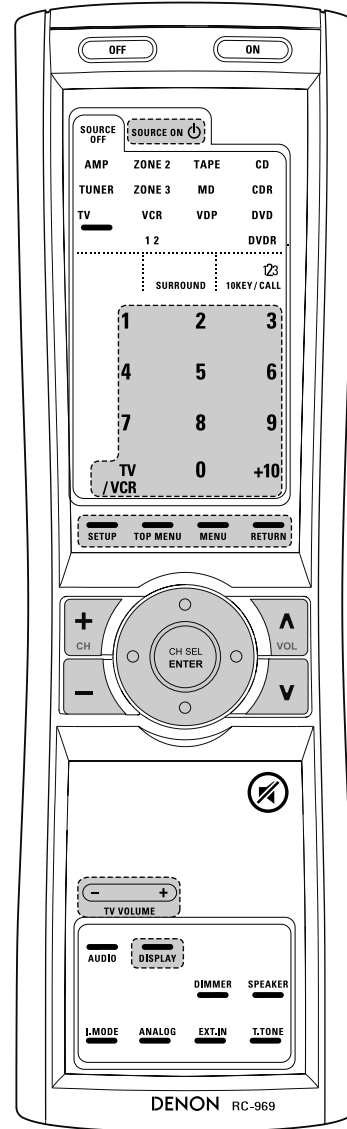

- SOURCE ON : Power on/Standby
- ◀▶ : Manual search (forward and reverse)
- : Stop
- ▶ : Play
- ⏸ : Pause
- 0~9, +10 : 10 key

- SOURCE ON : Power on/standby
- ◀▶ : Manual search (forward and reverse)
- SETUP : Setup
- TOP MENU : Top menu
- MENU : Menu
- RETURN : Return
- ▲▼◀▶ : Cursor up,down,left and right
- ENTER : Enter
- DISPLAY : Switch display
- Channel +, - : Switch channels +,-
- 0~9, +10 : 10 key
- TV/VCR : Switch between TV and video player
- VOL +,- : Volume up/down

Learning function

If your AV component is not a Denon product or if it cannot be operated using the preset memory, it can be controlled with the accessories remote control unit by storing its remote control signals in the remote control unit. For some remote control signals it is not possible to "learn" the signals or the device will not operate properly. In such cases use the remote control unit included with the device to operate it.

- 1** Press the power ON button and the OFF button simultaneously.

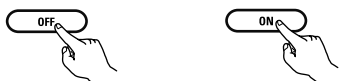

- 2** Press the "2" button to select Learning setup.

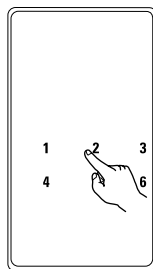

- 3** Press the Mode button for the component you want to learned, then press the ENTER button. Learning is not possible for the AMP, ZONE2, and ZONE3 modes.

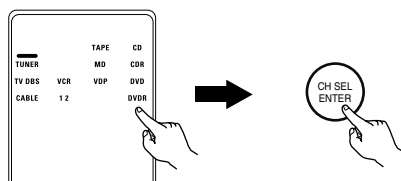

- 4** Buttons that allow learning will light. Press the button that you wish to be learned. **The display will go off and the unit will enter the learning standby mode.**

- To cancel, press the power ON button and the OFF button simultaneously.

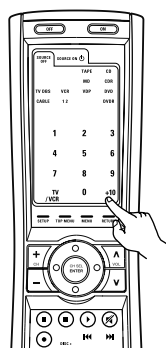

- 5** Point the remote control units directly at each other and press and hold in the button on the other remote control unit which you want to "learn".

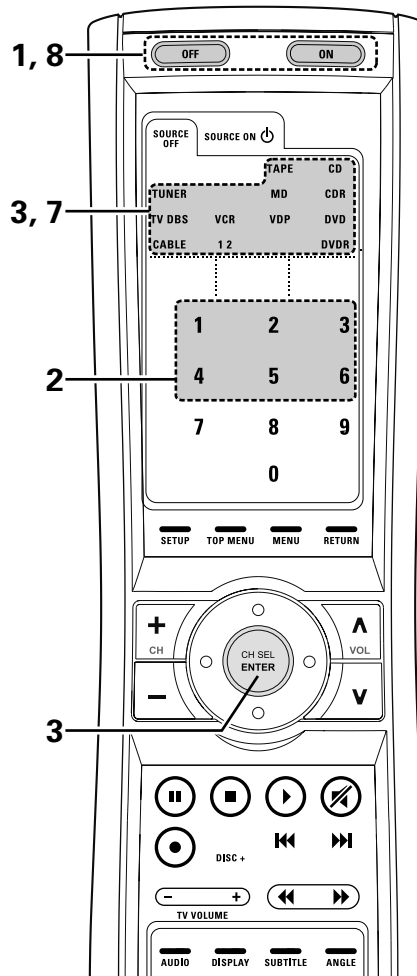
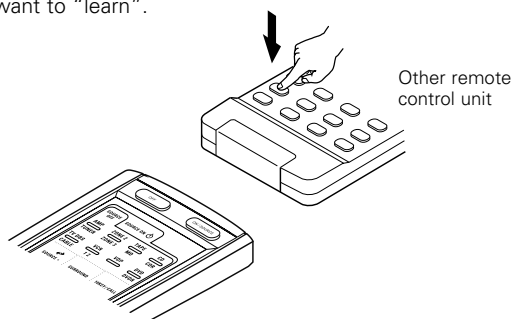

- 6** "OK" appears on the remote control unit's display and learning is completed.

- Other keys can be "learned" by repeating steps 5 to 6.
- "FAIL" appears on the remote control unit's display, repeating steps 4 to 6.

- 7** The mode can be switched by pressing a mode selector button.

The "Buttons that allow learning" display reappears and the learning standby mode is set.

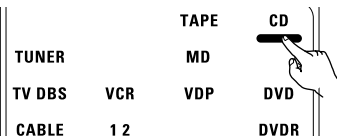

- 8** To cancel the learning mode, press the power ON button and the OFF button simultaneously again.



System call

The accessories remote control unit is equipped with "system call" function allowing a series of remote control signals to be transmitted by pressing a single button.

This function can be used for example to turn on the amplifier's power, select the input source, turn on the monitor TV's power, turn on the source component's power and set the source to the play mode, all at a signal button.

(1) System call buttons

Up to 12 signals each can be stored at the "CALL1" ~ "CALL6" buttons.

The System Call function can be used in the "AMP", "ZONE2", and "ZONE3" modes.

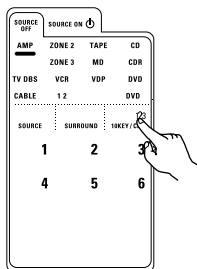

(2) Storing system call signals

- 1 Press the power ON button and the OFF button at the same time.



- 2 Press the "3" button to select system call setting.

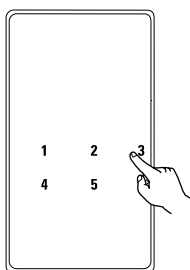

- 3 Press the Mode button for the component you want to register at the system call button, then press the ENTER button.

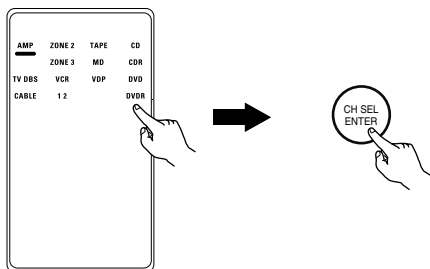

- 4 Press the button you want to register.

- 5 The mode can be switched by pressing a mode button.

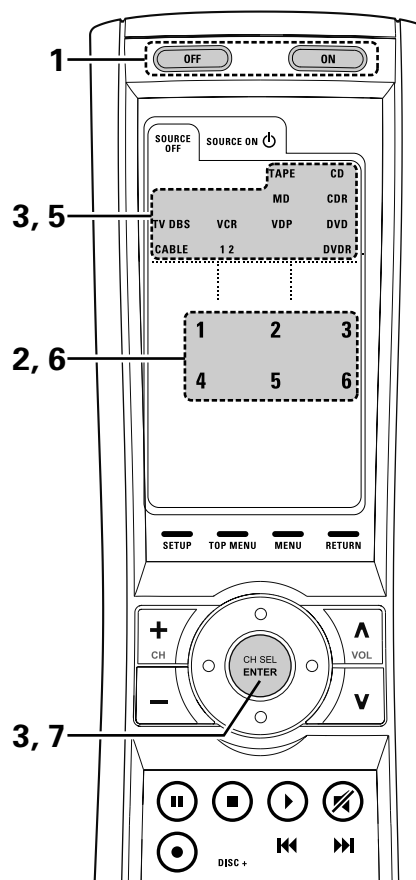
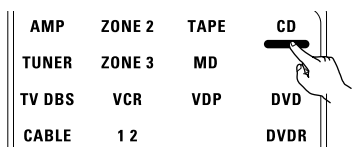

- 6 Repeat steps 4 and 5 to register the desired buttons. Up to 12 signals each can be stored at the CALL1~CALL6.
- 7 Press the ENTER button after the button registration is completed. There will be a changeover to the System Call registration screen.
- 8 Press buttons from "CALL 1" to "CALL 6" to register the System Call.
 - "OK" is displayed and the set returns to the normal operating mode.

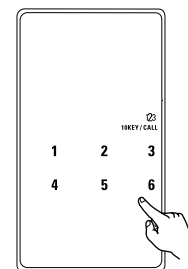

NOTES:

- The remote control signals of the buttons pressed while registering the system call signals are emitted, so be careful not to operate the components accidentally (cover the remote sensors, for example).
- If you exceed the number of signals that can be registered, There will be a changeover to the System Call registration screen.

(3) Using the system call function

- 1** Press the button at which the system call signals have been stored.
- The stored signals are transmitted successively.

Punch Through

(1) Punch through button

Buttons used in the CD, CDR, MD, TAPE, DVD, DVDR, VDP, VCR1 and VCR2 modes can be assigned to the buttons which are not normally used in the AMP, ZONE2, ZONE3, TV, DBS and CABLE modes.

For example, when the CD mode is set to the punch through mode in the AMP mode, the CD mode's PLAY, STOP, MANUAL SEARCH, AUTO SEARCH, PAUSE and DISC SKIP buttons' signals are sent in the AMP mode.

(2) Making the punch through setting

- 1** Press the power ON button and the OFF button at the same time.



- 2** Press the "4" button to select punch through setting.

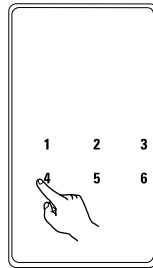

- 3** Press the mode button for the component you want to make the punch through setting, then press the ENTER button.

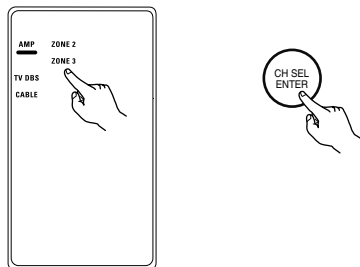

- 4** Press the mode button for the component you want to punch through, then press the ENTER button.

- The punch through is set and the set returns to the normal operating mode.

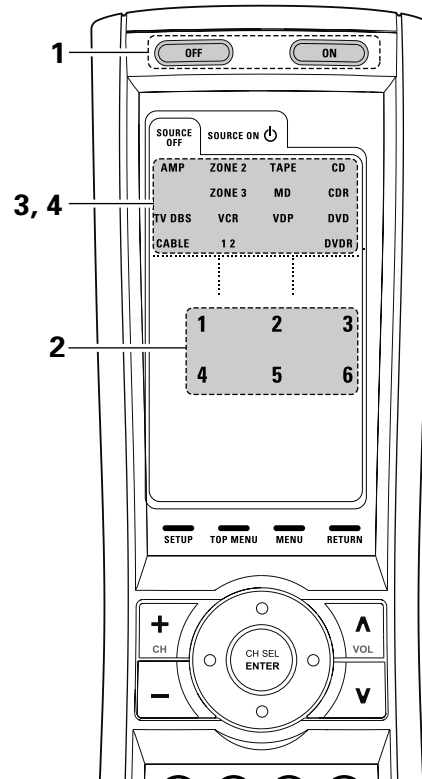
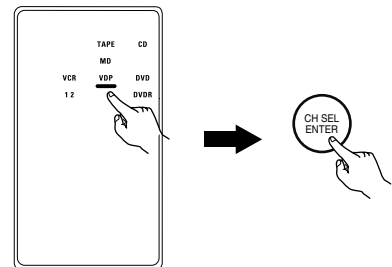

Setting the back light's lighting time

- 1** Press the power ON button and the OFF button at the same time.

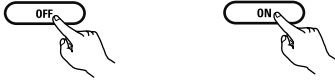

- 2** Press the "5" button to select Light setup.

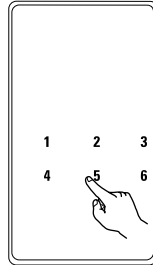

- 3** Press the button you want to adjust the lighting time (5sec~20sec).

- Lighting time
 - 1 : 5sec
 - 2 : 10sec
 - 3 : 15sec
 - 4 : 20sec

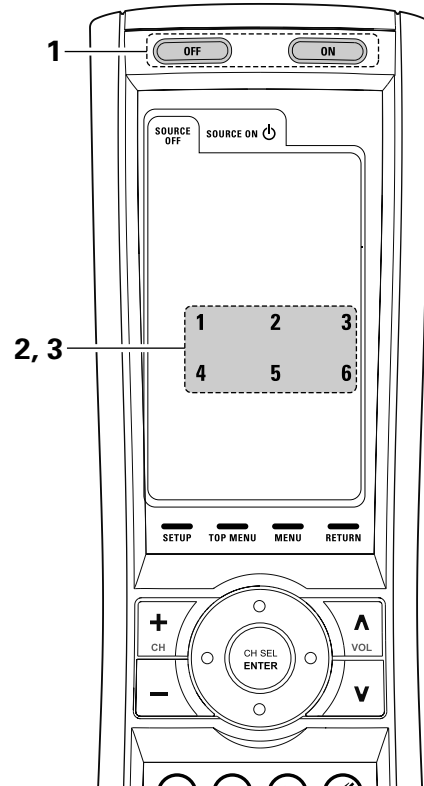
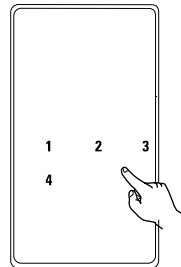

Setting the brightness

The brightness of the display can be adjusted in 4 levels.

- For 1 step brighten Hold the ENTER button and press the CH+ (channel up) button.
- For 1 step dimmer Hold the ENTER button and press the CH- (channel down) button.

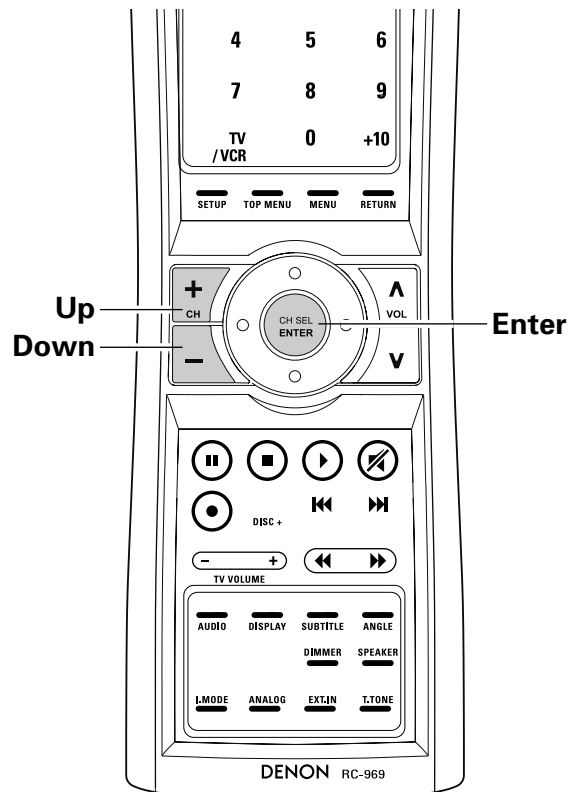
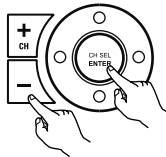

Resetting

(1) Resetting the preset memory

1 Press the power ON button and the OFF button at the same time.



2 Press the "6" button to select Resetting.

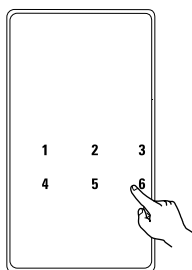

3 Press the "1" button to resetting the preset memory.

• Presetting List

- 1 : Resetting the preset memory
- 2 : Resetting the "Learned" buttons
- 3 : Resetting the system call
- 4 : Resetting the punch through setting
- +10: All reset function (factory default)

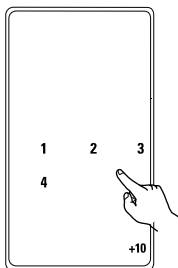

4 The mode buttons that were set in preset memory will all light.

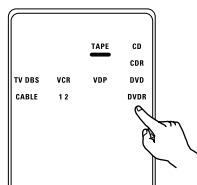

5 Press the mode button you want to resetting, then press the ENTER button.

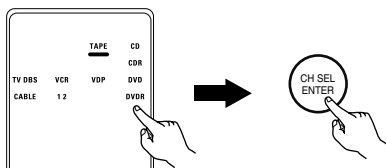

The set returns to the normal operating mode.

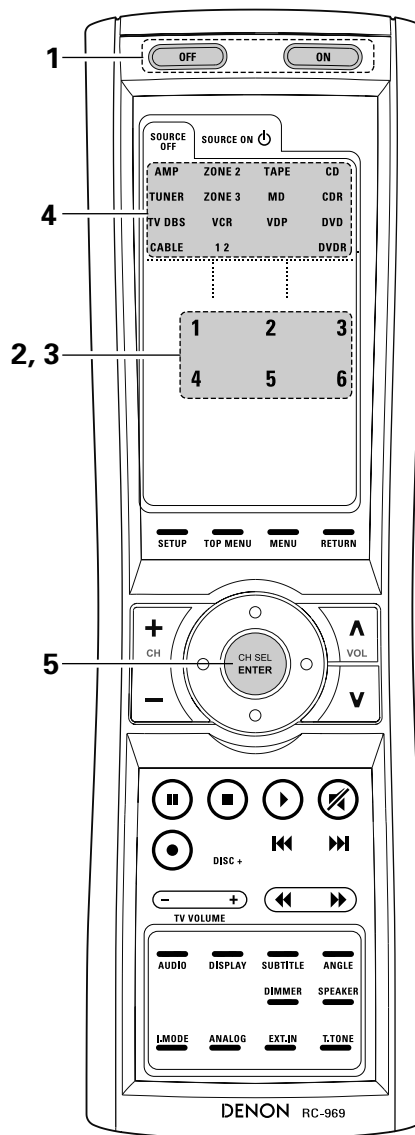

(2) Resetting "learned" buttons

- 1** Press the power ON button and the OFF button at the same time.
 - 2** Press the "6" button to select resetting.
 - 3** Press the "2" button to resetting the "learned" buttons
 - 4** The mode buttons will all light.
 - 5** Press the mode button you want to resetting, then press the ENTER button.
The set returns to the normal operating mode.
-

(3) Resetting the system call buttons

- 1** Press the power ON button and the OFF button at the same time.
 - 2** Press the "6" button to select resetting.
 - 3** Press the "3" button to resetting.the system call buttons.
 - 4** All buttons of System Call will light.
 - 5** Press the button you want to resetting, then press the ENTER button.
The set returns to the normal operating mode.
-

(4) Resetting the punch through setting

- 1** Press the power ON button and the OFF button at the same time.
 - 2** Press the "6" button to select resetting.
 - 3** Press the "4" button to resetting the "punch through" setting.
 - 4** All punched through mode buttons will light.
 - 5** Press the mode button you want to resetting, then press the ENTER button.
The set returns to the normal operating mode.
-

(5) All reset function

- 1** Press the power ON button and the OFF button at the same time.
 - 2** Press the "6" button to select resetting.
 - 3** Press the "+10" button to resetting, all the settings (factory defaults).
 - The set returns to the normal operating mode after approximately 20 seconds.
-

9 OPERATION

Operating the remote control unit

1 Select "AMP" using the AMP/TUNER button.

2 [SOURCE MENU]
• Operate the source.

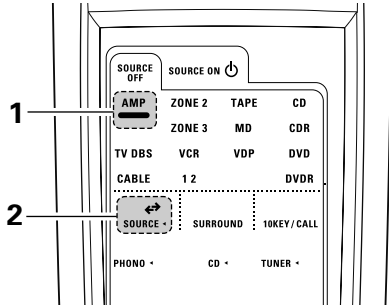

3 [SURROUND MENU]
• Operate the surround mode.

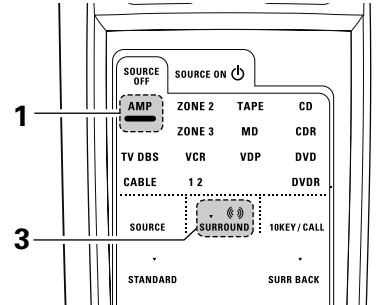

Before operating

1 Refer to "CONNECTIONS" (pages 6 to 13) and check that all connections are correct.

2 Select "AMP" using the AMP/TUNER button.
(only when operating with the remote control unit)



(Remote control unit)

3 Press the POWER switch (button).



(Main unit)

- **ON**
The power turns on and indicator is light.
Set the power switch to this position to turn the power on and off from the included remote control unit.
- **OFF**
The power turns off and indicator is off.
In this position, the power cannot be turned on and off from the remote control unit.

4 Turn on the power
Press the POWER ON/STANDBY switch (button).

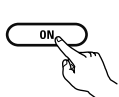

(Remote control unit)



(Main unit)

When pressed, the power turns on and the display lights. The sound is muted for several seconds, after which the unit operates normally. When pressed again, the power turns off, the standby mode is set and the display turns off.

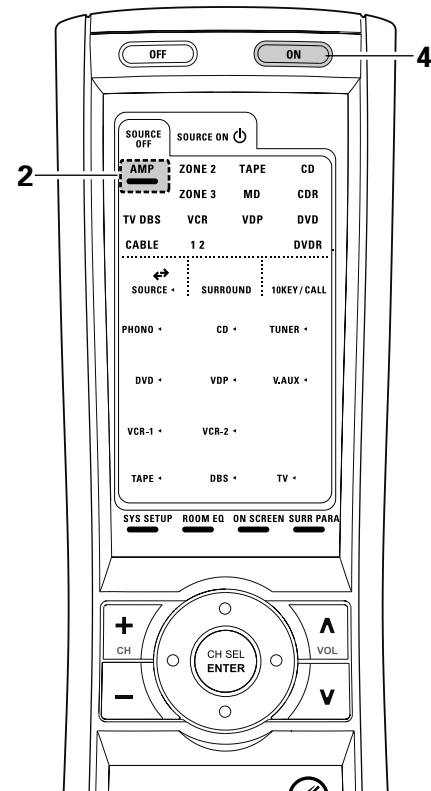
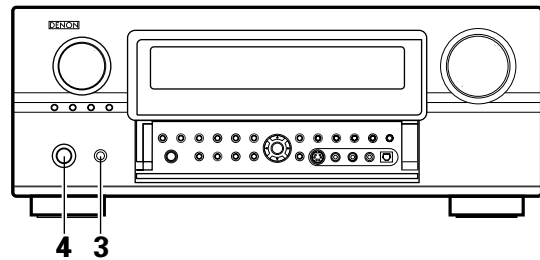

Playing the input source

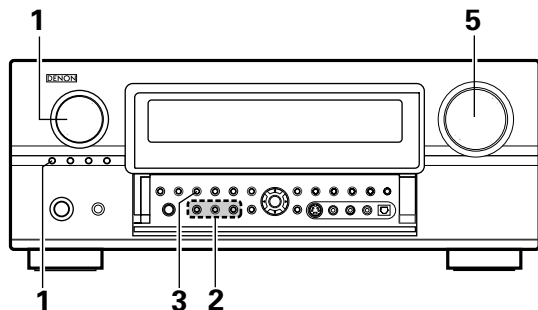

1 Select the input source to be played.

Example: CD



(Remote control unit)

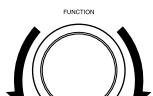

(Main unit)

※ To select the input source when ZONE2/ZONE3/REC OUT or TUNING PRESET is selected, press the SOURCE button then operate the input function selector.



(Main unit)

2 Select the input mode.

- Selecting the analog mode
Press the ANALOG button to switch to the analog input.



(Remote control unit)



(Main unit)

- Selecting the external input (EXT. IN) mode
Press the EXT. IN (on the EXT. IN button on the remote control unit) to switch the external input.



(Remote control unit)



(Main unit)

- Selecting the AUTO, PCM and DTS modes
The mode switches as shown below each time the INPUT MODE button is pressed.



(Remote control unit)



(Main unit)

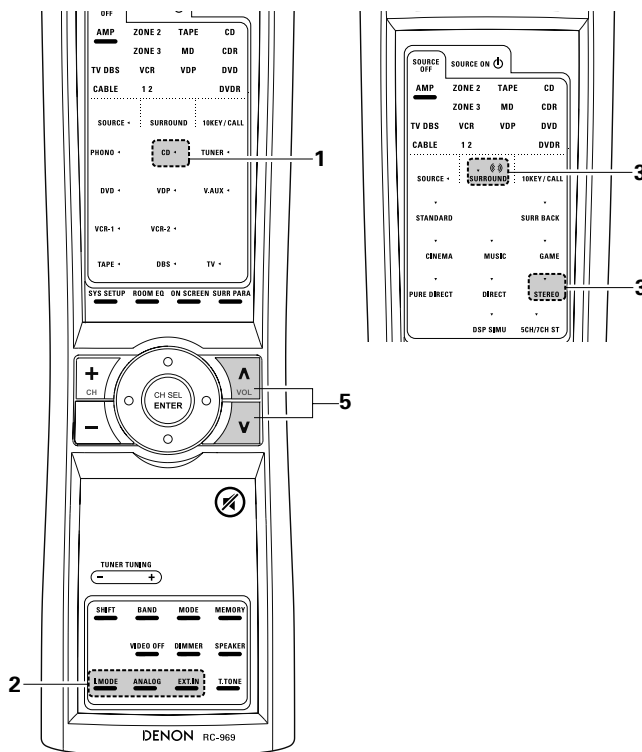

Input mode selection function

Different input modes can be selected for the different input sources. The selected input modes for the separate input sources are stored in the memory.

① AUTO (auto mode)

In this mode, the types of signals being input to the digital and analog input jacks for the selected input source are detected and the program in the AVR-3805's surround decoder is selected automatically upon playback. This mode can be selected for all input sources other than PHONO and TUNER.

The presence or absence of digital signals is detected, the signals input to the digital input jacks are identified and decoding and playback are performed automatically in DTS, Dolby Digital or PCM (2 channel stereo) format. If no digital signal is being input, the analog input jacks are selected.

Use this mode to play Dolby Digital signals.

② PCM (exclusive PCM signal playback mode)

Decoding and playback are only performed when PCM signals are being input.

Note that noise may be generated when using this mode to play signals other than PCM signals.

③ DTS (exclusive DTS signal playback mode)

Decoding and playback are only performed when DTS signals are being input.

④ ANALOG (exclusive analog audio signal playback mode)

The signals input to the analog input jacks are played.

⑤ EXT. IN (external decoder input jack selection mode)

The signals being input to the external decoder input jacks are played without passing through the surround circuitry.

NOTE:

- Note that noise will be output when CDs or LDs recorded in DTS format are played in the "PCM" (exclusive PCM signal playback) or "ANALOG" (exclusive PCM signal playback) mode. Select the AUTO or DTS mode when playing signals recorded in DTS from a laser disc player or CD player.

Note on playing a source encoded with DTS

- Noise may be generated at the beginning of playback and while searching during DTS playback in the AUTO mode. If so, play in the DTS mode.

3 Select the play mode.

Example: Stereo

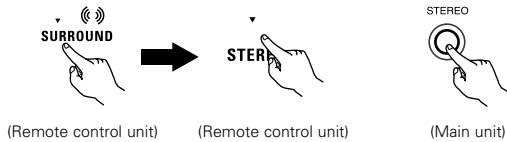

4 Start playback on the selected component.

- For operating instructions, refer to the component's manual.

5 Adjust the volume.

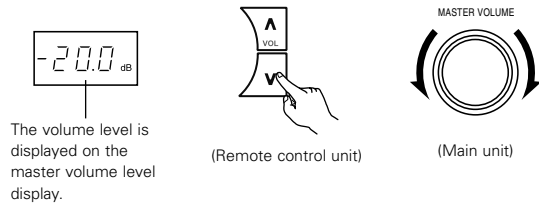

The volume level is displayed on the master volume level display.

- ※ The volume can be adjusted within the range of -80 to 0 to 18 dB, in steps of 0.5 dB. However, when the channel level is set as described on page 34-36 or pages 72 and 73, if the volume for any channel is set at +0.5 dB or greater, the volume cannot be adjusted up to 18 dB. (In this case the maximum volume adjustment range is "18 dB — (Maximum value of channel level)".)

Input mode when playing DTS sources

- Noise will be output if DTS-compatible CDs or LDs are played in the "ANALOG" or "PCM" mode.
- When playing DTS-compatible sources, be sure to connect the source component to the digital input jacks (OPTICAL/COAXIAL) and set the input mode to "DTS".

Input mode display

- In the AUTO mode



- In the DIGITAL PCM mode



- In the DIGITAL DTS mode



- In the ANALOG mode



- In the EXT.IN mode



Depending on the input signal.

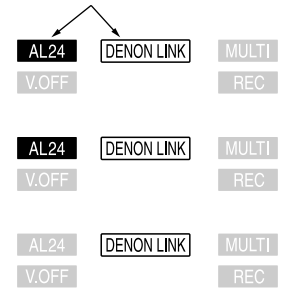

Input signal display

- DOLBY DIGITAL

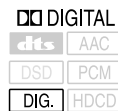

- DTS



- PCM

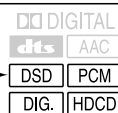

Depending on the input signal.

- The [DSD] indicator lights when the DENON LINK have been connected and the DSD signals have been inputted. (See page 14)

Depending on the input signal.

- The [HDCD] indicator lights when digital signals are being input with a player that supports HDCD playback.

- ※ The [DIG.] indicator lights when digital signals are being input properly. If the [DIG.] indicator does not light, check whether the digital input component setup (page 39) and connections are correct and whether the component's power is turned on.

- ※ AL24 processing is activated when PCM signals are played while the surround mode is set to PURE DIRECT, DIRECT, STEREO, MULTI CH DIRECT or MULTI CH IN.

NOTE:

- The [DIG.] indicator will light when playing CD-ROMs containing data other than audio signals, but no sound will be heard.

Playback using the external input (EXT. IN) jacks

- 1** Set the external input (EXT. IN) mode.
Press the EXT. IN to switch the external input.

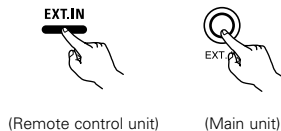

Once this is selected, the input signals connected to the FL (front left), FR (front right), C (center), SL (surround left), SR (surround right), SBL (surround back left) and SBR (surround back right) channels of the EXT. IN jacks are output directly to the front (left and right), center, surround (left and right) and surround back (left and right) speaker systems as well as the pre-out jacks without passing through the surround circuitry. In addition, the signal input to the SW (subwoofer) jack is output to the PRE OUT SUBWOOFER jack.

- 2** Cancelling the external input mode
To cancel the external input (EXT. IN) setting, press the input mode (I.MODE, PCM, DTS) or ANALOG button to switch to the desired input mode. (See page 60)

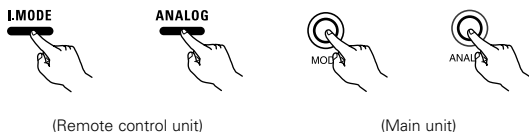

- When the input mode is set to the external input (EXT. IN), the surround mode (DIRECT, STEREO, STANDARD, 5/7CH STEREO, WIDE SCREEN or DSP SIMULATION) cannot be set.

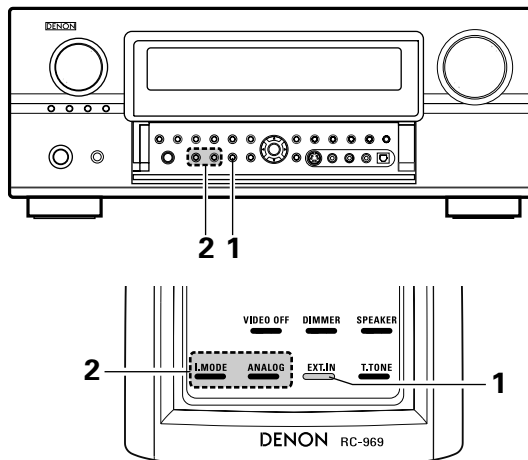

NOTES:

- In play modes other than the external input mode, the signals connected to these jacks cannot be played. In addition, signals cannot be output from channels not connected to the input jacks.
- The external input mode can be set for any input source. To watch video while listening to sound, select the input source to which the video signal is connected, then set this mode.
- If the subwoofer output level seems to high, set the "SW ATT" surround parameter to "ON".

Playing audio sources (CDs and DVDs)

The AVR-3805 is equipped with three 2-channel playback modes exclusively for music. Select the mode to suit your tastes.

1 PURE DIRECT mode

In this mode, the music is played with an extremely high level of sound quality. When this mode is set, all the video-related circuits are turned off so that music signals can be reproduced with high quality. When an analog mode is selected, the digital processing circuitry is also turned off to achieve analog sound with even higher purity. (See NOTES)

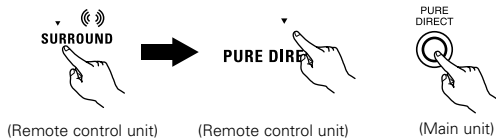

2 DIRECT mode

Use this mode to achieve good quality 2-channel sound while watching images. In this mode, the audio signals bypass such circuits as the tone circuit and are transmitted directly, resulting in good quality sound.

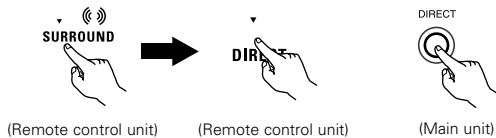

※ Using this mode, the DSD (2-channel/MULTI-channel) signal can be reproduced with high quality.

- The display in 2-channel input.
DSD DIRECT
- The display in MULTI-channel input
DSD MULTI DRCT

3 STEREO mode

Use this mode to adjust the tone and achieve the desired sound while watching images.

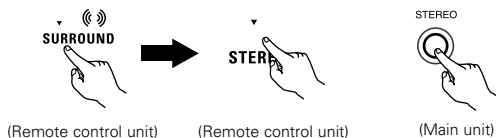

4 VIDEO ON/OFF button

When no video signals of a DVD, etc., are connected to the AVR-3805 and the DVD, etc., are connected directly to a TV, etc., the unneeded video circuitry can be turned off by selecting the "VIDEO OFF" setting.

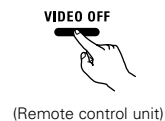

NOTES:

- The system setup function cannot be used when the PURE DIRECT mode is set. To use the system setup function, cancel the PURE DIRECT mode.
- The ZONE2 video output is not output in the PURE DIRECT mode.
- The channel level and surround parameters in the PURE DIRECT mode are the same as in the DIRECT mode.
- When the PURE DIRECT button is pressed while in the PURE DIRECT mode, the PURE DIRECT mode is cancelled.
- The subwoofer's channel level must be set to "OFF" in order to turn off the digital circuit in the PURE DIRECT mode.

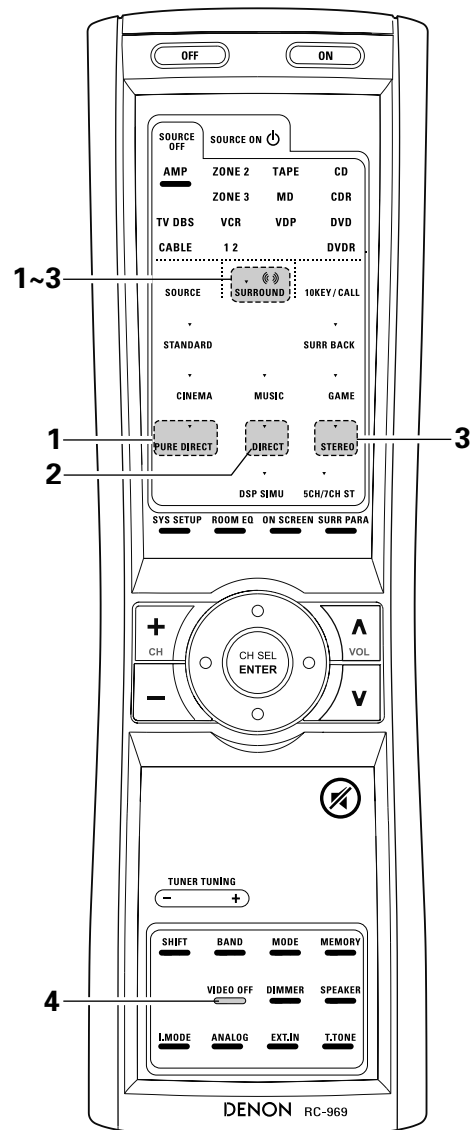
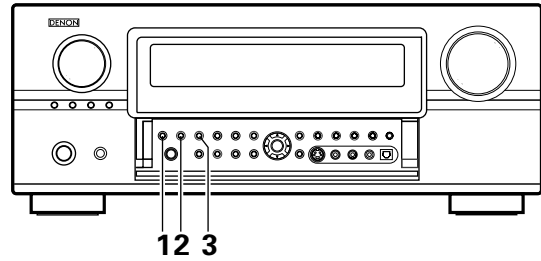

After starting playback

[1] Adjusting the sound quality (TONE)

The tone control function will not work in the PURE DIRECT and the DIRECT mode.

- 1** The tone switches as follows each time the TONE CONTROL button is pressed.



- 2** With the name of the volume to be adjusted selected, press cursor button to adjust the level.

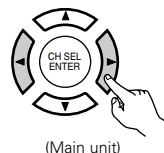

- To increase the bass or treble: Press the button. (The bass or treble sound can be increased to up to +6 dB in steps of 1 dB.)
- To decrease the bass or treble: Press the button. (The bass or treble sound can be decreased to up to -6 dB in steps of 1 dB.)

[2] Listening over headphone

- 1** Plug the headphone plug into the jack.

- ※ Connect the headphone to the PHONES jack. The pre-out output (including the speaker output) is automatically turned off when headphone are connected.

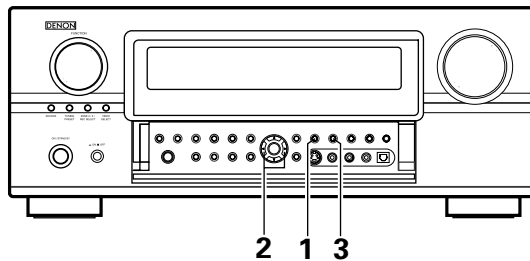
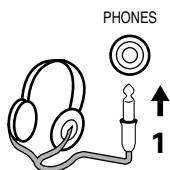

- 3** If you do not want the bass and treble to be adjusted, turn on the tone defeat mode.



- ※ The signals do not pass through the bass and treble adjustment circuits, providing higher quality sound.

[3] Turning the sound off temporarily (MUTING)

- 1** Use this to mute the audio output temporarily. Press the MUTING button.

- ※ Cancelling MUTING mode. Press the MUTING button again.



[4] Combining the currently playing sound with the desired image

- 1** Simulcast playback
Use this switch to monitor a video source other than the audio source. Press the VIDEO SELECT button, turn the FUNCTION knob until the desired source appears on the display.

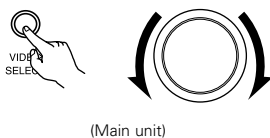

- ※ Cancelling simulcast playback.
 - Select "SOURCE" using the VIDEO SELECT button and the FUNCTION button.
 - Switch the program source to the component connected to the video input.
 - Press the SOURCE button.

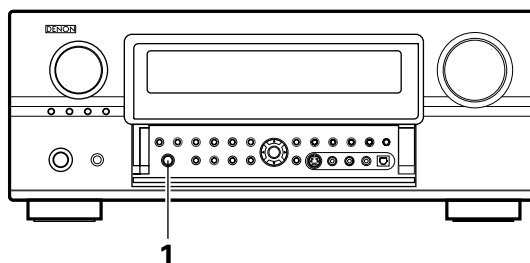

NOTE:

To prevent hearing loss, do not raise the volume level excessively when using headphone.

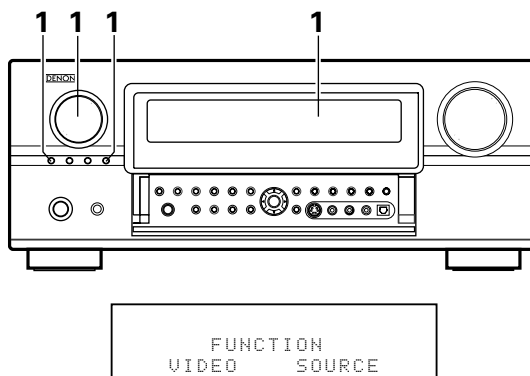
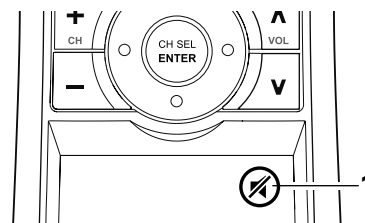

[5] Checking the currently playing program source, etc.

- 1** On screen display
- Each time an operation is performed, a description of that operation appears on the display connected to the unit's VIDEO MONITOR OUT jack. Also, the unit's operating status can be checked during playback by pressing the remote control unit's ON SCREEN button.
- Such information as the position of the input selector and the surround parameter settings is output in sequence.



(Remote control unit)

- Front panel display
- Descriptions of the unit's operations are also displayed on the front panel display. In addition, the display can be switched to check the unit's operating status while playing a source by pressing the STATUS button.

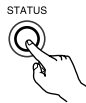

(Main unit)

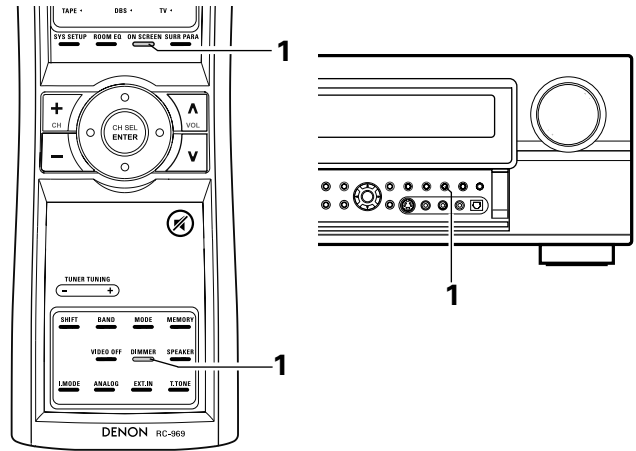

- Using the dimmer function
- Use this to change the brightness of the display. The display brightness changes in four steps (bright, medium, dim and off) by pressing the main unit's DIMMER button repeatedly.



(Remote control unit)

[6] Switching the surround speakers

- 1** The surround speakers switch as shown below each time the SPEAKER button is pressed.



(Remote control unit)

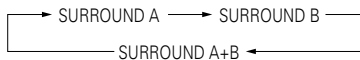

※ This operation is possible when the setting for using both surround speakers A and B is made at "Speaker Config" in the System Setup Menu.

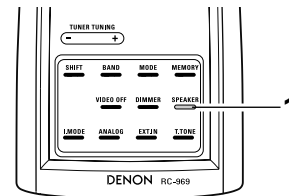

Multi-source recording/playback

Playing one source while recording another (REC OUT mode)

- 1** Press the ZONE2/REC button until "ZONE2 SOURCE" appears on the display.



(Main unit)

- 2** With "ZONE2 SOURCE" displayed, turn the FUNCTION knob until "RECOUT SOURCE" appears on the display. With "RECOUT SOURCE" displayed, turn the FUNCTION knob to select the source you wish to record.
- When the FUNCTION goes around, it turn to the "REC" indicator and the indicator of the selected source light.

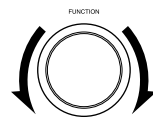

(Main unit)

- 3** Set the recording mode.
- For operating instructions, refer to the manual of the component on which you want to record.

- 4** To cancel, turn the function knob.

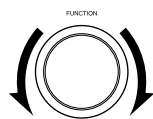

(Main unit)

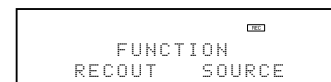
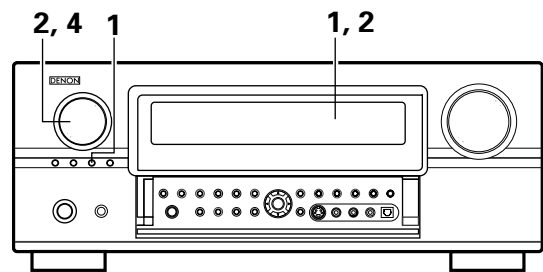

NOTES:

- Recording sources other than digital inputs selected in the REC OUT mode are also outputted from the Zone2 preout jacks.
- Digital signals are not outputted from the analog REC OUT jacks.

10 MULTI ZONE

Multi-zone playback with multi-source

MULTI ZONE MUSIC ENTERTAINMENT SYSTEM

- When the outputs of the “ZONE2 (ZONE3)” OUT terminals are wired and connected to integrated amplifiers installed in other rooms, different sources can be played in rooms other than the main zone in which this unit and the playback devices are installed. (Refer to ZONE2 (ZONE3) on the diagram below.)
 - MULTI ZONE SPEAKER OUT can be used when “ZONE3” is selected at System Setup Menu “Power Amp Assign”. In this case, Surround Back Speaker OUT cannot be used for MAIN ZONE. (See page 45.)
 - When a sold separately room-to-room remote control unit (DENON RC-616, 617 or 618) is wired and connected between the MAIN ZONE and ZONE2 (ZONE3), the remote-controllable devices in the main zone can be controlled from ZONE2 (ZONE3) using the remote control unit.
- ※ To control playback devices other than the ones above, either use that device’s remote control unit or preset a separately sold programmable remote control unit.

NOTES:

- For the AUDIO output, use high quality pin-plug cords and wire in such a way that there is no humming or noise.
- For instructions on installation and operation of separately sold devices, refer to the devices’ operating instructions.
- When the PURE DIRECT , VIDEO OFF mode is set for the main zone, no signals are output to the ZONE2 video terminals.
- Signals are output from the ZONE2 video terminals even when ZONE2 is set to “OFF”.

MULTI ROOM MUSIC ENTERTAINMENT SYSTEM

[1] Multi-zone playback using the ZONE2 PREOUT and ZONE3 FIXED-OUT terminals

■ When using the SURR.BACK/MULTI ZONE amplifier as the SURROUND BACK.

The AVR-3805 is equipped with pre-out terminals for which the volume is adjustable (ZONE2) and composite video output terminals as the ZONE2 output terminals and fixed output level as the ZONE3 output terminals.

(1) System configuration and connections example.

Using external amplifier

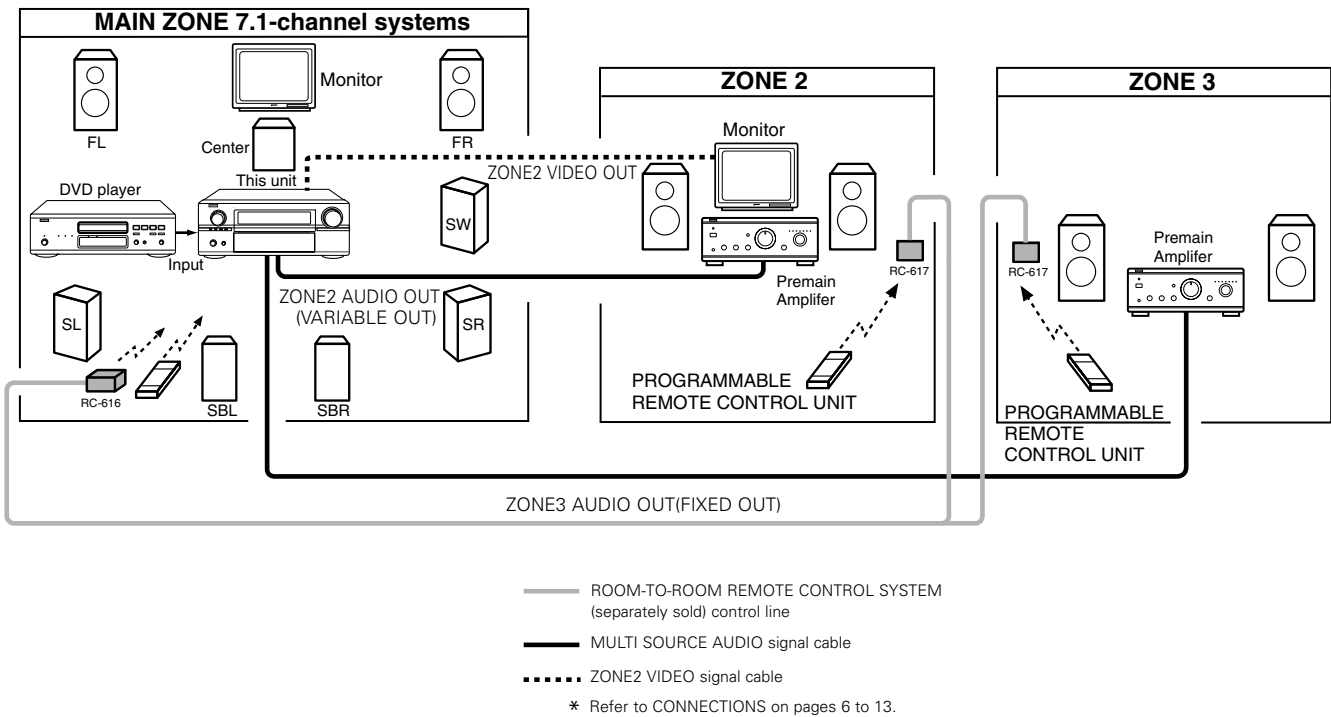

[2] Multi-zone playback using the ZONE2 PREOUT and MULTI ZONE3 terminals

■ When using the SURR.BACK/MULTI ZONE amplifier as the ZONE2/ZONE3.

- ZONE2/ZONE3 preout and speaker out can be used when "ZONE3" is selected at System Setup Menu "Power Amp Assign". In this case, Surround Back PREOUT and speaker out cannot be used for MAIN ZONE.
- The AVR-3805 is equipped with preout terminals for which the volume is adjustable (ZONE 2, MULTI ZONE) and speaker out terminals for which the volume is adjustable (MULTI ZONE) and fixed output level as the ZONE3 output terminals and composite video output terminals as the ZONE2 output terminals.

(1) System configuration and connections example.
Using external amplifier as the ZONE2 and using this unit's internal amplifier as the ZONE3.

(2) System configuration and connections example.
Using this unit's internal amplifier as the ZONE2 and using external amplifier as the ZONE3.

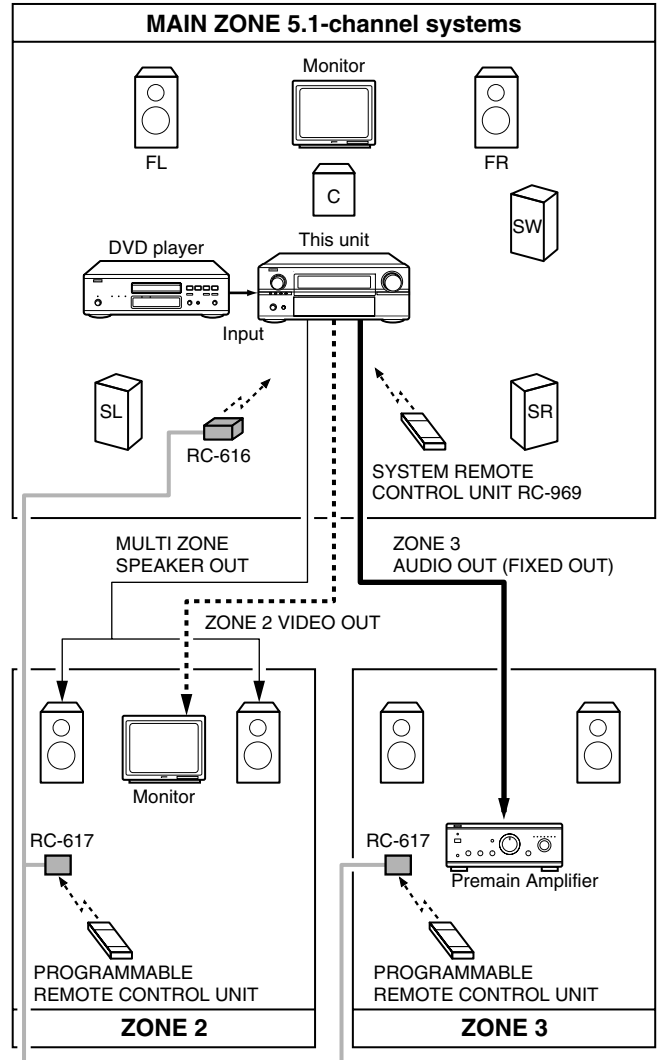
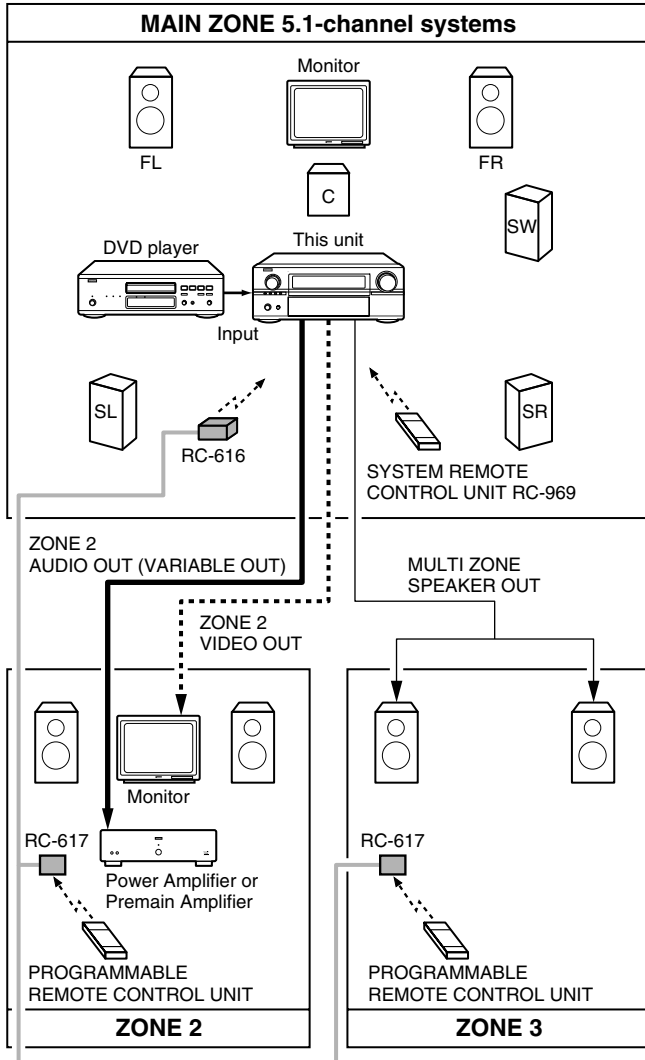

- ROOM-TO-ROOM REMOTE CONTROL SYSTEM (separately sold) control line
- MULTI SOURCE AUDIO signal cable
- SPEAKER cable
- ZONE2 VIDEO signal cable

* Refer to CONNECTIONS on pages 7 to 16.

[1] Outputting a program source to an amplifier, etc., in a different room (ZONE2, ZONE3 mode)

- 1** Press the "ON" button.



(Main unit)
- 2** Press the ZONE2/3/REC button. The display switches as follows each time the button is pressed.

ZONE2 ←→ ZONE3
(RECOUT)

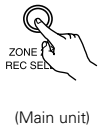

(Main unit)
- 3** With "ZONE2 SOURCE" displayed, turn the FUNCTION knob and select the source you wish to output.

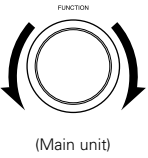
 - The display switches the selected source.

(Main unit)
- 4** Start playing the source to be output.

 - For operating instructions, refer to the manuals of the respective components.

• ZONE3 can also be set with a method similar to the above.

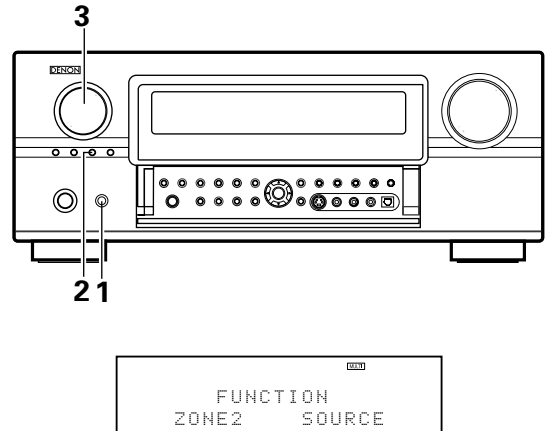

NOTES:

- The signals of the source selected in the ZONE2 mode are also output from the VCR-1, VCR-2 and CDR/TAPE recording output jacks.
- Digital signals are not output from the ZONE3, audio (FIXED-OUT) output jacks and ZONE2 audio output jacks.
- Refer to page 69, 70 about the MULTI ZONE connections.

[2] Remote control unit operations during multi-source playback (selecting the input source)

This operation is not possible in the REC OUT mode.

- 1** Select "ZONE2" using the ZONE2/ZONE3 button.

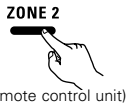

(Remote control unit)
 - 2** Press the "SOURCE ON" button.

※ To turn off the ZONE2 mode, press the ZONE2 "SOURCE OFF" button.

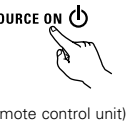

(Remote control unit)
 - 3** Press the input source button

 - The ZONE2 source switches directly.
 - 4** The output level of the ZONE2 OUT terminals can be controlled using the VOLUME + and - buttons on the remote control unit. The output level of ZONE2 OUT can be controlled only if ZONE2 vol. level is set "Variable" at Zone2 Control in System Setup Menu. (see page 45,46)

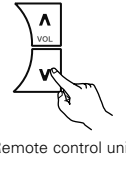

(Remote control unit)

※ DEFAULT SETTING (ZONE2 VOLUME LEVEL) :
--- dB (MINIMUM)
 - 5** When the ZONE2 SOURCE function is set to TUNER, the preset channel can be selected using the CHANNEL + and - buttons on the remote control unit.

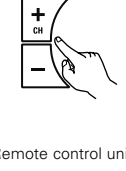

(Remote control unit)
- ZONE 3 can also be set with a method similar to the above.

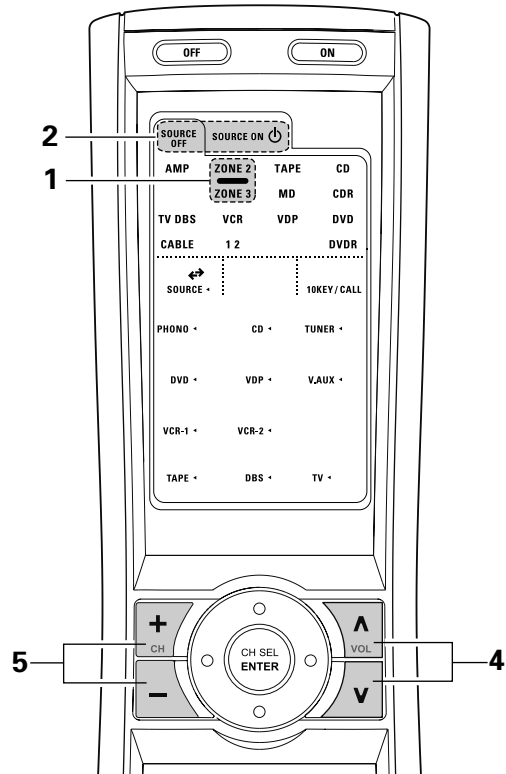

NOTE:

- The main zone output can be turn on and off "SOURCE ON/OFF"button (AMP mode)

11 SURROUND

Before playing with the surround function

- Before playing with the surround function, be sure to use the test tones to adjust the playback level from the different speakers. This adjustment can be performed with the system setup (see page 34~35) or from the remote control unit, as described below.
- Adjusting with the remote control unit using the test tones is only possible in the "Auto" mode and only effective in the STANDARD (DOLBY/DTS SURROUND) modes. The adjusted levels for the different modes are automatically stored in the memory.

1  Press the TEST TONE button.
(Remote control unit)

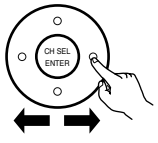
2  Test tones are output from the different speakers. Use the channel volume adjust buttons to adjust so that the volume of the test tones is the same for all the speakers.
(Remote control unit)

3  After completing the adjustment, press the TEST TONE button again.
(Remote control unit)

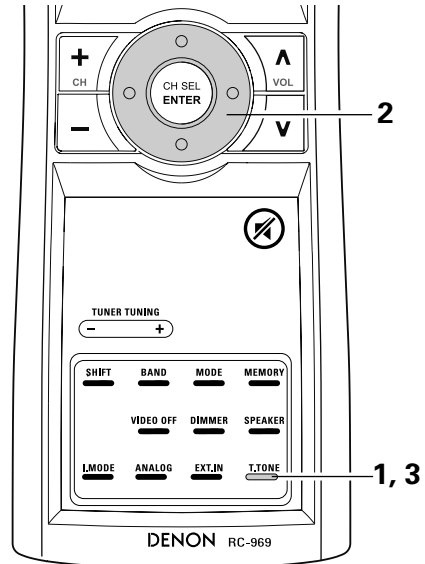

- After adjusting using the test tones, adjust the channel levels either according to the playback sources or to suit your tastes, as described below.

1  Select the speaker level you want to adjust.
(Remote control unit)
The channel switches as shown below each time the button is pressed.

```

    graph LR
      FL[FL] --> C[C]
      C --> FR[FR]
      FR --> SR[SR]
      SR --> SBR[SBR]
      SBR --> SBL[SBL]
      SBL --> SL[SL]
      SL --> SW[SW]
      SW --> FADER[FADER]
      FADER --> FL
      SBR -.-> SBR_note[※]
      SBL -.-> SBL_note[※]
  
```

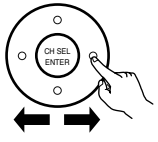
2  Adjust the level of the selected speaker.
(Remote control unit)

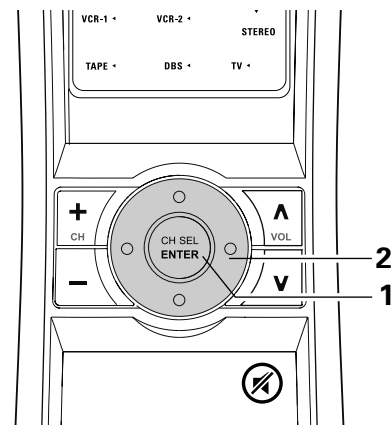

※ When the surround back speaker setting is set to "1spkr" for "Speaker Configuration", this is set to "SB".

NOTES:

- The adjustment range for the different channels is +12 dB to -12 dB.
- The sound from the subwoofer can be cut by lowering the SW (subwoofer) setting one step from -12 dB (setting it to "OFF").

Fader function

- This function makes it possible to lower the volume of the front channels (FL, C and FR) or the rear channels (SL, SR, SBL and SBR) together. Use it for example to adjust the balance of the sound from each position when multi-channel music sources are played.

1 Select "FADER".



(Remote control unit)



(Main unit)

The channel switches in the order shown below each time this button is pressed.

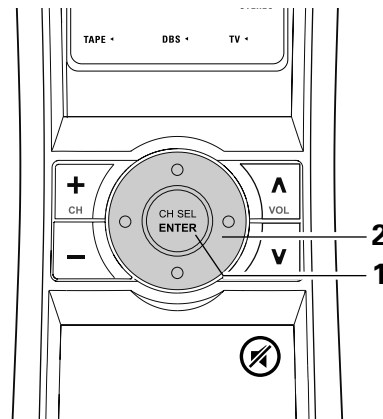
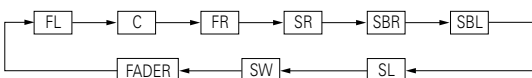

2 Press the ◀ button to reduce the volume of the front channels, the ▶ button to reduce the volume of the rear channels.

※ The fader function does not affect the SW channel.

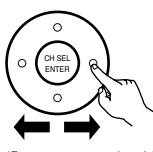

(Remote control unit)



(Main unit)

※ The channel whose channel level is adjusted lowest can be faded to -12 dB using the fader function.

※ If the channel levels are adjusted separately after adjusting the fader, the fader adjustment values are cleared, so adjust the fader again.

Fader		FRONT ◀ : ▶ REAR
FL	0.0dB	
C	0.0dB	
FR	0.0dB	
SR	0.0dB	
SBR	0.0dB	
SL	0.0dB	
SBL	0.0dB	

This is only displayed when setting the fader control.

```

    *Fader Vol.
    Front ◀ : ▶ Rear
  
```

Dolby Pro Logic IIx (Pro Logic II) mode

To play in the PL IIx mode, set "Sp.Back" at the Speaker Configuration setting to "1Spkr" or "2Spkr".

To play in the PL IIx mode, set "Surround Back" at the Power Amp Assign setting.

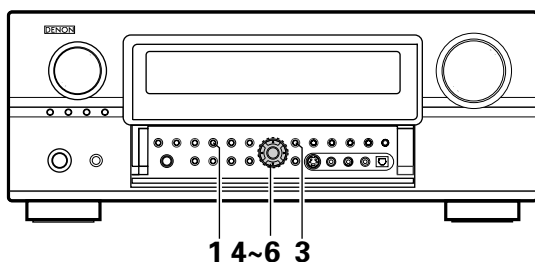

1 Select the Dolby Pro Logic IIx mode.



(Remote control unit)



(Remote control unit)



(Main unit)

2 Play a program source with the mark.

- For operating instructions, refer to the manuals of the respective components.

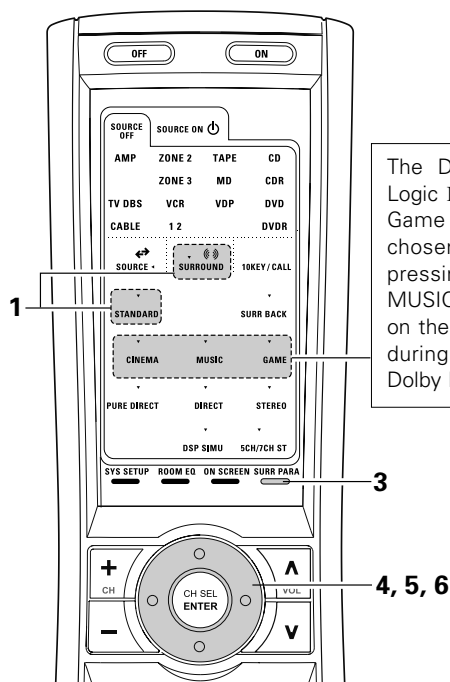

The Dolby Surround Pro Logic II Cinema, Music or Game mode can be chosen directly by pressing the CINEMA, MUSIC or GAME button on the remote control unit during playback in the Dolby Pro Logic IIx mode.

3 Set the surround parameter mode.

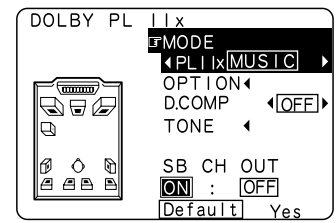
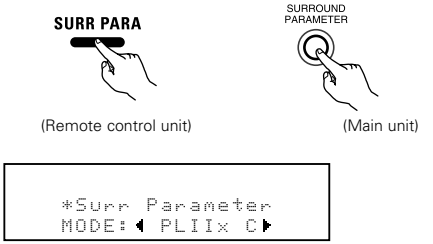

※ The on-screen display differs according to whether the operation is performed from the main unit or the remote control unit.

4 Select the play mode.

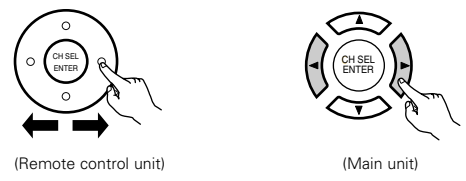

NOTE:

- The PLIIX mode is set when the "SB CH OUT" surround parameter is set to "ON", and the PLII mode is set when this parameter is set to "OFF".

- When the "SB CH OUT" parameter is set to "ON". (Set "SP.Back" at the system set up to "1spkr" or "2spkr").

Display

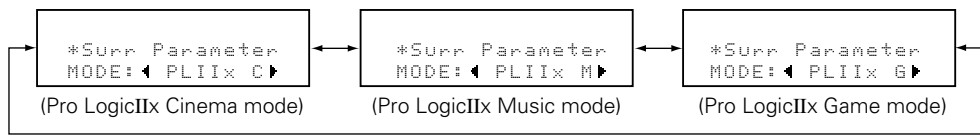

- When the "SB CH OUT" parameter is set to "OFF". (Set "SP.Back" at the system set up to "None").

Display

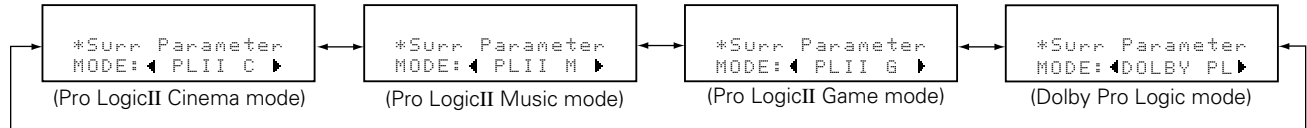

5 Select the parameter to change. (See "Surround parameters ①" for a description of each parameter.)

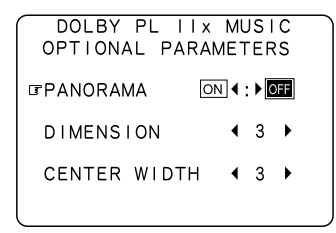
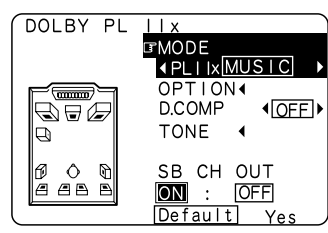
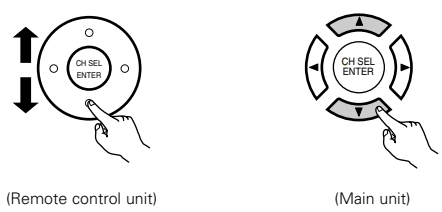

Ex : DOLBY PLIIX music mode screen.

※ When set with the on-screen display using the remote control unit while in the MUSIC mode, set the "☐" mark to "OPTION ◀" using the △ and ▽ cursor buttons, then press the ◀ cursor button. Press the ENTER button to return to the previous screen.

6 Set the various surround parameters.

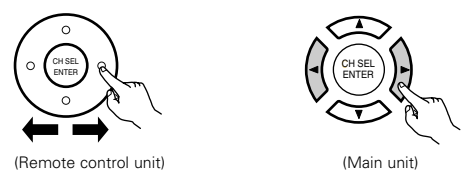

7 If the setting ends, press the "ENTER" or "SURROUND PARAMETER" button.

NOTE:

- There are four Dolby Surround Pro Logic modes (NORMAL, PHANTOM, WIDE and 3 STEREO). The AVR-3805 sets the mode automatically according to the types of speakers set during the system setup process (page 32).

Surround parameters ①

Pro Logic IIx and Pro Logic II Mode:

- The Cinema mode is for use with stereo television shows and all programs encoded in Dolby Surround.
 - The Music mode is recommended as the standard mode for auto sound music systems (no video), and is optional for A/V systems.
 - The Pro Logic mode offers the same robust surround processing as original Pro Logic in case the source contents is not of optimum quality.
 - The Game mode for playing games. The game mode can only be used with 2-channel audio sources.
- Select one of the modes ("Cinema", "Music", "Pro Logic" or "Game").

Panorama Control:

This mode extends the front stereo image to include the surround speakers for an exciting "wraparound" effect with side wall imaging. Select "OFF" or "ON".

Dimension Control:

This control gradually adjust the soundfield either towards the front or towards the rear.

The control can be set in 7 steps from 0 to 6.

Center Width Control:

This control adjust the center image so it may be heard only from the center speaker; only from the left/right speakers as a phantom image; or from all three front speakers to varying degrees.

The control can be set in 8 steps from 0 to 7.

DTS NEO:6 mode

- Surround playback can be performed for the analog input and PCM digital input 2-channel signals.

- 1 Select the DTS NEO:6 mode.



- The mode switches as shown below each time the button is pressed.

DOLBY PLIIx → DTS NEO:6

- 2 Play a program source.

- 3 Set the surround parameter mode.

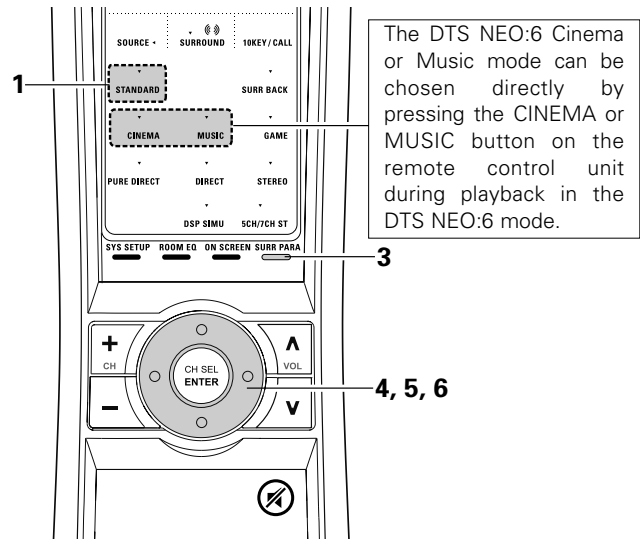
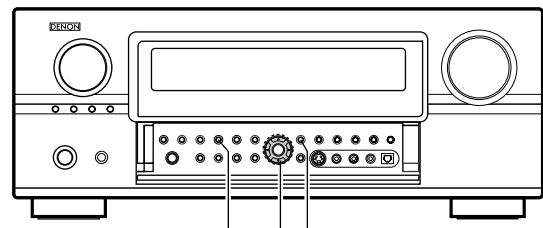
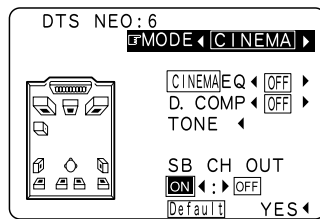
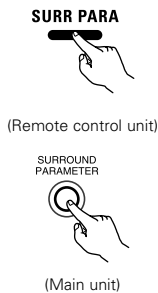

- 4 Select the play mode.

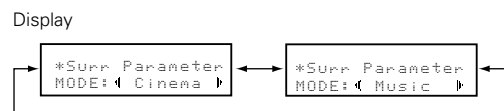
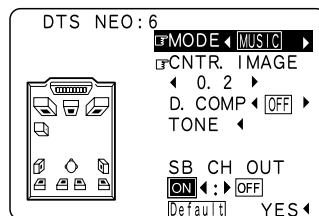
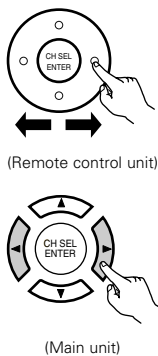

5 Select the various parameters.

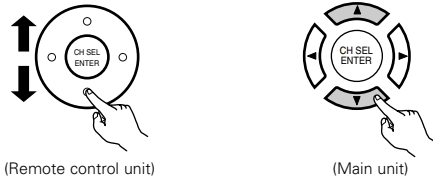

6 Adjust the parameter settings.

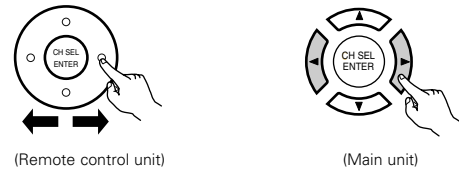

NOTE:

- When "Default" is selected and the ◀ cursor button is pressed, "MODE" and "TONE" are automatically reset to the default values and "CINEMA EQ" is set to "OFF".

Surround parameters ②

DTS NEO:6 Mode:

• Cinema

This mode is optimum for playing movies. Decoding is performed with emphasis on separation performance to achieve the same atmosphere with 2-channel sources as with 6.1-channel sources. This mode is effective for playing sources recorded in conventional surround formats as well, because the in-phase component is assigned mainly to the center channel (C) and the reversed phase component to the surround (SL, SR and SB channels).

• Music

This mode is suited mainly for playing music. The front channel (FL and FR) signals bypass the decoder and are played directly so there is no loss of sound quality, and the effect of the surround signals output from the center (C) and surround (SL, SR and SB) channels add a natural sense of expansion to the sound field.

CENTER IMAGE (0.0 to 1.0: default 0.3):

The center image parameter for adjusting the expansion of the center channel in the DTS NEO:6 MUSIC mode has been added.

Dolby Digital mode (only with digital input) and DTS Surround mode (only with digital input)

1 Select the input source.

Playback with a digital input

- Select an input source set to digital (COAXIAL/OPTICAL) (see page 39).

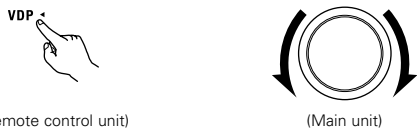

- Set the input mode to "AUTO" or "DTS".

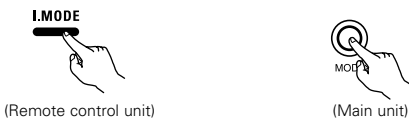

2 Select the STANDARD (Dolby/DTS Surround) mode.

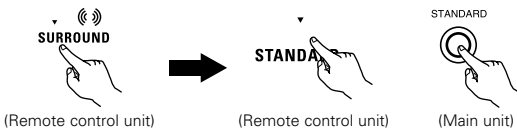

3 Play a program source with the , mark.

DIGITAL — Light

- The Dolby Digital indicator lights when playing Dolby Digital sources.

— Light

- The DTS indicator lights when playing DTS sources.

— Light

- Press the SURROUND Back button. Lights when the Surround Back CH is on.

— Light

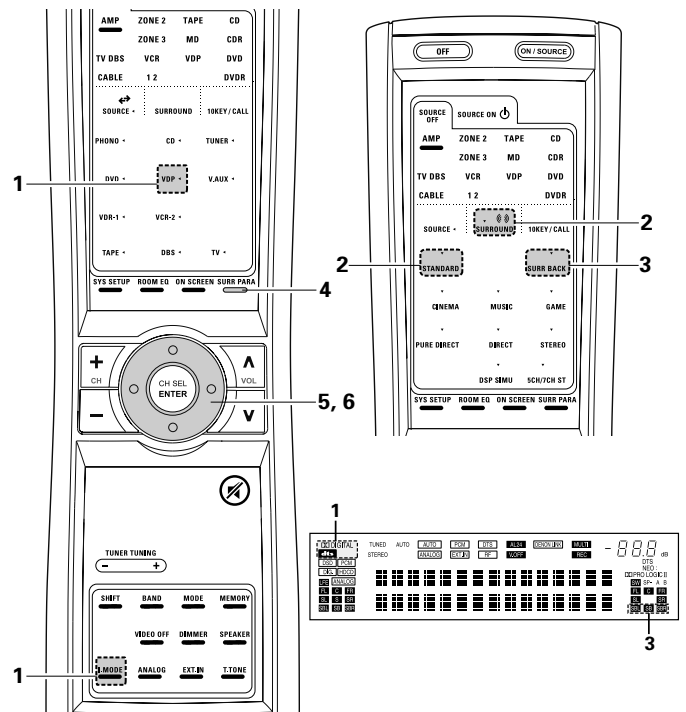
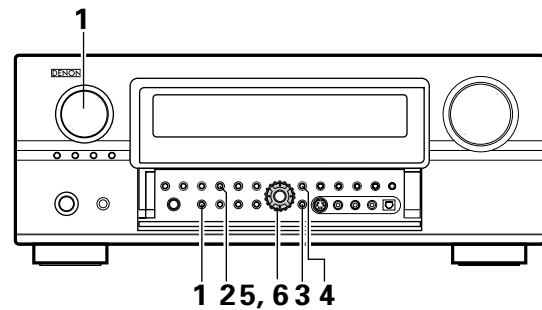

4

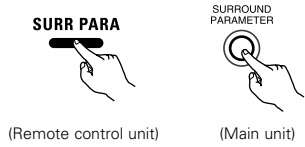

(Remote control unit) (Main unit)

Display the surround parameter menu.

NOTE: The display on the screen differs depending on whether you are performing the operation from the main unit or the remote control unit.

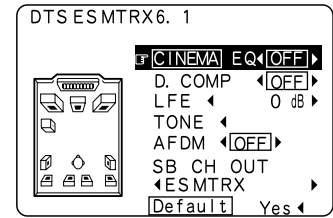
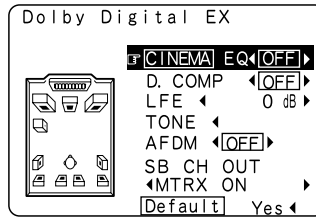

5

Select the various parameters.

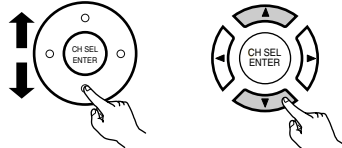

(Remote control unit) (Main unit)

6

Adjust the parameter settings.

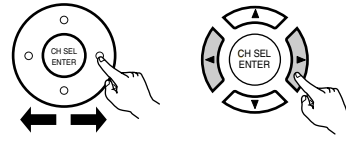

(Remote control unit) (Main unit)

■ Dialogue Normalization

The dialogue normalization function is activated automatically when playing Dolby Digital program sources. Dialogue normalization is a basic function of Dolby Digital which automatically normalizes the dialog level (standard level) of the signals which are recorded at different levels for different program sources, such as DVD, DTV and other future formats that will use Dolby Digital. These contents can be verified with the STATUS and ON SCREEN button.

Display

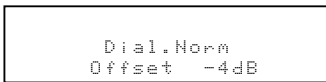

The number indicates the normalization level when the currently playing program is normalized to the standard level.

NOTE:

- When "Default" is selected and the ◀ cursor button is pressed, "CINEMA EQ." and "D.COMP." are automatically turned off, "LFE" is reset, and the tone is set to the default value.

Checking the input signal

The input signal can be checked by pressing the remote control unit's ON SCREEN button. (See page 41.)

ON SCREEN



(Remote control unit)

- SIGNAL: Displays the type of signal (DTS, DOLBY DIGITAL, PCM, etc.).
- fs: Displays the input signal's sampling frequency.
- FORMAT: Displays the input signal's number of channels.
"Number of front channels/Number of surround channels/LFE on/off"
"SURROUND" is displayed for 2-channel signal sources recorded in Dolby Surround.
- OFFSET: Displays the dialog normalization offset value.
- FLAG: Displays the special identification signal recorded in the input signal. (See page 51.)
"MATRIX" is displayed when matrix processing is conducted on the surround back channel, "DISCRETE" is displayed when discrete processing is conducted.
Not displayed when no identification signal is recorded.

In addition, screen information is displayed in the following order when the ON SCREEN button is pressed repeatedly:

- OSD-1 Input signal
- OSD-2 Input/output
- OSD-3 Auto surround mode
- OSD-3 ~ 9 Tuner preset stations

NOTE:

- OSD-3: This is displayed when the auto surround mode is set to "ON" and the input mode is set to "Auto". It is not displayed when the input mode is set to "Analog" or "EXT. IN".

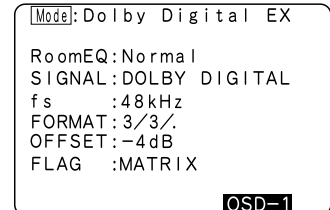

OSD-1

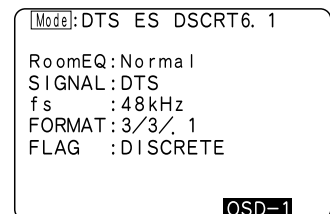

OSD-1

Surround parameters ②

CINEMA EQ. (Cinema Equalizer):

The Cinema EQ function gently decreases the level of the extreme high frequencies, compensating for overly-bright sounding motion picture soundtracks. Select this function if the sound from the front speakers is too bright.

This function only works in the Dolby Pro Logic IIX, Dolby Digital, DTS Surround, DTS NEO:6 and WIDE SCREEN modes. (The same contents are set for all operating modes.)

D.COMP. (Dynamic Range Compression):

Motion picture soundtracks have tremendous dynamic range (the contrast between very soft and very loud sounds). For listening late at night, or whenever the maximum sound level is lower than usual, the Dynamic Range Compression allows you to hear all of the sounds in the soundtrack (but with reduced dynamic range). (This only works when playing program sources recorded in Dolby Digital or DTS.) Select one of the four parameters ("OFF", "LOW", "MID" (middle) or "HI" (high)). Set to OFF for normal listening.

LFE (Low Frequency Effect):

This sets the level of the LFE (Low Frequency Effect) sounds included in the source when playing program sources recorded in Dolby Digital or DTS. If the sound produced from the subwoofer sounds distorted due to the LFE signals when playing Dolby Digital or DTS sources when the peak limiter is turned off with the subwoofer peak limit level setting (system setup menu), adjust the level as necessary.

Program source and adjustment range:

1. Dolby Digital: -10 dB to 0 dB
2. DTS Surround: -10 dB to 0 dB

※ When DTS encoded movie software is played, it is recommended that the LFE LEVEL be set to 0 dB for correct DTS playback.

※ When DTS encoded music software is played, it is recommended that the LFE LEVEL be set to -10 dB for correct DTS playback.

STONE:

This adjusts the tone control. This can be set individually for the separate shroud mode other than Pure direct and direct mode.

AFDM (Auto Flag Detect Mode):

ON.....This function only works with software on which a special identification signal is recorded. This software is scheduled to go on sale in the future.

This is a function for automatically playing in the 6.1-channel mode using the surround back speakers if the software is recorded in DTS-ES or in the normal 5.1-channel mode without using the surround back speakers when the software is not recorded in DTS-ES.

OFFSet the "OFF" mode to perform 6.1-channel playback with conventional 5.1-channel sources or sources on which the identification signal described below is not recorded.

SB CH OUT:

(1) (Multi channel source)

"OFF"Playback is conducted without using the surround back speaker.

"NON MTRX"The same signals those of the surround channels are output from the surround back channels.

"MTRX ON"Surround back channel is reproduced using digital matrix processing.

"ES MTRX"When playing DTS signals, the surround back signals undergo digital matrix processing for playback.

"ES DSCRT"When a signal identifying the source as a discrete 6.1-channel source is included in the DTS signals, the surround back signals included in the source are played.

"PL IIX Cinema"Processing is performed with the Cinema mode of the PL IIX decoder and the Surround Back channel is reproduced.

"PL IIX Music"Processing is performed with the Music mode of the PL IIX decoder and the Surround Back channel is reproduced.

(2) (2ch source)

"OFF"Playback is conducted without using the surround back speaker.

"ON"Playback is conducted using the surround back speaker.

NOTE: This operation can be performed directly using the "SURROUND BACK" button on the main unit's panel.

Adjusting the Audio Delay

When watching a DVD or other video source, the picture on the monitor may seem delayed with respect to the sound. In this case, adjust the audio delay to delay the sound and synchronize it with the picture. The audio delay setting is stored separately for each input source.

- ① Select the input source.

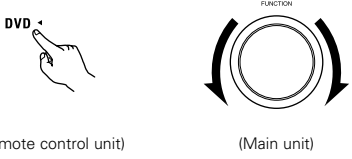

(Remote control unit) (Main unit)
- ② Set the input mode to "AUTO".



(Remote control unit) (Main unit)
- ③ Select the Dolby/DTS Surround.

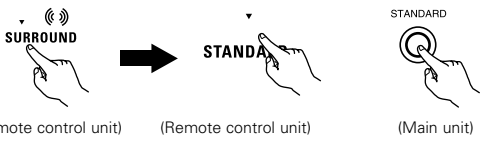

(Remote control unit) (Remote control unit) (Main unit)
- ④ Play a program source (DVD, etc.).

- 2 Press the SYSTEM SETUP button and display the System Setup Menu.

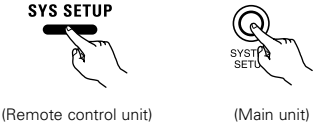

(Remote control unit) (Main unit)

System Setup Menu

 - 1. Auto Setup/Room EQ
 - 2. Speaker Setup
 - 3. Input Setup
 - 4. Advanced Playback
 - 5. Option Setup

Exit

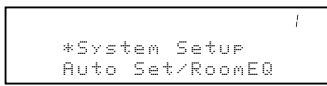
- 3 Select "Advanced Playback" at the System Setup Menu.

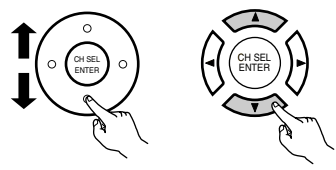

(Remote control unit) (Main unit)

4 Press the ENTER button and display the Advanced Playback Menu.

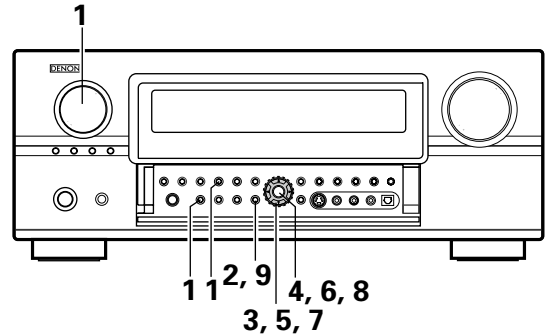
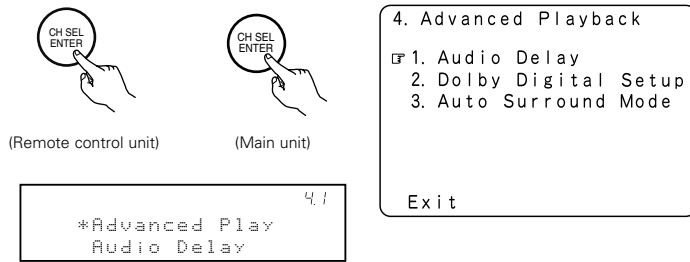

5 Select "Audio Delay" at the Advanced Playback Menu.

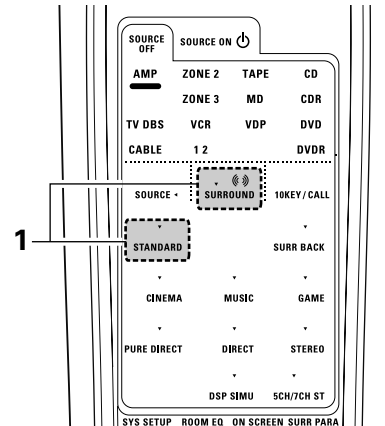
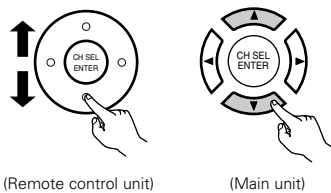

6 Switch to the Audio Delay adjustment screen.

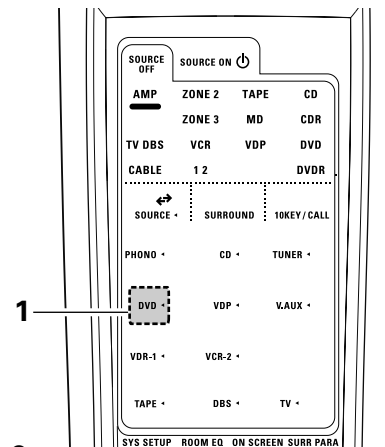
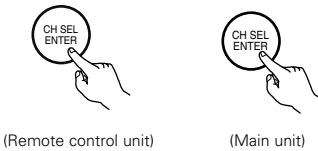

7 Set the delay time. (0 ms ~ 200 ms)

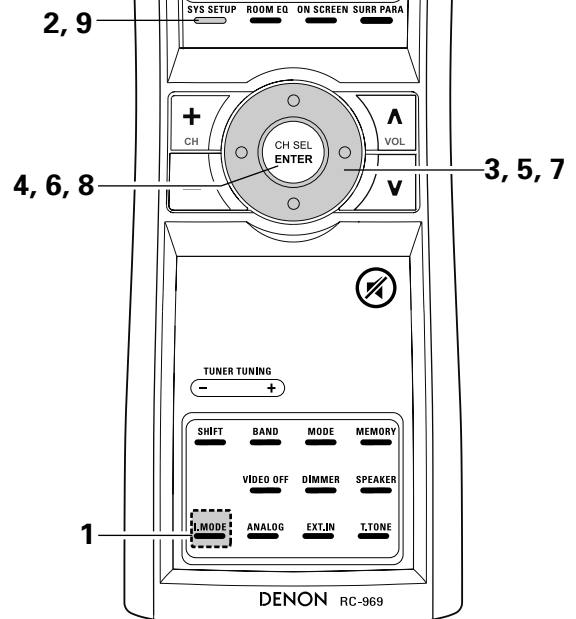
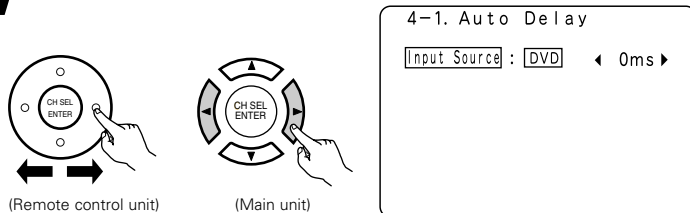

With a movie source, for example, adjust so that the movement of the actors' lips is synchronized with the sound.

8 Enter the setting. The Advanced Playback Menu reappears.

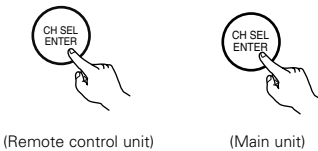

9 Press the SYSTEM SETUP button to complete the setting.

NOTE:
The audio delay setting does not apply when playing in the EXT. IN mode or in the analog input direct mode or stereo mode (TONE DEFEAT "ON").

12 DSP SURROUND SIMULATION

- The AVR-3805 is equipped with a high performance DSP (Digital Signal Processor) which uses digital signal processing to synthetically recreate the sound field. One of ten preset surround modes can be selected according to the program source and the parameters can be adjusted according to the conditions in the listening room to achieve a more realistic, powerful sound. These surround modes can also be used for program sources not recorded in Dolby Surround Pro Logic, Dolby Digital or DTS.

Surround modes and their features

1	WIDE SCREEN	Select this to achieve an atmosphere like that of a movie theater with a large screen. In this mode, all signal sources are played in the 7.1-channel mode, including Dolby Pro Logic and Dolby Digital 5.1-channel sources. Effects simulating the multi surround speakers of movie theaters are added to the surround channels.
2	SUPER STADIUM	Select this when watching baseball or soccer programs to achieve a sound as if you were actually at the stadium. This mode provides the longest reverberation signals.
3	ROCK ARENA	Use this mode to achieve the feeling of a live concert in an arena with reflected sounds coming from all directions.
4	JAZZ CLUB	This mode creates the sound field of a live house with a low ceiling and hard walls. This mode gives jazz a very vivid realism.
5	CLASSIC CONCERT	Select this for the sound of a concert hall rich in reverberations.
6	MONO MOVIE (NOTE 1)	Select this when watching monaural movies for a greater sense of expansion.
7	VIDEO GAME	Use this to enjoy video game sources.
8	MATRIX	Select this to emphasize the sense of expansion for music sources recorded in stereo. Signals consisting of the difference component of the input signals (the component that provides the sense of expansion) processed for delay are output from the surround channel.
9	VIRTUAL	Select this mode to enjoy a virtual sound field, produced from the front 2-channel speakers.
10	5CH/7CH STEREO	The front left channel signals are output to the surround and surround back signal left channels, the front right channel signals are output to the surround and surround back signal right channels, and the in-phase component of the left and right channels is output to the center channel. Use this mode to enjoy stereo sound.

- ※ Depending on the program source being played, the effect may not be very noticeable.
In this case, try other surround modes, without worrying about their names, to create a sound field suited to your tastes.

NOTE 1: When playing sources recorded in monaural, the sound will be one-sided if signals are only input to one channel (left or right), so input signals to both channels. If you have a source component with only one audio output (monophonic camcorder, etc.) obtain a "Y" adaptor cable to split the mono output to two outputs, and connect to the L and R inputs.

Personal Memory Plus

This set is equipped with a personal memorize function that automatically memorizes the surround modes and input modes selected for the input different sources. When the input source is switched, the modes set for that source last time it was used are automatically recalled.

- ※ The surround parameters, tone control settings and playback level balance for the different output channels are memorized for each surround mode.

DSP surround simulation

1 Select the surround mode for each input channel.

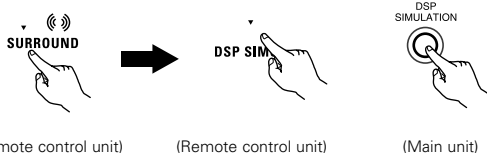

The surround mode switches in the following order each time the DSP SIMULATION button is pressed:

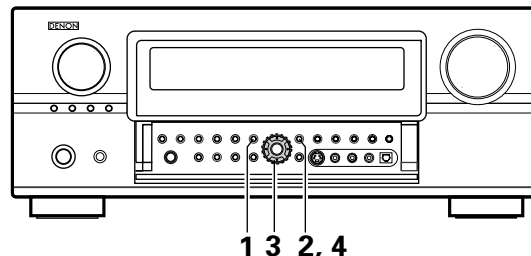
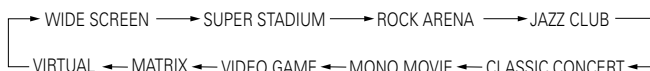

2 Press the surround parameter button. Display the surround parameter screen.

※ The screen for the selected surround mode appears.

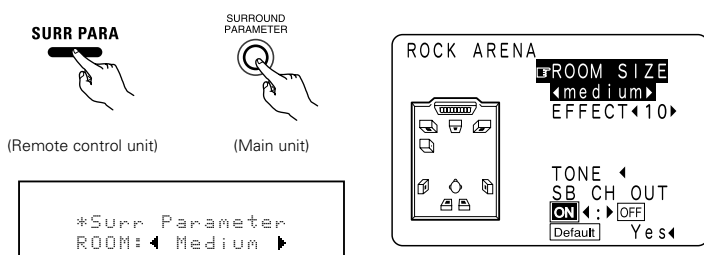

3 Set the parameters.

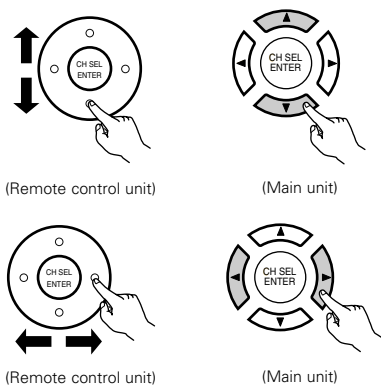

4 If the setting mode ends, press the surround parameter button again.

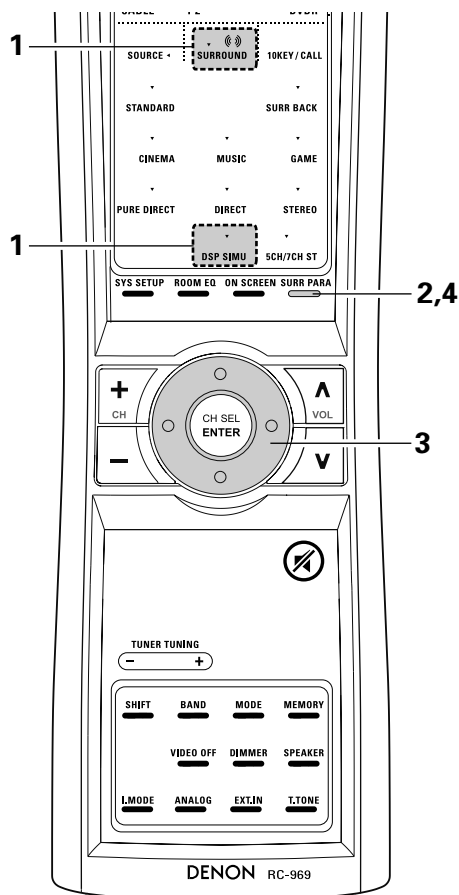
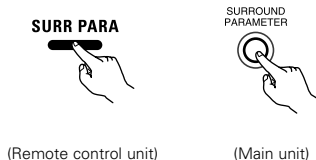

NOTES:

- The surround speaker setting can also be changed with the SPEAKER button on the remote control unit.
- When "Default" is selected and the ◀ cursor button is pressed, "CINEMA EQ." and "D.COMP." are automatically turned off, "ROOM SIZE" is set to "medium", "EFFECT LEVEL" to "10", "DELAY TIME" to "30ms" and "LFE" to "0dB".
- The "ROOM SIZE" expresses the expansion effect for the different surround modes in terms of the size of the sound field, not the actual size of the listening room.
- When playing PCM digital signals or analog signals in the DOLBY PRO LOGIC II, DOLBY PRO LOGIC IIx, DTS NEO:6 modes and the input signal switches to a digital signal encoded in Dolby Digital, the Dolby surround mode switches automatically. When the input signal switches to a DTS signal, the mode automatically switches to DTS surround.

Tone control setting

- Use the tone control setting to adjust the bass and treble as desired.
- Operate the tone control from the remote control unit.

1



(Remote control unit)

Press the surround parameter button.
Display the surround parameter screen.
※ The screen selected surround mode appears.
"TONE" cannot be selected in the Direct mode.

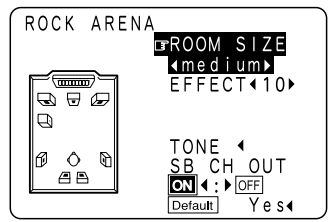
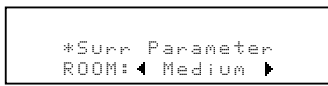

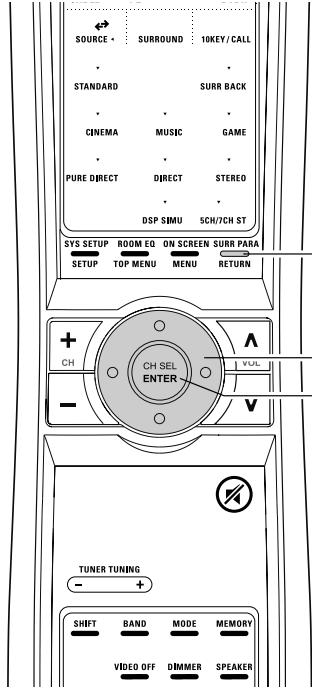
2

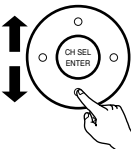

(Remote control unit)

Select "TONE".

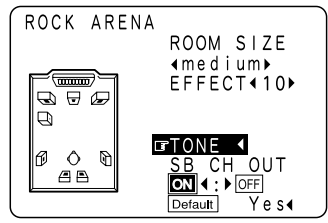
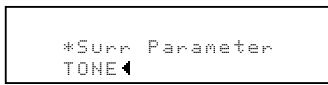



3

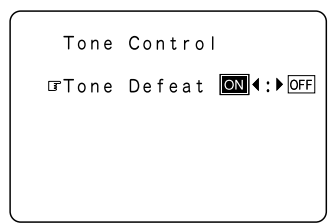
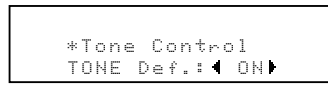

(Remote control unit)

Display the Tone Control screen.



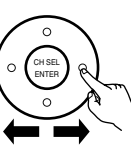

4

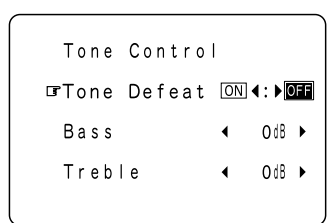

(Remote control unit)

Display the Tone Control screen.
Select Tone Defeat OFF.



5



(Remote control unit)

Select Bass or Treble.

6



(Remote control unit)

Enter the setting.
The surround parameter menu screen reappears.

7



(Remote control unit)

Set the level.

6



(Remote control unit)

Enter the setting.
The surround parameter menu screen reappears.

7



(Remote control unit)

If the setting ends, press the surround parameter button again.

- Operate the tone control from the main unit.

1 The tone switches as follows each time the TONE CONTROL button is pressed.



(Main unit)

BASS ← → TREBLE

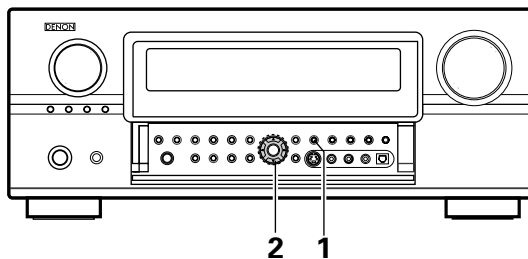

2



(Main unit)

Select with the name of the volume to be adjusted and adjust the level.

- To increase the bass or treble:
The bass or treble sound can be increased up to +6 dB in steps of 1 dB.
- To decrease the bass or treble:
The bass or treble sound can be decreased up to -6 dB in steps of 1 dB.

Surround parameters ③

ROOM SIZE:

This sets the size of the sound field.

There are five settings: "small", "med.s" (medium-small), "medium", "med.l" (medium-large) and "large". "small" recreates a small sound field, "large" a large sound field.

EFFECT LEVEL:

This sets the strength of the surround effect.

The level can be set in 15 steps from 1 to 15. Lower the level if the sound seems distorted.

DELAY TIME:

The delay time can be set within the range of 0 to 300 ms only in matrix mode.

TONE CONTROL:

This can be set individually for each surround mode except Pure Direct and Direct.

■ Surround modes and parameters

Mode	Signals and adjustability in the different modes										
	Channel output					When playing Dolby Digital signals	When playing DTS signals	When playing PCM signals	When playing ANALOG signals	When playing DSD signals	When playing DVD-AUDIO signals
	FRONT L/R	CENTER	SURROUND L/R	SURROUND BACK L/R	SUB-WOOFER						
DIRECT / PURE DIRECT	○	×	×	×	⊙	○	○	○	○	○	○
MULTI CH DIRECT	○	⊙	⊙	⊙	⊙	×	×	×	×	○	○
STEREO	○	×	×	×	⊙	○	○	○	○	○	○
EXTERNAL INPUT	○	⊙	⊙	⊙	⊙	×	×	×	○	×	×
MULTI CH IN	○	⊙	⊙	⊙	⊙	×	×	×	×	○	○
DOLBY PRO LOGIC II	○	⊙	⊙	⊙	⊙	○*	○*	○	○	○*	○*
DOLBY PRO LOGIC II x	○	⊙	⊙	⊙	⊙	○*	○	○	○	○*	○*
DTS NEO:6	○	⊙	⊙	⊙	⊙	○*	○*	○	○	○*	○*
DOLBY DIGITAL SURROUND	○	⊙	⊙	⊙	⊙	○	×	×	×	×	×
DTS SURROUND	○	⊙	⊙	⊙	⊙	×	○	×	×	×	×
5/7CH STEREO	○	⊙	⊙	⊙	⊙	○	○	○	○	○	○
WIDE SCREEN	○	⊙	⊙	⊙	⊙	○	○	○	○	○	○
SUPER STADIUM	○	⊙	⊙	⊙	⊙	○	○	○	○	○	○
ROCK ARENA	○	⊙	⊙	⊙	⊙	○	○	○	○	○	○
JAZZ CLUB	○	⊙	⊙	⊙	⊙	○	○	○	○	○	○
CLASSIC CONCERT	○	⊙	⊙	⊙	⊙	○	○	○	○	○	○
MONO MOVIE	○	⊙	⊙	⊙	⊙	○	○	○	○	○	○
VIDEO GAME	○	⊙	⊙	⊙	⊙	○	○	○	○	○	○
MATRIX	○	⊙	⊙	⊙	⊙	○	○	○	○	○	○
VIRTUAL	○	×	×	×	⊙	○	○	○	○	○	○

○ : Signal / Adjustable

×

⊙ : Turned on or off by speaker configuration setting

○ : Able

×

* : Only for 2 ch contents

Mode	Signals and adjustability in the different modes						
	Parameter (default values are shown in parentheses)						
	When playing Dolby Digital and DTS signals			SB CH OUT (MODE)	TONE CONTROL	CINEMA EQ.	MODE
	D. COMP	LFE	AFDM				
DIRECT / PURE DIRECT	○ (OFF)	○ (0dB)	×	×	×	×	×
MULTI CH DIRECT	×	○ (0dB)	×	○	×	×	×
STEREO	○ (OFF)	○ (0dB)	×	×	○ (0dB)	×	×
EXTERNAL INPUT	×	×	×	×	×	×	×
MULTI CH IN	×	○ (0dB)	×	○	○ (0dB)	×	×
PRO LOGIC II	○ (OFF)	○ (0dB)	○	○	○ (0dB)	○ (OFF)	○
DOLBY PRO LOGIC II x	○ (OFF)	○ (0dB)	○	○	○ (0dB)	○ (OFF)	○
DTS NEO:6	○ (OFF)	○ (0dB)	○	○	○ (0dB)	○ (OFF)	○
DOLBY DIGITAL SURROUND	○ (OFF)	○ (0dB)	○	○	○ (0dB)	○ (OFF)	×
DTS SURROUND	○ (OFF)	○ (0dB)	○	○	○ (0dB)	○ (OFF)	×
5/7CH STEREO	○ (OFF)	○ (0dB)	×	○	○ (0dB)	×	×
WIDE SCREEN	○ (OFF)	○ (0dB)	×	○	○ (0dB)	×	×
SUPER STADIUM	○ (OFF)	○ (0dB)	×	○	○ (Note1)	×	×
ROCK ARENA	○ (OFF)	○ (0dB)	×	○	○ (Note2)	×	×
JAZZ CLUB	○ (OFF)	○ (0dB)	×	○	○ (0dB)	×	×
CLASSIC CONCERT	○ (OFF)	○ (0dB)	×	○	○ (0dB)	×	×
MONO MOVIE	○ (OFF)	○ (0dB)	×	○	○ (0dB)	×	×
VIDEO GAME	○ (OFF)	○ (0dB)	×	○	○ (0dB)	×	×
MATRIX	○ (OFF)	○ (0dB)	×	○	○ (0dB)	×	×
VIRTUAL	○ (OFF)	○ (0dB)	×	×	○ (0dB)	×	×

○ : Able
 × : Unable

○ : Adjustable
 × : Not adjustable
 Note1 : BASS +6 dB, TREBLE 0 dB
 Note2 : BASS +6 dB, TREBLE 4 dB

Mode	Signals and adjustability in the different modes									
	SURROUND PARAMETER									
	ROOM SIZE	EFFECT ON/OFF	EFFECT LEVEL	DELAY TIME	SUBWOOFER ON/OFF	PRO LOGIC II / II x ONLY			NEO:6 MUSIC	EXT.IN
						PANORAMA	DIMENSION	CENTER WIDTH		
DIRECT / PURE DIRECT	×	×	×	×	○ (OFF)	×	×	×	×	×
MULTI CH DIRECT	×	×	×	×	×	×	×	×	×	×
STEREO	×	×	×	×	×	×	×	×	×	×
EXTERNAL INPUT	×	×	×	×	×	×	×	×	×	○
MULTI CH IN	×	×	×	×	×	×	×	×	×	×
PRO LOGIC II	×	×	×	×	×	○ (OFF)	○ (3)	○ (3)	×	×
DOLBY PRO LOGIC II x	×	×	×	×	×	○ (OFF)	○ (3)	○ (3)	×	×
DTS NEO:6	×	×	×	×	×	×	×	×	○ (0.3)	×
DOLBY DIGITAL SURROUND	×	×	×	×	×	×	×	×	×	×
DTS SURROUND	×	×	×	×	×	×	×	×	×	×
5/7CH STEREO	×	×	×	×	×	×	×	×	×	×
WIDE SCREEN	×	○ (ON)	○ (10)	×	×	×	×	×	×	×
SUPER STADIUM	○ (Medium)	×	○ (10)	×	×	×	×	×	×	×
ROCK ARENA	○ (Medium)	×	○ (10)	×	×	×	×	×	×	×
JAZZ CLUB	○ (Medium)	×	○ (10)	×	×	×	×	×	×	×
CLASSIC CONCERT	○ (Medium)	×	○ (10)	×	×	×	×	×	×	×
MONO MOVIE	○ (Medium)	×	○ (10)	×	×	×	×	×	×	×
VIDEO GAME	○ (Medium)	×	○ (10)	×	×	×	×	×	×	×
MATRIX	×	×	×	○ (30ms)	×	×	×	×	×	×
VIRTUAL	×	×	×	×	×	×	×	×	×	×

○ : Adjustable
 × : Not adjustable

13 LISTENING TO THE RADIO

- Check that the remote control unit is set to AMP or TUNER.

Auto tuning

- 1** Set the input function to "TUNER".



- 2** Watching the display, press the BAND button to select the desired band (AM or FM).

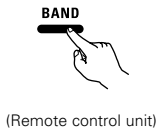

- 3** Press the MODE button to set the auto tuning mode.

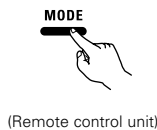

"Auto" appears on the display.

- 4** Press the TUNING + or – button.

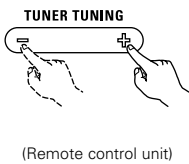

Automatic searching begins, then stops when a station is tuned in.

If tuning does not stop at the desired station, use the "Manual tuning" operation.

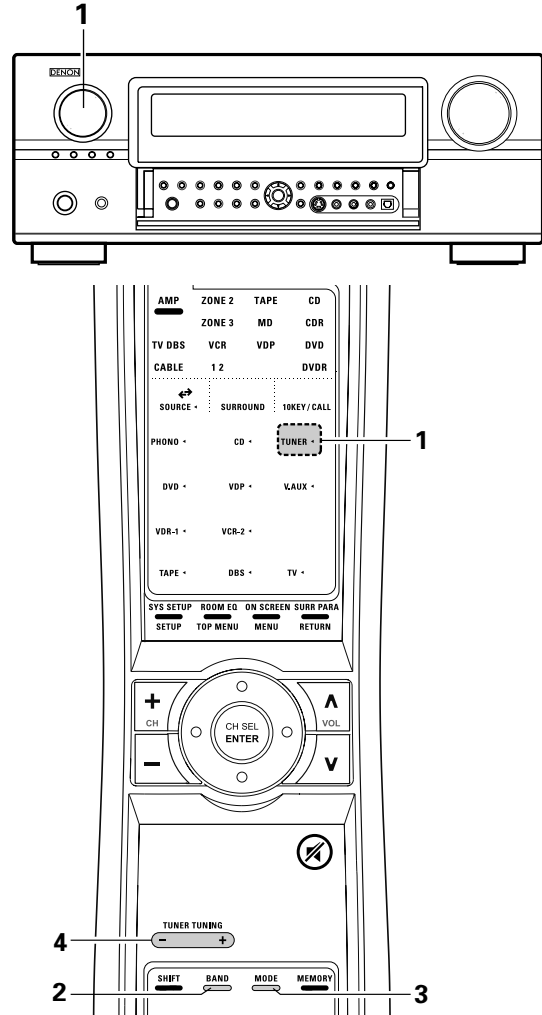

Manual tuning

- 1** Set the input function to "TUNER".



- 2** Watching the display, press the BAND button to select the desired band (AM or FM).

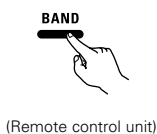

- 3** Press the MODE button to set the manual tuning mode. Check that the display's "AUTO" indicator turns off.

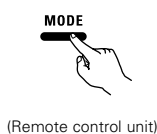

- 4** Press the TUNING + or – button to tune in the desired station. The frequency changes continuously when the button is held in.

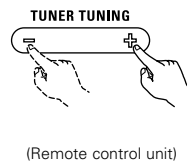

NOTES:

- When in the auto tuning mode on the FM band, the "STEREO" indicator lights on the display when a stereo broadcast is tuned in. At open frequencies, the noise is muted and the "TUNED" and "STEREO" indicators turn off.
- When the manual tuning mode is set, FM stereo broadcasts are received in monaural and the "STEREO" indicator turns off.

Preset memory

1 Use the “Auto tuning” or “Manual tuning” operation to tune in the station to be preset in the memory.

2 Press the MEMORY button.

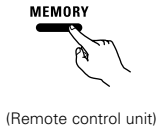

3 Press the SHIFT button and select the desired memory block (A to G).

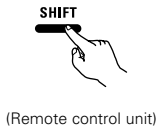

4 Press the CHANNEL + (UP) or - (DOWN) button to select the desired preset channel (1 to 8).

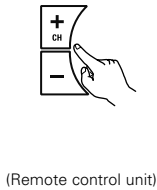

5 Press the MEMORY button again to store the station in the preset memory.

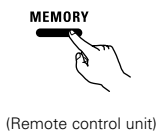

To preset other channels, repeat steps 2 to 5.
A total of 56 broadcast stations can be preset — 8 stations (channels 1 to 8) in each of blocks A to G.

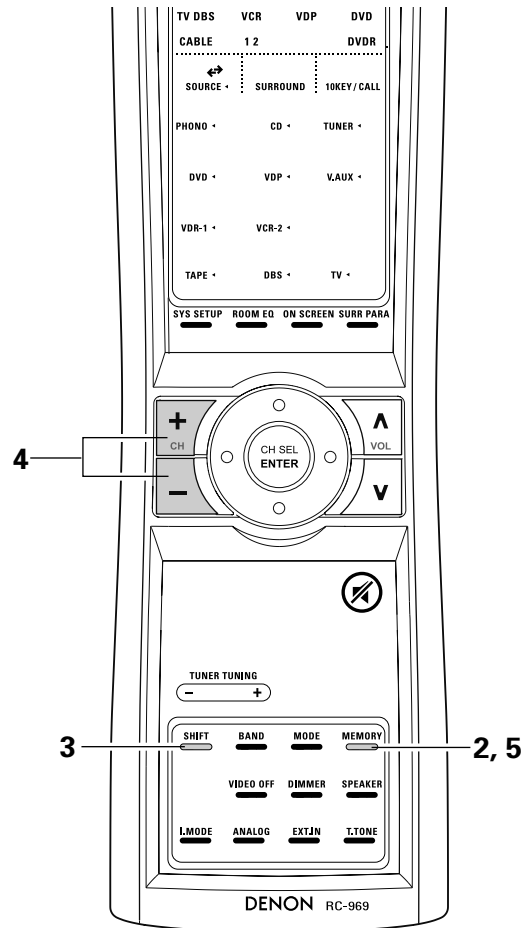

Checking the preset stations

- The preset (broadcast) stations can be checked on the on screen display.

1 Press the ON SCREEN button repeatedly until the “Tuner Preset Stations” screen appears on the OSD.

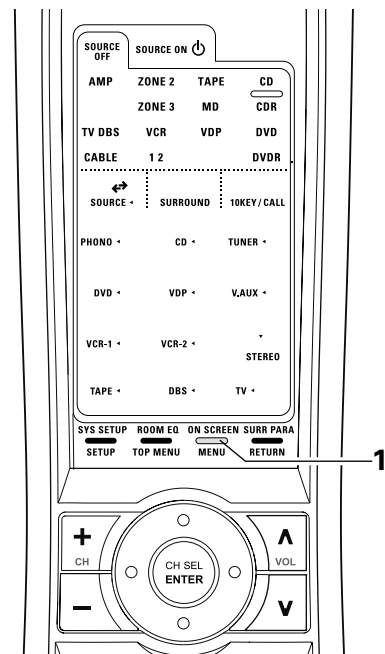
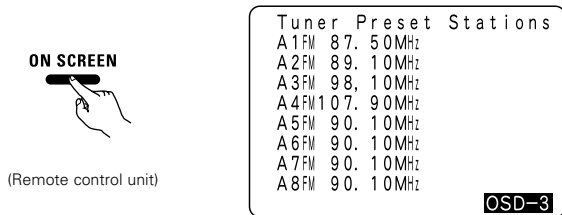

Recalling preset stations

- Recalling preset stations from the remote control unit.
- Preset stations can be chosen directly preset channel and channel range button. (see page 52)

1  Watching the display, press the SHIFT button to select the preset memory block.

(Remote control unit)

2  Watching the display, press the CHANNEL + (UP) or - (DOWN) button to select the desired preset channel.

(Remote control unit)

- Recalling preset stations from the main unit's panel.

1 Press the TUNING PRESET button.



(Main unit)

2 Turn the FUNCTION knob and select the desired preset channel.

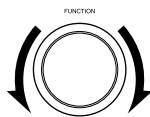

(Main unit)

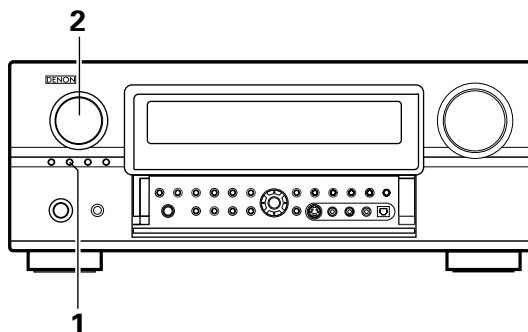
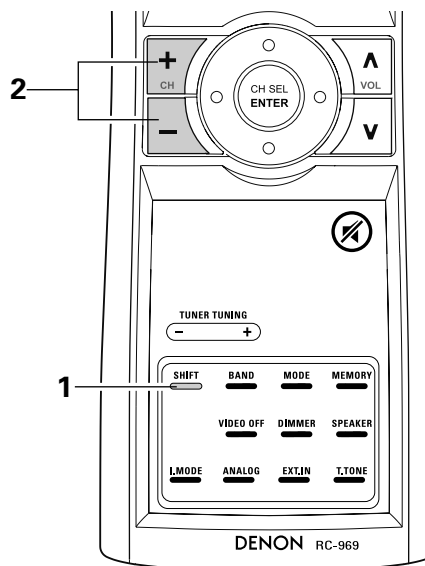

14 LAST FUNCTION MEMORY

- This unit is equipped with a last function memory which stores the input and output setting conditions as they were immediately before the power is switched off. This function eliminates the need to perform complicated resetting when the power is switched on.
- The unit is also equipped with a back-up memory. This function provides approximately one week of memory storage from when the main unit's power switch is off and with the power cord disconnected.

15 INITIALIZATION OF THE MICROPROCESSOR

When the indication of the display is not normal or when the operation of the unit does not show the reasonable result, the initialization of the microprocessor is required by the following procedure.

1 Switch off the unit using the main unit's power operation switch.

2 Hold the following PURE DIRECT button and DIRECT button, and turn the main unit's power operation switch on.

3 Check that the entire display is flashing with an interval of about 1 second, and release your fingers from the 2 buttons and the microprocessor will be initialized.

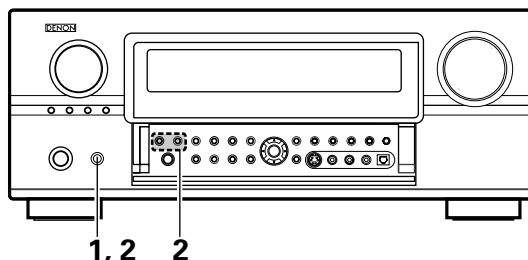

NOTES:

- If step 3 does not work, start over from step 1.
- If the microprocessor has been reset, all the settings are reset to the default values (the values set upon shipment from the factory).

16 TROUBLESHOOTING

If a problem should arise, first check the following table.

1. Are the connections correct ?

2. Have you operated the receiver according to the Operating Instructions ?

3. Are the speakers, turntable and other components operating properly ?

If this unit is not operating properly, check the items listed in the table below. Should the problem persist, there may be a malfunction. Disconnect the power immediately and contact your store of purchase.

	Symptom	Cause	Measures	Page
Common problems when listening to the CD's, Records, Tapes and FM broadcasts, etc.	DISPLAY not lit and sound not produced when power switch set to on.	<ul style="list-style-type: none"> Power cord not plugged in securely. 	<ul style="list-style-type: none"> Check the insertion of the power cord plug. Turn the power on with the remote control unit after turning the POWER switch on. 	7 62
	DISPLAY lit but sound not produced.	<ul style="list-style-type: none"> Speaker cords not securely connected. Improper position of the audio function button. Volume control set to minimum. MUTING is on. Digital signals not input Digital input selected. 	<ul style="list-style-type: none"> Connect securely. Set to a suitable position. Turn volume up to suitable level. Switch off MUTING. Input digital signals or select input jacks to which digital signals are being input. 	15 63 64 67 63
	DISPLAY not lit and power indicator is flashing rapidly.	<ul style="list-style-type: none"> Speaker terminals are short-circuited. Block the ventilation holes of the set. The unit is operating at continuous high power conditions and/or inadequate ventilation. 	<ul style="list-style-type: none"> Switch power off, connect speakers properly, then switch power back on. Turn off the set's power, then ventilate it well to cool it down. Once the set is cooled down, turn the power back on. Turn off the set's power, then ventilate it well to cool it down. Once the set is cooled down, turn the power back on. 	15 4, 16 4, 16
	Sound produced only from one channel.	<ul style="list-style-type: none"> Incomplete connection of speaker cords. Incomplete connection of input/output cords. 	<ul style="list-style-type: none"> Connect securely. Connect securely. 	15 7 ~ 16
	Positions of instruments reversed during stereo playback.	<ul style="list-style-type: none"> Reverse connections of left and right speakers or left and right input/output cords. 	<ul style="list-style-type: none"> Check left and right connections. 	13
	The on screen display is not displayed.	<ul style="list-style-type: none"> "On screen display" is set to off on the system setup menu screen. 	<ul style="list-style-type: none"> Set "on screen display" on the system setup menu screen to on. 	49
When playing Records	Humming noise produced when Record is playing.	<ul style="list-style-type: none"> Ground wire of turntable not connected properly. Incomplete PHONO jack connection. TV or radio transmission antenna nearby. 	<ul style="list-style-type: none"> Connect securely. Connect securely. Contact your store of purchase. 	7 7 —
	Howling noise produced when volume is high.	<ul style="list-style-type: none"> Turntable and speaker systems too close together. Floor is unstable and vibrates easily. 	<ul style="list-style-type: none"> Separate as much as possible. Use cushions to absorb speaker vibrations transmitted by floor. If turntable is not equipped with insulators, use audio insulators (commonly available). 	— —
	Sound is distorted.	<ul style="list-style-type: none"> Stylus pressure too weak. Dust or dirt on stylus. Cartridge defective. 	<ul style="list-style-type: none"> Apply proper stylus pressure. Check stylus. Replace cartridge. 	— — —
	Volume is weak.	<ul style="list-style-type: none"> MC cartridge being used. 	<ul style="list-style-type: none"> Replace with MM cartridge or use a head amplifier or step-up transformer. 	7
Remote control unit	This unit does not operate properly when remote control unit is used.	<ul style="list-style-type: none"> Batteries dead. Remote control unit too far from this unit. Obstacle between this unit and remote control unit. 	<ul style="list-style-type: none"> Replace with new batteries. Move closer. Remove obstacle. 	50 50 50
		<ul style="list-style-type: none"> Different button is being pressed. ⊕ and ⊖ ends of battery inserted in reverse. 	<ul style="list-style-type: none"> Press the proper button. Insert batteries properly. 	— 50

17 ADDITIONAL INFORMATION

Optimum surround sound for different sources

There are currently various types of multi-channel signals (signals or formats with more than two channels).

■ Types of multi-channel signals

Dolby Digital, Dolby Pro Logic, DTS, high definition 3-1 signals (Japan MUSE Hi-Vision audio), DVD-Audio, SACD (Super Audio CD), MPEG multi-channel audio, etc.

“Source” here does not refer to the type of signal (format) but the recorded content. Sources can be divided into two major categories.

■ Types of sources

• Movie audio

Signals created to be played in movie theaters. In general sound is recorded to be played in movie theaters equipped with multiple surround speakers, regardless of the format (Dolby Digital, DTS, etc.).

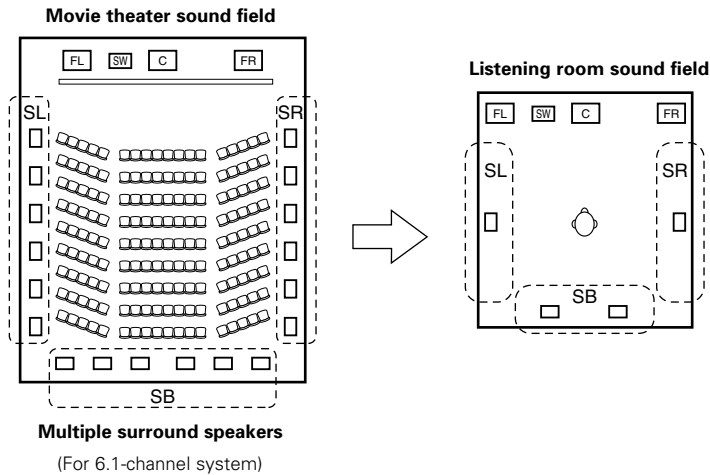

In this case it is important to achieve the same sense of expansion as in a movie theater with the surround channels. To do so, in some cases the number of surround speakers is increased (to four or eight) or speakers with bipolar or dipolar properties are used.

(SL: Surround L channel
SR: Surround R channel
SB: Surround back channel)

- **Other types of audio** These signals are designed to recreate a 360° sound field using three to five speakers.

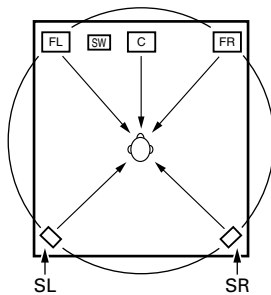

In this case the speakers should surround the listener from all sides to create a uniform sound field from 360°. Ideally the surround speakers should function as “point” sound sources in the same way as the front speakers.

These two types of sources thus have different properties, and different speaker settings, particularly for the surround speakers, are required in order to achieve the ideal sound.

The AVR-3805 is equipped the function of surround speakers selection that makes it possible to change the settings according to the combination of surround speakers being used and the surrounding environment in order to achieve the ideal surround sound for all sources. This means that you can connect a pair of bipolar or dipolar surround speakers (mounted on either side of the prime listening position), as well as a separate pair of direct radiating (monopolar) speakers placed at the rear corners of the listening room.

Surround back speakers

A 6.1-channel system is a conventional 5.1-channel system to which the “surround back” (SB) channel has been added. This makes it easy to achieve sound positioned directly behind the listener, something that was previously difficult with sources designed for conventional multi surround speakers. In addition, the acoustic image extending between the sides and the rear is narrowed, thus greatly improving the expression of the surround signals for sounds moving from the sides to the back and from the front to the point directly behind the listening position.

Change of positioning and acoustic image with 5.1-channel systems

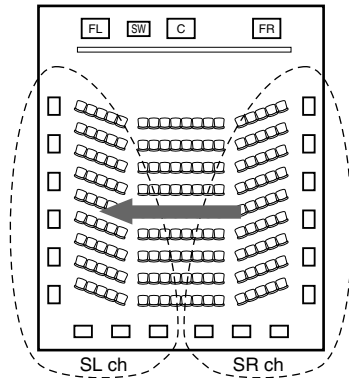

Movement of acoustic image from SR to SL

Change of positioning and acoustic image with 6.1-channel systems

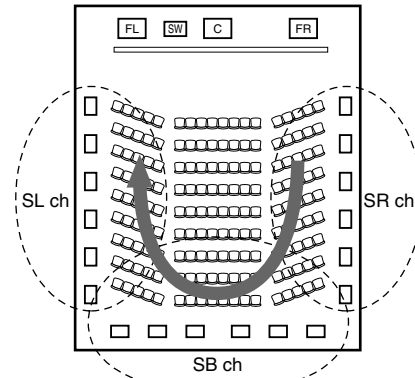

Movement of acoustic image from SR to SB to SL

With this set, speaker(s) for 1 or 2 channels are required to achieve a 6.1-channel system (DTS-ES, etc.). Adding these speakers, however, increases the surround effect not only with sources recorded in 6.1 channels but also with conventional 2- to 5.1-channel sources. The WIDE SCREEN mode is a mode for achieving surround sound with up to 7.1 channels using surround back speakers, for sources recorded in conventional Dolby Surround as well as Dolby Digital 5.1-channel and DTS Surround 5.1-channel sources. Furthermore, all the Denon original surround modes (see page 62) are compatible with 7.1-channel playback, so you can enjoy 7.1-channel sound with any signal source.

■ Number of surround back speakers

Though the surround back channel only consists of 1 channel of playback signals for 6.1-channel sources (DTS-ES, etc.), we recommend using two speakers. When using speakers with dipolar characteristics in particular, it is essential to use two speakers.

Using two speakers results in a smoother blend with the sound of the surround channels and better sound positioning of the surround back channel when listening from a position other than the center.

■ Placement of the surround left and right channels when using surround back speakers

Using surround back speakers greatly improves the positioning of the sound at the rear. Because of this, the surround left and right channels play an important role in achieving a smooth transition of the acoustic image from the front to the back. As shown on the diagram above, in a movie theater the surround signals are also produced from diagonally in front of the listeners, creating an acoustic image as if the sound were floating in space.

To achieve these effects, we recommend placing the speakers for the surround left and right channels slightly more towards the front than with conventional surround systems. Doing so sometimes increases the surround effect when playing conventional 5.1-channel sources in the 6.1 surround or DTS-ES Matrix 6.1 mode. Check the surround effects of the various modes before selecting the surround mode.

Speaker setting examples

Here we describe a number of speaker settings for different purposes. Use these examples as guides to set up your system according to the type of speakers used and the main usage purpose.

1. DTS-ES compatible system (using surround back speakers)

(1) Basic setting for primarily watching movies

This is recommended when mainly playing movies and using regular single way or 2-way speakers for the surround speakers.

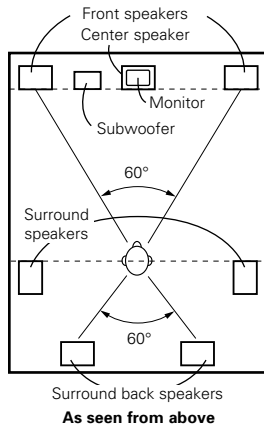

- Set the front speakers with their front surfaces as flush with the TV or monitor screen as possible. Set the center speaker between the front left and right speakers and no further from the listening position than the front speakers.
- Consult the owner's manual for your subwoofer for advice on placing the subwoofer within the listening room.
- If the surround speakers are direct-radiating (monopolar) then place them slightly behind and at an angle to the listening position and parallel to the walls at a position 60 to 90 centimeters (2 to 3 feet) above ear level at the prime listening position.
- When using two surround back speakers, place them at the back facing the front at a narrower distance than the front left and right speakers. When using one surround back speaker, place it at the rear center facing the front at a slightly higher position (0 to 20 cm) than the surround speakers.
- We recommend installing the surround back speaker(s) at a slightly downward facing angle. This effectively prevents the surround back channel signals from reflecting off the monitor or screen at the front center, resulting in interference and making the sense of movement from the front to the back less sharp.
- Connect the surround speakers to the surround speaker A jacks on the AVR-3805 and set all settings on the setup menu to "A". (This is the factory default setting. For details, see page 38.)

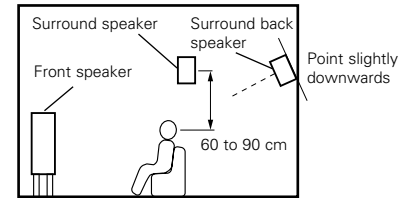

(2) Setting for primarily watching movies using diffusion type speakers for the surround speakers

For the greatest sense of surround sound envelopment, diffuse radiation speakers such as bipolar types, or dipolar types, provide a wider dispersion than is possible to obtain from a direct radiating speaker (monopolar). Place these speakers at either side of the prime listening position, mounted above ear level.

Path of the surround sound from the speakers to the listening position

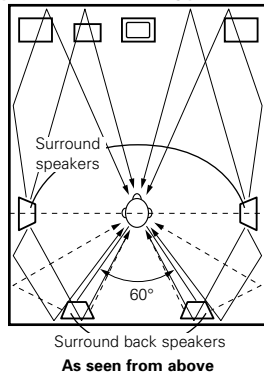

- Set the front speakers, center speaker and subwoofer in the same positions as in example (1).
- It is best to place the surround speakers directly at the side or slightly to the front of the viewing position, and 60 to 90 cm above the ears.
- Same as surround back speaker installation method (1). Using dipolar speakers for the surround back speakers as well is more effective.
- Connect the surround speakers to the surround speaker A jacks on the AVR-3805 and set all settings on the setup menu to "A". (This is the factory default setting. For details, see page 38.)
- The signals from the surround channels reflect off the walls as shown on the diagram at the left, creating an enveloping and realistic surround sound presentation. For multi-channel music sources however, the use of bipolar or dipolar speakers mounted at the sides of the listening position may not be satisfactory in order to create a coherent 360 degree surround sound field. Connect another pair of direct radiating speakers as described in example (3) and place them at the rear corners of the room facing towards the prime listening position.

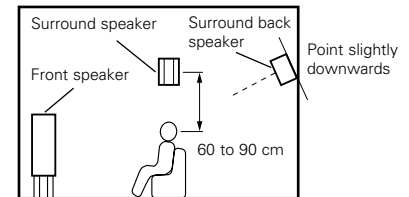

(3) When using different surround speakers for movies and music

To achieve more effective surround sound for both movies and music, use different sets of surround speakers and different surround modes for the two types of sources.

- Set the front speakers slightly wider apart than the setup for watching movies only and point them toward the listening position in order assure clear positioning of the sound.
- Set the center speaker in the same positions as in example (1).
- Set surround speakers A for watching movies in the positions described in example (1) or (2), depending on the types of speakers used.
- Set surround speakers B for playing multi-channel music at the same height as the front speakers and slightly at an angle to the rear of the listening position, and point them toward the listening position.
- Connect the surround speakers for watching movies to the surround speaker A jacks on the AVR-3805, the surround speakers for playing multi-channel music to the surround speaker B jacks. Set the surround speaker selection on the setup menu. (For instructions, see page 38.)

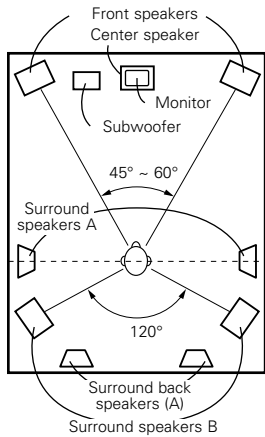

As seen from above

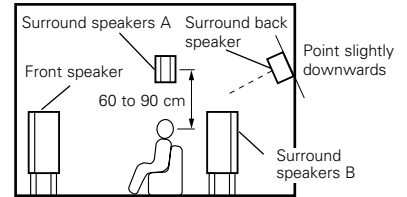

As seen from the side

2. When not using surround back speakers

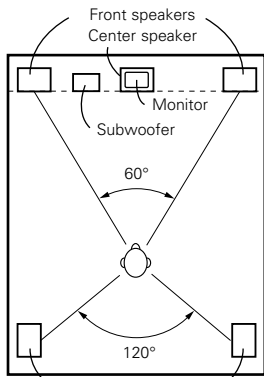

As seen from above

- Set the front speakers with their front surfaces as flush with the TV or monitor screen as possible. Set the center speaker between the front left and right speakers and no further from the listening position than the front speakers.
- Consult the owner's manual for your subwoofer for advice on placing the subwoofer within the listening room.
- If the surround speakers are direct-radiating (monopolar) then place them slightly behind and at an angle to the listening position and parallel to the walls at a position 60 to 90 centimeters (2 to 3 feet) above ear level at the prime listening position.
- Connect the surround speakers to the surround speaker A jacks on the AVR-3805 and set all settings on the setup menu to "A". (This is the factory default setting. For details, see page 38.)

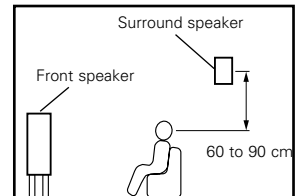

As seen from the side

Surround

The AVR-3805 is equipped with a digital signal processing circuit that lets you play program sources in the surround mode to achieve the same sense of presence as in a movie theater.

Dolby Surround

(1) Dolby Digital

Dolby Digital is the multi-channel digital signal format developed by Dolby Laboratories.

Dolby Digital consists of up to “5.1” channels - front left, front right, center, surround left, surround right, and an additional channel exclusively reserved for additional deep bass sound effects (the Low Frequency Effects – LFE – channel, also called the “.1” channel, containing bass frequencies of up to 120 Hz).

Unlike the analog Dolby Pro Logic format, Dolby Digital’s main channels can all contain full range sound information, from the lowest bass, up to the highest frequencies – 22 kHz. The signals within each channel are distinct from the others, allowing pinpoint sound imaging, and Dolby Digital offers tremendous dynamic range from the most powerful sound effects to the quietest, softest sounds, free from noise and distortion.

■ Dolby Digital and Dolby Pro Logic

Comparison of home surround systems	Dolby Digital	Dolby Pro Logic
No. recorded channels (elements)	5.1 ch	2 ch
No. playback channels	5.1 ch	4 ch
Playback channels (max.)	L, R, C, SL, SR, SW	L, R, C, S (SW - recommended)
Audio processing	Digital discrete processing Dolby Digital encoding/decoding	Analog matrix processing Dolby Surround
High frequency playback limit of surround channel	20 kHz	7 kHz

■ Dolby Digital compatible media and playback methods

Marks indicating Dolby Digital compatibility:  .

The following are general examples. Also refer to the player’s operating instructions.

Media	Dolby Digital output jacks	Playback method (reference page)
LD (VDP)	Coaxial Dolby Digital RF output jack ※1	Set the input mode to “AUTO”. (Page 63)
DVD	Optical or coaxial digital output (same as for PCM) ※2	Set the input mode to “AUTO”. (Page 63)
Others (satellite broadcasts, CATV, etc.)	Optical or coaxial digital output (same as for PCM)	Set the input mode to “AUTO”. (Page 63)

※1 Please use a commercially available adapter when connecting the Dolby Digital RF output jack of the LD player to the digital input jack.

Please refer to the instruction manual of the adapter when making connection.

※2 Some DVD digital outputs have the function of switching the Dolby Digital signal output method between “bit stream” and “(convert to) PCM”. When playing in Dolby Digital surround on the AVR-3805, switch the DVD player’s output mode to “bit stream”. In some cases players are equipped with both “bit stream + PCM” and “PCM only” digital outputs. In this case connect the “bit stream + PCM” jacks to the AVR-3805.

(2) Dolby Pro Logic IIx

- Dolby Pro Logic IIx furthers the matrix decoding technology of Dolby Pro Logic II to decode audio signals recorded on two channels into up to 7.1 playback channels, including the surround back channel. Dolby Pro Logic IIx also allows 5.1-channel sources to be played in up to 7.1 channels.

The mode can be selected according to the source. The Music mode is best suited for playing music, the Cinema mode for playing movies, and the Game mode for playing games. The Game mode can only be used with 2-channel audio sources.

(3) Dolby Pro Logic II

- Dolby Pro Logic II is a new multi-channel playback format developed by Dolby Laboratories using feedback logic steering technology and offering improvements over conventional Dolby Pro Logic circuits.
- Dolby Pro Logic II can be used to decode not only sources recorded in Dolby Surround (※) but also regular stereo sources into five channels (front left, front right, center, surround left and surround right) to achieve surround sound.
- Whereas with conventional Dolby Pro Logic the surround channel playback frequency band was limited, Dolby Pro Logic II offers a wider band range (20 Hz to 20 kHz or greater). In addition, the surround channels were monaural (the surround left and right channels were the same) with previous Dolby Pro Logic, but Dolby Pro Logic II they are played as stereo signals.
- Various parameters can be set according to the type of source and the contents, so it is possible to achieve optimum decoding (see page 73).

※ Sources recorded in Dolby Surround

These are sources in which three or more channels of surround have been recorded as two channels of signals using Dolby Surround encoding technology.

Dolby Surround is used for the sound tracks of movies recorded on DVDs, LDs and Video cassettes to be played on stereo VCRs, as well as for the stereo broadcast signals of FM radio, TV, satellite broadcasts and cable TV.

Decoding these signals with Dolby Pro Logic II makes it possible to achieve multi-channel surround playback. The signals can also be played on ordinary stereo equipment, in which case they provide normal stereo sound.

There are two types of DVD Dolby surround recording signals.

- ① 2-channel PCM stereo signals
- ② 2-channel Dolby Digital signals

When either of these signals is input to the AVR-3805, the surround mode is automatically set to Dolby Pro Logic II when the "DOLBY/DTS SURROUND" mode is selected.

■ Sources recorded in Dolby Surround are indicated with the logo mark shown below.

Dolby Surround support mark: 

Manufactured under license from Dolby Laboratories.
 "Dolby", "Pro Logic" and the double-D symbol are trademarks of Dolby Laboratories.

DTS Digital Surround

Digital Theater Surround (also called simply DTS) is a multi-channel digital signal format developed by Digital Theater Systems.



DTS offers the same "5.1" playback channels as Dolby Digital (front left, front right and center, surround left and surround right) as well as the stereo 2-channel mode. The signals for the different channels are fully independent, eliminating the risk of deterioration of sound quality due to interference between signals, crosstalk, etc.

DTS features a relatively higher bit rate as compared to Dolby Digital (1234 kbps for CDs and LDs, 1536 kbps for DVDs) so it operates with a relatively low compression rate. Because of this the amount of data is great, and when DTS playback is used in movie theaters, a separate CD-ROM synchronized with the film is played.

With LDs and DVDs, there is of course no need for an extra disc; the pictures and sound can be recorded simultaneously on the same disc, so the discs can be handled in the same way as discs with other formats.

There are also music CDs recorded in DTS. These CDs include 5.1-channel surround signals (compared to two channels on current CDs). They do not include picture data, but they offer surround playback on CD players that are equipped with digital outputs (PCM type digital output required). DTS surround track playback offers the same intricate, grand sound as in a movie theater, right in your own listening room.

■ DTS compatible media and playback methods

Marks indicating DTS compatibility:  and .

The following are general examples. Also refer to the player's operating instructions.

Media	Dolby Digital output jacks	Playback method (reference page)
CD	Optical or coaxial digital output (same as for PCM) ※2	Set the input mode to "AUTO" or "DTS" (page 63). Never set the mode to "ANALOG" or "PCM". ※1
LD (VDP)	Optical or coaxial digital output (same as for PCM) ※2	Set the input mode to "AUTO" or "DTS" (page 63). Never set the mode to "ANALOG" or "PCM". ※1
DVD	Optical or coaxial digital output (same as for PCM) ※3	Set the input mode to "AUTO" or "DTS" (page 63).

※1 DTS signals are recorded in the same way on CDs and LDs as PCM signals. Because of this, the un-decoded DTS signals are output as random "hissy" noise from the CD or LD player's analog outputs. If this noise is played with the amplifier set at a very high volume, it may possibly cause damage to the speakers. To avoid this, be sure to switch the input mode to "AUTO" or "DTS" before playing CDs or LDs recorded in DTS. Also, never switch the input mode to "ANALOG" or "PCM" during playback. The same holds true when playing CDs or LDs on a DVD player or LD/DVD compatible player. For DVDs, the DTS signals are recorded in a special way so this problem does not occur.

※2 The signals provided at the digital outputs of a CD or LD player may undergo some sort of internal signal processing (output level adjustment, sampling frequency conversion, etc.). In this case the DTS-encoded signals may be processed erroneously, in which case they cannot be decoded by the AVR-3805, or may only produce noise. Before playing DTS signals for the first time, turn down the master volume to a low level, start playing the DTS disc, then check whether the DTS indicator on the AVR-3805 (see page 64) lights before turning up the master volume.

※3 A DVD player with DTS-compatible digital output is required to play DTS DVDs. A DTS Digital Output logo is featured on the front panel of compatible DVD players. Recent DENON DVD player models feature DTS-compatible digital output – consult the player's owner's manual for information on configuring the digital output for DTS playback of DTS-encoded DVDs.

Manufactured under license from Digital Theater Systems, Inc. US Pat. No. 5,451,942, 5,956,674, 5,974,380, 5,978,762 and other world-wide patents issued and pending.
 "DTS", "DTS-ES Extended Surround" and "Neo:6" are trademarks of Digital Theater Systems, Inc. ©1996, 2000 Digital Theater Systems, Inc. All Rights Reserved.

DTS-ES Extended Surround™

DTS-ES Extended Surround is a new multi-channel digital signal format developed by Digital Theater Systems Inc. While offering high compatibility with the conventional DTS Digital Surround format, DTS-ES Extended Surround greatly improves the 360-degree surround impression and space expression thanks to further expanded surround signals. This format has been used professionally in movie theaters since 1999.

In addition to the 5.1 surround channels (FL, FR, C, SL, SR and LFE), DTS-ES Extended Surround also offers the SB (Surround Back, sometimes also referred to as "surround center") channel for surround playback with a total of 6.1 channels. DTS-ES Extended Surround includes two signal formats with different surround signal recording methods, as described below.

■ DTS-ES™ Discrete 6.1

DTS-ES Discrete 6.1 is the newest recording format. With it, all 6.1 channels (including the SB channel) are recorded independently using a digital discrete system. The main feature of this format is that because the SL, SR and SB channels are fully independent, the sound can be designed with total freedom and it is possible to achieve a sense that the acoustic images are moving about freely among the background sounds surrounding the listener from 360 degrees.

Though maximum performance is achieved when sound tracks recorded with this system are played using a DTS-ES decoder, when played with a conventional DTS decoder the SB channel signals are automatically down-mixed to the SL and SR channels, so none of the signal components are lost.

■ DTS-ES™ Matrix 6.1

With this format, the additional SB channel signals undergo matrix encoding and are input to the SL and SR channels beforehand. Upon playback they are decoded to the SL, SR and SB channels. The performance of the encoder used at the time of recording can be fully matched using a high precision digital matrix decoder developed by DTS, thereby achieving surround sound more faithful to the producer's sound design aims than with conventional 5.1- or 6.1-channel systems.

In addition, the bit stream format is 100% compatible with conventional DTS signals, so the effect of the Matrix 6.1 format can be achieved even with 5.1-channel sources. Of course it is also possible to play DTS-ES Matrix 6.1 encoded sources with a DTS 5.1-channel decoder.

When DTS-ES Discrete 6.1 or Matrix 6.1 encoded sources are decoded with a DTS-ES decoder, the format is automatically detected upon decoding and the optimum playing mode is selected. However, some Matrix 6.1 sources may be detected as having a 5.1-channel format, so the DTS-ES Matrix 6.1 mode must be set manually to play these sources.

(For instructions on selecting the surround mode, see page 78.)

The DTS-ES decoder includes another function, the DTS Neo:6 surround mode for 6.1-channel playback of digital PCM and analog signal sources.

■ DTS Neo:6™ surround

This mode applies conventional 2-channel signals to the high precision digital matrix decoder used for DTS-ES Matrix 6.1 to achieve 6.1-channel surround playback. High precision input signal detection and matrix processing enable full band reproduction (frequency response of 20 Hz to 20 kHz or greater) for all 6.1 channels, and separation between the different channels is improved to the same level as that of a digital discrete system.

DTS Neo:6 surround includes two modes for selecting the optimum decoding for the signal source.

• DTS Neo:6 Cinema

This mode is optimum for playing movies. Decoding is performed with emphasis on separation performance to achieve the same atmosphere with 2-channel sources as with 6.1-channel sources.

This mode is effective for playing sources recorded in conventional surround formats as well, because the in-phase component is assigned mainly to the center channel (C) and the reversed phase component to the surround (SL, SR and SB channels).

• DTS Neo:6 Music

This mode is suited mainly for playing music. Changes in the sound quality are reduced by decoding with emphasis on the front channel signals (FL and FR), and a natural sense of expansion is given to the sound field by the effect of the surround signals output from the center (C) and surround (SL, SR and SB) channels.

DTS 96/24

The sampling frequency, number of bits and number of channels used for recording of music, etc., in studios has been increasing in recent years, and there are a growing number of high quality signal sources, including 96 kHz/24 bit 5.1-channel sources.

For example, there are high picture/sound quality DVD video sources with 96 kHz/24 bit stereo PCM audio tracks.

However, because the data rate for these audio tracks is extremely high, there are limits to recording them on two channels only, and since the quality of the pictures must be restricted it is common to only include still pictures.

In addition, 96 kHz/24 bit 5.1-channel surround is possible with DVD audio sources, but DVD audio players are required to play them with this high quality.

DTS 96/24 is a multi-channel digital signal format developed by Digital Theater Systems Inc. in order to deal with this situation.

Conventional surround formats used sampling frequencies of 48 or 44.1 kHz, so 20 kHz was about the maximum playback signal frequency. With DTS 96/24, the sampling frequency is increased to 96 or 88.2 kHz to achieve a wide frequency range of over 40 kHz.

In addition, DTS 96/24 has a resolution of 24 bits, resulting in the same frequency band and dynamic range as 96 kHz/24 bit PCM.

As with conventional DTS Surround, DTS 96/24 is compatible with a maximum of 5.1 channels, so sources recorded using DTS 96/24 can be played in high sampling frequency, multiple channel audio with such normal media as DVD videos and CDs.

Thus, with DTS 96/24, the same 96 kHz/24 bit multi-channel surround sound as with DVD-Audio can be achieved while viewing DVD-Video images on a conventional DVD-Video player (*1). Furthermore, with DTS 96/24 compatible CDs, 88.2 kHz/24 bit multi-channel surround can be achieved using normal CD/LD players (*1).

Even with the high quality multi-channel signals, the recording time is the same as with conventional DTS surround sources.

What's more, DTS 96/24 is fully compatible with the conventional DTS surround format, so DTS 96/24 signal sources can be played with a sampling frequency of 48 kHz or 44.1 kHz on conventional DTS or DTS-ES surround decoders (*2).

*1: A DVD player with DTS digital output capabilities (for CD/LD players, a player with digital outputs for conventional DTS CDs/LDs) and a disc recorded in DTS 96/24 are required.

*2: The resolution is 24 or 20 bits, depending on the decoder.

HDCD® (High Definition Compatible Digital®)

HDCD is an encoding/decoding technology that greatly reduces the distortion that occurs upon digital recording while maintaining compatibility with the conventional CD format, thus expanding the dynamic range and achieving a high resolution.

Conventional CDs and HDCD compatible CDs are identified automatically to select the optimum digital processing.



- ®, HDCD®, High Definition Compatible Digital® and Microsoft® are either registered trademarks or trademarks of Microsoft Corporation, Inc. in the United States and/or other countries. HDCD system manufactured under license from Microsoft Corporation, Inc. This product is covered by one or more of the following: In the USA: 5,479,168, 5,638,074, 5,640,161, 5,808,574, 5,838,274, 5,854,600, 5,864,311, 5,872,531, and in Australia: 669114. Other patents pending.

DENON LINK (DENON Digital Link)

High-grade LPCM 24-bit, 96-kHz, 6-channel or 24-bit, 192-kHz, 2-channel^(*) digital input is possible when the AVR-3805 is connected via a shielded twisted pair (STP) cable to a Denon DVD player that supports Denon Digital Link. Since Denon Digital Link uses low-voltage differential signaling (LVDS), transfer capabilities of greater than 1.2 Gbps at a differential voltage of approximately 0.3Vpp are possible.

AL24 Plus (AL24 Processing Plus)

■ AL24 Processing for All Channels

Denon has further developed its proprietary AL24 Processing, an analog waveform reproduction technology, to support the 192-kHz sampling frequency of DVD-Audio. AL24 Processing Plus, thoroughly suppresses quantization noise associated with D/A conversion of LPCM signals to reproduce the low-level signals with optimum clarity that will bring out all the delicate nuances of the music.

Equipped for not only front left and right channels but also for the surround left and right, center and subwoofer channels.

System setup items and default values (set upon shipment from the factory)

1. Speaker Setup

Speaker Setup			Default settings								
1	Speaker Configuration	Input the combination of speakers in your system and their corresponding sizes (SMALL for regular speakers, LARGE for full-size, full-range) to automatically set the composition of the signals output from the speakers and the frequency response.	Front Sp.		Center Sp.	Subwoofer	Surround Sp. A / B		Surround Back Sp.		
			Large		Small	Yes	Small		Small / 2spkr		
2	Delay Time	This parameter is for optimizing the timing with which the audio signals are produced from the speakers and subwoofer according to the listening position.	Front L & R		Center	Subwoofer	Surround L & R		SBL & SBR		
			12 ft (3.6 m)		12 ft (3.6 m)	12 ft (3.6 m)	10 ft (3.0 m)		10 ft (3.0 m)		
3	Channel Level	This adjusts the volume of the signals output from the speakers and subwoofer for the different channels in order to obtain optimum effects.	Front L	Front R	Center	Surround L	Surround R	Surround Back L	Surround Back R	Subwoofer	
			0 dB	0 dB	0 dB	0 dB	0 dB	0 dB	0 dB	0 dB	0 dB
4	Crossover Frequency	Set the frequency (Hz) below which the bass so of the various speaker is to be output from the subwoofer.	80Hz								
5	Subwoofer mode	This selects the subwoofer speaker for playing deep bass signals.	LFE								
6	(Surround Speaker Setting)	Use this function when using multiple surround speaker combinations for more ideal surround sound. Once the combinations of surround speakers to be used for the different surround modes are preset, the surround speakers are selected automatically according to the surround mode.	Surround mode	DOLBY/DTS CINEMA	DOLBY/DTS MUSIC	DOLBY/PL IIX GAME	WIDE SCREEN	5CH/7CH STEREO	DSP SIMULATION	MULTI CH MODE	EXT.IN
			Surround speaker	A	A	A	A	A	A	A	A

2. Input Setup

Input Setup				Default settings								
1	Digital In Assignment	This assigns the digital input jacks for the different input sources.	Input source	CD	DVD	VDP	TV	DBS	V. AUX	VCR-1	VCR-2	CDR/TAPE
			Digital Inputs	COAX1	COAX2	OPT1	OFF	OPT2	OPT5	OPT3	OFF	OPT4
2	Ext. In Subwoofer Level	Set the Ext. In Subwoofer terminal playback level.	Subwoofer = +15 dB									
3	Component In Assign	This assigns the color difference (component) video input jacks for the different input sources.	DVD	VDP	TV	DBS	VCR-1	VCR-2	V. AUX	—	—	
			VIDEO1	NONE	VIDEO2	VIDEO3	NONE	NONE	NONE	—	—	
4	Video Input Mode	Set the input signal to be output from the monitor output terminal.	AUTO									
5	Auto Tuner Presets	FM stations are received automatically and stored in the memory.	A1 ~ A8	87.5/89.1/98.1/107.9/90.1/90.1/90.1/90.1 MHz								
			B1 ~ B8	520/600/1000/1400/1500/1710 kHz/90.1/90.1 MHz								
			C1 ~ C8	90.1 MHz								
			D1 ~ D8	90.1 MHz								
			E1 ~ E8	90.1 MHz								
			F1 ~ F8	90.1 MHz								
G1 ~ G8	90.1 MHz											

3. Advanced Playback

Advanced Playback			Default settings			
1	Audio Delay	Set the audio delay to delay time the sound and synchronize it with the picture.	0 ms			
2	Dolby Digital Setup	Turn the audio compression on or off when down-mixing Dolby Digital signals.	OFF			
3	Auto Surround Mode	Set the Auto surround mode function.	Auto Surround Mode = ON			

4.Option Setup

Option Setup			Default settings										
1	Power AMP Assignment	Set this to switch the surround back channel's power amplifier for use for zone2 or zone3.	Surround Back										
2	Zone2 vol. Level	This sets the output level the zone2 output jacks.	Variable										
3	Trigger Out1 Setup	Set the Trigger Out1 output for the different input sources.	ZONE=ZONE1										
			PHONO	CD	TUNER	CDR/TAPE	DVD	VDP	TV	DBS	VCR-1	VCR-2	V. AUX
			OFF	OFF	OFF	OFF	ON	ON	ON	ON	ON	ON	ON
4	Trigger Out2 Setup	Set the Trigger Out2 output for the different input sources.	ZONE=ZONE2										
			PHONO	CD	TUNER	CDR/TAPE	DVD	VDP	TV	DBS	VCR-1	VCR-2	V. AUX
			ON	ON	ON	ON	ON	ON	ON	ON	ON	ON	ON
5	Muting Level	This sets the output level for the speaker terminals.	--dB(minimum)										
6	On Screen Display	This sets whether or not to display the on-screen display that appears on the monitor screen when the controls on the remote control unit or main unit are operated. A setting to prevent flickering.	On Screen Display = ON / Mode 1										
7	Setup Lock	Set whether or not to lock the system setup settings so that they cannot be changed.	Setup Lock = OFF										

Surround modes and parameters

Mode	Signals and adjustability in the different modes										
	Channel output					When playing Dolby Digital signals	When playing DTS signals	When playing PCM signals	When playing ANALOG signals	When playing DSD signals	When playing DVD-AUDIO signals
	FRONT L/R	CENTER	SURROUND L/R	SURROUND BACK L/R	SUB-WOOFER						
DIRECT / PURE DIRECT	○	×	×	×	⊗	○	○	○	○	○	○
MULTI CH DIRECT	○	⊗	⊗	⊗	⊗	×	×	×	×	○	○
STEREO	○	×	×	×	⊗	○	○	○	○	○	○
EXTERNAL INPUT	○	⊗	⊗	⊗	⊗	×	×	×	○	×	×
MULTI CH IN	○	⊗	⊗	⊗	⊗	×	×	×	×	○	○
DOLBY PRO LOGIC II	○	⊗	⊗	⊗	⊗	○*	○*	○	○	○*	○*
DOLBY PRO LOGIC II x	○	⊗	⊗	⊗	⊗	○*	○	○	○	○*	○*
DTS NEO:6	○	⊗	⊗	⊗	⊗	○*	○*	○	○	○*	○*
DOLBY DIGITAL SURROUND	○	⊗	⊗	⊗	⊗	○	×	×	×	×	×
DTS SURROUND	○	⊗	⊗	⊗	⊗	×	○	×	×	×	×
5/7CH STEREO	○	⊗	⊗	⊗	⊗	○	○	○	○	○	○
WIDE SCREEN	○	⊗	⊗	⊗	⊗	○	○	○	○	○	○
SUPER STADIUM	○	⊗	⊗	⊗	⊗	○	○	○	○	○	○
ROCK ARENA	○	⊗	⊗	⊗	⊗	○	○	○	○	○	○
JAZZ CLUB	○	⊗	⊗	⊗	⊗	○	○	○	○	○	○
CLASSIC CONCERT	○	⊗	⊗	⊗	⊗	○	○	○	○	○	○
MONO MOVIE	○	⊗	⊗	⊗	⊗	○	○	○	○	○	○
VIDEO GAME	○	⊗	⊗	⊗	⊗	○	○	○	○	○	○
MATRIX	○	⊗	⊗	⊗	⊗	○	○	○	○	○	○
VIRTUAL	○	×	×	×	⊗	○	○	○	○	○	○

○ : Signal / Adjustable
 × : No signal
 ⊗ : Turned on or off by speaker configuration setting

○ : Able
 × : Unable
 * : Only for 2 ch contents

Mode	Signals and adjustability in the different modes						
	Parameter (default values are shown in parentheses)						
	When playing Dolby Digital and DTS signals			SB CH OUT (MODE)	TONE CONTROL	CINEMA EQ.	MODE
	D. COMP	LFE	AFDM				
DIRECT / PURE DIRECT	○ (OFF)	○ (0dB)	×	×	×	×	×
MULTI CH DIRECT	×	○ (0dB)	×	○	×	×	×
STEREO	○ (OFF)	○ (0dB)	×	×	○ (0dB)	×	×
EXTERNAL INPUT	×	×	×	×	×	×	×
MULTI CH IN	×	○ (0dB)	×	○	○ (0dB)	×	×
PRO LOGIC II	○ (OFF)	○ (0dB)	○	○	○ (0dB)	○ (OFF)	○
DOLBY PRO LOGIC II x	○ (OFF)	○ (0dB)	○	○	○ (0dB)	○ (OFF)	○
DTS NEO:6	○ (OFF)	○ (0dB)	○	○	○ (0dB)	○ (OFF)	○
DOLBY DIGITAL SURROUND	○ (OFF)	○ (0dB)	○	○	○ (0dB)	○ (OFF)	×
DTS SURROUND	○ (OFF)	○ (0dB)	○	○	○ (0dB)	○ (OFF)	×
5/7CH STEREO	○ (OFF)	○ (0dB)	×	○	○ (0dB)	×	×
WIDE SCREEN	○ (OFF)	○ (0dB)	×	○	○ (0dB)	×	×
SUPER STADIUM	○ (OFF)	○ (0dB)	×	○	○ (Note1)	×	×
ROCK ARENA	○ (OFF)	○ (0dB)	×	○	○ (Note2)	×	×
JAZZ CLUB	○ (OFF)	○ (0dB)	×	○	○ (0dB)	×	×
CLASSIC CONCERT	○ (OFF)	○ (0dB)	×	○	○ (0dB)	×	×
MONO MOVIE	○ (OFF)	○ (0dB)	×	○	○ (0dB)	×	×
VIDEO GAME	○ (OFF)	○ (0dB)	×	○	○ (0dB)	×	×
MATRIX	○ (OFF)	○ (0dB)	×	○	○ (0dB)	×	×
VIRTUAL	○ (OFF)	○ (0dB)	×	×	○ (0dB)	×	×

○ : Able
 × : Unable

○ : Adjustable
 × : Not adjustable
 Note1 : BASS +6 dB, TREBLE 0 dB
 Note2 : BASS +6 dB, TREBLE 4 dB

Mode	Signals and adjustability in the different modes									
	SURROUND PARAMETER									
	ROOM SIZE	EFFECT ON/OFF	EFFECT LEVEL	DELAY TIME	SUBWOOFER ON/OFF	PRO LOGIC II / II x ONLY			NEO:6 MUSIC	EXT.IN
						PANORAMA	DIMENSION	CENTER WIDTH	CENTER IMAGE	SW ATT
DIRECT / PURE DIRECT	×	×	×	×	○	×	×	×	×	×
MULTI CH DIRECT	×	×	×	×	×	×	×	×	×	×
STEREO	×	×	×	×	×	×	×	×	×	×
EXTERNAL INPUT	×	×	×	×	×	×	×	×	×	○
MULTI CH IN	×	×	×	×	×	×	×	×	×	×
PRO LOGIC II	×	×	×	×	×	○ (OFF)	○ (3)	○ (3)	×	×
DOLBY PRO LOGIC II x	×	×	×	×	×	○ (OFF)	○ (3)	○ (3)	×	×
DTS NEO:6	×	×	×	×	×	×	×	×	○ (0.3)	×
DOLBY DIGITAL SURROUND	×	×	×	×	×	×	×	×	×	×
DTS SURROUND	×	×	×	×	×	×	×	×	×	×
5/7CH STEREO	×	×	×	×	×	×	×	×	×	×
WIDE SCREEN	×	○ (ON)	○ (10)	×	×	×	×	×	×	×
SUPER STADIUM	○ (Medium)	×	○ (10)	×	×	×	×	×	×	×
ROCK ARENA	○ (Medium)	×	○ (10)	×	×	×	×	×	×	×
JAZZ CLUB	○ (Medium)	×	○ (10)	×	×	×	×	×	×	×
CLASSIC CONCERT	○ (Medium)	×	○ (10)	×	×	×	×	×	×	×
MONO MOVIE	○ (Medium)	×	○ (10)	×	×	×	×	×	×	×
VIDEO GAME	○ (Medium)	×	○ (10)	×	×	×	×	×	×	×
MATRIX	×	×	×	○ (30ms)	×	×	×	×	×	×
VIRTUAL	×	×	×	×	×	×	×	×	×	×

○ : Adjustable
 × : Not adjustable

■ Differences in surround mode names depending on the input signals

Surround Mode	Input signals						
	ANALOG	LINEAR PCM	DTS			DOLBY DIGITAL	
			DTS (5.1 ch)	DTS 96/24 (5.1 ch)	DTS (6.1 ch)	D. D. (2 ch)	D. D. (5.1 ch)
PURE DIRECT, DIRECT	○	○	○	○	○	○	○
STEREO	○	○	○	○	○	○	○
DTS SURROUND	DTS NEO:6	DTS NEO:6	*DTS ES MTRX DTS SURROUND DTS+PLIIx (Cinema,Music)	*DTS ES MTRX DTS 96/24 DTS+PLIIx (Cinema,Music)	◎ ES DSCRT6.1 ES MTRX6.1 *DTS SURROUND DTS+PLIIx(Cinema,Music)	DTS NEO:6	×
DOLBY DIGITAL	*DOLBY PRO LOGIC II DOLBY PRO LOGIC IIx (Cinema,Music,Game)	*DOLBY PRO LOGIC II DOLBY PRO LOGIC IIx (Cinema,Music,Game)	×	×	×	*DOLBY PRO LOGIC II DOLBY PRO LOGIC IIx (Cinema,Music,Game)	*DOLBY DIGITAL EX DOLBY DIGITAL DOLBY DIGITAL +PL IIx (Cinema,Music)
DSP SIMULATION	○	○	○	○	○	○	○

○ : Selectable

* : The surround mode name differs depending on the "SB CH OUT" surround parameter setting.

◎ : The surround mode name differs depending on the input signal.

× : Not selectable

Relationship between the video input signal and monitor output according to the VIDEO INPUT MODE settings

VIDEO INPUT Mode	Input signals			MONITOR OUT		
	COMPONENT	S-VIDEO	VIDEO	COMPONENT	S-VIDEO	VIDEO
AUTO	×	×	○	VIDEO	VIDEO	VIDEO
	×	○	×	S-VIDEO	S-VIDEO	S-VIDEO
	×	○	○	S-VIDEO	S-VIDEO	VIDEO *3
	○	×	×	COMPONENT	×	×
	○	×	○	COMPONENT *1	VIDEO	VIDEO
	○	○	×	COMPONENT *2	S-VIDEO	S-VIDEO
○	○	○	COMPONENT *2	S-VIDEO	VIDEO *3	

VIDEO INPUT Mode	Input signals			MONITOR OUT		
	COMPONENT	S-VIDEO	VIDEO	COMPONENT	S-VIDEO	VIDEO
COMPONENT	×	×	○	×	×	×
	×	○	×	×	×	×
	×	○	○	×	×	×
	○	×	×	COMPONENT	×	×
	○	×	○	COMPONENT	×	×
	○	○	×	COMPONENT	×	×
○	○	○	COMPONENT	×	×	

VIDEO INPUT Mode	Input signals			MONITOR OUT		
	COMPONENT	S-VIDEO	VIDEO	COMPONENT	S-VIDEO	VIDEO
S-VIDEO	×	×	○	×	×	×
	×	○	×	S-VIDEO	S-VIDEO	S-VIDEO
	×	○	○	S-VIDEO	S-VIDEO	S-VIDEO
	○	×	×	×	×	×
	○	×	○	×	×	×
	○	○	×	S-VIDEO	S-VIDEO	S-VIDEO
○	○	○	S-VIDEO	S-VIDEO	S-VIDEO	

VIDEO INPUT Mode	Input signals			MONITOR OUT		
	COMPONENT	S-VIDEO	VIDEO	COMPONENT	S-VIDEO	VIDEO
VIDEO	×	×	○	VIDEO	VIDEO	VIDEO
	×	○	×	×	×	×
	×	○	○	VIDEO	VIDEO	VIDEO
	○	×	×	×	×	×
	○	×	○	VIDEO	VIDEO	VIDEO
	○	○	×	×	×	×
○	○	○	VIDEO	VIDEO	VIDEO	

○ : Signal input

× : No signal

× : Not output

COMPONENT : On-screen display only displayed for SYSTEM SETUP, SURR.PARA and ON SCREEN buttons

*1 : On-screen display superimposed on video signal and output

*2 : On-screen display superimposed on S-video signal and output

*3 : The on-screen display is not displayed when a cable is connected to the S-VIDEO monitor output terminal.

18 SPECIFICATIONS

<ul style="list-style-type: none"> ■ Audio section • Power amplifier 		
Rated output:	Front:	120 W + 120 W (8 Ω/ohms, 20 Hz ~ 20 kHz with 0.05% T.H.D.) 160 W + 160 W (6 Ω/ohms, 1 kHz with 0.7% T.H.D.)
	Center:	120 W (8 Ω/ohms, 20 Hz ~ 20 kHz with 0.05% T.H.D.) 160 W (6 Ω/ohms, 1 kHz with 0.7% T.H.D.)
	Surround:	120 W + 120 W (8 Ω/ohms, 20 Hz ~ 20 kHz with 0.05% T.H.D.) 160 W + 160 W (6 Ω/ohms, 1 kHz with 0.7% T.H.D.)
	Surround Back:	120 W + 120 W (8 Ω/ohms, 20 Hz ~ 20 kHz with 0.05% T.H.D.) 160 W + 160 W (6 Ω/ohms, 1 kHz with 0.7% T.H.D.)
Dynamic power:	140 W x 2 ch	(8 Ω/ohms)
	210 W x 2 ch	(4 Ω/ohms)
	240 W x 2 ch	(2 Ω/ohms)
Output terminals:	Front, Center, Surr. Back/Multi Zone	6 ~ 16 Ω/ohms
	Surround:	A or B 6 ~ 16 Ω/ohms A + B 8 ~ 16 Ω/ohms
<ul style="list-style-type: none"> • Analog 		
Input sensitivity / input impedance:	200 mV / 47 kΩ/kohms	
Frequency response:	10 Hz ~ 100 kHz: +0, -3 dB (DIRECT mode)	
S/N:	102 dB (DIRECT mode)	
Distortion:	0.005% (20 Hz ~ 20 kHz) (DIRECT mode)	
Rated output:	1.2 V	
<ul style="list-style-type: none"> • Digital 		
D/A output:	Rated output — 2 V (at 0 dB playback) Total harmonic distortion — 0.008% (1 kHz, at 0 dB) S/N ratio — 102 dB Dynamic range — 96 dB Format — Digital audio interface	
<ul style="list-style-type: none"> • Digital input: 		
<ul style="list-style-type: none"> • Phono equalizer (PHONO input — REC OUT) 		
Input sensitivity:	2.5 mV	
RIAA deviation:	±1 dB (20 Hz to 20 kHz)	
Signal-to-noise ratio:	74 dB (A weighting, with 5 mV input)	
Rated output / Maximum output:	150 mV / 8 V	
Distortion factor:	0.03% (1 kHz, 3 V)	
<ul style="list-style-type: none"> ■ Video section 		
<ul style="list-style-type: none"> • Standard video jacks 		
Input / output level and impedance:	1 Vp-p, 75 Ω/ohms	
Frequency response:	5 Hz ~ 10 MHz — +0, -3 dB	
<ul style="list-style-type: none"> • S-video jacks 		
Input / output level and impedance:	Y (brightness) signal — 1 Vp-p, 75 Ω/ohms C (color) signal — 0.286 Vp-p, 75 Ω/ohms	
Frequency response:	5 Hz ~ 10 MHz — +0, -3 dB	
<ul style="list-style-type: none"> • Color component video jacks 		
Input / output level and impedance:	Y (brightness) signal — 1 Vp-p, 75 Ω/ohms Pb/Cb signal — 0.7 Vp-p, 75 Ω/ohms Pr/Cr signal — 0.7Vp-p, 75 Ω/ohms DC ~ 100 MHz — +0, -3 dB	
Frequency response:		
<ul style="list-style-type: none"> ■ Tuner section 		
Receiving Range:	[FM] (note: μV at 75 Ω/ohms, 0 dBf=1 x 10 ⁻¹⁵ W)	[AM]
Usable Sensitivity:	87.50 MHz ~ 107.90 MHz	520 kHz ~ 1710 kHz
50 dB Quieting Sensitivity:	1.0 μV (11.2 dBf)	18 μV
	MONO 1.6 μV (15.3 dBf)	
	STEREO 23 μV (38.5 dBf)	
S/N (IHF-A):	MONO 77 dB	
	STEREO 72 dB	
Total Harmonic Distortion (at 1 kHz):	MONO 0.15%	
	STEREO 0.3%	
<ul style="list-style-type: none"> ■ General 		
Power supply:	AC 120 V, 60 Hz	
Power consumption:	7.1 A 1 W Max (Standby)	
Maximum external dimensions:	434 (W) x 171 (H) x 429 (D) mm (17-3/32" x 6-47/64" x 16-57/64")	
Mass:	17 kg (37 lbs 8 oz)	
<ul style="list-style-type: none"> ■ Remote control unit (RC-969) 		
Batteries:	R03/AAA Type (four batteries)	
External dimensions:	72 (W) x 238 (H) x 25.5 (D) mm (2-53/64" x 9-3/8" x 1-0")	
Mass:	225 g (Approx. 8 oz) (including batteries)	

* For purposes of improvement, specifications and design are subject to change without notice.

MEMO :

DENON,Ltd.

16-11, YUSHIMA 3-CHOME, BUNKYOU-KU, TOKYO 113-0034, JAPAN
Telephone: (03) 3837-5321

Free Manuals Download Website

<http://myh66.com>

<http://usermanuals.us>

<http://www.somanuals.com>

<http://www.4manuals.cc>

<http://www.manual-lib.com>

<http://www.404manual.com>

<http://www.luxmanual.com>

<http://aubethermostatmanual.com>

Golf course search by state

<http://golfingnear.com>

Email search by domain

<http://emailbydomain.com>

Auto manuals search

<http://auto.somanuals.com>

TV manuals search

<http://tv.somanuals.com>