

# DENON

## AV SURROUND RECEIVER RÉCEPTEUR AUDIO-VIDÉO

# AVR-1705/685

## OPERATING INSTRUCTIONS MODE D'EMPLOI

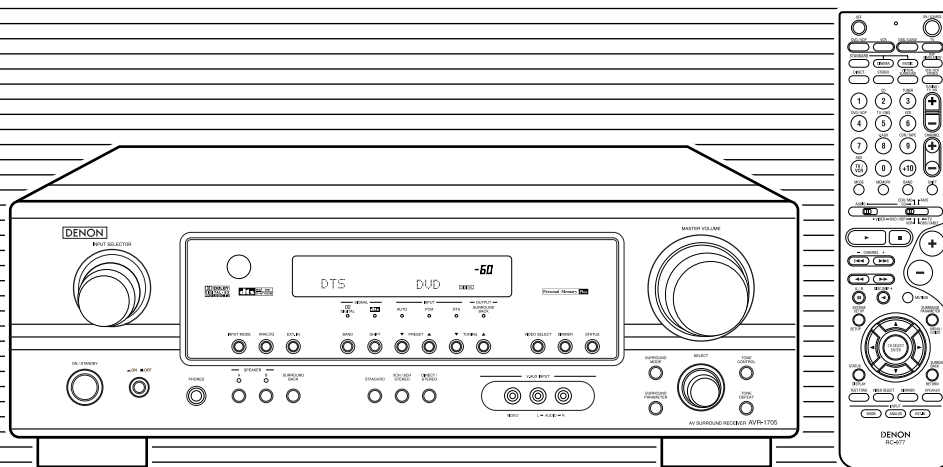

FOR ENGLISH READERS PAGE 2 ~ PAGE 65, 128 ~ 132

- We greatly appreciate your purchase of this unit.
- To be sure you take maximum advantage of all the features this unit has to offer, read these instructions carefully and use the set properly. Be sure to keep this manual for future reference should any questions or problems arise.

"SERIAL NO. \_\_\_\_\_

PLEASE RECORD UNIT SERIAL NUMBER ATTACHED TO THE REAR OF THE CABINET FOR FUTURE REFERENCE"

POUR LES LECTEURS FRANCAIS PAGE 2, 66 ~ PAGE 132

- Nous vous remercions pour l'achat de cet appareil.
- Pour être sûr de profiter au maximum de toutes les caractéristiques qu'offre cet appareil, lire avec soin ces instructions et bien utiliser l'appareil. Toujours conserver ce mode d'emploi pour s'y référer ultérieurement en cas de question ou de problème.

"NO. DE SERIE \_\_\_\_\_

PRIERE DE NOTER LE NUMERO DE SERIE DE L'APPAREIL INSCRIT A L'ARRIERE DU COFFRET DE FAÇON A POUVOIR LE CONSULTER EN CAS DE PROBLEME."

**SAFETY PRECAUTIONS**

**CAUTION**

**RISK OF ELECTRIC SHOCK**

**DO NOT OPEN**

**CAUTION: TO REDUCE THE RISK OF ELECTRIC SHOCK, DO NOT REMOVE COVER (OR BACK). NO USER-SERVICEABLE PARTS INSIDE. REFER SERVICING TO QUALIFIED SERVICE PERSONNEL.**

The lightning flash with arrowhead symbol, within an equilateral triangle, is intended to alert the user to the presence of uninsulated "dangerous voltage" within the product's enclosure that may be of sufficient magnitude to constitute a risk of electric shock to persons.

The exclamation point within an equilateral triangle is intended to alert the user to the presence of important operating and maintenance (servicing) instructions in the literature accompanying the appliance.

**WARNING: TO REDUCE THE RISK OF FIRE OR ELECTRIC SHOCK, DO NOT EXPOSE THIS APPLIANCE TO RAIN OR MOISTURE.**

**FCC INFORMATION (For US customers)**

**1. PRODUCT**  
This product complies with Part 15 of the FCC Rules. Operation is subject to the following two conditions: (1) this product may not cause harmful interference, and (2) this product must accept any interference received, including interference that may cause undesired operation.

**2. IMPORTANT NOTICE: DO NOT MODIFY THIS PRODUCT**  
This product, when installed as indicated in the instructions contained in this manual, meets FCC requirements. Modification not expressly approved by DENON may void your authority, granted by the FCC, to use the product.

**3. NOTE**  
This product has been tested and found to comply with the limits for a Class B digital device, pursuant to Part 15 of the FCC Rules. These limits are designed to provide reasonable protection against harmful interference in a residential installation.  
This product generates, uses and can radiate radio frequency energy and, if not installed and used in accordance with the instructions, may cause harmful interference to radio communications. However, there is no guarantee that interference will not occur in a particular installation. If this product does cause harmful interference to radio or television reception, which can be determined by turning the product OFF and ON, the user is encouraged to try to correct the interference by one or more of the following measures:

- Reorient or relocate the receiving antenna.
- Increase the separation between the equipment and receiver.
- Connect the product into an outlet on a circuit different from that to which the receiver is connected.
- Consult the local retailer authorized to distribute this type of product or an experienced radio/TV technician for help.

**FOR CANADA MODEL ONLY**

**CAUTION**

TO PREVENT ELECTRIC SHOCK, MATCH WIDE BLADE OF PLUG TO WIDE SLOT, FULLY INSERT.

**POUR LES MODELE CANADIEN UNIQUEMENT**

**ATTENTION**

POUR ÉVITER LES CHOCS ÉLECTRIQUES, INTERODUIRE LA LAME LA PLUS LARGE DE LA FICHE DANS LA BORNE CORRESPONDANTE DE LA PRISE ET POUSSER JUSQU' AU FOND.

**NOTE ON USE / OBSERVATIONS RELATIVES A L'UTILISATION**

<ul style="list-style-type: none"> <li>• Avoid high temperatures. Allow for sufficient heat dispersion when installed on a rack.</li> <li>• Éviter des températures élevées. Tenir compte d'une dispersion de chaleur suffisante lors de l'installation sur une étagère.</li> </ul>	<ul style="list-style-type: none"> <li>• Keep the set free from moisture, water, and dust.</li> <li>• Protéger l'appareil contre l'humidité, l'eau et la poussière.</li> </ul>	<ul style="list-style-type: none"> <li>• Do not let foreign objects in the set.</li> <li>• Ne pas laisser des objets étrangers dans l'appareil.</li> </ul>
<ul style="list-style-type: none"> <li>• Handle the power cord carefully. Hold the plug when unplugging the cord.</li> <li>• Manipuler le cordon d'alimentation avec précaution. Tenir la prise lors du débranchement du cordon.</li> </ul>	<ul style="list-style-type: none"> <li>• Unplug the power cord when not using the set for long periods of time.</li> <li>• Débrancher le cordon d'alimentation lorsque l'appareil n'est pas utilisé pendant de longues périodes.</li> </ul>	<ul style="list-style-type: none"> <li>• Do not let insecticides, benzene, and thinner come in contact with the set.</li> <li>• Ne pas mettre en contact des insecticides, du benzène et un diluant avec l'appareil.</li> </ul>
<p style="text-align: center;">* (For sets with ventilation holes)</p> <ul style="list-style-type: none"> <li>• Do not obstruct the ventilation holes.</li> <li>• Ne pas obstruer les trous d'aération.</li> </ul>	<ul style="list-style-type: none"> <li>• Never disassemble or modify the set in any way.</li> <li>• Ne jamais démonter ou modifier l'appareil d'une manière ou d'une autre.</li> </ul>	

# SAFETY INSTRUCTIONS

1. Read Instructions – All the safety and operating instructions should be read before the product is operated.
2. Retain Instructions – The safety and operating instructions should be retained for future reference.
3. Heed Warnings – All warnings on the product and in the operating instructions should be adhered to.
4. Follow Instructions – All operating and use instructions should be followed.
5. Cleaning – Unplug this product from the wall outlet before cleaning. Do not use liquid cleaners or aerosol cleaners.
6. Attachments – Do not use attachments not recommended by the product manufacturer as they may cause hazards.
7. Water and Moisture – Do not use this product near water – for example, near a bath tub, wash bowl, kitchen sink, or laundry tub; in a wet basement; or near a swimming pool; and the like.
8. Accessories – Do not place this product on an unstable cart, stand, tripod, bracket, or table. The product may fall, causing serious injury to a child or adult, and serious damage to the product. Use only with a cart, stand, tripod, bracket, or table recommended by the manufacturer, or sold with the product. Any mounting of the product should follow the manufacturer's instructions, and should use a mounting accessory recommended by the manufacturer.
9. A product and cart combination should be moved with care. Quick stops, excessive force, and uneven surfaces may cause the product and cart combination to overturn.
10. Ventilation – Slots and openings in the cabinet are provided for ventilation and to ensure reliable operation of the product and to protect it from overheating, and these openings must not be blocked or covered. The openings should never be blocked by placing the product on a bed, sofa, rug, or other similar surface. This product should not be placed in a built-in installation such as a bookcase or rack unless proper ventilation is provided or the manufacturer's instructions have been adhered to.
11. Power Sources – This product should be operated only from the type of power source indicated on the marking label. If you are not sure of the type of power supply to your home, consult your product dealer or local power company. For products intended to operate from battery power, or other sources, refer to the operating instructions.
12. Grounding or Polarization – This product may be equipped with a polarized alternating-current line plug (a plug having one blade wider than the other). This plug will fit into the power outlet only one way. This is a safety feature. If you are unable to insert the plug fully into the outlet, try reversing the plug. If the plug should still fail to fit, contact your electrician to replace your obsolete outlet. Do not defeat the safety purpose of the polarized plug.



13. Power-Cord Protection – Power-supply cords should be routed so that they are not likely to be walked on or pinched by items placed upon or against them, paying particular attention to cords at plugs, convenience receptacles, and the point where they exit from the product.
15. Outdoor Antenna Grounding – If an outside antenna or cable system is connected to the product, be sure the antenna or cable system is grounded so as to provide some protection against voltage surges and built-up static charges. Article 810 of the National Electrical Code, ANSI/NFPA 70, provides information with regard to proper grounding of the mast and supporting structure, grounding of the lead-in wire to an antenna discharge unit, size of grounding conductors, location of antenna-discharge unit, connection to grounding electrodes, and requirements for the grounding electrode. See Figure A.
16. Lightning – For added protection for this product during a lightning storm, or when it is left unattended and unused for long periods of time, unplug it from the wall outlet and disconnect the antenna or cable system. This will prevent damage to the product due to lightning and power-line surges.
17. Power Lines – An outside antenna system should not be located in the vicinity of overhead power lines or other electric light or power circuits, or where it can fall into such power lines or circuits. When installing an outside antenna system, extreme care should be taken to keep from touching such power lines or circuits as contact with them might be fatal.
18. Overloading – Do not overload wall outlets, extension cords, or integral convenience receptacles as this can result in a risk of fire or electric shock.
19. Object and Liquid Entry – Never push objects of any kind into this product through openings as they may touch dangerous voltage points or short-out parts that could result in a fire or electric shock. Never spill liquid of any kind on the product.
20. Servicing – Do not attempt to service this product yourself as opening or removing covers may expose you to dangerous voltage or other hazards. Refer all servicing to qualified service personnel.
21. Damage Requiring Service – Unplug this product from the wall outlet and refer servicing to qualified service personnel under the following conditions:
  - a) When the power-supply cord or plug is damaged,
  - b) If liquid has been spilled, or objects have fallen into the product,
  - c) If the product has been exposed to rain or water,
  - d) If the product does not operate normally by following the operating instructions. Adjust only those controls that are covered by the operating instructions as an improper adjustment of other controls may result in damage and will often require extensive work by a qualified technician to restore the product to its normal operation,
  - e) If the product has been dropped or damaged in any way, and
  - f) When the product exhibits a distinct change in performance – this indicates a need for service.
22. Replacement Parts – When replacement parts are required, be sure the service technician has used replacement parts specified by the manufacturer or have the same characteristics as the original part. Unauthorized substitutions may result in fire, electric shock, or other hazards.
23. Safety Check – Upon completion of any service or repairs to this product, ask the service technician to perform safety checks to determine that the product is in proper operating condition.
24. Wall or Ceiling Mounting – The product should be mounted to a wall or ceiling only as recommended by the manufacturer.
25. Heat – The product should be situated away from heat sources such as radiators, heat registers, stoves, or other products (including amplifiers) that produce heat.

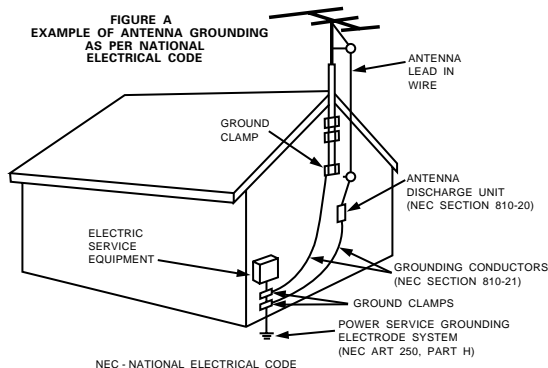

## ■ INTRODUCTION

Thank you for choosing the DENON A/V Surround receiver. This remarkable component has been engineered to provide superb surround sound listening with home theater sources such as DVD, as well as providing outstanding high fidelity reproduction of your favorite music sources. As this product is provided with an immense array of features, we recommend that before you begin hookup and operation that you review the contents of this manual before proceeding.

## TABLE OF CONTENTS



<b>1</b> Before Using .....4	<b>11</b> Remote Control Unit .....29 ~ 33
<b>2</b> Cautions on Installation .....5	<b>12</b> Operation .....34 ~ 38
<b>3</b> Cautions on Handling .....5	<b>13</b> Surround .....39 ~ 47
<b>4</b> Features .....6	<b>14</b> DSP Surround Simulation .....48 ~ 52
<b>5</b> Part Names and Functions .....7, 8	<b>15</b> Listening to the Radio .....53 ~ 55
<b>6</b> Read this first .....9	<b>16</b> Last Function Memory .....56
<b>7</b> Setting up the Speaker Systems .....9	<b>17</b> Initialization of the Microprocessor .....56
<b>8</b> Connections .....10 ~ 16	<b>18</b> Additional Information .....57 ~ 63
<b>9</b> Using the Remote Control Unit .....17	<b>19</b> Troubleshooting .....64
<b>10</b> Setting up the System .....18 ~ 28	<b>20</b> Specifications .....65
	List of Preset Codes .....128 ~ 132

## ■ ACCESSORIES

Check that the following parts are included in addition to the main unit:

① Operating instructions .....1	⑤ R6P/AA batteries .....2
② Warranty .....1	⑥ AM loop antenna .....1
③ Service station list .....1	⑦ FM indoor antenna .....1
④ Remote control unit (RC-977) .....1	

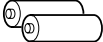
④ 	⑤ 	⑥ 	⑦ 
---	---	--	---

## **1** BEFORE USING

Pay attention to the following before using this unit:

- **Moving the set**  
To prevent short circuits or damaged wires in the connection cords, always unplug the power cord and disconnect the connection cords between all other audio components when moving the set.
- **Before turning the power operation switch on**  
Check once again that all connections are proper and that there are not problems with the connection cords. Always set the power operation switch to the standby position before connecting and disconnecting connection cords.

- **Store this instructions in a safe place.**  
After reading, store this instructions along with the warranty in a safe place.
- **Note that the illustrations in this instructions may differ from the actual set for explanation purposes.**

- **V. AUX terminal**  
The AVR-1705/685's front panel is equipped with a V. AUX terminal. Remove the cap covering the terminal when you want to use it.

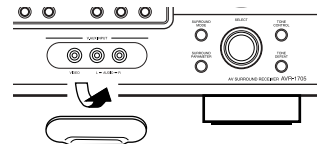

## 2 CAUTIONS ON INSTALLATION

Noise or disturbance of the picture may be generated if this unit or any other electronic equipment using microprocessors is used near a tuner or TV.

If this happens, take the following steps:

- Install this unit as far as possible from the tuner or TV.
- Set the antenna wires from the tuner or TV away from this unit's power cord and input/output connection cords.
- Noise or disturbance tends to occur particularly when using indoor antennas or 300  $\Omega$ /ohms feeder wires. **We recommend using outdoor antennas and 75  $\Omega$ /ohms coaxial cables.**

**For heat dispersal, leave at least 0.3 ft (10 cm) of space between the top, back and sides of this unit and the wall or other components.**

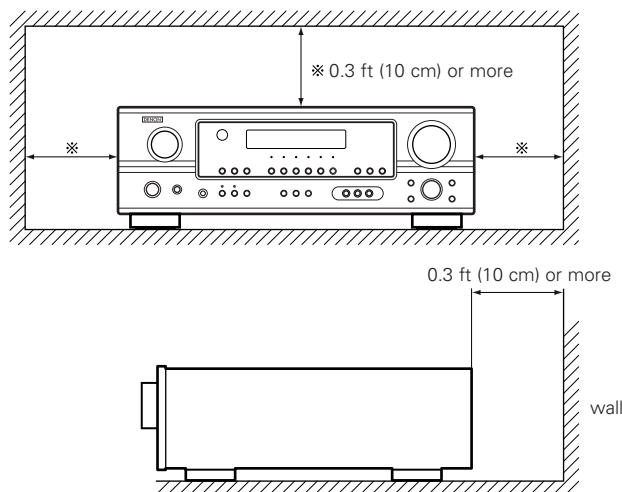

## 3 CAUTIONS ON HANDLING

- **Switching the input function when input jacks are not connected**

A clicking noise may be produced if the input function is switched when nothing is connected to the input jacks. If this happens, either turn down the MASTER VOLUME control or connect components to the input jacks.

- **Muting of PRE OUT jack, HEADPHONE jack and SPEAKER terminals**

The PRE OUT jack, HEADPHONE jack and SPEAKER terminals include a muting circuit. Because of this, the output signals are greatly reduced for several seconds after the power operation switch is turned on or input function, surround mode or any other set-up is changed.

If the volume is turned up during this time, the output will be very high after the muting circuit stops functioning. Always wait until the muting circuit turns off before adjusting the volume.

- **Whenever the unit is in the STANDBY state, the apparatus is still connected on AC line voltage. Please be sure to turn the power off (■ off) when you leave home for, say, a vacation.**

## 4 FEATURES

### 1. Dolby Digital

Using advanced digital processing algorithms, Dolby Digital provides up to 5.1 channels of wide-range, high fidelity surround sound. Dolby Digital is the default digital audio delivery system for DVD and North American DTV.

### 2. Dolby Pro Logic IIx compatibility

Dolby Pro Logic IIx furthers the matrix decoding technology of Dolby Pro Logic II to decode audio signals recorded on two channels into up to 6.1 playback channels, including the surround back channel.

The mode can be selected according to the source. The Music mode is best suited for playing music, the Cinema mode for playing movies, and the Game mode for playing games. The Game mode can only be used with 2-channel audio sources.

### 3. Dolby Pro Logic II Game mode compatibility

In addition to the previously offered Music and Cinema modes, the AVR-1705/685 also offers a Game mode optimum for games.

### 4. DTS (Digital Theater Systems)

DTS provides up to 5.1 channels of wide-range, high fidelity surround sound, from sources such as laser disc, DVD and specially-encoded music discs.

### 5. DTS-ES Extended Surround and DTS Neo:6

The AVR-1705/685 can be decoded with DTS-ES Extended Surround, a multi-channel format developed by Digital Theater Systems Inc.

The AVR-1705/685 can be also decoded with DTS Neo:6, a surround mode allowing 6.1 channels playback of regular stereo sources.

### 6. DTS 96/24 compatibility

The AVR-1705/685 can be decoded with sources recorded in DTS 96/24, a multi-channel digital signal format developed by Digital Theater Systems Inc.

DTS 96/24 sources can be played in the multi-channel mode on the AVR-1705/685 with high sound quality of 96 kHz/24 bits or 88.2 kHz/24 bits.

### 7. Video Conversion Function

The AVR-1705/685 is equipped with a function for up-converting video signals.

Because of this, the AVR-1705/685's MONITOR OUT jack can be connected to the monitor (TV) with a set of cables offering a higher quality connection, regardless of how the player and the AVR-1705/685's video input jacks are connected.

### 8. Component Video Switching

In addition to composite video and "S" video switching, the AVR-1705/685 provides 3 sets of component video (Y, Pb/Cb, Pr/Cr) inputs, and one set of component video outputs to the television, for superior picture quality.

### 9. Auto Surround Mode

This function stores the surround mode last used for an input signal in the memory and automatically sets that surround mode the next time that signal is input.

### 10. Front input terminal

The unit is equipped with a Front Input connector for the convenient connection of a video camera or other equipment.

### 11. 6CH EXT. IN jacks

This unit is equipped with 6CH EXT. IN jacks for use with audio formats of the future.

### 12. Personal Memory Plus function

Personal Memory Plus is an advanced version of Personal Memory. With Personal Memory Plus, the set automatically memorizes the surround mode, channel volume, surround parameters, etc., for each of the separate input sources.

### 13. Preset Memory Tuning

56-Station AM/FM Random Preset Memory tuning.

# 5 PART NAMES AND FUNCTIONS

## Front Panel

• For details on the functions of these parts, refer to the pages given in parentheses ( ).

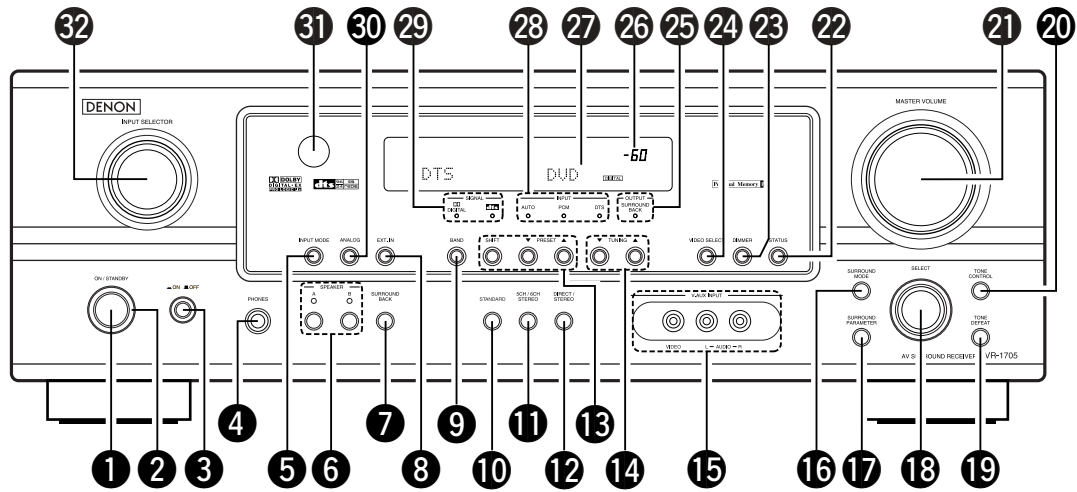

- |  |  |
|--|--|
| <ul style="list-style-type: none"> <li>1 Power ON/STANDBY switch.....(19, 34, 53)</li> <li>2 POWER indicator.....(19, 34)</li> <li>3 Power switch.....(19, 34)</li> <li>4 Headphone jack (PHONES).....(37)</li> <li>5 INPUT MODE button.....(35, 38)</li> <li>6 SPEAKER A/B buttons.....(34, 56)</li> <li>7 SURROUNDBACK button.....(45)</li> <li>8 EXT. IN button.....(35, 38)</li> <li>9 BAND button.....(54)</li> <li>10 STANDARD button.....(39, 41, 43, 45)</li> <li>11 5CH/6CH STEREO button.....(49)</li> <li>12 DIRECT/STEREO button.....(48)</li> <li>13 Preset station select buttons.....(55)</li> <li>14 TUNING ▲ (up) / ▼ (down) buttons.....(54)</li> <li>15 V. AUX INPUT terminals.....(4, 12)</li> <li>16 SURROUND MODE button.....(36)</li> </ul> | <ul style="list-style-type: none"> <li>17 SURROUND PARAMETER button.....(41, 49)</li> <li>18 SELECT knob.....(36, 41, 51)</li> <li>19 TONE DEFEAT button.....(36)</li> <li>20 TONE CONTROL button.....(36)</li> <li>21 MASTER VOLUME control.....(36)</li> <li>22 STATUS button.....(37)</li> <li>23 DIMMER button.....(37)</li> <li>24 VIDEO SELECT button.....(37)</li> <li>25 SURROUND BACK indicator.....(45)</li> <li>26 MASTER VOLUME indicator.....(36)</li> <li>27 Display</li> <li>28 INPUT mode indicators.....(36)</li> <li>29 SIGNAL indicators.....(36)</li> <li>30 ANALOG button.....(35, 38)</li> <li>31 Remote control sensor (REMOTE SENSOR).....(17)</li> <li>32 INPUT SELECTOR knob.....(35)</li> </ul> |
|--|--|

## Remote control unit

- For details on the functions of these parts, refer to the pages given in parentheses ( ).

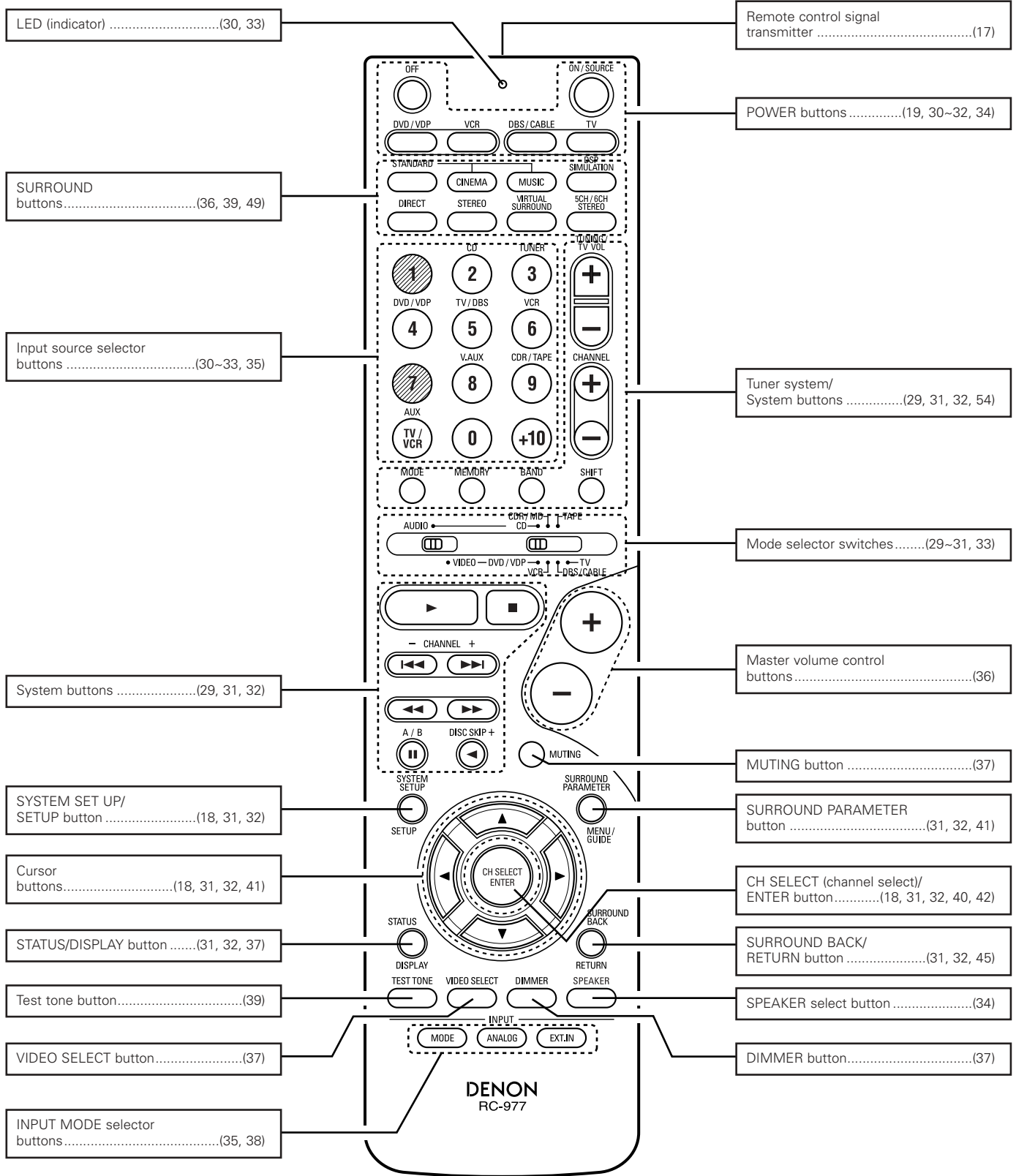

**NOTE:**

- The shaded buttons do not function with the AVR-1705/685. (Nothing happens when they are pressed.)



## 6 READ THIS FIRST

This AV Surround Receiver must be setup before use. Following these steps.

### Step 1 (page 9 to 16)

Choose the best location to setup the Speakers and connecting the components.

### Step 2 (page 17)

Next, insert the batteries into the remote control unit.

### Step 3 (page 18 to 28)

Finally, setting up the system.

## 7 SETTING UP THE SPEAKER SYSTEMS

### ■ Speaker system layout

Basic system layout

- The following is an example of the basic layout for a system consisting of seven speaker systems and a television monitor:

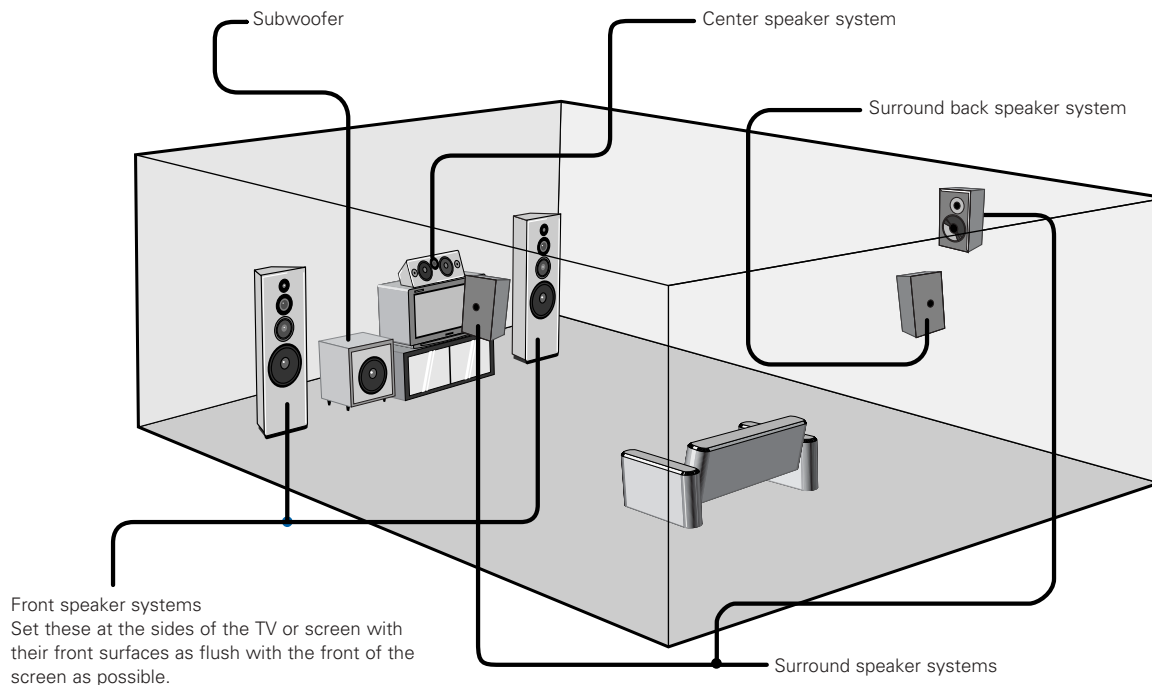

## 8 CONNECTIONS

- Do not plug in the power cord until all connections have been completed.
- Be sure to connect the left and right channels properly (left with left, right with right).
- Insert the plugs securely. Incomplete connections will result in the generation of noise.
- **Use the AC OUTLETS for audio equipment only. Do not use them for hair driers, etc.**
- Note that binding pin plug cords together with power cords or placing them near a power transformer will result in generating hum or other noise.
- Noise or humming may be generated if a connected audio equipment is used independently without turning the power of this unit on. If this happens, turn on the power of this unit.

### Connecting the audio components

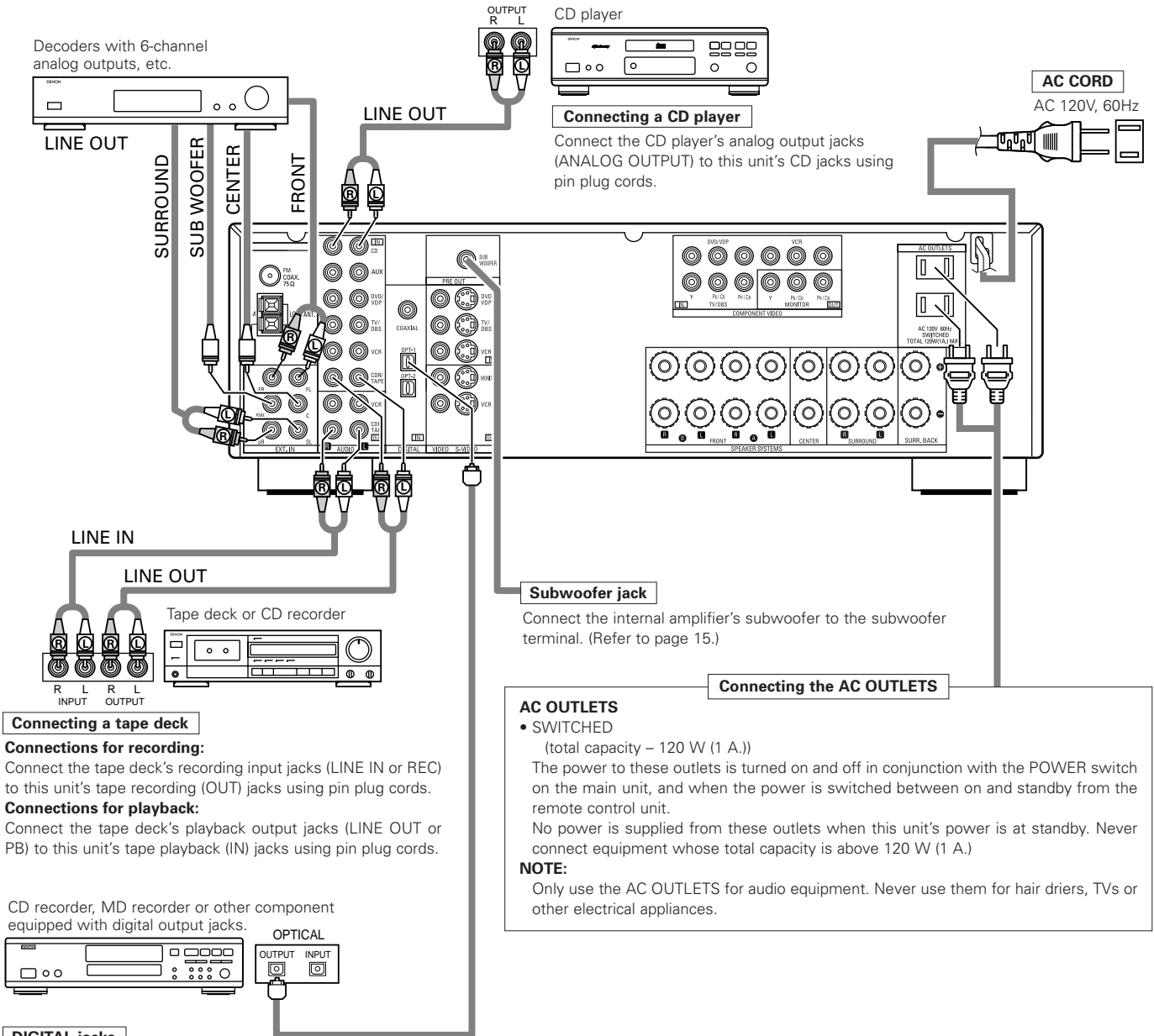

#### Connecting a tape deck

##### Connections for recording:

Connect the tape deck's recording input jacks (LINE IN or REC) to this unit's tape recording (OUT) jacks using pin plug cords.

##### Connections for playback:

Connect the tape deck's playback output jacks (LINE OUT or PB) to this unit's tape playback (IN) jacks using pin plug cords.

CD recorder, MD recorder or other component equipped with digital output jacks.

#### DIGITAL jacks

Use these for connections to audio equipment with digital output. Refer to page 26 for instructions on setting this terminal.

- Use 75  $\Omega$ /ohms cable pin cords (sold separately) for coaxial connections.
- Use optical cables (sold separately) for optical connections.

#### Connecting a CD player

Connect the CD player's analog output jacks (ANALOG OUTPUT) to this unit's CD jacks using pin plug cords.

#### Subwoofer jack

Connect the internal amplifier's subwoofer to the subwoofer terminal. (Refer to page 15.)

#### Connecting the AC OUTLETS

##### AC OUTLETS

###### • SWITCHED

(total capacity – 120 W (1 A.))

The power to these outlets is turned on and off in conjunction with the POWER switch on the main unit, and when the power is switched between on and standby from the remote control unit.

No power is supplied from these outlets when this unit's power is at standby. Never connect equipment whose total capacity is above 120 W (1 A.)

###### NOTE:

Only use the AC OUTLETS for audio equipment. Never use them for hair driers, TVs or other electrical appliances.

## Connecting the video equipments

To connect the video signal, connect using a 75 Ω/ohms video signal cable cord. Using an improper cable can result in a drop in sound quality.

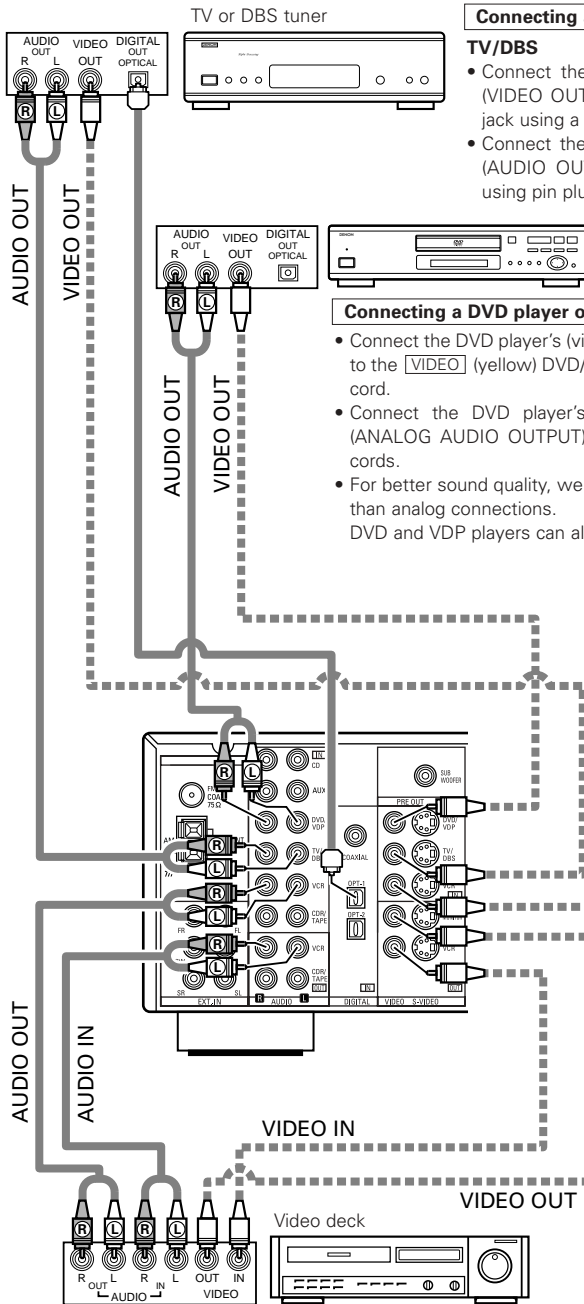

### Connecting a TV/DBS tuner

#### TV/DBS

- Connect the TV's or DBS tuner's video output jack (VIDEO OUTPUT) to the VIDEO (yellow) TV/DBS IN jack using a 75 Ω/ohms video coaxial pin plug cord.
- Connect the TV's or DBS tuner's audio output jacks (AUDIO OUTPUT) to the AUDIO TV/DBS IN jacks using pin plug cords.

### Connecting a DVD player or a video disc player (VDP)

- Connect the DVD player's (video disc player's) video output jack (VIDEO OUTPUT) to the VIDEO (yellow) DVD/VDP IN jack using a 75 Ω/ohms video coaxial pin plug cord.
- Connect the DVD player's (video disc player's) analog audio output jacks (ANALOG AUDIO OUTPUT) to the AUDIO DVD/VDP IN jacks using pin plug cords.
- For better sound quality, we recommend using the DVD player with digital rather than analog connections. DVD and VDP players can also be connected to the VCR terminals.

### MONITOR OUT

- Connect the TV's video input jack (VIDEO INPUT) to the VIDEO MONITOR OUT jack using a 75 Ω/ohms video coaxial pin plug cord.

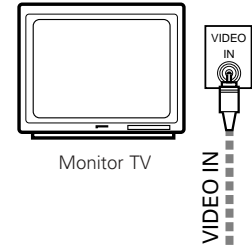

**NOTE:**  
 Connection of the video disc Player Equipped with Dolby Digital RF Output jack.  
 • Please use a commercially available adaptor when connecting the Dolby Digital RF output jack of the video disc player to the digital input jack. Please refer to the instruction manual of the adaptor when making connections.

### Connecting a video decks

#### Video input/output connections:

- Connect the video deck's video output jack (VIDEO OUT) to the VIDEO (yellow) VCR IN jack, and the video deck's video input jack (VIDEO IN) to the VIDEO (yellow) VCR OUT jack using 75 Ω/ohms video coaxial pin plug cords.

#### Connecting the audio output jacks:

- Connect the video deck's audio output jacks (AUDIO OUT) to the AUDIO VCR IN jacks, and the video deck's audio input jacks (AUDIO IN) to the AUDIO VCR OUT jacks using pin plug cords.

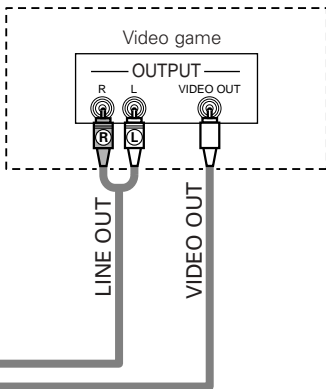
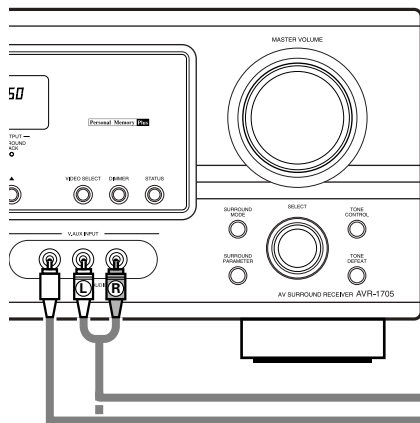

**Connecting a Video game equipment**

- Connect the Video game equipment's output jacks to this unit's V. AUX INPUT jacks.

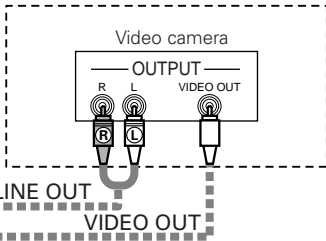

**Connecting a Video camera equipment**

- Connect the video camera equipment's output jacks to this unit's V. AUX INPUT jacks.

※ The V. AUX terminal is covered with a cap. Remove this cap in order to use the terminal. (See page 4 for instructions on removing the cap.)

**Connecting a video component equipped with S-video jacks**

- When marking connections, also refer to the operating instructions of the other components.
- **A note on the S input jacks**  
The input selectors for the S inputs and pin jack inputs work in conjunction with each other.
- **Precaution when using S-jacks**

This unit's S-jacks (input and output) and video pin jacks (input and output) have independent circuit structures, so that video signals input from the S-jacks are only output from the S-jack outputs and video signals input from the pin jacks are only output from the pin jack outputs. When connecting this unit with equipment that is equipped with S-jacks, keep the above point in mind and make connections according to the equipment's instruction manuals.

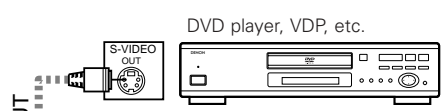

**Connecting a DVD player or video disc player (VDP)**

- Connect the DVD player's or video disc player's S-video output jack to the S-VIDEO DVD/VDP IN jack using an S-video connection cord.



**Connecting a monitor TV**

- Connect the TV's or DBS tuner's S video input (S-VIDEO INPUT) to the [S-VIDEO] MONITOR OUT jack using a S jack connection cord.

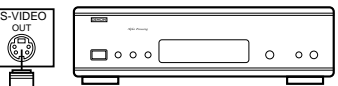

**Connecting a TV/DBS tuner**

- Connect the TV's or DBS tuner's S-video output jack (S-VIDEO OUTPUT) to the [S-VIDEO] TV/DBS IN jack using an S jack connection cord.

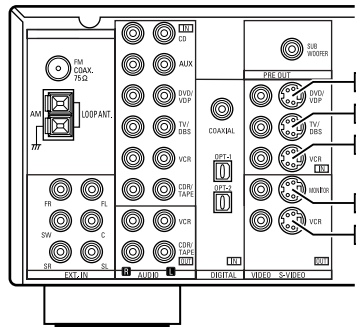

**Connecting the video decks**

- Connect the video deck's S output jack (S-OUT) to the [S-VIDEO] VCR IN jack and the video deck's S input jack (S-IN) to the [S-VIDEO] VCR OUT jack using S jack connection cords.

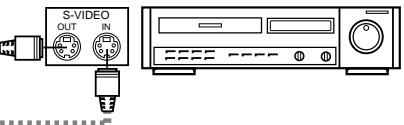

Connect the components' audio inputs and outputs as described on page 11.

## Connecting the Video Component Equipped with Color Difference (Component - Y, Pr/Cr, Pb/Cb) Video Jacks

- When making connections, also refer to the operating instructions of the other components.
- The signals input to the color difference (component) video jacks are not outputs to the VIDEO output jack (yellow) or the S-Video output jack.
- Some video sources with component video outputs are labeled Y, Cb, Cr or Y, Pb, Pr or Y, R-Y, B-Y. These terms all refer to component video color difference output.

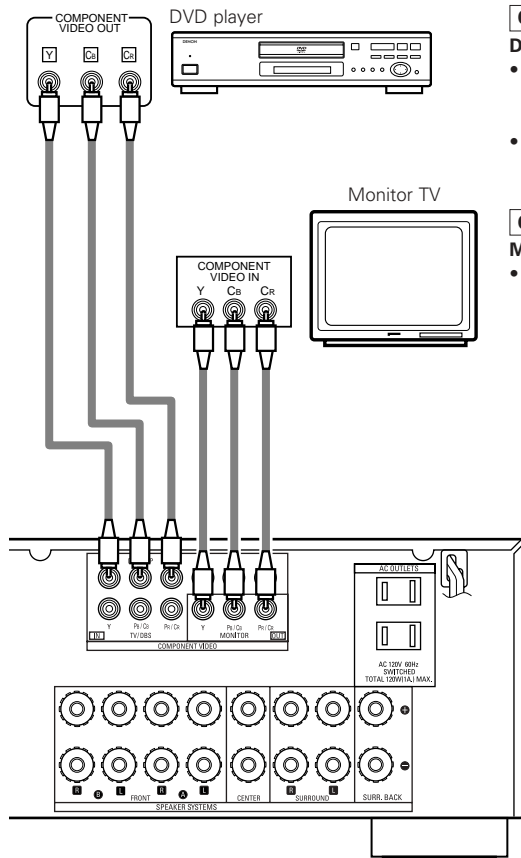

### Connecting a DVD player

#### DVD IN jacks

- Connect the DVD player's color difference (component) video output jacks (COMPONENT VIDEO OUTPUT) to the COMPONENT DVD IN jack using 75 Ω/ohms coaxial video pin-plug cords.
- In the same way, another video source with component video outputs such as a TV/DBS tuner, etc., can be connected to the TV/DBS color difference (component) video jacks.

### Connecting a monitor TV

#### MONITOR OUT jack

- Connect the TV's color difference (component) video input jacks (COMPONENT VIDEO INPUT) to the COMPONENT MONITOR OUT jack using 75 Ω/ohms coaxial video pin-plug cords.

• The color difference input jacks may be indicated differently on some TVs, monitors or video components ("Cr, Cb and Y", "R-Y, B-Y and Y", "Pr, Pb and Y", etc.). For details, carefully read the operating instructions included with the TV or other component.

### MONITOR OUT jacks

The AVR-1705/685 is equipped with a function for up-converting video signals. Because of this, the AVR-1705/685's MONITOR OUT jack can be connected to the monitor (TV) with a set of cables offering a higher quality connection, regardless of how the player and the AVR-1705/685's video input jacks are connected.

Generally speaking, connections using the component video jacks offer the highest quality playback, followed by connections using the S-Video jacks, then connections using regular video jacks (yellow).

### NOTE:

Down-converting from the component video signal to the S-Video and composite video signal is not possible, so when not using the component video monitor output terminal connect the player using the S-Video or composite video input terminal.

### Cautions on the video conversion function:

When the component video terminals are used to connect the AVR-1705/685 with a TV (or monitor, projector, etc.) and the video (yellow) or S-Video terminals are used to connect the AVR-1705/685 with a VTR, depending on the combination of the TV and VTR the picture may flicker in the horizontal direction, be distorted, be out of sync not display at all when playing video tapes. If this happens, connect a commercially available video stabilizer, etc., with a TBC (time base corrector) function between the AVR-1705/685 and the VTR, or if your VTR has a TBC function, turn it on.

## The Video Conversion Function

With the AVR-1705/685, the Video signal and the S-video signal which were inputted are converted mutually. And also the Video signal and the S-Video signal which were inputted are converted into a higher quality.

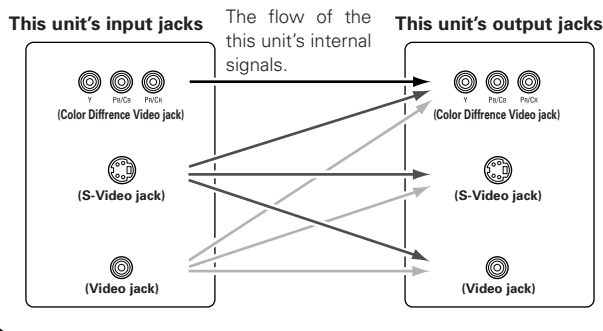

## Connecting the antenna terminals

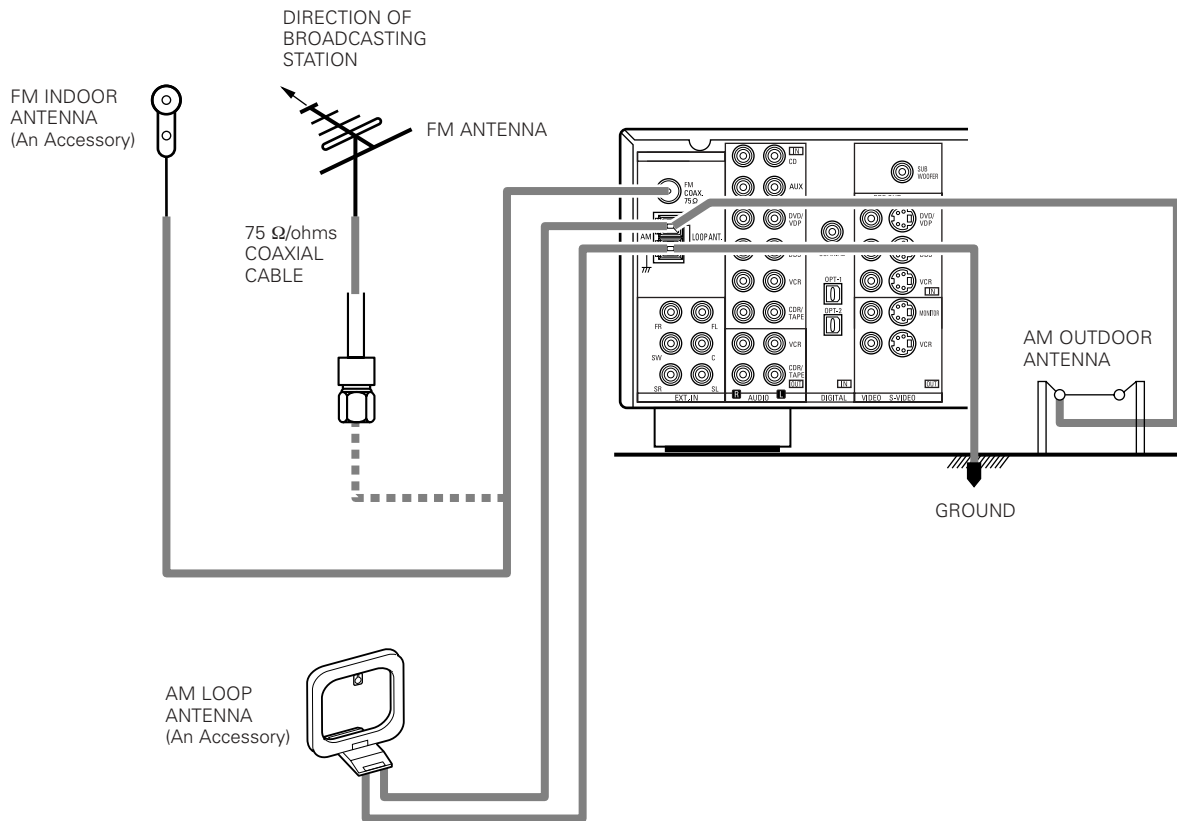

### AM loop antenna assembly

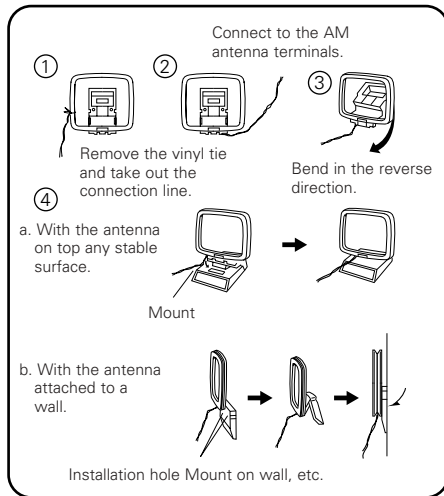

### Connection of AM antennas

1. Push the lever.
2. Insert the conductor.
3. Return the lever.

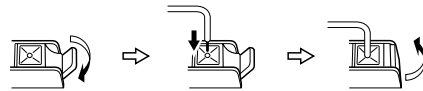

#### Note to CATV system installer:

This reminder is provided to call the CATV system installer's attention to Article 820-40 of the NEC which provides guidelines for proper grounding and, in particular, specifies that the cable ground shall be connected to the grounding system of the building, as close to the point of cable entry as practical.

#### NOTES:

- Do not connect two FM antennas simultaneously.
- Even if an external AM antenna is used, do not disconnect the AM loop antenna.
- Make sure AM loop antenna lead terminals do not touch metal parts of the panel.

## Speaker system connections

- Connect the speaker terminals with the speakers making sure that like polarities are matched (⊕ with ⊕, ⊖ with ⊖). Mismatching of polarities will result in weak central sound, unclear orientation of the various instruments, and the sense of direction of the stereo being impaired.
- When making connections, take care that none of the individual conductors of the speaker cord come in contact with adjacent terminals, with other speaker cord conductors, or with the rear panel.

**NOTE:**  
**NEVER touch the speaker terminals when the power is on.**  
**Doing so could result in electric shocks.**

### Speaker Impedance

- When speaker systems A and B are use separately, speakers with an impedance of 6 to 16 Ω/ohms can be connected for use as front speakers.
- Be careful when using two pairs of front speakers (A + B) at the same time, since use of speakers with an impedance of 12 to 16 Ω/ohms.
- Speakers with an impedance of 6 to 16 Ω/ohms can be connected for use as center and surround and surround back speakers.
- The protector circuit may be activated if the set is played for long periods of time at high volumes when speakers with an impedance lower than the specified impedance are connected.

### Connecting the speaker cords

1. Loosen by turning counterclockwise.



2. Insert the cord.



3. Tighten by turning clockwise.



### Connecting banana plugs

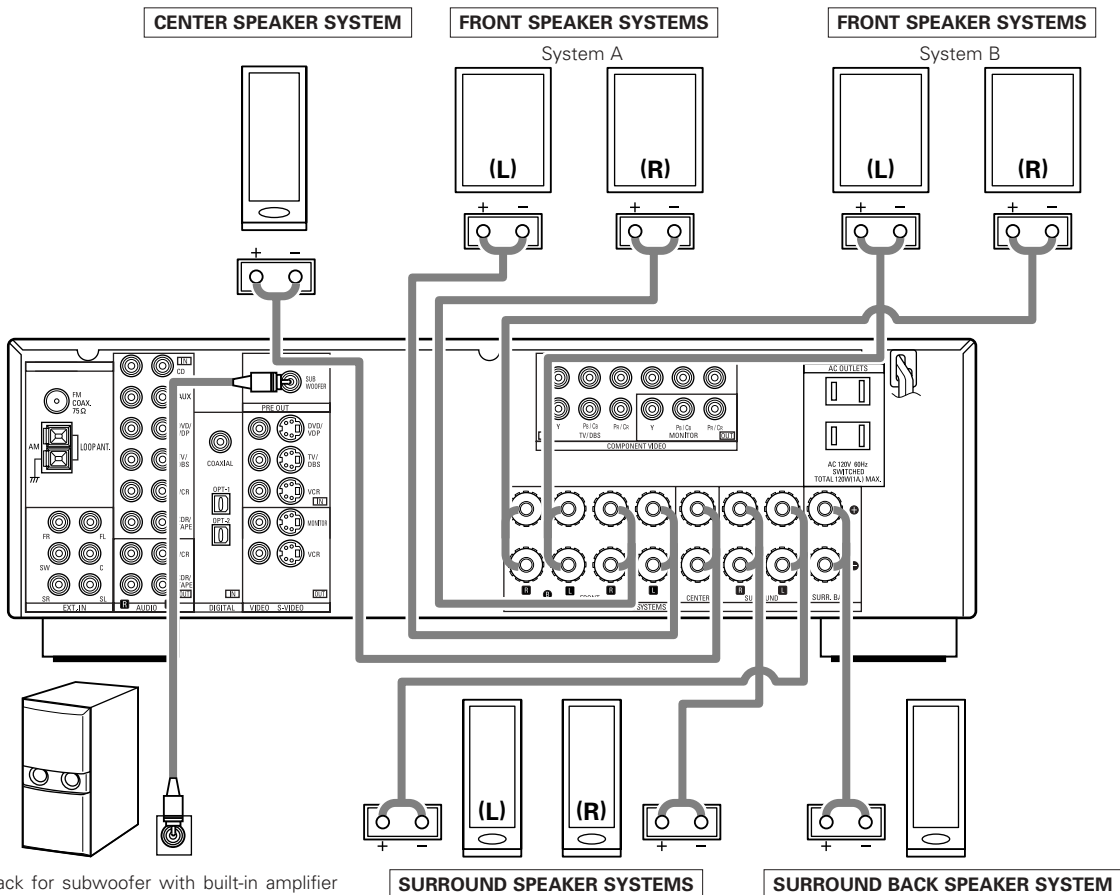
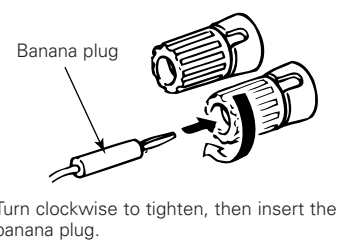

Connection jack for subwoofer with built-in amplifier (super woofer), etc.

※ To achieve Dolby Digital playback effect, use a unit that can sufficiently reproduce frequencies of under 80 Hz.

### Precautions when connecting speakers

If a speaker is placed near a TV or video monitor, the colors on the screen may be disturbed by the speaker's magnetism. If this should happen, move the speaker away to a position where it does not have this effect.

### Protector circuit

- This unit is equipped with a high-speed protection circuit. The purpose of this circuit is to protect the speakers under circumstances such as when the output of the power amplifier is inadvertently short-circuited and a large current flows, when the temperature surrounding the unit becomes unusually high, or when the unit is used at high output over a long period which results in an extreme temperature rise.

When the protection circuit is activated, the speaker output is cut off and the power supply indicator LED flashes. Should this occur, please follow these steps: be sure to switch off the power of this unit, check whether there are any faults with the wiring of the speaker cables or input cables, and wait for the unit to cool down if it is very hot. Improve the ventilation condition around the unit and switch the power back on.

If the protection circuit is activated again even though there are no problems with the wiring or the ventilation around the unit, switch off the power and contact a DENON service center.

### Note on speaker impedance

- The protector circuit may be activated if the set is played for long periods of time at high volumes when speakers with an impedance lower than the specified impedance (for example speakers with an impedance of lower than 4  $\Omega$ /ohms) are connected. If the protector circuit is activated, the speaker output is cut off. Turn off the set's power, wait for the set to cool down, improve the ventilation around the set, then turn the power back on.



## 9 USING THE REMOTE CONTROL UNIT

Following the procedure outlined below, insert the batteries before using the remote control unit.

### Range of operation of the remote control unit

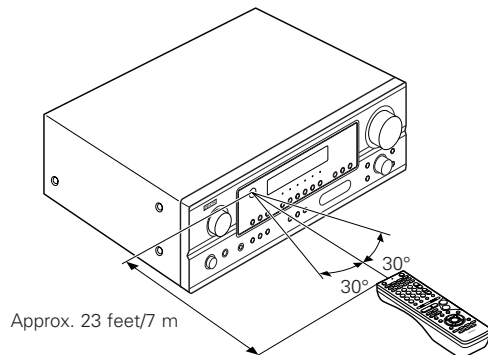

Point the remote control unit at the remote control sensor as shown on the diagram at the left.

#### NOTES:

- The remote control unit can be used from a straight distance of approximately 23 feet/7 meters, but this distance will shorten or operation will become difficult if there are obstacles between the remote control unit and the remote control sensor, if the remote control sensor is exposed to direct sunlight or other strong light, or if operated from an angle.
- Neon signs or other devices emitting pulse-type noise nearby may result in malfunction, so keep the set as far away from such devices as possible.

### Inserting the batteries

① Press as shown by the arrow and slide off.

② Insert the R6P/AA batteries properly, as shown on the diagram.

③ Close the lid.

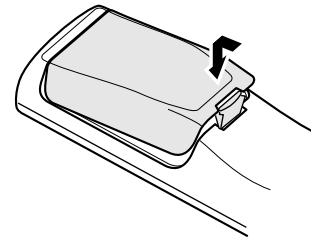
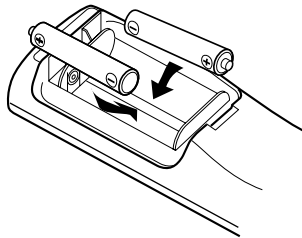
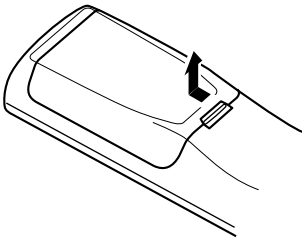

#### NOTES:

- Use only R6P/AA batteries for replacement.
- Be sure the polarities are correct. (See the illustration inside the battery compartment.)
- Remove the batteries if the remote control transmitter will not be used for an extended period of time.
- If batteries leak, dispose of them immediately. Avoid touching the leaked material or letting it come in contact with clothing, etc. Clean the battery compartment thoroughly before installing new batteries.
- Have replacement batteries on hand so that the old batteries can be replaced as quickly as possible when the time comes.
- Even if less than a year has passed, replace the batteries with new ones if the set does not operate even when the remote control unit is operated nearby the set. (The included battery is only for verifying operation. Replace it with a new battery as soon as possible.)

## 10 SETTING UP THE SYSTEM

- Once all connections with other AV components have been completed as described in "CONNECTIONS" (see pages 10 to 16), make the various settings described below on the display. These settings are required to set up the listening room's AV system centered around the this unit.

**1** Set the slide switch to "AUDIO".

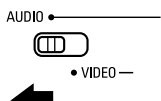

**2** Use the following buttons to set up the system:

**SYSTEM SETUP button**

Press this to display the system setup on the display.

**CURSOR buttons (▲, ▼, ◀, ▶)**

Press this change what appears on the display.

**ENTER button**

Press this to switch the display. Also use this button to complete the setting.

- System setup items and default values (set upon shipment from the factory)

System setup		Default settings							
Speaker Configuration	Input the combination of speakers in your system and their corresponding sizes (SMALL for regular speakers, LARGE for full-size, full-range) to automatically set the composition of the signals output from the speakers and the frequency response.	Front Sp.	Center Sp.	Surround Sp.	Surround back Sp.	Subwoofer			
		Large	Small	Small	Small	Yes			
Delay Time	This parameter is for optimizing the timing with which the audio signals are produced from the speakers and subwoofer according to the listening position.	Front L	Front R	Center	Surround L	Surround R	Surround Back	Subwoofer	
		12 ft	12 ft	12 ft	10 ft	10 ft	10 ft	12 ft	
Subwoofer Mode	This selects the subwoofer speaker for playing deep bass signals.	Subwoofer mode = Normal							
Crossover Frequency	Set the frequency (Hz) below which the bass sound of the various speakers is to be output from the subwoofer.	80 Hz							
Test Tone	This adjusts the volume of the signals output from the speakers and subwoofer for the different channels in order to obtain optimum effects.	Front L	Front R	Center	Surround L	Surround R	Surround Back	Subwoofer	
		0 dB	0 dB	0 dB	0 dB	0 dB	0 dB	0 dB	
Digital In Assignment	This assigns the digital input jacks for the different input sources.	Digital Inputs	COAXIAL	OPTICAL1	OPTICAL2				
		Input source	CD	DVD/VDP	TV/DBS				
Video Input Mode	Set the input signal to be output from the monitor output terminal.	AUTO							
Auto Surround Mode	Auto surround mode function setting.	Auto Surround Mode = ON							
Ext. In SW Level	Set the Ext. In Subwoofer channel playback level.	Ext. In SW Level = +15 dB							



**NOTE:**

- The system setup is not displayed when "HEADPHONE ONLY" is selected.

## Before setting up the system

**1** Refer to "CONNECTIONS" (pages 10 to 16) and check that all connections are correct.

**2**  Press the Power switch (button) .

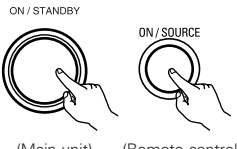

-  ON  
The power turns on and indicator is light.  
Set the power switch to this position to turn the power on and off from the included remote control unit.
-  OFF  
The power turns off and indicator is off.  
In this position, the power cannot be turned on and off from the remote control unit.

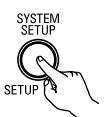
**3**  Turn on the power.  
Press the Power ON/STANDBY switch (button).

**4**  Press the SYSTEM SETUP button to enter the setting.

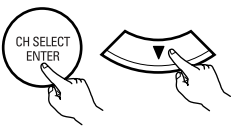

\*SYSTEM SET UP

**NOTE:** Please make sure the "AUDIO" position of the slide switch on the remote control unit.

**5**  Press the ENTER or  (down) button to switch to the speaker configuration set up.

**NOTE:** Press the SYSTEM SETUP button again to finish system set up. System set up can be finished at any time. The changes to the settings made up to that point are entered.

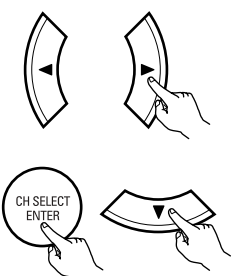
## Setting the speaker configuration

**1**  Use the  (left) and  (right) buttons to select your front speaker type.

1 FRONT LARGE

(Initial)

LARGE



SMALL

 ←

→ 

(left) button      (right) button

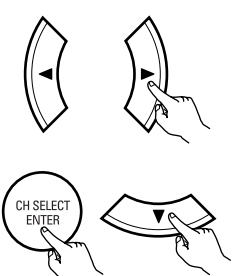
Press the ENTER or  (down) button to switch to the center speaker setting.

**2**  Use the  (left) and  (right) buttons to select your center speaker type.

2 CENTER SMALL

(Initial)

LARGE

SMALL

NONE

 ←

→ 

(left) button      (right) button

Press the ENTER or  (down) button to switch to the surround speaker setting.

**NOTE:**

- When "Small" has been selected for the front speakers, "Large" cannot be selected for the center speaker.

### 3

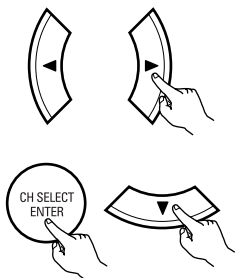

Use the (left) and (right) buttons to select your surround speaker type.

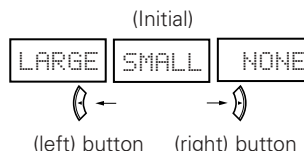
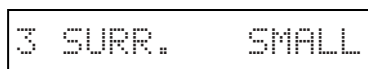

Press the ENTER or (down) button to switch to the surround back speaker setting.

**NOTE:**

- When "Small" has been selected for the front speakers, "Large" cannot be selected for the surround speakers.

### 4

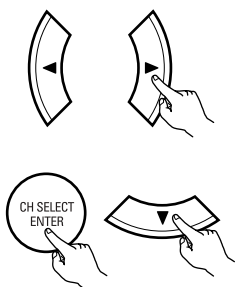

Use the (left) and (right) buttons to select your surround back speaker type.

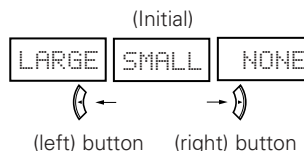
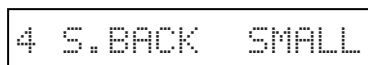

Press the ENTER or (down) button to switch to the subwoofer setting.

**NOTE:**

- When "Small" has been selected for the surround speakers, "Large" cannot be selected for the surround back speakers.

### 5

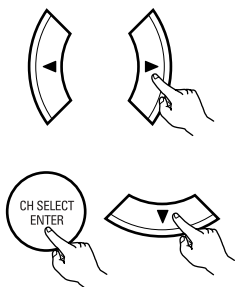

Use the (left) and (right) buttons to select your subwoofer setting.

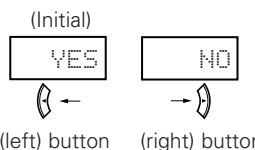
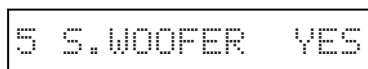

Press the ENTER or (down) button to enter the settings and switch to the Speaker Distance setting.

**Parameters**

- Large..... Select this when using speakers that have sufficient performance for reproducing bass sound below the frequency set for the Crossover Frequency mode.
- Small..... Select this when using speakers that do not have sufficient performance for reproducing bass sound below the frequency set for the Crossover Frequency mode. When this is set, bass sound with a frequency below the frequency set for the Crossover Frequency mode is sent to the subwoofer.
- None..... Select this when no speakers are installed.
- Yes/No.... Select "Yes" when a subwoofer is installed, "No" when a subwoofer is not installed.

※ If the subwoofer has sufficient low frequency playback capacity, good sound can be achieved even when "Small" is set for the front, center and surround speakers.

## Setting the delay time

- Input the distance between the listening position and the different speakers to set the delay time for the surround mode.

### Preparations:

Measure the distances between the listening position and the speakers (L1 to L5) on the diagram at the right).

- L1: Distance between center speaker and listening position
- L2: Distance between front speakers and listening position
- L3: Distance between surround speakers and listening position
- L4: Distance between surround back speaker and listening position
- L5: Distance between subwoofer and listening position

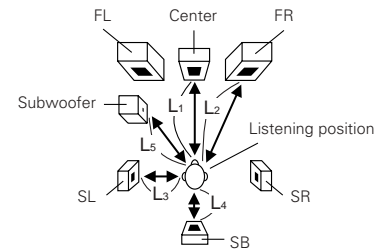

### CAUTION:

- ※ Please note that the difference for every speaker should be 15 ft or less.

### NOTE:

- No setting when "None" has been selected for the Speaker Configuration setting.

1

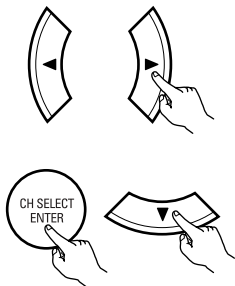

Use the (left) and (right) buttons to set the distance from the front L speaker to the listening position.

6 FRONT L 12ft

- The number changes in units of 1 foot each time one of the buttons is pressed. Select the value closest to the measured distance.

Press the ENTER or (down) button to switch to the front R speaker setting.

2

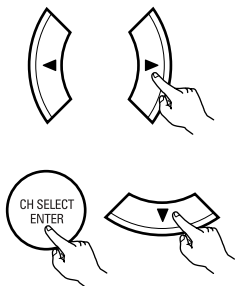

Use the (left) and (right) buttons to set the distance from the front R speaker to the listening position.

7 FRONT R 12ft

- The number changes in units of 1 foot each time one of the buttons is pressed. Select the value closest to the measured distance.

Press the ENTER or (down) button to switch to the center speaker setting.

3

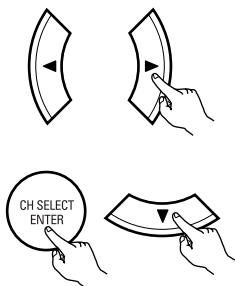

Use the (left) and (right) buttons to set the distance from the center speaker to the listening position.

8 CENTER 12ft

- The number changes in units of 1 foot each time one of the buttons is pressed. Select the value closest to the measured distance.

Press the ENTER or (down) button to switch to the surround L speakers setting.

4

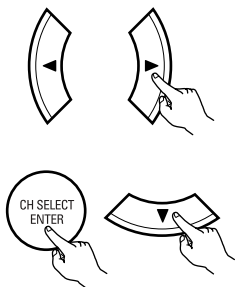

Use the (left) and (right) buttons to set the distance from the surround L speakers to the listening position.

9 SURR.L 10ft

- The number changes in units of 1 foot each time one of the buttons is pressed. Select the value closest to the measured distance.

Press the ENTER or (down) button to switch to the surround R speaker setting.

5

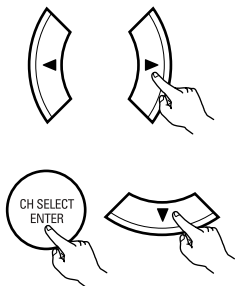

Use the (left) and (right) buttons to set the distance from the surround R speakers to the listening position.

10 SURR.R 10ft

- The number changes in units of 1 foot each time one of the buttons is pressed. Select the value closest to the measured distance.

Press the ENTER or (down) button to switch to the surround back speaker setting.

6

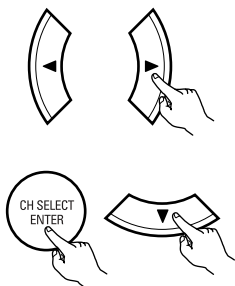

Use the (left) and (right) buttons to set the distance from the surround back speakers to the listening position.

11 S.BACK 10ft

- The number changes in units of 1 foot each time one of the buttons is pressed. Select the value closest to the measured distance.

Press the ENTER or (down) button to switch to the subwoofer setting.

7

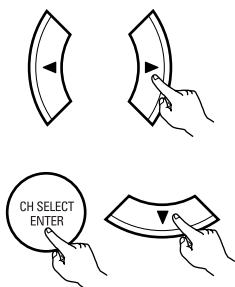

Use the (left) and (right) buttons to set the distance from the subwoofer to the listening position.

12 SW 12ft



- The number changes in units of 1 foot each time one of the buttons is pressed. Select the value closest to the measured distance.

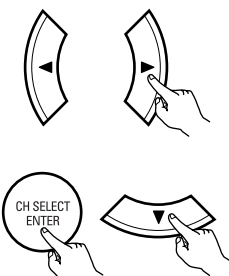

Press the ENTER or (down) button to enter the setting and switch to the Subwoofer mode setting.

## Setting the Subwoofer mode and Crossover Frequency

**1**





Use the  (left) and  (right) buttons to select the Subwoofer mode.



(Initial)  
 NORM      +MAIN  
 ←      →   
 (left) button      (right) button

Press the ENTER or  (down) button to enter the setting and switch to the Crossover Frequency setting.

**2**



Use the  (left) and  (right) buttons to select the Crossover Frequency.

(Initial)  
 40Hz   60Hz   80Hz   100Hz   120Hz   150Hz   200Hz   250Hz  
 ←      →   
 (left) button      (right) button

Press the ENTER or  (down) button to enter the setting and switch to the Test Tone setting.

**NOTES:**

— **Assignment of low frequency signal range** —

- The signals produced from the subwoofer channel are LFE signals (during playback of Dolby Digital or DTS signals) and the low frequency signal range of channels set to “SMALL” in the setup. The low frequency signal range of channels set to “LARGE” are produced from those channels.

— **Crossover Frequency** —

- When “Subwoofer” is set to “Yes” at the “Speaker Configuration Setting”, set the frequency (Hz) below which the bass sound of the various speakers is to be output from the subwoofer (the crossover frequency).
- For speakers set to “Small”, sound with a frequency below the crossover frequency is cut, and the cut bass sound is output from the subwoofer instead.

**NOTE:** For ordinary speaker systems, we recommend setting the crossover frequency to 80 Hz. When using small speakers, however, setting the crossover frequency to a high frequency may improve frequency response for frequencies near the crossover frequency.

— **Subwoofer mode** —

- The subwoofer mode setting is only valid when “LARGE” is set for the front speakers and “YES” is set for the subwoofer in the “Speaker Configuration” settings (see pages 19, 20).  
 If “SMALL” is set for the front speakers or “NO” is set for the subwoofer, the subwoofer mode setting does not affect playback of low frequency signal range.
- When the “+MAIN” playback mode is selected, the low frequency signal range of channels set to “LARGE” are produced simultaneously from those channels and the subwoofer channel.  
 In this playback mode, the low frequency range expand more uniformly through the room, but depending on the size and shape of the room, interference may result in a decrease of the actual volume of the low frequency range.
- When the “NORM” playback mode is selected, the low frequency signal range of channels set to “LARGE” are only produced from those channels. In this playback mode there tends to be little interference of the low frequency range in the room.
- Try playing the music or movie source and select the playback mode providing the stronger low frequency range sound.

## Setting the Test Tone

- Use this setting to adjust to that the playback level between the different channel is equal.
- From the listening position, listen to the test tones produced from the speakers to adjust the level.
- The level can also be adjusted directly from the remote control unit. (For details, see page 39.)

1

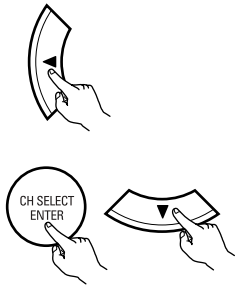

- Use the (left) button to switch the Test Tone mode.
- Press the ENTER or (down) button to switch to the DIGITAL input (COAX) setting.

15 T.TONE <YES

2

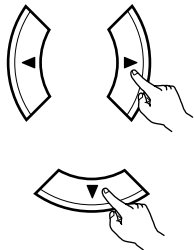

Use the (left) and (right) buttons to select the Test Tone mode.

T.TONE AUTO

(Initial)  
 AUTO      MANUAL  
 ←      →   
 (left) button      (right) button

Press the (down) button to start Test Tone.

- Auto:  
Adjust the level while listening to the test tones produced automatically from the different speakers.
- Manual:  
Select the speaker from which you want to produce the test tone to adjust the level.

3

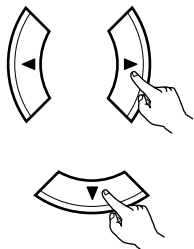

Use the (left) and (right) buttons to set the front L channel level.

AUTO-FL

(Initial)  
 -12dB      0dB      +12dB  
 ←      →   
 (left) button      (right) button

Press the (down) button to switch to the center channel level (manual mode).

4

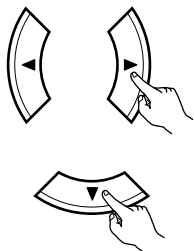

Use the (left) and (right) buttons to set the center channel level.

AUTO-C

(Initial)  
 -12dB      0dB      +12dB  
 ←      →   
 (left) button      (right) button

Press the (down) button to switch to the front R channel level (manual mode).

5

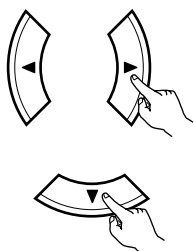

Use the (left) and (right) buttons to set the front R channel level.

AUTO-FR

(Initial)  
 -12dB      0dB      +12dB  
 ←      →   
 (left) button      (right) button

Press the (down) button to switch to the surround R channel level (manual mode).



6

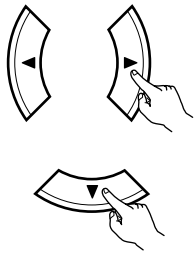

Use the (left) and (right) buttons to set the surround R channel level.

AUTO-SR

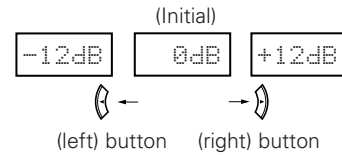

Press the (down) button to switch to the surround back channel level (manual mode).

7

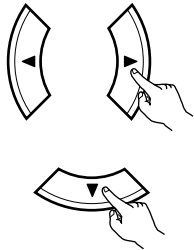

Use the (left) and (right) buttons to set the surround back channel level.

AUTO-SB

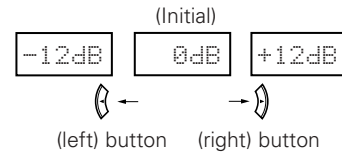

Press the (down) button to switch to the surround L channel level (manual mode).

8

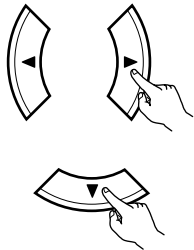

Use the (left) and (right) buttons to set the surround L channel level.

AUTO-SL

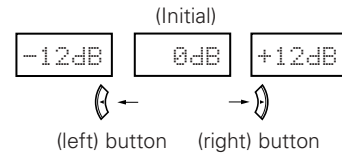

Press the (down) button to switch to the subwoofer channel level (manual mode).

9

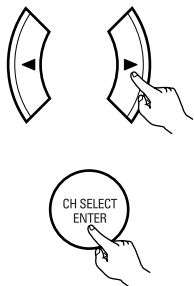

Use the (left) and (right) buttons to set the subwoofer channel level.

AUTO-SW

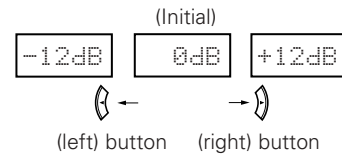

Press the ENTER button to finish the Test Tone.

10

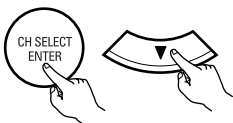



Press the ENTER or (down) button to switch the DIGITAL input (COAX) setting.

## Setting the Digital In assignment

Input the type of components connected to the digital input terminals.

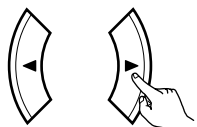
**1**





Use the  (left) and  (right) buttons to assign the input function connected to the COAXIAL input (COAXIAL) terminal.

16 COAX CD

(Initial)

CD	AUX	DVD	TV	UCR	CDR	OFF
----	-----	-----	----	-----	-----	-----

 ←      → 

(left) button      (right) button

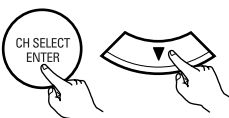

• Select "OFF" if nothing is connected.

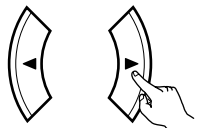

Press the ENTER or  (down) button to switch the optical input 1 (OPT 1) setting.

**2**





Use the  (left) and  (right) buttons to assign the input function connected to the optical input 1 (OPTICAL 1) terminal.

17 OPT1 DVD

(Initial)

CD	AUX	DVD	TV	UCR	CDR	OFF
----	-----	-----	----	-----	-----	-----

 ←      → 

(left) button      (right) button



• Select "OFF" if nothing is connected.

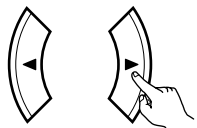

Press the ENTER or  (down) button to switch the optical input 2 (OPT 2) setting.

**3**





Use the  (left) and  (right) buttons to assign the input function connected to the optical input 2 (OPTICAL 2) terminal.

18 OPT2 TV

(Initial)

CD	AUX	DVD	TV	UCR	CDR	OFF
----	-----	-----	----	-----	-----	-----

 ←      → 

(left) button      (right) button

• Select "OFF" if nothing is connected.



Press the ENTER or  (down) button to switch the Video Input Mode setting.

**NOTE:**



- TUNER, V. AUX cannot be selected.

## Setting the Video Input Mode

Set the input signal to be output from the monitor output terminal.

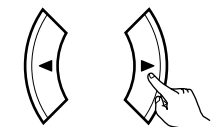
**1**





Use the  (left) and  (right) buttons to select the video input terminal.

19 DVD AUTO

(Initial)

AUTO	COMP	Svideo	video
------	------	--------	-------

 ←      → 



(left) button      (right) button

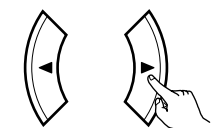

Press the ENTER or  (down) button to switch the input source (TV) setting.

**2**





Use the  (left) and  (right) buttons to select the video input terminal.

20 TV AUTO

(Initial)

AUTO	COMP	Svideo	video
------	------	--------	-------

 ←      → 



(left) button      (right) button

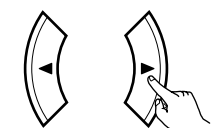

Press the ENTER or  (down) button to switch the input source (VCR) setting.

**3**





Use the  (left) and  (right) buttons to select the video input terminal.

21 VCR AUTO

(Initial)

AUTO	COMP	Svideo	video
------	------	--------	-------

 ←      → 

(left) button      (right) button



Press the ENTER or  (down) button to switch the Auto Surround Mode setting.

- AUTO: When there are multiple input signals, the input signals are detected and the input signal to be output from the video monitor output terminal is selected automatically in the following order: component video, S-Video, composite video.
- Component: The signal connected to the component video terminal is always played.  
Video conversion is not conducted, so no image is output from the monitor output terminal when there is no input signal to the component terminal.
- S-Video: The signal connected to the S-Video terminal is always played.  
The S-Video input signal is converted and output from the composite and component monitor output terminal.
- Video: The signal connected to the composite video terminal is always played.  
The composite video input signal is up-converted and output from the S-Video and component monitor output terminals.

**NOTE:**

Down-converting from the component video signal to the S-Video and composite video signal is not possible, so when not using the component video monitor output terminal connect the player using the S-Video or composite video input terminal.

**Cautions on the video conversion function:**

When the component video terminals are used to connect the AVR-1705/685 with a TV (or monitor, projector, etc.) and the video (yellow) or S video terminals are used to connect the AVR-1705/685 with a VTR, depending on the combination of the TV and VTR the picture may flicker in the horizontal direction, be distorted, be out of sync or not display at all when playing video tapes.

If this happens, connect a commercially available video stabilizer, etc., with a TBC (time base corrector) function between the AVR-1705/685 and the VTR, or if your VTR has a TBC function, turn it on.

## Setting the Auto Surround Mode

For the three kinds of input signals as shown below, the surround mode played the last is stored in the memory. At next time it the same signal inputs, the memorized surround mode is automatically selected and the signal is played.

Note that the surround mode setting is also stored separately for the different input function.

	SIGNAL	Default Auto Surround Mode
①	Analog and PCM 2-channel signals	STEREO
②	2-channel signals of Dolby Digital, DTS or other multichannel format	Dolby PLIIx Cinema
③	Multichannel signals of Dolby Digital, DTS or other multichannel format	Dolby or DTS Surround

1

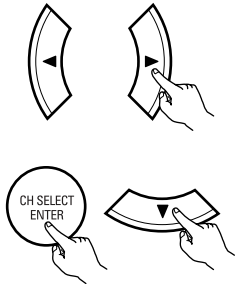

Use the (left) and (right) buttons to select the Auto Surround mode.

22 AUTOSURR. ON

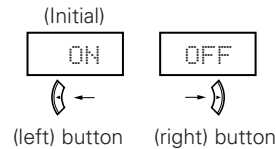

Press the ENTER or (down) button to switch the Ext. In SW Level setting.

## Setting the Ext. In SW Level

Set the method of playback of the analog input signal connected to the Ext. In terminal.

1

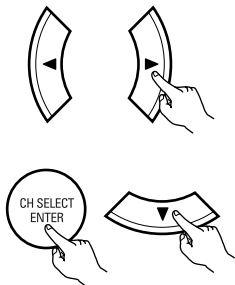

Use the (left) and (right) buttons to select the Ext. In Subwoofer channel Level playback.

23 EXT. IN SW +15

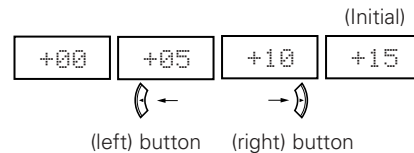

Press the ENTER or (down) button if you want to start the settings over from the beginning.

## After setting up the system

1

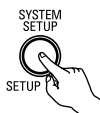

Press the SYSTEM SETUP button to finish system set up.

This completes the system setup operations. Once the system is set up, there is no need to make the settings again unless other components or speakers are connected to or the speaker layout is changed.

# 11 REMOTE CONTROL UNIT

## Operating DENON audio components

- Turn on the power of the different components before operating them.

**1** Set mode switch 1 to "AUDIO".

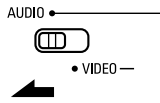

**2** Set mode switch 2 to the position for the component to be operated. (CD, CDR/MD or Tape deck)

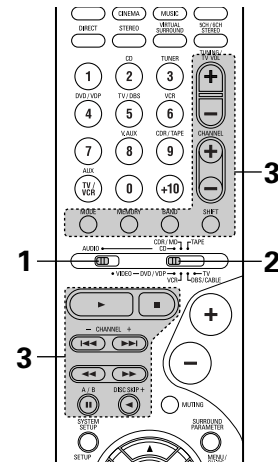
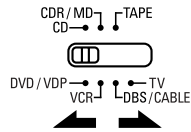

**3** Operate the audio component.

- For details, refer to the component's operating instructions.
- ※ While this remote control is compatible with a wide range of infrared controlled components, some models of components may not be operated with this remote control.

### 1. CD player (CD) and CD recorder and MD recorder (CDR/MD) system buttons

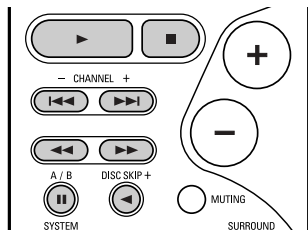

- ◀▶ : Manual search (forward and reverse)
- : Stop
- ▶ : Play
- ◀▶▶▶ : Auto search (cue)
- ⏸ : Pause
- DISC : Switch discs
- SKIP+ : (for CD changers only)

### 2. Tape deck (TAPE) system buttons

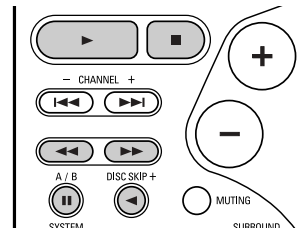

- ◀▶ : Rewind
- ▶▶▶▶ : Fast-forward
- : Stop
- ▶ : Forward play
- ◀ : Reverse play
- A/B : Switch between decks A and B

### 3. Tuner system buttons

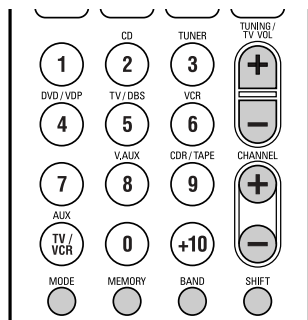

- SHIFT : Switch preset channel range
- CHANNEL : Preset channel
- + , - : up/down
- TUNING : Frequency
- + , - : up/down
- BAND : Switch between the AM and FM bands
- MODE : Switch between auto and mono
- MEMORY : Preset memory

**NOTE:**

- TUNER can be operated when the switch is at "AUDIO" position.

## Preset memory

DENON and other makes of components can be operated by setting the preset memory. This remote control unit can be used to operate components of other manufacturers by registering the manufacturer of the component as shown on the List of Preset Codes (pages 128~132). Operation is not possible for some models.

- 1** Set mode switch 1 to "AUDIO" or "VIDEO".

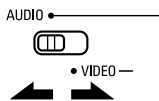

Set the AUDIO side for the CD, Tape deck or CDR/MD position, to the VIDEO side for the DVD/VDP, DBS/CABLE, VCR or TV position.

- 2** Set mode switch 2 to the component to be registered.

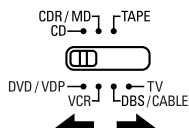

- 3** Press the ON/SOURCE button and the OFF button at the same time.



• Indicator flash.

- 4**
- |   |   |   |   |
|---|---|---|---|
| ① | ② | ③ | Referring to the included List of Preset Codes, use the number buttons to input the preset code (a 3-digit number) for the manufacturer of the component whose signals you want to store in the memory. |
| ④ | ⑤ | ⑥ |   |
| ⑦ | ⑧ | ⑨ |   |
| ⑩ |   |   |   |
|   |   |   |   |

- 5** To store the codes of another component in the memory, repeat steps 1 to 4.

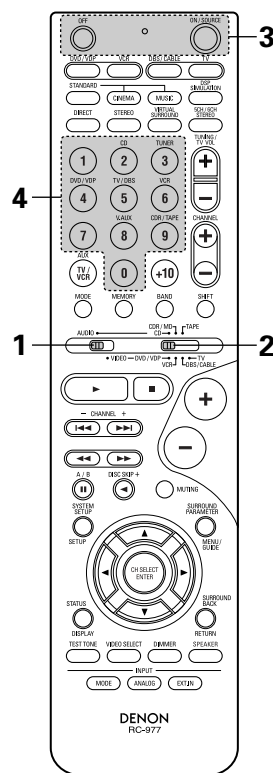

### NOTES:

- The signals for the pressed buttons are emitted while setting the preset memory. To avoid accidental operation, cover the remote control unit's transmitting window while setting the preset memory.
- Depending on the model and year of manufacture, this function cannot be used for some models, even if they are of makes listed on the included list of preset codes.
- Some manufacturers use more than one type of remote control code. Refer to the included list of preset codes to change the number and check.
- **The preset memory can be set for one component only among the following: CDR/MD, DVD/VDP and DBS/CABLE.**

The preset codes are as follows upon shipment from the factory and after resetting:

TV, VCR .....	HITACHI
CD, TAPE .....	DENON
CDR/MD .....	DENON (CDR)
DVD/VDP .....	DENON (DVD)
DBS/CABLE .....	ABC (CABLE)

# Operating component stored in the preset memory

**1** Set mode switch 1 to "AUDIO" or "VIDEO".

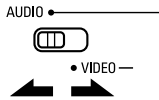

Set the AUDIO side for the CD, tape deck or CDR/MD position, to the VIDEO side for the DVD/VDP, DBS/CABLE, VCR or TV position.

**2** Set mode switch 2 to the component you want to operate.

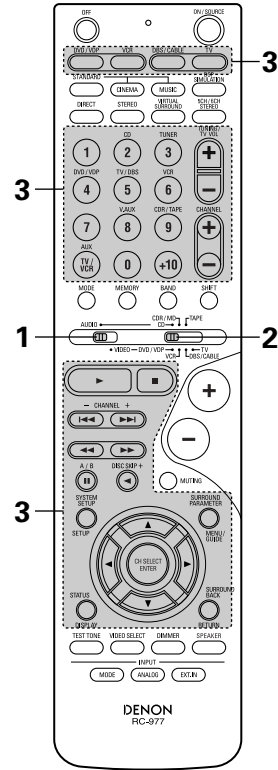
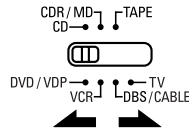

**3** Operate the component.  
 • For details, refer to the component's operating instructions.  
 ※ Some models cannot be operated with this remote control unit.

## 1. Digital video disc player (DVD) system buttons

- POWER : Power on/standby (ON/SOURCE)
- OFF : DENON DVD power off
- ◀▶▶▶ : Manual search (forward and reverse)
- : Stop
- ▶ : Play
- ◀▶▶▶ : Auto search (to beginning of track)
- || : Pause
- 0 ~ 9, +10 : 10 key skip + : Disc skip (for DVD changer only)
- DISPLAY : Switch display
- MENU : Menu
- RETURN : Return
- SETUP : Setup
- ▲, ▼, ◀, ▶ : Cursor up, down, left and right
- ENTER : Enter setting

**NOTE:**

• Some manufacturers use different names for the DVD remote control buttons, so also refer to the instructions on remote control for that component.

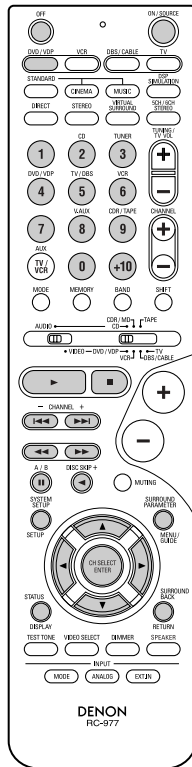

## 2. Video disc player (VDP) system buttons

- POWER : Power on/standby (ON/SOURCE)
- ◀▶▶▶ : Manual search (forward and reverse)
- : Stop
- ▶ : Play
- ◀▶▶▶ : Auto search (cue)
- || : Pause
- 0~9, +10 : 10 key

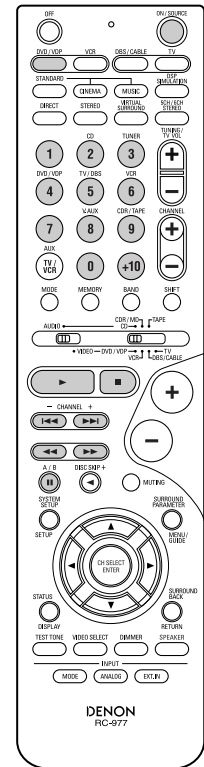





# Punch Through

- “Punch Through” is a function allowing you to operate the PLAY, STOP, MANUAL SEARCH and AUTO SEARCH buttons on the CD, TAPE, CDR/MD, DVD/VDP or VCR components when in the DBS/CABLE or TV mode. By default, nothing is set.

**1** Set mode switch 1 to “VIDEO”.

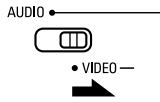

**2** Set mode switch 2 to the component to be registered (DBS/CABLE or TV).

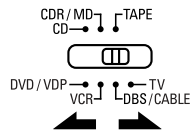

**3** Press the DVD/VDP power button and the TV power button at the same time.



- Indicator flash.

**4** Input the number of the component you want to set. (See Table 1)

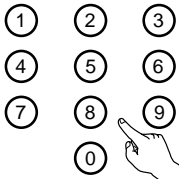

**Table 1**

	No.
CD	1
TAPE	2
CDR/MD	3
DVD/VDP	4
VCR	5
No setting	0

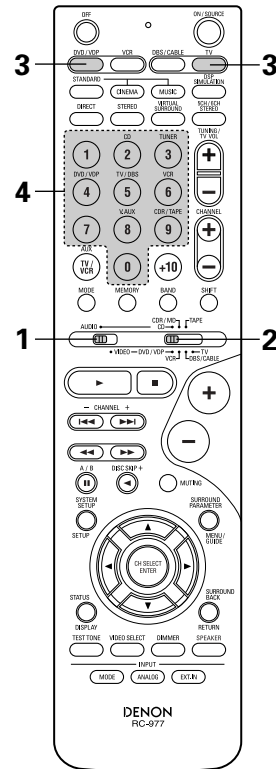

# 12 OPERATION

## Before operating

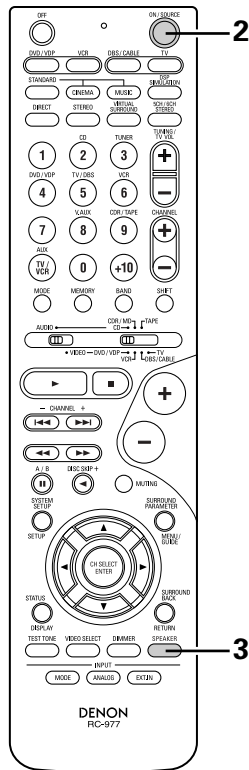
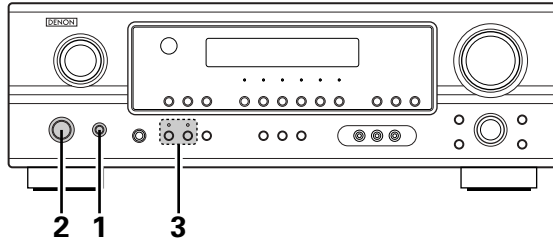

### Preparations:

Check that all connections are proper.

**1** Press the Power switch (button).



- ON**  
 The power turns on and indicator is light.  
 Set the power switch to this position to turn the power on and off from the included remote control unit.
- OFF**  
 The power turns off and indicator is off.  
 In this position, the power cannot be turned on and off from the remote control unit.

**2** Turn on the power.  
 Press the Power ON/STANDBY switch (button).

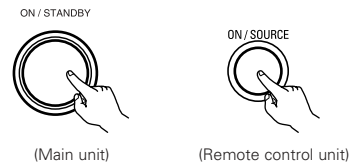

When pressed, the power turns on and the display lights. The sound is muted for several seconds, after which the unit operates normally. When pressed again, the power turns off, the standby mode is set and the display turns off.

**3** Select the front speakers.  
 Press the SPEAKER A or B button to turn the speaker on.



- The front speaker A, B setting can be also be changed with the SPEAKER button on the remote control unit.

**Playing the input source**

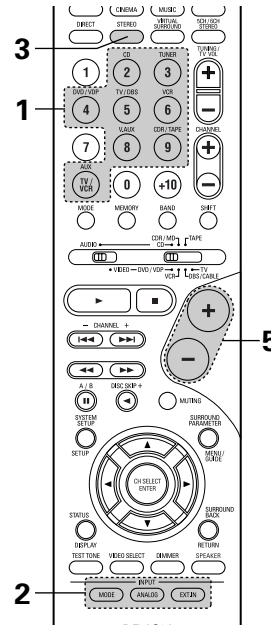
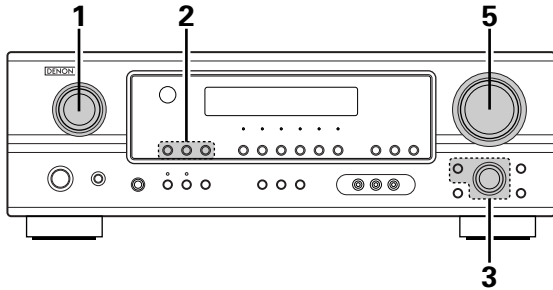

**1** Select the input source to be played.  
**Example: CD**



**2** Select the input mode.  
 • Selecting the analog mode  
 Press the ANALOG button to switch to the analog input.



• Selecting the external input (EXT. IN) mode  
 Press the EXT. IN (or the EXT. IN button on the remote control unit) to switch the external input.



• Selecting the AUTO, PCM and DTS modes  
 The mode switches as shown below each time the INPUT MODE button is pressed.

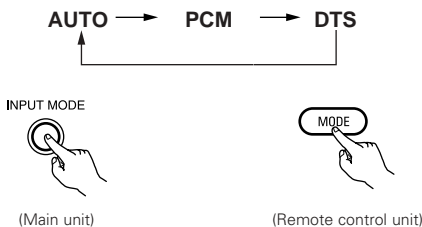

**Input mode selection function**

Different input modes can be selected for the different input sources. The selected input modes for the separate input sources are stored in the memory.

- ① AUTO (All auto mode)  
 In this mode, the types of signals being input to the digital and analog input jacks for the selected input source are detected and the program in the this unit's surround decoder is selected automatically upon playback. This mode can be selected for all input sources other than TUNER.  
 The presence or absence of digital signals is detected, the signals input to the digital input jacks are identified and decoding and playback are performed automatically in DTS, Dolby Digital or PCM (2 channel stereo) format. If no digital signal is being input, the analog input jacks are selected.  
 Use this mode to play Dolby Digital signals.
- ② PCM (exclusive PCM signal playback mode)  
 Decoding and playback are only performed when PCM signals are being input.  
 Note that noise may be generated when using this mode to play signals other than PCM signals.
- ③ DTS (exclusive DTS signal playback mode)  
 Decoding and playback are only performed when DTS signals are being input.
- ④ ANALOG (exclusive analog audio signal playback mode)  
 The signals input to the analog input jacks are decoded and played.
- ⑤ EXT. IN (external decoder input jack selection mode)  
 The signals being input to the external decoder input jacks are played without passing through the surround circuitry.

**NOTE:**

- Note that noise will be output when CDs or LDs recorded in DTS format are played in the "PCM" (exclusive PCM signal playback) or "ANALOG" (exclusive analog audio signal playback) mode. Select the AUTO or DTS (exclusive DTS signal playback) mode when playing signals recorded in DTS from a laser disc player.

**Notes on playing a source encoded with DTS**

- Noise may be generated at the beginning of playback and while searching during DTS playback in the AUTO mode. If so, play in the DTS mode.
- In some rare cases the noise may be generated when you preform the operation to stop playback of a DTS-CD or DTS-LD.

- 3** Select the play mode.  
Press the SURROUND MODE button, then turn the SELECT knob.

**Example: Stereo**

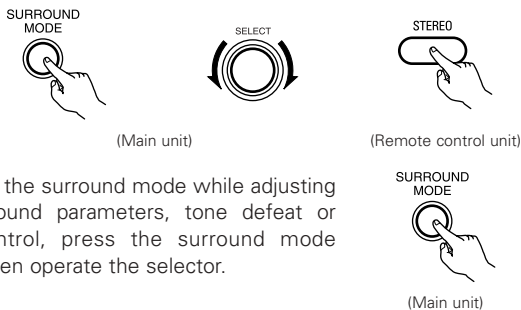

※ To select the surround mode while adjusting the surround parameters, tone defeat or tone control, press the surround mode button then operate the selector.

- 4** Start playback on the selected component.  
• For operating instructions, refer to the component's manual.

- 5** Adjust the volume.

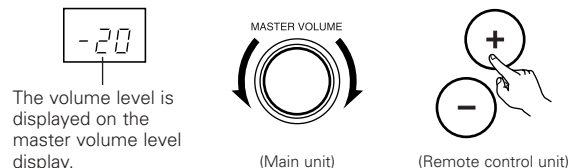

※ The volume can be adjusted within the range of -70 to 0 to 18 dB, in steps of 1 dB. However, when the channel level is set as described on page 39, if the volume for any channel is set at +1 dB or greater, the volume cannot be adjusted up to 18 dB. (In this case the maximum volume is adjusted to "18 dB — (Maximum value of channel level)".)

**Input mode when playing DTS sources**

- Noise will be output if DTS-compatible CDs or LDs are played in the "ANALOG" or "PCM" mode.
- When playing DTS-compatible sources, be sure to connect the source component to the digital input jacks (OPTICAL/COAXIAL) and set the input mode to "DTS".

**Input mode display**

- In the AUTO mode
- In the DIGITAL PCM mode
- In the DIGITAL DTS mode
- In the ANALOG mode

One of these lights, depending on the input signal.



**Input signal display**

- DOLBY DIGITAL
- DTS
- PCM

※ The **DIGITAL** indicator lights when digital signals are being input properly. If the **DIGITAL** indicator does not light, check whether the digital input component setup (page 26) and connections are correct and whether the component's power is turned on.

**NOTE:**

- The **DIGITAL** indicator will light when playing CD-ROMs containing data other than audio signals, but no sound will be heard.

**After starting playback**

**[1] Adjusting the sound quality (tone)**

- 1** The tone switches as follows each time the TONE CONTROL button is pressed.

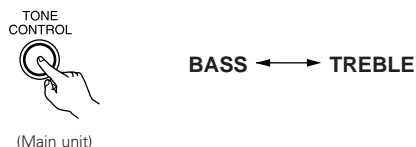

- 2** With the name of the volume to be adjusted selected, turn the SELECT knob to adjust the level.
- 

- To increase the bass or treble: Turn the control clockwise. (The bass or treble sound can be increased to up to +12 dB in steps of 2 dB.)
- To decrease the bass or treble: Turn the control counterclockwise. (The bass or treble sound can be decreased to up to -12 dB in steps of 2 dB.)

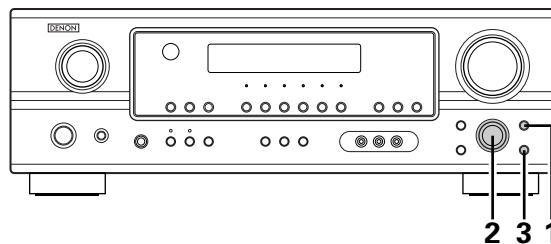

- 3** If you do not want the bass and treble to be adjusted, turn on the tone defeat mode.



※ The signals do not pass through the bass and treble adjustment circuits, so it provides higher quality sound.

**[2] Listening over headphones**

- 1** Plug the headphones' plug into the jack.
  - ※ Connect the headphones to the PHONES jack. The speaker output is automatically turned off when headphones are connected.



**NOTE:**

To prevent hearing loss, do not raise the volume level excessively when using headphones.

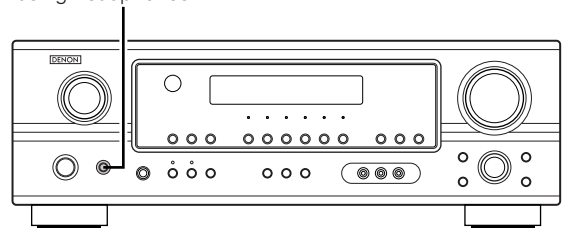

**[3] Turning the sound off temporarily (muting)**

- 1** Use this to turn off the audio output temporarily. Press the MUTING button.
  - ※ Cancelling MUTING mode.
    - Press the MUTING button again.
    - Muting will also be cancelled when MASTER VOL is adjusted up or down.

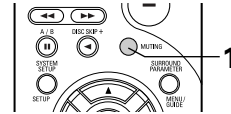

**[4] Combining the currently playing sound with the desired image**

- 1** Simulcast playback  
Use this switch to monitor a video source other than the audio source. Press the VIDEO SELECT button repeatedly until the desired source appears on the display.
  - ※ Cancelling simulcast playback.
    - Select "SOURCE" using the video select button.
    - Switch the program source to the component connected to the video input jacks.

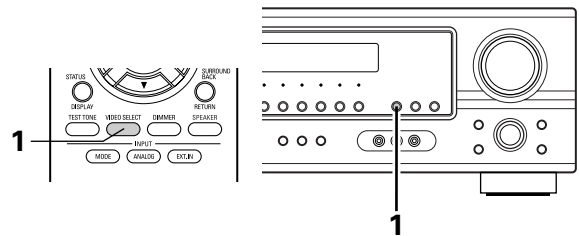
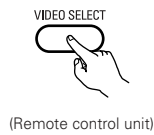

**[5] Checking the currently playing program source, etc.**

- 1** Front panel display
  - Descriptions of the unit's operations are also displayed on the front panel display. In addition, the display can be switched to check the unit's operating status while playing a source by pressing the STATUS button.

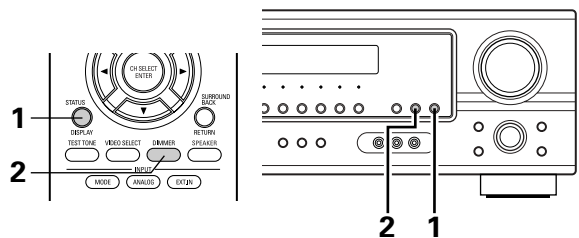
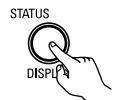

- 2** Using the dimmer function
  - Use this to change the brightness of the display. The display brightness changes in four steps (bright, medium, dim and off) by pressing the main unit's DIMMER button repeatedly.



## Playback using the external input (EXT. IN) jacks

- 1** Set the external input (EXT. IN) mode.  
Press the EXT. IN to switch the external input.

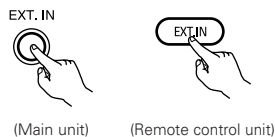

Once this is selected, the input signals connected to the FL (front left), FR (front right), C (center), SL (surround left), and SR (surround right) channels of the EXT. IN jacks are output directly to the front (left and right), center, surround (left and right) speaker systems without passing through the surround circuitry.

In addition, the signal input to the SW (subwoofer) jack is output to the PRE OUT SUBWOOFER jack.

- 2** Cancelling the external input mode  
To cancel the external input (EXT. IN) setting, press the INPUT MODE (AUTO, PCM, DTS) or ANALOG button to switch to the desired input mode. (See page 35.)

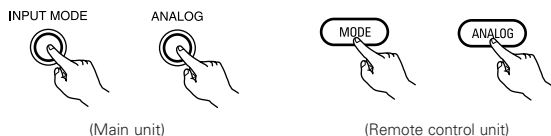

- When the input mode is set to the external input (EXT. IN), the play mode (DIRECT, STEREO, STANDARD, 5/6CH STEREO or DSP SIMULATION) cannot be selected.

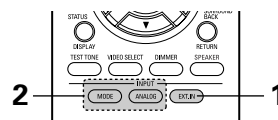
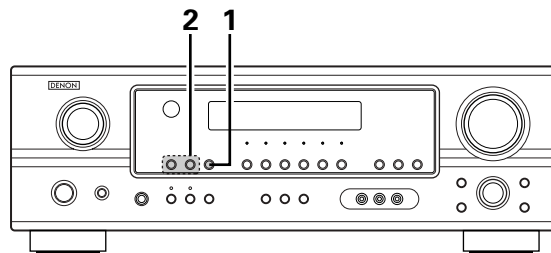

**NOTES:**

- In play modes other than the external input mode, the signals connected to EXT. IN jacks cannot be played. In addition, signals cannot be output from channels not connected to the input jacks.
- The external input mode can be set for any input source. To watch video while listening to sound, select the input source to which the video signal is connected, then set this mode.
- If the subwoofer output level seems to high, set the "SW ATT." surround parameter to "ON".

## Recording the program source (recording the source currently being monitored)

- 1** Follow step 1 to 3 under "Playing the input source".

- 2** Start recording on the tape or video deck.  
For instructions, refer to the component's operating instructions.

### Simultaneous recording

The signals of the source selected with the function selector button are output simultaneously to the CDR/TAPE and VCR REC OUT jacks. If a total of two tape and/or video decks are connected and set to the recording mode, the same source can be recorded simultaneously on every decks.

**NOTE:**

- The AUDIO IN's signal selected with the input selector knob are output to the CDR/TAPE and VCR AUDIO OUT jacks.

# 13 SURROUND

## Before playing with the surround function

- Before playing with the surround function, be sure to use the test tones to adjust the playback level from each speakers. This adjustment can be performed from the remote control unit, as (described) below.
- The adjustment with the test tones is only effective in the STANDARD (DOLBY/DTS SURROUND) modes. The adjusted playback levels for the different surround modes are automatically stored in the memory of each surround modes.

1 Set the STANDARD (DOLBY/DTS SURROUND) modes.



2 Press the TEST TONE button.

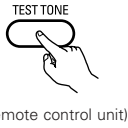

Test tones are output from the different speakers. Use the channel volume adjust buttons to adjust so that the volume of the test tones is the same for all the speakers.

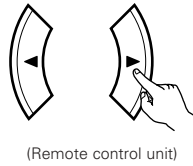

**NOTE:** Please make sure the "AUDIO" position of the slide switch on the remote control unit.

3 After completing the adjustment, press the TEST TONE button again.

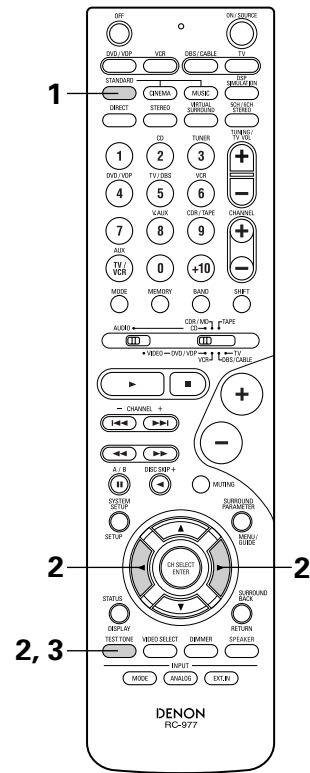
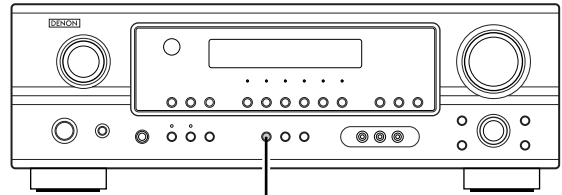
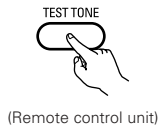

- After adjusting using the test tones, adjust the channel levels either according to the playback sources or to suit your tastes, as (described) below.

**1** Select the speaker whose level you want to adjust.



(Remote control unit)

**2** The channel switches as shown below each time the button is pressed.



(Remote control unit)

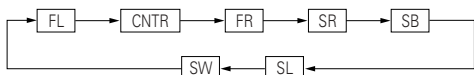

**NOTE:** Please make sure the “AUDIO” position of the slide switch on the remote control unit.

**3** Adjust the level of the selected speaker.

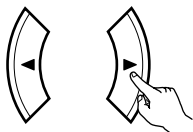

(Remote control unit)

- ※ Default setting of channel level is 0 dB.
  - ※ The level of the selected speaker can be adjusted within the range of +12 to -12 dB using cursor buttons.
  - ※ SW channel level can be turned off by decreasing one step from -12 dB.
- OFF ↔ -12 dB ↔ 12 dB

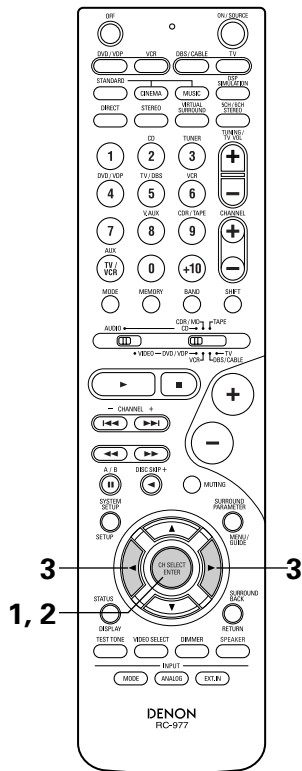



# Dolby Pro Logic IIx (Pro Logic II) mode

To play in the PL IIx mode, set "S. BACK" at the Speaker Configuration setting to "SMALL" or "LARGE".

**1** Select the function to which the component you want to play is connected.

Example: DVD

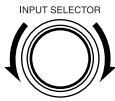

(Main unit)



(Remote control unit)

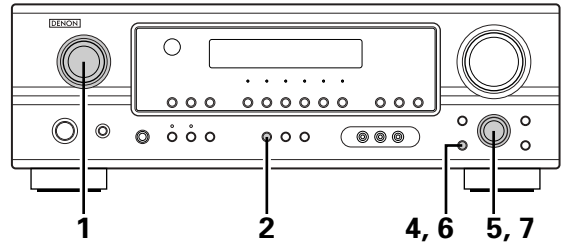

**2** Select the STANDARD (Dolby Pro Logic IIx) mode.



(Main unit)

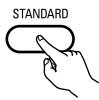

(Remote control unit)

- The Dolby Pro Logic indicator lights.

Display



Light

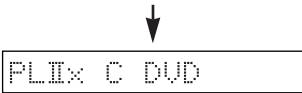

**3** Play a program source with the **DD DOLBY SURROUND** mark.

- For operating instructions, refer to the manuals of the respective components.

**4** Select the surround parameter mode.



(Main unit)



(Remote control unit)

Display

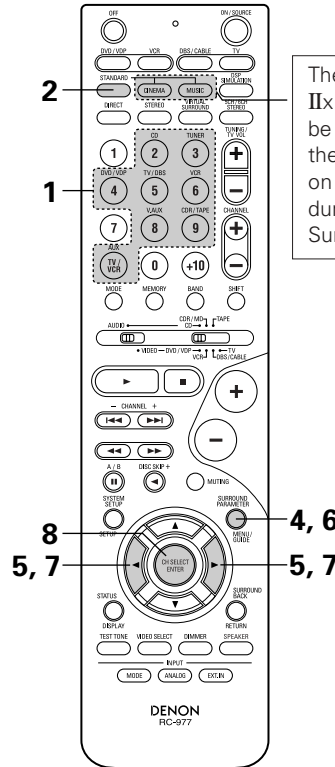
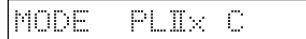

The Dolby Surround Pro Logic IIx Cinema or Music mode can be chosen directly by pressing the CINEMA or MUSIC button on the remote control unit during playback in the Dolby Surround Pro Logic IIx mode.

※ To perform this operation from the remote control unit, check that the mode selector switch is set to "AUDIO".

**5** Select the optimum mode for the source.



(Main unit)

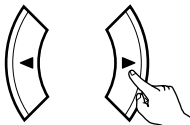

(Remote control unit)

- When the "SURROUND BACK" parameter is set to "ON". (Set "S. BACK" at system set up to "SMALL" or "LARGE".)

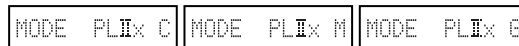

(Pro Logic IIx Cinema mode)

(Pro Logic IIx Music mode)

(Pro Logic IIx Game mode)

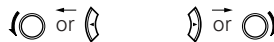

- When the "SURROUND BACK" parameter is set to "OFF". (Set "S. BACK" at system set up to "NONE".)



(Pro Logic II Cinema mode)

(Pro Logic II Music mode)

(Pro Logic II Game mode)

(Dolby Pro Logic mode)



## 6 Set the surround parameters according to the mode.

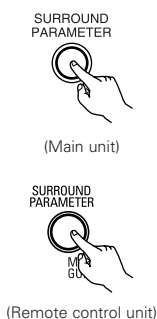

- The mode switches as shown below each time the button is pressed.

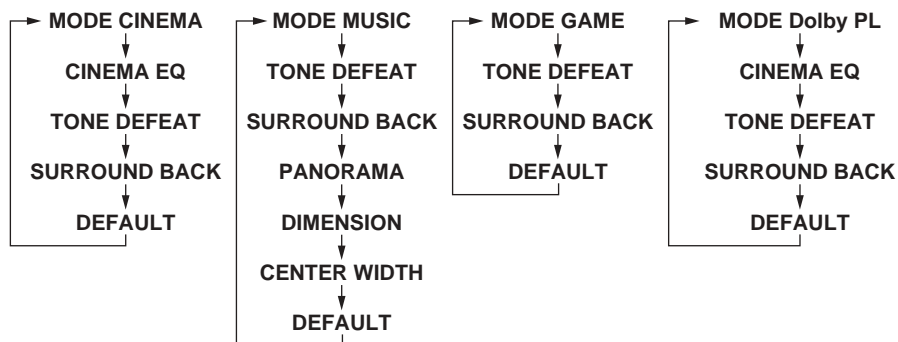

\* If you do want the bass and trable to be adjusted, turn off the tone defeat mode.

## 7 Set the various surround parameters.

### • CINEMA EQ setting

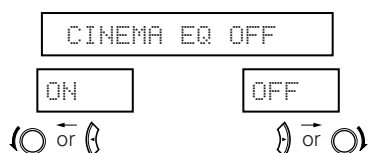

### • PANORAMA setting

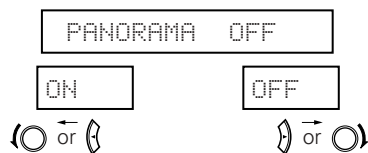

### • DIMENSION setting

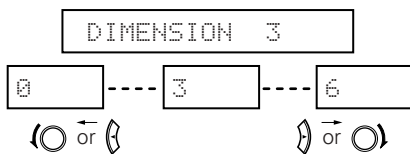

### • CENTER WIDTH setting

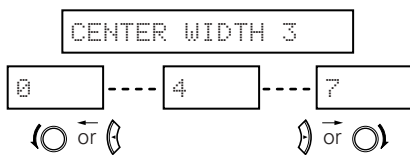

### • TONE DEFEAT setting

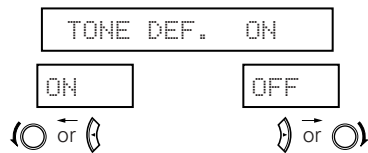

### • SURROUND BACK SPEAKER setting

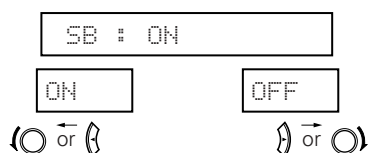

### • D. COMP. setting

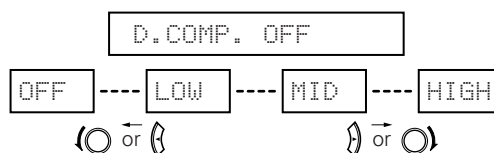

**NOTE:**

This parameter is displayed during DOLBY DIGITAL playback.

### • LFE setting

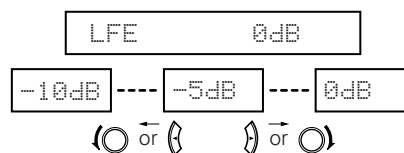

**NOTE:**

This parameter is displayed during DOLBY DIGITAL playback.

### • DEFAULT setting

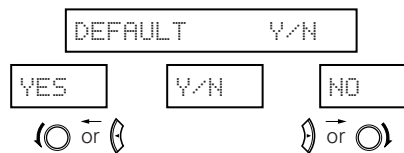

\* Select "Yes" to reset to the factory defaults.

## 8



(Remote control unit)

Press the ENTER button to finish surround parameter mode.

**NOTE:**

- When making parameter settings, the display will return to the regular condition several seconds after the last button was pressed and the setting will be completed.

# DTS NEO:6 mode

**1** Select the function to which the component you want to play is connected.

**Example: DVD**



(Main unit)



(Remote control unit)

**2** Select the DTS NEO:6 mode.



(Main unit)



(Remote control unit)

• The mode switches as shown below each time the button is pressed.

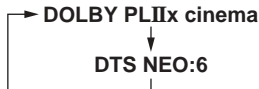

**3** Play a program source.

**4** Select the surround parameter mode.



(Main unit)



(Remote control unit)

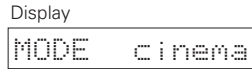

※ To perform this operation from the remote control unit, check that the mode selector switch is set to "AUDIO".

**5** Select the optimum mode for the source.



(Main unit)

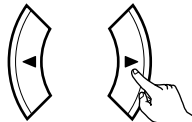

(Remote control unit)

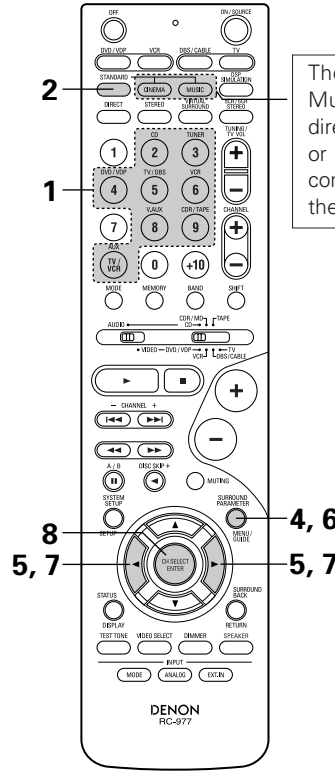
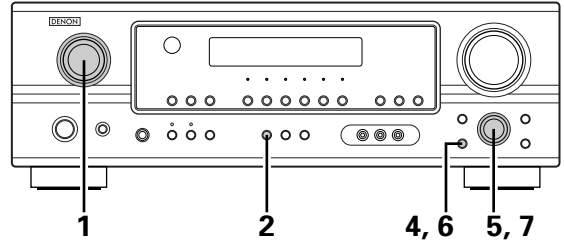
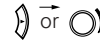
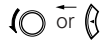

The DTS NEO:6 Cinema or Music mode can be chosen directly by pressing the CINEMA or MUSIC button on the remote control unit during playback in the DTS NEO:6 mode.

**6** Set the surround parameters according to the mode.



(Main unit)



(Remote control unit)

• The mode switches as shown below each time the button is pressed.

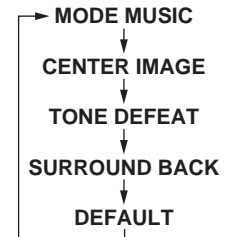
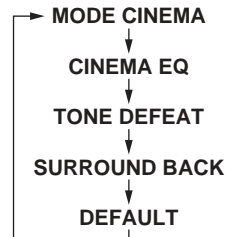

※ If you do want the bass and trable to be adjusted, turn off the tone defeat mode.

# 7

Set the various surround parameters.

• **CINEMA EQ setting**

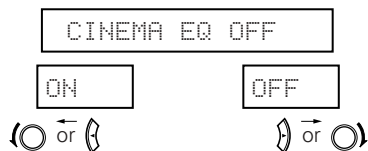

• **CENTER IMAGE setting**

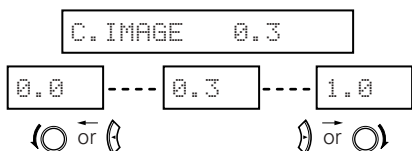

• **TONE DEFEAT setting**

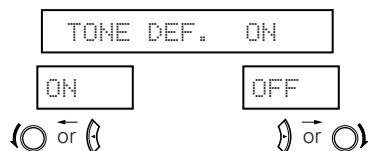

• **SURROUND BACK SPEAKER setting**

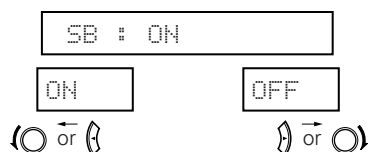

• **D. COMP. setting**

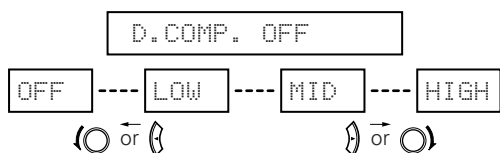

**NOTE:**  
This parameter is displayed during DOLBY DIGITAL playback.

• **LFE setting**

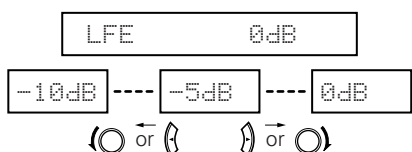

**NOTE:**  
This parameter is displayed during DOLBY DIGITAL playback.

• **DEFAULT setting**

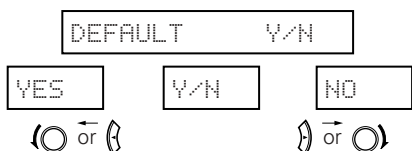

\* Select "Yes" to reset to the factory defaults.

# 8

Press the ENTER button to finish surround parameter mode.



(Remote control unit)

**NOTE:**

- When making parameter settings, the display will return to the regular condition several seconds after the last button was pressed and the setting will be completed.

**Surround parameters ①**

**Pro Logic IIx and Pro Logic II Mode:**

- The Cinema mode is for use with stereo television shows and all programs encoded in Dolby Surround.
- The Music mode is recommended as the standard mode for auto sound music systems (no video), and is optional for AV systems.
- The Pro Logic mode offers the same robust surround processing as original Pro Logic in case the source contents is not of optimum quality.
- The Game mode for playing games. The game mode can only be used with 2-channel audio sources.

Select one of the modes ("Cinema", "Music", "Pro Logic" or "Game").

**Panorama Control:**

This mode extends the front stereo image to include the surround speakers for an exciting "wraparound" effect with side wall imaging.

Select "OFF" or "ON".

**Dimension Control:**

This control gradually adjust the soundfield either towards the front or towards the rear.

The control can be set in 7 steps from 0 to 6.

**Center Width Control:**

This control adjust the center image so it may be heard only from the center speaker; only from the left/right speakers as a phantom image; or from all three front speakers to varying degrees.

The control can be set in 8 steps from 0 to 7.

**DTS NEO:6 Mode:**

• **Cinema**

This mode is optimum for playing movies. Decoding is performed with emphasis on separation performance to achieve the same atmosphere with 2-channel sources as with 6.1-channel sources.

This mode is effective for playing sources recorded in conventional surround formats as well, because the in-phase component is assigned mainly to the center channel (C) and the reversed phase component to the surround (SL, SR and SB channels).

• **Music**

This mode is suited mainly for playing music. The front channel (FL and FR) signals bypass the decoder and are played directly so there is no loss of sound quality, and the effect of the surround signals output from the center (C) and surround (SL, SR and SB) channels add a natural sense of expansion to the sound field.

**CENTER IMAGE (0.0 to 1.0: default 0.3):**

The center image parameter for adjusting the expansion of the center channel in the DTS NEO:6 MUSIC mode has been added.

**Dolby Digital mode (only with digital input) and DTS Surround (only with digital input)**

**1** Select the input source.

Playback with a digital input

① Select an input source set to digital (COAXIAL/OPTICAL) (see page 26).

**Example: DVD**

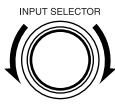

(Main unit)



(Remote control unit)

② Set the input mode to "AUTO" or DTS.

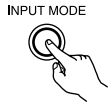

(Main unit)

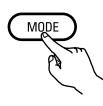

(Remote control unit)

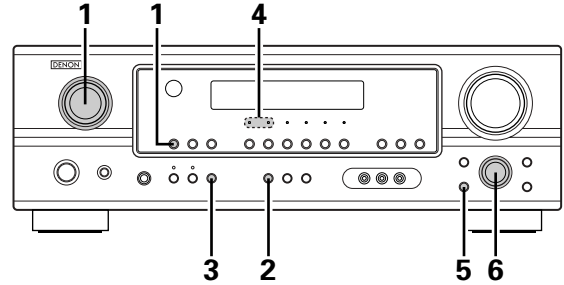

**2** Select the STANDARD (Dolby/DTS Surround) mode.



(Main unit)

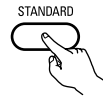

(Remote control unit)

**3** Operate the SURROUND BACK button to switch Surround Back CH ON/OFF.



(Main unit)



(Remote control unit)

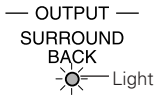

• Lights when the Surround Back CH is on.

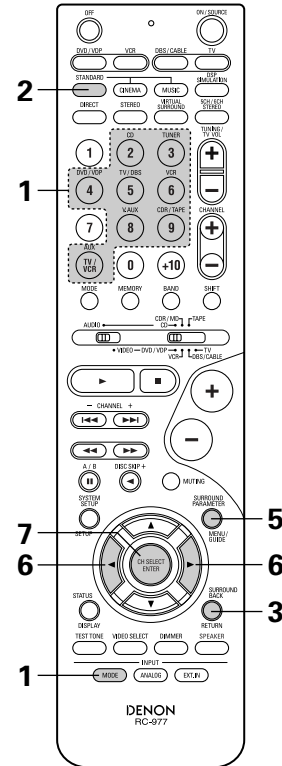

**4** Play a program source with the mark.



• The Dolby Digital indicator lights when playing Dolby Digital sources.

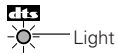

• The DTS indicator lights when playing DTS sources.

## 5 Set the surround parameter according to the source.

SURROUND  
PARAMETER



(Main unit)

SURROUND  
PARAMETER



(Remote control unit)

- The parameter switches as shown below each time the button is pressed.

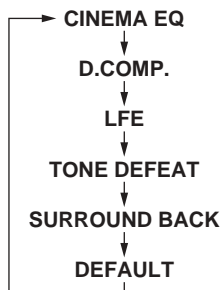

※ If you do want the bass and trable to be adjusted, turn off the tone defeat mode.

**NOTE:**

Please make sure the "AUDIO" position of the slide switch on the remote control unit.

## 6 Set the various surround parameters.

• **CINEMA EQ setting**

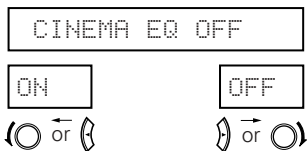

• **TONE DEFEAT setting**

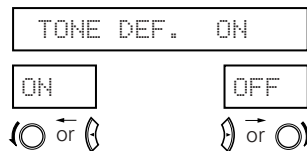

• **D. COMP. setting**

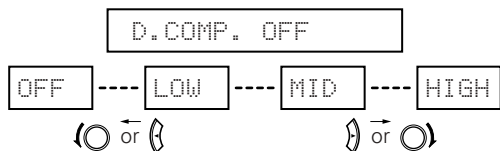

• **SURROUND BACK SPEAKER setting**

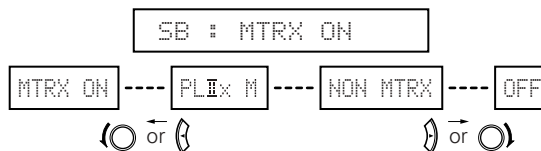

**NOTE:**

This parameter is displayed during DOLBY DIGITAL playback.

**NOTE:**

This parameter is displayed during DOLBY DIGITAL playback.

• **LFE setting**

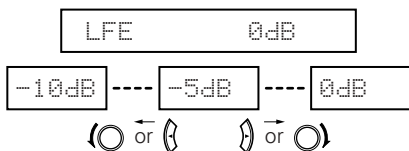

• **DEFAULT setting**

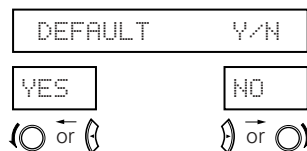

※ Select "Yes" to reset to the factory defaults.

## 7



(Remote control unit)

Press the ENTER button to finish surround parameter mode.

**NOTE:**

- When making parameter settings, the display will return to the regular condition several seconds after the last button was pressed and the setting will be completed.

## ■ Dialogue Normalization

The dialogue normalization function is activated automatically when playing Dolby Digital program sources. Dialogue normalization is a basic function of Dolby Digital which automatically normalizes the dialog level (standard level) of the signals which are recorded at different levels for different program sources, such as DVD, DTV and other future formats that will use Dolby Digital. These contents can be verified with the STATUS button.

Display

OFFSET    -    4dB

The number indicates the normalization level when the currently playing program is normalized to the standard level.

### Surround parameters ②

#### CINEMA EQ. (Cinema Equalizer):

The Cinema EQ function gently decreases the level of the extreme high frequencies, compensating for overly-bright sounding motion picture soundtracks. Select this function if the sound from the front speakers is too bright.

This function only works in the Dolby Pro Logic IIx, Dolby Digital, DTS Surround and DTS NEO:6 modes. (The same contents are set for all operating modes.)

#### D.COMP. (Dynamic Range Compression):

Motion picture soundtracks have tremendous dynamic range (the contrast between very soft and very loud sounds). For listening late at night, or whenever the maximum sound level is lower than usual, the Dynamic Range Compression allows you to hear all of the sounds in the soundtrack (but with reduced dynamic range). (This only works when playing program sources recorded in Dolby Digital or DTS.) Select one of the four parameters ("OFF", "LOW", "MID" (middle) or "HI" (high)). Set to OFF for normal listening.

#### LFE (Low Frequency Effect):

This sets the level of the LFE (Low Frequency Effect) sounds included in the source when playing program sources recorded in Dolby Digital or DTS.

If the sound produced from the subwoofer sounds distorted due to the LFE signals when playing Dolby Digital or DTS sources when the peak limiter is turned off with the subwoofer peak limit level setting (system setup menu), adjust the level as necessary.

Program source and adjustment range:

1. Dolby Digital:    -10 dB to 0 dB
2. DTS Surround:    -10 dB to 0 dB

※ When DTS encoded movie software is played, it is recommended that the LFE LEVEL be set to 0 dB for correct DTS playback.

※ When DTS encoded music software is played, it is recommended that the LFE LEVEL be set to -10 dB for correct DTS playback.

#### TONE:

This adjusts the tone control. This can be set individually for the separate shroud mode other than Direct mode.

#### SB CH OUT (Surround Back):

(1) (Multi channel source)

"OFF" .....Playback is conducted without using the surround back speaker.

"NON MTRX" .....The same signals those of the surround channels are output from the surround back channels.

"MTRX ON" .....Surround back channel is reproduced using digital matrix processing.

"ES MTRX" .....When playing DTS signals, the surround back signals undergo digital matrix processing for playback.

"ES DSCRT" .....When a signal identifying the source as a discrete 6.1-channel source is included in the DTS signals, the surround back signals included in the source are played.

"PL IIx Music" ....Processing is performed with the Music mode of the PL IIx decoder and the Surround Back channel is reproduced.

(2) (2ch source)

"OFF" .....Playback is conducted without using the surround back speaker.

"ON" .....Playback is conducted using the surround back speaker.

**NOTE:** This operation can be performed directly using the SURROUND BACK button on the main unit's panel.

## 14 DSP SURROUND SIMULATION

- This unit is equipped with a high performance DSP (Digital Signal Processor) which uses digital signal processing to synthetically recreate the sound field. One of 7 preset surround modes can be selected according to the program source and the parameters can be adjusted according to the conditions in the listening room to achieve a more realistic, powerful sound.

### Surround modes and their features

1	5CH/6CH STEREO	In this mode, the signals of the front left channel are output from the left surround channel, the signals of the front right channel are output from the right surround channel, and the same (in-phase) component of the left and right channels is output from the center channel. This mode provides all speaker surround sound, but without directional steering effects, and works with any stereo program source.
2	MONO MOVIE (NOTE 1)	Select this when watching monaural movies for a greater sense of expansion.
3	ROCK ARENA	Use this mode to achieve the feeling of a live concert in an arena with reflected sounds coming from all directions.
4	JAZZ CLUB	This mode creates the sound field of a live house with a low ceiling and hard walls. This mode gives jazz a very vivid realism.
5	VIDEO GAME	Use this to enjoy video game sources.
6	MATRIX	Select this to emphasize the sense of expansion for music sources recorded in stereo. Signals consisting of the difference component of the input signals (the component that provides the sense of expansion) processed for delay are output from the surround channel.
7	VIRTUAL	Select this mode to enjoy a virtual sound field, produced from the front 2-channel speakers.

- ※ Depending on the program source being played, the effect may not be very noticeable.  
In this case, try other surround modes, without worrying about their names, to create a sound field suited to your tastes.

NOTE 1: When playing sources recorded in monaural, the sound will be one-sided if signals are only input to one channel (left or right), so input signals to both channels. If you have a source component with only one audio output (monophonic camcorder, etc.) obtain a "Y" adaptor cable to split the mono output to two outputs, and connect to the L and R inputs.

#### Personal Memory Plus

This set is equipped with a personal memorize function that automatically memorizes the surround modes and input modes selected for the input different sources. When the input source is switched, the modes set for that source last time it was used are automatically recalled.

- ※ The surround parameters, tone control settings and playback level balance for the different output channels are memorized for each surround mode.



## DSP surround simulation

- To operate the surround mode and surround parameters from the remote control unit.

**1** Select the surround mode for the input channel.

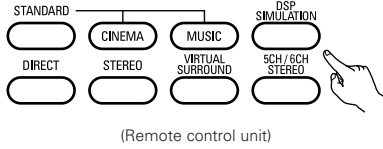

The surround mode switches in the following order each time the DSP SIMULATION button is pressed:



**2** To enter the surround parameter setting mode, press the SURROUND PARAMETER button.

- The surround parameter switches in the following order each time the SURROUND PARAMETER button is pressed for the different surround modes.

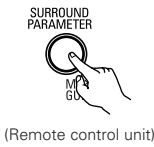

- MONO MOVIE
- ROCK ARENA
- JAZZ CLUB
- VIDEO GAME

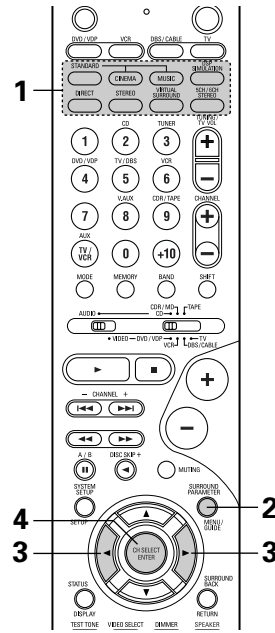
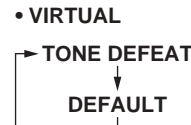
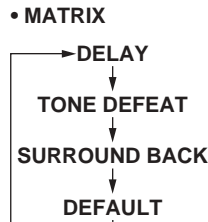
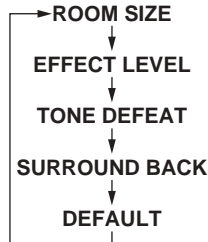

※ If you do want the bass and trable to be adjusted, turn off the tone defeat mode.

**3** Set the various surround parameters.

• ROOM SIZE setting

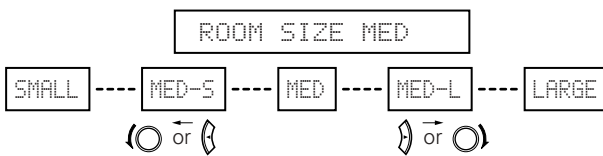

• EFFECT LEVEL setting

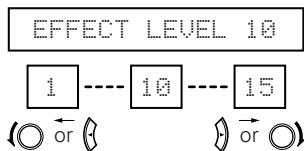

• DELAY TIME setting

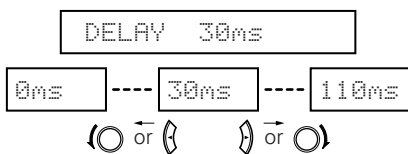

• D. COMP. setting

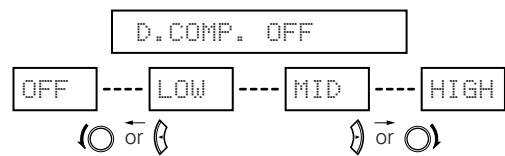

NOTE:

This parameter is displayed during DOLBY DIGITAL playback.

• LFE setting

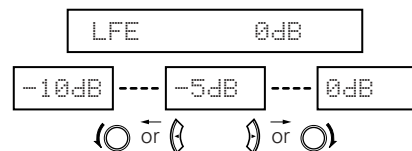

NOTE:

This parameter is displayed during DOLBY DIGITAL and DTS playback.

• TONE DEFEAT setting

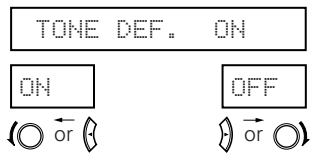

• SURROUND BACK SPEAKER setting

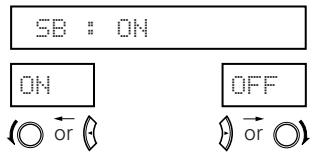

• DEFAULT setting

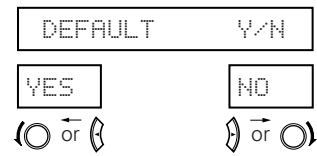

※ Select "Yes" to reset to the factory defaults.

4



(Remote control unit)

Press the ENTER button to finish surround parameter mode.

**NOTE:**

- When making parameter settings, the display will return to the regular condition several seconds after the last button was pressed and the setting will be completed.

- Operating the surround mode and surround parameters from the main unit's panel.

**1** Turn the SELECT knob to select the surround mode.

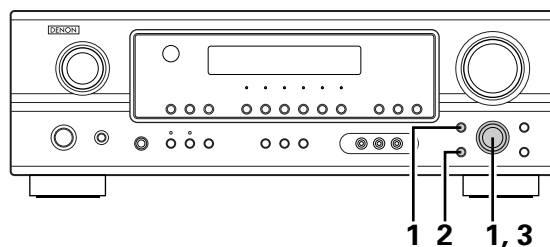

- When turned clockwise

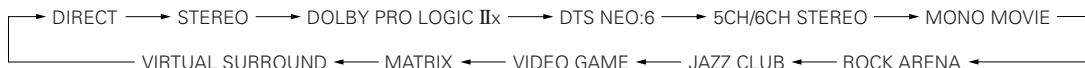

- When turned counterclockwise



※ To select the surround mode while adjusting the surround parameters, tone defeat or tone control, press the SURROUND MODE button then operate the selector.

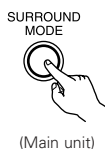

**2** Press the SURROUND PARAMETER button.

Press and hold in the surround parameter button to select the parameter you want to set.

- The parameters which can be set differ for the different surround modes. (Refer to "Surround Modes and Parameters" on page 52.)



**3** Display the parameter you want to adjust, then turn the SELECT knob to set it.

**NOTES:**

- When making parameter settings, the display will return to the regular condition several seconds after the last button was pressed and the setting will be completed.
- When the "5CH/6CH STEREO" mode is selected, the display differs according to the Surround Back CH ON/OFF.  
 Surround Back CH ON: 6CH STEREO  
 Surround Back CH OFF: 5CH STEREO

**Surround parameters ③**

**ROOM SIZE:**

This sets the size of the sound field.

There are five settings: "small", "med.s" (medium-small), "medium", "med.l" (medium-large) and "large". "small" recreates a small sound field, "large" a large sound field.

**EFFECT LEVEL:**

This sets the strength of the surround effect.

The level can be set in 15 steps from 1 to 15. Lower the level if the sound seems distorted.

**DELAY TIME:**

In the matrix mode only, the delay time can be set within the range of 0 to 110 ms.

■ Surround modes and parameters

Mode	Signals and adjustability in the different modes								
	Channel output					When playing Dolby Digital signals	When playing DTS signals	When playing PCM signals	When playing ANALOG signals
	FRONT L/R	CENTER	SURROUND L/R	SURROUND BACK L/R	SUBWOOFER				
DIRECT	○	×	×	×	⊗	○	○	○	○
STEREO	○	×	×	×	⊗	○	○	○	○
EXTERNAL INPUT	○	⊗	⊗	⊗	⊗	×	×	×	○
DOLBY PRO LOGIC II	○	⊗	⊗	⊗	⊗	○*	○*	○	○
DOLBY PRO LOGIC IIx	○	⊗	⊗	⊗	⊗	○*	○	○	○
DTS NEO:6	○	⊗	⊗	⊗	⊗	○*	○*	○	○
DOLBY DIGITAL	○	⊗	⊗	⊗	⊗	○	×	×	×
DTS SURROUND	○	⊗	⊗	⊗	⊗	×	○	×	×
5CH/6CH STEREO	○	⊗	⊗	⊗	⊗	○	○	○	○
ROCK ARENA	○	⊗	⊗	⊗	⊗	○	○	○	○
JAZZ CLUB	○	⊗	⊗	⊗	⊗	○	○	○	○
VIDEO GAME	○	⊗	⊗	⊗	⊗	○	○	○	○
MONO MOVIE	○	⊗	⊗	⊗	⊗	○	○	○	○
MATRIX	○	⊗	⊗	⊗	⊗	○	○	○	○
VIRTUAL	○	×	×	×	⊗	○	○	○	○

○ : Signal / Adjustable  
 × : No signal  
 ⊗ : Turned on or off by speaker configuration setting  
 ○ : Able  
 × : Unable  
 \* Only for 2 ch contents

Mode	Signals and adjustability in the different modes					
	When playing Dolby Digital and DTS signals		SB CH OUT (MODE)	TONE CONTROL	CINEMA EQ.	MODE
	D. COMP.	LFE				
DIRECT	○ (OFF)	○ (0 dB)	×	×	×	×
STEREO	○ (OFF)	○ (0 dB)	×	○ (0 dB)	×	×
EXTERNAL INPUT	×	×	×	×	×	×
DOLBY PRO LOGIC II	○ (OFF)	○ (0 dB)	○	○ (0 dB)	○ (OFF)	○
DOLBY PRO LOGIC IIx	○ (OFF)	○ (0 dB)	○	○ (0 dB)	○ (OFF)	○
DTS NEO:6	○ (OFF)	○ (0 dB)	○	○ (0 dB)	○ (OFF)	○
DOLBY DIGITAL	○ (OFF)	○ (0 dB)	○	○ (0 dB)	○ (OFF)	×
DTS SURROUND	○ (OFF)	○ (0 dB)	○	○ (0 dB)	○ (OFF)	×
5CH/6CH STEREO	○ (OFF)	○ (0 dB)	○	○ (0 dB)	×	×
ROCK ARENA	○ (OFF)	○ (0 dB)	○	○ (0 dB)	×	×
JAZZ CLUB	○ (OFF)	○ (0 dB)	○	○ (0 dB)	×	×
VIDEO GAME	○ (OFF)	○ (0 dB)	○	○ (0 dB)	×	×
MONO MOVIE	○ (OFF)	○ (0 dB)	○	○ (0 dB)	×	×
MATRIX	○ (OFF)	○ (0 dB)	○	○ (0 dB)	×	×
VIRTUAL	○ (OFF)	○ (0 dB)	×	×	×	×

○ : Able  
 × : Unable  
 ○ : Adjustable  
 × : Not adjustable

Mode	Signals and adjustability in the different modes								
	SURROUND PARAMETER								
					PRO LOGIC II / IIx ONLY			NEO:6 MUSIC	EXT. IN
	ROOM SIZE	EFFECT LEVEL	DELAY TIME	SUBWOOFER ON/OFF	PANORAMA	DIMENSION	CENTER WIDTH	CENTER IMAGE	SW ATT
DIRECT	×	×	×	○ (OFF)	×	×	×	×	×
STEREO	×	×	×	×	×	×	×	×	×
EXTERNAL INPUT	×	×	×	×	×	×	×	×	○
DOLBY PRO LOGIC II	×	×	×	×	○ (OFF)	○ (3)	○ (3)	×	×
DOLBY PRO LOGIC IIx	×	×	×	×	○ (OFF)	○ (3)	○ (3)	×	×
DTS NEO:6	×	×	×	×	×	×	×	○ (0.3)	×
DOLBY DIGITAL	×	×	×	×	×	×	×	×	×
DTS SURROUND	×	×	×	×	×	×	×	×	×
5CH/6CH STEREO	×	×	×	×	×	×	×	×	×
ROCK ARENA	○ (Medium)	○ (10)	×	×	×	×	×	×	×
JAZZ CLUB	○ (Medium)	○ (10)	×	×	×	×	×	×	×
VIDEO GAME	○ (Medium)	○ (10)	×	×	×	×	×	×	×
MONO MOVIE	○ (Medium)	○ (10)	×	×	×	×	×	×	×
MATRIX	×	×	○ (30msec)	×	×	×	×	×	×
VIRTUAL	×	×	×	×	×	×	×	×	×

○ : Adjustable  
 × : Not adjustable

# 15 LISTENING TO THE RADIO

## Auto preset memory

This unit is equipped with a function for automatically searching for FM broadcast stations and storing them in the preset memory.

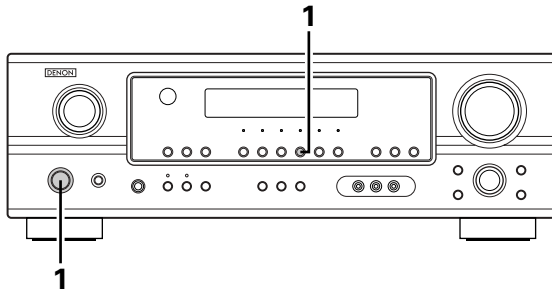

**1** When the main unit's power operation switch turn on while pressing the set's PRESET ▲ (+) button the unit automatically begins searching for FM broadcast stations.



**2** When the first FM broadcast station is found, that station is stored in the preset memory at channel A1. Subsequent stations are automatically stored in order at preset channels A1 to A8, B1 to B8, C1 to C8, D1 to D8, E1 to E8, F1 to F8 and G1 to G8, for a maximum of 56 stations.

**3** Channel A1 is tuned in after the auto preset memory operation is completed.

**NOTES:**

- If an FM station cannot be preset automatically due to poor reception, use the "Manual tuning" operation to tune in the station, then preset it using the manual "Preset memory" operation.
- To interrupt this function, press the power operation button.

■ DEFAULT VALUE

AUTO TUNER PRESETS	
A1 ~ A8	87.5/89.1/98.1/107.9/90.1/90.1/90.1/90.1 MHz
B1 ~ B8	520/600/1000/1400/1500/1710 kHz/90.1/90.1 MHz
C1 ~ C8	90.1 MHz
D1 ~ D8	90.1 MHz
E1 ~ E8	90.1 MHz
F1 ~ F8	90.1 MHz
G1 ~ G8	90.1 MHz

## Auto tuning

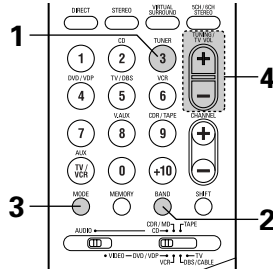
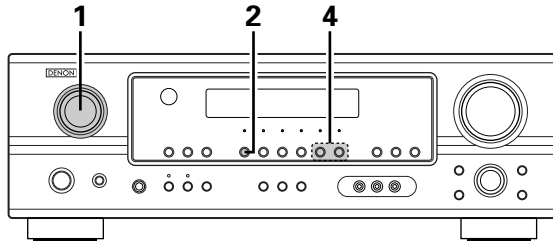

**1** Set the input source to "TUNER".

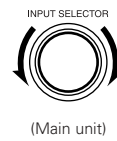

**2** Watching the display, press the BAND button to select the desired band (AM or FM).



**3** Press the MODE button to set the auto tuning mode.

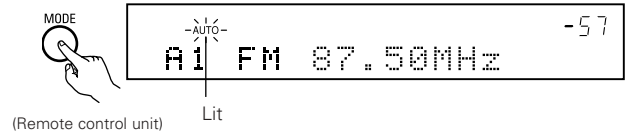

**4** Press the TUNING ▲ (+) or ▼ (-) button.

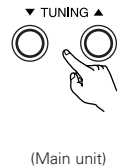

- Automatic searching begins, then stops when a station is tuned in.

**NOTE:**

- When in the auto tuning mode on the FM band, the "STEREO" indicator lights on the display when a stereo broadcast is tuned in. At open frequencies, the noise is muted and the "TUNED" and "STEREO" indicators turn off.

## Manual tuning

**1** Set the input function to "TUNER".

**2** Watching the display, press the BAND button to select the desired band (AM or FM).

**3** Press the MODE button to set the manual tuning mode. Check that the display's "AUTO" indicator turns off.

**4** Press the TUNING ▲ (+) or ▼ (-) button to tune in the desired station. The frequency changes continuously when the button is held in.

**NOTE:**

- When the manual tuning mode is set, FM stereo broadcasts are received in monaural and the "STEREO" indicator turns off.

## Preset stations

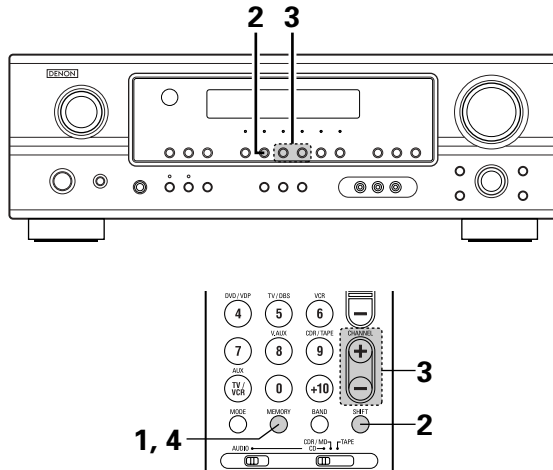

### Preparations:

Use the "Auto tuning" or "Manual tuning" operation to tune in the station to be preset in the memory.

**1** Press the MEMORY button.

(Remote control unit)

**2** Press the SHIFT button and select the desired memory block (A to G).

(Main unit) (Remote control unit)

**NOTE:** Please make sure the "AUDIO" position of the slide switch on the remote control unit.

**3** Press the PRESET ▲ (+) or ▼ (-) button to select the desired preset channel (1 to 8).

(Main unit) (Remote control unit)

**4** Press the MEMORY button again to store the station in the preset memory.

(Remote control unit)

※ To preset other channels, repeat steps 1 to 4.  
A total of 56 broadcast stations can be preset – 8 stations (channels 1 to 8) in each of blocks A to G.

## Recalling preset stations

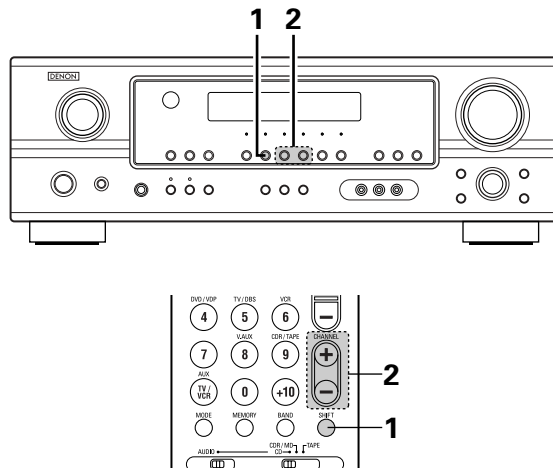

**1** Watching the display, press the SHIFT button to select the preset memory block.

(Main unit) (Remote control unit)

**NOTE:** Please make sure the "AUDIO" position of the slide switch on the remote control unit.

**2** Watching the display, press the PRESET ▲ (+) or ▼ (-) button to select the desired preset channel.

(Main unit) (Remote control unit)

## 16 LAST FUNCTION MEMORY

- This unit is equipped with a last function memory which stores the input and output setting conditions as they were immediately before the power is switched off.
- The unit is also equipped with a back-up memory. This function provides approximately one week of memory storage when the main unit's power switch is off and with the power cord disconnected.

## 17 INITIALIZATION OF THE MICROPROCESSOR

When the indication of the display is not normal or when the operation of the unit does not show the reasonable result, the initialization of the microprocessor is required by the following procedure.

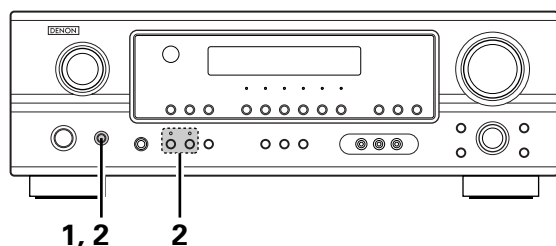

- 1 Switch off the unit using the main unit's power switch.
- 2 Hold the following SPEAKER A button and B button, and turn the main unit's power switch.
- 3 Check that the entire display is flashing with an interval of about 1 second, and release your fingers from the 2 buttons and the microprocessor will be initialized.

### NOTES:

- If step 3 does not work, start over from step 1.
- If the microprocessor has been reset, all the button settings are reset to the default values (the values set upon shipment from the factory).



## 18 ADDITIONAL INFORMATION

### Optimum surround sound for different sources

There are currently various types of multi-channel signals (signals or formats with more than two channels).

#### Types of multi-channel signals

Dolby Digital, Dolby Pro Logic, DTS, high definition 3-1 signals (Japan MUSE Hi-Vision audio), DVD-Audio, SACD (Super Audio CD), MPEG multi-channel audio, etc.

“Source” here does not refer to the type of signal (format) but the recorded content. Sources can be divided into two major categories.

#### Types of sources

- Movie audio** Signals created to be played in movie theaters. In general sound is recorded to be played in movie theaters equipped with multiple surround speakers, regardless of the format (Dolby Digital, DTS, etc.).

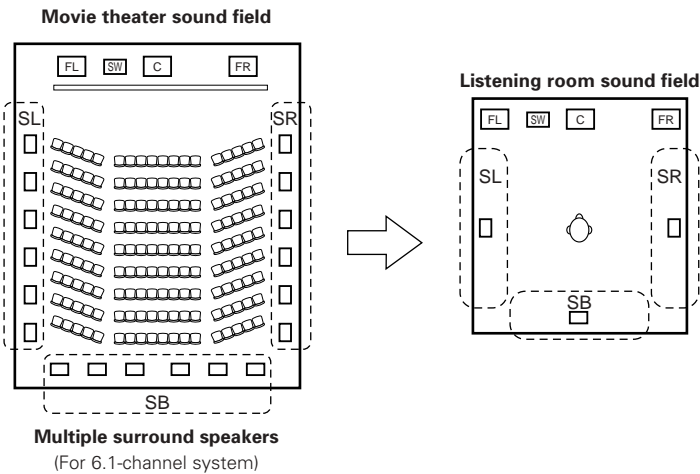

In this case it is important to achieve the same sense of expansion as in a movie theater with the surround channels. To do so, in some cases the number of surround speakers is increased (to four or eight) or speakers with bipolar or dipolar properties are used.

- SL: Surround L channel
- SR: Surround R channel
- SB: Surround back channel

- Other types of audio** These signals are designed to recreate a 360° sound field using three to five speakers.

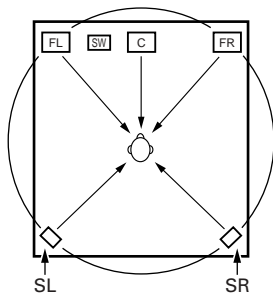

In this case the speakers should surround the listener from all sides to create a uniform sound field from 360°. Ideally the surround speakers should function as “point” sound sources in the same way as the front speakers.

These two types of sources thus have different properties, and different speaker settings, particularly for the surround speakers, are required in order to achieve the ideal sound.

## Surround back speakers

A 6.1-channel system is a conventional 5.1-channel system to which the “surround back” (SB) channel has been added. This makes it easy to achieve sound positioned directly behind the listener, something that was previously difficult with sources designed for conventional multi surround speakers. In addition, the acoustic image extending between the sides and the rear is narrowed, thus greatly improving the expression of the surround signals for sounds moving from the sides to the back and from the front to the point directly behind the listening position.

**Change of positioning and acoustic image with 5.1-channel systems**

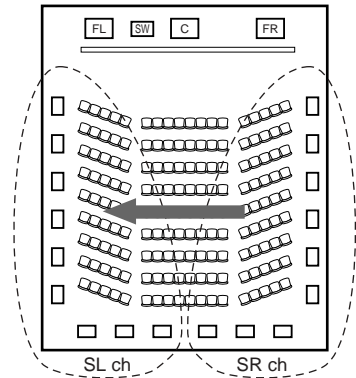

**Movement of acoustic image from SR to SL**

**Change of positioning and acoustic image with 6.1-channel systems**

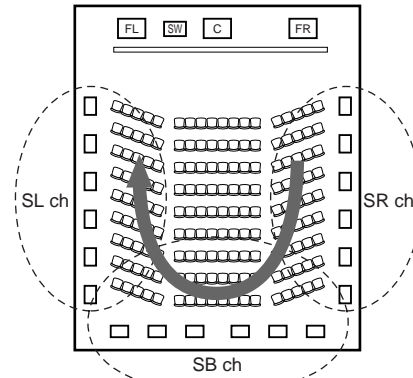

**Movement of acoustic image from SR to SB to SL**

With this set, speaker(s) for 1 or 2 channels are required to achieve a 6.1-channel system (DTS-ES, etc.). Adding these speakers, however, increases the surround effect not only with sources recorded in 6.1 channels but also with conventional 2- to 5.1-channel sources. All the DENON original surround modes (see page 48) are compatible with 6.1-channel playback, so you can enjoy 6.1-channel sound with any signal source.

### ■ Placement of the surround left and right channels when using surround back speakers

Using surround back speakers greatly improves the positioning of the sound at the rear. Because of this, the surround left and right channels play an important role in achieving a smooth transition of the acoustic image from the front to the back. As shown on the diagram above, in a movie theater the surround signals are also produced from diagonally in front of the listeners, creating an acoustic image as if the sound were floating in space.

To achieve these effects, we recommend placing the speakers for the surround left and right channels slightly more towards the front than with conventional surround systems. Doing so sometimes increases the surround effect when playing conventional 5.1-channel sources in the 6.1 surround or DTS-ES Matrix 6.1 mode. Check the surround effects of the various modes before selecting the surround mode.

## Speaker setting examples

Here we describe a number of speaker settings for different purposes. Use these examples as guides to set up your system according to the type of speakers used and the main usage purpose.

### 1. DTS-ES compatible system (using surround back speakers)

#### (1) Basic setting for primarily watching movies

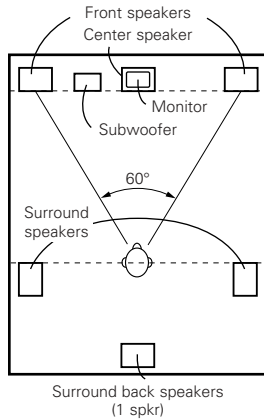

As seen from above

- Set the front speakers with their front surfaces as flush with the TV or monitor screen as possible. Set the center speaker between the front left and right speakers and no further from the listening position than the front speakers.
- Consult the owner's manual for your subwoofer for advice on placing the subwoofer within the listening room.
- If the surround speakers are direct-radiating (monopolar) then place them slightly behind and at an angle to the listening position and parallel to the walls at a position 2 to 3 feet (60 to 90 cm) above ear level at the prime listening position.
- When using one surround back speaker, place it at the rear center facing the front at a slightly higher position (0 to 20 cm) than the surround speakers.
- We recommend installing the surround back speaker(s) at a slightly downward facing angle. This effectively prevents the surround back channel signals from reflecting off the monitor or screen at the front center, resulting in interference and making the sense of movement from the front to the back less sharp.

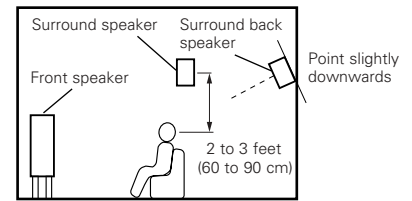

As seen from the side

#### (2) Setting for primarily watching movies using diffusion type speakers for the surround speakers

For the greatest sense of surround sound envelopment, diffuse radiation speakers such as bipolar types, or dipolar types, provide a wider dispersion than is possible to obtain from a direct radiating speaker (monopolar). Place these speakers at either side of the prime listening position, mounted above ear level.

Path of the surround sound from the speakers to the listening position

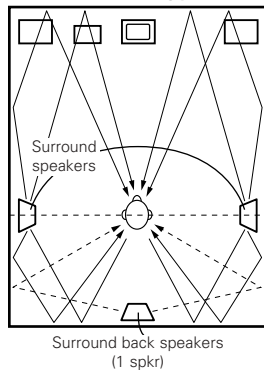

As seen from above

- Set the front speakers, center speaker and subwoofer in the same positions as in example (1).
- It is best to place the surround speakers directly at the side or slightly to the front of the viewing position, and 2 to 3 feet (60 to 90 cm) above the ears.
- Same as surround back speaker installation method (1).
- Using dipolar speakers for the surround back speakers as well is more effective.
- Connect the surround speakers to the surround speaker jacks.
- The signals from the surround channels reflect off the walls as shown on the diagram at the left, creating an enveloping and realistic surround sound presentation.

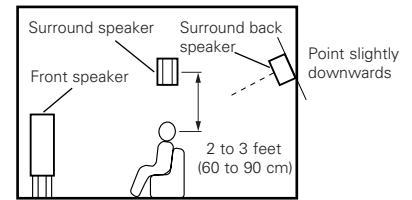

As seen from the side

For multi-channel music sources however, the use of bipolar or dipolar speakers mounted at the sides of the listening position may not be satisfactory in order to create a coherent 360 degree surround sound field. Connect another pair of direct radiating speakers as described in example (3) and place them at the rear corners of the room facing towards the prime listening position.

### 2. When not using surround back speakers

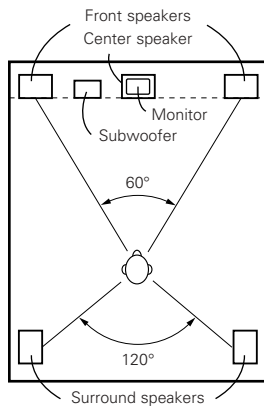

As seen from above

- Set the front speakers with their front surfaces as flush with the TV or monitor screen as possible. Set the center speaker between the front left and right speakers and no further from the listening position than the front speakers.
- Consult the owner's manual for your subwoofer for advice on placing the subwoofer within the listening room.
- If the surround speakers are direct-radiating (monopolar) then place them slightly behind and at an angle to the listening position and parallel to the walls at a position 2 to 3 feet (60 to 90 cm) above ear level at the prime listening position.

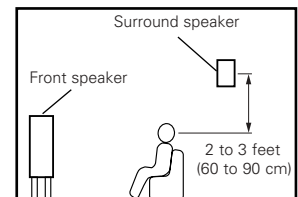

As seen from the side

## Surround

The AVR-1705/685 is equipped with a digital signal processing circuit that lets you play program sources in the surround mode to achieve the same sense of presence as in a movie theater.

### Dolby Surround

#### (1) Dolby Digital

Dolby Digital is the multi-channel digital signal format developed by Dolby Laboratories.

Dolby Digital consists of up to "5.1" channels - front left, front right, center, surround left, surround right, and an additional channel exclusively reserved for additional deep bass sound effects (the Low Frequency Effects – LFE – channel, also called the ".1" channel, containing bass frequencies of up to 120 Hz).

Unlike the analog Dolby Pro Logic format, Dolby Digital's main channels can all contain full range sound information, from the lowest bass, up to the highest frequencies – 22 kHz. The signals within each channel are distinct from the others, allowing pinpoint sound imaging, and Dolby Digital offers tremendous dynamic range from the most powerful sound effects to the quietest, softest sounds, free from noise and distortion.

#### ■ Dolby Digital and Dolby Pro Logic

Comparison of home surround systems	Dolby Digital	Dolby Pro Logic
No. recorded channels (elements)	5.1 ch	2 ch
No. playback channels	5.1 ch	4 ch
Playback channels (max.)	L, R, C, SL, SR, SW	L, R, C, S (SW - recommended)
Audio processing	Digital discrete processing Dolby Digital encoding/decoding	Analog matrix processing Dolby Surround
High frequency playback limit of surround channel	20 kHz	7 kHz

#### ■ Dolby Digital compatible media and playback methods

Marks indicating Dolby Digital compatibility:  .

The following are general examples. Also refer to the player's operating instructions.

Media	Dolby Digital output jacks	Playback method (reference page)
LD (VDP)	Coaxial Dolby Digital RF output jack ※1	Set the input mode to "AUTO". (Page 35)
DVD	Optical or coaxial digital output (same as for PCM) ※2	Set the input mode to "AUTO". (Page 35)
Others (satellite broadcasts, CATV, etc.)	Optical or coaxial digital output (same as for PCM)	Set the input mode to "AUTO". (Page 35)

※1 Please use a commercially available adapter when connecting the Dolby Digital RF output jack of the LD player to the digital input jack. Please refer to the instruction manual of the adapter when making connection.

※2 Some DVD digital outputs have the function of switching the Dolby Digital signal output method between "bit stream" and "(convert to) PCM". When playing in Dolby Digital surround on the AVR-1705/685, switch the DVD player's output mode to "bit stream". In some cases players are equipped with both "bit stream + PCM" and "PCM only" digital outputs. In this case connect the "bit stream + PCM" jacks to the AVR-1705/685.

#### (2) Dolby Pro Logic IIx

- Dolby Pro Logic IIx furthers the matrix decoding technology of Dolby Pro Logic II to decode audio signals recorded on two channels into up to 6.1 playback channels, including the surround back channel. Dolby Pro Logic IIx also allows 5.1-channel sources to be played in up to 6.1 channels.

The mode can be selected according to the source. The Music mode is best suited for playing music, the Cinema mode for playing movies, and the Game mode for playing games. The Game mode can only be used with 2-channel audio sources.

**(3) Dolby Pro Logic II**

- Dolby Pro-Logic II is a new multi-channel playback format developed by Dolby Laboratories using feedback logic steering technology and offering improvements over conventional Dolby Pro Logic circuits.
- Dolby Pro Logic II can be used to decode not only sources recorded in Dolby Surround (※) but also regular stereo sources into five channels (front left, front right, center, surround left and surround right) to achieve surround sound.
- Whereas with conventional Dolby Pro Logic the surround channel playback frequency band was limited, Dolby Pro Logic II offers a wider band range (20 Hz to 20 kHz or greater). In addition, the surround channels were monaural (the surround left and right channels were the same) with previous Dolby Pro Logic, but Dolby Pro Logic II they are played as stereo signals.
- Various parameters can be set according to the type of source and the contents, so it is possible to achieve optimum decoding (see page 52).

※ Sources recorded in Dolby Surround

These are sources in which three or more channels of surround have been recorded as two channels of signals using Dolby Surround encoding technology.

Dolby Surround is used for the sound tracks of movies recorded on DVDs, LDs and video cassettes to be played on stereo VCRs, as well as for the stereo broadcast signals of FM radio, TV, satellite broadcasts and cable TV.

Decoding these signals with Dolby Pro Logic makes it possible to achieve multi-channel surround playback. The signals can also be played on ordinary stereo equipment, in which case they provide normal stereo sound.

There are two types of DVD Dolby surround recording signals.

- ① 2-channel PCM stereo signals
- ② 2-channel Dolby Digital signals

When either of these signals is input to the AVR-1705/685, the surround mode is automatically set to Dolby Pro Logic II when the "DOLBY/DTS SURROUND" mode is selected.

■ Sources recorded in Dolby Surround are indicated with the logo mark shown below.

Dolby Surround support mark: 

Manufactured under license from Dolby Laboratories.

"Dolby", "Pro Logic" and the double-D symbol are trademarks of Dolby Laboratories.

**DTS Digital Surround**

Digital Theater Surround (also called simply DTS) is a multi-channel digital signal format developed by Digital Theater Systems.



DTS offers the same "5.1" playback channels as Dolby Digital (front left, front right and center, surround left and surround right) as well as the stereo 2-channel mode. The signals for the different channels are fully independent, eliminating the risk of deterioration of sound quality due to interference between signals, crosstalk, etc.

DTS features a relatively higher bit rate as compared to Dolby Digital (1234 kbps for CDs and LDs, 1536 kbps for DVDs) so it operates with a relatively low compression rate. Because of this the amount of data is great, and when DTS playback is used in movie theaters, a separate CD-ROM synchronized with the film is played.

With LDs and DVDs, there is of course no need for an extra disc; the pictures and sound can be recorded simultaneously on the same disc, so the discs can be handled in the same way as discs with other formats.

There are also music CDs recorded in DTS. These CDs include 5.1-channel surround signals (compared to two channels on current CDs). They do not include picture data, but they offer surround playback on CD players that are equipped with digital outputs (PCM type digital output required). DTS surround track playback offers the same intricate, grand sound as in a movie theater, right in your own listening room.

■ DTS compatible media and playback methods

Marks indicating DTS compatibility:  and .

The following are general examples. Also refer to the player's operating instructions.

Media	Dolby Digital output jacks	Playback method (reference page)
CD	Optical or coaxial digital output (same as for PCM) ※2	Set the input mode to "AUTO" or "DTS" (page 35). Never set the mode to "ANALOG" or "PCM". ※1
LD (VDP)	Optical or coaxial digital output (same as for PCM) ※2	Set the input mode to "AUTO" or "DTS" (page 35). Never set the mode to "ANALOG" or "PCM". ※1
DVD	Optical or coaxial digital output (same as for PCM) ※3	Set the input mode to "AUTO" or "DTS" (page 35).

- ※1 DTS signals are recorded in the same way on CDs and LDs as PCM signals. Because of this, the un-decoded DTS signals are output as random “hissy” noise from the CD or LD player’s analog outputs. If this noise is played with the amplifier set at a very high volume, it may possibly cause damage to the speakers. To avoid this, be sure to switch the input mode to “AUTO” or “DTS” before playing CDs or LDs recorded in DTS. Also, never switch the input mode to “ANALOG” or “PCM” during playback. The same holds true when playing CDs or LDs on a DVD player or LD/DVD compatible player. For DVDs, the DTS signals are recorded in a special way so this problem does not occur.
- ※2 The signals provided at the digital outputs of a CD or LD player may undergo some sort of internal signal processing (output level adjustment, sampling frequency conversion, etc.). In this case the DTS-encoded signals may be processed erroneously, in which case they cannot be decoded by the AVR-1705/685, or may only produce noise. Before playing DTS signals for the first time, turn down the master volume to a low level, start playing the DTS disc, then check whether the DTS indicator on the AVR-1705/685 (see page 36) lights before turning up the master volume.
- ※3 A DVD player with DTS-compatible digital output is required to play DTS DVDs. A DTS Digital Output logo is featured on the front panel of compatible DVD players. Recent DENON DVD player models feature DTS-compatible digital output – consult the player’s owner’s manual for information on configuring the digital output for DTS playback of DTS-encoded DVDs.

MANUFACTURED UNDER LICENSE FROM DIGITAL THEATER SYSTEMS, INC.  
 U.S. PAT. NO'S. 5,451,942; 5,956,674; 5,974,380; 5,978,762; 6,226,616; 6,487,535 AND OTHER U.S. AND WORLD-WIDE PATENTS ISSUED AND PENDING.  
 “DTS”, “DTS-ES”, “Neo:6”, AND “DTS 96/24” ARE TRADEMARKS OF DIGITAL THEATER SYSTEMS, INC. © 1996, 2003 DIGITAL THEATER SYSTEMS, INC. ALL RIGHTS RESERVED.

## DTS-ES Extended Surround™

DTS-ES Extended Surround is a new multi-channel digital signal format developed by Digital Theater Systems Inc. While offering high compatibility with the conventional DTS Digital Surround format, DTS-ES Extended Surround greatly improves the 360-degree surround impression and space expression thanks to further expanded surround signals. This format has been used professionally in movie theaters since 1999.

In addition to the 5.1 surround channels (FL, FR, C, SL, SR and LFE), DTS-ES Extended Surround also offers the SB (Surround Back, sometimes also referred to as “surround center”) channel for surround playback with a total of 6.1 channels. DTS-ES Extended Surround includes two signal formats with different surround signal recording methods, as described below.

### ■ DTS-ES™ Discrete 6.1

DTS-ES Discrete 6.1 is the newest recording format. With it, all 6.1 channels (including the SB channel) are recorded independently using a digital discrete system. The main feature of this format is that because the SL, SR and SB channels are fully independent, the sound can be designed with total freedom and it is possible to achieve a sense that the acoustic images are moving about freely among the background sounds surrounding the listener from 360 degrees.

Though maximum performance is achieved when sound tracks recorded with this system are played using a DTS-ES decoder, when played with a conventional DTS decoder the SB channel signals are automatically down-mixed to the SL and SR channels, so none of the signal components are lost.

### ■ DTS-ES™ Matrix 6.1

With this format, the additional SB channel signals undergo matrix encoding and are input to the SL and SR channels beforehand. Upon playback they are decoded to the SL, SR and SB channels. The performance of the encoder used at the time of recording can be fully matched using a high precision digital matrix decoder developed by DTS, thereby achieving surround sound more faithful to the producer’s sound design aims than with conventional 5.1- or 6.1-channel systems.

In addition, the bit stream format is 100% compatible with conventional DTS signals, so the effect of the Matrix 6.1 format can be achieved even with 5.1-channel signal sources. Of course it is also possible to play DTS-ES Matrix 6.1 encoded sources with a DTS 5.1-channel decoder.

When DTS-ES Discrete 6.1 or Matrix 6.1 encoded sources are decoded with a DTS-ES decoder, the format is automatically detected upon decoding and the optimum playing mode is selected. However, some Matrix 6.1 sources may be detected as having a 5.1-channel format, so the DTS-ES Matrix 6.1 mode must be set manually to play these sources.

(For instructions on selecting the surround mode, see page 45.)

The DTS-ES decoder includes another function, the DTS Neo:6 surround mode for 6.1-channel playback of digital PCM and analog signal sources.

### ■ DTS Neo:6™ surround

This mode applies conventional 2-channel signals to the high precision digital matrix decoder used for DTS-ES Matrix 6.1 to achieve 6.1-channel surround playback. High precision input signal detection and matrix processing enable full band reproduction (frequency response of 20 Hz to 20 kHz or greater) for all 6.1 channels, and separation between the different channels is improved to the same level as that of a digital discrete system.

DTS Neo:6 surround includes two modes for selecting the optimum decoding for the signal source.

#### • DTS Neo:6 Cinema

This mode is optimum for playing movies. Decoding is performed with emphasis on separation performance to achieve the same atmosphere with 2-channel sources as with 6.1-channel sources.

This mode is effective for playing sources recorded in conventional surround formats as well, because the in-phase component is assigned mainly to the center channel (C) and the reversed phase component to the surround (SL, SR and SB channels).

#### • DTS Neo:6 Music

This mode is suited mainly for playing music. The front channel (FL and FR) signals bypass the decoder and are played directly so there is no loss of sound quality, and the effect of the surround signals output from the center (C) and surround (SL, SR and SB) channels add a natural sense of expansion to the sound field.

## DTS 96/24

The sampling frequency, number of bits and number of channels used for recording of music, etc., in studios has been increasing in recent years, and there are a growing number of high quality signal sources, including 96 kHz/24 bit 5.1-channel sources.

For example, there are high picture/sound quality DVD video sources with 96 kHz/24 bit stereo PCM audio tracks.

However, because the data rate for these audio tracks is extremely high, there are limits to recording them on two channels only, and since the quality of the pictures must be restricted it is common to only include still pictures.

In addition, 96 kHz/24 bit 5.1-channel surround is possible with DVD audio sources, but DVD audio players are required to play them with this high quality.

DTS 96/24 is a multi-channel digital signal format developed by Digital Theater Systems Inc. in order to deal with this situation.

Conventional surround formats used sampling frequencies of 48 or 44.1 kHz, so 20 kHz was about the maximum playback signal frequency. With DTS 96/24, the sampling frequency is increased to 96 or 88.2 kHz to achieve a wide frequency range of over 40 kHz.

In addition, DTS 96/24 has a resolution of 24 bits, resulting in the same frequency band and dynamic range as 96 kHz/24 bit PCM.

As with conventional DTS Surround, DTS 96/24 is compatible with a maximum of 5.1 channels, so sources recorded using DTS 96/24 can be played in high sampling frequency, multiple channel audio with such normal media as DVD videos and CDs.

Thus, with DTS 96/24, the same 96 kHz/24 bit multi-channel surround sound as with DVD-Audio can be achieved while viewing DVD-Video images on a conventional DVD-Video player (※1). Furthermore, with DTS 96/24 compatible CDs, 88.2 kHz/24 bit multi-channel surround can be achieved using normal CD/LD players (※1).

Even with the high quality multi-channel signals, the recording time is the same as with conventional DTS surround sources.

What's more, DTS 96/24 is fully compatible with the conventional DTS surround format, so DTS 96/24 signal sources can be played with a sampling frequency of 48 kHz or 44.1 kHz on conventional DTS or DTS-ES surround decoders (※2).

- ※1 A DVD player with DTS digital output capabilities (for CD/LD players, a player with digital outputs for conventional DTS CDs/LDs) and a disc recorded in DTS 96/24 are required.
- ※2 The resolution is 24 or 20 bits, depending on the decoder.

## 19 TROUBLESHOOTING

If a problem should arise, first check the following.

1. Are the connections correct ?
2. Have you operated the receiver according to the Operating Instructions ?
3. Are the speakers and other components operating properly ?

If this unit is not operating properly, check the items listed in the table below. Should the problem persist, there may be a malfunction. Disconnect the power immediately and contact your store of purchase.

	Symptom	Cause	Measures	Page
Common problems arising when listening to the CD, records, tapes, and FM broadcasts, etc.	DISPLAY not lit and sound not produced when power switch set to on.	<ul style="list-style-type: none"> <li>• Power cord not plugged in securely.</li> </ul>	<ul style="list-style-type: none"> <li>• Check the insertion of the power cord plug.</li> <li>• Turn the power off with the remote control unit after turning the POWER operation switch on.</li> </ul>	10 34
	DISPLAY lit but sound not produced.	<ul style="list-style-type: none"> <li>• Speaker cords not securely connected.</li> <li>• Improper position of the audio function button.</li> <li>• Volume control set to minimum.</li> <li>• MUTING is on.</li> <li>• Digital signals not input Digital input selected.</li> </ul>	<ul style="list-style-type: none"> <li>• Connect securely.</li> <li>• Set to a suitable position.</li> <li>• Turn volume up to suitable level.</li> <li>• Switch off MUTING.</li> <li>• Input digital signals or select input jacks to which digital signals are being input.</li> </ul>	15, 16 35 36 37 36
	DISPLAY not displayed and the "ON/STANDBY" LED flashes at a high rate	<ul style="list-style-type: none"> <li>• Speaker terminals are short-circuited.</li> <li>• Block the ventilation holes of the set.</li> <li>• The unit is operating at continuous high power conditions and/or inadequate ventilation.</li> </ul>	<ul style="list-style-type: none"> <li>• Switch power off, connect speakers properly, then switch power back on.</li> <li>• Turn off the set's power, then ventilate it well to cool it down. Once the set is cooled down, turn the power back on.</li> <li>• Turn off the set's power, then ventilate it well to cool it down. Once the set is cooled down, turn the power back on.</li> </ul>	15, 16 4, 16 4, 16
	Sound produced only from one channel.	<ul style="list-style-type: none"> <li>• Incomplete connection of speaker cords.</li> <li>• Incomplete connection of input/output cords.</li> </ul>	<ul style="list-style-type: none"> <li>• Connect securely.</li> <li>• Connect securely.</li> </ul>	15, 16 10 ~ 16
	Positions of instruments reversed during stereo playback.	<ul style="list-style-type: none"> <li>• Reverse connections of left and right speakers or left and right input/output cords.</li> </ul>	<ul style="list-style-type: none"> <li>• Check left and right connections.</li> </ul>	10, 15
	Remote control unit.	This unit does not operate properly when remote control unit is used.	<ul style="list-style-type: none"> <li>• Batteries dead.</li> <li>• Remote control unit too far from this unit.</li> <li>• Obstacle between this unit and remote control unit.</li> <li>• Different button is being pressed.</li> <li>• ⊕ and ⊖ ends of battery inserted in reverse.</li> </ul>	<ul style="list-style-type: none"> <li>• Replace with new batteries.</li> <li>• Move closer.</li> <li>• Remove obstacle.</li> <li>• Press the proper button.</li> <li>• Insert batteries properly.</li> </ul>

**Note:**

When a subwoofer has been connected and the virtual surround function is being used, the signal played from the subwoofer channel is LFE only (only when playing Dolby Digital or DTS signals) for initial factory settings (i.e., the setting of the front speaker is "LARGE" and the setting of the subwoofer mode is "NORM").

When subwoofer effects are felt to be weak, while in the system setup mode try setting the subwoofer mode to "+MAIN", or the front speaker to "SMALL" in the system setup "Speaker Configuration" settings.

Making these settings will result in the low-frequency sounds of the front channel being played from the subwoofer.



## 20 SPECIFICATIONS

### ■ Audio section

- **Power amplifier**  
Rated output:

Front:	75 W + 75 W	(8 Ω/ohms, 20 Hz ~ 20 kHz with 0.08% T.H.D.)
	110 W + 110 W	(6 Ω/ohms, 1 kHz with 0.7% T.H.D.)
Center:	75 W	(8 Ω/ohms, 20 Hz ~ 20 kHz with 0.08% T.H.D.)
	110 W	(6 Ω/ohms, 1 kHz with 0.7% T.H.D.)
Surround:	75 W + 75 W	(8 Ω/ohms, 20 Hz ~ 20 kHz with 0.08% T.H.D.)
	110 W + 110 W	(6 Ω/ohms, 1 kHz with 0.7% T.H.D.)
Surround back:	75W	(8 Ω/ohms, 20 Hz ~ 20 kHz with 0.08% T.H.D.)
	110 W	(6 Ω/ohms, 1 kHz with 0.7% T.H.D.)
Front:	A or B	6 to 16 Ω/ohms
	A + B	12 to 16 Ω/ohms
Center/Surround/Surr. Back:		6 to 16 Ω/ohms

#### Output terminals:

- **Analog**

**Input sensitivity / input impedance:**

**Frequency response:**

**S/N ratio:**

200 mV / 47 kΩ/kohms  
10 Hz ~ 100 kHz: +1, -3 dB (TONE DEFEAT ON)  
98 dB (IHF-A weighted) (TONE DEFEAT ON)

### ■ Video section

- **Standard video jacks**

**Input / output level and impedance:**

**Frequency response:**

- **S-video jacks**

**Input / output level and impedance:**

**Frequency response:**

- **Color component video jacks**

**Input / output level and impedance:**

**Frequency response:**

1 Vp-p, 75 Ω/ohms  
5 Hz ~ 10 MHz — +1, -3 dB

Y (brightness) signal — 1 Vp-p, 75 Ω/ohms  
C (color) signal — 0.286 Vp-p, 75 Ω/ohms  
5 Hz ~ 10 MHz — +1, -3 dB

Y (brightness) signal — 1 Vp-p, 75 Ω/ohms  
PB/CB (blue) signal — 0.7 Vp-p, 75 Ω/ohms  
PR/CR (red) signal — 0.7 Vp-p, 75 Ω/ohms  
DC ~ 100 MHz — +0, -3 dB

### ■ Tuner section

**Receiving range:**

**Usable sensitivity:**

**50 dB quieting sensitivity:**

**S/N ratio:**

**Total harmonic distortion:**

**[FM]** (note: μV at 75 Ω/ohms, 0 dBf =  $1 \times 10^{-15}$  W)

87.50 MHz ~ 107.90 MHz

1.0 μV (11.2 dBf)

MONO 1.6 μV (15.3 dBf)

STEREO 23 μV (38.5 dBf)

MONO 77 dB (IHF-A weighted)

STEREO 72 dB (IHF-A weighted)

MONO 0.15% (1kHz)

STEREO 0.3% (1kHz)

**[AM]**

520 kHz ~ 1710 kHz

18 μV

### ■ General

**Power supply:**

**Power consumption:**

**Maximum external dimensions:**

**Mass:**

AC 120 V, 60 Hz

4.0 A

434 (W) x 147 (H) x 417 (D) mm (17-3/32" x 5-25/32" x 1-23/64")

10.9 kg (24 lbs 49 oz)

### ■ Remote control unit (RC-977)

**Batteries:**

**External dimensions:**

**Mass:**

R6P/AA Type (two batteries)

55 (W) x 225 (H) x 34.5 (D) mm (2-11/64" x 8-55/64" x 1-9/64")

165 g (Approx. 5.8 oz) (including batteries)

\* For purposes of improvement, specifications and design are subject to change without notice.

## ■ INTRODUCTION

Nous vous remercions d'avoir choisi l'ampli-tuner A/V Surround de DENON.

Ce remarquable composant a été fabriqué pour fournir une superbe écoute de sons d'ambiance avec des sources de cinéma domestique telles que DVD, ainsi que pour assurer une formidable reproduction haute fidélité de vos sources musicales favorites.

Ce produit étant équipé d'une immense foule de caractéristiques, nous vous recommandons avant de commencer l'installation et l'utilisation de l'appareil de bien lire le contenu de ce manuel avant de procéder.

## TABLE DES MATIERES

1	Avant L'utilisation.....	66	11	Unité de Télécommande.....	91~95
2	Précautions D'installation.....	67	12	Opération.....	96~100
3	Précautions de Manipulation.....	67	13	Ambiance.....	101~109
4	Caractéristiques.....	68	14	Simulation d'ambiance DSP.....	110~114
5	Nomenclature et Fonctions.....	69, 70	15	Ecoute de la Radio.....	115~117
6	A lire en premier.....	71	16	Mémoire de Dernière Fonction.....	118
7	Réglage des systèmes d'enceinte.....	71	17	Initialisation du Microprocesseur.....	118
8	Connexions.....	72~78	18	Informations Supplémentaires.....	119~125
9	Utilisation de la télécommande.....	79	19	Dépistage des Pannes.....	126
10	Installation du Système.....	80~90	20	Spécifications.....	127
				Liste de codes pré-réglés.....	128~132

## ■ ACCESSOIRES

Vérifier que les articles suivants sont inclus dans le carton en plus de l'unité principale:

1	Mode d'emploi.....	1	5	Piles R6P/AA.....	2
2	Certificat de garantie.....	1	6	Antenne-cadre AM.....	1
3	Liste des centres d'entretien.....	1	7	Antenne intérieure FM.....	1
4	Télécommande (RC-977).....	1			

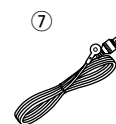
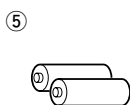

## 1 AVANT L'UTILISATION

Faire attention au points suivants avant d'utiliser cet appareil:

### • Déplacement de l'appareil

Pour éviter des court-circuits ou des fils endommagés dans les câbles de connexion, toujours débrancher le cordon d'alimentation, et déconnecter les câbles de connexion entre tous les autres composants audio lors du déplacement de l'appareil.

### • Avant de mettre sous tension

Vérifier une nouvelle fois si toutes les connexions sont bonnes et s'il n'y a pas de problèmes avec les câbles de connexion. Toujours placer l'interrupteur de mise sous tension en position d'attente avant de connecter et de déconnecter les câbles de connexion.

### • Ranger ces instructions dans un endroit sûr.

Après les avoir lues, ranger ces instructions en même temps que la garantie dans un endroit sûr.

### • Noter que les illustrations de ces instructions peuvent varier de l'appareil actuel dans un but d'explication.

### • Borne V. AUX

Le panneau avant de l'AVR-1705/685 est équipé d'une borne V. AUX. Retirer le capuchon recouvrant la borne en cas d'utilisation.

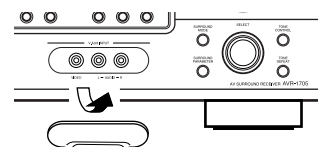

## LIST OF PRESET CODES / LISTE DE CODES PRÉRÉGLÉS

## DVD

Denon	014, *[111]
Aiwa	009
Hitachi	010
JVC	006, 011
Konka	012, 013
Magnavox	005
Mitsubishi	004
Panasonic	014
Philips	005, 015, 016, 017
Pioneer	003, 008
Sanyo	018
Sony	002, 019, 020
Toshiba	001, 021, 022
Zenith	023

## VDP

Denon	028, 029, 112
Magnavox	026
Mitsubishi	028
Panasonic	029, 030
Philips	026
Pioneer	028, 031
RCA	032
Sony	033, 034, 035, 036

## VCR

Admiral	081
Aiko	095
Aiwa	009
Akai	026, 027, 070, 072, 082, 083, 084
Alba	055
Amstrad	009
ASA	042
Asha	087
Audio Dynamic	005, 085
Audiovox	088
Beaumarck	087
Broksonic	086, 093
Calix	088
Candle	006, 087, 088, 089, 090
Canon	049, 057
Capehart	025, 055, 056, 071
Carver	015
CCE	095
Citizen	006, 007, 087, 088, 089, 090, 095
Craig	007, 087, 088, 091, 115
Curtis Mathes	006, 049, 073, 080, 087, 090, 092

Cybernex	087
Daewoo	025, 055, 059, 074, 089, 093, 095, 096
Daytron	025, 055
DBX	005, 085
Dumont	053
Dynatech	009
Electrohome	001, 088, 097
Electroponic	088
Emerson	001, 009, 017, 027, 086, 088, 089, 092, 093, 097, 100, 101, 102, 103, 104, 117
Fisher	009, 028, 031, 053, 054, 091, 099, 115
GE	007, 011, 049, 050, 051, 052, 073, 080, 087
Go Video	047, 048
Goldstar	000, 006, 012, 062, 088
Gradiente	094
Grundig	042
Harley Davidson	094
Harman Kardon	040, 062
Hi-Q	091
Hitachi	009, 013, 023, 026, 058, *[108], 109, 110, 111
JC Penny	004, 005, 007, 023, 028, 049, 062, 085, 087, 088
Jensen	013, 026
JVC	004, 005, 006, 026, 029, 043, 044, 045, 046, 085
Kenwood	004, 005, 006, 026, 029, 033, 045, 085, 090
Kodak	088
Lloyd	009, 094
LXI	088
Magnavox	015, 016, 042, 049, 063, 106
Magnin	087
Marantz	004, 005, 006, 015, 042, 049, 085, 090
Marta	088
MEI	049
Memorex	009, 033, 049, 053, 060, 081, 087, 088, 091, 094, 115
Metz	123, 124, 125, 126, 127, 128
MGA	001, 017, 027, 041, 097
MGN Technology	087
Midland	011

Minolta	013, 023
Mitsubishi	001, 003, 008, 013, 014, 017, 027, 029, 039, 040, 041, 045, 097
Motorola	081
Montgomery Ward	001, 002, 007, 009, 049, 063, 081, 115, 117
MTC	009, 087, 094
Multitech	007, 009, 011, 087, 090, 094
NAD	038
NEC	004, 005, 006, 018, 026, 029, 045, 061, 062, 085
Nikko	088
Noblex	087
Optimus	081, 088
Optonica	021
Panasonic	024, 049, 064, 066, 067, 068, 069, 107
Perdio	009
Pentax	009, 013, 023, 058, 090
Philco	015, 016, 049
Philips	015, 021, 042, 049, 105
Pilot	088
Pioneer	005, 013, 029, 036, 037, 038, 045, 085
Portland	025, 055, 090
Proscan	063, 080
Pulsar	060
Quartz	033
Quasar	034, 035, 049
Radio Shack	001, 002, 021, 081, 087, 088, 091, 094, 097, 098, 115
Radix	088
Randex	088
RCA	007, 013, 019, 023, 058, 063, 064, 065, 073, 080, 082, 087
Realistic	009, 021, 031, 033, 049, 053, 081, 087, 088, 091, 094, 097, 098
Ricoh	055
Salora	033, 041
Samsung	007, 011, 051, 059, 070, 083, 087, 089, 113
Sanky	081
Sansui	005, 026, 029, 045, 061, 085, 114
Sanyo	032, 033, 053, 087, 091, 115, 116
SBR	042
Scott	017, 020, 086, 089, 093, 117
Sears	013, 023, 028, 031, 033, 053, 054, 088, 091, 098, 099, 115
Sentra	055
Sharp	001, 002, 021, 097

Shogun	087
Sony	075, 076, 077, 078, 079, 121, 122
STS	023
Sylvania	009, 015, 016, 017, 041, 049, 094
Symphonic	009, 094
Tandy	009
Tashiko	009, 088
Tatung	004, 026, 030
Teac	004, 009, 026, 094
Technics	024, 049
Teknika	009, 010, 022, 049, 088, 094
TMK	087, 092
Toshiba	013, 017, 020, 041, 059, 089, 098, 099, 117
Totevision	007, 087, 088
Unirech	087
Vecrtor Research	005, 062, 085, 089, 090
Victor	005, 045, 046, 085
Video Concepts	005, 027, 085, 089, 090
Videosonic	007, 087
Wards	013, 021, 023, 087, 088, 089, 091, 094, 097, 118, 119, 120
XR-1000	094
Yamaha	004, 005, 006, 026, 062, 085
Zenith	060, 078, 079

## TV

Admiral	045, 121
Adventura	122
Aiko	054
Akai	016, 027, 046
Alleron	062
A-Mark	007
Amtron	061
Anam	006, 007, 036
Anam National	061, 147
AOC	003, 007, 033, 038, 039, 047, 048, 049, 133
Archer	007
Audiovox	007, 061
Bauer	155
Belcor	047
Bell & Howell	045, 118
Bradford	061
Brockwood	003, 047
Candle	003, 030, 031, 032, 038, 047, 049, 050, 122
Capehart	003
Celebrity	046

Circuit City	003
Citizen	029, 030, 031, 032, 034, 038, 047, 049, 050, 054, 061, 095, 122, 123
Concerto	031, 047, 049
Colortyme	003, 047, 049, 135
Contec	013, 051, 052, 061
Cony	051, 052, 061
Craig	004, 061
Crown	029
Curtis Mathes	029, 034, 038, 044, 047, 049, 053, 095, 118
Daewoo	027, 029, 039, 048, 049, 054, 055, 106, 107, 137
Daytron	003, 049
Dimensia	044
Dixi	007, 015, 027
Electroband	046
Electrohome	029, 056, 057, 058, 147
Elta	027
Emerson	029, 051, 059, 060, 061, 062, 118, 123, 124, 139, 148
Envision	038
Etron	027
Fisher	014, 021, 063, 064, 065, 118
Formenti	155
Fortress	012
Fujitsu	004, 062
Funai	004, 062
Futuretech	004
GE	020, 036, 037, 040, 044, 058, 066, 088, 119, 120, 125, 147
Goldstar	000, 015, 029, 031, 039, 048, 051, 056, 057, 067, 068, 069, 116
Grundy	062
Hitachi	029, 031, 051, 052, 070, 111, 112, 113, 124, <b>*[134]</b>
Hitachi Pay TV	151
Infinity	017, 071
Janeil	122
JBL	017, 071
JC Penny	020, 034, 039, 040, 041, 044, 048, 050, 058, 066, 069, 076, 088, 090, 095, 125, 136, 159
JCB	046
JVC	019, 051, 052, 072, 073, 091, 117, 126
Kawasho	018, 046
Kenwood	038, 056, 057
Kloss	010, 032
Kloss Novabeam	005, 122, 127, 131

KTV	074, 123
Loewe	071
Logik	144
Luxman	031
LXI	008, 014, 017, 024, 040, 044, 063, 071, 075, 076, 077, 118, 125
Magnavox	005, 010, 017, 030, 033, 038, 050, 056, 071, 078, 079, 085, 089, 108, 109, 110, 127, 131, 132, 145
Marantz	015, 017, 071, 080
Matsui	027
Memorex	014, 027, 045, 083, 118, 144
Metz	160, 161, 162, 163
MGA	001, 039, 048, 056, 057, 058, 065, 081, 083
Midland	125
Minutz	066
Mitsubishi	001, 016, 039, 048, 056, 057, 058, 065, 081, 082, 083, 105
Montgomery Ward	011, 020, 144, 145, 146
Motorola	121, 147
MTC	031, 034, 039, 048, 095
NAD	008, 075, 076, 128
National	002, 036, 061, 147
National Quenties	002
NEC	031, 038, 039, 048, 057, 084, 086, 135, 147
Nikko	054
NTC	054
Optimus	128
Optonica	011, 012, 093, 121
Orion	004, 139
Panasonic	002, 009, 017, 036, 037, 071, 141, 143, 147
Philco	005, 010, 030, 050, 051, 056, 079, 085, 127, 131, 132, 145, 147
Philips	005, 015, 017, 050, 051, 056, 078, 087, 088, 089, 131, 132, 147
Pioneer	124, 128, 142
Portland	054
Price Club	095
Proscan	040, 044, 125
Proton	035, 051, 092, 129
Pulsar	042
Quasar	036, 037, 074, 141
Radio Shack	011, 044, 063, 093, 118
RCA	040, 044, 125, 130, 137, 151, 152
Realistic	014, 063, 093, 118
Saisho	027

Samsung	003, 015, 034, 053, 055, 057, 094, 095, 136, 153
Sansui	139
Sanyo	013, 014, 021, 022, 063, 064, 081, 096
SBR	015
Schneider	015
Scott	062
Sears	008, 014, 021, 022, 023, 024, 025, 040, 052, 057, 062, 063, 064, 065, 073, 075, 076, 097, 098, 125, 159
Sharp	011, 012, 013, 026, 093, 099, 100, 104, 121
Siemens	013
Signature	045, 144
Simpson	050
Sony	043, 046, 138, 146, 150
Soundesign	030, 050, 062
Spectricon	007, 033
Squareview	004
Supre-Macy	032, 122
Supreme	046
Sylvania	005, 010, 017, 030, 078, 079, 085, 089, 101, 127, 131, 132, 145, 155
Symphonic	004, 148
Tandy	012, 121
Tatung	036, 124
Technics	037
Teknika	001, 030, 032, 034, 052, 054, 078, 083, 095, 144, 156, 157
Tera	035, 129
Toshiba	008, 014, 034, 063, 075, 076, 095, 097, 136, 158, 159
Universal	020, 066, 088
Victor	019, 073, 126
Video Concepts	016
Viking	032, 122
Wards	005, 045, 066, 078, 085, 088, 089, 093, 102, 103, 131, 132, 148
Zenith	042, 114, 115, 140, 144, 149
Zonda	007

## CABLE

ABC	006, *[007], 008, 009
Archer	010, 011
Century	011
Citizen	011
Colour Voice	012, 013
Comtronic	014

Eastern	015
Garrard	011
Gemini	030, 033, 034
General Instrument	030, 031, 032
Hytex	006
Jasco	011
Jerrold	009, 016, 017, 026, 032
Magnavox	018
Movie Time	019
NSC	019
Oak	000, 006, 020
Panasonic	001, 005
Philips	011, 012, 013, 018, 021
Pioneer	002, 003, 022
RCA	029
Regency	015
Samsung	014, 023
Scientific Atlanta	004, 024, 025
Signal	014
SL Marx	014
Starcom	009
Stargate	014
Teleview	014
Tocom	007, 016
TV86	019
Unika	011
United Artists	006
Universal	010, 011
Viewstar	018, 019
Zenith	027, 028

## DBS (SATELLITE)

Alphastar	054
Chaparral	035, 036
Dishnet	053
Drake	037, 038
Echostar Dish	062, 066
GE	048, 055, 056
General Instruments	039, 040, 041
Grundig	070, 071, 072, 073
Hitachi	058, 059
Hughes Network	063, 064, 065, 069
JVC	057
Kathrein	074, 075, 076, 083
Magnavox	060
Nokia	070, 080, 084, 085, 086
Philips	060
Primestar	051
Proscan	048, 055, 056

RCA	048, 055, 056, 068
Realistic	042
Sierra I	036
Sierra II	036
Sierra III	036
Sony	049, 067
STS1	043
STS2	044
STS3	045
SRS4	046
Technisat	077, 078, 079, 081, 082
Toshiba	047, 050
Uniden	061

### CD

Denon	<b>*[111]</b>
Aiwa	001, 035, 043
Burmster	002
Carver	003, 035
Emerson	004, 005, 006, 007
Fisher	003, 008, 009, 010
JVC	018, 019
Kenwood	011, 012, 013, 014, 017
Magnavox	006, 015, 035
Marantz	016, 028, 035
MCS	016, 024
Onkyo	025, 027
Optimus	017, 020, 021, 022, 023
Philips	014, 032, 033, 035
Pioneer	006, 022, 030
Sears	006
Sony	023, 031
Teac	002, 009, 028
Technics	016, 029, 036
Wards	035, 037
Yamaha	038, 039, 040, 041
Zenith	042

### CDR

Denon	<b>*[111], 112</b>
Philips	112

### MD

Denon	113
Kenwood	003, 004
Onkyo	007
Sharp	005
Sony	006

### TAPE

Denon	<b>*[111]</b>
Aiwa	001, 002
Carver	002
Harman/Kardon	002, 003
JVC	004, 005
Kenwood	006
Magnavox	002
Marantz	002
Onkyo	016, 018
Optimus	007, 008
Panasonic	012
Philips	002
Pioneer	007, 008, 009
Sony	013, 014, 015
Technics	012
Victor	004
Wards	007
Yamaha	010, 011

\*[ ] : Preset codes set upon shipment from the factory.

\*[ ] : Les codes pré-réglés diffèrent en fonction des livraisons de l'usine.

DVD preset codes Codes pré-réglés DVD	0000	0001
<b>DENON</b> Model No. Modèle numéro	DVD-700 DVD-900 DVD-1000 DVD-1400 DVD-1500 DVD-2200 DVD-2800 DVD-2800II DVD-2900 DVD-3800 DVD-A11 DVD-A1	DVD-800 DVD-1600 DVD-2000 DVD-2500 DVD-3000 DVD-3300

**MEMO:**



**MEMO:**

**MEMO:**

**DENON,Ltd.**

16-11, YUSHIMA 3-CHOME, BUNKYO-KU, TOKYO 113-0034, JAPAN  
Telephone: (03) 3837-5321

## Free Manuals Download Website

<http://myh66.com>

<http://usermanuals.us>

<http://www.somanuals.com>

<http://www.4manuals.cc>

<http://www.manual-lib.com>

<http://www.404manual.com>

<http://www.luxmanual.com>

<http://aubethermostatmanual.com>

Golf course search by state

<http://golfingnear.com>

Email search by domain

<http://emailbydomain.com>

Auto manuals search

<http://auto.somanuals.com>

TV manuals search

<http://tv.somanuals.com>