

AlphaPC 164SX Motherboard DIGITAL UNIX

User's Manual

Order Number: EC-R8P7B-TE

Revision/Update Information: This is a revised document. It supersedes the *AlphaPC 164SX Motherboard DIGITAL UNIX User's Manual*, EC-R8P7A-TE.

October 1998

The information in this publication is subject to change without notice.

COMPAQ COMPUTER CORPORATION SHALL NOT BE LIABLE FOR TECHNICAL OR EDITORIAL ERRORS OR OMISSIONS CONTAINED HEREIN, NOR FOR INCIDENTAL OR CONSEQUENTIAL DAMAGES RESULTING FROM THE FURNISHING, PERFORMANCE, OR USE OF THIS MATERIAL. THIS INFORMATION IS PROVIDED "AS IS" AND COMPAQ COMPUTER CORPORATION DISCLAIMS ANY WARRANTIES, EXPRESS, IMPLIED OR STATUTORY AND EXPRESSLY DISCLAIMS THE IMPLIED WARRANTIES OF MERCHANTABILITY, FITNESS FOR PARTICULAR PURPOSE, GOOD TITLE AND AGAINST INFRINGEMENT.

This publication contains information protected by copyright. No part of this publication may be photocopied or reproduced in any form without prior written consent from Compaq Computer Corporation.

©1998 Compaq Computer Corporation. All rights reserved. Printed in U.S.A.

AlphaPC, COMPAQ, DECnet, DIGITAL, DIGITAL UNIX, OpenVMS, the Compaq logo, and the DIGITAL logo registered in United States Patent and Trademark Office.

Cypress and hyperCache are trademarks of Cypress Semiconductor Corporation.

GRAFOIL is a registered trademark of Union Carbide Corporation.

Linux is a registered trademark of Linus Torvalds in the United States and other countries.

Microsoft, MS-DOS, and Windows are registered trademarks and Windows NT is a trademark of Microsoft Corporation.

SMC is a registered trademark of Standard Microsystems Corporation.

UNIX is a registered trademark in the United States and other countries, licensed exclusively through X/Open Company Limited.

Other product names mentioned herein may be trademarks and/or registered trademarks of their respective companies.

Contents

1 About This Manual

1.1	Manual Conventions and Terminology	1-1
-----	--	-----

2 Features

2.1	Power Requirements	2-4
2.2	Environmental Requirements	2-4
2.3	Physical Parameters	2-5
2.3.1	ATX Hole Specification	2-6
2.3.2	ATX I/O Shield Requirements	2-7

3 AlphaPC 164SX Switch Configuration

3.1	Mini-Debugger (CF3)	3-1
3.2	CPU Speed Selection (CF[6:4])	3-1
3.3	Fail-Safe Booter (CF7)	3-1

4 AlphaPC 164SX Connector Pinouts

4.1	PCI Bus Connector Pinouts	4-1
4.2	ISA Expansion Bus Connector Pinouts	4-3
4.3	SDRAM DIMM Connector Pinouts	4-4
4.4	EIDE Drive Bus Connector Pinouts	4-5
4.5	Diskette (Floppy) Drive Bus Connector Pinouts	4-6
4.6	Parallel Bus Connector Pinouts	4-6
4.7	COM1/COM2 Serial Line Connector Pinouts	4-7
4.8	Keyboard/Mouse Connector Pinouts	4-7
4.9	SRAM Test Data Input Connector Pinouts	4-8
4.10	Input Power Connector Pinouts	4-8
4.11	Enclosure Fan Power Connector Pinouts	4-8

4.12	Microprocessor Fan Power Connector Pinouts	4-9
4.13	Soft Power Connector Pinouts	4-9
4.14	Multipurpose Connector Pinouts	4-9

5 Memory and Microprocessor Configuration

5.1	Configuring SDRAM Memory	5-1
5.2	Upgrading SDRAM Memory	5-2
5.3	Increasing Microprocessor Speed.	5-3
5.3.1	Preparatory Information	5-3
5.3.2	Required Tools	5-3
5.3.3	Removing the 21164PC Microprocessor	5-4
5.3.4	Installing the 21164PC Microprocessor	5-4

6 Interrupts and ISA Bus Addresses

6.1	Interrupts	6-1
6.2	ISA I/O Address Map	6-2

7 Alpha SRM Console Firmware

7.1	Alpha SRM Console Firmware Conventions.	7-1
7.2	Basic Alpha SRM Console Command Descriptions	7-3
7.3	Environment Variables for Alpha SRM Console Commands	7-18
7.3.1	Environment Variable Descriptions	7-18
7.3.1.1	Architecture-Required Environment Variables	7-19
7.3.1.2	System-Defined Environment Variables	7-20
7.4	Using the AlphaBIOS Firmware Update Utility to Update the Flash ROM	7-22
7.4.1	AlphaBIOS Conventions	7-22
7.4.2	Starting the AlphaBIOS	7-23
7.4.3	Installing Alpha SRM Console Using AlphaBIOS Setup Program	7-24
7.5	Installing the DIGITAL UNIX Operating System	7-29
7.5.1	Requirements	7-29

8 Troubleshooting

8.1	Hardware Startup	8-1
8.2	Beep Codes	8-2
8.3	Post Codes	8-2
8.4	Fail-Safe Booter	8-4

9 Battery Recycle/Disposal Information

A Support, Products, and Documentation

A.1	Customer Support	A-1
A.2	Supporting Products	A-2
A.2.1	Memory	A-2
A.2.2	Thermal Products	A-2
A.2.3	Power Supply	A-2
A.2.4	Enclosure	A-3
A.3	Associated Documentation	A-3

Figures

2-1	AlphaPC 164SX Switch/Connector/Component Location	2-2
2-2	ATX Hole Specification	2-6
2-3	ATX I/O Shield Dimensions	2-7
3-1	AlphaPC 164SX Configuration Switches	3-2
4-1	Multipurpose Connector Pinouts	4-10
5-1	Fan/Heat-Sink Assembly	5-5
7-1	AlphaBIOS Boot Screen	7-23
7-2	AlphaBIOS Setup Screen	7-24
7-3	AlphaBIOS Upgrade Options Screen	7-25
7-4	AlphaBIOS Warning Screen	7-26
7-5	AlphaBIOS Upgrade SRM Console Screen	7-27
7-6	AlphaBIOS Upgrade Complete Screen	7-28

Tables

2-1	AlphaPC 164SX Features	2-1
2-2	AlphaPC 164SX Switch/Connector/Component List	2-3
2-3	Power Supply DC Current Requirements	2-4
2-4	AlphaPC 164SX Motherboard Environmental Requirements	2-5
4-1	PCI Bus Connector Pinouts	4-1
4-2	ISA Expansion Bus Connector Pinouts (J22, J23)	4-3
4-3	SDRAM DIMM Connector Pinouts (J7 through J10)	4-4
4-4	EIDE Drive Bus Connector Pinouts (J5, J6)	4-5
4-5	Diskette (Floppy) Drive Bus Connector Pinouts (J11)	4-6
4-6	Parallel Bus Connector Pinouts (J13)	4-6
4-7	COM1/COM2 Serial Line Connector Pinouts (J3)	4-7
4-8	Keyboard/Mouse Connector Pinouts (J4)	4-7
4-9	SRAM Test Data Input Connector Pinouts (J21)	4-8
4-10	Input Power Connector Pinouts (J2)	4-8
4-11	Enclosure Fan (+12 V dc) Power Connector Pinouts (J16)	4-8
4-12	Microprocessor Fan Power Connector Pinouts (J14)	4-9
4-13	Soft Power Connector Pinouts (J1)	4-9
4-14	Multipurpose Connector Pinouts (J20)	4-9
5-1	AlphaPC 164SX SDRAM Memory Configurations	5-2
6-1	ISA Interrupts	6-1
6-2	ISA I/O Address Map	6-2
7-1	AlphaBIOS Keys	7-22
8-1	Beep Codes	8-2
8-2	Post Codes	8-2

About This Manual

This manual describes the AlphaPC 164SX motherboard, a board for computing systems based on the Alpha 21164PC microprocessor and the companion 21174 core logic chip. It describes the motherboard's features and how to set its configuration switches. This manual helps users to install and populate the AlphaPC 164SX motherboard with memory boards and peripheral cards.

1.1 Manual Conventions and Terminology

The following conventions are used in this manual.

Caution: Cautions indicate potential damage to equipment, software, or data.

Note: Notes provide additional information about a topic.

Numbering: All numbers are decimal or hexadecimal unless otherwise indicated. In case of ambiguity, a subscript indicates the radix of nondecimal numbers. For example, 19 is a decimal number, but 19_{16} and 19A are hexadecimal numbers.

Extents: Extents are specified by a single number or a pair of numbers in brackets ([]) separated by a colon (:), and are inclusive. For example, bits [7:3] specify an extent including bits 7, 6, 5, 4, and 3. Multiple bit fields are shown as extents.

Register Figures: Register figures have bit and field position numbering starting at the right (low-order) and increasing to the left (high-order).

Signal Names: All signal names are printed in **boldface** type. Signal names that originate in an industry-standard specification, such as PCI or IDE, are printed in the case as found in the specification (usually uppercase). Active low signals have either a pound sign “#” appended, or a “not” overscore bar; for example, **DEVSEL#** and **RESET**.

Italic Type: *Italic* type emphasizes important information and indicates complete titles of documents.

Manual Conventions and Terminology

Terms: The following terms are used in this manual:

This term...	Refers to...
Alpha SRM console	The Alpha SRM Console firmware
DIGITAL UNIX installation guide	The <i>DIGITAL UNIX Installation Guide</i>
DIGITAL UNIX	The DIGITAL UNIX operating system

Table 2–1 provides an overview of the AlphaPC 164SX motherboard’s features.

Table 2–1 AlphaPC 164SX Features

Feature	Description
Microprocessor	Alpha 21164PC microprocessor (64-bit RISC)
Core logic chip	21174 core logic chip, comprising a single control chip that provides an interface to system memory and the PCI bus
Synchronous DRAM (SDRAM) memory	32MB to 512MB memory array -- Two banks of 128-bit memory; 168-pin unbuffered SDRAM DIMMs.
Caching	
L1 Icache	16KB, direct-mapped, instruction cache on the CPU chip
L1 Dcache	8KB, direct-mapped, data cache on the CPU chip
L2 backup cache	Onboard 1MB, direct-mapped, synchronous SSRAM backup cache with 128-bit data path
I/O and miscellaneous support	<ul style="list-style-type: none"> • 32-bit and 64-bit, 33-MHz PCI • Two 64-bit and two 32-bit PCI expansion slots • Cypress CY82C693U–NC chip with a PCI-to-ISA bridge, PCI EIDE, keyboard, mouse, and time-of-year clock • Two dedicated ISA expansion slots • SMC FDC37C669 combination controller chip provides control for diskettes, two UARTs with modem control, and parallel port • 1MB flash ROM
Firmware	Alpha SRM Console firmware

Figure 2–1 shows the AlphaPC 164SX motherboard and its components, and Table 2–2 describes these components.

Figure 2–1 AlphaPC 164SX Switch/Connector/Component Location

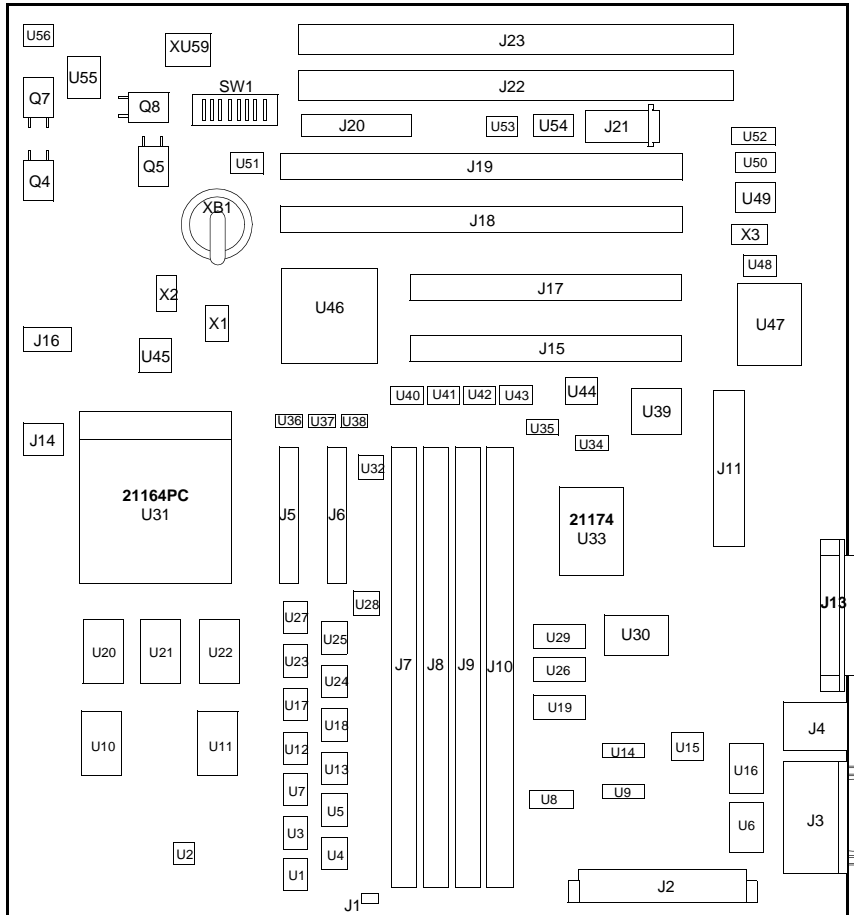

Table 2–2 AlphaPC 164SX Switch/Connector/Component List

Item No.	Description	Item No.	Description
XB1	RTC battery (CR2032)	J20	LEDs/speaker/buttons connectors
J1	Soft power connector	J21	SRAM test port connector
J2	Input power (+3 V, +5 V, -5 V, +12 V, -12 V)	J22	ISA slot 1
J3	COM1/COM2 (DB9) connectors	J23	ISA slot 0
J4	Keyboard/mouse connectors	SW1	Configuration switchpack
J5	EIDE drive 2/3 connector	U48	System clock PLL (CY2081)
J6	EIDE drive 0/1 connector	U10, U11, U20, U22	L2 cache data SRAMs
J7	SDRAM DIMM 0 [0:63] connector	U21	L2 cache tag SRAM
J8	SDRAM DIMM 1 [64:128] connector	U33	21174 core logic chip
J9	SDRAM DIMM 2 [0:63] connector	U19, U26, U29	Memory address/control buffers
J10	SDRAM DIMM 3 [64:128] connector	U1, U3, U4, U5, U7, U12, U13, U17, U18, U23, U24, U25, U27	Data switches
J11	Diskette (floppy) drive connector	U40 to U43	Interrupt shift registers
J13	Parallel I/O connector	U30	Flash ROM (1MB)
J14	Microprocessor fan/fan sense connector	U46	PCI-ISA Bridge (CY82C693U-NC)
J15	PCI slot 3 (32-bit)	U36 to U38	IDE buffers
J16	Fan power, enclosure (+12 V)	U47	Combination controller (FDC37C669)
J17	PCI slot 2 (32-bit)	U2, U28, U32	Reg-reg cache isolate logic
J18	PCI slot 1 (64-bit)	U31	Microprocessor, socketed (Alpha 21164PC)
J19	PCI slot 0 (64-bit)	U45	Microprocessor clock synthesizer (MC12439)

Power Requirements

2.1 Power Requirements

The AlphaPC 164SX motherboard has a total power dissipation of 90 W, excluding any plug-in PCI and ISA devices. Table 2–3 lists the power requirement for each dc supply voltage.

The power supply must be ATX-compliant.

Table 2–3 Power Supply DC Current Requirements

Voltage/Tolerance	Current ¹
+3.3 V dc, ±5%	5.0 A
+5 V dc, ±5%	12.0 A
–5 V dc, ±5%	0.0 A
+12 V dc, ±5%	1.0 A
–12 V dc, ±5%	100.0 mA

¹ Values indicated are for an AlphaPC 164SX motherboard with an Alpha 21164PC microprocessor operating at 400 MHz, with 128MB SDRAM, excluding adapter cards and disk drives.

Caution: **Fan sensor required.** The 21164PC microprocessor cooling fan *must* drive an RPM indicator signal. If the airflow stops, the sensor on the motherboard detects that the RPM has stopped, and resets the system.

2.2 Environmental Requirements

The 21164PC microprocessor is cooled by a small fan blowing directly into the chip’s heat sink. The AlphaPC 164SX motherboard is designed to run efficiently by using only this fan. Additional fans may be necessary depending upon cabinetry and the requirements of plug-in cards.

The AlphaPC 164SX motherboard is specified to run within the environment listed in Table 2–4.

Table 2–4 AlphaPC 164SX Motherboard Environmental Requirements

Parameter	Specification
Operating temperature	10°C to 40°C (50°F to 104°F)
Storage temperature	–55°C to 125°C (–67°F to 257°F)
Relative humidity	10% to 90% with maximum wet bulb temperature 28°C (82°F) and minimum dew point 2°C (36°F)
Rate of (dry bulb) temperature change	11°C/hour \pm 2°C/hour (20°F/hour \pm 4°F/hour)

2.3 Physical Parameters

The AlphaPC 164SX motherboard is an ATX-size printed-wiring board (PWB) with the following dimensions:

- Length: 30.48 cm (12.0 in \pm 0.0005 in)
- Width: 24.38 cm (9.6 in \pm 0.0005 in)
- Height: 6.00 cm (2.4 in)

Physical Parameters

2.3.1 ATX Hole Specification

Figure 2-2 shows the ATX hole specification for the AlphaPC 164SX.

Figure 2-2 ATX Hole Specification

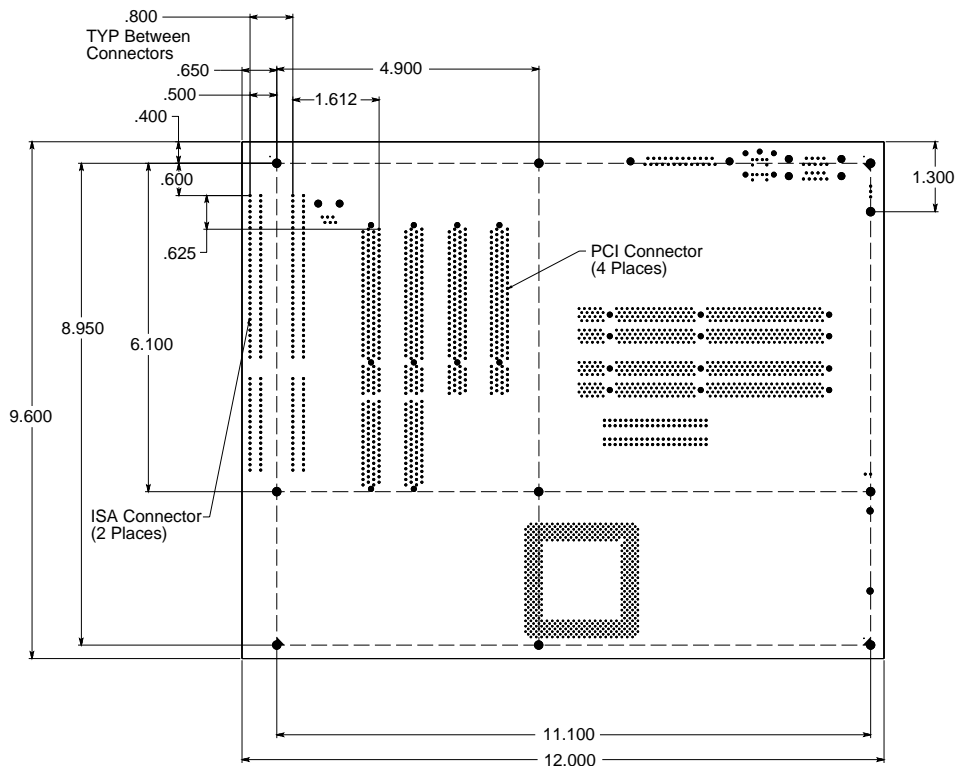

FM-06122.A14

2.3.2 ATX I/O Shield Requirements

Figure 2-3 shows the ATX I/O shield dimensions for the AlphaPC 164SX.

Figure 2-3 ATX I/O Shield Dimensions

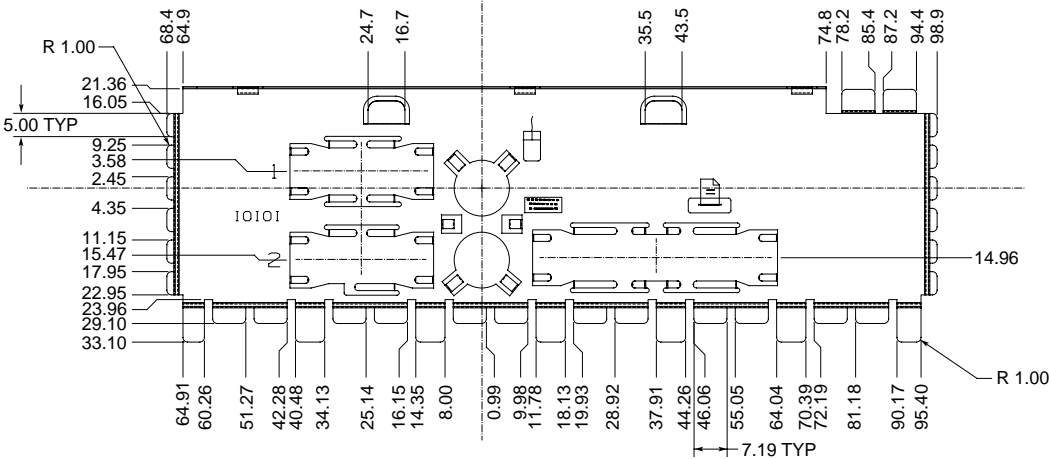

FM-05986.A14

AlphaPC 164SX Switch Configuration

The AlphaPC 164SX motherboard has a switchpack located at SW1, as shown previously in Figure 2–1. These switches set the hardware configuration. Figure 3–1 shows these switch configurations.

3.1 Mini-Debugger (CF3)

The Alpha SROM Mini-Debugger is stored in the flash ROM and is enabled/disabled by switch CF3. The default position for this switch is on (see Figure 3–1). When this switch is off, it causes the SROM initialization to trap to the Mini-Debugger after all initialization is complete, but before starting the execution of the system flash ROM code.

3.2 CPU Speed Selection (CF[6:4])

The clock synthesizer at U45 makes it possible to change the frequency of the microprocessor's clock output. The switch configuration is set in SW1, CF[6:4]. These three switches set the speed at power-up as listed in Figure 3–1. The microprocessor frequency divided by the ratio determines the system clock frequency.

3.3 Fail-Safe Booter (CF7)

The fail-safe booter provides an emergency recovery mechanism when the primary firmware image contained in flash memory has been corrupted. When flash memory has been corrupted, and no image can be loaded safely from the flash, you can run the fail-safe booter and boot another image from a diskette that is capable of reprogramming the flash.

Refer to Section 8.4 for more information.

Fail-Safe Booter (CF7)

Figure 3–1 AlphaPC 164SX Configuration Switches

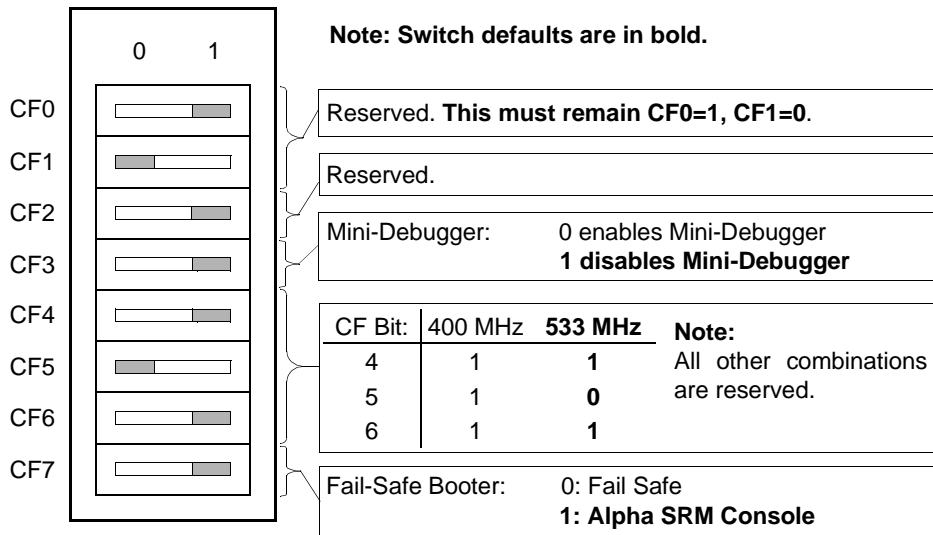

4

AlphaPC 164SX Connector Pinouts

This chapter lists the pinouts of the AlphaPC 164SX connectors (see Table 4–1 through Table 4–14). See Figure 2–1 for connector locations.

4.1 PCI Bus Connector Pinouts

Table 4–1 shows the PCI bus connector pinouts.

Table 4–1 PCI Bus Connector Pinouts

(Sheet 1 of 2)

Pin	Signal	Pin	Signal	Pin	Signal	Pin	Signal
32-Bit and 64-Bit PCI Connectors (J15, J17, J18, J19)							
A1	TRST#	A2	+12V	A3	TMS	A4	TDI
A5	Vdd	A6	INTA	A7	INTC	A8	Vdd
A9	—	A10	Vdd	A11	—	A12	Gnd
A13	Gnd	A14	—	A15	RST#	A16	Vdd
A17	GNT#	A18	Gnd	A19	—	A20	AD[30]
A21	+3V	A22	AD[28]	A23	AD[26]	A24	Gnd
A25	AD[24]	A26	IDSEL	A27	+3V	A28	AD[22]
A29	AD[20]	A30	Gnd	A31	AD[18]	A32	AD[16]
A33	+3V	A34	FRAME#	A35	Gnd	A36	TRDY#
A37	STOP#	A38	STOP#	A39	+3V	A40	SDONE
A41	SBO#	A42	Gnd	A43	PAR	A44	AD[15]
A45	+3V	A46	AD[13]	A47	AD[11]	A48	Gnd
A49	AD[09]	A50	Not used	A51	Not used	A52	C/BE#[0]
A53	+3V	A54	AD[06]	A55	AD[04]	A56	Gnd
A57	AD[02]	A58	AD[00]	A59	Vdd	A60	REQ64#
A61	Vdd	A62	Vdd	B1	-12V	B2	TCK
B3	Gnd	B4	TDO	B5	Vdd	B6	Vdd
B7	INTB	B8	INTD	B9	PRSENT1#	B10	—

PCI Bus Connector Pinouts

Table 4–1 PCI Bus Connector Pinouts

(Sheet 2 of 2)

Pin	Signal	Pin	Signal	Pin	Signal	Pin	Signal
B11	PRSENT2#	B12	Gnd	B13	Gnd	B14	—
B15	Gnd	B16	CLK	B17	Gnd	B18	REQ#
B19	Vdd	B20	AD[31]	B21	AD[29]	B22	Gnd
B23	AD[27]	B24	AD[25]	B25	+3V	B26	C/BE#[3]
B27	AD[23]	B28	Gnd	B29	AD[21]	B30	AD[19]
B31	+3V	B32	AD[17]	B33	C/BE#[2]	B34	Gnd
B35	IRDY#	B36	+3V	B37	DEVSEL#	B38	Gnd
B39	LOCK#	B40	PERR#	B41	+3V	B42	SERR#
B43	+3V	B44	C/BE#[1]	B45	AD[14]	B46	Gnd
B47	AD[12]	B48	AD[10]	B49	Gnd	B50	Not used
B51	Not used	B52	AD[08]	B53	AD[07]	B54	+3V
B55	AD[05]	B56	AD[03]	B57	Gnd	B58	AD[01]
B59	Vdd	B60	ACK64#	B61	Vdd	B62	Vdd
64-Bit PCI Connectors Only (J18, J19)							
A63	Gnd	A64	C/BE#[7]	A65	C/BE#[5]	A66	Vdd
A67	PAR64	A68	D[62]	A69	Gnd	A70	D[60]
A71	D[58]	A72	Gnd	A73	D[56]	A74	D[54]
A75	Vdd	A76	D[52]	A77	D[50]	A78	Gnd
A79	D[48]	A80	D[46]	A81	Gnd	A82	D[44]
A83	D[42]	A84	Vdd	A85	D[40]	A86	D[38]
A87	Gnd	A88	D[36]	A89	D[34]	A90	Gnd
A91	D[32]	A92	—	A93	Gnd	A94	—
B63	—	B64	Gnd	B65	C/BE#[6]	B66	C/BE#[4]
B67	Gnd	B68	D[63]	B69	D[61]	B70	Vdd
B71	D[59]	B72	D[57]	B73	Gnd	B74	D[55]
B75	D[53]	B76	Gnd	B77	D[51]	B78	D[49]
B79	Vdd	B80	D[47]	B81	D[45]	B82	Gnd
B83	D[43]	B84	D[41]	B85	Gnd	B86	D[39]
B87	D[37]	B88	Vdd	B89	D[35]	B90	D[33]
B91	Gnd	B92	—	B93	—	B94	Gnd

4.2 ISA Expansion Bus Connector Pinouts

Table 4–2 shows the ISA expansion bus connector pinouts.

Table 4–2 ISA Expansion Bus Connector Pinouts (J22, J23)

Pin	Signal	Pin	Signal	Pin	Signal	Pin	Signal
1	Gnd	2	IOCHCK#	3	RSTDRV	4	SD7
5	Vdd	6	SD6	7	IRQ9	8	SD5
9	–5V	10	SD4	11	DRQ2	12	SD3
13	–12V	14	SD2	15	ZEROWS#	16	SD1
17	+12V	18	SD0	19	Gnd	20	IOCHRDY
21	SMEMW#	22	AEN	23	SMEMR#	24	SA19
25	IOW#	26	SA18	27	IOR#	28	SA17
29	DACK3#	30	SA16	31	DRQ3	32	SA15
33	DACK1#	34	SA14	35	DRQ1	36	SA13
37	REFRESH#	38	SA12	39	SYCLK	40	SA11
41	IRQ7	42	SA10	43	IRQ6	44	SA9
45	IRQ5	46	SA8	47	IRQ4	48	SA7
49	IRQ3	50	SA6	51	DACK2#	52	SA5
53	TC	54	SA4	55	BALE	56	SA3
57	Vdd	58	SA2	59	OSC	60	SA1
61	Gnd	62	SA0	63	MEMCS16#	64	SBHE#
65	IOCS16#	66	LA23	67	IRQ10	68	LA22
69	IRQ11	70	LA21	71	IRQ12	72	LA20
73	IRQ15	74	LA19	75	IRQ14	76	LA18
77	DACK0#	78	LA17	79	DRQ0	80	MEMR#
81	DACK5#	82	MEMW#	83	DRQ5	84	SD8
85	DACK6#	86	SD9	87	DRQ6	88	SD10
89	DACK7#	90	SD11	91	DRQ7	92	SD12
93	Vdd	94	SD13	95	MASTER#	96	SD14
97	Gnd	98	SD15	—	—	—	—

SDRAM DIMM Connector Pinouts

4.3 SDRAM DIMM Connector Pinouts

Table 4–3 shows the SDRAM DIMM connector pinouts.

Table 4–3 SDRAM DIMM Connector Pinouts (J7 through J10)¹

(Sheet 1 of 2)

Pin	Signal	Pin	Signal	Pin	Signal	Pin	Signal
1	Gnd	2	DQ0	3	DQ1	4	DQ2
5	DQ3	6	+3V	7	DQ4	8	DQ5
9	DQ6	10	DQ7	11	DQ8	12	Gnd
13	DQ9	14	DQ10	15	DQ11	16	DQ12
17	DQ13	18	+3V	19	DQ14	20	DQ15
21	CB0	22	CB1	23	Gnd	24	NC
25	NC	26	+3V	27	$\overline{\text{WE}}$	28	DQMB0
29	DQMB1	30	$\overline{\text{S0}}$	31	NC	32	Gnd
33	A0	34	A2	35	A4	36	A6
37	A8	38	A10	39	A12	40	+3V
41	+3V	42	CK0	43	Gnd	44	NC
45	$\overline{\text{S2}}$	46	DQMB2	47	DQMB3	48	NC
49	+3V	50	NC	51	NC	52	CB2
53	CB3	54	Gnd	55	DQ16	56	DQ17
57	DQ18	58	DQ19	59	+3V	60	DQ20
61	NC	62	NC	63	CKE1	64	Gnd
65	DQ21	66	DQ22	67	DQ23	68	Gnd
69	DQ24	70	DQ25	71	DQ26	72	DQ27
73	+3V	74	DQ28	75	DQ29	76	DQ30
77	DQ31	78	Gnd	79	CK2	80	NC
81	NC	82	SDA	83	SCL	84	+3V
85	Gnd	86	DQ32	87	DQ33	88	DQ34
89	DQ35	90	+3V	91	DQ36	92	DQ37
93	DQ38	94	DQ39	95	DQ40	96	Gnd
97	DQ41	98	DQ42	99	DQ43	100	DQ44
101	DQ45	102	+3V	103	DQ46	104	DQ47
105	CB4	106	CB5	107	Gnd	108	NC
109	NC	110	+3V	111	$\overline{\text{CAS}}$	112	DQMB4
113	DQMB5	114	S1	115	RAS	116	Gnd
117	A1	118	A3	119	A5	120	A7
121	A9	122	BA0	123	A13	124	+3V

EIDE Drive Bus Connector Pinouts

Table 4–3 SDRAM DIMM Connector Pinouts (J7 through J10)¹

(Sheet 2 of 2)

Pin	Signal	Pin	Signal	Pin	Signal	Pin	Signal
125	CK1	126	BA1²	127	Gnd	128	CKE0
129	S$\bar{3}$	130	DQMB6	131	DQMB7	132	PD³
133	+3V	134	NC	135	NC	136	CB6
137	CB7	138	Gnd	139	DQ48	140	DQ49
141	DQ50	142	DQ51	143	+3V	144	DQ52
145	NC	146	NC	147	PD	148	Gnd
149	DQ53	150	DQ54	151	DQ55	152	Gnd
153	DQ56	154	DQ57	155	DQ58	156	DQ59
157	+3V	158	DQ60	159	DQ61	160	DQ62
161	DQ63	162	Gnd	163	CK3	164	NC
165	SA0	166	SA1	167	SA2	168	+3V

¹ Pins 1 through 84 are on the front side and pins 85 through 168 are on the back side.

² The AlphaPC 164SX uses **BA1** as both **BA1** and **ADDR12**. Therefore, four-bank DIMMs using **ADDR[11:0]** are the maximum size. (Two-bank DIMMs can use **ADDR[12:0]**.)

³ Pull-down.

4.4 EIDE Drive Bus Connector Pinouts

Table 4–4 shows the EIDE drive bus connector pinouts.

Table 4–4 EIDE Drive Bus Connector Pinouts (J5, J6)

Pin	Signal	Pin	Signal	Pin	Signal	Pin	Signal
1	RESET	2	Gnd	3	IDE_D7	4	IDE_D8
5	IDE_D6	6	IDE_D9	7	IDE_D5	8	IDE_D10
9	IDE_D4	10	IDE_D11	11	IDE_D3	12	IDE_D12
13	IDE_D2	14	IDE_D13	15	IDE_D1	16	IDE_D14
17	IDE_D0	18	IDE_D15	19	Gnd	20	NC (key pin)
21	MARQ	22	Gnd	23	IOW	24	Gnd
25	IOR	26	Gnd	27	CHRDY	28	BALE
29	MACK	30	Gnd	31	IRQ	32	IOCS16
33	ADDR1	34	NC	35	ADDR0	36	ADDR2
37	CS0	38	CS1	39	ACT	40	Gnd

Diskette (Floppy) Drive Bus Connector Pinouts

4.5 Diskette (Floppy) Drive Bus Connector Pinouts

Table 4–5 shows the diskette (floppy) drive bus connector pinouts.

Table 4–5 Diskette (Floppy) Drive Bus Connector Pinouts (J11)

Pin	Signal	Pin	Signal	Pin	Signal	Pin	Signal
1	Gnd	2	DEN0	3	Gnd	4	NC
5	Gnd	6	DEN1	7	Gnd	8	INDEX
9	Gnd	10	MTR0	11	Gnd	12	DR1
13	Gnd	14	DR0	15	Gnd	16	MTR1
17	Gnd	18	DIR	19	Gnd	20	STEP
21	Gnd	22	WDATA	23	Gnd	24	WGATE
25	Gnd	26	TRK0	27	Gnd	28	WRTPRT
29	ID0	30	RDATA	31	Gnd	32	HDSEL
33	ID1	34	DSKCHG	—	—	—	—

4.6 Parallel Bus Connector Pinouts

Table 4–6 shows the parallel bus connector pinouts.

Table 4–6 Parallel Bus Connector Pinouts (J13)

Pin	Signal	Pin	Signal	Pin	Signal	Pin	Signal
1	STB	2	PD0	3	PD1	4	PD2
5	PD3	6	PD4	7	PD5	8	PD6
9	PD7	10	ACK	11	BUSY	12	PE
13	SLCT	14	AFD	15	ERR	16	INIT
17	SLIN	18	Gnd	19	Gnd	20	Gnd
21	Gnd	22	Gnd	23	Gnd	24	Gnd
25	Gnd	—	—	—	—	—	—

4.7 COM1/COM2 Serial Line Connector Pinouts

Table 4–7 shows the COM1/COM2 serial line connector pinouts.

Table 4–7 COM1/COM2 Serial Line Connector Pinouts (J3)

COM1 Pin (Top)	COM1 Signal	COM2 Pin (Bottom)	COM2 Signal
1	DCD1	1	DCD2
2	RxD1	2	RxD2
3	TxD1	3	TxD2
4	DTR1	4	DTR2
5	SG1	5	SG2
6	DSR1	6	DSR2
7	RTS1	7	RTS2
8	CTS1	8	CTS2
9	RI1	9	RI2

4.8 Keyboard/Mouse Connector Pinouts

Table 4–8 shows the keyboard/mouse connector pinouts.

Table 4–8 Keyboard/Mouse Connector Pinouts (J4)

Keyboard Pin (Top)	Keyboard Signal	Mouse Pin (Bottom)	Mouse Signal
1	KBDATA	1	MSDATA
2	NC	2	NC
3	Gnd	3	Gnd
4	Vdd	4	Vdd
5	KBCLK	5	MSCLK
6	NC	6	NC

SROM Test Data Input Connector Pinouts

4.9 SROM Test Data Input Connector Pinouts

Table 4–9 shows the SROM test data input connector pinouts.

Table 4–9 SROM Test Data Input Connector Pinouts (J21)

Pin	Signal	Description
1	NC	—
2	SROM_CLK_L	Clock out
3	Gnd	—
4	NC	—
5	TEST_SROM_D_L	SROM serial data in
6	NC	—

4.10 Input Power Connector Pinouts

Table 4–10 shows the input power connector pinouts.

Table 4–10 Input Power Connector Pinouts (J2)¹

Pin	Voltage	Pin	Voltage	Pin	Voltage	Pin	Voltage
1	+3.3 V dc	2	+3.3 V dc	3	Gnd	4	+5 V dc
5	Gnd	6	+5 V dc	7	Gnd	8	P_DCOK
9	5 V SB	10	+12 V dc	11	+3.3 V dc	12	–12 V dc
13	Gnd	14	PS_ON	15	Gnd	16	Gnd
17	Gnd	18	–5 V dc	19	+5 V dc	20	+5 V dc

¹ This pinout is ATX-compliant.

4.11 Enclosure Fan Power Connector Pinouts

Table 4–11 shows the enclosure fan power connector pinouts.

Table 4–11 Enclosure Fan (+12 V dc) Power Connector Pinouts (J16)

Pin	Voltage
1	Gnd
2	+12 V dc
3	Gnd

4.12 Microprocessor Fan Power Connector Pinouts

Table 4–12 shows the microprocessor fan power connector pinouts.

Table 4–12 Microprocessor Fan Power Connector Pinouts (J14)

Pin	Signal	Description
1	+12 V dc	—
2	FAN_CONN_L	Fan connected
3	Gnd	—

4.13 Soft Power Connector Pinouts

Table 4–13 shows the soft power connector pinouts.

Table 4–13 Soft Power Connector Pinouts (J1)

Pin	Signal	Description
1	Input	System power on/off
2	Gnd	—

4.14 Multipurpose Connector Pinouts

J20 is a multipurpose connector that provides pins for the following functions:

- System speaker
- LEDs for power and the EIDE drive
- Buttons for reset and halt

Table 4–14 shows the multipurpose connector pinouts, and Figure 4–1 shows the connector layout.

Table 4–14 Multipurpose Connector Pinouts (J20)

(Sheet 1 of 2)

Pin	Signal	Description
1	Gnd	—
2	HALT_BUTTON	Halt system
3	Gnd	—
4	RESET_BUTTON	Reset system

Multipurpose Connector Pinouts

Table 4–14 Multipurpose Connector Pinouts (J20)

(Sheet 2 of 2)

Pin	Signal	Description
5	HD_PU	Hard drive power-up
6	HD_LED	Pull-up to Vdd
7	—	No connection
8	POWER_LED_L	Pull-up to Vdd
10, 12, 14, 16	Gnd	—
9	SPKR	Speaker output
15	Vdd	—
11, 13	—	No connection

Figure 4–1 Multipurpose Connector Pinouts

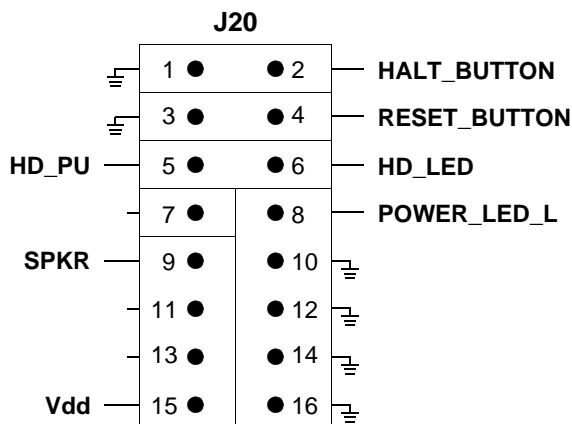

Memory and Microprocessor Configuration

For higher system speed or greater throughput, SDRAM memory can be upgraded by replacing DIMMs with those of greater size.

When configuring or upgrading SDRAM, observe the following rules:

- Each DIMM must be a 168-bit unbuffered version and have a frequency of 100 MHz.
- Each bank consists of two DIMMs and must be fully populated.
- Both DIMMs in the same bank must be of equal size.

5.1 Configuring SDRAM Memory

Although not an exhaustive list, Table 5–1 lists the tested SDRAM memory configurations available. As additional configurations become available, they will be posted in online revisions of this manual on the Alpha OEM World Wide Web Internet site. See Appendix A for the URL.

For a list of vendors who supply components and accessories for the AlphaPC 164SX, see Appendix A.

Refer to Figure 2–1 for DIMM connector locations.

Note: 1Mb × 72 and 1Mb × 64 DIMMs are not supported.

Upgrading SDRAM Memory

Table 5–1 AlphaPC 164SX SDRAM Memory Configurations

Total Memory	Bank 0 ¹		Bank 1 ¹	
	J7	J8	J9	J10
32MB	2Mb × 72	2Mb × 72	—	—
64MB	2Mb × 72	2Mb × 72	2Mb × 72	2Mb × 72
	4Mb × 72	4Mb × 72	—	—
96MB	4Mb × 72	4Mb × 72	2Mb × 72	2Mb × 72
128MB	4Mb × 72	4Mb × 72	4Mb × 72	4Mb × 72
	8Mb × 72	8Mb × 72	—	—
160MB	8Mb × 72	8Mb × 72	2Mb × 72	2Mb × 72
192MB	8Mb × 72	8Mb × 72	4Mb × 72	4Mb × 72
256MB	8Mb × 72	8Mb × 72	8Mb × 72	8Mb × 72
	16Mb × 72	16Mb × 72	—	—
512MB	16Mb × 72	16Mb × 72	16Mb × 72	16Mb × 72

¹ 64-bit-wide DIMMs can also be used.

5.2 Upgrading SDRAM Memory

You can upgrade memory in the AlphaPC 164SX by adding more DIMMs or replacing the ones you have with a greater size. Refer to Figure 2–1 for DIMM connector locations.

Use the following general guidelines:

1. *Observe antistatic precautions.* Handle DIMMs only at the edges to prevent damage.
2. Remove power from the system.

3. Align the DIMM so that the notch in the DIMM matches the key in the socket.
4. Firmly push the DIMM straight into the connector. Ensure that the DIMM snaps into the plastic locking levers on both ends.
5. Restore power to the system.

5.3 Increasing Microprocessor Speed

This section describes how to complete the following actions to increase microprocessor speed:

- Replace the Alpha 21164PC microprocessor with an Alpha chip that has a higher speed rating.
- Reconfigure the clock divisor switches.

5.3.1 Preparatory Information

Caution: Static-Sensitive Component – Due to the sensitive nature of electronic components to static electricity, anyone handling the microprocessor *must* wear a properly grounded antistatic wriststrap. Use of antistatic mats, ESD approved workstations, or exercising other good ESD practices is recommended.

An Alpha 21164PC microprocessor with a higher speed rating is available from your local distributor. See Appendix A for information about supporting products.

When replacing the microprocessor chip, also replace the thermal conducting GRAFOIL pad. See Appendix A for information about the parts kit, which includes the heat sink, GRAFOIL pad, two hex nuts, heat-sink clips, 52-mm fan, and four screws.

5.3.2 Required Tools

The following tools are required when replacing the microprocessor chip:

A TS30 manual nut/torque driver (or equivalent) with the following attachments is required to affix the heat sink and fan to the microprocessor's IPGA package:

- 1/4-inch hex bit
- 3/8-inch socket with 1/4-inch hex drive
- #2 Phillips-head screwdriver bit

Increasing Microprocessor Speed

5.3.3 Removing the 21164PC Microprocessor

Remove the microprocessor currently in place at location U31 by performing the following steps:

1. Unplug the fan power/sensor cable from connector J14 (see Figure 2–1).
2. Remove the four 6–32 × 0.625-inch screws that secure the fan to the heat sink.
3. Remove the fan.
4. If the sink/chip/fan clip is used, remove it by unhooking its ends from around the ZIF socket retainers.
5. Using a 3/8-inch socket, remove the two nuts securing the heat sink to the microprocessor studs.
6. Remove the heat sink by gently lifting it off the microprocessor.
7. Remove and discard the GRAFOIL heat conduction pad.
8. Thoroughly clean the bottom surface of the heat sink before affixing it to the new microprocessor.
9. Lift the ZIF socket actuator handle to a full 90° angle.
10. Remove the microprocessor chip by lifting it straight out of the socket.

5.3.4 Installing the 21164PC Microprocessor

Install the new microprocessor in location U31 by performing the following steps:

Note: Install the heat sink only after the microprocessor has been assembled to the ZIF socket.

1. Observe antistatic precautions.
2. Lift the ZIF socket actuator handle to a full 90° angle.
3. Ensure that all the pins on the microprocessor package are straight.
4. The ZIF socket and microprocessor are keyed to allow for proper installation. Align the microprocessor, with its missing AD01 pin, with the corresponding plugged AD01 position on the ZIF socket. Gently lower into position.
5. Close the ZIF socket actuator handle to its locked position.
6. Install the heat sink and heat-sink fan as directed in the following steps. A heat-sink/fan kit is available from the vendor listed in Appendix A. Refer to Figure 5–1 for heat-sink and fan assembly details.

Figure 5-1 Fan/Heat-Sink Assembly

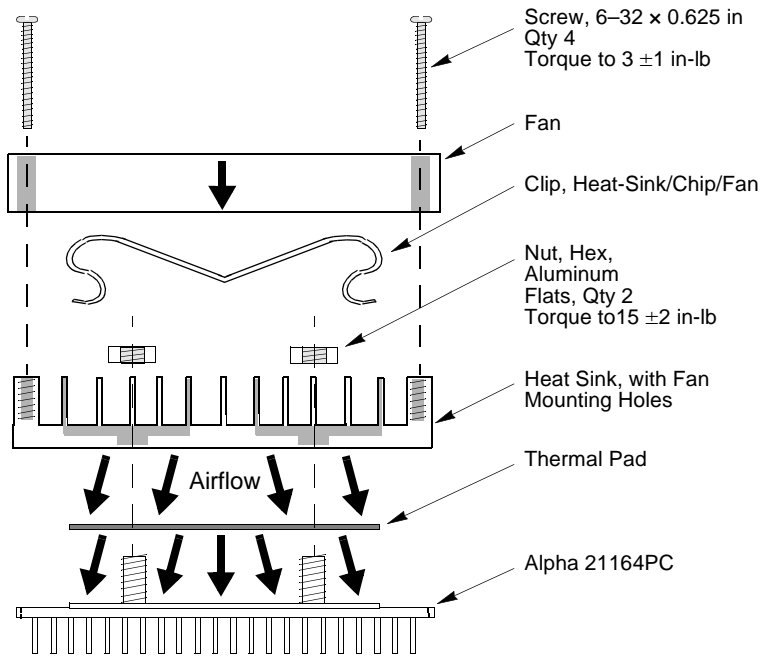

- a. Put the GRAFOIL thermal pad in place. The GRAFOIL pad is used to improve the thermal conductivity between the chip package and the heat sink by replacing micro air pockets with a less insulative material. Perform the following steps to position the GRAFOIL pad:
 1. Perform a visual inspection of the package slug to ensure that it is free of contamination.
 2. Wearing clean gloves, pick up the GRAFOIL pad. *Do not* perform this with bare hands because skin oils can be transferred to the pad.
 3. Place the GRAFOIL pad on the gold-plated slug surface and align it with the threaded studs.

Increasing Microprocessor Speed

- b. Attach the microprocessor heat sink. The heat-sink material is clear anodized, hot-water-sealed, 6061-T6 aluminum. The nut material is 2011-T3 aluminum (this grade is critical). Perform the following steps to attach the heat sink:
 1. Observe antistatic precautions.
 2. Align the heat-sink holes with the threaded studs on the ceramic package.
 3. Handle the heat sink by the edges and lower it onto the chip package, taking care not to damage the stud threads.
 4. Set a calibrated torque driver to 15 in-lb, ± 2 in-lb, (2.3 Nm, ± 0.2 Nm). The torque driver should have a mounted 3/8-inch socket.
 5. Insert a nut into the 3/8-inch socket, place on one of the studs, and tighten to the specified torque. Repeat for the second nut.
 6. If the sink/chip/fan clip is used, properly install it by positioning it over the assembly and hooking its ends around the ZIF socket retainers.
- c. Attach the heat-sink fan assembly:
 1. Place the fan assembly on top of the heat sink, aligning the fan mounting holes with the corresponding threaded heat-sink holes. Align the fan so that the fan power/sensor wires exit the fan closest to connector J14 (see Figure 2-1). Fan airflow must be directed into the heat sink (fan label facing down toward the heat sink).
 2. Using a calibrated torque driver set to 3 in-lb, ± 1 in-lb, secure the fan to the heat sink with four 6-32 \times 0.625-inch screws.
 3. Plug the fan power/sensor cable into connector J14.

Note: When installing the microprocessor, you must change the frequency of its clock output by setting the system clock divisor switches, as described in Section 3.2.

6

Interrupts and ISA Bus Addresses

This section lists the system and I/O interrupt assignments. It also lists the physical AlphaPC 164SX I/O space assignments.

6.1 Interrupts

Table 6–1 lists each AlphaPC 164SX ISA interrupt and its source.

Table 6–1 ISA Interrupts

(Sheet 1 of 2)

Interrupt Number	Interrupt Source
IRQ0	Internal timer 1
IRQ1	Keyboard
IRQ2	Interrupt from controller 2
IRQ3	COM2
IRQ4	COM1
IRQ5	Available
IRQ6	Diskette (floppy)
IRQ7	Parallel port
IRQ8# ¹	Reserved
IRQ9	Available
IRQ10	USB
IRQ11	Available
IRQ12	Mouse

ISA I/O Address Map

Table 6–1 ISA Interrupts

(Sheet 2 of 2)

Interrupt Number	Interrupt Source
IRQ13	Available
IRQ14	EIDE
IRQ15	EIDE

¹ The # symbol indicates an active low signal.

6.2 ISA I/O Address Map

Table 6–2 lists the AlphaPC 164SX ISA I/O space address mapping.

Table 6–2 ISA I/O Address Map

Range (hex)	Usage
000-00F	8237 DMA #1
020-021	8259 PIC #1
040-043	8253 timer
060-061	Ubus IRQ12 and NMI control
070	CMOS RAM address and NMI mask register
080-08F	DMA page registers
0A0-0A1	8259 PIC #2
0C0-0DF	8237 DMA #2
2F8-2FF	Serial port—COM2
370-377	Secondary diskette (floppy)
3BC-3BF	Parallel port—LPT1
3F0-3F7	Primary diskette (floppy)
3F8-3FF	Serial port—COM1

Alpha SRM Console Firmware

The Alpha SRM Console firmware initializes the system and enables you to install and boot the DIGITAL UNIX operating system. This firmware resides in the flash ROM on the AlphaPC 164SX motherboard.

7.1 Alpha SRM Console Firmware Conventions

The following conventions are used in this section:

Convention	Description
>>>	Alpha SRM Console prompt.
Backslash (\) at the end of a line	Continuation symbol to continue long commands on the next line.
_>	Continuation line prompt.
Maximum command length	255 characters.
Multiple contiguous spaces or tabs	Treated as a single space.
Command abbreviations	Allowed, if not ambiguous.
Command qualifiers or options	Prefix with a space and a dash (-).
Numbers	Hexadecimal, unless otherwise specified. (Registers, such as R0–R31, are shown in decimal notation.)

Alpha SRM Console Firmware Conventions

The following table lists Alpha SRM Console special keys and their functions. These special keys, also referred to as shortcut keys, provide command recall, line editing, and basic input/output control flow.

Shortcut Key	Function
Enter	Terminate the command line input.
Backspace or Delete	Delete one character to the left of the cursor.
Ctrl/A	Toggles insert/overstrike mode. (Overstrike is the default.)
Ctrl/B Up arrow Down arrow	Recall previous commands. (The last 16 commands are stored.)
Ctrl/C	Terminate the foreground process.
Ctrl/D Left arrow	Move the cursor one position to the left.
Ctrl/E	Move the cursor to the end of the line.
Ctrl/F Right arrow	Move the cursor one position to the right.
Ctrl/H	Move the cursor to the beginning of the line.
Ctrl/O	Suppress or resume (toggle) console output.
Ctrl/Q	Resume the flow (XON) of data to the console.
Ctrl/R	Retype the current command line.
Ctrl/S	Stop the flow (XOFF) of data to the console.
Ctrl/U	Delete the entire line.

7.2 Basic Alpha SRM Console Command Descriptions

This section describes the following basic Alpha SRM Console commands that are necessary to boot the DIGITAL UNIX operating system:

- arc
- boot
- deposit
- examine
- fwupdate
- set
- show

The Alpha SRM Console offers additional commands. For a complete list of Alpha SRM Console commands, enter **help** at the Alpha SRM Console prompt (>>>).

Basic Alpha SRM Console Command Descriptions

arc

Loads and runs the AlphaBIOS firmware update utility from a diskette.

Syntax

arc

nt

Arguments

None

Options

None

Description

None

Examples

Either of the following commands load and run the AlphaBIOS firmware update utility from a diskette:

```
>>>arc
```

or

```
>>>nt
```

Basic Alpha SRM Console Command Descriptions

boot

Initializes the processor, loads a program image from the specified boot device, and transfers control to the loaded image.

Syntax

```
boot [-file <filename>] [-flags  
<longword>[,<longword>]]  
[-protocols <enet_protocol>] [-halt]  
[<boot_device>]
```

Arguments

<boot_device>

A device path or list of devices from which the firmware will attempt to boot. Use the **set bootdef_dev** command to set an environment variable that specifies a default boot device.

Options

boot Command Option	Description
-file <filename>	Specifies the name of a file to load into the system. Use the set boot_file command to set the environment variable that specifies a default boot file.
-flags <longword> [,<longword>]	Specifies additional information for the operating system. For DIGITAL UNIX systems, the following values may be used: i = Interactive boot s = Boot to single user a = Autoboot to multiuser Use the set boot_osflags command to set an environment variable that specifies a default boot flag value.
-protocols <enet_protocol>	Specifies the Ethernet protocols that will be used for a network boot. Values may be mop or bootp .
-halt	Forces the bootstrap operation to halt and invoke the console program after the image is loaded and the page tables and other data structures are set up.

Basic Alpha SRM Console Command Descriptions

Description

The **boot** command initializes the processor, loads a program image from the specified boot device, and transfers control to that image. If you do not specify a boot device in the command line, the default boot device is used. The default boot device is determined by the value of the `bootdef_dev` environment variable.

If you specify a list of devices, a bootstrap is attempted from each device in the order in which the device is listed. Then control passes to the first successfully booted image. In a list, always enter network devices *last* because network bootstraps terminate only if a fatal error occurs or if an image is successfully loaded.

The **-flags** option can pass additional information to the operating system about the boot that you are requesting. On an OpenVMS system, the **-flags** option specifies the system root number and boot flags. If you do not specify a boot flag qualifier, the default boot flag's value specified by the `boot_osflags` environment variable is used.

The **-protocols** option allows selection of either the DECnet MOP or the TCP/IP BOOTP network protocols. The keywords **mop** and **bootp** are valid arguments for this option. It is possible to set the default protocol for a port by setting the environment variable `ewa0_protocols` or `era0_protocols` to the appropriate protocol.

Explicitly stating the boot flags or the boot device overrides the current default value for the current boot request, but does not change the corresponding environment variable.

See the Environment Variables for Alpha SRM Console Commands section in this chapter for more information about environment variables.

Basic Alpha SRM Console Command Descriptions

Examples

boot Command Example	Description
>>>boot	Boots the system from the default boot device.
>>>boot ewa0	Boots the system from Ethernet port ewa0.
>>>boot -file dec2.sys ewa0	Boots the file named dec2.sys from Ethernet port ewa0.
>>>boot -protocol bootp ewa0	Boots the system using the TCP/IP BOOTP protocol from Ethernet port ewa0.
>>>boot -flags 0,1	Boots the system from the default boot device using flag setting 0,1.
>>>boot -halt dka0	Loads the bootstrap image from disk dka0, halts the bootstrap operation, and invokes the console program. Subsequently, you can enter continue to transfer control to the operating system.

Basic Alpha SRM Console Command Descriptions

deposit

Writes data to the specified address.

Syntax

```
deposit [-{b,w,l,q,o,h}] [{physical, virtual, gpr, fpr, ipr}] [-n <count>] [-s <step>] [<device>:]<address> <data>
```

Arguments

<device>:

The optional device name (or address space) selects the device to access. The following platform-independent devices are supported:

- **pmem**
Physical memory.
- **vmem**
Virtual memory. All access and protection checking occur. If the access is not allowed to a program running with the current processor status (PS), the console issues an error message. If memory mapping is not enabled, virtual addresses are equal to physical addresses.

<address>

An address that specifies the offset within a device into which data is deposited. The address may be any legal symbolic address.

Valid symbolic addresses are shown in the following table.

Symbolic Address	Description
gpr-name	Represents general-purpose register.
ipr-name	Represents internal processor register.
PC	Program counter.
+	The location immediately following the last location referenced by examine or deposit .

Basic Alpha SRM Console Command Descriptions

Symbolic Address	Description
-	The location immediately preceding the last location referenced by examine or deposit .
*	The location last referenced by examine or deposit .
@	The location addressed by the last location referenced by examine or deposit .

<data>

The data to be deposited.

Options

deposit Command Option	Description
-b	Specifies data type is byte.
-w	Specifies data type is word.
-l	Specifies data type is longword.
-q	Specifies data type is quadword.
-o	Specifies data type is octaword.
-h	Specifies data type is hexword.
-physical	References physical address space.
-virtual	References virtual address space.
-gpr	References general-purpose register address space.
-fpr	References floating-point register address space.
-ipr	References internal processor register address space.
-n <count>	Specifies the number of consecutive locations to examine.
-s <step>	Specifies the address increment as a hexadecimal value. This option allows you to override the increment that is normally derived from the data size.

Basic Alpha SRM Console Command Descriptions

Description

The **deposit** command writes data to the specified address, such as a memory location, register, device, or file. The defaults for address space, data size, and address are the last specified values. After initialization, the default for address space is physical memory; for data size, the default is a quadword; and for address, the default is zero.

An address or device can be specified by concatenating the device name with the address. For example, use **pmem:0** and specify the size of the address space to be written. If a conflicting device, address, or data size is specified, the console ignores the command and issues an error response.

Examples

deposit Command Example	Description
<code>>>>d -n 1ff pmem:0 0</code>	Clears the first 512 bytes of physical memory.
<code>>>>d -l -n 3 pmem:1234 5</code>	Writes the value 5 into four longwords, starting at physical memory address 1234.
<code>>>>d -n 8 r0 ffffffff</code>	Loads GPRs R0 through R8 with -1.
<code>>>>d -l -n 10 -s 200 pmem:0 8</code>	Writes the value 8 in the first longword of the first 17 pages in physical memory.

Basic Alpha SRM Console Command Descriptions

examine

Displays the contents of the specified address.

Syntax

```
examine [-{b,w,l,q,o,h,d}] [-{physical, virtual,  
gpr, fpr, ipr}] [-n <count>] [-s <step>]  
[<device>:]<address>
```

Arguments

<device>:

The optional device name (or address space) selects the device to access.

<address>

The address specifies the first location to examine within the current device. The address can be any legal address specified.

Options

examine Command Option	Description
-b	Specifies data type is byte.
-w	Specifies data type is word.
-l	Specifies data type is longword.
-q	Specifies data type is quadword.
-o	Specifies data type is octaword.
-h	Specifies data type is hexword.
-d	Specifies the data displayed is the decoded macro instruction. The Alpha instruction decode (-d) does not recognize machine-specific PALcode instructions.
-physical	References physical address space.
-virtual	References virtual address space.
-gpr	References general-purpose register address space.
-fpr	References floating-point register address space.

Basic Alpha SRM Console Command Descriptions

examine Command Option	Description
-ipr	References internal processor register address space.
-n <count>	Specifies the number of consecutive locations to examine.
-s <step>	Specifies the address increment as a hexadecimal value. This option allows you to override the increment that is normally derived from the data size.

Description

The **examine** command displays the contents of the specified address, such as a memory location, register, device, or file. The defaults for address space, data size, and address are the last specified values. After initialization, the default for address space is physical memory; for data size, the default is a quadword; and for address, the default is zero.

An address or device can be specified by concatenating the device name with the address. For example, use **pmem:0** and specify the size of the address space to be displayed. If a conflicting device, address, or data size is specified, the console ignores the command and issues an error response.

The display line consists of the device name, the hexadecimal address (or offset within the device), and the examined data (also in hexadecimal).

The **examine** command supports the same options as the **deposit** command. Additionally, the **examine** command supports instruction decoding with the **-d** option, which disassembles instructions beginning at the current address.

Basic Alpha SRM Console Command Descriptions

Examples

examine Command Example	Display	Description
<code>>>>e r0</code>	<code>gpr: 0 (R0) 0000000000000002</code>	Examines the contents of R0, using a symbolic address.
<code>>>>e -g 0</code>	<code>gpr: 0 (R0) 0000000000000002</code>	Examines the contents of R0, using address space.
<code>>>>e grp:0</code>	<code>gpr: 0 (R0) 0000000000000002</code>	Examines the contents of R0, using a device name.
<code>>>>examine -n 5 r7</code>	<code>gpr: 38 (R7) 0000000000000000 gpr: 40 (R8) 0000000000000000 gpr: 48 (R9) 0000000000000000 gpr: 50 (R10) 000000007FFBF800 gpr: 58 (R11) 000000007FF781A2 gpr: 60 (R12) 0000000000000000</code>	Examines the contents of R7 and the next five registers.
<code>>>>examine ipr:11</code>	<code>ipr 11 (KSP) FFFFFFFF8228DFD0</code>	Examines the contents of internal processor register 11.

Basic Alpha SRM Console Command Descriptions

fwupdate

Loads and runs the AlphaBIOS firmware update utility from a diskette.

Syntax

fwupdate

Arguments

None

Options

None

Description

The **fwupdate** command script is used to load and run the AlphaBIOS firmware update utility from a diskette. The file `fwupdate.exe` is extracted from a diskette with a FAT file structure. This executable is then loaded to physical address 900000 and is executed in PALmode.

Examples

The following **fwupdate** command script loads and runs the AlphaBIOS firmware update utility from a diskette:

```
>>>fwupdate
```

Basic Alpha SRM Console Command Descriptions

set

Sets or modifies the value of an environment variable.

Syntax

```
set <envar> <value> [-default] [-integer] [-string]
```

Arguments

<envar>

The environment variable to be assigned a new value.

<value>

The value that is assigned to the environment variable. It can be either a numeric value or an ASCII string.

Options

set Command Option	Description
-default	Restores an environment variable to its default value.
-integer	Creates an environment variable as an integer.
-string	Creates an environment variable as a string.

Description

The **set** command is used to set or modify the value of an environment variable. Environment variables are used to pass configuration information between the console and the operating system. See Section 7.3 for more information about environment variables.

Basic Alpha SRM Console Command Descriptions

Examples

set Command Example	Description
<code>>>>set bootdef_dev ewa0</code>	Modifies the default boot device to ewa0.
<code>>>>set auto_action boot</code>	Attempts to boot the operating system following an error, halt, or power-up.
<code>>>>set boot_osflags 0,1</code>	Modifies the default boot flags to 0,1.
<code>>>>set foobar 5</code>	Creates an environment variable called foobar and gives it a value of 5.

Basic Alpha SRM Console Command Descriptions

show

Displays the current value of the specified environment variable or information about the system.

Syntax

```
show [{config, device [device_name], iobq, hwrpb,  
map, memory, pal, version, <envar>...}]
```

Arguments

show Command Argument	Description
config	Displays the current memory configuration, PCI logical slots, and ISA logical slots.
device [device name]	Displays the devices and controllers in the system. Specifying a device name returns information on that device only.
iobq	Displays the input/output counter blocks.
hwrpb	Displays the hardware restart parameter block.
map	Displays the system virtual memory map.
memory	Displays the memory module configuration.
pal	Displays the version of DIGITAL UNIX PALcode.
version	Displays the version of the console.
<envar>	Displays the current value of a specified environment variable.

Options

None

Description

The **show** command displays information about the system and the current value of a specified environment variable. See Section 7.3 for more information about environment variables.

Environment Variables for Alpha SRM Console Commands

Examples

show Command Example	Description
<pre>>>>show device dka0.0.0.6.0 DKA0 RZ26L 441A dka400.4.0.6.0 DKA400 RRD43 3213 dva0.0.0.0.1 DVA0 ewa0.0.0.12.0 EWA0 08-00-2B-E2-1C-25 pka0.7.0.6.0 PKA0 SCSI Bus ID 7</pre>	Lists device information, such as system designation, drive model, or Ethernet address.
<pre>>>>show memory 48 Meg of System Memory</pre>	Lists system random-access memory (RAM) size.
<pre>>>>show * (refer to Section 7.3)</pre>	Lists all environment variables and their settings.
<pre>>>>show boot* (refer to Section 7.3)</pre>	Lists all environment variables, beginning with boot.

7.3 Environment Variables for Alpha SRM Console Commands

This section describes environment variables that are used to define the system operational state and to pass information between the firmware and the operating system.

7.3.1 Environment Variable Descriptions

Environment variables are classified as either Alpha SRM Console architecture-required or system-defined.

Environment Variables for Alpha SRM Console Commands

7.3.1.1 Architecture-Required Environment Variables

The following table shows common Alpha SRM Console architecture-required environment variables and their descriptions. For a complete list, enter **show *** at the Alpha SRM Console prompt.

Architecture-Required Environment Variable	Description
<code>auto_action</code>	When used with the set or show command, this variable modifies or displays the console action that follows an error, halt, or power-up. The action can be halt, boot, or restart. The default is halt.
<code>boot_file</code>	When used with the set or show command, this variable modifies or displays the file name to be used when a bootstrap requires a file name. The default is null.
<code>boot_osflags</code>	When used with the set or show command, this variable modifies or displays the additional parameters to be passed to system software. The default is 0.
<code>bootdef_dev</code>	When used with the set or show command, this variable modifies or displays the default device or device list from which the system will attempt to boot. If the system software is preloaded, the variable is preset to point to the device containing the preloaded software. The default is null.

Environment Variables for Alpha SRM Console Commands

7.3.1.2 System-Defined Environment Variables

The following table shows common Alpha SRM Console system-defined environment variables and their descriptions. For a complete list, enter **show *** at the Alpha SRM Console prompt.

System-Defined Environment Variable	Description
<code>console</code>	When used with the set command, this variable modifies the console output to either the serial port or the graphics controller.
<code>control_scsi_term</code>	This variable is unused in the motherboard system.
<code>ewa0_mode</code>	This variable determines if the AUI (ThinWire) or the twisted-pair Ethernet ports will be enabled. AUI is the default. (Autosensing is not supported.)
<code>os_type</code>	When used with the set or show command, this variable modifies or displays the specified firmware that will be loaded on the next power cycle. Specify the value osf or UNIX to select the Alpha SRM Console.
<code>pci_parity</code>	This variable controls PCI parity checking. The possible values are: on = Parity checking is enabled. off = Parity checking is disabled; this is the default. sniff = Parity checking is enabled or disabled depending on the PCI device.
<code>oem_string</code>	When used with the set or show command, this variable modifies or displays a text string that identifies the product name in the Alpha SRM Console banner.

Environment Variables for Alpha SRM Console Commands

System-Defined Environment Variable	Description
<code>language n</code>	<p>The language environment variable assigns language <code>n</code> to the system (where <code>n</code> is the option number of a language listed in the menu that follows). Use the following procedure to select the language:</p> <ol style="list-style-type: none">At the Alpha SRM Console prompt, enter the following commands: <pre>>>>set language 0 >>>init</pre> <p>The following menu and prompt are displayed:</p> <pre>n Language n Language ===== 0 none (display menu) 40 Français (Suisse Romande) 30 Dansk 42 Italiano 32 Deutsch 44 Nederlands 34 Deutsch (Schweiz) 46 Norsk 36 English (American) 48 Portugues 38 English (British/Irish) 4A Suomi 3A Español 4C Svenska 3C Français 4E Vlaams 3E Français (Canadian)</pre> <p>(1 . . 16) :</p> <ol style="list-style-type: none">Enter the number that corresponds to the language that you want to use. The following example shows how to assign the English (American) language to the system: <pre>(1 . . 16) : 36</pre>When you receive a message to reset the system, power cycle the system.

Using the AlphaBIOS Firmware Update Utility to Update the Flash ROM

7.4 Using the AlphaBIOS Firmware Update Utility to Update the Flash ROM

Use the AlphaBIOS firmware update utility to update the firmware in a flash ROM.

7.4.1 AlphaBIOS Conventions

AlphaBIOS uses universally accepted keys and key combinations for navigating the interface and selecting items. If you are familiar with MS-DOS or Microsoft Windows keyboard conventions, navigating AlphaBIOS is simple. Use the keys and key combinations shown in Table 7–1 when navigating and selecting items in AlphaBIOS.

Table 7–1 AlphaBIOS Keys

Key or Key Combination	Description
Tab	Move highlight forward between fields of a dialog.
Shift + Tab	Move highlight backwards between fields of a dialog.
↓ or ↑	Move highlight within a menu, or cycle through available field values in a dialog window.
Alt + ↓	Drop down a menu of choices from a drop-down listbox. A drop-down listbox can be recognized by the symbol ↓.
Home	Move to the beginning of a text-entry field.
End	Move to the end of a text-entry field.
← or →	Move to the left or right in a text-entry field.
Esc	Discard changes and back up to previous screen.

Two levels of keyboard help are available:

- Press **F1** once to display explanations of the keystrokes available for the currently displayed part of AlphaBIOS.
- Press **F1** twice to display explanations of the keystrokes available for navigating throughout AlphaBIOS.

Using the AlphaBIOS Firmware Update Utility to Update the Flash ROM

7.4.2 Starting the AlphaBIOS

To start the AlphaBIOS, follow this procedure:

1. Insert the AlphaBIOS diskette into diskette drive A.
2. At the Alpha SRM Console prompt, enter the following command:

```
>>>fwupdate
```

Note: Because the firmware update utility reinitializes some system components, it may appear as if your system is restarting.

Figure 7–1 shows an example of the AlphaBIOS Boot screen with the “Press <F2> to enter SETUP” message at the bottom.

Figure 7–1 AlphaBIOS Boot Screen

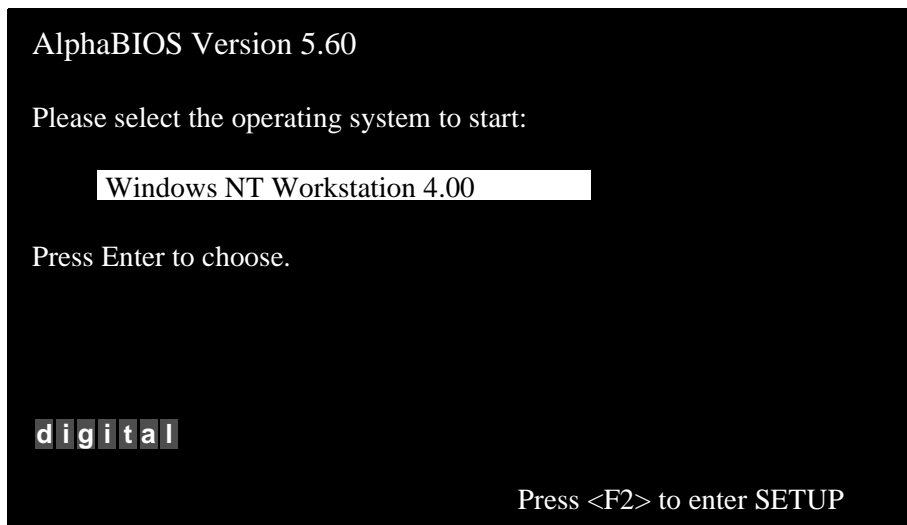

3. Press **F2** to start the AlphaBIOS setup program.

Using the AlphaBIOS Firmware Update Utility to Update the Flash ROM

7.4.3 Installing Alpha SRM Console Using AlphaBIOS Setup Program

Figure 7–2 shows an example of the AlphaBIOS Setup screen. Select the **AlphaBIOS Upgrade...** option by using the arrow or Tab keys.

Figure 7–2 AlphaBIOS Setup Screen

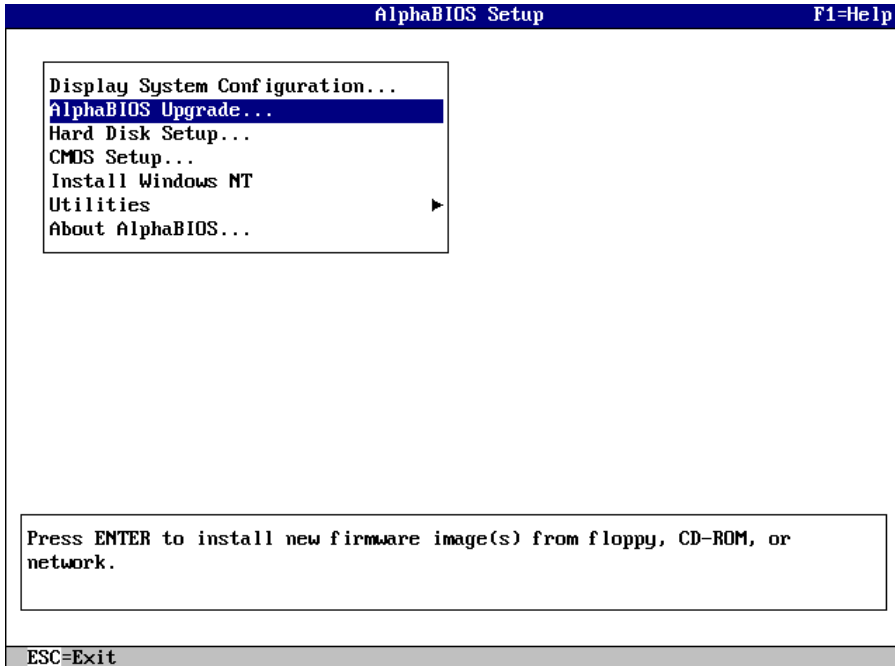

Press **Enter** to begin installing the SRM Console firmware image.

Using the AlphaBIOS Firmware Update Utility to Update the Flash ROM

Figure 7–3 shows an example of the AlphaBIOS Upgrade Options screen. If more than one image is found, the new image's name is displayed. If the name of the new image is not SRM Console, use the down arrow key to cycle through the available field values until SRM Console is displayed.

Figure 7–3 AlphaBIOS Upgrade Options Screen

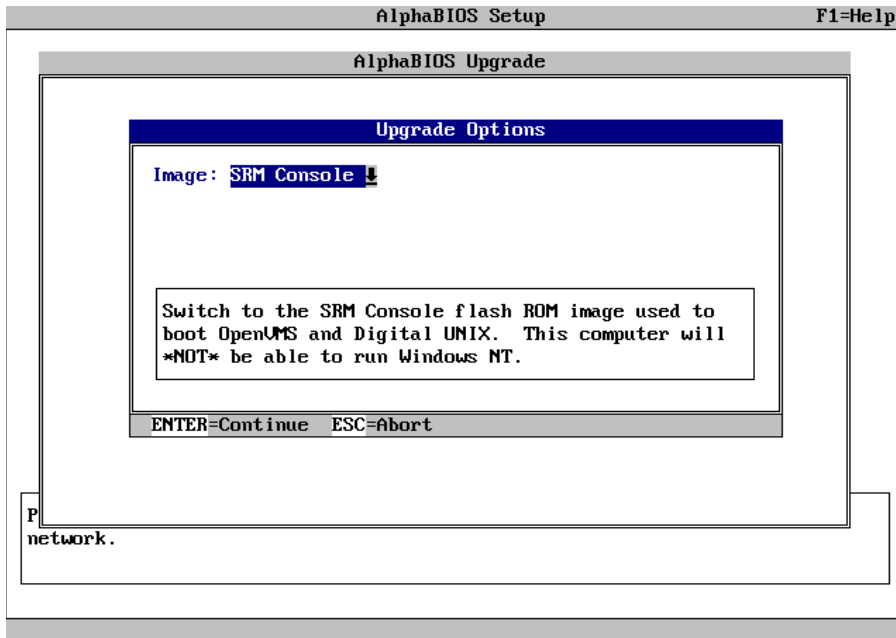

Press **Enter** to continue the installation.

Using the AlphaBIOS Firmware Update Utility to Update the Flash ROM

Figure 7–4 shows an example of the AlphaBIOS screen that warns you that you have selected to switch the operating system.

Figure 7–4 AlphaBIOS Warning Screen

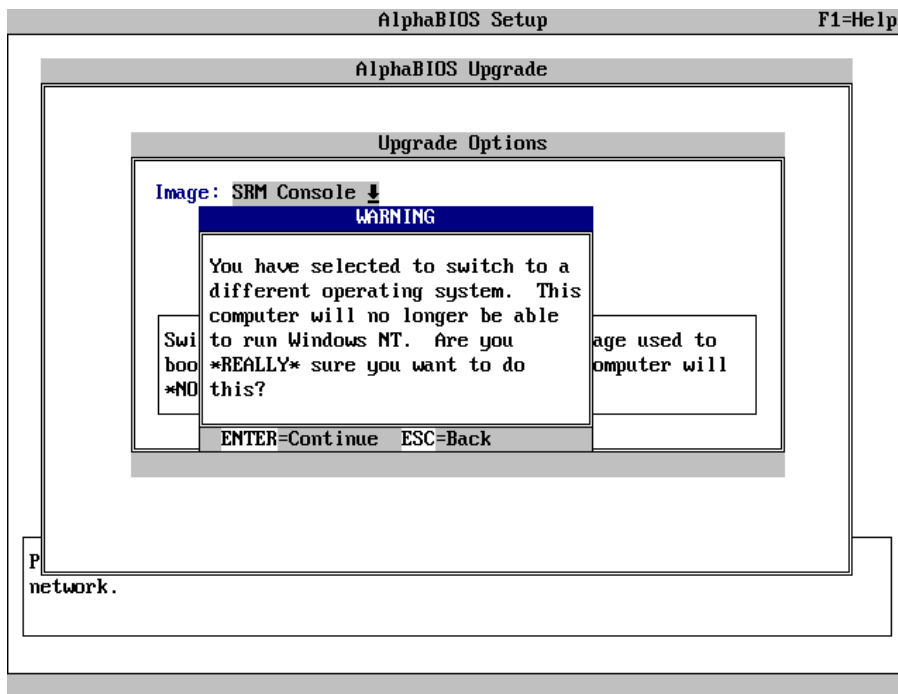

Press **Enter** to continue the installation.

Using the AlphaBIOS Firmware Update Utility to Update the Flash ROM

A screen similar to Figure 7–5 is displayed. The version numbers shown on your screen may be different than those shown in Figure 7–5.

Figure 7–5 AlphaBIOS Upgrade SRM Console Screen

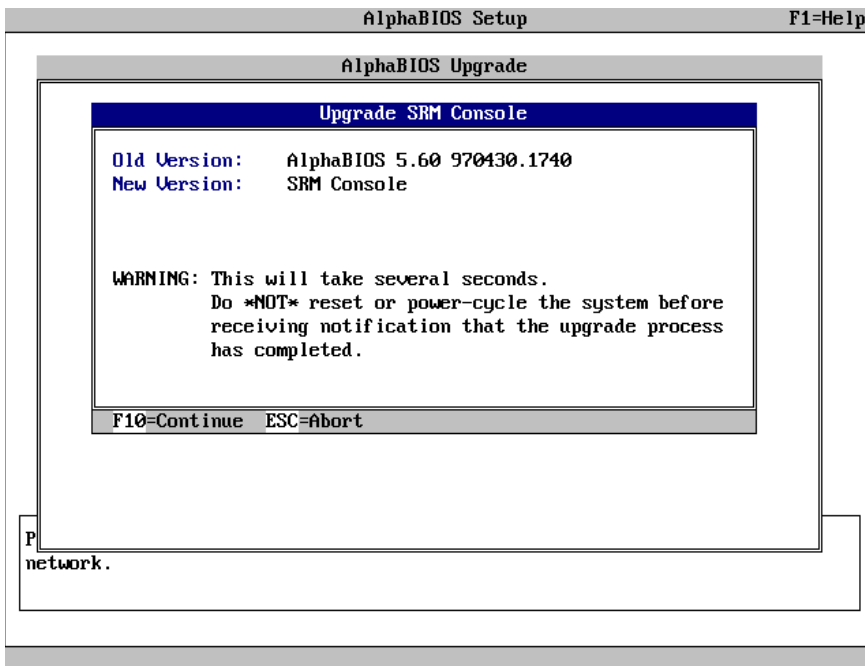

Press **F10** to continue the installation.

Using the AlphaBIOS Firmware Update Utility to Update the Flash ROM

Figure 7–6 shows an example of the AlphaBIOS Upgrade Complete screen.

Figure 7–6 AlphaBIOS Upgrade Complete Screen

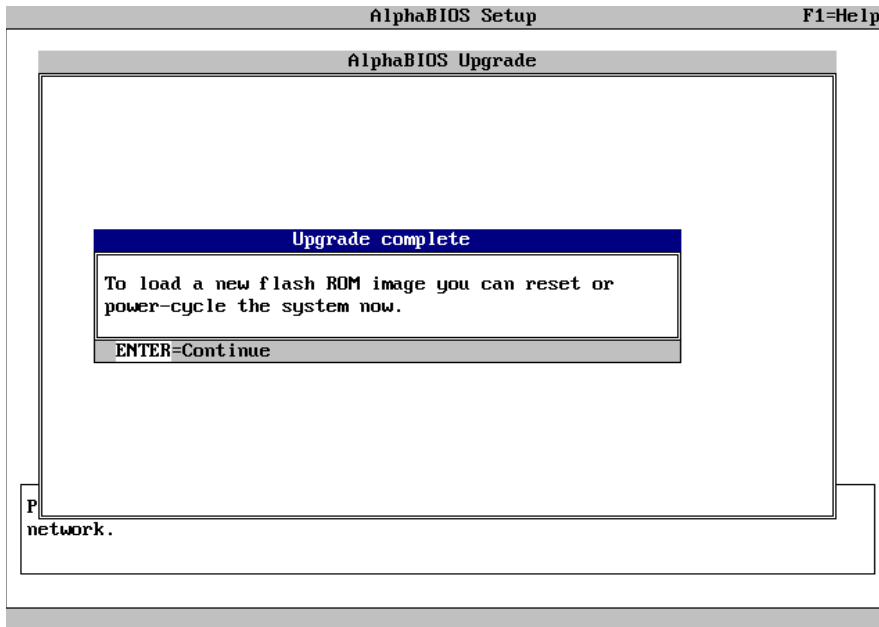

To load the SRM Console, power-cycle the system.

7.5 Installing the DIGITAL UNIX Operating System

Note: DIGITAL UNIX Version 4.0D is the minimum revision required for the AlphaPC 164SX motherboard system.

This section supplements the *DIGITAL UNIX Installation Guide* for installing the DIGITAL UNIX operating system on an AlphaPC 164SX motherboard system.

Note: If you already have a previous version of DIGITAL UNIX installed, see the *DIGITAL UNIX Installation Guide* for information on how to upgrade to a new version of the operating system. Be sure to review the preinstallation tasks, which are covered in the *DIGITAL UNIX Installation Guide*.

7.5.1 Requirements

You need the following hardware and software to install the DIGITAL UNIX operating system on an AlphaPC 164SX motherboard system:

- A minimum of 32MB of main memory; 64MB is recommended
- A 1GB (or larger) SCSI or EIDE hard disk capable of storing the supported software subsets
- Supported load devices
 - SCSI CD-ROM drive capable of reliably reading in 512-byte block mode
or
 - EIDE (ATAPI) CD-ROM drive
or
 - A network interface
- A console terminal with ASCII capability or a supported graphics display console
- DIGITAL UNIX Version 4.0D or higher Operating System Volume 1 compact disc
- Alpha SRM Console Version 4.9 or higher

This chapter contains information about troubleshooting hardware and software during AlphaPC 164SX startup.

8.1 Hardware Startup

Use the following troubleshooting steps if video is not working on your system. If you still have no video after reviewing these steps, please call your system vendor.

Troubleshooting Steps: No Video

1. Check the connection to the ac outlet.
2. Check the voltage setting on the power supply (115 V ac in the U.S.).
3. Check that the frequency/switch selection matches the speed of the Alpha chip.
4. Check that the CPU fan is connected and spinning.
5. Ensure that the flash ROM update procedure was performed correctly. If you have a terminal attached to COM1, check the output for error messages after verifying that the flash ROM update procedure was performed correctly.
6. Reseat the video card and ensure that it is connected to the monitor.
7. Reseat the DIMMs.
8. Replace the DIMMs.

Beep Codes

8.2 Beep Codes

The beep codes provide error information about the AlphaPC 164SX system. Table 8–1 lists and describes the beep codes.

Table 8–1 Beep Codes

Beep Code	Description
1–2–3 ¹	This sequence represents the fail-safe booter startup.
4	No valid header found in ROM; loading entire ROM.
5	No memory found.
6	Checksum error detected when image was read back from memory.

¹ One beep and a pause, followed by two beeps and a pause, followed by three beeps.

8.3 Post Codes

The post codes indicate the progress of the SROM and SRM Console firmware. Table 8–2 lists and describes the post codes.

Table 8–2 Post Codes

(Sheet 1 of 3)

Source	Post Code (hex)	Description
SROM	00	Firmware initialization is complete
	01	CPU speed detected
	02	CPU speed converted
	03	Configuration jumpers read
	04	Bcache configuration value computed
	05	Bcache control value computed
	0C	Memory sized and memory bank 0 written
	0D	Enable Dcache
	13	All of memory rewritten (good data parity written)
	14	Memory errors cleared; start reading system ROM
	15	Loading ROM without SROM decompression
	16	Loading ROM using SROM decompression
	17	System ROM loaded to memory
	18	Icache flush code written to memory
	19	CPU errors cleared; jump to system code
	20	ISA bus reset

Table 8–2 Post Codes

(Sheet 2 of 3)

Source	Post Code (hex)	Description
	3A	Jump to Mini-Debugger
	3F	Fatal error. Second code identifies source of error: 05 = No memory found 06 = Checksum error detected when image was read back from memory
SRM	FF	Starting console
Console	FE	Idle PCB initialization
	FD	Semaphore initialization
	FC	Heap initialization
	FB	Heap initialization
	FA	Heap initialization
	F9	Driver structure initialization
	F8	Idle process PID initialization
	F7	File system initialization
	F6	Timer data structures initialization
	F5	Lowering IPL
	F4	Entering idle loop
	F3	Creating task to deallocate dead PCBs
	F2	Creating polling task
	F1	Creating timer task
	F0	Creating power-up task
	EF	Configuring memory
	EE	Phase 1 driver startup
	ED	Configuring the PCI/ISA bus
	EC	Phase 3 driver startup
	EB	Switching stdin/out/err to console terminal device
	EA	Phase 4 driver startup
	E9	Building per CPU slot in the HWRPB
	E8	SCSI class driver initialization
	E7	Phase 5 driver startup
Fail-safe booter	FD	I/O bus initialization
	FC	I/O initialization complete
	FB	UART initialization

Table 8–2 Post Codes

(Sheet 3 of 3)

Source	Post Code (hex)	Description
	BF	Fail-safe booter is scanning the diskette
	1	Fail-safe booter is loading the AlphaBIOS
	2	Fail-safe booter is loading the Debug Monitor
	3	Fail-safe booter is loading the SRM console
	4	Fail-safe booter is loading the Linux mini-loader

8.4 Fail-Safe Booter

The fail-safe booter provides an emergency recovery mechanism when the primary firmware image contained in flash memory has been corrupted. When flash memory has been corrupted, and no image can be loaded safely from the flash, you can run the fail-safe booter and boot another image from a diskette that is capable of reprogramming the flash.

Starting the Fail-Safe Booter

You can start the fail-safe booter in one of two ways:

- If the primary firmware image is unavailable when the system is powered on or reset, the fail-safe booter runs automatically. When the fail-safe booter runs, the system emits a series of beeps through the speaker as beep code 1-2-3; that is, one beep and a pause, followed by two beeps and a pause, followed by three beeps. After the diskette activity light flashes, insert the *AlphaPC 164SX SRM Console Firmware* diskette. The fail-safe booter will load and run the AlphaBIOS firmware update utility from this diskette. Proceed to Section 7.4 and follow the procedure for updating your flash ROM.
- You can also start the fail-safe booter manually as follows:
 1. Power off your system.
 2. Slide switch CF7 to off, as described in Section 3.3.
 3. Power on your system.
 4. Insert the *AlphaPC 164SX SRM Console Firmware* diskette into the diskette drive.
 5. Proceed to Section 7.4 and follow the procedures.

Battery Recycle/Disposal Information

NOTICE

Recycle or dispose of batteries promptly in accordance with your organization's environmental policies. If this is a LITHIUM battery, the following additional precautions may apply:

- Replace batteries correctly to prevent possible explosion.
- Replace batteries with the same or equivalent type.
- Prior to disposal or recycling, protect all batteries against accidental short circuiting by affixing nonconductive tape across battery terminals or conductive surfaces.
- Keep batteries away from small children.

Support, Products, and Documentation

A.1 Customer Support

The Alpha OEM website provides the following information for customer support.

URL	Description
http://www.digital.com/alphaoem	Contains the following links: <ul style="list-style-type: none">• Developers' Area: Development tools, code examples, driver developers' information, and technical white papers• Motherboard Products: Motherboard details and performance information• Microprocessor Products: Microprocessor details and performance information• News: Press releases• Technical Information: Motherboard firmware and drivers, hardware compatibility lists, and product documentation library• Customer Support: Feedback form

Supporting Products

A.2 Supporting Products

This section lists sources for components and accessories that are not included with the AlphaPC 164SX.

A.2.1 Memory

Dual inline memory modules (DIMMs) are available from a variety of vendors. For a list of the qualified vendors, visit the Alpha OEM World Wide Web Internet site at

<http://www.digital.com/alphaoem>

Click on **Technical Information**.

Then click on **Alpha OEM Hardware Compatibility List**.

A.2.2 Thermal Products

Components included in this heat-sink and fan solution are heat sink, GRAFOIL pad, two hex nuts, heat-sink clips, 52-mm fan, and four screws. These are available from:

United Machine and Tool Design Company, Inc.

18 River Road
P.O. Box 168
Fremont, NH 03044
Phone: 603-642-5040
Fax: 603-642-5819
PN 70-33148-01

A.2.3 Power Supply

An ATX form-factor power supply, suitable for use with the AlphaPC 164SX (+3.3 V, +5 V, -5 V, +12 V, -12 V), is available from:

Quantum Power Labs, Inc.

1410 Gail Borden Place C-4
El Paso, TX 79935
Phone: 915-599-2688
Fax: 915-599-2699
PN AP2-5300FRV (300 W)

Antec, Inc.

2859 Bayview Drive
Fremont, CA 94538
Phone: 510-770-1200, ext. 313
PN PP-253V (250 W)

A.2.4 Enclosure

An enclosure, suitable for housing the AlphaPC 164SX and its power supply, is available from:

Delta Axxion Technology

1550 Northwestern
El Paso, TX 79912
Phone: 915-877-5288
PN DL17

A.3 Associated Documentation

You can order the following associated documentation directly from the vendor.

If you have feedback about the Alpha technical documentation, please send your comments to alpha.techdoc@compaq.com.

Title	Vendor
Alpha Architecture Reference Manual EY-W938E-DP	Call your sales office or call Butterworth-Heinemann (DIGITAL Press) at 1-800-366-2665
Alpha Architecture Handbook EC-QD2KB-TE	Order online: http://www.digital.com/alphaoem
Alpha 21164PC Microprocessor Hardware Reference Manual EC-R2W0A-TE	See previous entry
Alpha 21164PC Microprocessor Data Sheet EC-R2W1A-TE	See previous entry

Associated Documentation

Title	Vendor
PCI Local Bus Specification, Revision 2.1	PCI Special Interest Group
PCI Multimedia Design Guide, Revision 1.0	U.S. 1-800-433-5177
PCI System Design Guide	International 1-503-797-4207
PCI-to-PCI Bridge Architecture Specification, Revision 1.0	Fax 1-503-234-6762
PCI BIOS Specification, Revision 2.1	
CY82C693U hyperCache/Stand-Alone PCI Peripheral Controller with USB Data Sheet	Cypress Semiconductor Corporation 3901 North First Street San Jose, CA 95134 Phone: 1-800-858-1810
Super I/O Floppy Disk Controller with Infrared Support (FDC37C669) Data Sheet	Standard Microsystems Corporation 80 Arkay Drive Hauppauge, NY 11788 Phone: 1-800-443-7364 Fax: 1-516-231-6004

Free Manuals Download Website

<http://myh66.com>

<http://usermanuals.us>

<http://www.somanuals.com>

<http://www.4manuals.cc>

<http://www.manual-lib.com>

<http://www.404manual.com>

<http://www.luxmanual.com>

<http://aubethermostatmanual.com>

Golf course search by state

<http://golfingnear.com>

Email search by domain

<http://emailbydomain.com>

Auto manuals search

<http://auto.somanuals.com>

TV manuals search

<http://tv.somanuals.com>