

**BELKIN®**

**OmniView® LCD Rack  
Console with Built-In  
PRO3 KVM Switch**



**User Manual**

F1DC108BxxSR  
F1DC116BxxSR

# Table of Contents

|   |           |
|---|-----------|
| <b>1. Introduction</b> .....  | <b>1</b>  |
| Package Contents .....  | 2         |
| <b>2. Overview</b> .....  | <b>3</b>  |
| Feature Overview .....  | 3         |
| Equipment Requirements.....   | 4         |
| System Requirements.....  | 6         |
| Unit Display Diagrams .....   | 7         |
| Specifications .....  | 9         |
| <b>3. Installation</b> .....  | <b>10</b> |
| Pre-Configuration.....  | 10        |
| Connecting Servers to the LCD Rack Console .....  | 12        |
| Connecting the LCD Rack Console with Multiple<br>PRO3 KVM Switches (Daisy-Chaining) ..... | 14        |
| Powering Up the Systems .....   | 18        |
| <b>4. Using your LCD Rack Console</b> .....   | <b>19</b> |
| Selecting a Server or BANK Using Hot-Key Commands .....                                   | 20        |
| AutoScan Mode .....   | 22        |
| On-Screen Display (OSD) .....   | 22        |
| Keyboard Hot-Key-Command Shortcuts .....  | 27        |
| Sun Combo and Mac Key Mapping.....  | 28        |
| Updating Firmware .....   | 29        |
| <b>5. Frequently Asked Questions</b> .....  | <b>31</b> |
| <b>6. Troubleshooting</b> .....   | <b>33</b> |
| <b>7. Glossary</b> .....  | <b>36</b> |
| <b>8. Information</b> .....   | <b>37</b> |

Congratulations on your purchase of the Belkin OmniView LCD Rack Console with Built-In PRO3 KVM Switch (the LCD Rack Console). Our diverse line of KVM solutions exemplifies the Belkin commitment to delivering high-quality, durable products at an affordable price.

Designed to give you control over multiple servers, the LCD Rack Console provides an excellent solution for the server administrator. It outperforms any other rack console with KVM switch on the market. Engineered to work with the most advanced server room and laboratory environments, this LCD Rack Console offers:

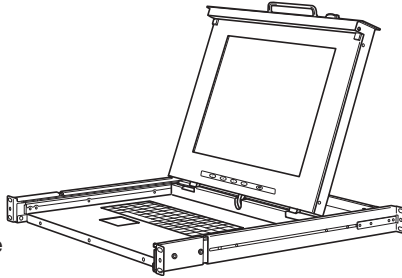

- Single-rail system with 1U compact design
- Video resolution support of up to 1280x1024
- PS/2 and USB support for input devices
- On-Screen Display (OSD)
- Daisy-chain capability with other Belkin PRO switches (up to 256 servers)
- Security
- Flash-upgradeable firmware
- Dual-port micro-cabling (PS/2 cable kits sold separately)
- Belkin 2-Year Warranty
- Free technical support
- 17-inch LCD

This User Manual will provide details about your new LCD Rack Console, from installation and operation to troubleshooting—in the unlikely event of a problem. For quick and easy installation, please refer to the Quick Installation Guide included in your LCD Rack Console packaging.

Thank you for purchasing the Belkin OmniView LCD Rack Console with Built-In PRO3 KVM Switch. We appreciate your business and have confidence that you will soon see for yourself why Belkin is the number-one-selling brand in KVM switches worldwide.

## Package Contents



LCD Rack  
Console

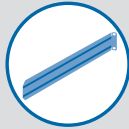

Bracket Kit



Bracket Screws



DB9-to-RJ11 Serial  
Flash Cable



12V DC,  
1A Power Supply With  
schuko and Uk plug



User Manual



Quick Installation  
Guide

## Feature Overview

- Hot Keys

Hot-key functionality allows you to select a desired port using designated key commands. By using a simple hot-key sequence on your keyboard, you can select one server from as many as 256 servers, instantaneously.

- AutoScan

The AutoScan feature allows you to set your LCD Rack Console to scan and monitor the activities of all connected servers, one by one. The time interval allotted for each server can be adjusted through the On-Screen Display (OSD) menu.

- Video Resolution

The LCD Rack Console supports video resolutions of up to 1280x1024@65Hz.

- Security

Allows you to specify user names and passwords to prevent unauthorized users from accessing the OSD and KVM Switch.

- Dedicated Daisy-Chain Port

Up to 16 KVM switches can be daisy-chained together using dedicated ports, so you can easily expand your KVM configuration as your server environment grows.

- On-Screen Display (OSD)

The OSD feature simplifies server management by allowing you to assign individual names to each connected server throughout the system. It provides a visual means of switching between servers and assigning the hot-key scheme. The OSD can also be set up to support regional languages.

- Flash Upgrade

Flash-upgradeable firmware allows you to install the latest firmware on your LCD Rack Console. This enables your KVM Switch to maintain consistent compatibility with the latest devices and servers. Firmware upgrades are free for the life of your LCD Rack Console and can be downloaded from Belkin's support website at [www.belkin.com/support](http://www.belkin.com/support).

1

2

3

4

5

6

7

8

section

## Equipment Requirements

### Cables:

Connecting the LCD Rack Console to a server requires a Belkin Dual-Port Micro-Cable Kit.

Belkin Dual-Port Micro-Cable Kits:

F1D9400-XX (PS/2-style)    F1D9401-XX (USB-style)

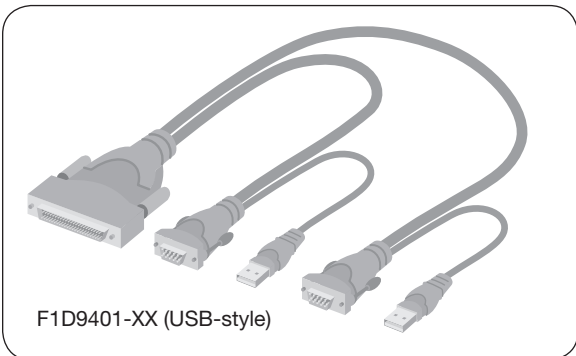
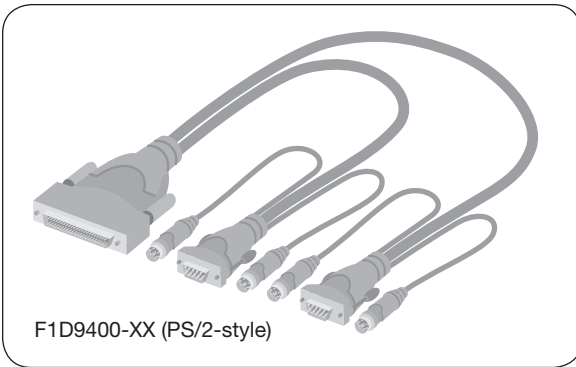

Belkin Daisy-Chain Cable: F1D108-CBL

**Note:** Product codes and availability may vary.

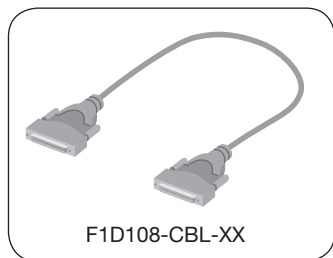

1

2

3

4

5

6

7

8

section

## System Requirements

### OS Platforms

The LCD Rack Console is compatible with CPUs running on, but not limited to, the following OS platforms

- Windows® NT®, 95, 98, 2000, Me, XP, Server 2003, or Vista®
- Microsoft® DOS 5.x and above
- Red Hat® Linux® 8.x and above
- Novell® NetWare® 5.x
- Mac OS® X and above (with USB support)
- Sun™ Solaris™ 8.x and above

### Keyboards

- PS/2-compatible
- USB-compatible
- Supports 101-/102-/104-key keyboards

### Mice

- PS/2- and USB-compatible mice having 2, 3, 4, or 5 buttons
- PS/2- and USB-compatible wireless or optical mice

### Monitors

- CRT
- LCD (with VGA support)



## Unit Display Diagrams

### Front View of the OmniView LCD Rack Console with Built-In PRO3 KVM Switch:

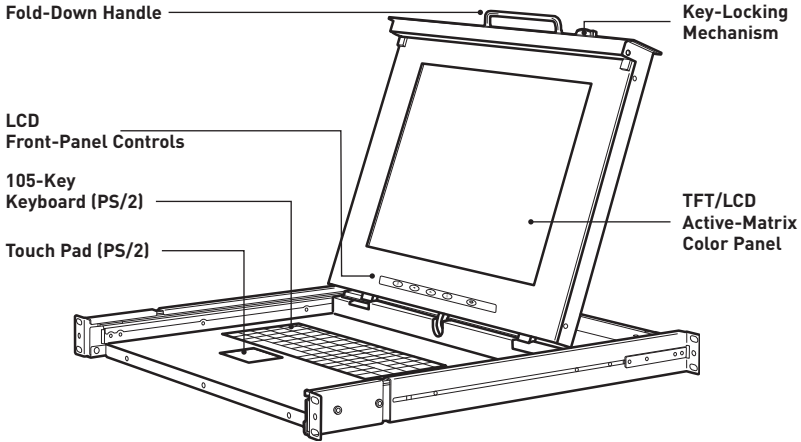

1

2

3

4

5

6

7

8

section

## Unit Display Diagrams

### Back View of the OmniView LCD Rack Console with Built-In PRO3 KVM Switch:

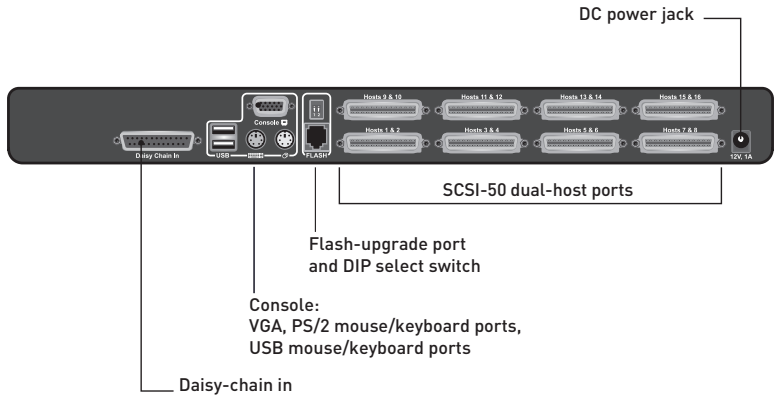

## Specifications

|                                  |   |
|----------------------------------|---|
| <b>Part No.:</b>                 | F1DC108BxxSR, F1DC116BxxSR  |
| <b>Enclosure:</b>                | Metal enclosure   |
| <b>Power:</b>                    | 12V DC, 1A power adapter, center-pin-positive polarity                                |
| <b>Daisy-Chain:</b>              | Maximum of 16 OmniView KVM Switches   |
| <b>No. of Servers Supported:</b> | 8 and 16 respectively for 8- and 16-port models (256 servers max. via daisy-chaining) |
| <b>Monitors Supported:</b>       | CRT and LCD (with VGA support)  |
| <b>Max. Resolution:</b>          | Up to 1280x1024 @ 65Hz  |
| <b>Keyboard Input:</b>           | PS/2 (miniDIN6), USB (Type A)   |
| <b>Mouse Input:</b>              | PS/2 (miniDIN6), USB (Type A)   |
| <b>Monitor Port:</b>             | VGA (HDDB15 female)   |
| <b>CPU Ports:</b>                | SCSI-50   |
| <b>Daisy-Chain Ports:</b>        | DB25 female   |
| <b>Flash-Upgrade Port:</b>       | RJ11  |
| <b>Operating Temp:</b>           | 32° to 104° F (0~40° C)   |
| <b>Storage Temp:</b>             | -4° to 140° F (20~60° C)  |
| <b>Humidity:</b>                 | 0-80% RH, non-condensing  |
| <b>Warranty:</b>                 | 2 years   |
| <b>Dimensions:</b>               | 23.5 x 17.5 x 1.75 in.<br>(597mm x 444.5mm x 44.5mm)                                  |
| <b>Weight:</b>                   | (F1DC108BxxSR) 33.0 lbs. (15.0kg.)<br>(F1DC116BxxSR) 34.1 lbs. (15.5kg.)              |

**Note:** Specifications are subject to change without notice.

1

2

3

4

5

6

7

8

section

## Pre-Configuration

### Consider the following when deciding where to place the OmniView LCD Rack Console with Built-In PRO3 KVM Switch:

- the location of your servers in relation to your console
- the lengths of the cables you use to connect your servers to the LCD Rack Console

### Cable-Distance Requirements:

#### For PS/2 Servers:

VGA signals transmit best up to 25 feet (7.6m). Beyond that length, the probability of video degradation increases. For this reason, Belkin recommends that the length of the cables between the LCD Rack Console and the connected servers does not exceed 25 feet (7.6m).

#### For USB Servers:

USB signals can be transmitted up to 15 feet (4.5m) between the LCD Rack Console and server. Beyond that length, the probability of USB-signal failure is likely, and may cause the device to fail.

**Note:** The Belkin OmniView CAT5 Extender, F1D084vea2 (PS/2) and F1D086Uea (USB), may be used to extend your console (keyboard, mouse, and monitor) by up to 300 feet (91m).

### **Cautions and Warnings!**

Avoid placing cables near fluorescent lights, air-conditioning equipment, or machines that create electrical noise (e.g., vacuum cleaners).

Before attempting to connect anything to the LCD Rack Console or your servers, ensure that everything is powered off. Plugging and unplugging cables while servers are powered on may cause irreversible damage of the servers and/or the LCD Rack Console. Belkin is not responsible for damage caused in this way.

**You are now ready to begin installation of your LCD Rack Console. The following sections (pages 11–13) provide complete instructions for the hardware setup of a single LCD Rack Console (F1DC108BxxSR, F1DC116BxxSR).**

## Connecting Servers to the LCD Rack Console (PS/2 Connection):

### Step 1

Make sure your server is powered off.

### Step 2

Using the Belkin Dual-Port Micro-Cable Kit for PS/2 (F1D9400-XX), connect the VGA connector to the monitor port on your server.

(Refer to diagram below.)

### Step 3

Connect the PS/2 mouse and keyboard connectors to the mouse and keyboard ports on the server.

(Refer to diagram below.)

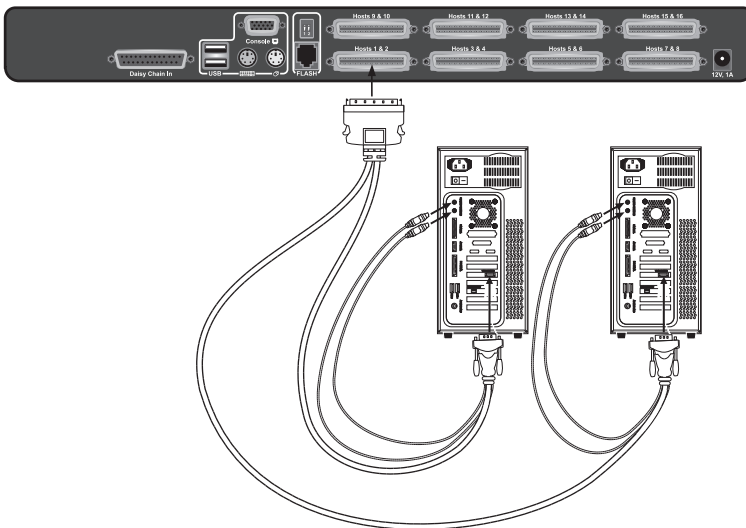

1

2

3

4

5

6

7

8

section

### Step 4

Connect the Belkin Dual-Port Micro-Cable Kit for PS/2 to the desired host ports on the PRO3 KVM Switch. (Refer to diagram below.)

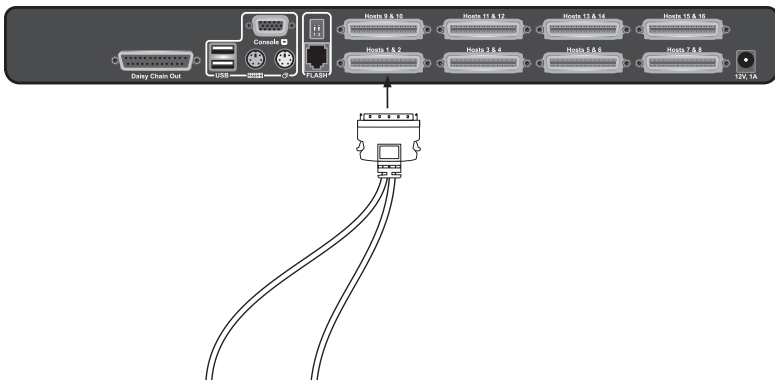

### Step 5

Power up your server.

### Step 6

Repeat Steps 1 through 5 for each additional PS/2 server you wish to connect.

## Connecting Servers to the LCD Rack Console (USB Connection):

### Step 1

Make sure your server is powered off.

### Step 2

Using the Belkin Dual-Port Micro-Cable Kit for USB (F1D9401-XX), connect the VGA connector to the monitor port on your server. (Refer to diagram on next page.)

### Step 3

Connect the USB connector to an available USB port on the server. (Refer to diagram on next page.)

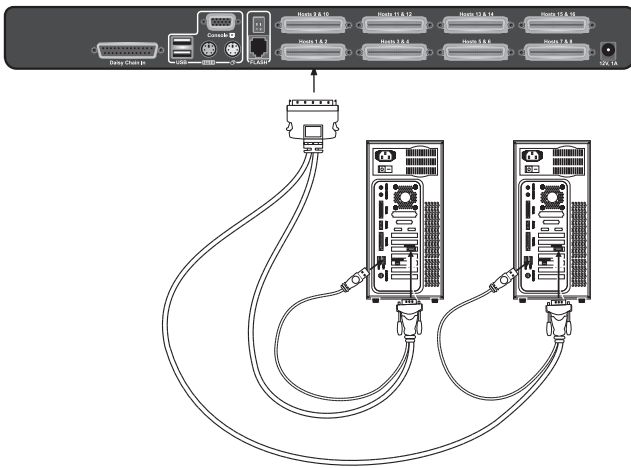

### Step 4

Connect the Belkin Dual-Port Micro-Cable Kit for USB to the desired host ports on the PRO3 KVM Switch. (Refer to diagram below.) Your server should recognize the KVM-Switch connection and automatically install the HID USB driver, if necessary.

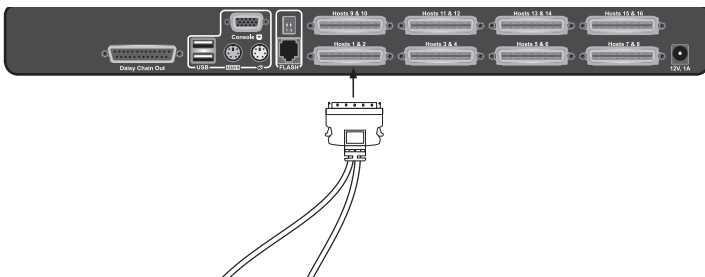

### Step 5

Repeat Steps 1 through 4 for each additional USB server you wish to connect.

**Note:** We recommend that you attach the Belkin Dual-Port Micro-Cable USB Kit directly to a free USB port on your server.

**Note:** When a USB Cable Kit is connected to a Sun server, the Server Interface Module emulates the Sun keys using a set of key combinations called “combo keys”. Refer to the table on page 28 for a list of Sun functions supported by the LCD Rack Console.

## Connecting the LCD Rack Console with Multiple PRO3 KVM Switches (Daisy-Chaining)

You can daisy-chain up to 15 additional PRO3 KVM Switches (F1DA104Zea, F1DA108Zea, F1DA116Zea, F1DA104Qea, F1DA108Qea, and F1DA116Qea), allowing a server administrator to manage up to a maximum of 256 servers from one console. Each daisy-chained PRO3 KVM Switch is referred to as a “BANK” and is assigned an address. The LCD Rack Console is BANK 00 and is referred to as the “primary” KVM switch. BANKs 01 through 15 are referred to as “secondary” KVM switches.

**Note:** The LCD Rack Console (F1DC108BxxSR, F1DC116BxxSR) must be designated as the primary KVM switch. Refer to the diagram below.

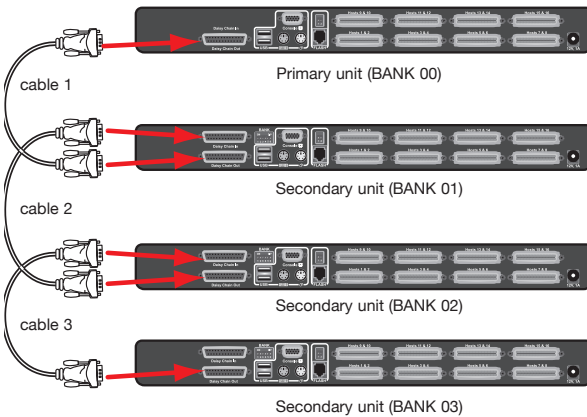

**Note:** A Daisy-Chain Cable (F1D108-CBL) is required to daisy-chain each PRO3 KVM Switch and is available through your Belkin reseller, or online at [www.belkin.com](http://www.belkin.com)



## How to Assign a BANK Address

All PRO3 KVM Switches feature a “BANK DIP” switch. The “BANK DIP” switch is used to assign the proper BANK address to each PRO3 KVM Switch.

- For a multi-unit configuration, the primary KVM switch (LCD Rack Console) is always set to “BANK address 00”. Each secondary unit must be set to a unique BANK address (from 01 through 15). Refer to the chart below for “BANK DIP” switch settings.

### BANK-DIP-Switch Configuration Chart

| DIP SWITCH# |    |     |     |     |     | BANK ADDRESS |                   |
|-------------|----|-----|-----|-----|-----|--------------|-------------------|
| 1           | 2  | 3   | 4   | 5   | 6   |              |                   |
| ON          | ON | ON  | ON  | ON  | ON  | BANK 0       | PRIMARY (default) |
| ON          | ON | OFF | ON  | ON  | ON  | BANK 1       | SECONDARY         |
| ON          | ON | ON  | OFF | ON  | ON  | BANK 2       | SECONDARY         |
| ON          | ON | OFF | OFF | ON  | ON  | BANK 3       | SECONDARY         |
| ON          | ON | ON  | ON  | OFF | ON  | BANK 4       | SECONDARY         |
| ON          | ON | OFF | ON  | OFF | ON  | BANK 5       | SECONDARY         |
| ON          | ON | ON  | OFF | OFF | ON  | BANK 6       | SECONDARY         |
| ON          | ON | OFF | OFF | OFF | ON  | BANK 7       | SECONDARY         |
| ON          | ON | ON  | ON  | ON  | OFF | BANK 8       | SECONDARY         |
| ON          | ON | OFF | ON  | ON  | OFF | BANK 9       | SECONDARY         |
| ON          | ON | ON  | OFF | ON  | OFF | BANK 10      | SECONDARY         |
| ON          | ON | OFF | OFF | ON  | OFF | BANK 11      | SECONDARY         |
| ON          | ON | ON  | ON  | OFF | OFF | BANK 12      | SECONDARY         |
| ON          | ON | OFF | ON  | OFF | OFF | BANK 13      | SECONDARY         |
| ON          | ON | ON  | OFF | OFF | OFF | BANK 14      | SECONDARY         |
| ON          | ON | OFF | OFF | OFF | OFF | BANK 15      | SECONDARY         |

ON = Up Position, OFF = Down Position

**Example:** Three 8-Port PRO3 KVM Switches (F1DA108Zea) are daisy-chained together with an LCD Rack Console to manage up to 32 servers. The DIP switch on the primary KVM (LCD Rack Console) switch is set to “BANK 00” (factory default) and the secondary units are each set to a unique BANK (between 01 and 03).

## Example of Daisy-Chain Configuration

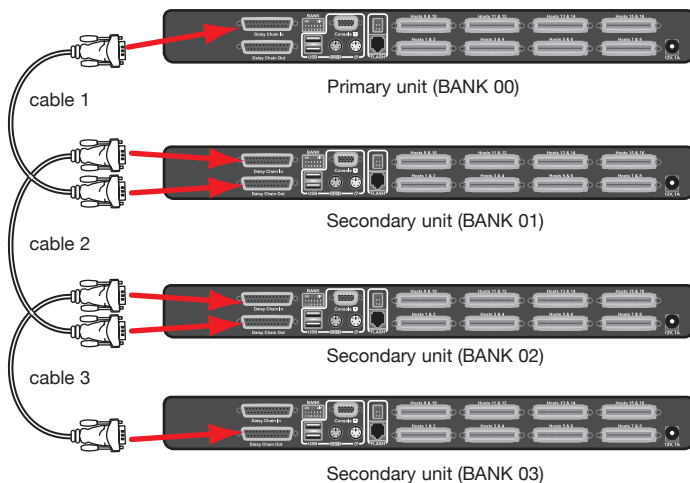

### Getting Started:

**Step 1:** Make sure that all servers, LCD Rack Console, and PRO3 KVM Switches are powered off and that each PRO3 KVM Switch has been assigned a unique BANK address.

**Step 2:** Place all primary and secondary KVM switches in the desired location.

## Connecting the Primary and Secondary KVM Switches:

### Step 1

Using the Daisy-Chain Cable (F1D108-CBL), connect one end to the “Daisy-Chain In” port on the LCD Rack Console (BANK 00).

### Step 2

Connect the other end of the Daisy-Chain Cable (F1D108-CBL) to the “Daisy-Chain Out” port of the first secondary KVM switch (BANK 01).

### Step 3

To add secondary units, connect one end of the Daisy-Chain Cable (F1D108-CBL) to the “Daisy-Chain In” port on the first secondary KVM switch and the other end to the “Daisy-Chain Out” port of the next secondary KVM switch (for example, BANK 01).

### Step 4

Repeat Step 3 for additional PRO3 KVM Switches you wish to daisy-chain together.

1

2

3

4

5

6

7

8

section

### **Connecting the Servers:**

#### **Step 1:**

Connect all servers to the primary and secondary KVM switches.

Refer to the “Connecting Servers to the LCD Rack Console” section on page 11 for instructions.

#### **Step 2:**

Power up the secondary KVM switches sequentially, beginning with the highest BANK, by connecting each unit’s power supply. Each KVM switch should display its corresponding BANK-address number as it is powered up.

#### **Step 3:**

Verify that the primary KVM switch has detected all secondary KVM switches by scrolling through the BANKs by using the OSD.

### **Powering Up the Systems**

Verify that all servers connected to the PRO3 KVM Switch are powered on. If any connected servers have not been powered on, it is okay to do so at this time (servers can be powered on simultaneously). The PRO3 KVM Switch emulates both a mouse and keyboard on each port and allows your server to boot normally.

The server connected to Port “1” will be displayed on the monitor. Check that the keyboard, monitor, and mouse are working normally. Check all occupied ports to verify that all servers are connected and responding correctly. If you encounter an error, check your cable connections for that server and reboot. If the problem persists, please refer to the “Troubleshooting” section in this User Manual.

## Using your LCD Rack Console

Now that you have connected your console and servers to your LCD Rack Console, it is ready for use. Select connected servers through the On-Screen Display; or by using hot-key commands through the console keyboard. It takes approximately 1–2 seconds for the video signal to refresh after switching servers. Re-synchronization of the mouse and keyboard signals also occurs. This is normal operation and ensures that proper synchronization is established between the console and the connected servers.

**Note:** For security reasons and to conserve energy, the LCD Rack Console has been designed to run off the console monitor after 10 minutes of inactivity. Press any key on the console keyboard to turn on the monitor. If security is enabled in the OSD, you will be prompted to enter a user name and password.

1

2

3

4

5

6

7

8

section

## Selecting a Server or BANK Using Hot-Key Commands

Switch to the next or previous port with simple, keyboard hot-key sequences using the “Scroll Lock” key, and either the “Up” or “Down” arrow keys. To send commands to the KVM Switch, the “Scroll Lock” key must be pressed twice within two seconds. The LCD Rack Console will beep, confirming that it is in hot-key mode. Next, press the “Up” arrow key and the PRO3 KVM Switch will switch to the previous port. Press the “Down” arrow key to switch to the next port.



Switch to previous active port, “Up” arrow.



Switch to next active port, “Down” arrow

With a single-switch configuration (no daisy-chained KVM switches), you can switch directly to any port by entering the 2-digit number of the port you wish to access. For example, if you press “Scroll Lock”, “Scroll Lock”, “02”, the PRO3 KVM Switch will switch to the server on Port 2 located on BANK 00.



Switch to BANK 00, Port 2 [02]

With a daisy-chain switch configuration, you can switch between BANKs (KVM switches) by pressing “Scroll Lock”, “Scroll Lock”, “Page Up”, to switch to the previous BANK. Press “Scroll Lock”, “Scroll Lock”, “Page Down”, to switch to the next BANK.

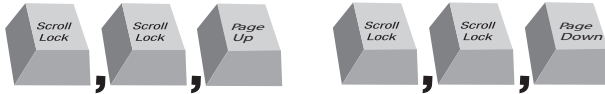

With a daisy-chain switch configuration, you can switch directly to any port on any BANK by pressing “Scroll Lock”, “Scroll Lock”, BANK address, and port number. For example, if you press “Scroll Lock”, “Scroll Lock”, “03”, “05”, the server on BANK 03, Port 5 will become active.

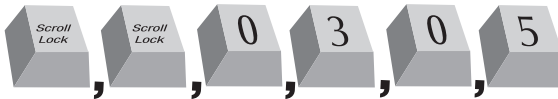

**Note:** You will have approximately five seconds to complete each hot-key sequence.

See page 26 for instructions on how to change the hot-key-initiator key.

1

2

3

4

5

6

7

8

section

## AutoScan Mode

The AutoScan feature allows you to set your LCD Rack Console to scan and monitor the activities of all connected servers one by one. The LCD Rack Console remains on one server for a preset number of seconds, before switching to the next server. The time interval allotted for each server can be adjusted through the OSD menu (see the “AutoScan Time” section).

When the LCD Rack Console is in AutoScan mode, it is also in view-only mode. This means that input from the console (keyboard and mouse) will not be transmitted to the server in focus. Cancel AutoScan to regain control of the server.

To activate the AutoScan function, press “Scroll Lock”, “Scroll Lock”, “A”. To stop AutoScan, press any key on the keyboard.

**Note:** There is no mouse or keyboard control in AutoScan mode. This is necessary to prevent data and synchronization errors. If the user is using the mouse or keyboard when the LCD Rack Console is switching between ports, data flow may become interrupted and could result in erratic mouse movement and/or wrong-character input when using the keyboard.

## On-Screen Display (OSD)

The OSD allows you to switch servers, assign names to your servers, start and stop the AutoScan feature, set the desired scan-time interval for AutoScan, enable the password security feature, and program hot keys. To access the OSD menu, press “Scroll Lock”, “Scroll Lock”, and the space bar. Immediately, the OSD screen will appear. The superimposed menu screen is generated by the LCD Rack Console, and does not affect the function of your server, operating system, or software function.



## Main OSD Page

| P | ORT | N | A | M | E |   |                 |
|---|-----|---|---|---|---|---|-----------------|
| B | A   | N | K | : | 1 | F | 1 : M E N U     |
| 0 | 1   | * | S | Y | S | F | 2 : L O G O U T |
| 0 | 2   | * | S | Y | S | F | 3 : P R E V     |
| 0 | 3   | * | S | Y | S | E | S               |
| 0 | 4   | * | S | Y | S | E | N               |
| 0 | 5   | * | S | Y | S | E | N               |
| 0 | 6   | * | S | Y | S | E | N               |
| 0 | 7   | * | S | Y | S | E | N               |
| 0 | 8   | * | S | Y | S | E | N               |

|                     |  |  |  |  |  |  |   |   |   |   |   |   |   |   |   |   |   |   |
|---------------------|--|--|--|--|--|--|---|---|---|---|---|---|---|---|---|---|---|---|
| P g U p / P g D n : |  |  |  |  |  |  | B | A | N | K | S | E | L | E | C | T |   |   |
| U                   |  |  |  |  |  |  | S | E | R | : | A |   |   |   |   |   |   |   |
| A                   |  |  |  |  |  |  | D | M | I | N | I | S | T | R | A | T | O | R |
| S                   |  |  |  |  |  |  | C | A | N | T | I | M | E | : | I |   |   |   |
| I                   |  |  |  |  |  |  | O | S | E | C |   |   |   |   |   |   |   |   |

The main OSD menu displays the current selected BANK and connected servers to that BANK. If you have only one the LCD Rack Console in your configuration, the OSD menu will display "BANK 00". A "\*" symbol indicates that the connected server is powered up.

## OSD Keyboard Commands

(↑ ↓): Navigate to different servers in the same BANK

(Page Up/Page Down): Select next or previous BANK

(Enter): Switch servers, complete action

(F1): Takes you to options in the Main Menu page

(F2): Session logout

(F3): Takes you to previous screen when navigating through OSD

(Esc): Exits the OSD

1

2

3

4

5

6

7

8

section

To switch servers using the main OSD menu, use the arrow keys on your keyboard to navigate to the desired server, and press the “Enter” key. A “←” symbol indicates which server is currently being accessed on your console. To select a different BANK, press the “Page Up” or “Page Down” key to select the next BANK or the previous BANK.

### Main Menu Page

The following “Main Menu” options are available only to the administrator.

| M A I N M E N U           |                 |                 |         |
|---------------------------|-----------------|-----------------|---------|
| S E L E C T O P T I O N : |                 |                 |         |
| 0 1                       | L A N G U A G E |                 |         |
| 0 2                       | P O R T         | N A M E         | E D I T |
| 0 3                       | P O R T         | S E A R C H     |         |
| 0 4                       | U S E R         | S E T T I N G S |         |
| 0 5                       | A C C E S S     | L I S T         |         |
| 0 6                       | H O T K E Y     |                 |         |
| 0 7                       | A U T O S C A N | T I M E         |         |

The “Main Menu” page allows you to:

- 01 - Set the language for the OSD
- 02 - Edit the naming of individual ports
- 03 - Search for a port by its name
- 04 - Assign user names and passwords
- 05 - Access security settings
- 06 - Change the hot-key trigger
- 07 - Set the AutoScan time interval

## Main-Menu-Page Keyboard Commands

- (↑ ↓): Navigate to the next field
- (Enter): To select an option
- (F3): Return to the main OSD menu
- (Esc): Exit OSD

## Language

This allows you to select which language the OSD will display. You have eight languages to choose from:

- English
- French
- German
- Italian
- Spanish
- Simplified Chinese
- Japanese
- Russian

The default language is set to English. To designate a different language, use the arrow keys to navigate to the desired language field, and then press “Enter” to select and save the entry.

## Port Name Edit

This option allows you to name each port with up to 10 characters. To name the port, use the arrow keys to navigate to the desired server port, and then press “Enter” to select and name the port. Press “Enter” again to save the entry.

## User Setting

This option allows you to specify an administrator/user name and passwords to prevent unauthorized users from accessing the OSD and KVM Switch. One administrator and eight users can be stored. To add the name and password, use the arrow keys to navigate to the desired field, and then press “Enter” to select and edit. Press “Enter” again to save the entry. The maximum characters for the name and password fields are eight characters.

The default administrator name and password are:

**Username: admin**  
**Password: belkin**

1

2

3

4

5

6

7

8

section

### Access List

This feature allows you to discretely specify the user access at a port level. Only the administrator can set up the access list. The column on the left lists the port names. The users are listed by their number (1 to 8). Navigate to the user and port, and press the “Enter” key to enable/deny the access right for each user and port combination. “X” represents access is denied and “O” represents access is enabled.

**Note: User name and password fields cannot be left blank.** If two identical user names are entered, the first user-name password will apply.

### Hot Key

This allows you to select which key will be used to initiate hot-key commands. You have nine key options to choose from:

- Scroll Lock
- Number Lock
- Caps Lock
- Left Ctrl
- Right Ctrl
- Left Alt
- Right Alt
- Left Win
- Right Win

The default key for all hot-key commands is “Scroll Lock” (see “Keyboard Hot-Key-Command Shortcuts” on the next page). To designate a different key to initiate hot-key commands, use the arrow keys to navigate to the “Hot Key” field, and then press “Enter” to select and save the entry.

### AutoScan Time

This specifies the amount of time the LCD Rack Console remains on a server before switching to the next server while in AutoScan mode. You can set the scan-time interval to anywhere between 05 and 99 seconds. To change the scan time, use the arrow keys to navigate to the “Scan Time” field and hit “Enter”, and then type the desired time interval (in seconds).

To enable AutoScan, refer to the hot-key section on page 27.

**Note:** The number keypad will not function in the OSD.

## Keyboard Hot-Key-Command Shortcuts

Below is a complete list of hot-key commands that can be used for your LCD Rack Console:

| Command            | Function  |
|--------------------|---|
| Space Bar          | Activate OSD  |
| ↑                  | Previous host   |
| ↓                  | Next host   |
| [01,02...,16] port | Non-daisy-chain KVM switch  |
| [00,01...,15] BANK | Daisy-Chain Config: First and second digit specifies BANK                                 |
| [01,02...,16] port | Daisy-Chain: Third and fourth digit specifies number                                      |
| PgUP               | Previous BANK   |
| PgDown             | Next BANK   |
| B                  | Turn on/off beep while in AutoScan mode   |
| S                  | Enable/disable OSD security   |
| P                  | Turns console screen "Off", and prompts for user name and password if security is enabled |
| A                  | Administrator activates AutoScan  |
| Delete             | Administrator sets the OSD back to factory-default values (except for security settings)  |

**Note:** You will have approximately three seconds to complete each hot-key sequence.

1

2

3

4

5

6

7

8

section

## Sun Combo and Mac® Key Mapping

The keyboard does not support the Sun keypad to perform special functions in the Sun operating-system environment. When the LCD Rack Console is connected to a Sun server, the KVM Switch emulates the Sun keys using a set of key combinations called “combo keys”. Some Mac keys are also mapped. Please refer to the table below.

| Windows<br>USB Keyboard           | Sun Micro<br>USB Keyboard | Mac<br>USB Keyboard |
|-----------------------------------|---------------------------|---------------------|
| Caps Lock & L_Alt                 | Stop                      |                     |
| Caps Lock & L_Ctrl                | Props                     |                     |
| Caps Lock & L_Shift (Application) | Compose                   |                     |
| Caps Lock & 1                     | Mute                      |                     |
| Caps Lock & 2                     | Volume down               |                     |
| Caps Lock & 3                     | Volume up                 |                     |
| Caps Lock & F3                    | Find                      |                     |
| Caps Lock & F1                    | Front                     |                     |
| Caps Lock & F2                    | Open                      |                     |
| Caps Lock & F4                    | Again                     |                     |
| Caps Lock & F5                    | Undo                      |                     |
| Caps Lock & F8                    | Cut                       |                     |
| Caps Lock & F6                    | Copy                      |                     |
| Caps Lock & F7                    | Paste                     |                     |
| Caps Lock & F11                   | Help                      |                     |
| Caps Lock & F12                   | Power                     | Power               |
| Windows key                       |                           | Apple key           |
| Alt                               |                           | Option              |
| Print Screen                      |                           | F13                 |
| Scroll Lock                       |                           | F14                 |
| Pause Break                       |                           | F15                 |

## Updating Firmware

1

The LCD Rack Console features flash-upgradeable firmware to ensure compatibility with the latest devices and servers. Firmware upgrades are free for the life of your LCD Rack Console.

2

To update your firmware, download the appropriate firmware file and utility from [www.belkin.com/support/](http://www.belkin.com/support/). The utility will guide you through the process of updating the firmware on your LCD Rack Console.

3

**⚠ Warning!** We strongly recommend that you update your firmware only if you are experiencing mouse and keyboard problems with your LCD Rack Console, as reconfiguring software may lead to unexpected operational problems. Please contact Belkin Technical Support if you need assistance.

4

section

5

**To update the firmware, you will need the following items:**

6

1. A separate server running Windows 2000, XP, or Vista. This server must NOT be connected to the server ports on the LCD Rack Console.
2. An available serial port on the server.
3. A custom Serial Flash Cable (DB9 male-to-RJ11; included with purchase) that connects between the LCD Rack Console and the server.

7

You will need to follow these instructions:

8

1. Power off the LCD Rack Console.
2. Connect the Serial Flash Cable's RJ11 end to the LCD Rack Console and the DB9F end to an available serial (COM) port on the computer.
3. Notice that there are two flashes that can be upgraded. **Please make sure you select the correct FW upgrade file and set the Flash DIP switch in the correct position.**

| DIP Switch |     | Function                     |
|------------|-----|------------------------------|
| 1          | 2   |                              |
| ON         | ON  | Normal Run Operation mode    |
| OFF        | ON  | Upgrade Main KVM CPU mode    |
| ON         | OFF | Upgrade Daisy-Chain CPU mode |
| OFF        | OFF | Reserved (not used)          |

4. Run "BELKIN Firmware Upgrade Utility.exe". Click "Browse" to select the FW upgrade file. Make sure the Comm-port setting matches the port where the Serial Flash Cable is connected.

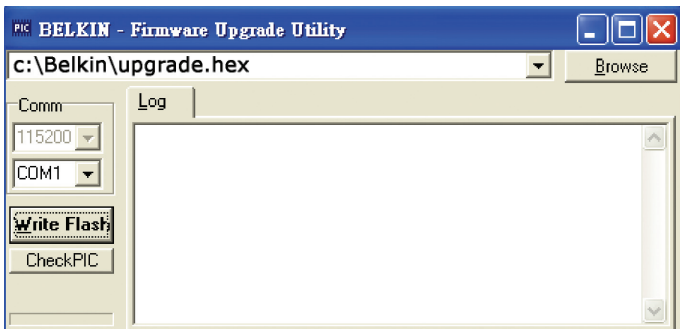

5. Apply power to the LCD Rack Console. The KVM Switch will enter into flash-upgrade mode and wait for the data to upgrade.
6. Click “Write Flash” to start the upgrade. The upgrade process takes about six seconds. You should see “WRITE OK” display when the upgrade completes successfully.

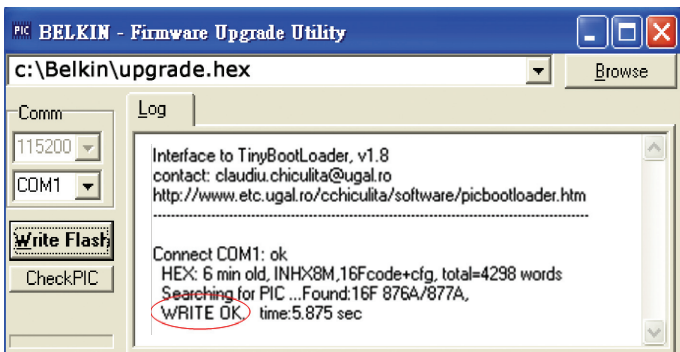

7. Disconnect the Serial Flash Cable, **POWER OFF** the KVM Switch, set the DIP switch back to the Normal Run Operation position “ON, ON”, and then power on the LCD Rack Console. The LCD Rack Console should be running on the new firmware. The OSD will display the FW version in the bottom-right corner of the “Main Menu” page.



- Q: Which operating systems does the LCD Rack Console support?**
- A:** The LCD Rack Console will support any operating system that runs on a PS/2 and USB platform. Operating systems include, but are not limited to, DOS; Windows 95, 98, 2000, Me, NT, XP, 2003 Server, Vista; Sun; Linux; and Mac OS.
- Q: Can I mix PS/2 and USB servers on the host side?**
- A:** Yes, the LCD Rack Console will support any mix of PS/2 and USB host servers at a time.
- Q: What does flash-upgradeable mean?**
- A:** With flash-upgrade capability, you can update your LCD Rack Console firmware at any time through a simple serial connection. Upgrade capability ensures that your LCD Rack Console is always the most current version on the market with the latest features and enhancements. See the “Updating Firmware” section in this User Manual.
- Q: How does the LCD Rack Console allow the user to switch between ports?**
- A:** The LCD Rack Console supports two methods of port selection. The user can select servers using specially designated keyboard hot keys or through the On-Screen Display.
- Q: How far can the server be from the LCD Rack Console?**
- A:** The LCD Rack Console can be placed up to 25 feet away from your PS/2 server and up to 15 feet away from your USB server.
- Q: What is the maximum video resolution that the LCD Rack Console supports?**
- A:** The advanced video circuit in the LCD Rack Console supports a maximum resolution of up to 1280x1024@65Hz.

1

---

2

---

3

---

4

---

5

---

6

---

7

---

8

---

section

## Frequently Asked Questions

---

**Q: Do I have to install any software to use the LCD Rack Console?**

**A:** No, the LCD Rack Console does not require any drivers or software to be installed in your servers. Simply connect all your servers to the Belkin KVM Cable Kits and it is ready for use.

**Q: Does the LCD Rack Console require an AC adapter?**

**A:** Yes, the LCD Rack Console requires a 12-volt DC, 1-Amp power adapter in order to function properly.

**Q: Can I use the LCD Rack Console to switch video signals only?**

**A:** No, the LCD Rack Console must be connected to both the video and keyboard/mouse ports on your servers. The LCD Rack Console detects the power from the PS/2 and USB ports on your servers in order to function.

**Q: Can I use the LCD Rack Console on my Sun server that supports USB?**

**A:** Yes, the LCD Rack Console works with any USB-capable server.

**Q: Does the LCD Rack Console support Linux?**

**A:** Yes, the LCD Rack Console works with Red Hat and other Linux distributions configured for PS/2 or USB support.

**Q: How long is the warranty for the LCD Rack Console?**

**A:** The LCD Rack Console comes with a 2-Year Limited Warranty.

### **My server does not boot up when connected to the LCD Rack Console, but works fine when I connect the keyboard, video, and mouse directly to the server.**

- Make sure that the keyboard and mouse cables are connected tightly between the LCD Rack Console and the server.
- Check that the keyboard and mouse cables are not crossed.
- Check the cable connections.

### **I am getting ghosting, shadowing, or fuzzy images on my monitor.**

- Check that all video cables are inserted properly to the Cable Kit.
- Check that the monitor supports the resolution and refresh-rate setting on your server.
- Lower the video resolution of the monitor.
- Check that the cable length does not exceed 25 feet.
- Check that the graphics card you are using supports the resolution and refresh-rate setting on your server.

### **I am getting a black screen on my monitor.**

- Check that all video cables are inserted properly.
- Check that the keyboard cable is connected and inserted properly between the server the appropriate port on the LCD Rack Console.
- Move the mouse and see if it is necessary to log in as a user.

### **The server does not detect a keyboard and I get a keyboard error reported at boot up.**

- Check that the cable kit on the LCD Rack Console is completely connected to your server. Tighten any loose connections.
- Check whether USB-keyboard legacy support is enabled in the system BIOS.
- If you are using the keyboard software that was included with your keyboard, uninstall it and then reinstall the standard Microsoft keyboard driver.
- Try booting the problem computer while the port is selected and wait until the operating system loads before switching away to another computer.

1

2

3

4

5

6

7

8

### **The mouse is lost when I switch to a different port.**

- Tighten any loose cable connections.
- If you are using a mouse driver that was included with your mouse, uninstall it and install the standard Microsoft mouse driver.
- If the server is coming out of standby mode, allow up to one minute to regain mouse function.
- De-activate power-management schemes on the PC with which you are experiencing problems.

### **The mouse is not detected at boot up.**

- Check the cables and make sure that they are inserted correctly.

### **The server boots up, but the mouse does not work.**

- Try booting the problem computer while the port is selected and wait until the operating system loads before switching away to another computer.

### **When I switch from one port to another, mouse movement is completely erratic**

- Make sure you do not have more than one mouse driver installed. Make sure that the driver is either for a standard PS/2 or USB mouse, or a Microsoft server-compatible PS/2 or USB mouse.
- Make sure you do not have any mouse drivers loaded in your "CONFIG.SYS" or "AUTOEXEC.BAT" files.
- Avoid moving the mouse or pressing the mouse button when switching ports on the LCD Rack Console.

## USB

### **I am connecting the USB Cable Kit to a USB server, and my keyboard and mouse do not work.**

- Prior to connecting the LCD Rack Console, make sure that the HID USB driver is installed on each server. (To install the HID USB driver, connect a USB mouse and USB keyboard to the server. A Windows operating system should automatically install the drivers.)

### **Some of the keys on my keyboard are not functioning properly when I use a Mac server.**

- If you are accessing a Mac system, a few of the option keys on your keyboard may be reversed. All major keys will function as labeled. Refer to the “Sun Combo and Mac Key Mapping” section in this User Manual.

1

---

2

---

3

---

4

---

5

---

6

---

7

---

8

---

section

The following definitions are used throughout this User Manual.

**AutoScan:** A mode of operation where the KVM switch scans from one port to another, on an ongoing basis, as configured by the user.

**BANK:** The address of a daisy-chained KVM switch (00–15), set by the DIP switch.

**Console:** The all-in-one term for the keyboard, video monitor, and mouse connected to a KVM switch.

**Console Port:** Receptors for the console to connect to the KVM switch.

**Control:** When discussing switching between ports, control means that the console is capable of sending input to the server. Control requires that the console also has focus on the port, and is viewing it.

**DDC:** Short for Display Data Channel, a VESA standard for communication between a monitor and a video adapter. Using DDC, a monitor can inform a computer's video card about its properties, such as maximum resolution and color depth, to ensure that the user is presented with valid options for configuring the display.

**Daisy-Chain:** A configuration of multiple KVM switches that are connected one to another in a series. A KVM switch daisy-chain uses common settings to allow seamless, complex interactions between multiple consoles for control over many servers.

**HID:** Human Interface Device, the USB device class that includes keyboards and mice.

**KVM:** Literally “Keyboard Video Mouse”, this term refers to technology that allows two or more computers to be controlled by one keyboard, video monitor, and mouse; some switches that use KVM technology enable sharing of other peripherals such as audio speakers, microphones, and printers.

**KVM Switch:** A device that allows a user to access and control multiple servers from a single console. It has at least one console port and multiple server ports.

**OSD:** On-Screen Display, a Graphical User Interface that can be used to control and configure the KVM switch.

**Port:** An interface receptor on a server through which you can attach a device or plug in a device cable.

**Primary KVM Switch:** The KVM switch that is connected to the console and is set to BANK address 00.

**Secondary KVM Switch:** Any KVM switch that is daisy-chained to the primary KVM switch and is set to BANK address 01–15 (and has no console connected).

## FCC Statement

### DECLARATION OF CONFORMITY WITH FCC RULES FOR ELECTROMAGNETIC COMPATIBILITY

We, Belkin International, Inc., of 501 West Walnut Street, Compton CA 90220, declare under our sole responsibility that the products:

F1DC108B-SR, F1DC116B-SR,

to which this declaration relates:

Comply with Part 15 of the FCC Rules. Operation is subject to the following two conditions:

- (1) this device may not cause harmful interference, and
- (2) this device must accept any interference received, including interference that may cause undesired operation.

### CE Declaration of Conformity

We, Belkin International, Inc., declare under our sole responsibility that the products F1DC108B-SR, F1DC116B-SR, to which this declaration relates, are in conformity with Emissions Standard EN55022 and with Immunity Standard EN55024, LVP EN61000-3-2, and EN61000-3-3.

### ICES

This Class A digital apparatus complies with Canadian ICES-003. Cet appareil numérique de la classe A est conforme à la norme NMB-003 du Canada.

### Belkin International, Inc., Limited 2-Year Product Warranty

What this warranty covers.

Belkin International, Inc. ("Belkin") warrants to the original purchaser of this Belkin product that the product shall be free of defects in design, assembly, material, or workmanship.

#### **What the period of coverage is.**

Belkin warrants the Belkin product for two years.

What will we do to correct problems?

#### *Product Warranty.*

Belkin will repair or replace, at its option, any defective product free of charge (except for shipping charges for the product).

1

2

3

4

5

6

7

8

section

What is not covered by this warranty?

All above warranties are null and void if the Belkin product is not provided to Belkin for inspection upon Belkin's request at the sole expense of the purchaser, or if Belkin determines that the Belkin product has been improperly installed, altered in any way, or tampered with. The Belkin Product Warranty does not protect against acts of God such as flood, lightning, earthquake, war, vandalism, theft, normal-use wear and tear, erosion, depletion, obsolescence, abuse, damage due to low voltage disturbances (i.e. brownouts or sags), non-authorized program, or system equipment modification or alteration.

### **How to get service.**

To get service for your Belkin product you must take the following steps:

1. Contact Belkin International, Inc., at 501 W. Walnut St., Compton, CA 90220, Attn: Customer Service, or call (800)-223-5546, within 15 days of the Occurrence. Be prepared to provide the following information:
  - a. The part number of the Belkin product.
  - b. Where you purchased the product.
  - c. When you purchased the product.
  - d. Copy of original receipt.
2. Your Belkin Customer Service Representative will then instruct you on how to forward your receipt and Belkin product and how to proceed with your claim.

Belkin reserves the right to review the damaged Belkin product. All costs of shipping the Belkin product to Belkin for inspection shall be borne solely by the purchaser. If Belkin determines, in its sole discretion, that it is impractical to ship the damaged equipment to Belkin, Belkin may designate, in its sole discretion, an equipment repair facility to inspect and estimate the cost to repair such equipment. The cost, if any, of shipping the equipment to and from such repair facility and of such estimate shall be borne solely by the purchaser. Damaged equipment must remain available for inspection until the claim is finalized. Whenever claims are settled, Belkin reserves the right to be subrogated under any existing insurance policies the purchaser may have.

### **How state law relates to the warranty.**

THIS WARRANTY CONTAINS THE SOLE WARRANTY OF BELKIN. THERE ARE NO OTHER WARRANTIES, EXPRESSED OR, EXCEPT AS REQUIRED BY LAW, IMPLIED, INCLUDING THE IMPLIED WARRANTY OR CONDITION OF QUALITY, MERCHANTABILITY OR FITNESS FOR A PARTICULAR PURPOSE, AND SUCH IMPLIED WARRANTIES, IF ANY, ARE LIMITED IN DURATION TO THE TERM OF THIS WARRANTY.

Some states do not allow limitations on how long an implied warranty lasts, so the above limitations may not apply to you.



IN NO EVENT SHALL BELKIN BE LIABLE FOR INCIDENTAL, SPECIAL, DIRECT, INDIRECT, CONSEQUENTIAL OR MULTIPLE DAMAGES SUCH AS, BUT NOT LIMITED TO, LOST BUSINESS OR PROFITS ARISING OUT OF THE SALE OR USE OF ANY BELKIN PRODUCT, EVEN IF ADVISED OF THE POSSIBILITY OF SUCH DAMAGES.

This warranty gives you specific legal rights, and you may also have other rights, which may vary from state to state. Some states do not allow the exclusion or limitation of incidental, consequential, or other damages, so the above limitations may not apply to you.

## Free Tech Support\*

You can find additional support information on our website [www.belkin.com](http://www.belkin.com) through the tech-support area. If you want to contact technical support by phone, please call the number you need from the list below\*.

\*Local rates apply

| Country         | Number                            | Internet address  |
|-----------------|-----------------------------------|---|
| AUSTRIA         | 0820 200766                       | <a href="http://www.belkin.com/uk/networking/">http://www.belkin.com/uk/networking/</a>   |
| BELGIUM         | 07 07 00 073                      | <a href="http://www.belkin.com/nl/networking/">http://www.belkin.com/nl/networking/</a>   |
| CZECH REPUBLIC  | 239 000 406                       | <a href="http://www.belkin.com/uk/networking/">http://www.belkin.com/uk/networking/</a>   |
| DENMARK         | 701 22 403                        | <a href="http://www.belkin.com/uk/networking/">http://www.belkin.com/uk/networking/</a>   |
| FINLAND         | 00800 - 22 35 54 60               | <a href="http://www.belkin.com/uk/networking/">http://www.belkin.com/uk/networking/</a>   |
| FRANCE          | 08 - 25 54 00 26                  | <a href="http://www.belkin.com/fr/networking/">http://www.belkin.com/fr/networking/</a>   |
| GERMANY         | 0180 - 500 57 09                  | <a href="http://www.belkin.com/de/networking/">http://www.belkin.com/de/networking/</a>   |
| GREECE          | 00800 - 44 14 23 90               | <a href="http://www.belkin.com/uk/networking/">http://www.belkin.com/uk/networking/</a>   |
| HUNGARY         | 06 - 17 77 49 06                  | <a href="http://www.belkin.com/uk/networking/">http://www.belkin.com/uk/networking/</a>   |
| ICELAND         | 800 8534                          | <a href="http://www.belkin.com/uk/networking/">http://www.belkin.com/uk/networking/</a>   |
| IRELAND         | 0818 55 50 06                     | <a href="http://www.belkin.com/uk/networking/">http://www.belkin.com/uk/networking/</a>   |
| ITALY           | 02 - 69 43 02 51                  | <a href="http://www.belkin.com/it/support/tech/issues_more.asp">http://www.belkin.com/it/support/tech/issues_more.asp</a>             |
| LUXEMBOURG      | 34 20 80 85 60                    | <a href="http://www.belkin.com/uk/networking/">http://www.belkin.com/uk/networking/</a>   |
| NETHERLANDS     | 0900 - 040 07 90 €0.10 per minute | <a href="http://www.belkin.com/nl/networking/">http://www.belkin.com/nl/networking/</a>   |
| NORWAY          | 81 50 0287                        | <a href="http://www.belkin.com/uk/networking/">http://www.belkin.com/uk/networking/</a>   |
| POLAND          | 00800 - 441 17 37                 | <a href="http://www.belkin.com/uk/networking/">http://www.belkin.com/uk/networking/</a>   |
| PORTUGAL        | 707 200 676                       | <a href="http://www.belkin.com/uk/networking/">http://www.belkin.com/uk/networking/</a>   |
| RUSSIA          | 495 580 9541                      | <a href="http://www.belkin.com/networking/">http://www.belkin.com/networking/</a>   |
| SOUTH AFRICA    | 0800 - 99 15 21                   | <a href="http://www.belkin.com/uk/networking/">http://www.belkin.com/uk/networking/</a>   |
| SPAIN           | 902 - 02 43 66                    | <a href="http://www.belkin.com/es/support/tech/networkingsupport.asp">http://www.belkin.com/es/support/tech/networkingsupport.asp</a> |
| SWEDEN          | 07 - 71 40 04 53                  | <a href="http://www.belkin.com/se/support/tech/networkingsupport.asp">http://www.belkin.com/se/support/tech/networkingsupport.asp</a> |
| SWITZERLAND     | 08 - 48 00 02 19                  | <a href="http://www.belkin.com/uk/networking/">http://www.belkin.com/uk/networking/</a>   |
| UNITED KINGDOM  | 0845 - 607 77 87                  | <a href="http://www.belkin.com/uk/networking/">http://www.belkin.com/uk/networking/</a>   |
| OTHER COUNTRIES | +44 - 1933 35 20 00               |   |

# BELKIN®

## OmniView® LCD Rack Console with Built-In PRO3 KVM Switch

# BELKIN®

[www.belkin.com](http://www.belkin.com)

### **Belkin Ltd.**

Express Business Park  
Shipton Way, Rushden  
NN10 6GL, United Kingdom  
+44 (0) 1933 35 2000  
+44 (0) 1933 31 2000 fax

### **Belkin SAS**

130 rue de Sully  
92100 Boulogne-Billancourt  
France  
+33 (0) 1 41 03 14 40  
+33 (0) 1 41 31 01 72 fax

### **Belkin B.V.**

Boeing Avenue 333  
1119 PH Schiphol-Rijk  
Netherlands  
+31 (0) 20 654 73 00  
+31 (0) 20 654 73 49 fax

### **Belkin Iberia**

Avda. Cerro del Aguila 3  
28700 San Sebastián de los Reyes  
Spain  
+34 91 625 80 00  
+34 902 02 00 34 fax

### **Belkin GmbH**

Hanebergstrasse 2  
80637 Munich  
Germany  
+49 (0) 89 14 34 05 0  
+49 (0) 89 14 34 05 100 fax

### **Belkin Sweden**

Knarrarnäsgatan 7  
164 40 Kista  
Sweden  
+46 (0) 8 5229 1870  
+46 (0) 8 5229 1874 fax

## Free Manuals Download Website

<http://myh66.com>

<http://usermanuals.us>

<http://www.somanuals.com>

<http://www.4manuals.cc>

<http://www.manual-lib.com>

<http://www.404manual.com>

<http://www.luxmanual.com>

<http://aubethermostatmanual.com>

Golf course search by state

<http://golfingnear.com>

Email search by domain

<http://emailbydomain.com>

Auto manuals search

<http://auto.somanuals.com>

TV manuals search

<http://tv.somanuals.com>