

Uniden®

UIP300

(H.323 IP Phone)



Administrator Guide

Preface

This Document

This document provides instructions to user for operating UIP300 IP Phone. This manual provides a detailed description of the telephone, LCD displays and features. Basic telephone operations and features are explained. Setup and configuration instructions are also provides.

*Uniden® is a registered trademark of Uniden America Corporation.

*Artisoft® and Televantage® are registered trademarks of Artisoft, Inc.

Regulatory Information

FCC Part 15

Complies with the limits for a Class B computing device pursuant to Subpart B of Part 15 of FCC Rules.

U.L. Compliance

This equipment complies with Underwriters Laboratories Standard U.L. 60950.

Repairs

NO REPAIRS CAN BE DONE BY THE CUSTOMER

Hearing-Aid Compatibility

The equipment is hearing-aid compatible.



The act of monitoring or recording telephone conversations under certain circumstances may violate federal or state statutes. Consultation with your legal counsel prior to engaging in such practices would be advisable.

Industry Canada (ICES-003)

This class B digital apparatus complies with Canadian ICES-003.



Users should not attempt to make such connections themselves, but should contact the appropriate electric inspection authority, or electrician, as appropriate.

Important Safety Considerations

When using this product, basic safety precautions should always be followed to reduce the risk of fire, electrical shock, and injury to persons, including the following:

- 1 Read and understand all instructions.
- 2 Follow all warnings and instructions marked on the product.
- 3 Unplug this product from the wall outlet before cleaning. Do not use liquid cleaners or aerosol cleaners. Use a dry cloth for cleaning.
- 4 **Do not** use this product near water; for example, near a sink or in a wet area.
- 5 **Do not** place this product on an unstable cart, stand, or table. The telephone can fall, causing serious damage to the unit.
- 6 Slots and openings in the cabinet and the back or bottom are provided for ventilation. To protect the product from overheating, these openings must not be blocked or covered. This product should never be placed near or over a radiator or heat register. This product should not be placed in a built-in installation unless the proper ventilation is provided.
- 7 This product should be operated only from the type of power source indicated on the marking label. If you are not sure of the type of power supply to your home, consult your dealer or local power company.
- 8 **Do not** allow anything to rest on the power cord. Do not locate this product where the cord will be damaged by people walking on it.
- 9 **Do not** overload wall outlets and extension cords, as this can result in the risk of fire or electrical shock.
- 10 Never push objects of any kind into this product through cabinet slots, as they may touch dangerous voltage points or short out parts that could result in a risk of fire or electrical shock. Never spill liquid of any kind on the product.
- 11 To reduce the risk of electric shock, do not disassemble this product. Contact qualified service personnel when some service or repair work is required. Opening or removing covers may expose you to dangerous voltages or other risks. Incorrect reassembly can cause electric shock when the appliance is subsequently used.
- 12 Unplug this product from the wall outlet and refer servicing to qualified service personnel under the following conditions:
 - A When the power supply cord is damaged or frayed.
 - B If liquid has been spilled onto the product.
 - C If the product has been exposed to water or rain.
 - D If the product does not operate normally when following the operating instructions. (Adjust only those controls that are covered by the operating instructions. Improper adjustment of other controls can result in damage, and will often require extensive repair work by a qualified technician.)
 - E If the product has been dropped, or the cabinet has been damaged.
 - F If the product exhibits a distinct change in performance.
- 13 Uniden works to reduce lead content in our PVC coated cords in our products and accessories.

Warning: The cords on this product and/or accessories contain lead, a chemical known to the State of California to cause birth defects or other reproductive harm.

Wash hands after handling.

Important Electrical Considerations

Unplug all electrical appliances when you know an electrical storm is approaching. Lightning can pass through your household wiring and damage any device connected to it. This product is no exception.

WARNING! Please do not attempt to unplug any appliance during an electrical storm.

The FCC Wants You to Know

Changes or modifications to this product not expressly approved by the party responsible for compliance could void the user's authority to operate the equipment.

note

This equipment has been tested and found to comply with the limits for a Class B digital device pursuant to part 15 of the FCC Rules. These limits are designed to provide reasonable protection against harmful interference in a residential installation. This equipment generates, uses and can radiate radio frequency energy and, if not installed and used in accordance with the instructions, and may cause harmful interference to radio communications. However, there is no guarantee that interference will not occur in a particular installation.

If this equipment does cause harmful interference to radio or television reception, which can be determined by turning the equipment off and on, the user is encouraged to try to correct the interference by one or more of the following measures:

- Reorient or relocate the receiving antenna.
- Increase the separation between the equipment and the receiver.
- Connect the equipment into an outlet on a circuit different from that to which the receiver is connected.
- Consult the dealer or an experienced radio/TV technician for help.

Optional AC Adapter

The UIP300 is intended to be supplied by AD300 a UL Listed direct plug-in power unit marked "Class 2" or "LPS" or "I.T.E. Power Supply" and rated 48Vdc, 0.25A output which is available as optional. When you use an AC Adapter, use and AC outlet without a switch to interrupt power, and do not use an outlet controlled by a wall switch.

note

Place the power cord so that it does not create a trip hazard, or where it could become chafed and create a fire or other electrical hazards.

Table of Contents

Chapter 1 Product Description

General Information	8
Standard Features of the Telephone	9
VoIP Specific Features	9
General Features	9
Control and Functions of the Telephone	10
Function Keys.....	10
LED Status	10
Specifications	11
Physical Interface.....	11
Power Supply	11
Speaker	11
Optional & Replacement Equipment	12

Chapter 2 Installation and Basic Setup Instructions

General Information	13
Attaching the Footstand to the Telephone	13
Connecting the Telephone	14
Quick Setup Procedure	15

Chapter 3 Basic Operations

General Information	23
Telephone Operations	23
Standby	23
Originating Calls	24
Using the Handset	24
Using the Phone Book	24
Using On-Hook Dialing	25
Receiving Calls	25
Answering Calls Using the Handset	25
Answering Calls Handsfree.....	25
2-Line Operation	25
Accessing Line 1	25
Accessing a Line Using the Line Key	26
Volume Control.....	26

Handset Volume Control	26
Speakerphone Volume Control	26
Headset Volume Control	27
Ringer Volume Control	27
Feature Operations	28
Handsfree	28
Speakerphone	28
Headset.....	28
Receiving a Call Using Handsfree	28
Phone Book	28
Programmable and Fixed Function Keys	29
Speed Dial.....	29
Do Not Disturb (DND)	29
Voice Mail	30
Redial	30
Mute	30
Hold.....	30
Transfer.....	31
Blind Transfer	31
Supervised Transfer	31
Conference	31
Call Waiting.....	31

Chapter 4 Setup Menu

General Information	32
Basic Setup Menu Options.....	32
Call Log Submenu	32
Phone Book Submenu.....	35
Searching Telephone Records	36
Name Search	36
Quick Search	37
Telephone Configuration	42
Call Duration	43
Local Date/Time	44
Ringer Tone.....	45
LCD Contrast	45
Function Key	46
Network Configuration	47
Enable/Disable DHCP	48
Terminal IP Address	49

Terminal Subnet Mask.....	50
Default Gateway IP Address	51
Enable/Disable VLAN	52
VLAN ID	53
Restore Factory Settings.....	54
View Info	54
Web-Based Setup and Configuration	55
User Configuration	55
Phone Settings Configuration	57
Function Key Configuration.....	58
Phone Book.....	59
Password Change	60
Administrator Configuration.....	61
Network Configuration	63
H.323 Configuration	64
SNTP Server	65
Codec Configuration	66
Add/Del User and Password	67
Change Administrator's Password.....	68
Update Firmware.....	69
Update Configuration File	71

Chapter 5 Appendix

General Information	73
Factory Default Settings.....	73
Setup Menu Tree	75

List of Figures

Figure 1-1	UIP300 IP Phone.....	8
Figure 2-1	Footstand Mounting.....	13
Figure 2-2	Plugging Handset Cord into Telephone.....	14
Figure 2-3	Connecting to LAN	14
Figure 2-4	Web Login Screen.....	19
Figure 2-5	Network Configuration.....	20
Figure 2-6	H.323 Configuration	21
Figure 2-7	Codec Configuration	22
Figure 4-1	Call Log Menu Structure	32
Figure 4-2	Actions Applicable to Phone Book Records	35
Figure 4-3	Normal Phone Book Record Data Input Sequence	38
Figure 4-4	Phone Configuration Menu	42
Figure 4-5	Function Keys	46
Figure 4-6	Web Login Screen.....	55
Figure 4-7	User Main Page.....	56
Figure 4-8	Phone Settings	57
Figure 4-9	Function Key Configuration.....	58
Figure 4-10	Phone Book Configuration	59
Figure 4-11	Password Change	60
Figure 4-12	Web Login Screen.....	61
Figure 4-13	Administrative Configuration Main Page.....	62
Figure 4-14	Network Configuration.....	63
Figure 4-15	H.323 Configuration	64
Figure 4-16	SNTP Server Configuration.....	65
Figure 4-17	Codec Configuration	66
Figure 4-18	Add/Delete User ID and Password	67
Figure 4-19	Administrator Password	68
Figure 4-20	Update Firmware.....	69
Figure 4-21	Update Configuration	71

Chapter 1 Product Description

General Information

UIP300 is a business IP telephone in an enterprise LAN environment and will be connected to a softswitch.

This chapter describes the features of the UIP300 IP Phone and protocols that are used.

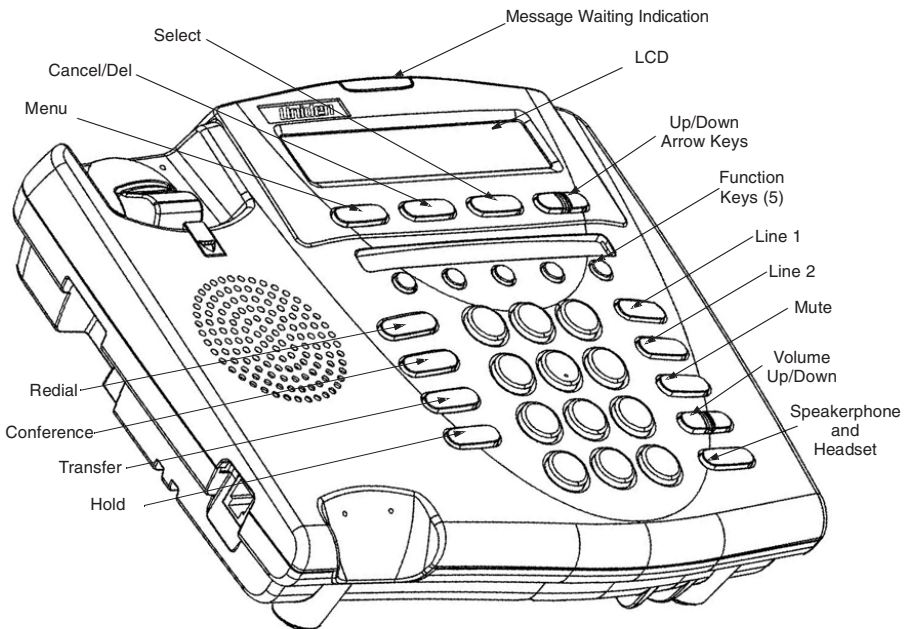

Figure 1-1 UIP300 IP Phone

Standard Features of the Telephone

The UIP300 comes equipped with the following standard features.

- 2-line, 24-character alphanumeric LCD display
- 10 LED indicators (Line 1, Line 2, Message Waiting Indication, Mute, Speaker/Headset, five Function keys)
- 12-key dial pad
- 20 specific keys (five Function keys, Menu, Select, Cancel/Del, Transfer, Mute, Redial, Hold, Conference, Speaker, Line 1 and 2 keys, Volume Up/Down keys, Menu Up/Down keys)
- Date and time configured locally or from SNTP Server
- Call duration display
- Volume control for speaker, handset, headset and ringer
- Phone book and speed dial
- Redial, Hold, Mute
- Call Waiting, Call Transfer, 3-way Conference and Do Not Disturb (DND)
- Display Caller ID (Name)
- On-hook dialing, Handsfree talking
- DTMF generation
- 8 ringer tones

VoIP Specific Features

The following features are specific to the VoIP function.

- H.323 standard complaint
- Voice Codec: G.711 (μ -Law and A-Law), G723.1A(6.3kbits/s), G729AB
- E.164 dialing
- Acoustic Echo Cancellation (AEC) (G.167)
- Rapid configuration with DHCP or statically configured IP address
- Voice Activity Detection (VAD)
- QoS (IEEE 802.1 p/q based and DiffServ)
- Jitter compensation
- 10/100 Base-T Ethernet Interface

General Features

The following general features include:

- Terminal and web-based configuration
- Firmware/configuration download via Web
- Password protection for configuration

Control and Functions of the Telephone

To make telephone operations easier and to avoid user confusion, many required functions are already programmed into the fixed function keys. There are 15 fixed function keys in UIP300.

- Speaker – Turn speakerphone or headset on/off
- Mute – Enable/disable the Mute function
- Hold – Hold the called party
- Transfer – Generate a DTMF String which the user can set
- Conference – Generate a DTMF String which the user can set
- Redial – Generate a DTMF String which the user can set / Enter “,” , pause digit for phone book or speed dial numbers.
- Menu – Display the main Setup menu if in the Standby screen, or return to Standby screen if in any menu or submenu screen
- Select – Confirm a particular choice inside any menu screen
- Cancel/Del
 - ◇ Works as delete key when there is one or more character(s)
The character string may contain one or more digits as part of the string.
 - ◇ Works as backspace key when there is one or more digit(s)
 - ◇ Deletes the entire character string or digit(s) if this key is pressed and held for two seconds or longer.
 - ◇ Cancels the operation in the setup menu and returns to the previous menu.
- Navigation ▲ (up) and ▼ (down) Keys – Primarily used to navigate up or down the Setup Menu.
- Volume ▲ (up) and ▼ (down) Keys – Used for adjusting the volume louder or softer.
- Telephone Line Keys – Used to select telephone line 1 or 2.

Function Keys

There are five user programmable function keys in UIP300. Each can be programmed to one of the three available functions – Speed Dial, Do Not Disturb (DND), and Voice Mail.

LED Status

There are 10 LEDs in UIP300. Four LEDs are located adjacent to the four fixed keys. Lines 1 and 2, Speaker and Mute show the status of the function in each key. The Message Waiting Indication is dedicated to notify the user for the arrival of an incoming call or a new voice mail. Table 1-1 “LED Status” lists the LEDs and describes that states of the LED.

- Message Waiting Indication with activation of voice mail function in the system.

Table 1-1 LED Status

LED	LED On	LED Blinking	LED Off
Speaker/Headset	Turned on when the SPK/HS is pressed	N/A	When not used
Mute	While call is muted	N/A	While not muted
Message Waiting Indication	When there is 1 or more new voice mail(s)	Arrival of Incoming Call when It is a regular call It is a call waiting call (Fast blinking)	when no more new voice mail or no incoming call is waiting
Line 1	When in use	When Line 1 is on hold. (Slow blinking) When incoming call comes thru Line 1 (Fast blinking)	When not in use
Line 2	When in use	When Line 2 is on hold. (Slow blinking). When incoming call comes thru Line 2 (Fast blinking)	When not in use
Function Keys			
Speed Dial/Voice Mail	Turned on when the key is pressed and it remain on for 5 seconds.	N/A	Whenever any of the following occurs: <ul style="list-style-type: none"> • 5 seconds after it is turned on • When it returns to on hook • A different speed dial key is pressed
Do Not Disturb (DND)	While DND is activated	N/A	While DND is off



The On and Off time for “Fast blinking” is 200 ms cycle and the time for “Slow blinking” is 1 sec. cycle.

Specifications

The following specifications apply to the physical interface, power supply and speaker.

Physical Interface

- ◆ 10/100 Base-T (RJ-45) x 1
- ◆ Handset (RJ-22) x 1
- ◆ Handset (phone jack - 2.5 mm) x 1
- ◆ DC Jack x 1

Power Supply

- ◆ DC 48V, 0.25A (Optional)
- ◆ Line Power (Power Dsign)







Speaker

- ◆ 8 Ω, 1 W

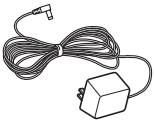
Optional & Replacement Equipment

The following equipment is available for use with your UIP300 IP Phone. The table below provides a description and Stock Number.

Table 1-2 Optional & Replacement Equipment

Description	Part Number	Equipment Diagram
AC Adapter ¹	AD300	
Cord	UIPA3035	
Handset	UIPA3030	
Headset	EXP9530	
	EXP9730	
5 Port 10/100 Ethernet	PCS500	

1. This product is intended to be supplied by a listed direct plug-in power unit marked “Class 2” or “LPS” and rated 48Vdc with minimum 0.25A output.

Chapter 2 Installation and Basic Setup Instructions

General Information

This chapter provides instructions for installing the foot stand on the IP telephone, connecting the IP telephone to the LAN and sample setup instructions for setting up the telephone.

Attaching the Footstand to the Telephone

The footstand is included with the IP telephone. The footstand can be attached to the bottom of the IP telephone, allowing the user to tilt the telephone at either low or high angle or to wall mount the telephone. The adjustments are clearly marked on the footstand with arrows indicating the direction that the footstand should be attached the bottom of the telephone for the desired height or wall mounting.

To attach the footstand to the telephone, determine the desired adjustment and align the tabs on the footstand with the tab receptacles on the bottom of the telephone by matching the arrows. Press firmly on the footstand to lock the tabs in place.

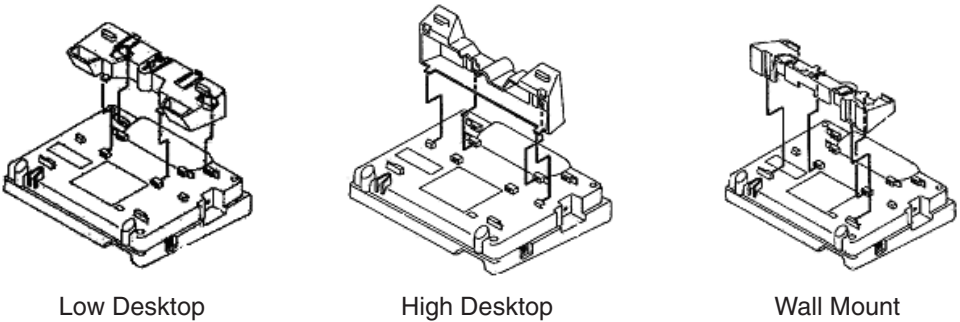

Figure 2-1 Footstand Mounting

Connecting the Telephone

Before using UIP300, it is necessary to connect the handset to the telephone and to connect the telephone to the LAN network.

1. Connect the handset to the handset port located on the left side of the telephone.

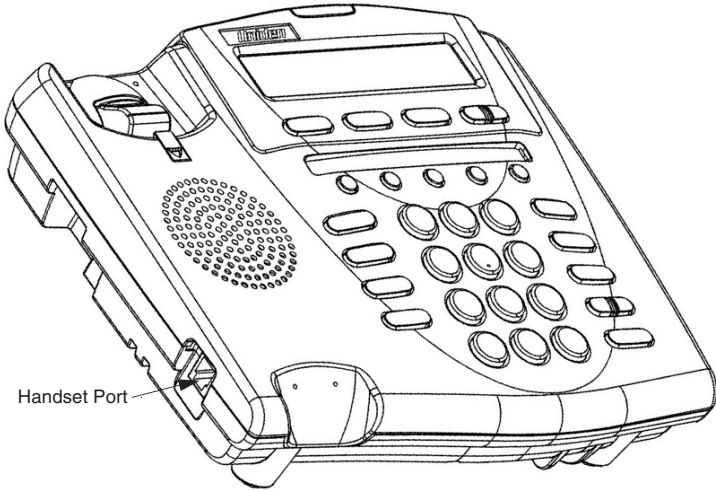

Figure 2-2 Plugging Handset Cord into Telephone

2. Connect the Ethernet cable from the LAN to the network port on UIP300. The network port is located on the back side of the telephone.

note Do not connect UIP300 to a standard telephone line.

3. If a powered hub is not being used, connect the AC adapter to the power jack and then connect the adapter to a suitable power outlet.

note The AC adapter is not included with UIP300. Refer to Chapter 1 "Product Description", "Optional & Replacement Equipment" on page 12 for the part number for the AC adapter.

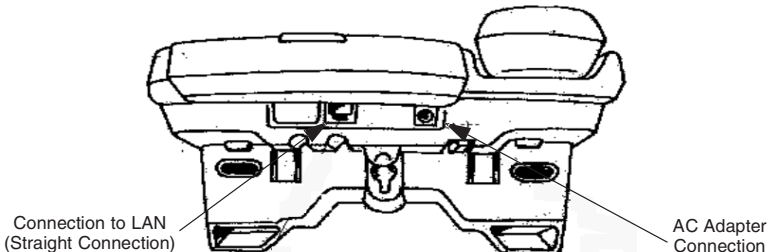



Figure 2-3 Connecting to LAN

Quick Setup Procedure

This example provides steps for configuring an IP telephone via terminal based configuration (User interface) and the web browser based configuration. Both UIP300 terminal interface and the web browser are used when modifying the information for the operation of UIP300.

This example assumes that UIP300 is connected to a Televantage® system.

 *The IP terminal must be configured, before the web browser is configured.*

Terminal Configuration using UIP300

To access the Phone Configuration Menu and set up a telephone configuration:

1. Press **Menu**.
2. Use the ▲ or ▼ keys to access the Configuration menu, then press **Select**.

```
Setup Menu:                3/4
Configuration
```

3. Use the ▲ or ▼ keys to access the Network Configuration menu, then press **Select**.

```
Configuration Menu:       2/3
Network Configuration
```

4. When prompted to enter “Password” enter the password, then press **Select**.

```
Enter Password
*****
```



The default password is **654321**. If an incorrect password is entered, the message “Incorrect Password” is displayed for one second. The Password screen is returned and the password can be entered again.

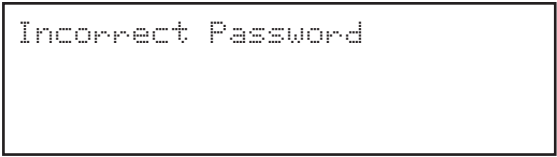

5. Once the correct password is entered, the DHCP option is displayed (default is Disabled). Press **Select** to access the Disabled screen.

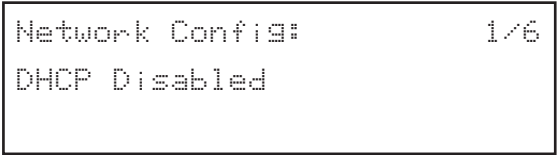

6. Press **Select** to accept the Disabled option or press **▲** to access the Enable option.

If Disabled is the desired option, press **Select**. When the “Press Select to Restart” message is displayed, press **Cancel/Del** to return to the Network Config menu.



If using a static IP address, DHCP must be set to Disabled.

If Enabled is the desired option, press **Select** to accept the option. When the “Press Select to Restart” message is displayed, press **Cancel/Del** to return to the Network Config menu, or press **Select** to restart the telephone.



If enabled is selected, the IP address, Subnet Mask address and Default Gateway address cannot be entered.



This selection is not recognized until the telephone has been reinitialized. When the telephone has been restarted, the LCD shows “Initializing...” and then “Searching DHCP Server...”. After initialization is complete, the telephone returns to the time and date display.

7. Use ▲ to access the IP Address screen on the Network Config menu.

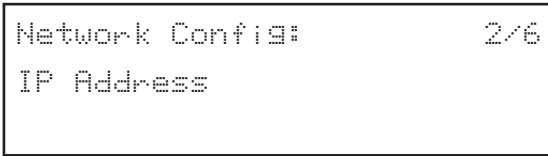

Network Config: 2/6
IP Address

8. Press **Select** to display the previous IP address.
9. Press **Select** again and enter the new IP address. The format of the IP address is: XXX.XXX.XXX.XXX

Numbers 0~255 are valid entries for the IP address.

note *The following IP addresses, 0.0.0.0 and 255.255.255.255, are not valid.*

10. After the correct IP address is entered, press **Select**.
11. When the “Press Select to Restart” message is displayed, press **Cancel/Del** to return to the Network Config menu.

note *The new IP address is not recognized until the telephone has been restarted. When the telephone has been restarted, the LCD shows “Initializing...”. After initialization is complete, the telephone returns to the time and date display.*

12. Use the ▲ to access the Subnet Mask screen on the Network Config Menu.

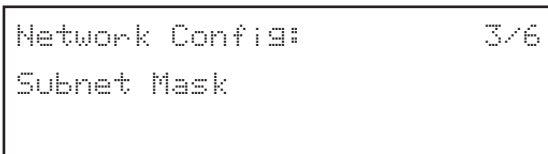

Network Config: 3/6
Subnet Mask

13. Press **Select** to display the previous Subnet Mask address.
14. Press **Select** again and enter the new Subnet Mask. The format of the Subnet Mask is:
XXX.XXX.XXX.XXX

Numbers 0~255 are valid entries for the Subnet Mask.

15. After the correct Subnet Mask is entered, press **Select**.

16. When the “Press Select to Restart” message is displayed, press **Cancel/Del** to return to the Network Config menu.

note *The new Subnet Mask address is not recognized until the telephone has been restarted. When the telephone has been restarted, the LCD shows “Initializing...”. After initialization is complete, the telephone returns to the time and date display.*

17. Press **▲** to access the Default Gateway screen.

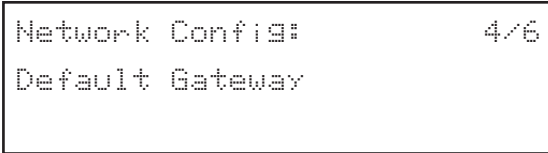

The screenshot shows a monochrome LCD display with a black border. The text on the screen is as follows:
Network Config: 4/6
Default Gateway

18. Press **Select** to display the previous Gateway IP address.

19. Press **Select** again and enter the Gateway IP address. The format of the Gateway IP address is:
XXX.XXX.XXX.XXX

Numbers 0~255 are valid entries for the Gateway IP Address.

20. After the correct Gateway IP address is entered, press **Select** to restart.

note *When the telephone has been restarted, the LCD shows “Initializing...”. After initialization is complete, the telephone returns to the time and date display. Once reinitialization has been completed, the changes that were made are now in affect.*

Web Browser Configuration

To access the web-based setup and configuration program:

1. Start the web browser from a PC that is connected to the same IP network as UIP300.
2. Check the IP address on the telephone and enter that IP address in the web browser eg., <http://169.254.1.10>. When the Enter Network Password screen appears, enter the **User Name** and Password. Click **OK**.



- At default the User Name is **admin**.
- The password is 6~10 digits. At default the Password is **654321**.

Enter Network Password

Please type your user name and password.

Site: 67.96.53.89

Realm /

User Name

Password

Save this password in your password list

OK Cancel

Figure 2-4 Web Login Screen

3. Access the Network Configuration screen and enter:

- **Phone IP Address: XXX.XXX.XXX.XXX**
- **Subnet Mask Address: XXX.XXX.XXX.XXX**
- **Default Gateway Address: XXX.XXX.XXX.XXX**

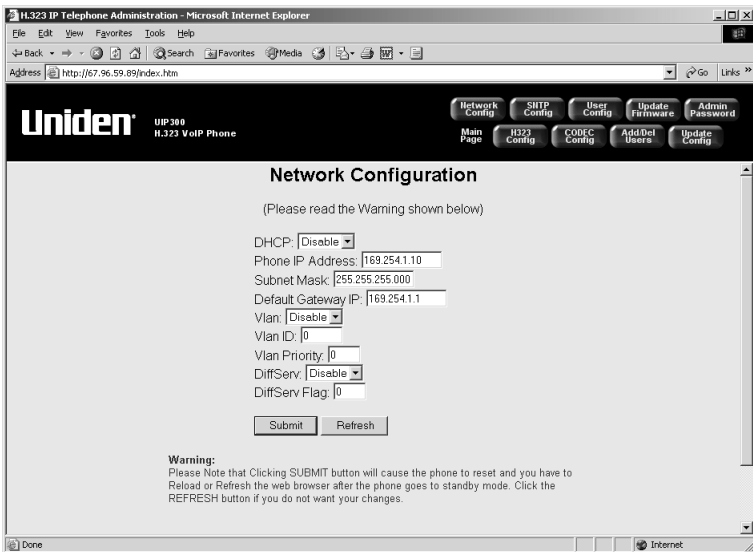

Figure 2-5 Network Configuration

4. Click **Submit**.

note *The phone will restart after clicking on **Submit** and the new settings are stored.*

5. Access the H.323 Configuration screen and enter:

- **VOIP Proxy IP:** XXX.XXX.XXX.XXX
- **Connection Str:** *Extension*Password*
The login string for a user with user extension 101 and password 101 would be *101*101*.
- **Extension (E164):** Terminal Extension No.

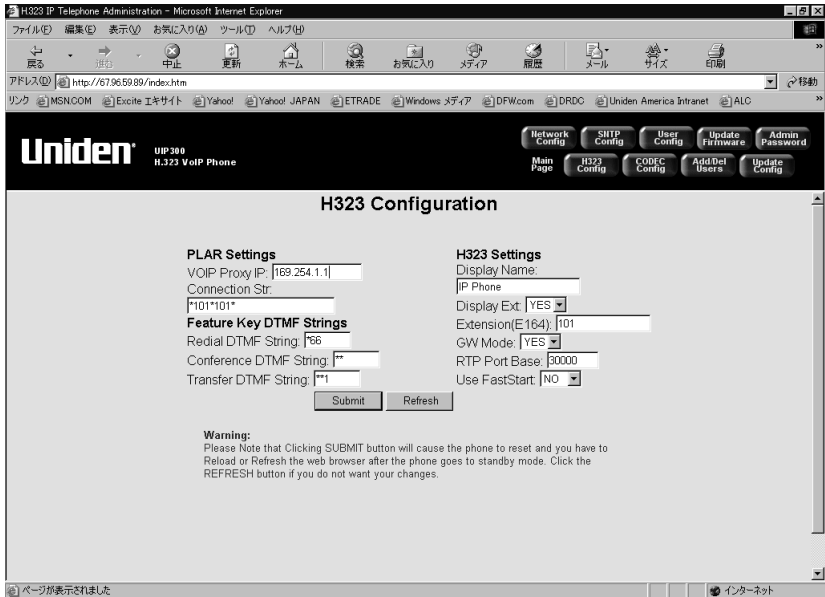

Figure 2-6 H.323 Configuration

6. Click **Submit**.

note *The phone will restart after clicking on **Submit** and the new settings are stored.*

7. Access the Codec Configuration screen and change **Preferred Codec** (The default preferred code is G.711_Mu).

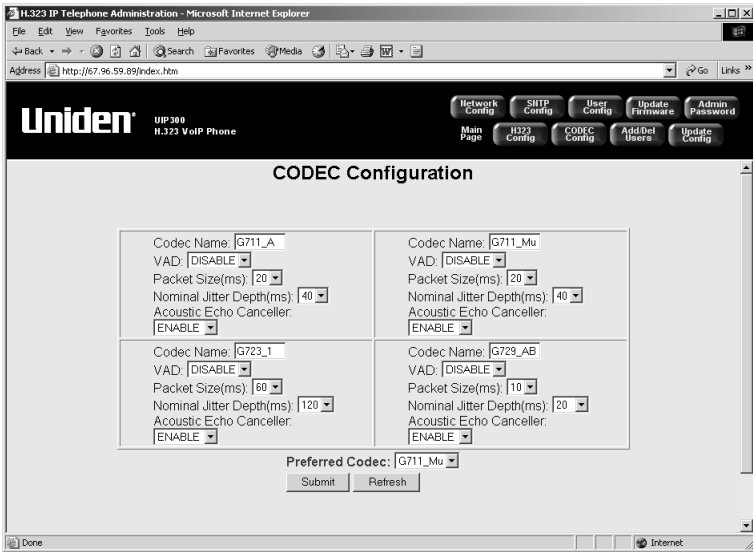

Figure 2-7 Codec Configuration

8. Click **Submit**. The UIP300 is now ready for operation.

note *The phone will restart after clicking on **Submit** and the new settings are stored.*

Chapter 3 Basic Operations

General Information

There are several basic operations that the UIP300 performs. These include:

- Standby
- Originating a Call
- Receiving a Call
- 2-line Operation
- Setting the Volume

Telephone Operations

Standby

When the telephone is powered on, “Initializing...\” is shown while the telephone is starting up. The last character on the LCD rotates, indicating that the software is still running.

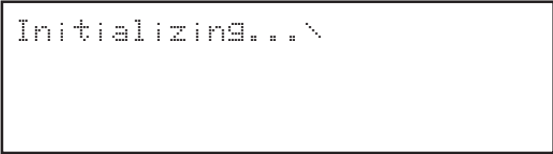

```
Initializing...\
```

Before the telephone switches to standby mode, the firmware version is shown on the LCD for five seconds (below is an example for the firmware version 1.00).

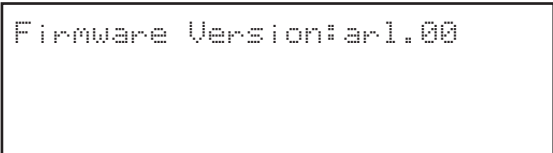

```
Firmware Version: ar1.00
```

The current date and time is displayed in the LCD, while the telephone is on-hook and in standby mode.



The telephone extension (E.164) number (if available) is also displayed in the LCD while the telephone is on-hook and in standby mode.



Originating Calls

Users can make calls using a handset or the handsfree feature. (Refer to “Handsfree” on page 28 for a detailed discussion of handsfree operation.)

Using the Handset

To originate a call using the handset:

1. Pick up the handset (the telephone is off-hook).
2. Dial the telephone number (or extension number), or the IP address of the called party.

Using the Phone Book

To originate a call using the phone book:

1. Press ▼ to access the phone book. (Refer to “Phone Book” on page 28 for instructions for adding, editing, or deleting Phone Book entries.)
2. Once the phone book is displayed, use either the ▲ or ▼ to navigate through the entries.
3. Once the desired entry is displayed in the LCD, press **Select** to initiate the call.



*To cancel out of the phone book, press **Cancel/Del**.*

Using On-Hook Dialing

Users can enter telephone numbers before going off-hook (while the telephone is in standby mode).

To dial the number:

1. Enter the destination number.
2. Go off-hook with the handset or speakerphone.
3. The outgoing call is initiated.

Receiving Calls

When there is an incoming call, the Message Waiting Indication and the line LED flash. Users can answer the call using the handset or handsfree (using the speakerphone).

Answering Calls Using the Handset

To answer an incoming call:

1. Pick up the handset.
2. Begin the conversation.

Answering Calls Handsfree

To answering an incoming call:

1. Press the **Speaker/Headset** key or press the line key (the handset remains in the cradle).
2. Begin the conversation.

2-Line Operation

UIP300 supports 2-line operations.

Accessing Line 1

UIP300 uses Line 1 if the user picks up the handset or presses the **Speaker/Headset** key.

Accessing a Line Using the Line Key

Press Line 1 or Line 2 to access the appropriate line. When the line key is pressed, the LED on the line key turns on indicating the selected line is in use. If the handset is used, the user hears a dial tone through the handset. If the handset is in the cradle and the telephone was originally on-hook, pressing the line key causes the telephone to go off-hook and turns on the handsfree feature. The user hears dial tone through the telephone speaker.

Volume Control

There are four volume settings:

- ◆ Handset
- ◆ Headset
- ◆ Speakerphone
- ◆ Ringer Volume



There are five volume levels for each volume.

Handset Volume Control

To change the volume on the handset:

With the handset off-hook, press ▲ (increase) or ▼ (decrease) to adjust the volume. The volume of the handset changes as the keys are pressed.

If no activity is detected for one second, the volume setting screen disappears and returns the LCD to the original display and the volume setting is saved.

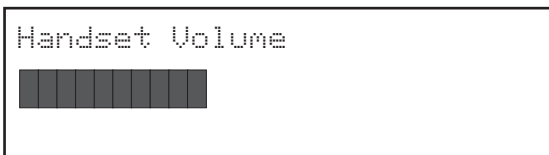

Speakerphone Volume Control

When using speakerphone, the speakerphone volume is adjusted in the same way that the handset volume is adjusted. Refer to “Handset Volume Control” on this page.

Note that the speakerphone can only be adjusted if the headset is not plugged in.

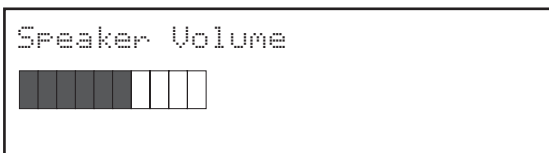

Headset Volume Control

The headset volume is adjusted in the same way that the speakerphone volume is adjusted. Refer to “Handset Volume Control” on page 26.

Note that the headset volume can only be adjusted if the headset is plugged in.

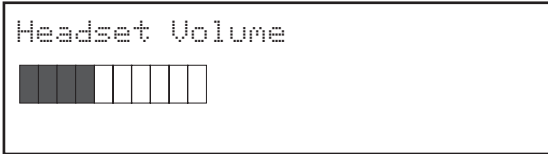

Ringer Volume Control

To change the ringer volume:

With the telephone on-hook, press ▲ (increase) or ▼ (decrease) to adjust the volume. The volume of the ringer changes as the keys are pressed.

If no activity is detected for one second, the volume setting screen disappears and returns the LCD to the original display and the volume setting is saved.

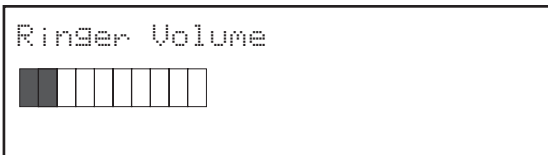

Feature Operations

The operation for the basic features of the UIP300 IP Phone are described in this section.

Handsfree

This feature allows the user to make a call or receive a call without using the handset. This feature is provided when using the speakerphone or the headset.

Speakerphone

When the **Speaker/Headset** key or one of the line keys is pressed (and the headset is not plugged in), the user can listen from the built-in speaker and can speak through the built-in microphone. If the handset goes off-hook while the speakerphone is in use, the speakerphone is turned off and the handset becomes active. If the handset is active and the speakerphone goes off-hook (by pressing the **Speaker/Headset**) key, the handset becomes idle and the speakerphone becomes active.

Headset

When the **Speaker/Headset** is pressed and the telephone detects that the headset is plugged in, the voice path of the speakerphone and the microphone (used by the speakerphone) is disabled and the speaker and microphone inside the headset is activated.

Receiving a Call Using Handsfree

When the telephone rings, the user can press the **Speaker/Headset** key or the line key with the flashing LED without picking up the handset. The **Speaker/Headset** LED goes on and the LCD screen is the same as if the user answered the call using the handset.

To disconnect the call, press the **Speaker/Headset** key. Pressing the line key does not disconnect the call.

If the handset is picked up, the Handsfree feature is disabled and the telephone returns to normal operation allowing conversation through the handset.

Phone Book

The Phone Book feature allows users to store up to 50 telephone records. Each records contains the following data fields:

- ◆ Name – alphanumeric identification of a party (stored phone book entry)
- ◆ Number – telephone number or extension of the party (stored phone book entry)

The Phone Book can be accessed in two ways:

- ◆ Press the ▼ navigation key to access the quick Phone Book (dial only).
- ◆ Press the **Menu** key to go to the Setup Main menu. Select the phone book that appears as the second item inside the menu.

Records inside the phone book can be searched (by name), dialed, edited or deleted. Refer to “Phone Book Submenu” on page 34.

Programmable and Fixed Function Keys

There are five programmable and fixed functions keys in the UIP300 IP Phone. Programmable function keys can be assigned to one of the three available functions: Speed Dial, Do Not Disturb (DND), or Voice Mail.

Speed Dial

Users can make calls by pressing a key that has been previously programmed for speed dialing. Users can press a speed dial key after going off-hook with the handset or with the speakerphone. If the user presses a speed dial key while on-hook, the telephone immediately goes off-hook with the speakerphone and starts dialing the number.

Do Not Disturb (DND)

Do Not Disturb allows users to ignore all incoming calls. The calling party hears a busy tone or an announcement when DND is activated.

To use DND, a function key must be assigned. Refer to “Function Key” on page 42 for instructions for assigning DND to a function key.

To activate DND:

Press the **Function** key assigned for DND.

The DND key LED remains lit while the feature is activated.

To deactivate DND:

Press the **Function** key assigned for DND.

The DND key LED goes off.



*The **DND** key can only be activated and de-activated while the phone is on book and in the standby screen.*

Voice Mail

UIP300 supports voice mail service. In order to access this feature, the user's IP terminal must be connected to the existing voice mail system. When a new message arrives, the Message Waiting Indication turns on to notify the user that a new voice mail message is waiting.

To access voice mail:

Press the **Function** key assigned for voice mail or dial the voice mail number manually. Refer to "Function Key" on page 42 for instructions for assigning a function key to access voice mail.

The user is connected to the voice mail system and prompted by instructions to access their mail box. The Message Waiting Indication remains lit solid until UIP300 receives "No Message" indication from the voice mail system.

Redial

Redial records are retained in the gateway system and will be invoked by sending a pre-assigned DTMF String to the system when the **Redial** key is pressed.

Mute

Mute can be used during a conversation.

To activate mute:

Press the **Mute** key.

The user's voice is muted, however, the user can still hear the other parties participating in the call. The Mute LED goes on to remind the user that their voice is being muted.

To deactivate mute:

Press the **Mute** key.

Mute is disabled, the Mute LED goes off and the user's voice can now be heard.

Hold

To place a call on hold during a conversation:

Press the **Hold** key.

The LED of the line that is put on hold blinks continuously.

To resume the call:

Press the line key for the party on hold.

The Hold indication message disappears and the line LED changes from blinking to a solid-on indication.



Music on Hold is sent to the holding party from the gateway. If the holding party disconnects, the telephone stops Music on Hold and the telephone LCD shows "Call Disconnected".

Transfer

UIP300 allows users to perform a transfer while the user is engaged in a conversation.

To transfer a call when the calling party is on Line 1:

Blind Transfer

1. Press **Transfer** key. This places the second party on hold.
2. Dial the phone number of the party where the call is to be transferred.
3. Upon hearing the line ringing, hang up to complete the transfer.

Supervised Transfer

1. Press **Transfer** key. This places the second party on hold.
2. Dial the phone number of the party where the call is to be transferred.
3. a. If the third party accepts the call, hang up to complete the transfer.
b. If the third party rejects the call and hangs up, follow the voice guidance menu and press **4** to return to the initial caller.

Conference

The feature allows three parties to be a part of the same conversation.

To make a conference call, at least one line must be available.

1. Press **Conference** key. This puts remote party on hold by the system.
2. Enter “#” followed by the destination party’s telephone number.
3. When connected to the third party, press **Conference** key and then **5** to start the conference call.

Call Waiting

This feature allows a user to answer an incoming call while one of the two lines is being used. When there is an incoming call and one of the two lines is in use, the user hears a call waiting tone and the LED on the available line blinks continuously. A call waiting tone and flashing LED continues until the call is answered or the incoming call is terminated.

To answer the incoming call:

1. Press the **Hold** key to put the current party on hold.
2. Press the line key where the new incoming call is ringing.

note

If the user presses the line key without first putting the current party on hold, the current call is automatically dropped.

Chapter 4 Setup Menu

General Information

This chapter describes how to setup and configure UIP300.

The main setup and configuration menu is the Setup Menu. This menu consists of three submenus and displays information about UIP300:

- Call Log Menu – This submenu is used to set operations relating to incoming and missed call log information.
- Phone Book Menu – This submenu is used for setting up any operations relating to memory dial records.
- Configuration Menu – This submenu includes two types of configurations and allows users to restore the factory default settings:
 - Telephone Configuration
 - Network Configuration
 - Restore Factory Settings
- View Information – Displays the telephone IP address and firmware version.

Basic Setup Menu Options

This menu provides access to the three submenus: Call Log, Phone Book and Configuration.

To access the Setup Menu:

1. Press **Menu**.



*When **Menu** is first pressed, the Setup Menu and Call Logs submenu are displayed.*

2. To navigate the submenu options, press the ▲ and ▼ keys. When the desired submenu option is accessed, press the **Select** key to display the selected submenu.

Call Log Submenu

There are two types of call logs – Incoming and Missed call logs – inside the Call Log Menu. Besides the two types of call logs, the Call Log Menu also includes the Delete Logs function as the third item. This function is used to delete all call log records inside any chosen call log group. When a record is chosen, user can apply one of the two functions– Delete and Date/Time – to the chosen record.

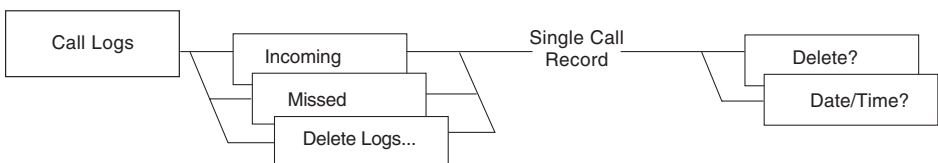

Figure 4-1 Call Log Menu Structure

Every call record in any call log group, contains 3 common data fields regardless of its call log type:

1. Caller's Name
2. Call Date
3. Call Time

Choose a Call Log Record

A call log record from any call log group can be chosen as follows:

1. Choose Call Logs from the Setup Menu and press the **Select** key.

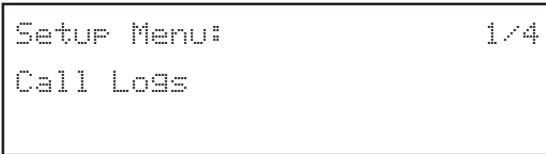

2. Use ▼ or ▲ to move to the Incoming or Missed call log items and press the **Select** key.
3. User presses ▼ or ▲ navigation keys to find the record of interest and press the **Select** key. On next screen, choose one of the two possible actions – Delete, and Date/Time.



Each call log record has a number shown at the top right corner to show the receiving order. "1" is the latest record. The larger the number, the older the record it is.

Delete a Single Call Log Record

If user continues from the end of the section Choose a Call Log Record, press the **Select** key.

1. Press the ▲ navigation key to change the action to the Delete action.

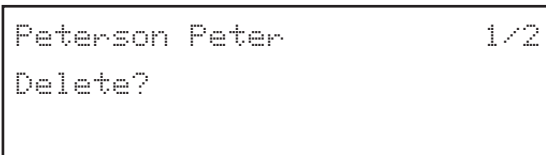

2. Press the **Select** key. The delete confirmation message will be displayed on the LCD screen. Choose either to delete the current selected call log record, or to cancel the delete action.

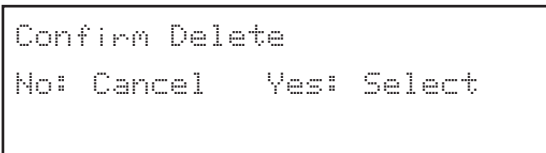

3a.If user presses the **Select** key, the phone will delete the chosen record. Then, the delete successful message will be displayed for 1 second.

```
Record Deleted
```

3b.If **Cancel/Del** key is pressed, the delete action will be cancelled, and the display will return to Step 1.

Retrieve Date/Time information of a Call Log Record

Date/Time is the last action inside the call log operation menu. This menu will display the name (if available), date and time of the call of a call log record.

If user continues from the end of the section Choose a Call Log Record, press the **Select** key.

1. Press the ▲ navigation key to change the action to the Date/Time action.

```
Peterson Peter                2/2  
Date/Time?
```

2. Press the **Select** key. The following info will be displayed:

- ◆ 1st line: Name
- ◆ 2nd line: The date and time of the call log

```
Peterson Peter  
12:52PM 08/25/02
```

Delete All Records in Any Call Log Group

Besides two call log groups, the Call Log Menu also contains the Delete Logs feature. It allows users to delete all records inside any particular (or all) call log group(s).

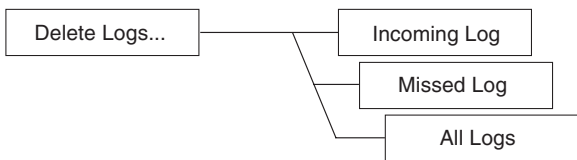

1. From the Call Log Menu, choose the Delete Logs items and press **Select**.



The next screen will consist of three choices of delete preferences –Incoming Log, Missed Log and All Logs.

2. Presses ▼ or ▲ navigation keys to find the selection of your choice, and press **Select**.
3. After pressing the **Select** key, the log delete confirmation screen will prompt user. If **Select** is pressed, go to Step 4. If **Cancel/Del** is pressed, the display will return to the previous menu with the same log type in Step 2.

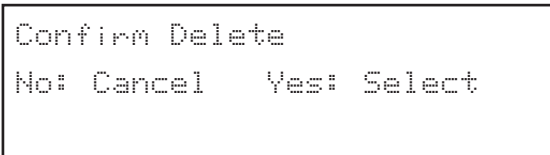

4. The phone will delete all records inside the chosen call log group. One of the log delete successful messages below depending on the log type will be displayed for 1 second.

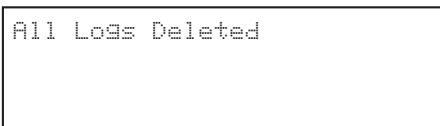
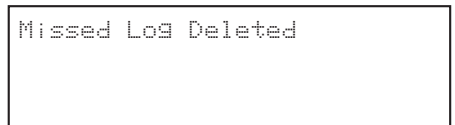
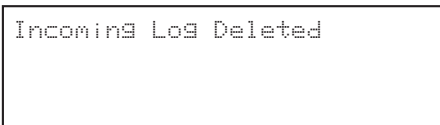

Phone Book Submenu

The “phone book” feature allows users to store up to 50 telephone records. The Phone Book function appears as one of the submenus in the Setup Menu. The Phone Book submenu provides four functions relating to the phone book records. Refer to Figure 4-2 “Actions Applicable to Phone Book Records”.

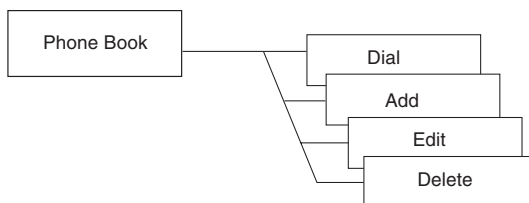
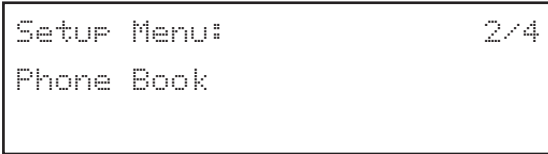

Figure 4-2 Actions Applicable to Phone Book Records

To access the Phone Book menu, use the ▲ or ▼ arrows to choose Phone Book from the Setup Menu.



Setup Menu: 2/4
Phone Book

If the ▼ is pressed while the telephone is in standby mode and the date and number are displayed in the LCD, the first Phone Book entry is shown.

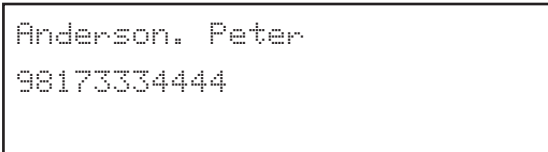

Anderson, Peter
98173334444



This quick access operation applies to dialing only. If the user has already entered a character on the LCD, pressing the ▼ has no affect.

Searching Telephone Records

The “phone book” can hold up to 50 records. As a result, navigating through the telephone records can become time consuming. To avoid lengthy searches, UIP300 allows users to search the telephone records by entering a name or the first letter of a name. There are two types of searches: name search and quick search.

Name Search

This search is typically used when the Dial or Edit features are chosen from the Phone Book menu. Edit and dial features are chosen by pressing the **Select** keys on the Phone Book menu.

To perform a name search:

1. Choose Dial or Edit from the Phone Book Menu by pressing the **Select** key. It will go to the name search screen.

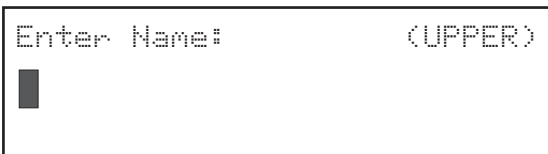

Enter Name: (UPPER)
█



If the phone book is empty, user will see the message, “Phone Book is Empty”, for one second.

2. To enter a name using the numeric keys on the keypad.
3. When finished entering the name or character(s), press the **Select** key.

After the actual search is performed, the first record that matches the input string appears on the first line of the LCD display.

```
Peterson, John
98173334444
```

note

- During the name input, user can move the cursor by using ▼ and ▲ keys.
- When there are user input characters and the cursor is moved over a particular character, a press of **Cancel/Del** key will delete the character that the cursor is highlighting. All remaining character(s), if there is/are any, on the right of the deleted character will move one space to the left.
- The search mechanism is not case-sensitive.
- If nothing is entered and the **Select** key is pressed, the first phone book record will show up. Press ▼ or ▲ key to navigate to the record of interest.
- If there is no match, the first record exceeding the searching input criteria will appear on the first line of the LCD display. For example, assume a search string of "Pete J" is entered. If inside the phone book record list, there is a name Pete K, which is stored right after another record with name Pete C. In this case, the record Pete K will be displayed since it is the first record that exceeds the searching criteria – Pete J. From the resulted record, user can navigate to different records using ▼ and ▲ keys.

Quick Search

This search is used to quickly navigate the "phone book" by pressing a digit key. This is another way to quickly perform a name search.

To perform a quick search:

1. From the on hook standby screen or from off hook screen prior to dialing digits, Press the ▼ key.
2. Press the dial digits on the keypad to retrieve the first phone book entry name with the corresponding letter. For example, user would hit the "6" key once to get the first entry beginning with the letter "M". User would hit the "6" key a second time to get the first entry beginning with the letter "N", and so forth.

note

- Press ▼ or ▲ key to navigate to the record of interest.
- The search mechanism is not case-sensitive.

Add a Phone Book Record

The phone book feature allows user to store up to 50 phone book records. Each phone book record contains 2 data fields – Name and Number.

1. From the Phone Book Menu, choose the Add item using the ▼ and ▲ navigation keys and press the **Select** key.

```
Phone Book Menu:      2/4
Add
```

If the Phone Book is full when user tries to add a new record, “Phone Book is Full” message will be displayed on the screen. Then, it will return to the Phone Book Menu with the Dial item on the display.

Phone Book is Full

Otherwise the normal record adding procedure should be shown as follows.

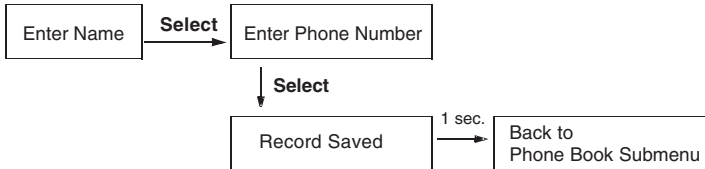

Figure 4-3 Normal Phone Book Record Data Input Sequence

2. After user chooses Add from the Phone Book Menu, the name input screen is displayed. User can enter a name for the record. Press the **Select** key when input is done.

Enter Name: (lower)
 Barbara Anderson █



- A name can be 24 alphanumeric characters.
- To switch from upper and lower case, press the # key.
- Press the corresponding number on the dial pad to enter the letters. For example, number 2 on the dial pad is used to enter A, B and C. Press the 2 key once for the letter A, twice for B and three times for C. Use the other keys on the dial pad the same way.
- To enter a space, press 0.
- The asterisk key can be pressed eight times to enter one of the following characters:
 - 1 time = .
 - 2 times = @
 - 3 times = *
 - 4 times = #
 - 5 times = -
 - 6 times = &
 - 7 times = (
 - 8 times =)

3. Enter the phone number.

```
Enter Phone Number:
98171234567█
```



- Whenever the **Cancel/Del** is pressed, the last digit will be deleted.
- Whenever the **REDIAL** is pressed, the character “,” will be inserted. The “,” character represents a 2 second pause is to be performed between the previous digit and the next digit, when the entry is dialed.
- The phone number field contains a phone number (or an extension) up to 24 digits.

4. When phone number is entered, press the **Select** key.

The save confirmation screen will be displayed for 1 second. Then, it will return to the Phone Book Menu with the Add item menu.

If the name of the entry already exists in the Phone Book, the following message will be shown and ask user to replace the existing entry. If user selects “Yes”, the old entry will be deleted and the new entry will be saved. If user selects “No”, it will return to the Step 2 to allow user to change the name.

```
Name Exists      Replace?
No: Cancel      Yes: Select
```



If the item could not be saved, the following message will be shown on the LCD for 1 second and then return to the Phone Book Menu with the Add item. If name or number or both is not entered, this message will also appear.

```
Could not save
```

Edit a Phone Book Record

1. From the Phone Book Menu, choose the Edit item using the ▼ and ▲ navigation keys and press the **Select** key.

```
Phone Book Menu:      3/4
Edit
```

note

If the phone book is empty, you will see the message, "Phone Book is Empty", for one second.

2. User will enter the Name Search mode, search for the phonebook entry user wishes to edit and press the **Select** key. (Refer to the "Name Search" section for directions on using Name Search mode.)
3. This brings user to the name editing field. At this point, user can follow steps 2 through 4 of adding a new phone book record to complete your task.

Delete Phone Book Records

1. From the Phone Book Menu, choose the Delete item using the ▼ and ▲ navigation keys and press the **Select** key.

```
Phone Book Menu:      4/4
Delete
```

note

If the phone book is empty, user will see the message, "Phone Book is Empty", for one second.

After choosing Delete from the Phone Book Menu and pressing the **Select** key, user is given two choices to delete – Delete One by One, and Delete All.

2. Use ▼ and ▲ navigation keys to select between erasing a single record or all records. The currently selected choice, either "Delete One by One" or "Delete All" will blink continuously. Press the **Select** key.

```
Delete One by One
Delete All
```

Delete A Single Record

- 3a. If Delete One by One is chosen, it will bring the user to the first record in the phone book. User may get to a desired record quickly by performing a Quick Search and/or using the ▼ and ▲ keys to navigate to the desired record. (Refer to the Quick Search section to learn more about using the Quick Search feature.)
- 4a. After the desired record is located, press the **Select** key and it brings user to the delete confirmation screen.

```
Confirm Delete All
No: Cancel   Yes: Select
```

- 5a. Press the **Select** key to proceed or **Cancel/Del** to return to the phone record list.

```
Record Deleted
```

If the **Select** key is pressed the display will be shown for 1 second. Then, the display will return to the next record on the list. If **Cancel/Del** key is pressed, the delete will be aborted, and the display will return to the phone book record list.

Delete All Records

- 3b. If Delete All Records is chosen from the menu, the Delete All confirmation message will be displayed.

```
Confirm Delete All
No: Cancel   Yes: Select
```

- 4b. If user presses the **Select** key, all phone book records will be deleted. "All Records Deleted" will be shown on the LCD as below for 1 second then followed by "Phone Book is Empty" for another second. Finally, the display will return to the Phone Book Menu. If **Cancel/Del** key is pressed, the delete will be aborted, and the display will return to the two delete choices – Delete One by One, and Delete All.

```
All Records Deleted
```

Telephone Configuration

Telephone configuration includes configurations related to the characteristics of features of a normal telephone call. These characteristics and features include:

- ◆ Call Duration
- ◆ Local Date/Time
- ◆ Ringer Tone
- ◆ LCD Contrast
- ◆ Function Key

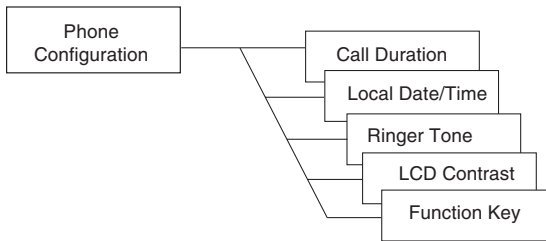

Figure 4-4 Phone Configuration Menu



- When making entries in this menu, the **Cancel/Del** key operates in the following manner:
When there is/are one or more character(s), the **Cancel/Del** key operates as a delete key.
When there are no characters, the **Cancel/Del** operates as a back key. It takes you one level back to the previous screen.
- During editing when there are more than one character, use the ▲ and ▼ keys to move left and right.

To access the Phone Configuration Menu and set up a telephone configuration:

1. Press **Menu**.
2. When the Setup Menu screen is displayed, the Call Logs submenu is the first selection that is displayed. Use the ▲ key to highlight the Configuration submenu.

```
Setup Menu:           1/4
Call Logs
```

```
Setup Menu:           3/4
Configuration
```

3. Press **Select**. The Configuration Menu is displayed, showing the first entry of the Configuration Menu, which is Phone Configuration.

```
Configuration Menu:   1/3
Phone Configuration
```

4. Press the **Select** key to enter the Phone Configuration menu. This allows access to the Phone Configuration functions.

Call Duration

1. Call Duration is the first option from the Phone Configuration menu, press **Select** to proceed with modifying it. Call Duration is displayed on the LCD with the current setting. To change the setting, use the ▲ or ▼ keys, then press **Select**.

```
Phone Configuration:  1/5
Call Duration
```

```
Call Duration:        1/2
On
```

```
Call Duration:        1/2
OFF
```

Local Date/Time

This selection allows the user to set the local date and time.

To access the Local Date/Time option and set date and time:

1. From the Phone Configuration menu use the ▲ or ▼ keys to access the Local Date / Time option, then press **Select**.

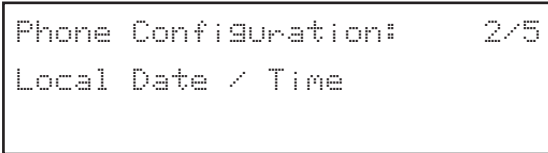

2. When “Enter Year” is displayed, enter the year (YYYY format), eg., 2002, then press **Select**.
3. When “Enter Month” is displayed, enter the month (1~12), then press **Select**.
4. When “Enter Day” is displayed, enter the day (1~31), then press **Select**.
5. When “Enter Hour” is displayed, enter the hour (0~23), then press **Select**.
6. When “Enter Minute” is displayed, enter the minutes (0~59), then press **Select**. The display returns to the Local Date/Time option.

note

- A data validation check is performed for each data field. If the date is not valid, a warning message is displayed for one second.
- Date and time information is obtained from a local SNTP server. However, if a local SNTP server is not available, then the date and time is obtained from a public SNTP server. If the user configures the local date and time, that information is maintained until the next time an SNTP server is polled.
- When time is maintained locally, the telephone checks every 10 minutes for the activation of an SNTP server and updates the local time if it is available.
- When the SNTP server is recovered and accessed, it automatically overwrites all previous manual local date and time settings and updates the information from the SNTP server.
- If an SNTP server is not available or it is disabled, the local time starts from 01/01/02 when the system is powered on.

Ringer Tone

There are eight types of ringer tones available.

To access the Ringer Tone option and set the desired tone:

1. From the Phone Configuration menu use the ▲ or ▼ keys to access the Ringer Tone option, then press **Select**.

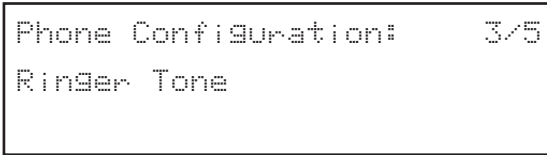

2. The current ring tone is displayed. Use the ▲ and ▼ keys to access the desired ring tone. As you scroll through the selections, the ring tone can be heard for three seconds. When the desired ring tone is displayed, press **Select**.

LCD Contrast

There are 10 levels of adjustment for the display contrast.

To access the LCD Contrast option and set the desired contrast level:

1. From the Phone Configuration menu use the ▲ or ▼ keys to access the LCD Contrast option, then press **Select**.

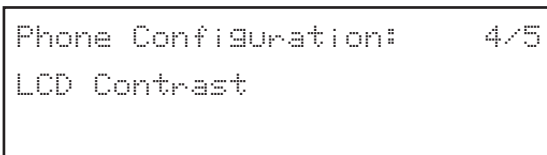

2. Adjust the contrast level by pressing the ▲ or ▼ keys. As the keys are pressed, the contrast level changes. When the desired level is displayed, press **Select**.

Function Key

Five function keys are available. Each of these keys can be assigned to one of four possible features: Do Not Disturb (DND), Speed Dial, Voice Mail, and No Feature Assigned.

To access and program a function key:

1. From the Phone Configuration menu use the ▲ or ▼ keys to access the Function Key option, then press **Select**.

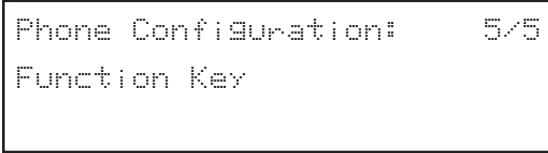

2. The telephone prompts the user to press the desired Function Key. When the Function Key is pressed, the current assignment for the key is displayed in the LCD.

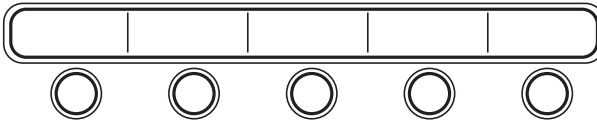

Figure 4-5 Function Keys

3. Use the ▲ or ▼ keys to scroll the different features. When the desired features is displayed, press **Select** to assign the feature to the Function Key.



Voice Mail, DND can only be assigned to one Function Key. If the user attempts to assign these features to more than one Function Key, the message "Function Already Assigned to Another Key" is displayed.

Network Configuration

Network Configuration is used to assign administrative settings. All of these settings are also available from the web-based administration and configuration.

Assignments in this menu are used to manage the network settings for the IP telephones. Users can enter the Network Configuration menu from the Configuration Menu. There are six network configurations that can be retrieved or modified.

- ◆ Enable/Disable Dynamic Host Configuration Protocol (DHCP IP Assignment for the Terminals)
- ◆ Terminal IP Address
- ◆ Terminal Subnet Mask
- ◆ Default Gateway IP Address
- ◆ Enable/Disable VLAN
- ◆ VLAN ID

To access the Network Configuration menu and assign administrative settings:

1. Press **Menu**.
2. Use the ▲ or ▼ keys to access the Configuration menu, then press **Select**.

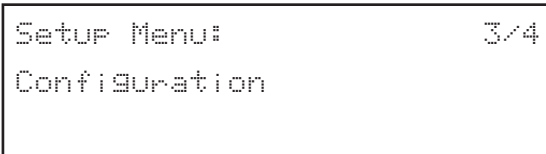

3. Use the ▲ or ▼ keys to access the Network Configuration menu, then press **Select**.

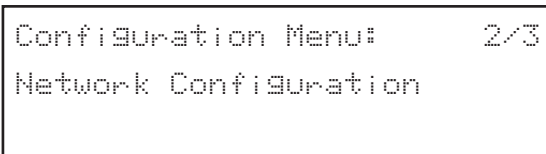

4. When prompted to enter “Password” enter the password, then press **Select**.

```
Enter Password
*****
```



*The default password is **654321**. If an incorrect password is entered, the message “Incorrect Password” is displayed for one second.*

```
Incorrect Password
```

5. Once the correct password is entered, the DHCP option is displayed with the current setting.

Enable/Disable DHCP

The first option available in the Network Configuration menu is the DHCP setting. This setting specifies whether the terminal IP address is assigned dynamically via a DHCP server or statically assigned by the administrator/user. If the DHCP IP option is enabled (turned on), the DHCP server assigns the terminal IP address and the terminal mask after the telephone is restarted. If this option is disabled, the terminal IP address is manually assigned by the administrator/user.

```
Network Config:      1/6
DHCP Enabled
```

To access this option and to enable/disable DHCP:

1. If already in Network Configuration menu, use the ▲ or ▼ keys to access DHCP option.
2. Press **Select**.
3. Use the ▲ or ▼ keys to select enable/disable, and then press **Select**.

```
DHCP                1/2
Disable
```

```
DHCP                2/2
Enable
```

note

If “Enable” is selected, the message “Press Select to Restart” is displayed. Press **Select**, to restart the telephone. The LCD shows “Initializing...\\” and then “Searching DHCP Server...”.

```
Press Select to Restart
```

note

- If “Disable” is selected, the message “Press Select to Restart” is displayed. Press **Select** to restart the telephone. The LCD shows “Initializing...\\” is displayed. The display returns to the date and time.
- If you do not want to restart the telephone, press **Cancel/Del** (to return to the previous menu) or **Menu** to exit programming and return the telephone to standby mode. If **Line 1**, **Line 2**, **Speaker/Handset**, or if the handset is picked up, the telephone goes off-hook and the restart is cancelled.
- When telephone restart is cancelled, the new network settings are not accepted until the telephone is restarted.

Terminal IP Address

This option is used to read or change the current terminal IP address value, if the DHCP assignment has been disabled. If DHCP is enabled, an IP address is assigned by the DHCP server when the telephone reinitializes.

```
Network Config:    2/6
IP Address
```

To change the IP address:

1. If already in the Network Configuration menu, use the ▲ or ▼ keys to access the IP address option.
2. Press **Select** to display the previous IP address.
3. Press **Select** again and enter the new IP address.

The format of the IP address is:

XXX.XXX.XXX.XXX

Numbers 0~255 are valid entries for the IP address.

4. After the correct IP address is entered, press **Select** and restart the telephone, or press **Del/Cancel** to cancel restart the phone and continue setting up the telephone.



- Pressing **Cancel/Del** returns to the previous menu. To exit programming and return the telephone to standby mode, press **Menu**.
- The new IP address is not recognized until the telephone has been reinitialized. Once the telephone restarts, a restart confirmation message is displayed on the LCD. "Initializing..." is displayed in the LCD while the telephone resets. If an error occurs during the initialization process, the message "Cannot Save" is displayed in the LCD for one second before returning the IP address menu.

Terminal Subnet Mask

This option is used to set/retrieve the terminal network mask. If the DHCP is enabled (turned on), the terminal mask is obtained from the DHCP server when the telephone initializes. If the user sets the network mask, it is overwritten by the value obtained from the DHCP server when the telephone is reinitialized.

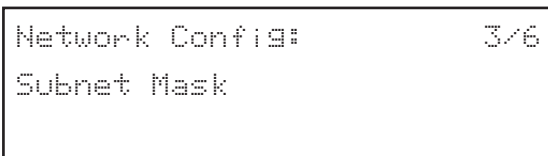

To set/retrieve the subnet mask:

1. If already in the Network Configuration menu, use the ▲ or ▼ keys to access the Subnet Mask option.
2. Press **Select** to display the previous Subnet address.

3. Press **Select** again and enter the Subnet Mask.

The format of the Subnet Mask is:

XXX.XXX.XXX.XXX

Numbers 0~255 are valid entries for the Subnet Mask.

4. After the correct Subnet Mask is entered, press **Select** and restart the telephone, or press **Del/Cancel** to cancel restart the phone and continue setting up the telephone.

note

- Pressing **Cancel/Del** returns to the previous menu. To exit programming and return the telephone to standby mode, press **Menu**. If **Line1**, **Line2**, **Speaker/Headset** are pressed or if the handset is picked up, the telephone goes off-hook and restart is cancelled. When the telephone restarts, the network settings are not used until after the telephone has been initialized.
- If the Subnet Mask is not valid, "Invalid Input" is displayed for one second before returning the display to the Subnet Mask menu.
- The new Subnet Mask address is not recognized until the telephone has been reinitialized. Once the telephone restarts, a restart confirmation message is displayed on the LCD. "Initializing..." is displayed in the LCD while the telephone resets.

Default Gateway IP Address

This option is used to read/write the default Gateway IP address.

```
Network Config:          4/6
Default Gateway
```

To read/write the Gateway IP address:

1. If already in the Network Configuration menu, use the ▲ or ▼ keys to access the Default Gateway option.

2. Press **Select** to display the previous Subnet address.

3. Press **Select** again and enter the Gateway IP address.

The format of the Gateway IP address is:

XXX.XXX.XXX.XXX

Numbers 0~255 are valid entries for the Gateway IP Address.

4. After the correct Default Gateway IP address is entered, press **Select** and restart the telephone, or press **Del/Cancel** to cancel restart the phone and continue setting up the telephone.

note

- Pressing **Cancel/Del** returns to the previous menu. To exit programming and return the telephone to standby mode, press **Menu**.

Enable/Disable VLAN

This option is used to enable or disable the VLAN.

```
Network Config:          5/6
VLAN Disabled
```

To enable/disable VLAN:

1. If already in the Network Configuration menu, use the ▲ or ▼ keys to access the VLAN option, and press **select**.
2. Use the ▲ or ▼ to change to the desired selection and press **Select**. The telephone display shows the selected VLAN setting.



- The setting that is displayed, is the previously assigned setting.
- “Press Select to Restart” is displayed. Press **Select**, to restart the telephone. The LCD shows “Initializing...” is displayed. The display returns to the date and time.

```
Press Select to Restart
```

VLAN ID

This option is used to read/write the VLAN ID.

```
Network Config:      6/6
VLAN ID
```

To read/write the VLAN ID:

1. If already in the Network Configuration menu, use the ▲ or ▼ keys to access the VLAN ID option.
2. To read the VLAN ID, press **Select**. To return to the previous screen without changing the ID press **Cancel/Del**. The screen is returned to the VLAN ID screen.

```
VLAN ID:65535
Press Select to Change
```

3. To change the ID, press **Select**. The change screen is displayed.

```
VLAN ID
65535
```

4. Press **Cancel/Del** to erase the current ID number and use the dial pad to enter the new number.
Valid VLAN ID numbers are 0~65535.
5. Press **Select**. The telephone displays the message, "Press Select to Restart".
6. Press **Select**, to restart the telephone and save the new ID. The LCD shows "Initializing...". The display returns to the date and time.

Restore Factory Settings

This option restores the default settings and configurations that were set at the factory.

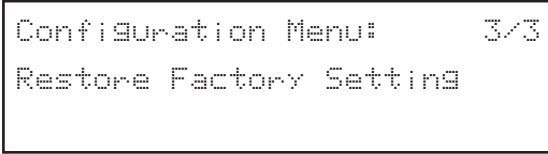

To restore the factory settings:

1. From the standby mode screen, press the **Menu** button in the standby mode. The Setup Menu is displayed.
2. Use the **▲** or **▼** keys to access the Configuration submenu.
3. Use the **▲** or **▼** keys to access the Restore Factory Setting option.
4. Press **Select**.
5. When prompted, enter the password (default: 654321) and press **Select**. The Restore Confirmation screen is displayed.

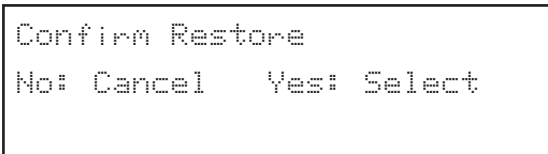

To cancel the restoration process, press **Cancel/Del**. To restore the factory settings, press **Select**. If **Select** is pressed, "Restoring..." followed by "Initializing..." is displayed in the LCD. When the local date and time are displayed on the LCD, the factory default settings have been restored.

View Info

This option allows users to view the current IP address and firmware version.

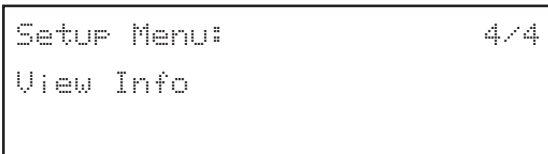

To view the information:

1. Press **Menu**.
2. Use the **▲** or **▼** keys to access the View Info submenu.
3. Press **Select**. The IP address and firmware version are displayed in the telephone LCD.

Web-Based Setup and Configuration

The web-based configuration enables a user to setup and configure UIP300 using a web browser on their PC. The web-based configuration provides additional settings not available using the telephone.

Microsoft Internet Explorer v.4.0 or higher must be used.

User Configuration

To access the web-based setup and configuration program:

1. Start the web browser from a PC that is connected to the same IP network as UIP300.
2. Check the IP address on the telephone and enter that IP address in the web browser eg., <http://169.254.1.10>.
3. When the Enter Network Password screen appears, enter the **User Name** and **Password**. Click **OK**.



- At default the User Name is **user**.
- The password is 6 ~ 10 digits. At default the Password is **123456**.

Enter Network Password [?] [X]

Please type your user name and password.

Site: 67.96.59.89

Realm: /

User Name:

Password:

Save this password in your password list

OK Cancel

Figure 4-6 Web Login Screen

4. The User Confirmation screen is displayed. This screen provides four links:

- ◆ Phone Settings (allows telephone functions to be configured)
- ◆ Function Keys (allows function keys to be configured)
- ◆ Phone Book (allows users to set up a personal telephone book)
- ◆ Password Change (allows users to change their password)

Click on any of the four links to view or edit the selection. Refer to Figure 4-7 “User Main Page”.

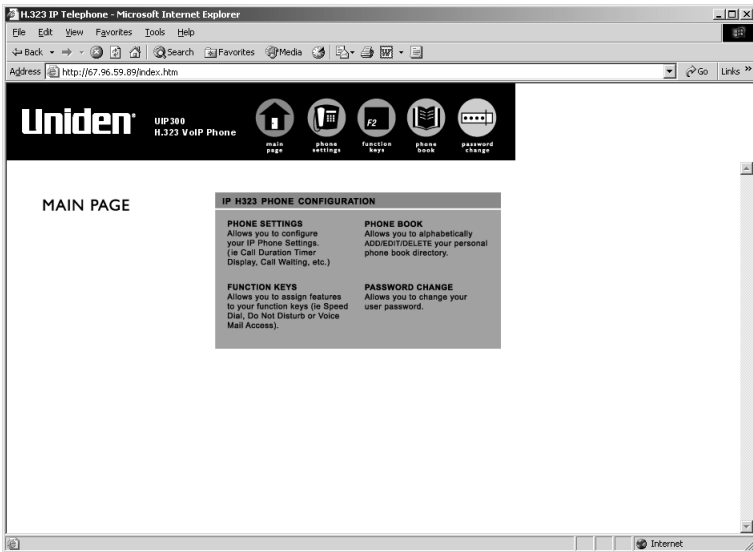

Figure 4-7 User Main Page

Phone Settings Configuration

This option allows users to configure IP telephone settings such as:

- ◆ Call Duration Timer Display (Enable/Disable)
- ◆ Call Waiting Tone (Enable/Disable)
- ◆ Ringer Tone (Tones 1~8)

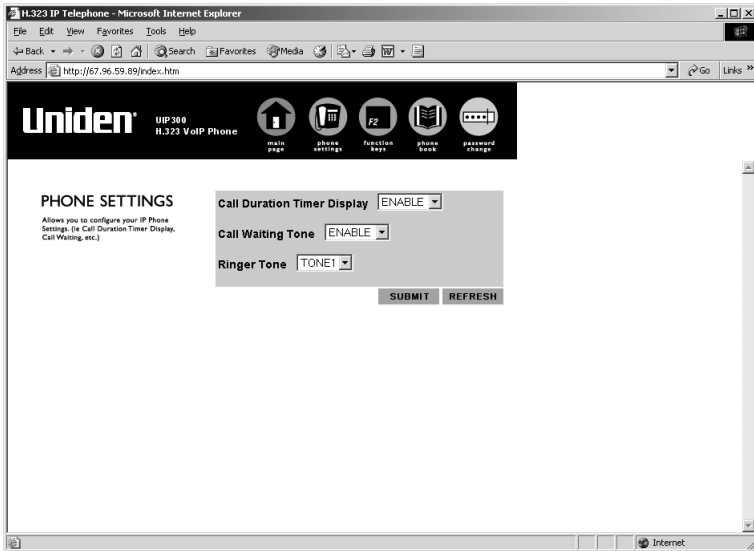

Figure 4-8 Phone Settings

On the Phone Settings screen, change the settings and then click **Submit**. The new settings are stored in the flash memory of UIP300 and the page is refreshed with the updated setting. If **Refresh** is clicked before **Submit**, the values posted in the page are reset.

Function Key Configuration

This option allows users to assign the function keys on UIP300.

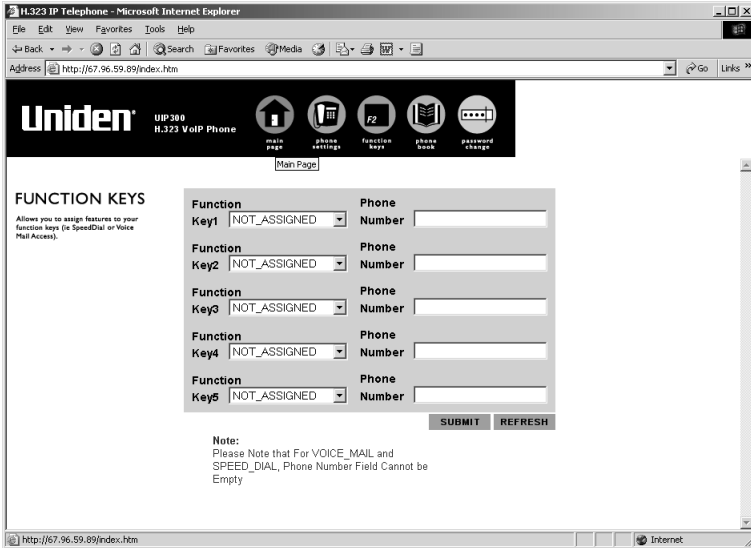

Figure 4-9 Function Key Configuration

Select the appropriate function key (Speed Dial, Voice Mail, or Do Not Disturb) and enter the associated telephone number (if necessary) and click **Submit**.

The new settings are stored in the flash memory of UIP300 and the page is refreshed with the updated settings. If **Refresh** is clicked before **Submit**, the values posted in the page are reset.

note

- *The Speed Dial key assignment is only available for a telephone number and not an IP address.*
- *If Speed Dial is selected, the speed dial number must be entered in the corresponding phone number field.*
- *If Voice Mail is selected, the telephone number of the Voice Mail server must be entered.*
- *Users cannot assign Voice Mail or DND to more than one function key.*
- *Telephone numbers should only be entered for Voice Mail and Speed Dial.*
- *Enter the “,” to insert a 2 second pause in the assigned number.*

Phone Book

This option allows users to view their telephone book and to add, delete and modify entries in their Phone Book.

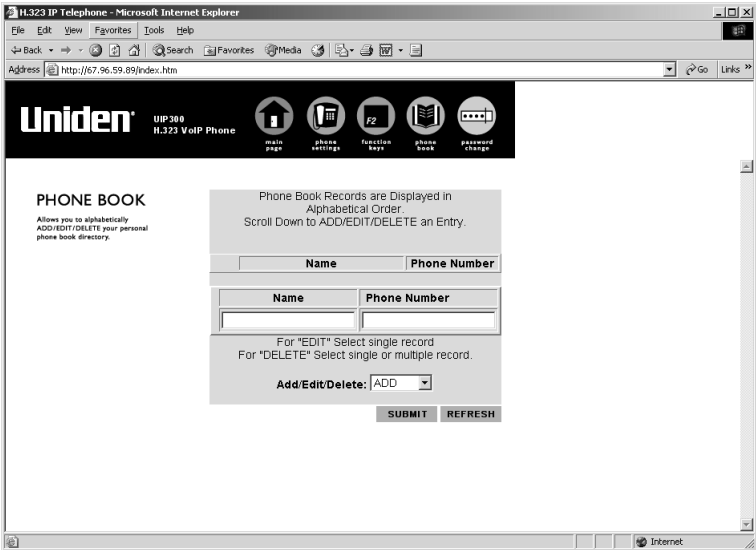

Figure 4-10 Phone Book Configuration

To add an entry to the Phone Book:

1. Enter the name and associated with the Phone Book entry, and the new number.
2. Beside the Add/Edit/Delete field, click the arrow on the pulldown menu and select **Add**.
3. Click **Submit**.

To edit an existing entry in the Phone Book:

1. Enter the **ID #** (record number) associated with the Phone Book entry.
2. Beside the Add/Edit/Delete field, click the arrow on the pulldown menu and select **Edit**.
3. Click **Submit**.



Enter the “,” to insert a 2 second pause in the assigned number to be dialed.

To delete an existing Phone Book entry:

1. Enter the **ID #** (record number) associated with the Phone Book entry.
2. Beside the Add/Edit/Delete field, click the arrow on the pulldown menu and select **Delete**.

To delete all Phone Book entries, select **DelAll** from the pulldown menu.

3. Click **Submit**.

The new settings are stored in the flash memory of UIP300 and the page is refreshed with the updated settings. If **Refresh** is clicked before **Submit**, the values posted in the page are reset.

Password Change

This option allows users to change their password.

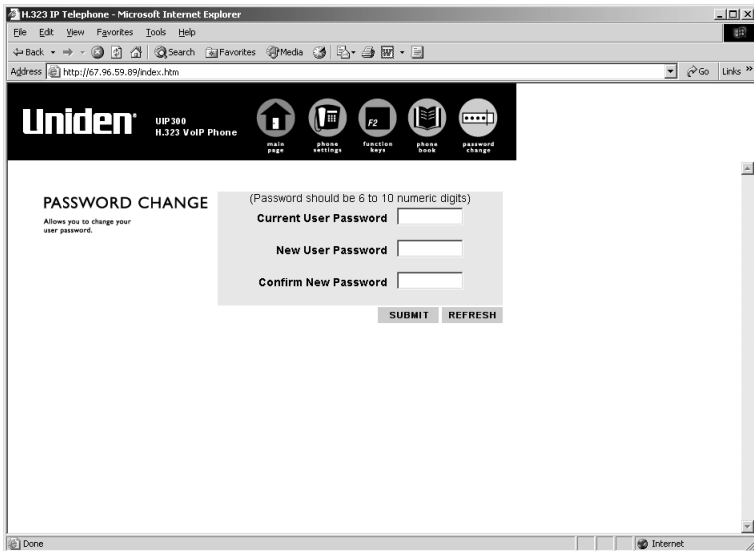

The screenshot shows a web browser window titled "H.323 IP Telephone - Microsoft Internet Explorer". The address bar shows "http://67.96.59.89/index.htm". The page header includes the Uniden logo and "UIP300 H.323 VoIP Phone". A navigation menu contains icons for "main page", "phone settings", "function keys", "phone book", and "password change". The main content area is titled "PASSWORD CHANGE" and includes the instruction "(Password should be 6 to 10 numeric digits)". Below this are three input fields: "Current User Password", "New User Password", and "Confirm New Password". At the bottom of the form are two buttons: "SUBMIT" and "REFRESH".

Figure 4-11 Password Change

To change the password:

1. Enter the old password in the **Current User Password** field.
2. Enter the new password in the **New User Password** field.

note

The password consists of 6 ~10 digits. If the password entry is not valid, an error message is displayed. To correct the password, click “Back to User Password Change” and reenter the passwords.

3. Confirm the new password in the **Confirm New Password** field.

The new settings are stored in the flash memory of UIP300 and the page is refreshed with the updated settings. If **Refresh** is clicked before **Submit**, the values posted in the page are reset.

note

If the user password change is successful, the user will be prompted to log in again using the new password.

Administrator Configuration

This menu allows Administrative users to review and modify the network and/or the protocol configuration.

1. Start the web browser from a PC that is connected to the same IP network as UIP300.
2. Check the IP address on the telephone and enter that IP address in the web browser: <http://169.254.1.10>
3. When the Enter Network Password screen appears, enter the **User Name** and **Password**. Click **OK**.

note

- At default the User Name is **admin**.
- The password is 6 ~ 10 digits. At default, the Password is **654321**.



Enter Network Password

Please type your user name and password.

Site: 67.96.59.89

Realm: /

User Name:

Password:

Save this password in your password list

OK Cancel

Figure 4-12 Web Login Screen

To access the Administrative Configuration screen and modify network and protocol configurations:

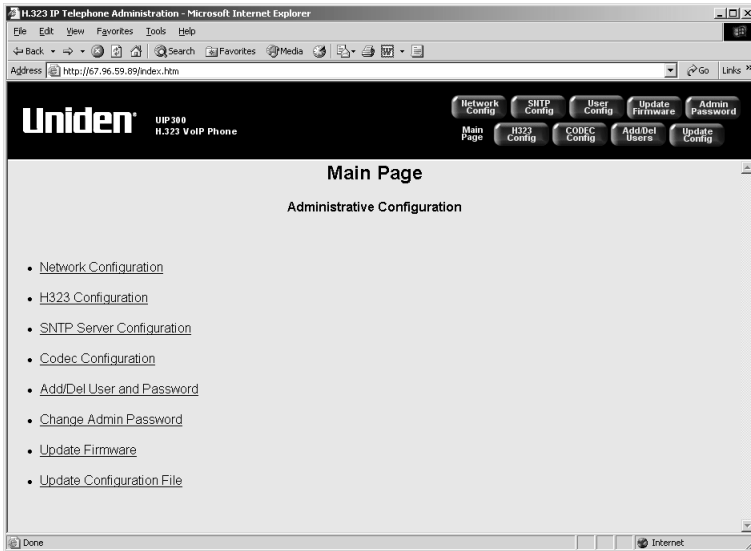

Figure 4-13 Administrative Configuration Main Page

4. The Administrator Configuration screen appears. This screen provides the following links:
 - ◆ Network Configuration
 - ◆ H.323 Configuration
 - ◆ SNTP Server Configuration
 - ◆ Codec Configuration
 - ◆ Add/Del User and Password
 - ◆ Change Admin Password
 - ◆ Update Firmware
 - ◆ Upload Configuration File
5. Click on any of the links to view or edit the related configuration.

Network Configuration

This option allows users to modify the following network related items:

- ◆ DHCP (Enable/Disable)
- ◆ Phone IP Address
- ◆ Subnet Mask
- ◆ Default Gateway IP Address
- ◆ VLAN (Enable/Disable)
- ◆ VLAN ID
- ◆ VLAN Priority
- ◆ DiffServ (Enable/Disable)
- ◆ DiffServ Flag

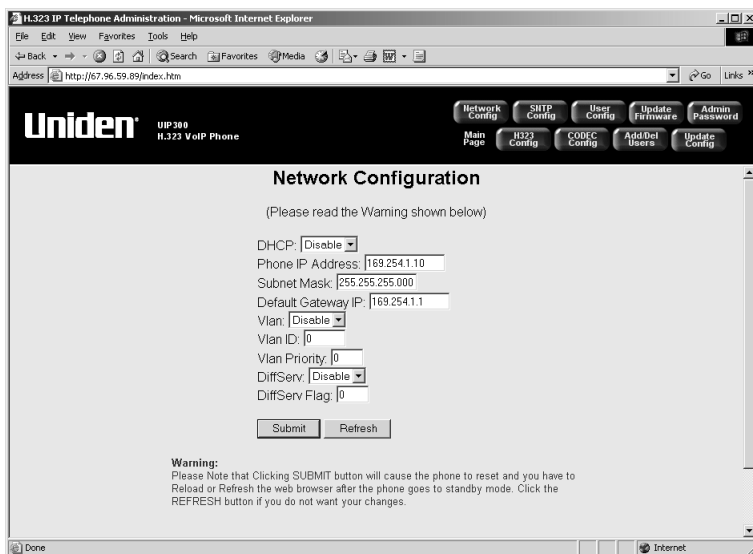

Figure 4-14 Network Configuration

To change a configuration:

1. Modify the information in the field by either entering the new information or clicking on the pulldown menu and selecting the new option.
2. Click **Submit**.

note

- *The new settings are stored in the flash memory of UIP300 and the telephone resets.*
- *After the new settings are stored and the telephone restarts and returns to standby mode, click **Refresh** to reload the web browser to view the updated information.*
- *Click **Refresh** before clicking **Submit** to cancel the changes.*

H.323 Configuration

This option allows users to modify the following H.323 related configurations.

PLAR Settings

- ◆ VOIP Proxy (Gateway)
 - IP Address
- ◆ Connection String

Feature Key DTMF Strings

- ◆ Redial DTMF String
- ◆ Conference DTMF String
- ◆ Transfer DTMF String

H.323 Settings

- ◆ Display Name
- ◆ Display Ext. (Yes/No)
- ◆ Extension (E164)
- ◆ GW Mode (Yes/No)
- ◆ RTP Port Base
- ◆ Use Fast Start (Yes/No)

Figure 4-15 H.323 Configuration

To change a configuration:

1. Modify the information in the field by either entering the new information or clicking on the pulldown menu and selecting the new option.
2. Click **Submit**.

note

- The new settings are stored in the flash memory of UIP300 and the telephone resets.
- After the new settings are stored and the telephone restarts and returns to standby mode, click **Refresh** to reload the web browser to view the updated information.
- Click **Refresh** before clicking **Submit** to cancel the changes.

SNTP Server

This option allows users to modify the following SNTP (Simple Network Time Protocol) related configurations.

- ◆ SNTP (Enable/Disable)
- ◆ Daylight Savings Time (Enable/Disable)
- ◆ Time Zone Offset (-12 to +12)
- ◆ SNTP Server IP Address

note

A global SNTP server (eg., 192.5.40.41) can be used as a default server if no local SNTP server is available.

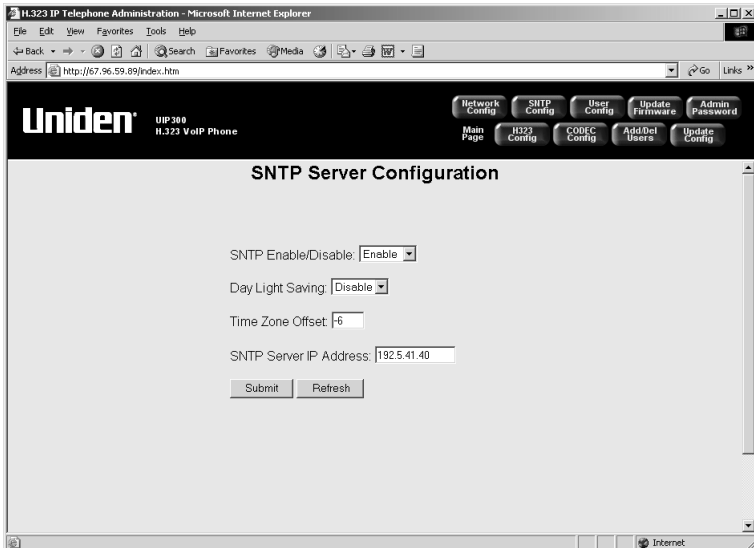

The screenshot shows a web browser window titled "H.323 IP Telephone Administration - Microsoft Internet Explorer". The address bar shows "http://67.96.59.89/index.htm". The page content includes the Uniden logo and "UIP 300 H.323 VoIP Phone". A navigation menu contains buttons for Network Config, SNTP Config, User Config, Update Firmware, Admin Password, Main Page, H323 Config, CODEC Config, Add/Del Users, and Update Config. The main content area is titled "SNTP Server Configuration" and contains the following fields and controls:

- SNTP Enable/Disable:
- Day Light Saving:
- Time Zone Offset:
- SNTP Server IP Address:
- Submit
- Refresh

Figure 4-16 SNTP Server Configuration

To change a configuration:

1. Modify the information in the field by either entering the new information or clicking on the pulldown menu and selecting the new option.
2. Click **Submit**.

note

Click **Refresh** before clicking **Submit** to cancel the changes.

Codec Configuration

This option allows users to modify the following voice Codec related configurations.

- ◆ Preferred Codec
- ◆ Acoustic Echo Canceller (Enable/Disable)
- ◆ Packet Size (ms)
- ◆ Nominal Jitter Depth (ms)



It is recommend that the nominal jitter depth be at least twice as large as the packet size.

- ◆ VAD (Enable/Disable)

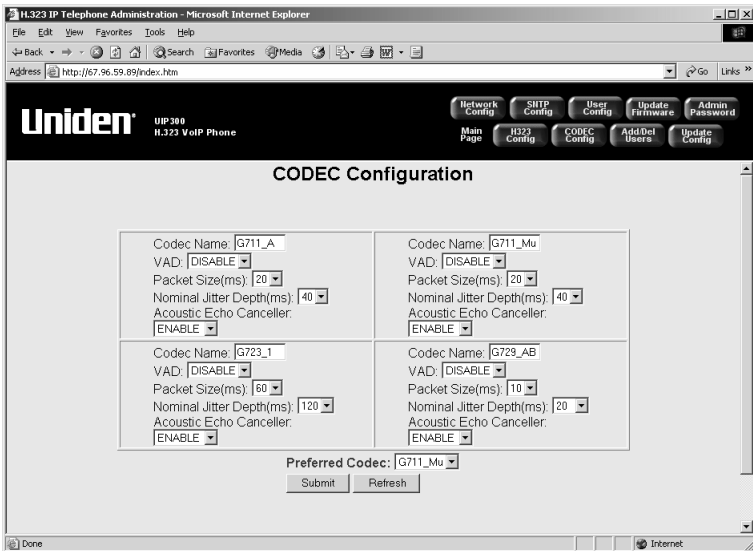

Figure 4-17 Codec Configuration

To change a configuration:

1. Modify the information in the field by either entering the new information or clicking on the pulldown menu and selecting the new option.
Or, select the Preferred Codec.
2. Click **Submit**.



*Click **Refresh** before clicking **Submit** to cancel the changes.*

Add/Del User and Password

This option allows users to add or delete the User Name and Password.

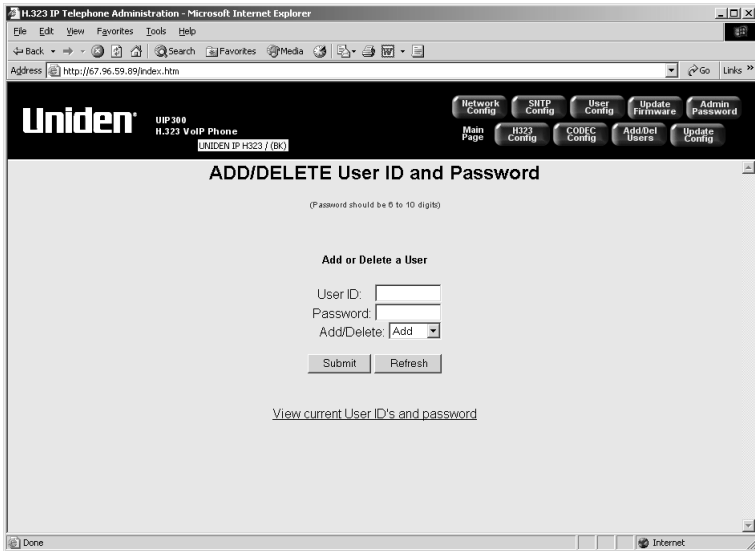

Figure 4-18 Add/Delete User ID and Password

To add/delete an administrator/user:

1. Enter the **User ID** and **Password**.
2. Select **Add/Delete** from the **Add/Del** pulldown menu.

note

- *The user that is currently logged on cannot be deleted.*
- *This terminal allows two users; the administrator and one additional user. At default the administrator and user are configured.*
- *Only the “administrator” is allowed to add or delete the “user.”*
- *To add a new user, delete the existing user and then add the new user.*

3. Click **Submit**.

note

- *The new settings are stored in the flash memory of UIP300 and the telephone resets.*
- *Click **Refresh** before clicking **Submit** to cancel the changes.*

Change Administrator's Password

This option allows the administrative user to change their password.



Figure 4-19 Administrator Password

To change the password:

1. Enter the **Old Admin Password**.
2. Enter the **New Admin Password**.

note

- The password is 6~10 digits.
- If the password is not valid, an error message is displayed. Return to the Administrator Password screen by clicking "Back to administrator password change" and repeat the process.

3. Enter the new password again in the **Confirm Password** field.
4. Click **Submit**.

note

- The new settings are stored in the flash memory of UIP300 and the telephone resets.
- Click **Refresh** before clicking **Submit** to cancel the changes.
- When the password has been successfully changed, the "Enter Network Password" box will prompt you to enter the new password.

Update Firmware

This option allows users to update the firmware version. Firmware updates can only be done using the web browser.

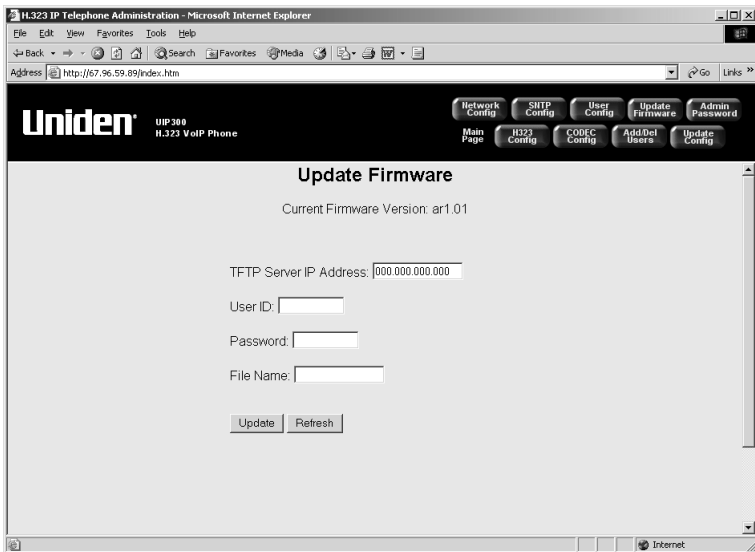

Figure 4-20 Update Firmware

To update the firmware:

1. Enter the **TFTP Server IP Address**.

note

A TFTP server must be running on an adjunct PC.

2. Enter the **User ID** (optional).
3. Enter the **Password** (optional).
4. Enter the **File Name**.
5. Click **Update**.

note

When the firmware starts updating “Downloading Firmware...” is displayed.

```
Downloading Firmware...  
uip300_enc_ar100.ftp
```

note

When the firmware file has been downloaded into RAM on UIP300, the checksum calculation starts.

```
Calculating Checksum...  
Please Wait
```

note

When the checksum calculation has finished, the old firmware is erased (the second line of the display indicates the sector of the flash being erased).

```
Erasing Flash...  
5/20
```

note

After the old firmware has been erased, new firmware programming starts (the percentage of progress is displayed on the second line of the display).

```
Programming Flash...  
75% Completed
```

note

When programming is completed, the following message is displayed and the telephone restarts automatically.

```
Firmware Update  
Completed
```

Update Configuration File

This option allows users to upload a configuration file from the web browser to configure UIP300.

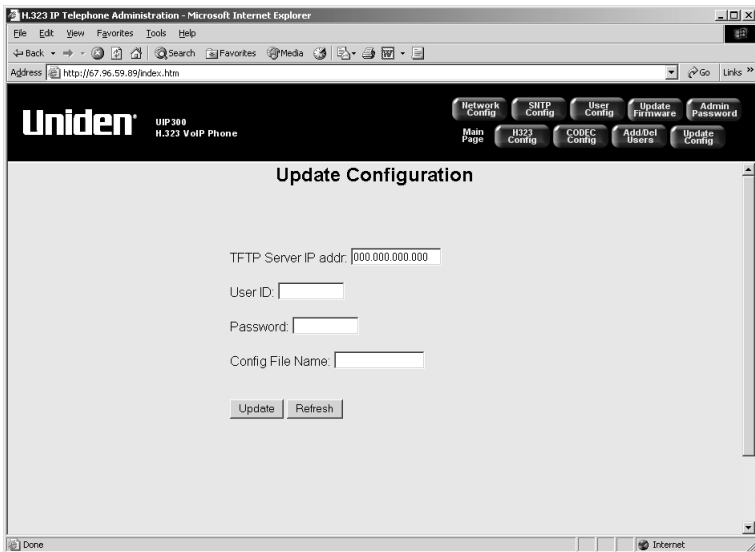

Figure 4-21 Update Configuration

To update the configuration file:

1. Enter the **TFTP Server IP Address**.
2. Enter the **User ID** (optional).
3. Enter the **Password** (optional).
4. Enter the **Config File Name**.
5. Click **Update**.

note

When the configuration file starts downloading, “Downloading Config...” is displayed.

```
Downloading Config...  
uip300_setting.txt
```

note

Once the configuration file has been downloaded into the RAM on UIP300, the progress message is displayed while the configuration is being updated.

```
Updating Config...
```

note

When the configuration update has been completed, “Config File Download Completed” is displayed and the telephone restarts automatically.

```
Config File Download  
Completed
```

Chapter 5 Appendix

General Information

This appendix provides information about the default setup and configuration data and provides a setup menu diagram to give users a “roadmap” of the programming menu structure.

Factory Default Settings

Parameter	Default
Handset Volume	2nd level
Speakerphone Volume	2nd level
Headset Volume	2nd level
Ringer Volume	2nd level
Phone Book	Empty
Call Log	Empty
Call Duration Timer	On
Call Waiting	On
Ringer Tone	Ringer 1
LCD Contrast	8th level
Function Key (5 keys)	No Feature Assigned
User Name	“user”
User Password	123456
Admin Name	“admin”
Admin Password	654321
DHCP	Disable
Phone IP Address	169.254.1.10
Subnet Mask	255.255.255.000
Default Gateway IP Address	169.254.1.2
VLAN	Disable
VLAN ID	0
VLAN Priority	0
DiffServ	Disable
DiffServ Flag	0
Firmware Updated	False
Display Name	“IP Phone”
Display Ext.	Yes
Extension (E164)	1000
Gateway Mode	Yes
RTP Port Base	30000
Use Fast Start	No

Parameter	Default
VOIP Proxy IP Address	169.254.1.1
Connection Password String	""
Redial DTMF String	"*66"
Conference DTMF String	"*"*"
Transfer DTMF String	"*"*1"
SNTP	Disable
Day Light Saving	Disable
Time zone offset	-6
SNTP server address	192.5.41.40
VAD (G711 A)	Disable
Packet Size (ms) (G711 A)	20
Nominal Jitter Depth (ms) (G711 A)	40
Acoustic Echo Canceller (G711 A)	Enable
VAD (G711 μ)	Disable
Packet Size (ms) (G711 μ)	20
Nominal Jitter Depth (ms) (G711 μ)	40
Acoustic Echo Canceller (G711 μ)	Enable
VAD (G723.1)	Disable
Packet Size (ms) (G723.1)	60
Nominal Jitter Depth (ms) (G723.1)	120
Acoustic Echo Canceller (G723.1)	Enable
VAD (G729.AB)	Disable
Packet Size (ms) (G729.AB)	10
Nominal Jitter Depth (ms) (G729.AB)	20
Acoustic Echo Canceller (G729.AB)	Enable
Preferred Codec Type	G711_Mu

Setup Menu Tree

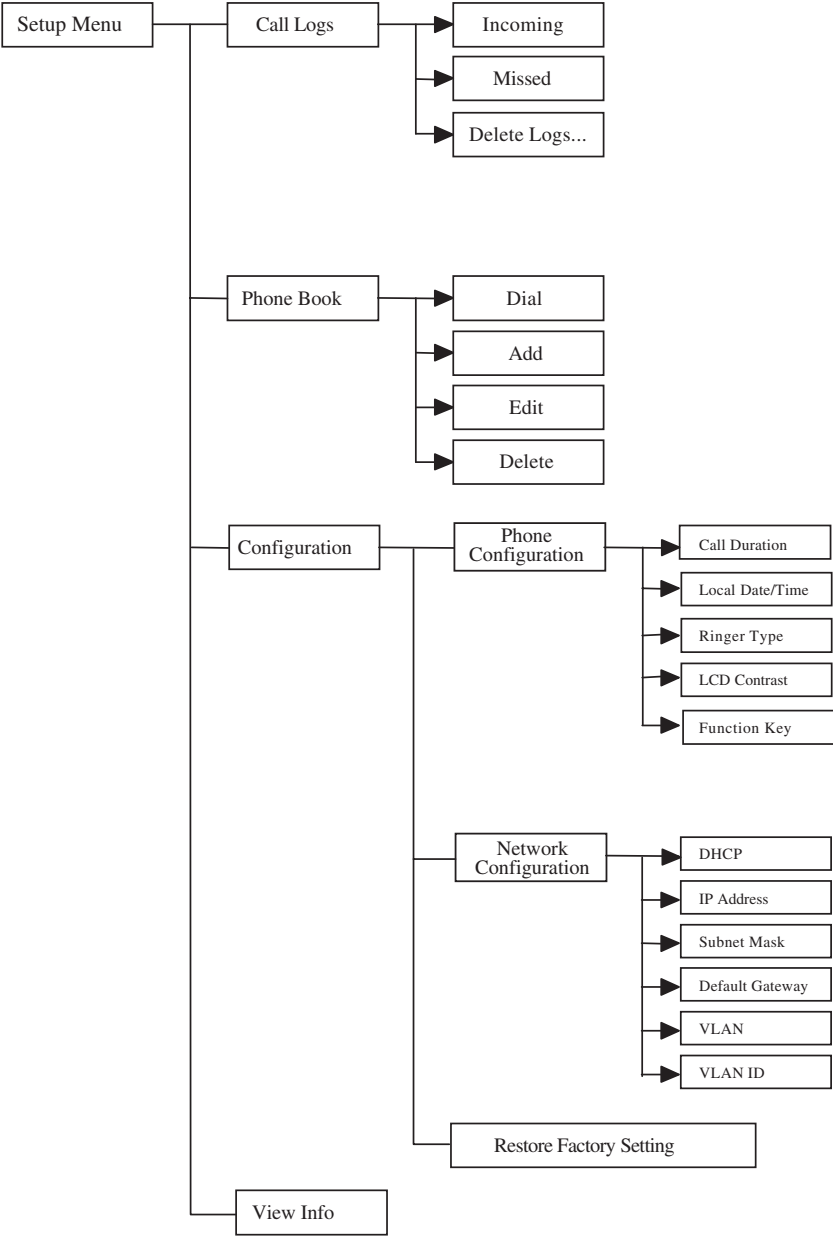

Memo

Memo

Uniden®

May be covered under one or more of the following U.S. patents:

4,523,058	4,595,795	4,797,916	5,381,460	5,426,690	5,434,905	5,491,745
5,533,010	5,574,727	5,581,598	5,650,790	5,660,269	5,661,780	5,663,981
5,671,248	5,696,471	5,717,312	5,732,355	5,754,407	5,758,289	5,768,345
5,787,356	5,794,152	5,801,466	5,825,161	5,864,619	5,893,034	5,912,968
5,915,227	5,929,598	5,930,720	5,960,358	5,987,330	6,044,281	6,070,082
6,125,277	6,253,088					

©2003 Uniden America Corporation, Fort Worth, Texas

Contain additional foreign articles.

Made in China.

Free Manuals Download Website

<http://myh66.com>

<http://usermanuals.us>

<http://www.somanuals.com>

<http://www.4manuals.cc>

<http://www.manual-lib.com>

<http://www.404manual.com>

<http://www.luxmanual.com>

<http://aubethermostatmanual.com>

Golf course search by state

<http://golfingnear.com>

Email search by domain

<http://emailbydomain.com>

Auto manuals search

<http://auto.somanuals.com>

TV manuals search

<http://tv.somanuals.com>