

SHARP

MICRO COMPONENT SYSTEM

MODEL

XL-S10

OPERATION MANUAL

Thank you for purchasing this SHARP product.
To obtain the best performance from this product,
please read this manual carefully. It will guide you in
operating your SHARP product.

XL-S10 Micro Component System consisting of XL-S10
(main unit) and CP-S10 (speaker system).

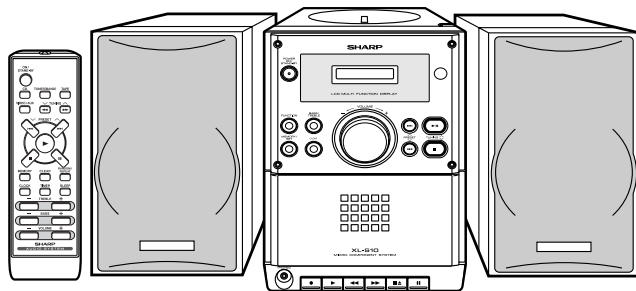

CD-R/RW
Playable 

COMPACT
disc
DIGITAL AUDIO

SPECIAL NOTES

Important Instruction



CAUTION
RISK OF ELECTRIC SHOCK
DO NOT OPEN



CAUTION: TO REDUCE THE RISK OF ELECTRIC SHOCK, DO NOT REMOVE COVER (OR BACK). NO USER-SERVICEABLE PARTS INSIDE. REFER SERVICING TO QUALIFIED SERVICE PERSONNEL.

Explanation of Graphical Symbols:



The lightning flash with arrowhead symbol, within an equilateral triangle, is intended to alert the user to the presence of uninsulated "dangerous voltage" within the product's enclosure that may be of sufficient magnitude to constitute a risk of electric shock to persons.



The exclamation point within an equilateral triangle is intended to alert the user to the presence of important operating and maintenance (servicing) instructions in the literature accompanying the appliance.

WARNING: TO REDUCE THE RISK OF FIRE OR ELECTRIC SHOCK, DO NOT EXPOSE THIS APPLIANCE TO RAIN OR MOISTURE.

Caution - use of controls or adjustments or performance of procedures other than those specified herein may result in hazardous radiation exposure.

NOTE

This equipment has been tested and found to comply with the limits for a Class B digital device, pursuant to Part 15 of the FCC Rules. These limits are designed to provide reasonable protection against harmful interference in a residential installation. This equipment generates, uses, and can radiate radio frequency energy and, if not installed and used in accordance with the instructions, may cause harmful interference to radio communications. However, there is no guarantee that interference will not occur in a particular installation. If this equipment does cause harmful interference to radio or television reception, which can be determined by turning the equipment off and on, the user is encouraged to try to correct the interference by one or more of the following measures:

- Reorient or relocate the receiving antenna.
- Increase the separation between the equipment and receiver.
- Connect the equipment into an outlet on a circuit different from that to which the receiver is connected.
- Consult the dealer or an experienced radio/TV technician for help.

WARNING

FCC Regulations state that any unauthorized changes or modifications to this equipment not expressly approved by the manufacturer could void the user's authority to operate this equipment.

NOTE

It is the intent of Sharp that this product be used in full compliance with the copyright laws of the United States and that prior permission be obtained from copyright owners whenever necessary.

FOR YOUR RECORDS

For your assistance in reporting this unit in case of loss or theft, please record below the model number and serial number which are located on the rear of the unit. Please retain this information.

Model number

Serial number

Date of purchase

Place of purchase

IMPORTANT SAFETY INSTRUCTIONS

- 1 Read Instructions** - All the safety and operating instructions should be read before the product is operated.
- 2 Retain Instructions** - The safety and operating instructions should be retained for future reference.
- 3 Heed Warnings** - All warnings on the product and in the operating instructions should be adhered to.
- 4 Follow Instructions** - All operating and use instructions should be followed.
- 5 Cleaning** - Unplug this product from the wall outlet before cleaning. Do not use liquid cleaners or aerosol cleaners. Use a damp cloth for cleaning.
- 6 Attachments** - Do not use attachments not recommended by the product manufacturer as they may cause hazards.
- 7 Water and Moisture** - Do not use this product near water - for example, near a bath tub, wash bowl, kitchen sink, or laundry tub; in a wet basement; or near a swimming pool; and the like.
- 8 Accessories** - Do not place this product on an unstable cart, stand, tripod, bracket, or table. The product may fall, causing serious injury to a child or adult, and serious damage to the product. Use only with a cart, stand, tripod, bracket, or table recommended by the manufacturer, or sold with the product. Any mounting of the product should follow the manufacturer's instructions, and should use a mounting accessory recommended by the manufacturer.
- 9 A product and cart combination should be moved with care. Quick stops, excessive force, and uneven surfaces may cause the product and cart combination to overturn.**



- 10 Ventilation** - Slots and openings in the cabinet are provided for ventilation and to ensure reliable operation of the product and to protect it from overheating, and these openings must not be blocked or covered. The openings should never be blocked by placing the product on a bed, sofa, rug, or other similar surface. This product should not be placed in a built-in installation such as a bookcase or rack unless proper ventilation is provided or the manufacturer's instructions have been adhered to.
- 11 Power Sources** - This product should be operated only from the type of power source indicated on the marking label. If you are not sure of the type of power supply to your home, consult your product dealer or local power company. For products intended to operate from battery power, or other sources, refer to the operating instructions.
- 12 Grounding or Polarization** - This product may be equipped with a polarized alternating-current line plug (a plug having one blade wider than the other). This plug will fit into the power outlet only one way. This is a safety feature. If you are unable to insert the plug fully into the outlet, try reversing the plug. If the plug should still fail to fit, contact your electrician to replace your obsolete outlet. Do not defeat the safety purpose of the polarized plug.
Alternate Warnings - This product is equipped with a three-wire grounding-type plug, a plug having a third (grounding) pin. This plug will only fit into a grounding-type power outlet. This is a safety feature. If you are unable to insert the plug into the outlet, contact your electrician to replace your obsolete outlet. Do not defeat the safety purpose of the grounding-type plug.
- 13 Power-Cord Protection** - Power-supply cords should be routed so that they are not likely to be walked on or pinched by items placed upon or against them, paying particular attention to cords at plugs, convenience receptacles, and the point where they exit from the product.
- 14 Protective Attachment Plug** - The product is equipped with an attachment plug having overload protection. This is a safety feature. See Instruction Manual for replacement or resetting of protective device. If replacement of the plug is required, be sure the service technician has used a replacement plug specified by the manufacturer that has the same overload protection as the original plug.

IMPORTANT SAFETY INSTRUCTIONS (continued)

- 15 Outdoor Antenna Grounding** - If an outside antenna or cable system is connected to the product, be sure the antenna or cable system is grounded so as to provide some protection against voltage surges and built-up static charges. Article 810 of the National Electrical Code, ANSI/NFPA 70, provides information with regard to proper grounding of the mast and supporting structure, grounding of the lead-in wire to an antenna discharge unit, size of grounding conductors, location of antenna discharge unit, connection to grounding electrodes, and requirements for the grounding electrode.

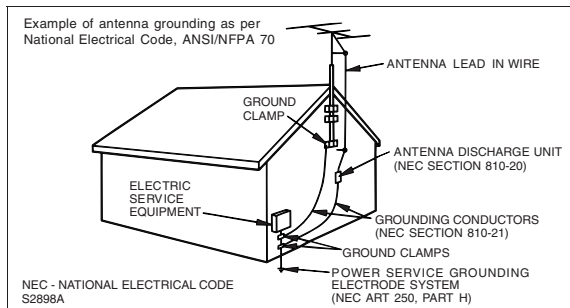

- 16 Lightning** - For added protection for this product during a lightning storm, or when it is left unattended and unused for long periods of time, unplug it from the wall outlet and disconnect the antenna or cable system. This will prevent damage to the product due to lightning and power-line surges.
- 17 Power Lines** - An outside antenna system should not be located in the vicinity of overhead power lines or other electric light or power circuits, or where it can fall into such power lines or circuits. When installing an outside antenna system, extreme care should be taken to keep from touching such power lines or circuits as contact with them might be fatal.
- 18 Overloading** - Do not overload wall outlets, extension cords, or integral convenience receptacles as this can result in a risk of fire or electric shock.

- 19 Object and Liquid Entry** - Never push objects of any kind into this product through openings as they may touch dangerous voltage points or short-out parts that could result in a fire or electric shock. Never spill liquid of any kind on the product.

- 20 Servicing** - Do not attempt to service this product yourself as opening or removing covers may expose you to dangerous voltage or other hazards. Refer all servicing to qualified service personnel.

- 21 Damage Requiring Service** - Unplug this product from the wall outlet and refer servicing to qualified service personnel under the following conditions:

- When the power-supply cord or plug is damaged,
- If liquid has been spilled, or objects have fallen into the product,
- If the product has been exposed to rain or water,
- If the product does not operate normally by following the operating instructions. Adjust only those controls that are covered by the operating instructions as an improper adjustment of other controls may result in damage and will often require extensive work by a qualified technician to restore the product to its normal operation,
- If the product has been dropped or damaged in any way, and
- When the product exhibits a distinct change in performance - this indicates a need for service.

- 22 Replacement Parts** - When replacement parts are required, be sure the service technician has used replacement parts specified by the manufacturer or have the same characteristics as the original part. Unauthorized substitutions may result in fire, electric shock, or other hazards.

- 23 Safety Check** - Upon completion of any service or repairs to this product, ask the service technician to perform safety checks to determine that the product is in proper operating condition.

- 24 Wall or Ceiling Mounting** - The product should be mounted to a wall or ceiling only as recommended by the manufacturer.

- 25 Heat** - The product should be situated away from heat sources such as radiators, heat registers, stoves, or other products (including amplifiers) that produce heat.

Accessories

Please confirm that the following accessories are included.

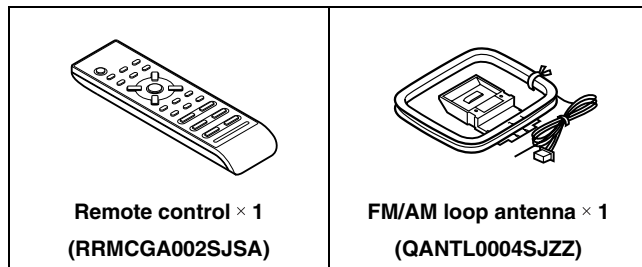

Note:

Only the above accessories are included.

Contents

	Page
■ General Information	
Precautions	6
Controls and indicators	7, 8
■ Preparation for Use	
System connections	9, 10
Remote control	11
■ Basic Operation	
Sound control	12
Setting the clock	13
■ CD Playback	
Listening to a CD	14 - 16
Programmed play	17
■ Radio	
Listening to the radio	18
Listening to the memorized station	19
■ Tape Playback	
Listening to a cassette tape	20
■ Tape Recording	
Recording to a cassette tape	21, 22
■ Advanced Features	
Timer and sleep operation	23, 24
Enhancing your system	25, 26
■ References	
Troubleshooting chart	27, 28
Maintenance	29
Specifications	30
CONSUMER LIMITED WARRANTY	Back cover

Precautions

■ General

- Please ensure that the equipment is positioned in a well-ventilated area and that there is at least 4" (10 cm) of free space along the sides and back. There must also be a minimum of 8" (20 cm) of free space on the top of the unit.

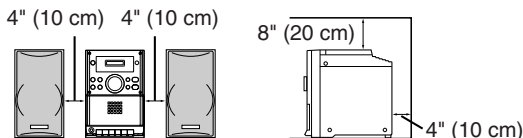

- Use the unit on a firm, level surface free from vibration.



- Keep the unit away from direct sunlight, strong magnetic fields, excessive dust, humidity and electronic/electrical equipment (home computers, facsimiles, etc.) which generate electrical noise.



- Do not place anything on top of the unit.
- Do not expose the unit to moisture, to temperatures higher than 140°F (60°C) or to extremely low temperatures.
- If the system does not work properly, unplug and plug it in again. Then turn on the system.
- In case of an electrical storm, unplug the unit for safety.

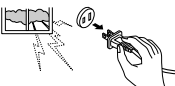

- Hold the AC power plug by the head when removing it from the AC outlet, as pulling the cord can damage internal wires.

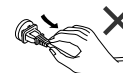

- Do not remove the outer cover, as this may result in electric shock. Refer internal service to your local SHARP service facility.

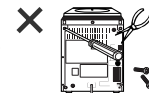

- This unit should only be used within the range of 41°F - 95°F (5°C - 35°C).

Warnings:

- The voltage used must be the same as that specified on this unit. Using this product with a higher voltage other than that which is specified is dangerous and may result in a fire or other type of accident causing damage. SHARP will not be held responsible for any damage resulting from use of this unit with a voltage other than that which is specified.
- CD players use a laser pickup which can damage the eyes if viewed directly. Do not look at the pickup, and do not touch the pickup directly.

■ Volume control

The sound level at a given volume setting depends on speaker efficiency, location and various other factors. It is advisable to avoid exposure to high volume levels, which occurs while turning the unit on with the volume control setting up high, or while continually listening at high volumes.

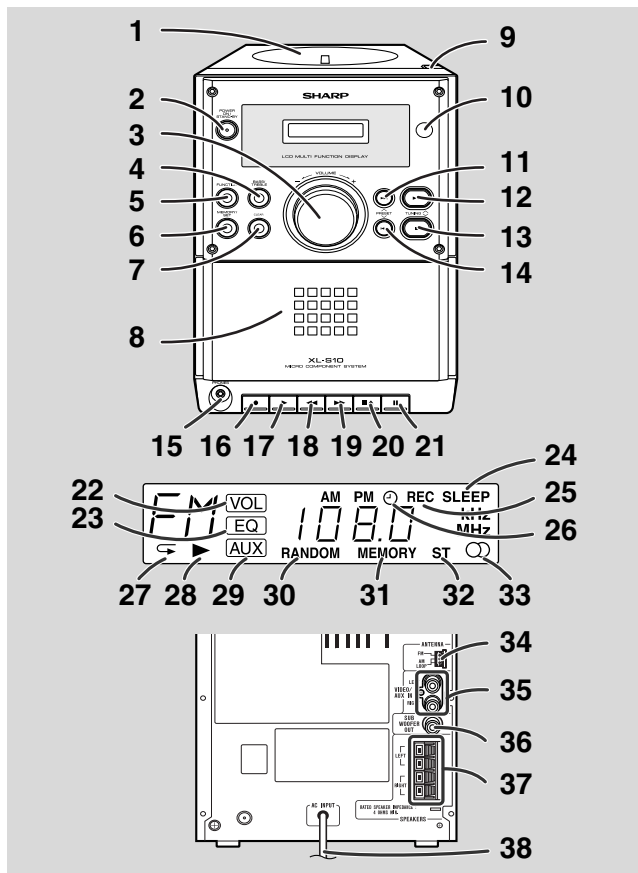

	Reference page
1. CD Compartment	14
2. Power On/Stand-by Button	11
3. Volume Control	12
4. Bass/Treble Selector Button	12
5. Function Selector Button	14, 18, 20, 23
6. Memory/Set Button	17, 19
7. Clear Button	17, 19
8. Cassette Compartment	20
9. CD Eject Button	14
10. Remote Sensor	11
11. CD Track Up or Fast Forward, Tuner Preset Up Button	15, 19
12. CD Play or Pause, Tuning Up Button	14, 15, 18
13. CD Stop, Tuning Down Button	15, 18
14. CD Track Down or Fast Reverse, Tuner Preset Down Button	15, 19
15. Headphone Jack	26
16. Tape Record Button	21, 22
17. Tape Play Button	20, 21, 22
18. Tape Rewind Button	20
19. Tape Fast Forward Button	20
20. Tape Stop/Eject Button	20, 21, 22
21. Tape Pause Button	20, 21, 22
22. Volume Indicator	12
23. Equalizer Indicator	12
24. Sleep Indicator	24
25. Tape Record Indicator	21
26. Timer Play Indicator	23
27. CD Repeat Play Indicator	16
28. CD Play Indicator	14
29. Auxiliary Indicator	25
30. CD Random Play Indicator	16
31. Memory Indicator	17, 19
32. FM Stereo Mode Indicator	18
33. FM Stereo Receiving Indicator	18
34. FM/AM Loop Antenna Jack	9
35. Video/Auxiliary (Audio Signal) Input Jacks	25
36. Subwoofer Pre-output Jack	26
37. Speaker Terminals	9
38. AC Power Cord	10

Controls and indicators (continued)

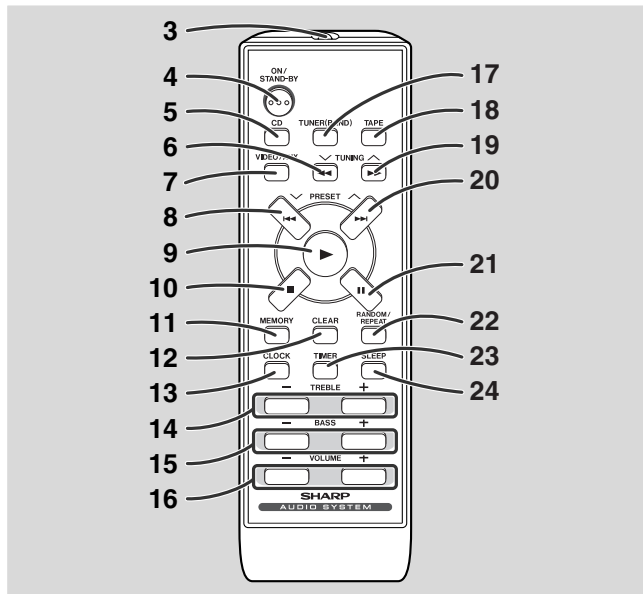
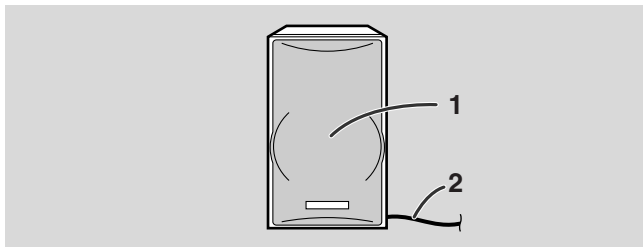

- 1. Full-Range Speaker
- 2. Speaker Wire

Reference page

3. Remote Control Transmitter	11
4. Power On/Stand-by Button	11
5. CD Button	14
6. CD Fast Reverse, Tuning Down Button	15, 18
7. Video/Auxiliary Button	25
8. CD Track Down, Tuner Preset Down Button	15, 19
9. CD Play Button	14, 15
10. CD Stop Button	15, 22
11. Memory Button	13, 17, 19
12. Clear Button	17, 19
13. Clock Button	13
14. Treble Up and Down Buttons	12
15. Bass Up and Down Buttons	12
16. Volume Up and Down Buttons	12, 23
17. Tuner and Band Selector Button	18
18. Tape Button	20
19. CD Fast Forward, Tuning Up Button	15, 18
20. CD Track Up, Tuner Preset Up Button	15, 19
21. CD Pause Button	15
22. Random/Repeat Button	16
23. Timer Button	23
24. Sleep Button	24

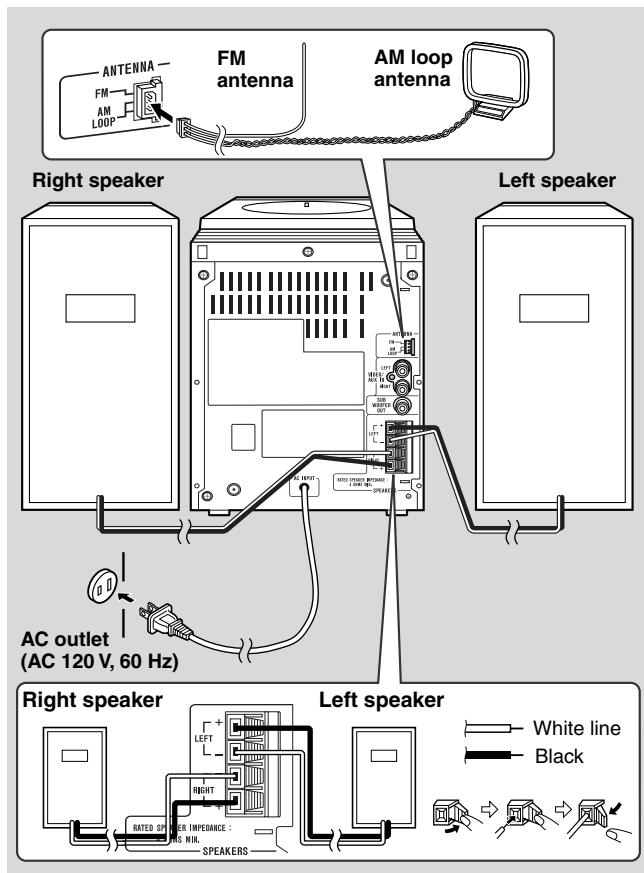

Make sure to unplug the AC power cord before any connections.

Antenna connection

Connect the FM/AM loop antenna to the ANTENNA jack. Position the FM antenna wire and rotate the AM loop antenna for optimum reception. Place the AM loop antenna on a shelf, or attach it to a stand or a wall.

Notes:

- Placing the antenna on the unit or near the AC power cord may cause noise pickup. Place the antenna away from the unit for better reception.
- Do not connect the attached FM antenna to an external FM antenna. Otherwise, trouble may occur.

Installing the AM loop antenna:

< Assembling >

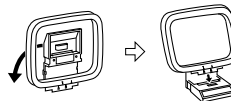

< Attaching to the wall >



Speaker connection

Connect the wire with the white line to the minus (-) terminal and the black wire to the plus (+) terminal.

Caution:

- Do not let the bare speaker wires touch each other.
- Use speakers with an impedance of 4 ohms or more, as lower impedance speakers can damage the unit.
- Do not mistake the right and the left channels. The right speaker is the one on the right side when you face the unit.

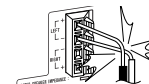

Incorrect

System connections (continued)

■ Placing the speaker system

There is no distinction between the right and the left speakers.

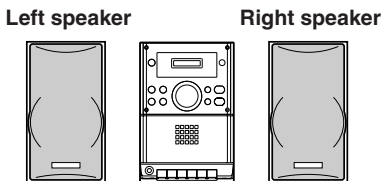

Notes:

- The speakers are magnetically shielded. Therefore, they do not affect the display even if you use them near the TV. However, some color variation may occur, depending on the type of TV used.

If color variation occurs...

Turn off the TV (from the power switch).
After 15 - 30 minutes, turn the TV on again.

If the color variation is still present...

Move the speakers further away from the TV.

- If any kind of magnet or an electromagnet is placed too close to the TV and the system, irregular colors may appear on the TV screen.

Note:

The speaker grilles are not removable.

■ Connecting the AC power cord

After checking all the connections have been made correctly, plug the AC power cord of this unit into the wall socket.

Note:

Unplug the unit if it will not be used for a prolonged period of time.

■ To turn the power on

Press the POWER ON/STAND-BY button to turn the power on.

To set the unit to the stand-by mode:

Press the POWER ON/STAND-BY button again.

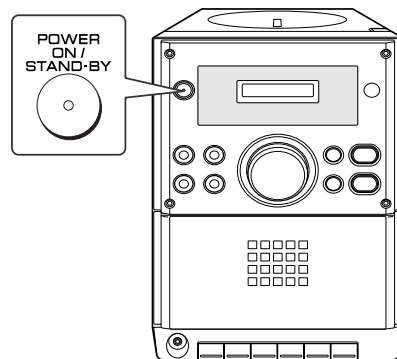

Remote control

■ Battery installation

Use 2 "AAA" size batteries (UM-4, R03, HP-16 or similar).
Batteries are not included.

- 1 **Remove the battery cover.**
- 2 **Insert the batteries according to the direction indicated in the battery compartment.**
When inserting or removing the batteries, push them toward the ⊖ battery terminals.
- 3 **Replace the cover.**

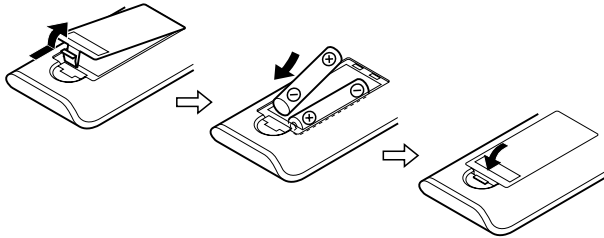

Precautions for battery use:

- Replace all old batteries with new ones at the same time.
- Do not mix old and new batteries.
- Remove the batteries if the unit is not to be used for long periods of time. This will prevent potential damage due to battery leakage.

Caution:

- Do not use rechargeable batteries (nickel-cadmium battery, etc.).
- Installing the batteries incorrectly may cause the unit to malfunction.

Notes concerning use:

- Replace the batteries if the operating distance is reduced or if the operation becomes erratic.
- Periodically clean the transmitter on the remote control and the sensor on the unit with a soft cloth.
- Exposing the sensor on the unit to strong light may interfere with operation. Change the lighting or the direction of the unit if this occurs.
- Keep the remote control away from moisture, heat, shock, and vibrations.

■ Test of the remote control

Face the remote control directly to the remote sensor on the unit.

Press the ON/STAND-BY button. Does the power turn on?
Now, you can enjoy the music.

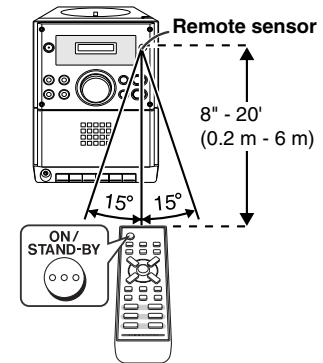

Sound control

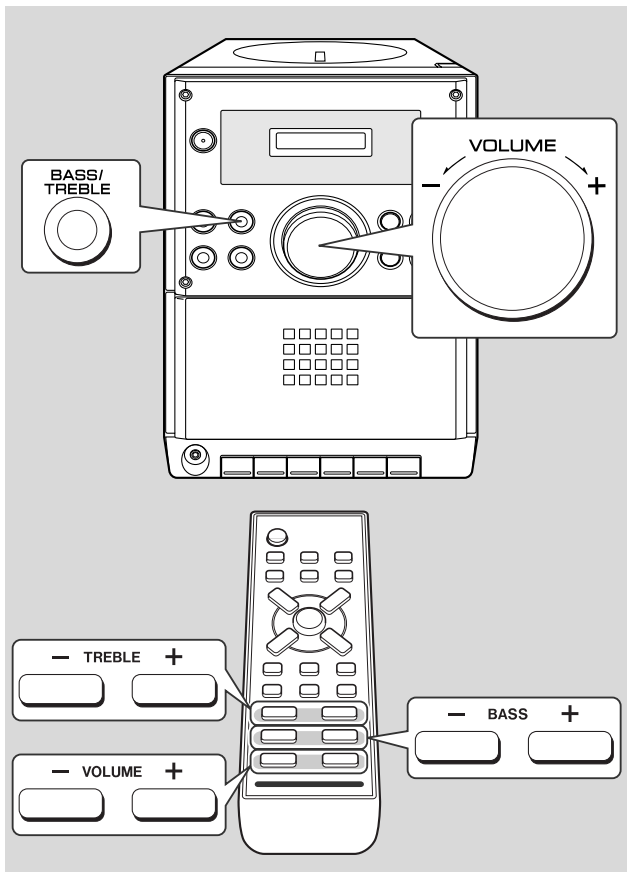

■ Adjusting the volume

Main unit operation:

When the VOLUME control is turned clockwise, the volume will increase. When it is turned counterclockwise, the volume will decrease.

Remote control operation:

Press the VOLUME + button to increase the volume and the VOLUME - button to decrease the volume.

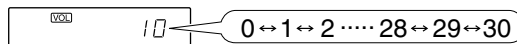

■ Adjusting the bass

Main unit operation:

- 1 Press the BASS/TREBLE button to select "BASS".
- 2 Within 5 seconds, turn the VOLUME control to adjust the bass.

Remote control operation:

Press the BASS (- or +) button to adjust the bass.

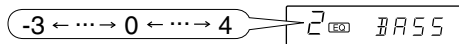

■ Adjusting the treble

Main unit operation:

- 1 Press the BASS/TREBLE button to select "TrE".
- 2 Within 5 seconds, turn the VOLUME control to adjust the treble.

Remote control operation:

Press the TREBLE (- or +) button to adjust the treble.

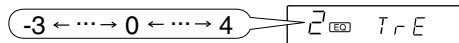

Setting the clock

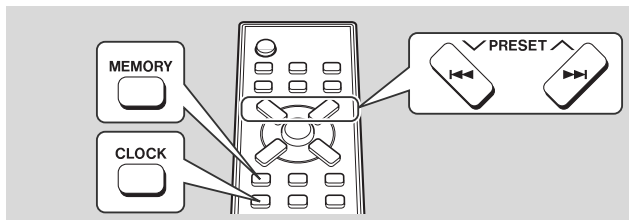

This may be operated only with the remote control.
In this example, the clock is set for the 12-hour (AM 12:00) display.

- 1 Press the CLOCK button and within 5 seconds, press the MEMORY button.**

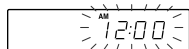

- 2 Within 1 minute, press the PRESET (∨ or ∧) button to select 12-hour or 24-hour display and then press the MEMORY button.**

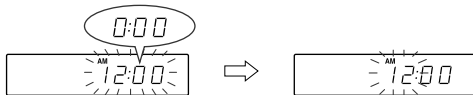

"AM 12:00" → The 12-hour display will appear.

(AM 12:00 - PM 11:59)

"0:00" → The 24-hour display will appear.

(0:00 - 23:59)

Note that this can only be set when the unit is first installed or it has been reset. (Refer to "Clearing all the memory (reset)" on page 28.)

- 3 Within 1 minute, press the PRESET (∨ or ∧) button to adjust the hour and then press the MEMORY button.**

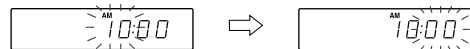

When the 12-hour display is selected, "AM" will change automatically to "PM".

- 4 Within 1 minute, press the PRESET (∨ or ∧) button to adjust the minutes and then press the MEMORY button.**

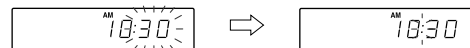

The clock starts from "0" second. (Seconds are not displayed.)

To confirm the time display:

Press the CLOCK button.

The time display will appear for about 5 seconds.

Note:

The "AM 12:00" or time will flash when the AC power supply is restored after a power failure or unplugging the unit. Readjust the clock as follows.

To readjust the clock:

Perform "Setting the clock" from the beginning.

To change the 12-hour or 24-hour display:

- 1 Clear all the programmed contents. [Refer to "Clearing all the memory (reset)" on page 28 for details.]
- 2 Perform "Setting the clock" from the beginning.

Listening to a CD

This system can play audio CDs, and CD-R/RW discs but can not record CDs.

Some audio CD-R and CD-RW discs may not be playable due to the state of the disc or the device that was used for recording.

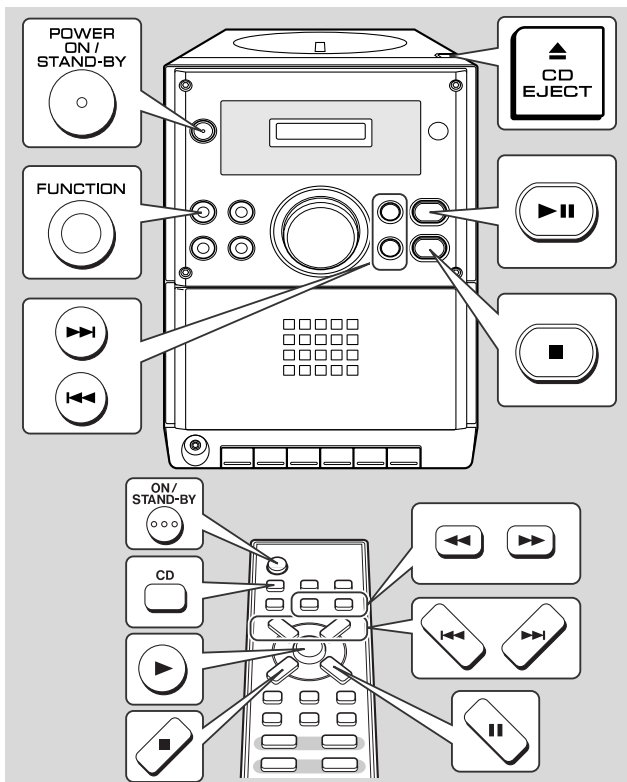

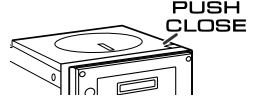
- 1 Press the ON/STAND-BY button to turn the power on.**
- 2 Press the FUNCTION button until "Cd DISC" appears on the display.**
When operating with the remote control, press the CD button.
- 3 Press the ▲ CD EJECT button to open the CD compartment.**
- 4 Place a CD on the spindle, label side up.**

- 5 Close the CD compartment by firmly pushing the corner marked "PUSH CLOSE".**

16	47:38
----	-------

Total number of tracks Total playing time
- 6 Press the ►II (▶) button to start playback from track 1.**

01 0:03

When the last track on the disc has finished playing, the CD player will stop automatically.

To interrupt playback:**Main unit operation:**

Press the ►|| button.

To resume playback from the same point, press the ►|| button again.

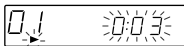
**Remote control operation:**

Press the || button.

To resume playback from the same point, press the ► button.

To stop playback:

Press the ■ button.

To remove the CD:

While in the stop mode, press the ▲ CD EJECT button.

After use:

Press the ON/STAND-BY button to enter the power stand-by mode.

Caution:

- If a disc is damaged, dirty, or loaded upside down, "no DISC" will appear on the display.
- Keep foreign objects out of the CD compartment.
- Subjecting the unit to shock or vibration may cause mistracking.
- When the unit is not being used, be sure to close the CD compartment. If it is left open, the lens may be covered with dust and the unit may not operate properly.
- If TV or radio interference occurs during CD operation, move the unit away from the TV or radio.

■ To locate the beginning of a track**To move to the beginning of the next track:**

Press the ►► button for less than 0.5 seconds during playback.



- You can skip to any track by pressing the ►► button repeatedly until the desired track number appears.

To restart the track being played:

Press the ◀◀ button for less than 0.5 seconds during playback.



- You can skip to any track by pressing the ◀◀ button repeatedly until the desired track number appears.

■ To locate the desired portion**For audible fast forward:**

Press and hold down the ►► button on the main unit or the ►► button on the remote control during playback.

For audible fast reverse:

Press and hold down the ◀◀ button on the main unit or the ◀◀ button on the remote control during playback.

Notes:

- Normal playback will resume when the ◀◀ (◀◀) or ►► (►►) button is released.
- When the end of the last track is reached during fast forward, "End" will appear on the display and CD operation will be paused. When the beginning of the first track is reached during fast reverse, the disc will start playback automatically.

Listening to a CD (continued)

■ Repeat or Random play

You can select one of the CD playback mode; "Repeat play", "Random play" and "Normal play".

- 1 When in the CD mode, press the **RANDOM/REPEAT** button on the remote control repeatedly to select the playback mode.

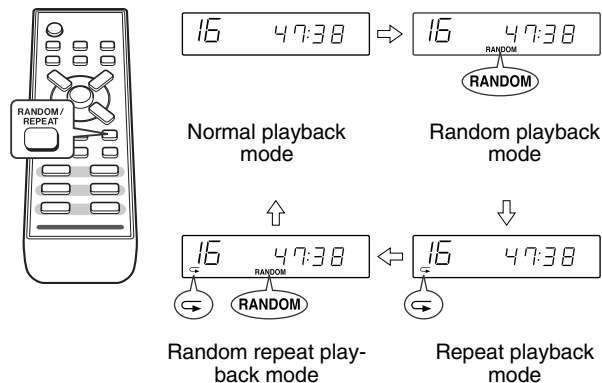

- 2 Press the **▶** button to start playback.

To repeat a programmed sequence:

Perform steps 1 - 4 in the "Programmed Play" section and then select the repeat playback.

Notes:

- The random play will stop automatically when all tracks are played once. (The same track will not be played back twice.)
- In random play, the CD player will select and play tracks automatically. (You cannot select the order of the tracks.)
- If you press the **▶▶** button during random play, you can move to the track selected next by the random operation. On the other hand, the **◀◀** button does not allow you to move to the previous track. The beginning of the track being played will be located.

Caution:

After performing repeat play or random repeat play, be sure to press the **■** button. Otherwise, the disc will play continuously.

To cancel repeat or random play:

Press the **RANDOM/REPEAT** button on the remote control repeatedly to select the normal playback mode.

Programmed play

You can choose up to 32 selections for playback in the order you like.

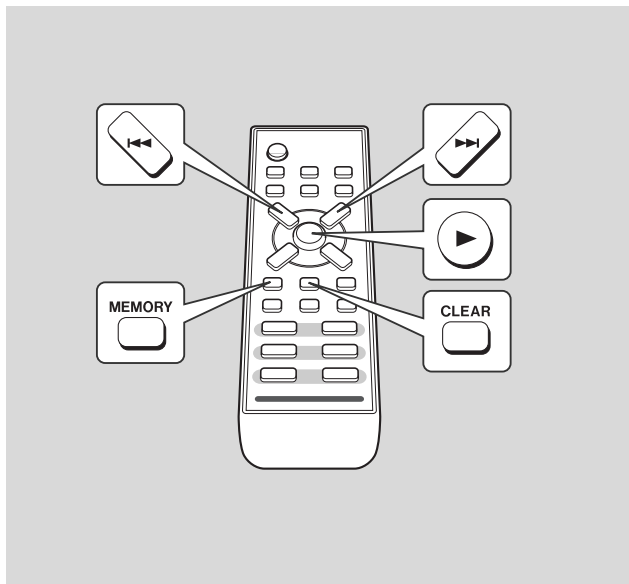

1 While in the stop mode, press the ◀◀ or ▶▶ button to select the desired track.



Selected track number

2 Press the MEMORY (MEMORY/SET) button to save the track number.

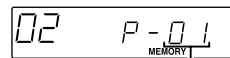

Playback order

3 Repeat steps 1 - 2 for other tracks. Up to 32 tracks can be programmed.

4 Press the ▶ (▶||) button to start playback.

To clear the programmed selections:

Press the CLEAR button while the "MEMORY" indicator is lit. Each time the button is pressed, one track will be cleared, beginning with the last track programmed.

Adding tracks to the program:

If a program has been previously stored, the "MEMORY" indicator will be displayed. Then follow steps 1 - 2 to add tracks. The new tracks will be stored after the last track of the original program.

Notes:

- Opening the CD compartment automatically cancels the programmed sequence.
- Even if you press the ON/STAND-BY button to enter the stand-by mode or the function is changed from CD to some other function, the programmed selections will not be cleared.
- During program operation, random play is not possible.

Listening to the radio

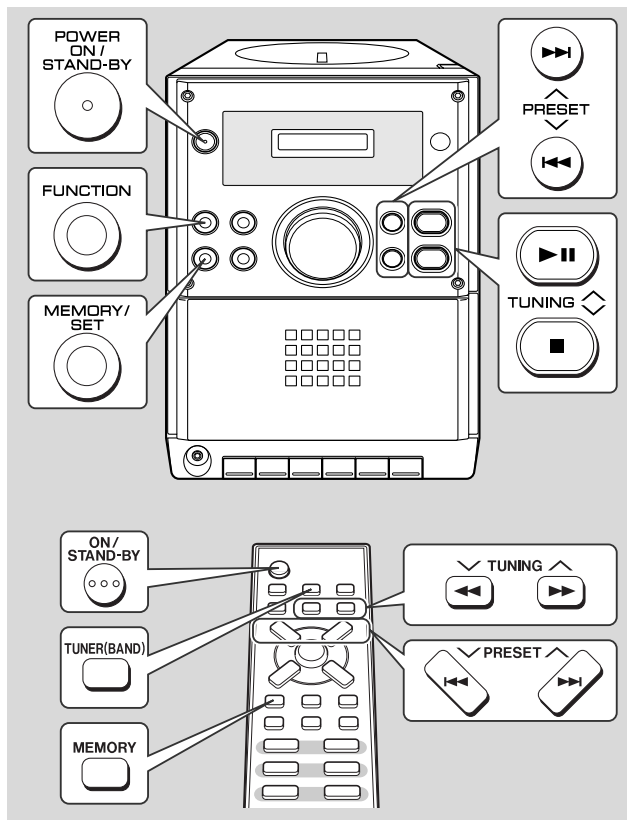

After use:

Press the ON/STAND-BY button to enter the power stand-by mode.

- 1 Press the ON/STAND-BY button to turn the power on.**
- 2 Press the FUNCTION button until "FM" or "AM" appears on the display.**
When operating with the remote control, press the TUNER (BAND) button to select "FM" or "AM".
- 3 Press the TUNING (∨ or ∧) button to tune in to the desired station.**
Manual tuning:
Press the TUNING button as many times as required to tune in to the desired station.
Auto tuning:
When the TUNING button is pressed for more than 0.5 seconds, scanning will start automatically and the tuner will stop at the first receivable broadcast station.
Notes:
 - When radio interference occurs, auto scan tuning may stop automatically at that point.
 - Auto scan tuning will skip weak signal stations.
 - To stop the auto tuning, press the TUNING button again.

To receive an FM stereo transmission:

Press the FUNCTION (TUNER (BAND)) button to display the "ST" indicator.

- "∞" will appear when an FM broadcast is in stereo.
- If the FM reception is weak, press the FUNCTION (TUNER (BAND)) button to extinguish the "ST" indicator. The reception changes to monaural, and the sound becomes clearer.

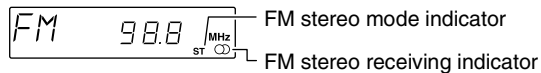

Listening to the memorized station

■ Memorizing a station

You can store 40 AM and FM stations in memory and recall them at the push of a button. (Preset tuning)

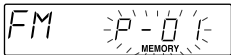
- 1 Perform steps 1 - 3 in "Listening to the radio" on page 18.**
- 2 Press the MEMORY/SET (MEMORY) button to enter the preset tuning saving mode.**

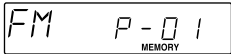
- 3 Within 5 seconds, press the PRESET (∨ or ∧) button to select the preset channel number.**

Store the stations in memory, in order, starting with preset channel 1.
- 4 Within 5 seconds, press the MEMORY/SET (MEMORY) button to store that station in memory.**

If the "MEMORY" and preset number indicators go out before the station is memorized, repeat the operation from step 2.
- 5 Repeat steps 1 - 4 to set other stations, or to change a preset station.**

When a new station is stored in memory, the station previously memorized will be erased.

Note:

The backup function protects the memorized stations for a few hours should there be a power failure or the AC power cord get disconnected.

■ To recall a memorized station

Press the PRESET (∨ or ∧) button for less than 0.5 seconds to select the desired station.

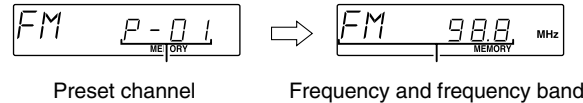

■ To scan the preset stations

The stations saved in memory can be scanned automatically. (Preset memory scan)

- 1 Press the PRESET (∨ or ∧) button for more than 0.5 seconds.**

The preset number will flash and the programmed stations will be tuned in sequentially, for 5 seconds each.
- 2 Press the PRESET (∨ or ∧) button again when the desired station is located.**

■ To clear a memorized station

- 1 Recall the memorized station.
- 2 While it is displayed, press the MEMORY/SET (MEMORY) button.
- 3 Within 5 seconds, press the CLEAR button on the remote control.

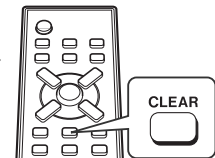

Listening to a cassette tape

Before playback:

- For playback, use normal or low-noise tapes for the best sound. (Metal or CrO₂ tapes are not recommended.)
- Do not use C-120 tapes or poor-quality tapes, as they may cause malfunctions.
- Before loading a tape into the cassette compartment, tighten the slack with a pen or a pencil.

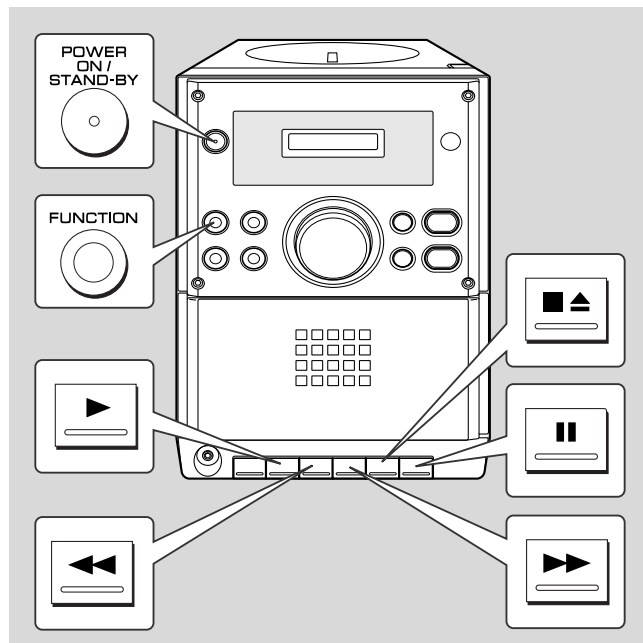

- 1 Press the ON/STAND-BY button to turn the power on.**
- 2 Press the FUNCTION button until "TAPE" appears on the display.**
When operating with the remote control, press the TAPE button.
- 3 Press the ■ ▲ button to open the cassette compartment.**
- 4 Load a cassette into the cassette compartment with the side to be played facing toward you.**
- 5 Close the cassette compartment.**
- 6 Press the ► button to start playback.**

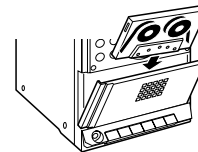

To stop playback:

Press the ■ ▲ button.

Fast forward/rewind:

To advance the tape, press the ■ ▲ button, then press the ►► button. To rewind, press the ■ ▲ button, then press the ◀◀ button.

To interrupt playback:

Press the || button during playback.

Press the || button again to resume playback.

Caution:

- Do not press the || button while fast forwarding or rewinding. The ◀◀ or ►► button will not be released when the tape end is reached. Once this occurs, press the ■ ▲ button.
- Before changing from one tape operation to another, press the ■ ▲ button.

Recording to a cassette tape

Before recording:

- When recording important selections, make a preliminary test to ensure that the desired material is properly recorded.
- SHARP is not liable for damage or loss of your recording arising from malfunction of this unit.
- The volume and sound controls can be adjusted with no effect on the recorded signal (Variable Sound Monitor).
- **For recording, use only normal tapes. Do not use metal or CrO₂ tapes.**

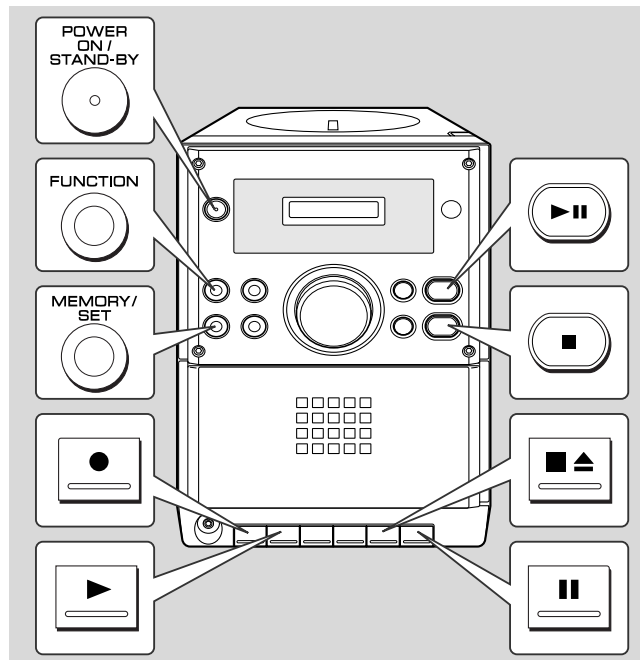

■ Recording from a CD

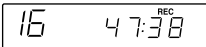
- 1 Press the ON/STAND-BY button to turn the power on.**
- 2 Press the FUNCTION button until "Cd DISC" appears on the display.**
When operating with the remote control, press the CD button.
- 3 Load the desired disc.**
- 4 Load a cassette into the cassette compartment with the side to be recorded on facing you.**
Wind past the leader of the tape, on which recording cannot be performed.
- 5 Press the II button.**
- 6 Press the ● button, which also engages the ► button.**

- 7 Press the II button again to cancel the pause mode.**
- 8 Press the ►II (►) button for CD.**

To perform programmed recording:

- 1 Program tracks (see page 17).
- 2 Press the II button.
- 3 Press the ● button, which also engages the ► button.
- 4 Press the II button again to cancel the pause mode.
- 5 Press the ►II (►) button for CD.

To interrupt recording:

Press the II button.
To resume recording, press the II button.

To stop recording:

Press the ■▲ button.
The tape will stop.

Recording to a cassette tape (continued)

■ Recording from the radio

- 1 Tune in to the desired station (see page 18).**
- 2 Load a cassette into the cassette compartment with the side to be recorded on facing you.**
Wind past the leader of the tape, on which recording cannot be performed.
- 3 Press the II button.**
- 4 Press the ● button, which also engages the ► button.**
- 5 Press the II button again to begin recording.**

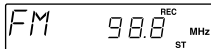

To stop recording:

Press the ■▲ button.

Note:

If you hear a whistling noise while recording an AM station, move the AM loop antenna.

■ Erasing a recorded tape

1. Load the tape to be erased into the cassette compartment with the side to be erased facing toward you.
2. Press the FUNCTION button until "TAPE" appears on the display.
3. Press the ● button which also engages the ► button to begin erasing.

Erase-prevention tabs of cassette tapes:

- When recording on a cassette tape, make sure that the erase-prevention tabs are not removed. Cassettes have removable tabs that prevent accidental recording or erasing.

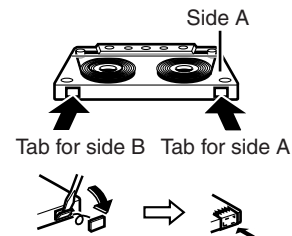

- To protect the recorded sound, remove the tab after recording. Cover the tab hole with the adhesive tape to record on the tape without the tab.

Timer and sleep operation

This may be operated only with the remote control.

Timer playback:

The unit turns on and plays the desired source (CD, tuner) at the preset time.

Sleep operation:

The radio and compact disc can all be turned off automatically.

Note:

The timer and sleep operations are not available during the tape mode.

Before setting timer:

- 1 Press the **CLOCK** button to check that the clock is set to the correct time.
- 2 Load a disc to be played.

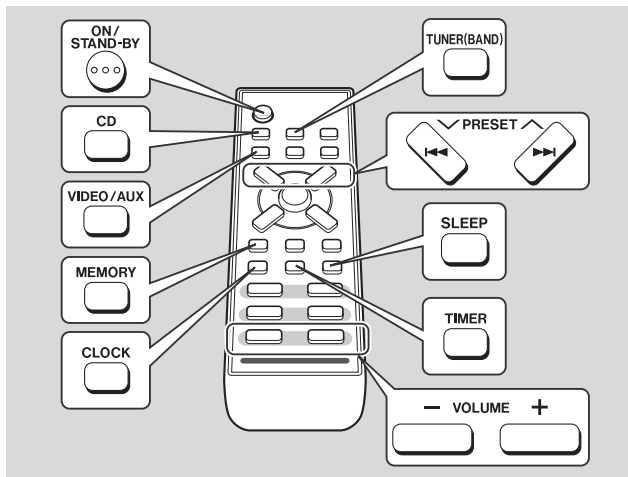
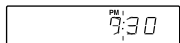

■ Timer playback

1 Press the ON/STAND-BY button to turn the power on.

2 Press the CD or TUNER (BAND) button to select the desired function.

If you select TUNER (BAND), tune in to the desired station.

3 Adjust the volume using the VOLUME buttons.

Do not turn the volume up too high.

4 Press the TIMER button and within 6 seconds, press the MEMORY button.

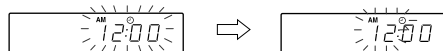

5 Within 1 minute, press the PRESET (∨ or ∧) button to specify the hour to start, then press the MEMORY button.



6 Within 1 minute, press the PRESET (∨ or ∧) button to specify the minutes to start, then press the MEMORY button.

- The timer playback starting time, function, and volume will be displayed, and then the unit will enter the stand-by mode automatically.
- "⊙" will light up and the current time will be displayed.



To cancel the timer playback:

Press the ON/STAND-BY button to turn the power on.

Continued to the next page

Timer and sleep operation (continued)

7 When the preset time is reached, playback will start.

The volume will increase gradually until it reaches the volume you were listening at before your system enters the timer stand-by mode.

8 The unit will enter the stand-by mode one hour after the timer playback starts. However, when CD playing time is one hour or less, it will enter the stand-by mode after completing playback.

To reset or change the timer setting:

Perform "Timer playback" from the beginning.

■ Sleep operation

1 Play back the desired sound source.

2 Press the SLEEP button.



To change the sleep time:

Press the SLEEP button repeatedly to select the desired sleep time. The time will decrease as follows.

The amount of sleep time can also be changed while in the sleep mode.

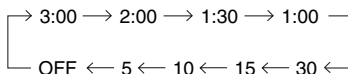

3 Your system will enter the power stand-by mode automatically after the preset time has elapsed.

The volume will be turned down 1 minute before the sleep operation finishes.

To cancel the sleep operation:

Press the ON/STAND-BY button while "SLEEP" is indicated. To cancel the sleep operation without setting the system to the stand-by mode, press the SLEEP button until "OFF" appears on the display.

To confirm the remaining sleep time:

Press the SLEEP button once while the sleep timer is set. The remaining sleep time is displayed for about 5 seconds.

■ To use timer and sleep operation together

Example: To fall asleep and wake up to the same radio station You can play back the same source only (the function cannot be switched).

1 Set the sleep time (steps 1 - 2, page 24).

2 While the sleep timer is set, set the timer playback start time (steps 4 - 6, page 23).

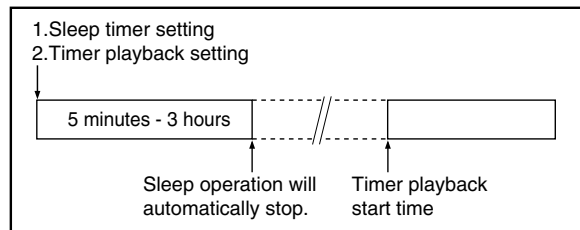

Enhancing your system

The connection cord is not included. Purchase a commercially available cord as shown below.

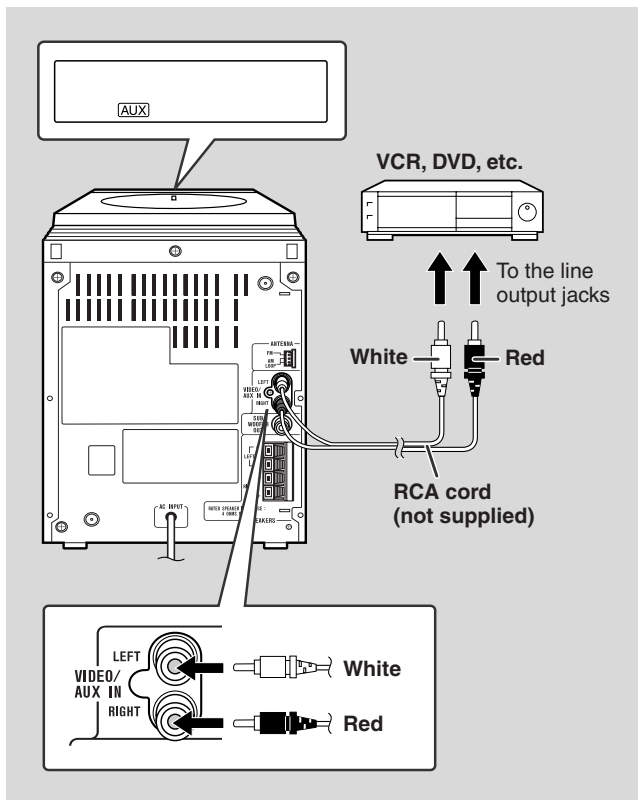

■ Listening to the playback sounds from VCR, DVD, etc.

- 1 Use a connection cord to connect the VCR, DVD, etc. to the VIDEO/AUX IN jacks.

When using video equipment, connect the audio output to this unit and the video output to a television.

- 2 Press the ON/STAND-BY button to turn the power on.

- 3 Press the FUNCTION button until "AUX" appears on the display.

When operating with the remote control, press the VIDEO/AUX button.

- 4 Play the connected equipment.

Note:

To prevent noise interference, place this unit away from a television.

■ To record on a tape

- 1 Insert a cassette in the cassette compartment.

- 2 Press the FUNCTION button until "AUX" appears on the display.

When operating with the remote control, press the VIDEO/AUX button.

- 3 Press the II button.

- 4 Press the ● button, which also engages the ► button.

- 5 Press the II button again to cancel the pause mode.

- 6 Play the VCR, DVD, etc.

Enhancing your system (continued)

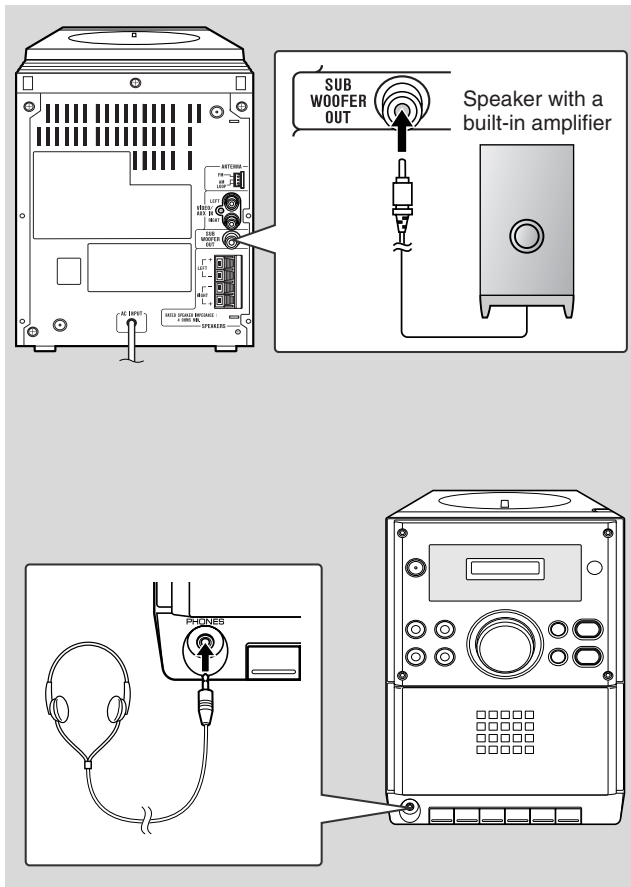

■ Subwoofer connection

When a commercially available speaker with a built-in amplifier is connected to this unit, you can enjoy sound with emphasized bass. Connect an RCA cord from a commercially available speaker with a built-in amplifier to the SUBWOOFER OUT jack.

■ Headphones

- Before plugging in or unplugging the headphones, reduce the volume.
- Be sure your headphones have a 1/8" (3.5 mm) diameter plug and are between 16 ohms and 50 ohms impedance. The recommended impedance is 32 ohms.
- Plugging in the headphones disconnects the speakers automatically. Adjust the volume using the VOLUME control.

Troubleshooting chart

Many potential problems can be resolved by the owner without calling a service technician.

If something is wrong with this product, check the following before calling your authorized SHARP dealer or service center.

■ General

Symptom	Possible cause
The clock is not set to the correct time.	<ul style="list-style-type: none"> ● Did a power failure occur? Reset the clock (refer to page 13).
When a button is pressed, the unit does not respond.	<ul style="list-style-type: none"> ● Set this unit to the power stand-by mode and then turn it back on. ● If the unit still malfunctions, reset it. (Refer to page 28.)
No sound is heard.	<ul style="list-style-type: none"> ● Is the volume level set to "0"? ● Are the headphones connected? ● Are the speaker wires disconnected?

■ CD player

Playback does not start.	<ul style="list-style-type: none"> ● Is the disc loaded upside down?
Playback stops in the middle or is not performed properly.	<ul style="list-style-type: none"> ● Does the disc satisfy the standards? ● Is the disc distorted or scratched?
Playback sounds are skipped, or stopped in the middle of a track.	<ul style="list-style-type: none"> ● Is the unit located near excessive vibrations? ● Is the disc very dirty? ● Has condensation formed inside the unit?

■ Tuner

The radio makes unusual noises continuously.	<ul style="list-style-type: none"> ● Is the unit placed near the TV or computer? ● Is the FM/AM loop antenna placed properly? Move the antenna away from the AC power cord if located nearby.
--	---

■ Cassette deck

Cannot record.	<ul style="list-style-type: none"> ● Is the erase-prevention tab removed?
Cannot record tracks with proper sound quality.	<ul style="list-style-type: none"> ● Is it a normal tape? (You cannot record on a metal or CrO₂ tape.)
Cannot erase completely.	
Sound skipping.	<ul style="list-style-type: none"> ● Is there any slack?
Cannot hear treble.	<ul style="list-style-type: none"> ● Is the tape stretched?
Sound fluctuation.	<ul style="list-style-type: none"> ● Are the capstan, pinch roller, or heads dirty?

■ Remote control

The remote control does not operate.	<ul style="list-style-type: none"> ● Is the AC power cord of the unit plugged in? ● Is the battery polarity correct? ● Are the batteries dead? ● Is the distance or angle incorrect? ● Does the remote control sensor receive strong light?
--------------------------------------	--

Troubleshooting chart (continued)

■ If trouble occurs

When this product is subjected to strong external interference (mechanical shock, excessive static electricity, abnormal supply voltage due to lightning, etc.) or if it is operated incorrectly, it may malfunction.

If such a problem occurs, do the following:

- 1 Set the unit to the stand-by mode and turn the power on again.
- 2 If the unit is not restored in the previous operation, unplug and plug in the unit, and then turn the power on.

Note:

If neither operation above restores the unit, clear all the memory by resetting it.

■ Clearing all the memory (reset)

- 1 Press the ON/STAND-BY button to enter the power stand-by mode.
- 2 While pressing down the MEMORY/SET button and the CLEAR button, press the ON/STAND-BY button until "CL" appears.



Caution:

This operation will erase all data stored in memory including clock, timer settings, tuner preset, and CD program.

■ Condensation

Sudden temperature changes, storage or operation in an extremely humid environment may cause condensation inside the cabinet (CD pickup, tape heads, etc.) or on the transmitter on the remote control. Condensation can cause the unit to malfunction. If this happens, leave the power on with no disc (or cassette) in the unit until normal playback is possible (about 1 hour). Wipe off any condensation on the transmitter with a soft cloth before operating the unit.

■ Cleaning the CD pickup lens

Do not touch the laser pickup lens. If fingerprints or dust accumulate on the pickup, clean it gently with a dry cotton swab.



■ Cleaning the cabinet

Periodically wipe the cabinet with a soft cloth and a diluted soap solution, then with a dry cloth.

Caution:

- Do not use chemicals for cleaning (gasoline, paint thinner, etc.). It may damage the cabinet finish.
- Do not apply oil to the inside of the unit. It may cause malfunctions.

■ Cleaning the tape-handling parts

- Dirty heads, capstan or pinch roller can cause poor sound and tape jams. Clean these parts with a cotton swab moistened with commercial head/pinch roller cleaner or isopropyl alcohol.
- When cleaning the heads, pinch roller, etc., unplug the unit which contains high voltages.

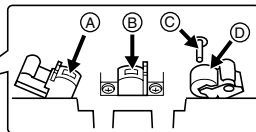

- A Erase head
- B Recording/Playback head
- C Capstan
- D Pinch roller

- After long use, the deck's heads and capstan may become magnetized, causing poor sound. Demagnetize these parts once every 30 hours of playing/recording time by using a commercial tape head demagnetizer. Read the demagnetizer's instructions carefully before use.

■ Care of compact discs

Compact discs are fairly resistant to damage, however mistracking can occur due to an accumulation of dirt on the disc surface. Follow the guidelines below for maximum enjoyment from your CD collection and player.

- Do not write on either side of the disc, particularly the non-label side from which signals are read. Do not mark this surface.
- Keep your discs away from direct sunlight, heat, and excessive moisture.
- Always hold the CDs by the edges. Fingerprints, dirt, or water on the CDs can cause noise or mistracking. If a CD is dirty or does not play properly, clean it with a soft, dry cloth, wiping straight out from the center, along the radius.

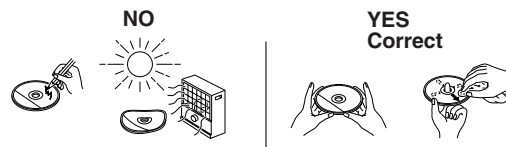

Specifications

As part of our policy of continuous improvement, SHARP reserves the right to make design and specification changes for product improvement without prior notice. The performance specification figures indicated are nominal values of production units. There may be some deviations from these values in individual units.

■ General

Power source	AC 120 V, 60 Hz
Power consumption	28 W
Dimensions	Width: 6-5/16" (160 mm) Height: 9-1/2" (242 mm) Depth: 9-7/8" (250 mm)
Weight	5.1 lbs. (2.3 kg)

■ Amplifier

Output power	5 watts minimum RMS per channel into 4 ohms from 100 Hz to 15 kHz, 10% total harmonic distortion
Output terminals	Speakers: 4 ohms Headphones: 16 - 50 ohms (recommended: 32 ohms) Subwoofer pre-out (audio signal): 500 mV/47 k ohms
Input terminals	Video/Auxiliary (audio signal): 500 mV/47 k ohms

■ Tuner

Frequency range	FM: 87.5 - 108.0 MHz AM: 530 - 1,720 kHz
------------------------	---

■ CD player

Type	Compact disc player
Signal readout	Non-contact, 3-beam semiconductor laser pickup
D/A converter	1-bit D/A converter
Frequency response	20 - 20,000 Hz
Dynamic range	90 dB (1 kHz)

■ Cassette deck

Frequency response	125 - 8,000 Hz (normal tape)
Signal/noise ratio	50 dB (recording/playback)
Wow and flutter	0.3 % (WRMS)

■ Speaker

Type	4" (10 cm) full-range speaker (magnetically shielded)
Maximum input power	10 W
Rated input power	5 W
Impedance	4 ohms
Dimensions	Width: 5-1/8" (130 mm) Height: 9-7/16" (240 mm) Depth: 6-5/16" (161 mm)
Weight	3.3 lbs. (1.5 kg)/each

CONSUMER LIMITED WARRANTY

SHARP ELECTRONICS CORPORATION warrants to the first consumer purchaser that this Sharp brand product (the "Product"), when shipped in its original container, will be free from defective workmanship and materials, and agrees that it will, at its option, either repair the defect or replace the defective Product or part thereof with a new or remanufactured equivalent at no charge to the purchaser for parts or labor for the period(s) set forth below.

This warranty does not apply to any appearance items of the Product nor to the additional excluded item(s) set forth below nor to any Product the exterior of which has been damaged or defaced, which has been subjected to improper voltage or other misuse, abnormal service or handling, or which has been altered or modified in design or construction.

In order to enforce the rights under this limited warranty, the purchaser should follow the steps set forth below and provide proof of purchase to the servicer.

The limited warranty described herein is in addition to whatever implied warranties may be granted to purchasers by law. ALL IMPLIED WARRANTIES INCLUDING THE WARRANTIES OF MERCHANTABILITY AND FITNESS FOR USE ARE LIMITED TO THE PERIOD(S) FROM THE DATE OF PURCHASE SET FORTH BELOW. Some states do not allow limitations on how long an implied warranty lasts, so the above limitation may not apply to you.

Neither the sales personnel of the seller nor any other person is authorized to make any warranties other than those described herein, or to extend the duration of any warranties beyond the time period described herein on behalf of Sharp.

The warranties described herein shall be the sole and exclusive warranties granted by Sharp and shall be the sole and exclusive remedy available to the purchaser. Correction of defects, in the manner and for the period of time described herein, shall constitute complete fulfillment of all liabilities and responsibilities of Sharp to the purchaser with respect to the Product, and shall constitute full satisfaction of all claims, whether based on contract, negligence, strict liability or otherwise. In no event shall Sharp be liable, or in any way responsible, for any damages or defects in the Product which were caused by repairs or attempted repairs performed by anyone other than an authorized servicer. Nor shall Sharp be liable or in any way responsible for any incidental or consequential economic or property damage. Some states do not allow the exclusion of incidental or consequential damages, so the above exclusion may not apply to you.

THIS WARRANTY GIVES YOU SPECIFIC LEGAL RIGHTS. YOU MAY ALSO HAVE OTHER RIGHTS WHICH VARY FROM STATE TO STATE.

Model Specific Section

Your Product Model Number & Description:

XL-S10 Micro Component System

(Be sure to have this information available when you need service for your Product.)

Warranty Period for this Product:

One (1) year parts and labor from the date of purchase.

Additional Item(s) Excluded from Warranty Coverage (if any):

Non-functional accessories, supplies, and consumable items.

Where to Obtain Service:

At a Sharp Authorized Servicer located in the United States.

To find a location of the nearest Sharp Authorized Servicer, call Sharp toll free at 1-800-BE-SHARP.

What to do to Obtain Service:

Ship prepaid or carry in your Product to a Sharp Authorized Servicer.

Be sure to have **Proof of Purchase** available. If you ship the Product, be sure it is insured and packaged securely.

TO OBTAIN SUPPLY, ACCESSORY OR PRODUCT INFORMATION, CALL **1-800-BE-SHARP**.

SHARP

SHARP ELECTRONICS CORPORATION

Sharp Plaza, Mahwah, New Jersey 07430-2135

SHARP CORPORATION

Printed in China
TINSEA018SJZZ
03M NYT ①

Free Manuals Download Website

<http://myh66.com>

<http://usermanuals.us>

<http://www.somanuals.com>

<http://www.4manuals.cc>

<http://www.manual-lib.com>

<http://www.404manual.com>

<http://www.luxmanual.com>

<http://aubethermostatmanual.com>

Golf course search by state

<http://golfingnear.com>

Email search by domain

<http://emailbydomain.com>

Auto manuals search

<http://auto.somanuals.com>

TV manuals search

<http://tv.somanuals.com>