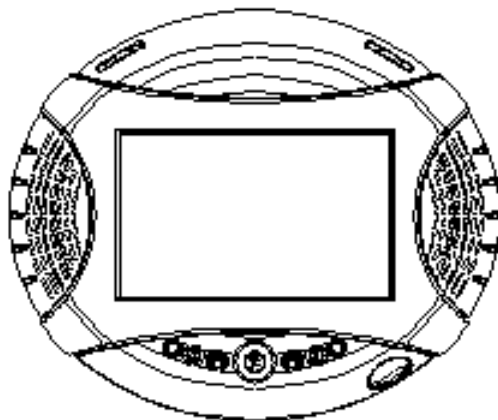




**AUDIOVOX®**  
**ELECTRONICS CORP.**



---

# D1420/D1420HP

**PORTABLE 4.2" LCD MONITOR AND DVD PLAYER IN A BAG**

---



For Customer Service  
Visit Our Website At  
[www.audiovox.com](http://www.audiovox.com)  
Product Information, Photos  
FAQs Owner's Manual

128-7397

# Content

A. Introduction .....	3
B. Cautions and Warnings .....	4
C. Package Contents .....	7
D. Features .....	7
E. Powering and Installation .....	7
F. Using the DVD Player Travel Bag .....	9
G. Controls and Indicators .....	10
H. Control Functions .....	11
I. Loading and Playing a Disc .....	11
J. Using the Joystick to Navigate the Setup Menu .....	11
K. Setup.....	11
L. Menu .....	16
M. Playing Audio CDS .....	16
N. Playing MP3 Discs .....	16
O. Playing JPEG files .....	17
P. Input and Output Connections .....	18
Q. Specifications .....	19
Warranty .....	20

An LCD panel and/or video monitor may be installed in a motor vehicle and visible to the driver if the LCD panel or video monitor is used for vehicle information, system control, rear or side observation or navigation. If the LCD panel or video monitor is used for television reception, video or DVD play, the LCD panel or video monitor must be installed so that these features will only function when the vehicle is in “park” or when the vehicle’s parking brake is applied.

An LCD panel or video monitor used for television reception, video or DVD play that operates when the vehicle is in gear or when the parking brake is not applied must be installed to the rear of the driver’s seat where it will not be visible, directly or indirectly, to the operator of the motor vehicle.

**Notice:**

This Product incorporates copyright protection technology that is protected by method claims of certain U.S. Patents and other intellectual property rights owned by Macrovision Corporation and other rights owners. Use of this copyright protection technology must be authorized by Macrovision Corporation, and is intended for home and other limited viewing uses only unless otherwise authorized by Macrovision Corporation. Reverse engineering or disassembly is prohibited.

**A. Introduction**

Thank you for choosing the D1420/D1420HP 4.2” Personal DVD player. The main features of this unit include a 4.2” Screen (16:9 aspect ratio) Liquid Crystal Display (LCD) monitor and a DVD player. Please read the entire instruction manual supplied with the unit prior to use. The documentation will assist you in operating the system properly to obtain the best equipment performance. Please save this manual for later use.

## **B. Cautions and Warnings**

**Follow Instructions** -- Follow all operating and maintenance instructions and adhere to all warnings.

**Cleaning** -- Unplug this product from the wall outlet before cleaning. Do not use liquid or aerosol cleaners.

**Accessories** -- Do not use accessories not recommended in this instruction book as they may be hazardous.

**Water and Moisture** -- Hazard of electric shock. Do not use this product near water or moist environments.

**Objects and Liquid** -- Never allow objects of any kind or liquids to be pushed or spilled into this product through various openings. Do not place objects filled with liquids on the unit.

**Condensation** -- Moisture will form in the operating section of the player if the player is brought from a cold environment into a warm environment. When this occurs, the player may not operate. To prevent this condition, let the player stand in its new surroundings for about an hour before switching it on.

**Power Cord Protection** -- Route the power cord so that it is not likely to be walked on or pinched by items placed upon or against them. Pay particular attention to the plug and the point where the cord exits the unit.

**Lightning** -- For added protection of this product during a lightning storm, or when it is left unattended and unused for long periods of time, disconnect it from the wall outlet. This will prevent damage to the product due to lightning and power-line surges.

**Overloading** -- Do not overload wall outlets and extension cords as this can result in risk of fire or electric shock.

**Servicing** -- Do not service this product yourself. Opening or removing covers may expose you to dangerous voltage or other hazards. Refer all servicing to qualified service personnel.

**Damage Requiring Service** -- Disconnect this product from the wall outlet and all power sources including batteries, and refer servicing to qualified service personnel under the following conditions:

- a) When the power cord or plug is damaged.
- b) If any liquid has been spilled onto, or objects have fallen into the product.
- c) If the unit does not operate normally even if you follow the operating instructions.
- d) If the unit has been dropped or the case has been damaged.

**Replacement Parts** -- When replacement parts are required, be sure the service technician has used replacement parts that are specified or that have the same characteristics as the original part. Unauthorized substitutions may result in fire, electric shock, or other hazards.

**Safety Check** -- Upon completion of any service or repairs to this product, ask the service technician to perform safety checks to ensure that the product is in safe operating order.

**Ventilation** --To ensure proper ventilation and proper operation, never cover the unit with a cloth or other material.

**Headphones** --Adjust the volume of the DVD player to a comfortable level when using headphones to prevent damage to hearing.

## **Warning**

A DVD player is a Class 1 laser product. This unit uses a visible laser beam, which could cause hazardous radiation exposure, if the safety interlocks are defeated.

Be sure to operate the unit correctly as instructed.

The following caution label is located on the rear panel of the player.



- Use of controls or adjustments or performance of procedures other than those specified herein may result in hazardous radiation exposure.
- Never use this device while driving.
- If the unit is being used by a passenger in your vehicle, be sure that it does not cause distraction to the driver, is secured or held safely, and does not obstruct any safety device (e.g.: airbag, seat belt, etc.)

**Note:** Both the DVD player and discs are coded by region. These region codes must match in order for the disc to play. If the codes do not match, the disc won't play. This unit's region code is 1. DVD's with other region codes cannot be played in this unit.

### **C. Package Contents**

- 1 x 4.2" LCD Monitor & DVD Player
  - 1 x AC to DC Adapter
  - 1 x Owner's Manual
  - 1 x AV Adapter Cable
  - 1 x Carry Bag
  - 1 x DC Power Adapter
  - 1 x Headphones\* P/N 1363688
- \*Supplied only with Model Number D1420HP

### **D. Features**

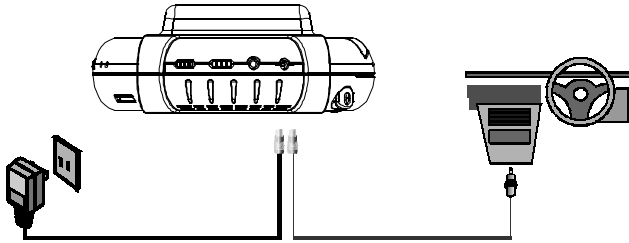
- Compact and Portable
- Multi-function controls
- Stand for desktop use
- High resolution picture
- Built-in Rechargeable battery (Ni-MH)

### **E. Powering and Charging**

#### ***1. Using the Adapter (Figure 1)***

Plug one end of the AC to DC adapter into the DC 9V jack on the right side of the unit, and plug the other end into a 120V AC power outlet. Then, slide the ON/OFF switch to ON position.

When in a vehicle, plug one end of the DC power adapter into the DC 9V jack and the other end into the vehicle power socket.



**Figure 1**

### **Using the battery**

Remove the AC adapter. Switch the ON/OFF switch to the ON position. If the battery is charged, it will power the unit.

## **2. Charging**

A built-in rechargeable battery (Ni-MH) is included for portable use. A fully charged battery will provide about 2 hours of playtime.

**Note:** Charge the battery for at least 8 hours before you use it for the first time.

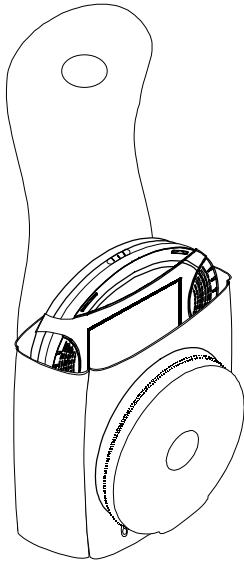
- 1) Switch the ON/OFF switch to the OFF position.
- 2) Connect one end of the AC adapter to the DC jack and the other end to a 120VAC standard wall outlet. The red charge indicator will light. Once the battery is fully recharged, the red light will turn off.
- 3) Disconnect the AC adapter.

**Note:** It takes about 5 hours to charge the battery after its initial charging.

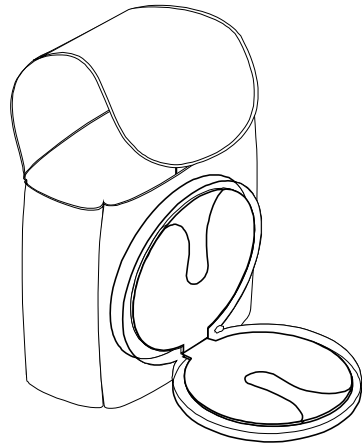


## F. Using the DVD Player Travel Bag

1. Place the unit into the bag as shown in Figure 2. Close the cover on the bag. Connect the nylon carrying strap to the bag.
2. The front of the bag contains plastic pouches for discs as shown in Figure 3.

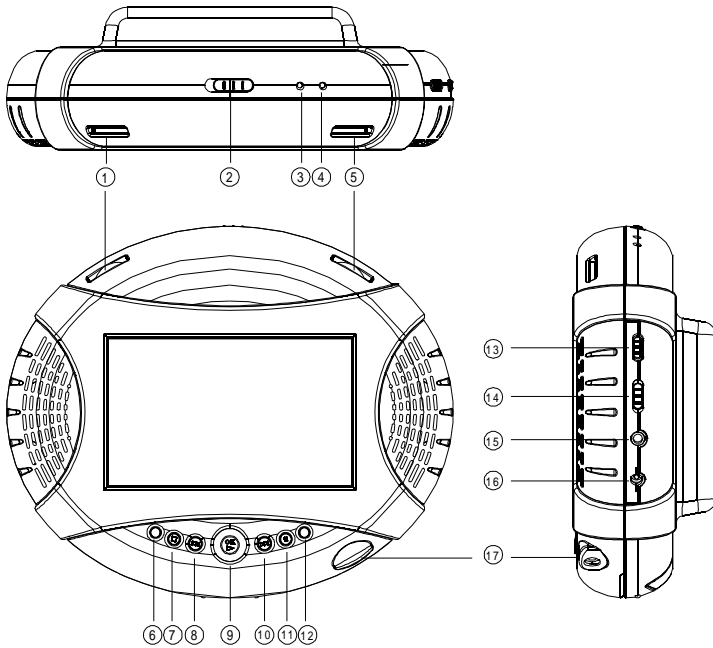


**Figure 2**



**Figure 3**

**G. Controls and Indicators (Figure 4)**



**Figure 4**

- |  |                         |
|--|-------------------------|
| 1) Brightness Control                          | 10) NEXT Button         |
| 2) OPEN Latch                                  | 11) PAUSE Button        |
| 3) POWER Indicator                             | 12) MENU Button         |
| 4) CHARGE Indicator                            | 13) Power ON/OFF Switch |
| 5) VOLUME Control                              | 14) AV IN/OUT Switch    |
| 6) SETUP Button                                | 15) A/V In/Out Jack     |
| 7) STOP Button                                 | 16) DC 9V Input Jack    |
| 8) PREVIOUS Button                             | 17) Headphone Jack      |
| 9) PLAY/OK/UP/DOWN/LEFT/RIGHT Joystick Control |                         |

## H. Control Functions

POWER	Turns the unit on or off.
OPEN	Opens the DVD player disc tray to load or remove the disc.
PLAY/OK	Begin playback or confirm a selected setting.
PAUSE	Pause playback.
NEXT	Go to the next chapter, track, or scene during playback.
PREVIOUS	Go back to the previous chapter, track, or scene during playback.
LEFT/RIGHT/UP/DOWN	Provides navigation through the menus.
OK	Select item or confirm setting.
MENU	Displays the root menu of a disc.
SETUP	Display the setup menu to select and set items. Also used to exit the setup menu.

## I. Loading and Playing a Disc

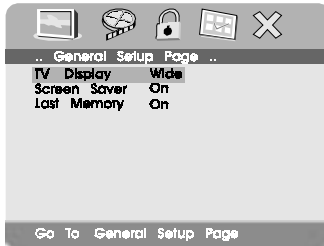
1. After connecting power to the unit, turn the DVD player on by sliding the Power switch to the ON position. The power indicator will light.
2. Open the disc tray by sliding the OPEN latch in the direction of the arrow, and place a disc onto the hub with the label side facing up.
3. Close the tray. The unit will load the disc and start playing.
4. Adjust the BRIGHTNESS and VOLUME controls to the desired levels.
5. When the DVD menu is displayed, use the joystick to start the movie (press down on the joystick (OK/←)).

## J. Using the Joystick to Navigate the Setup Menu

1. Press the Setup button.
2. Press the joystick Left/Right to select the desired menu page.
3. Press the joystick down to enter the selected page.
4. Press the joystick Up/Down to select from the various categories.
5. Press the joystick right to enter the submenu of the selected category.
6. Press the joystick Up/Down to select the desired setting and press the joystick to confirm the selected setting.
7. Press the joystick left to return to the current menu page. Press left twice to return to the main setup menu.

## K. Setup

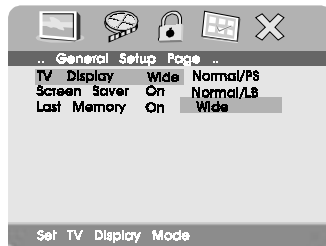
Press SETUP to display the main screen of the Setup Menu on the screen. Press SETUP again to exit the Setup Menu, and the unit will resume its last playback mode.



**Main Setup Menu Screen**

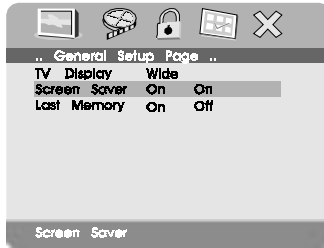
Note: To use some of the setup menu features, the unit must be in the STOP mode.

- 1) Press SETUP. The General Setup Page will be displayed on the screen.
  - a) Select TV Display using the UP/DOWN joystick, and then press RIGHT to enter the sub menu. Select the TV display mode on the screen using UP/DOWN, and press ENTER to confirm the setting. Press LEFT to return.
    - Normal/PS: When the player is connected to a normal TV, a wide picture appears on the full screen.
    - Normal/LB: When the player is connected to a normal TV, a wide picture appears on the screen with a black strip at both the top and bottom of the screen.
    - Wide: When the player is connected to a wide screen TV, a wide picture appears on the full screen.



**TV Display Screen**

b) Select Screen Saver mode on or off.



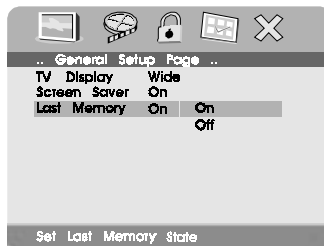
### Screen Saver Screen

On: Enables screen saver

Off: Disables screen saver

**Note:** The DVD player will enter the Screen Saver mode after approximately five minutes if the same image remains on the screen.

c) Select Last Memory mode On or Off.



### Last Memory Screen

On: The player will return to the last position on the disc.

Off: The player will not return to the last position on the disc.

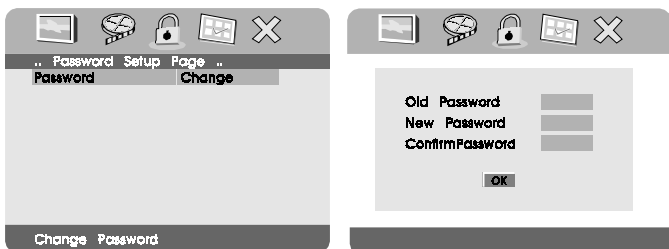
**Note:** The Last Memory function only works when power is on and the disc is not removed.

- 2) Select the Video Quality. Set Brightness, Contrast, Hue and saturation to the desired levels.



**Video Quality Setup Screen**

- 3) Select the Password setup page, then input the Old Password or the Default Password and New password as prompted on the screen.

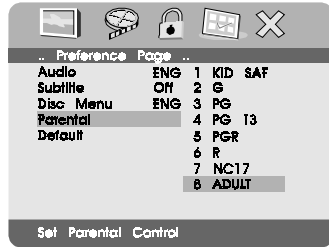


**Password Change Menu Screen**

**Note:**

The Default Password is Left, Left, Menu, Right. This password is always effective even after you have selected your own password and changed it. To avoid others using the default password to set the parental level and change the password, you can record this default password in other place and delete it from this manual. Some discs can be limited depending on the age of users while some discs cannot. The password can be changed to any sequence of the UP/DOWN/LEFT/RIGHT and MENU Buttons.

4) With no disc playing, select Preference to choose Audio language, Subtitle language, Disc Menu language, Parental level and Default setting.



## Preference setup

### Note:

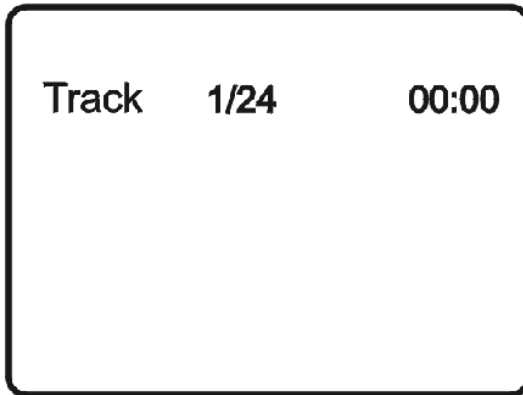
1. Language and subtitle selections are available only for discs that are recorded in the languages listed above. If the selected language is not available, the player will play and display on the screen the original language recorded in the disc.
2. The Parental setup levels are listed from the lowest level (1 Kid Safe) to the highest level (8 Adult). Enter a 4-button sequence ( Left, Left, Menu, Right) to change it and the level of 8 Adult is default setting.

## L. Menu

When you play a DVD, disc's main menu will appear on the screen of your TV or Monitor. The contents of the menu vary from disc to disc. Press MENU during playback to display the main menu. Some DVDs only allow you to select disc playback options using the DVD's main menu.

## M. Playing Audio CDs

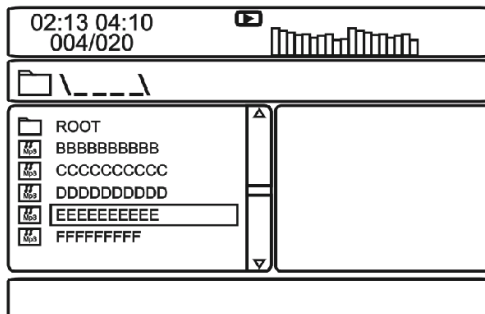
When playing an audio CD, the screen will display the elapsed playback time of the current track. Use Pause, Previous, and Next to navigate through the CD.



**CD Playing Screen**

## N. Playing MP3 Discs

CD-R /RW discs that have been encoded in MP3 format are compatible with this system. When you insert an MP3 Disc, the player will initialize the disc and the directory (folder) will be shown on the screen.







When an MP3 disc is inserted into the unit, the menu screen appears. Press the OK/PLAY button to begin playback. You can use the menu screen to change folders and songs. The system will play the songs in the order they were burned onto the disc.

1. Press the up or down button to choose a folder from the folder list on the left side of the screen.
2. Press OK to select the highlighted folder. The songs available under the folder will be listed.
3. Use the up and down buttons to choose a song from the list. Press OK to select and begin playback of the highlighted song.
4. Press NEXT to move to the next song. Press the PREVIOUS to move to the beginning of the previous song.

## NOTICE

-  icon in front of a file name indicates that this is a folder, not an MP3 file.
-  in front of a file name indicates that this is an MP3 file.

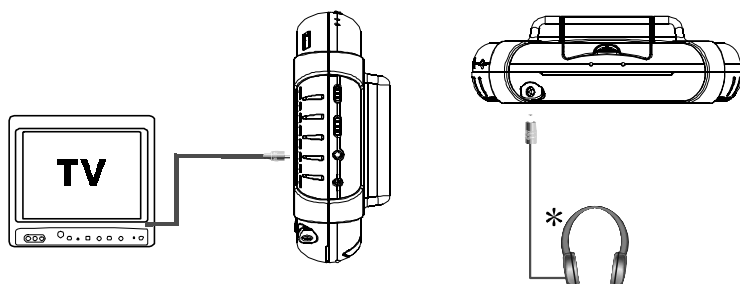
## O. Playing JPEG files

- 1) Load a JPEG Disc into the tray.
- 2) Select a JPEG file by pressing UP and DOWN.
- 3) You can preview the JPEG file by pressing PLAY or OK.
- 4) Press MENU to view the JPEG files. A menu will appear on the screen. Press PLAY to return.
- 5) Press PLAY, to play the JPEG file.

## P. Input and Output Connections

You can also connect the DVD player to a TV to enjoy high quality stereo audio and video on another monitor. To connect the DVD player to a monitor requires the purchase of an audio/video cable. The cable is readily available at most electronic retailers. The cable consists of three RCA jacks with the colors red and white corresponding to right and left audio channels and the yellow RCA connector is the video signal. The purchased cable can then be connected to the supplied AV adapter cable which then interfaces to the DVD player.

1. Connect one end of the audio/video adapter cable's black (1/8" stereo plug) plug into the unit's DVD AUDIO OUT jack, and connect the other end to the AUDIO INPUT jacks on your TV or Monitor (white = left channel, red = right channel).
2. Connect the audio/video adapter cable's yellow plug into the DVD VIDEO OUT jack on the back of the unit, and the other yellow plug to the VIDEO INPUT jack on your TV or Monitor.



**Note:** You may use wired headphones\* with the unit. Simply plug the headset into headphone jack on the bottom of the unit's screen.

\*Supplied only with model number D1420HP.

**Note:** Plugging the headphones into the headphone jack disables the internal speakers.

### Audio Video Input

When the IN/OUT switch is in the IN position, the unit can receive audio and video signals. You can connect the unit DVD player to a game/camcorder through the AV jack as described above..

Connect the AV Cable 3.5mm jack into the DVD AV jack. Then, connect the three color-corresponding plugs to the AV Output Jacks on your game/camcorder or other equipment.

## **Q. Specifications**

Compatible Discs: DVD/CD/MP3

Signal system: NTSC

Panel size: 4.2 inch

Resolution: 960 (RGB) x 234

Frequency response: 20 Hz to 20 kHz

Video output: 1 V<sub>p-p</sub>/75 Ohm, unbalanced

Audio output: 1.4V<sub>rms</sub>/10kOhm

Audio S/N: Better than 60 dB

Dynamic range: Better than 85 dB

Laser: Semiconductor Laser, Wave Length: 650 nm/795 nm

Power source: DC 9V

Power consumption: 9 W

Operating temperature: 41°~95°F (5~35°C)

Weight: 1.30lb (0.589kg)

Dimensions (W x D x H): 6.6 x 5.5 x 2.1inches (168 x 140 x 53.8mm)



**AUDIOVOX®**  
ELECTRONICS CORP.

## 90 DAY LIMITED WARRANTY

*Applies to Audiovox Video Products*

AUDIOVOX ELECTRONICS CORP. (the Company) warrants to the original retail purchaser of this product that should this product or any part thereof, under normal use and conditions, be proven defective in material or workmanship within 90 days from the date of original purchase, such defect(s) will be repaired or replaced with reconditioned product (at the Company's option) without charge for parts and repair labor.

To obtain repair or replacement within the terms of this Warranty, the product is to be delivered with proof of warranty coverage (e.g. dated bill of sale), specification of defect(s), transportation prepaid, to the Company at the address shown below.

This Warranty does not extend to the elimination of externally generated static or noise, to correction of antenna problems, to costs incurred for installation, removal or reinstallation of the product, or to damage to tapes, discs, speakers, accessories, or electrical systems.

This Warranty does not apply to any product or part thereof which, in the opinion of the Company, has suffered or been damaged through alteration, improper installation, mishandling, misuse, neglect, accident, or by removal or defacement of the factory serial number/bar code label(s). THE EXTENT OF THE COMPANY'S LIABILITY UNDER THIS WARRANTY IS LIMITED TO THE REPAIR OR REPLACEMENT PROVIDED ABOVE AND, IN NO EVENT, SHALL THE COMPANY'S LIABILITY EXCEED THE PURCHASE PRICE PAID BY PURCHASER FOR THE PRODUCT.

This Warranty is in lieu of all other express warranties or liabilities. ANY IMPLIED WARRANTIES, INCLUDING ANY IMPLIED WARRANTY OF MERCHANTABILITY, SHALL BE LIMITED TO THE DURATION OF THIS WRITTEN WARRANTY. ANY ACTION FOR BREACH OF ANY WARRANTY HEREUNDER INCLUDING ANY IMPLIED WARRANTY OF MERCHANTABILITY MUST BE BROUGHT WITHIN A PERIOD OF 30 MONTHS FROM DATE OF ORIGINAL PURCHASE. IN NO CASE SHALL THE COMPANY BE LIABLE FOR ANY CONSEQUENTIAL OR INCIDENTAL DAMAGES FOR BREACH OF THIS OR ANY OTHER WARRANTY, EXPRESS OR IMPLIED, WHATSOEVER. No person or representative is authorized to assume for the Company any liability other than expressed herein in connection with the sale of this product.

Some states do not allow limitations on how long an implied warranty lasts or the exclusion or limitation of incidental or consequential damage so the above limitations or exclusions may not apply to you. This Warranty gives you specific legal rights and you may also have other rights which vary from state to state.

**U.S.A. :** AUDIOVOX ELECTRONICS CORPORATION, 150 MARCUS BLVD.  
HAUPPAUGE, NEW YORK 11788 • 1-800-645-4994

**CANADA :** CALL 1-800-645-4994 FOR LOCATION OF WARRANTY STATION SERVING YOUR AREA

1285556E

## Free Manuals Download Website

<http://myh66.com>

<http://usermanuals.us>

<http://www.somanuals.com>

<http://www.4manuals.cc>

<http://www.manual-lib.com>

<http://www.404manual.com>

<http://www.luxmanual.com>

<http://aubethermostatmanual.com>

Golf course search by state

<http://golfingnear.com>

Email search by domain

<http://emailbydomain.com>

Auto manuals search

<http://auto.somanuals.com>

TV manuals search

<http://tv.somanuals.com>