



HEARTH PRODUCTS

RETAIN THESE INSTRUCTIONS
FOR FUTURE REFERENCE



OTL Report No. 116-F-36-5



⚠ WARNINGS

- **Hot! Do not touch!** The glass and surfaces of this appliance will be hot during operation and will retain heat for a while after shutting off the appliance. Severe burns may result.
- Carefully supervise children in the same room as appliance.



- If small children are present in the home, it is recommended that this appliance be fitted with a screen door or screen panel kit. See *Page 17* for ordering information.

WARNING: IF THE INFORMATION IN THIS MANUAL IS NOT FOLLOWED EXACTLY, A FIRE OR EXPLOSION MAY RESULT CAUSING PROPERTY DAMAGE, PERSONAL INJURY OR LOSS OF LIFE.

FOR YOUR SAFETY: Do not store or use gasoline or other flammables or liquids in the vicinity of this or any other appliance.

FOR YOUR SAFETY: What to do if you smell gas:

- **DO NOT** light any appliance.
- **DO NOT** touch any electrical switches.
- Do not use any phone in your building.
- Immediately call your gas supplier from a neighbor's phone. Follow your gas suppliers instructions.
- If your gas supplier cannot be reached, call the fire department.

Installation and service must be performed by a qualified installer, service agency or gas supplier.

HOMEOWNER'S CARE AND OPERATION INSTRUCTIONS

B-VENT MPB-33/35/40/45 SERIES

B-VENT GAS FIREPLACES

P/N 875,031M REV. A 02/2006

MODELS

Millivolt Models

MPB3328CNM	MPB3530CPM
MPB3328CPM	MPB4035CNM
MPB3530CNM	MPB4540CNM

Electronic Models

MPB3328CNE	MPB4035CNE
MPB3530CNE	MPB4540CNE

A French manual is available upon request. Order P/N 875,031CF

Ce manuel d'installation est disponible en francais, simplement en faire la demande. Numéro de la pièce 875,031CF.

AVERTISSEMENT: ASSUREZ-VOUS DE BIEN SUIVRE LES INSTRUCTIONS DONNÉ DANS CETTE NOTICE POUR RÉDUIRE AU MINIMUM LE RISQUE D'INCENDIE OU POUR ÉVITER TOUT DOMMAGE MATÉRIEL, TOUTE BLESSURE OU LA MORT.

POUR VOTRE SÉCURITÉ: Ne pas entreposer ni utiliser d'essence ni d'autre vapeurs ou liquides inflammables dans le voisinage de cet appareil ou de tout autre appareil.

POUR VOTRE SÉCURITÉ: Que faire si vous sentez une odeur de gaz:

- Ne pas tenter d'allumer d'appareil.
- Ne touchez à aucun interrupteur. Ne pas vous servir des téléphones se trouvant dans le bâtiment où vous vous trouvez.
- Evacuez la pièce, le bâtiment ou la zone.
- Appelez immédiatement votre fournisseur de gaz depuis un voisin. Suivez les instructions du fournisseur.
- Si vous ne pouvez rejoindre le fournisseur de gaz, appelez le service des incendies.

L'installation et service doit être exécuté par un qualifié installateur, agence de service ou le fournisseur de gaz.

CONGRATULATIONS!

In selecting this Lennox B-Vent Gas Appliance you have chosen the finest and most dependable fireplace to be found anywhere. A beautiful, prestigious, alternative to a wood burning fireplace. Welcome to a Family of tens of thousands of satisfied Lennox Fireplace Owners.

Please read and carefully follow all of the instructions found in this manual. Please pay special attention to the safety instructions provided in this manual. The Homeowner's Care and Operation Instructions included here will assure that you have many years of dependable and enjoyable service from your Lennox product.

TABLE OF CONTENTS

Introduction	Page 2
General Information	Page 2
Operation/Care of Your Appliance	Page 3
Variable Flame Adjustment.....	Page 4
Outside Combustion Air Control	Page 5
Manual Limit Switch	Page 5
Maintenance Schedule	Page 6
Maintenance.....	Page 7
Front Glass Enclosure Panel, Removal and Installation.....	Page 7
Burner Adjustments	Page 8
Millivolt Appliance Checkout	Page 8
Electronic Appliance Checkout	Page 8
Logs, Rockwool, Vermiculite & Volcanic Stone Placement.....	Page 9
Wiring Diagrams	Page 14
Warranty	Page 14
Replacement Parts	Page 14
Product Reference Information	Page 14
Accessory Components	Page 15
Lighting Instructions – Millivolt	Page 18
Lighting Instructions – Electronic	Page 20
Troubleshooting Guide – Millivolt	Page 22
Troubleshooting Guide – Electronic	Page 22
Replacement Parts List	Page 24

INTRODUCTION

The millivolt appliances are designed to operate on either natural or propane gas. A millivolt gas control valve with piezo ignition system provides safe, efficient operation. External electrical power is required to operate the optional electrically powered components, if installed. Electrical power must be wired during appliance installation.

The electronic appliances are designed to operate on either natural or propane gas. An electronic intermittent pilot system provides safe, efficient operation. External electrical power is required to operate these units.

These appliances comply with National Safety Standards and are tested and listed by OMNI-Test Laboratories, Inc. (Report No. 116-F-___) to ANSI Z21.50 (in Canada, CSA 2.22), and CAN/CGA-2.17-M91 in both USA and Canada, as vented gas fireplaces.

Installation must conform to local codes. In the absence of local codes, installation must comply with the current National Fuel Gas Code, ANSI Z223.1 (NFPA 54). (In Canada, the current CAN/CGA B149 installation code). Electrical wiring must comply with local codes. In the absence of local codes, installation must be in accordance with the National Electrical Code, NFPA 70 - (latest edition). (In Canada, the current CSA C22.1 Canadian Electric Code).

DO NOT ATTEMPT TO ALTER OR MODIFY THE CONSTRUCTION OF THE APPLIANCE OR ITS COMPONENTS. ANY MODIFICATION OR ALTERATION MAY VOID THE WARRANTY, CERTIFICATION AND LISTINGS OF THIS UNIT.

! WARNING

Improper installation, adjustment, alteration, service or maintenance can cause injury or property damage. Refer to this manual. For assistance or additional information consult a qualified installer, service agency or the gas supplier.

GENERAL INFORMATION

Note: Installation and repair should be performed by a qualified service person. The appliance should be inspected annually by a qualified professional service technician. More frequent inspections and cleanings may be required due to excessive lint from carpeting, bedding material, etc. It is imperative that the control compartment, burners and circulating air passage ways of the appliance be kept clean.

S'assurer que le brûleur et le compartiment des commandes sont propres. Voir les instructions d'installation et d'utilisation qui accompagnent l'appareil.

Provide adequate clearances around air openings and adequate accessibility clearance for service and proper operation. Never obstruct the front openings of the appliance.

Due to high temperatures the appliance should be located out of traffic and away from furniture and draperies. Locate furniture and window coverings accordingly.

! WARNING

These fireplaces are vented decorative gas appliances. Do not burn wood or other material in these appliances.

These appliances are designed to operate on natural or propane gas only.

Input of millivolt models is variable. These rates are shown in **Table 1**:

Millivolt Models with Manually-Modulated Gas Valve		
	Natural Gas	Propane Gas
Model	Input Rate (BTU/HR)	Input Rate (BTU/HR)
MPB3328	13,500 to 17,500	13,500 to 17,500
MPB3530	16,000 to 20,000	16,500 to 20,000
MPB4035	24,000 to 30,000	22,300 to 28,000
MPB4540	24,750 to 31,000	23,000 to 29,000

Table 1

Electronic Models -

Electronic models have a fixed rate gas valve. Input of electronic models is shown in **Table 2**:

Electronic Models with Fixed-Rate Gas Valve		
	Natural Gas	Propane Gas
Model	Input Rate (BTU/HR)	Input Rate (BTU/HR)
MPB3328	17,500	17,500
MPB3530	20,000	20,000
MPB4035	30,000	28,000
MPB4540	31,000	29,000

Table 2

Table 3 shows the units' orifice size for the elevations indicated.

Burner Orifice Sizes Elevation 0-4500 feet (0-1372 meters)		
Models	Natural Gas drill size (inches)	Propane Gas drill size (inches)
MPB-3328	#47 (.0785")	1.2mm (.048")
MPB-3530	#44 (.086")	#55 (.052")
MPB-4035	#37 (.104")	1/16" (.0625")
MPB-4540	#36 (.1065")	#52 (.0635")

Table 3

Maximum manifold pressure is 3.5 in. w.c. (0.87 kPa) for natural gas and 10 in. w.c. (2.49 kPa) for LP/Propane gas.

Do not use these appliances if any part has been under water. Immediately call a qualified, professional service technician to inspect the appliance and to replace any parts of the control system and any gas control which have been under water.

Ne pas se servir de cet appareil s'il a été plongé dans l'eau, complètement ou en partie. Appeler un technicien qualifié pour inspecter l'appareil et remplacer toute partie du système de contrôle et toute commande qui ont été plongés dans l'eau.

Test gauge connections are provided on the front of the millivolt gas control valve (identified OUT for the manifold side and IN for inlet pressure). A 1/8" NPT test gauge connection is provided on the electronic gas control valve adjacent to the outlet to the main burner.

Minimum inlet gas pressure to these appliances is 5.0 inches water column (1.24 kPa) for natural gas and 11 inches water column (2.74 kPa) for propane for the purpose of input adjustment.

Maximum inlet gas supply pressure to these appliances is 10.5 inches water column (2.61 kPa) for natural gas and 13.0 inches water column (3.23 kPa) for propane.

The appliance must be isolated from the gas supply piping system (by closing its individual manual shut-off valve) during any pressure testing of the gas supply piping system at test pressures equal to or less than 1/2 psig (3.5 kPa).

The appliance and its individual shut-off valve must be disconnected from the gas supply piping system during any pressure testing of that system at pressures in excess of 1/2 psig (3.5 kPa).

These appliances must not be connected to a chimney or flue serving a separate solid fuel burning appliance.

Any safety guard or screen removed for servicing the appliance must be replaced prior to operating the appliance.

! WARNING

B-Vent appliances are not designed to operate in negatively pressured environments (pressure within the home is less than pressures outside). Significant negatively pressured environments caused by weather, home design, or other devices may impact the operation of these appliances. Negative pressures may result in poor flame appearance, sooting, damage to property and/or severe personal injury. Do not operate these appliances in negatively pressured environments.

Carbon Monoxide Poisoning: Early signs of carbon monoxide poisoning are similar to the flu with headaches, dizziness and/or nausea. If you have these signs, obtain fresh air immediately. Turn off the gas supply to the appliance and have it serviced by a qualified professional, as it may not be operating correctly.

! WARNING

Failure to comply with the installation and operating instructions provided in this document will result in an improperly installed and operating appliance, voiding its warranty. Any change to this appliance and/or its operating controls is dangerous. Improper installation or use of this appliance can cause serious injury or death from fire, burns, explosion or carbon monoxide poisoning.

! WARNING

Children and adults should be alerted to the hazards of high surface temperatures. Use caution around the appliance to avoid burns or clothing ignition. Young children should be carefully supervised when they are in the same room as the appliance.

! WARNING

Do not place clothing or other flammable materials on or near this appliance.

! AVERTISSEMENT

Surveiller les enfants. Garder les vêtements, les meubles, l'essence ou autres liquides à vapeur inflammables loin de l'appareil.

OPERATION AND CARE OF YOUR APPLIANCE

Appliance operation may be controlled through a remotely located optional wall switch. Separate switches may provide independent control for the remote controlled fireplace operation (optional equipment).

In lieu of remote or remote wall switch operation, the appliance must be operated directly through the controls located on the front of the valve located within the control compartment which is located behind the control compartment access panel below the appliance front glass enclosure panel. See *Figure 1*.

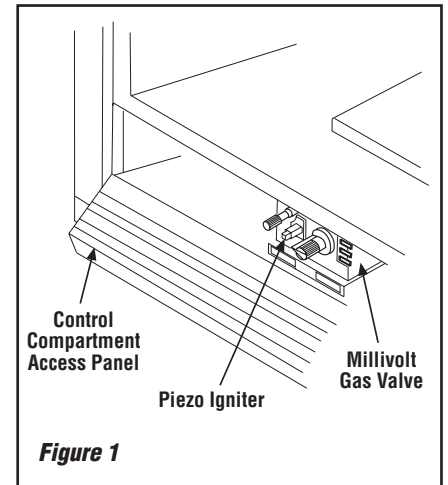

Gas Controls/Control Compartment Access

The gas controls can be found behind the control compartment access panel. To open the control compartment access panel, actuate the spring loaded magnetic catches securing the panel. First, gently depress the upper right top corner of the panel until the magnet catch "pops" the door free. Then, gently pulling the panel forward, disengage the left magnet catch and allow the panel to swing down to open.

Operation of millivolt and electronic gas control systems are different. Before lighting and operating your appliance determine if you have a millivolt or electronic appliance. See *Figure 1* for access to the control compartment.

Millivolt appliances will be fitted with the gas control valve shown in *Figure 3 on Page 4*.

Appliances with electronic systems will be fitted with the electronic valve shown in *Figure 2 on Page 4*.

Familiarize yourself with the gas control valve that your appliance uses.

Millivolt Appliances -

To light millivolt appliances refer to the detailed lighting instructions found on *Page 18 (English) and Page 19 (French)*. **Millivolt appliance lighting instructions may also be found on the pull-out lighting instruction labels attached to the gas control valve.** Refer to *Figure 3 on Page 4* for the location of the piezo igniter.

Millivolt appliances may be fitted with an optional burner ON/OFF Rocker Switch. The optional ON/OFF Rocker switch will be installed in the bracket just beneath the gas control valve. Once the pilot is lit, the ON/OFF rocker switch will control the appliance ON/OFF operation. To operate: Toggle the switch between its ON and OFF positions.

If your millivolt appliance is equipped with an optional remote wall switch or remote control kit and the pilot is lit, the appliance main burner may be turned on and off with the wall switch or remote control.

Electronic Appliances -

To light electronic appliances refer to the detailed lighting instructions found in both English and French on **Pages 20 and 21** of these instructions respectively. **Electronic appliance lighting instructions may also be found on the pull out lighting instruction labels attached to the gas control valve.** If your electronic appliance is equipped with an optional remote wall switch or remote control kit the appliance main burner may be turned on and off with the wall switch or remote control.

If your electronic appliance is not equipped with a wall switch or remote control, the main burner must be turned off and on with the gas control switch. Toggle the switch from ON to OFF to operate the main burner .

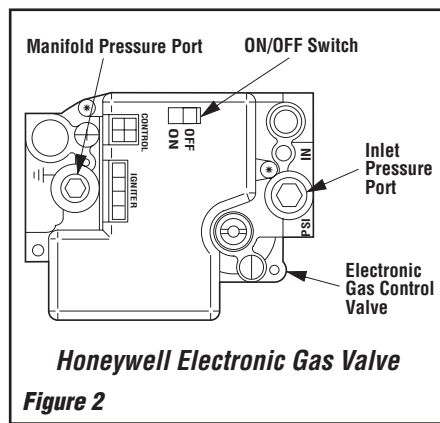

Honeywell Electronic Gas Valve

Figure 2

Variable Flame Height Adjustment (Millivolt Appliances only)

1. All Millivolt appliances are equipped with a variable gas control valve. Flame height for these models may be adjusted through a range between fixed low and high settings, alternately, while the appliance is in operation. Adjust the flame height as desired after lighting the appliance by rotating the variable adjustment control knob located on the front of the valve (*refer to Figure 3*).

2. When lit for the first time, this appliance will emit a slight odor for an hour or two. This is due to the “burn-in” of internal paints and lubricants used in the manufacturing process.

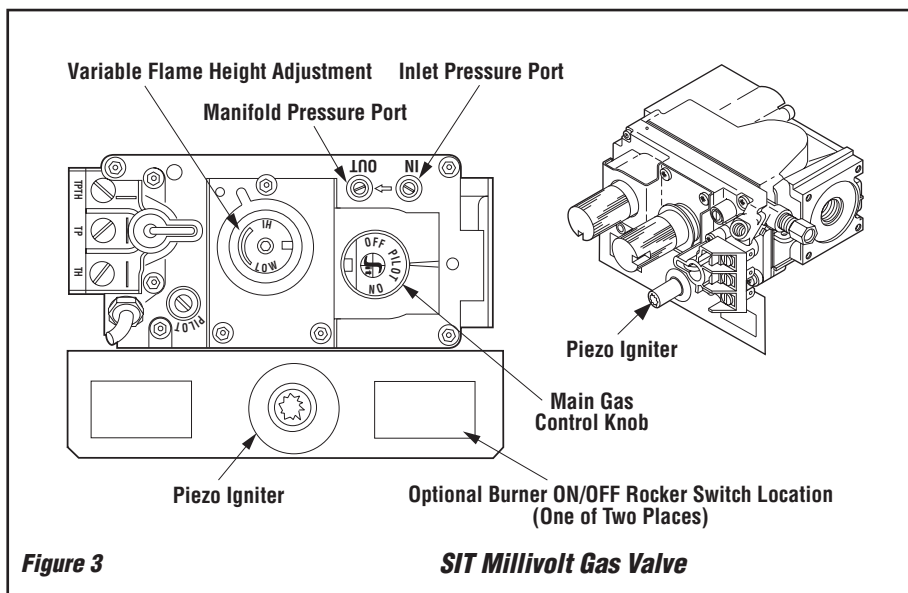

Figure 3

SIT Millivolt Gas Valve

3. Keep lower control compartment clean by vacuuming or brushing at least twice a year. More frequent cleaning may be required due to excessive lint from carpeting, bedding materials, etc. It is important that control compartments, burners and circulating air passageways of the appliance be kept clean.

4. Always turn off gas to the pilot (millivolt appliances) before cleaning. Before re-lighting, refer to the lighting instructions in this manual. Instructions are also found on a pull-out panel located on the floor of the appliance.

5. Always keep the appliance area clear and free from combustible materials, gasoline and other flammable liquids.

6. Remember, Millivolt appliances have a continuous burning pilot flame. Exercise caution when using products with combustible vapors.

7. Clean the front glass enclosure only when necessary. Wipe surface with clean, dampened, soft cloth. Follow with dry, soft towel as desired. Take care not to scratch the glass surface.

WARNING
Do not use abrasive cleaners. Never clean the glass when it is hot.

CAUTION
Do not attempt to touch the front enclosure glass with your hands while the fireplace is in use.

Outside Combustion Air Controls

Many appliances are equipped, when installed, with an outside (make-up air) vent system that is designed to provide the appliance with outside make-up air for combustion when in operation. The combustion air control lever for the outside air system is standard on all appliances but should not be operated if the complete system is not installed. Refer to **Figure 4**. When the complete outside air vent system is installed, the installer will remove the securing screw from the combustion air control lever located on the left side of the fireplace bottom opening.

If the securing screw has not been removed and you have reason to believe that you have a complete outside air system, contact your distributor to have your appliance inspected for the presence of the complete system. **DO NOT** assume that you have this system in place.

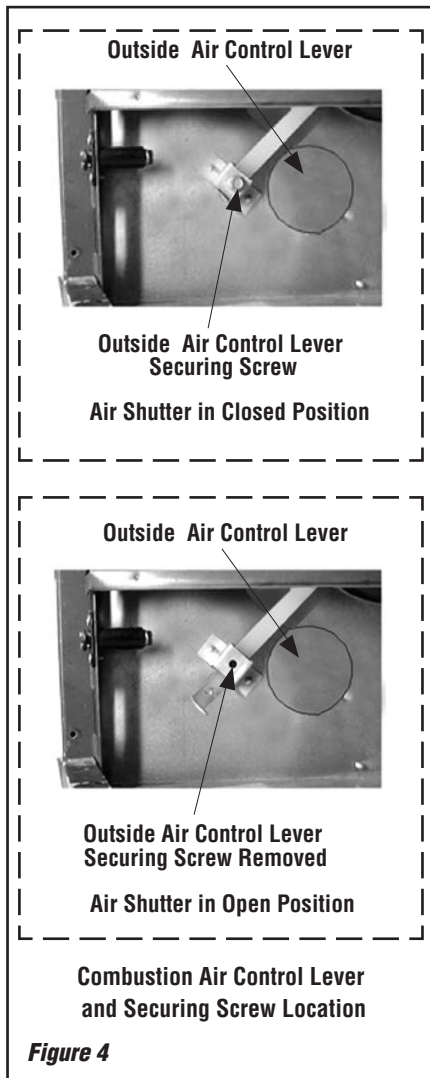

⚠ WARNING

Do not operate the shutoff lever unless a complete outside combustion air system has been installed with your appliance.

To open the outside air shutter, open the bottom control access panel, reach into control compartment and pull the combustion air control lever all the way out. The outside air shutter should be fully open when the fireplace is in use and completely closed when the fireplace is not being used. Closing it when not in use will prevent outside cold air from entering the dwelling.

Step 13. Spillage Test and Safety Limit Switch Operation

Spillage Test

After appliance installation, perform this spillage test to verify that proper venting conditions exist:

- 1 - Place unit in its normally-operated condition, that is, with the glass enclosure panel in place.
- 2 - Close all doors and windows in the room. Turn on all exhaust fans in the house.
- 3 - Light the appliance.
- 4 - Wait 15 minutes.
- 5 - To check for venting action, start by holding a smoke producing device within an inch of one edge (side edge, not top or bottom edge) of the glass enclosure panel. The smoke should be drawn toward the edge of the glass enclosure panel. Continue the test by moving the smoke producing device along the entire length of both side-edges of the glass door.
- 6 - **If the smoke is not drawn towards the edges of the glass door turn off the appliance and call a qualified service technician.**

Manually-Reset Safety Limit Switch

This appliance is equipped with a manually-reset blocked flue safety limit switch. Refer to **Figure 5 on Page 7** for its location. If, during appliance operation, the flame goes out (independently of the burner on/off wall switch), it may be due to the operation of this safety limit switch. **First allow the appliance to cool.** Remove top louver panel. Then reset the safety limit switch by pushing the red reset button, located between the wire terminals, on the back of the switch. See **Detail A of Figure 5** for location.

The appliance should then relight and remain lit. Reinstall top louver panel. If the appliance does not relight, **turn off the appliance and call for a qualified service technician.**

To replace the blocked flue safety limit switch refer to Figure 5 on Page 7 (Details B and C):

NOTE - This procedure should only be performed by a qualified service technician.

Important - Turn electrical power off before beginning this procedure.

- 1 - Lower the bottom control compartment access panel. Remove the glass enclosure panel: open the latch (located in the center of the unit front opening, under the firebox floor) securing the glass enclosure panel. Remove the panel by tilting it outward at the bottom and lifting it up. Set the door aside protecting it from inadvertent damage. See **Figure 6 on Page 7**.
- 2 - Remove the lintel securing screws (3) and then remove the lintel. One of the lintel cabinet top holes is shown in **Figure 5 (Detail B)**.
- 3 - Remove the scoop securing screws (3) and then remove the scoop. See **Figure 5 (Detail B)**.
- 4 - Remove the safety switch bracket securing screws (2), and pull the switch/bracket assembly, with low voltage wires attached, through the side panel slot into the firebox. See **Figure 5 (Detail C)**.
- 5 - Replace the switch.
- 6 - Reinstall the switch/bracket assembly.
- 7 - Reinstall the scoop and lintel.
- 8 - Reinstall the glass enclosure panel.
- 9 - Raise the bottom control compartment access panel.
- 10 - The appliance should then relight and remain lit. If this does not occur, check unit for a blocked flue condition.

MAINTENANCE SCHEDULE - Annually (Before the onset of the Burning Season)

MAINTENANCE TASK	ACCOMPLISHING PERSON	PROCEDURE
Inspecting/Cleaning Burner, Logs and Controls	Qualified Service Technician	Inspect valve and ensure it is properly operating. Check piping for leaks. Vacuum the control compartment, fireplace logs and burner area.
Check Flame Patterns and Flame Height	Qualified Service Technician	Refer to Figure 10 (MPB-3328) , Figure 11 (MPB-3530) or Figure 12 (MPB-4035 & MPB-4540) on Page 9 and verify the flame pattern and height displayed by the appliance conforms to the picture. Flames must not impinge on the logs.
Inspecting/Cleaning Pilot and Burner	Qualified Service Technician	Refer to Figure 8 or 9 on Page 8 . Remove any surface build-up on pilot and burner assembly. Wipe the pilot nozzles, igniter/ flame rod and hood. Ensure the pilot flame engulfs the flame sensor as shown.
Checking Vent System	Qualified Service Technician	Inspect the vent system at the top and at the base (within the firebox) for signs of blockage or obstruction. Look for any signs of dislocation or deterioration of the vent components.
Appliance Checkout	Qualified Service Technician	Perform the appropriate appliance checkout procedure detailed in this manual.
Replacing Rockwool Ember Materials	Homeowner/Qualified Service Technician	Remove old ember materials (rockwool) and vacuum the ember placement area. Place new embers as described on Pages 9-13 .

MAINTENANCE SCHEDULE - Periodically (After the Burning Season)

MAINTENANCE TASK	ACCOMPLISHING PERSON	PROCEDURE
Cleaning Firebox Interior	Homeowner	Carefully remove logs, embers (rockwool), and volcanic stone. Vacuum out interior of the firebox. Clean firebox walls. Replace logs, embers (rockwool) and volcanic stone as detailed in this manual (see Pages 9-13).
Check Flame Patterns and Flame Height	Homeowner	Refer to Figure 10 (MPB-3328) , Figure 11 (MPB-3530) or Figure 12 (MPB-4035 & MPB-4540) on Page 9 and verify the flame pattern and height displayed by the appliance conforms to the picture. Flames must not impinge on the logs.
Checking Vent System	Homeowner	Inspect the vent system at the top and at the base (within the firebox) for signs of blockage or obstruction. Look for any signs of dislocation of the vent components.
Cleaning Front Glass Enclosure Panel	Homeowner	Clean as necessary following the directions provided in this manual. DO NOT TOUCH OR ATTEMPT TO CLEAN GLASS WHILE HOT.

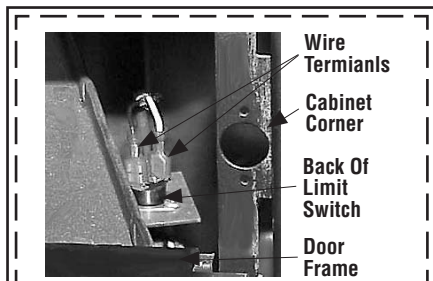

Detail A

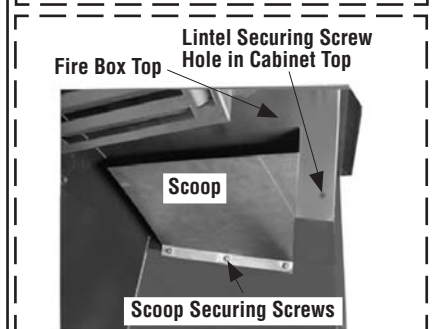

Detail B

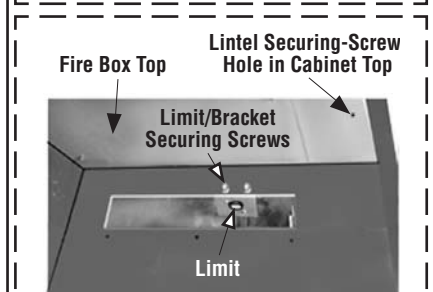

Detail C

Blocked Flue Safety Limit Location
Inside View of Firebox -
Top/Right Side Intersection

Figure 5

Maintenance

The appliance and venting system should be thoroughly inspected before initial use and at least annually by a qualified service technician. However, more frequent periodic inspections and cleanings should be performed by the homeowner. Homeowner must contact a qualified service technician at once if any abnormal condition is observed.

WARNING
 Turn off gas and electrical power before servicing the appliance.

Refer to the maintenance schedule for maintenance tasks, procedures, periodicity and by whom they should be performed. Always verify proper operation of the appliance after servicing.

IMPORTANT: TURN OFF GAS AND ANY ELECTRICAL POWER BEFORE SERVICING THE APPLIANCE.

Front Glass Enclosure Panel, Removal and Installation.

WARNING
 Never operate the appliance without the glass enclosure panel in place and secure. Do not operate appliance with the FRONT glass panel cracked, broken or missing. Replacement panels are available through your local LENNOX Dealer and must be installed by a licensed or qualified service technician.

These appliances are designed to operate only with the front glass enclosure panel properly installed. Generally, the glass enclosure panel should not be removed except to gain access to the components within the firebox, and the appliance may only be operated without the front glass enclosure panel in place for very brief periods of time during initial appliance checkout and adjustment.

During this appliance checkout and adjustment period, a potential safety hazard exists - EXERCISE EXTREME CAUTION to prevent the occurrence of any burn injuries from the exposed flames or hot surfaces. Also note, that while the front glass enclosure panel is removed, the flame appearance will appear to be smaller than normal.

WARNING
 Handle the glass with extreme care! Tempered glass is susceptible to damage (scratches, for example) – Handle glass door (glass enclosure panel) gently while reinstalling it.

WARNING
 Do not attempt to substitute the materials used on this door, or replace cracked or broken glass with any materials other than those provided by the appliance manufacturer.

NOTE: DIAGRAMS & ILLUSTRATIONS ARE NOT TO SCALE.

IMPORTANT
 The glass door of this appliance must only be replaced as a complete unit as provided by the manufacturer. Do not attempt to replace broken, cracked or chipped glass separately.

Refer to Figure 6 and remove the front glass enclosure panel as follows:

1. Remove the top louver assembly or radiant panel.
2. Open the hinged drop-down control compartment access panel.
3. Locate the latch at the top of the control compartment and disengage it from the door frame bottom Vee-flange, pulling down on its handle to open it.
4. Swing the bottom of the door out and raise it slightly to lift the top flange of the door frame away from the appliance.

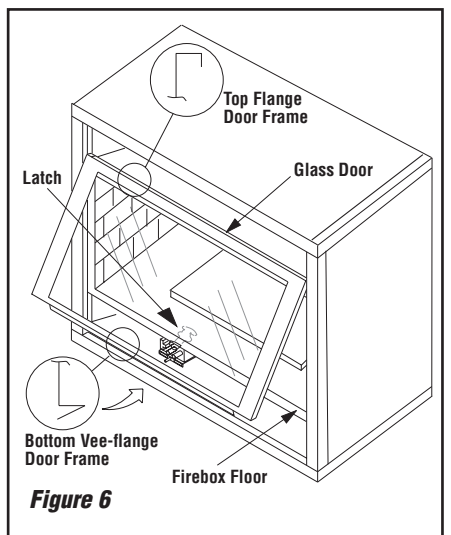

Figure 6

To install the front glass enclosure panel, proceed as follows:

1. Retrieve the glass door frame. Visually inspect the gasket on the backside of the panel. The gasket surface must be clean, free of irregularities and seated firmly.
2. Position the door frame in front of the firebox opening and engage the top flange over the lip at the top of the firebox opening.
3. Swing the door down and back. Ensure the gasket seats evenly as the door draws shut. Engage the Vee-flange at the bottom of the door with the latch and close the latch to secure the door.
4. Reinstall the top louver assembly or radiant panel.

Burner Adjustments

Note - The air shutter for the burner primary air opening is factory-set. Do not adjust the factory-set position. The factory-set position is shown in **Figure 7**.

Burner Air Shutter Adjustment

Setscrew - Factory Located in the Natural Gas Position; Relocate Set Screw for LP/Propane Gas in the Alternate Position. See Table for Air Shutter Openings for these Setscrew Locations.

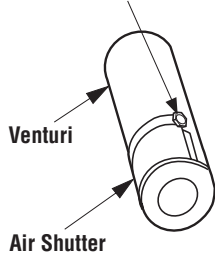

Main Burner Factory Air Shutter Opening Setting - Inches (millimeter)

Model	Natural Gas	Propane Gas
MPB-3328	Fully Closed	3/16" (4.76 mm)
MPB-3530	Fully Closed	3/16" (4.76 mm)
MPB-4035	Fully Closed	3/16" (4.76 mm)
MPB-4540	Fully Closed	3/16" (4.76 mm)

Figure 7

SIT Millivolt Appliance Checkout

The pilot flame should be steady, not lifting or floating. Flame should be blue in color with traces of orange at the outer edge.

The top 3/8" (10 mm) at the pilot generator (thermopile) and the top 1/8" min (tip) of the quick drop out thermocouple should be engulfed in the pilot flame. The flame should project 1" (25 mm) beyond the hood at all three ports (**Figure 8**).

To light the burner, refer to the lighting instructions on **Pages 18 and 19**.

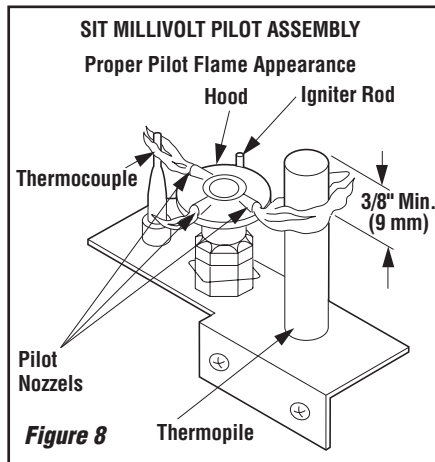

Figure 8

Electronic Appliance Checkout

To light the burner, refer to the lighting instructions on **Page 20 and 21**. Ensure the igniter lights the pilot. The pilot flame should engulf the flame sensor as shown in **Figure 9**.

ELECTRONIC PILOT ASSEMBLY Proper Pilot Flame Appearance

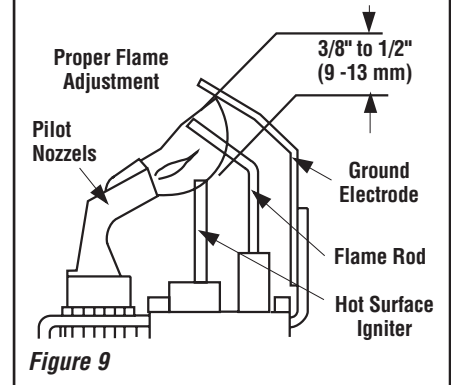

Figure 9

With proper care and maintenance, your appliance will provide many years of enjoyment. If you should experience any problem, first refer to the trouble shooting guide in this manual. If problem persists, contact your Lennox distributor.

Log Placement

WARNING

Logs get very hot and will remain hot up to one hour after gas supply is turned off. Handle only when logs are cool. Turn off all electricity to the appliance before you install grate and logs.

WARNING

This appliance is not meant to burn wood. Any attempt to do so could cause irreparable damage to your appliance and prove hazardous to your safety.

WARNING

The size and position on the log set IS Critical to give your appliance a safe, reliable and attractive flame pattern. Any attempt to use a different log set in the fireplace will void the Warranty and will result in incomplete combustion, sooting, and poor flame quality.

Initial Installation Considerations

The packaged logs are located within the firebox. The decorative volcanic stone and glowing embers are packaged separately in plastic bags located in the control area of the fireplace.

If the logs are being installed for the first time, the following paragraphs apply:

DO NOT attempt to install the logs until the appliance installation has been completed, the gas line connected and tested for leaks and the initial burner operation has been checked out.

Proper twig placement is critical to prevent sooting. Twigs should be placed in the gaps between the flame peaks and should be positioned so that at no time they impinge the flames.

- Step 1.** Remove the appliance front door.
- Step 2.** Remove the log set from the interior of the fireplace.
- Step 3.** Remove the logs from their packaging. **Handle logs carefully to prevent breakage.**
- Step 4. MPB-4035 & MPB-4540 Models** - Remove the restraining strap from the grate tines. Ensure the grate is fully inserted into the holes on the firebox rear panel and over the indents on the firebox floor.

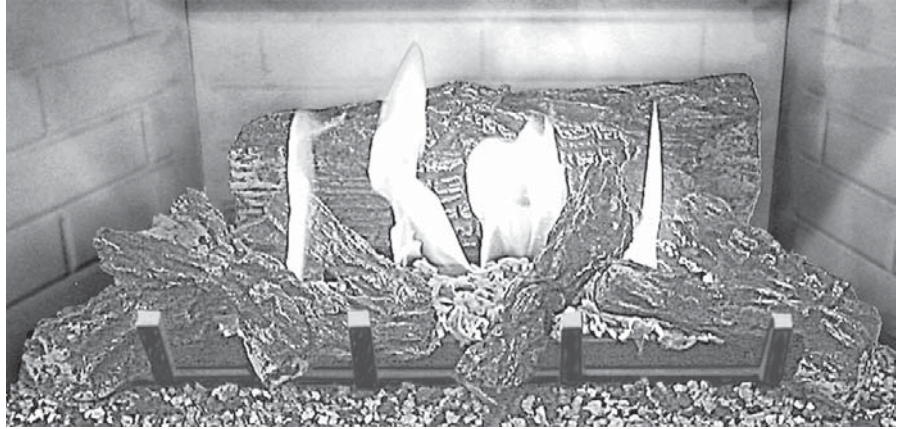

Figure 10 Burner Flame Appearance - Model MPB-3328

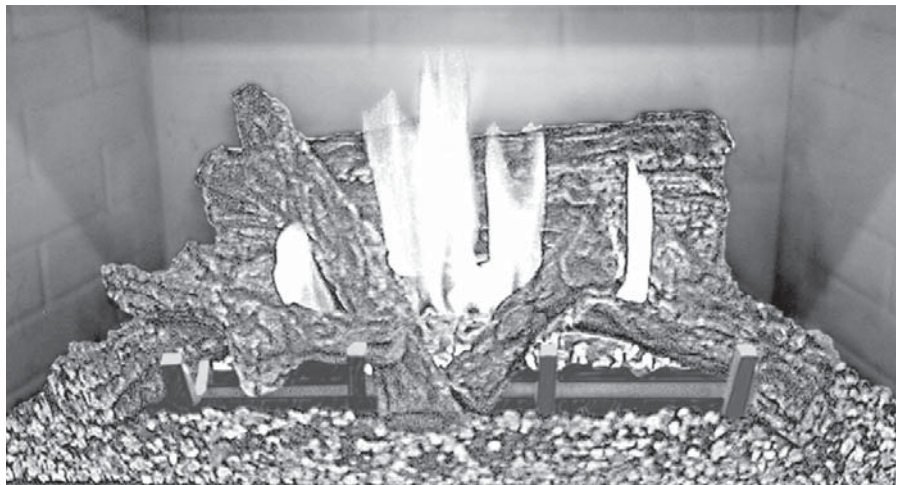

Figure 11 Burner Flame Appearance - Model MPB-3530

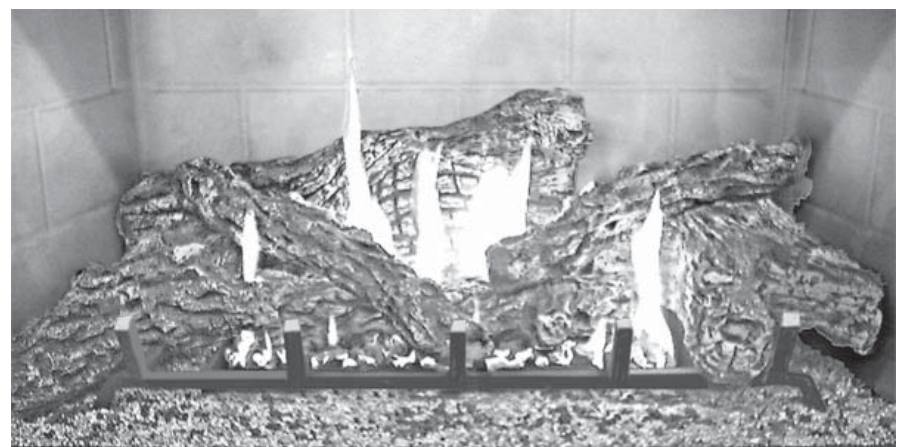

Figure 12 Burner Flame Appearance - Model MPB-4035 & MPB-4540

NOTE: DIAGRAMS & ILLUSTRATIONS ARE NOT TO SCALE.

Glowing Embers, Vermiculite, Decorative Volcanic Stone And Log Placement Instructions:

Step 1. Separate the Glowing Embers (Rockwool) into pieces about the size of a quarter (*see Figure 13*). Keep the pieces fluffed up, not matted.

MPB-3328 & MPB-3530 Models -

Distribute these pieces over the burner as shown in *Figure 14*. Do not use more than is shown. The glowing embers should not be placed directly over the large burner slots as shown in *Figure 14*.

MPB-4035 & MPB-4540 Models -

Place the center log (Log No. 1) on the burner as shown on *Page 12*. Distribute the glowing ember pieces at the front of the burner as shown in *Figure 15*. Do not use more than is shown. The glowing embers should not be placed directly over the large burner slots as shown in *Figure 15*.

Note: *This appliance is provided with enough Glowing Embers for several applications; do not feel compelled to use all that is in a new bag. For best glowing effect, replace the ember material annually. Replacement Glowing Embers are available (Catalogue Number 88L53).*

Step 2. Mound up a portion of the vermiculite (light colored material) in front of the burner and grate. Sprinkle the dark colored decorative volcanic stone on top of the vermiculite in a pleasing pattern. For best results, spread in a non-uniform manner while ensuring complete coverage of the black sheetmetal surface.

See Figure 14 - MPB-3328 or MPB-3530, or Figure 15 - MPB-4035 or MPB-4540 models.

Note: *Do Not place vermiculite or decorative volcanic stone on top of the gas burner where it will block the burner ports.*

Step 3. Position the individual logs as described on *Pages 11 (MPB-3328), 12 (MPB-3530) or 13 (MPB-4035 and MPB-4540).*

Note: *Your application may not require the use of all of the provided vermiculite, or decorative volcanic stone. Replacement vermiculite, volcanic stone and glowing embers is available (see below for ordering information).*

REFERENCE Firebox Accessories / Parts		
Cat. No.	Model No.	Description
88L53	FGE	Bag of Glowing Embers (1 oz. rockwool)
42363		Vermiculite, Bag (2 liters)
80L42	FDVS	Bag of Decorative Volcanic Stone

Table 4

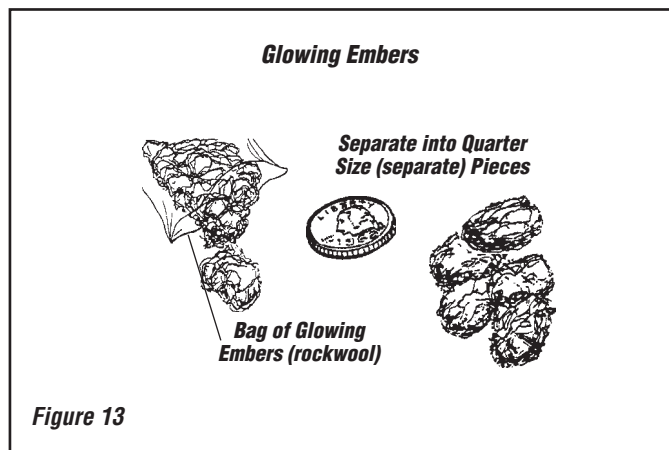

Figure 13

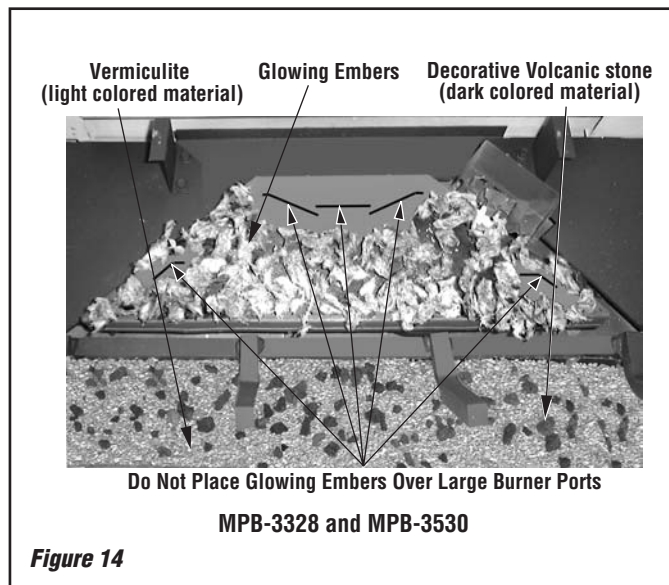

Figure 14

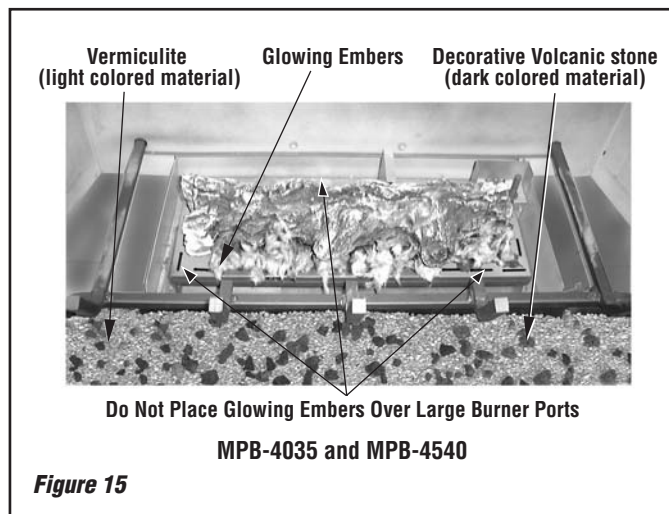
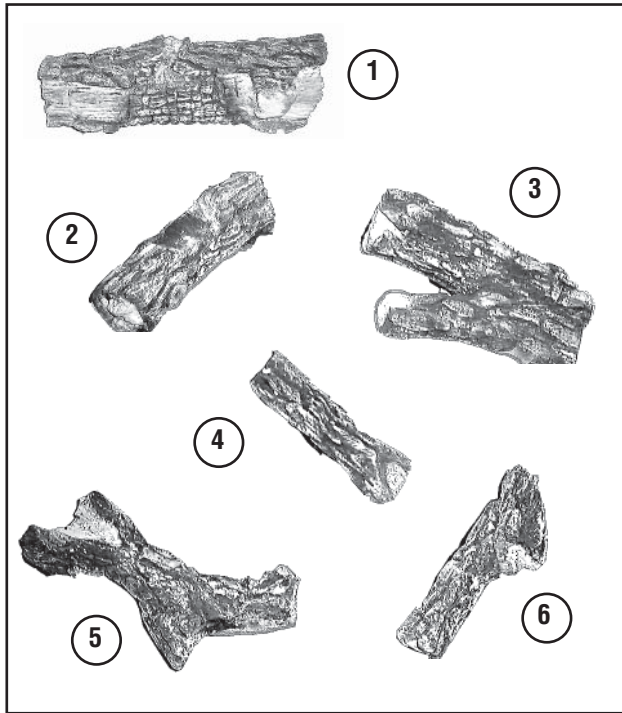

Figure 15

MPB-3328 LOG PLACEMENT



LOG SET Catalog Number 24M1501	
* Item	Description (stamped #)
1	Log, Rear (39-12)
2	Log, Left (39-1)
3	Log, Right (39-2)
4	Log, Top Center (39-13)
5	Log, Top/Left (39-3)
6	Log, Top/Right (39-4)

** Item numbers above correspond to photos*

Position the individual logs as shown below. Logs should be placed in the order shown. Position the rear log on the brackets at the rear of the firebox with the log's notches directly over the brackets. Position the right log (log no. 3) by inserting the pin from the rear log into the hole on its upper end. Place the left log and then the smaller left and right top logs. All logs that have notches to fit over the grate tines should be positioned with these notches directly against the grate. All top logs that rest on lower logs, do so over flattened mounting faces in the bottom logs.

Proper log and twig placement is critical to encourage outstanding flame appearance and prevent sooting.

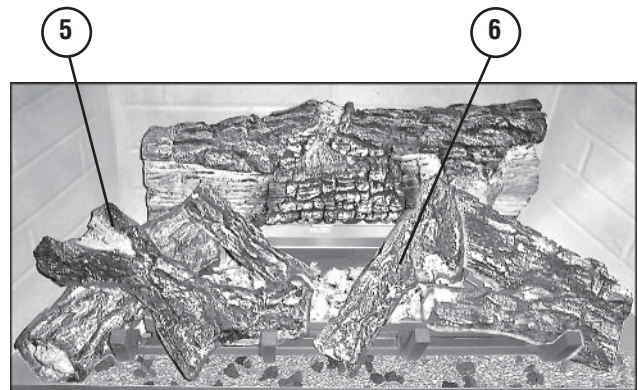
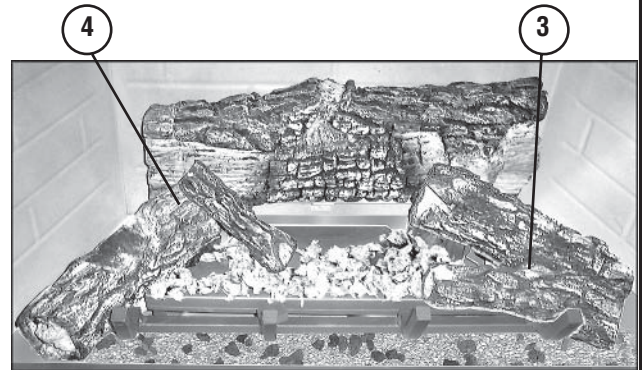
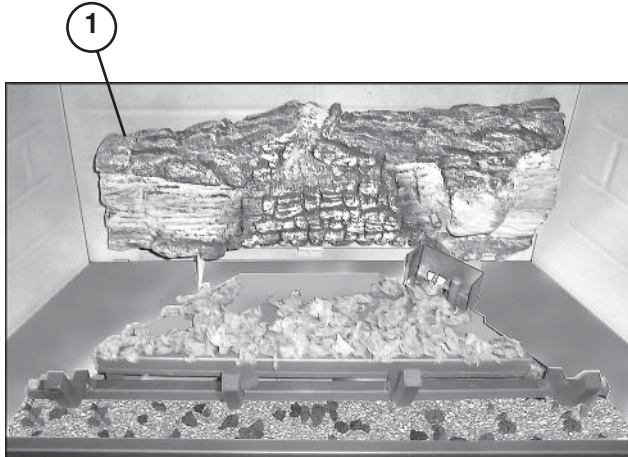
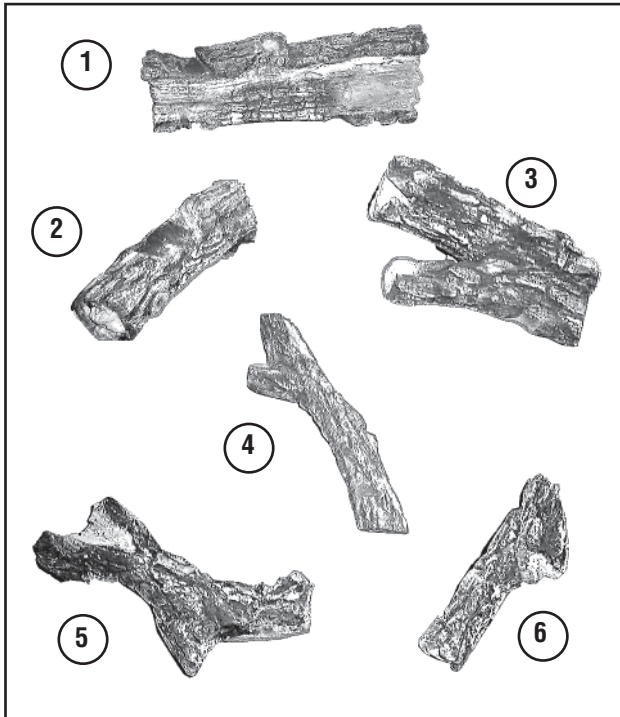

Figure 16

NOTE: DIAGRAMS & ILLUSTRATIONS ARE NOT TO SCALE.

MPB-3530 LOG PLACEMENT



LOG SET Catalog Number 24M2201	
* Item	Description (stamped #)
1	Log, Rear (39-5)
2	Log, Left (39-1)
3	Log, Right (39-2)
4	Log, Top Center (39-6)
5	Log, Top/Left (39-3)
6	Log, Top/Right (39-4)

** Item numbers above correspond to photos*

Position the individual logs as shown below. Logs should be placed in the order shown. Position the rear log on the brackets at the rear of the firebox with the log's notches directly over the brackets. Position the right log (log no. 3) by inserting the pin from the rear log into the hole on its upper end. Place the left log and then the smaller left and right top logs. All logs that have notches to fit over the grate tines should be positioned with these notches directly against the grate. All top logs that rest on lower logs, do so over flattened mounting faces in the bottom logs.

Proper log and twig placement is critical to encourage outstanding flame appearance and prevent sooting.

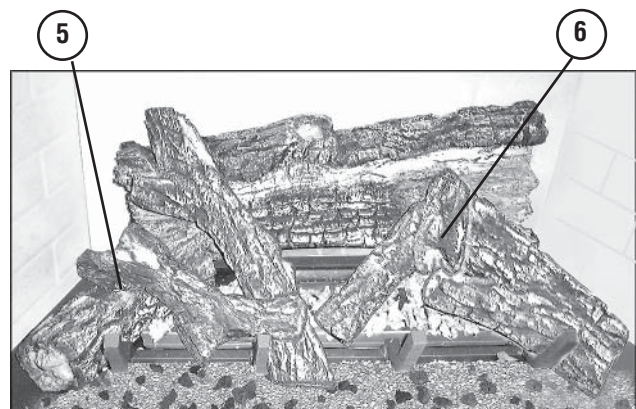
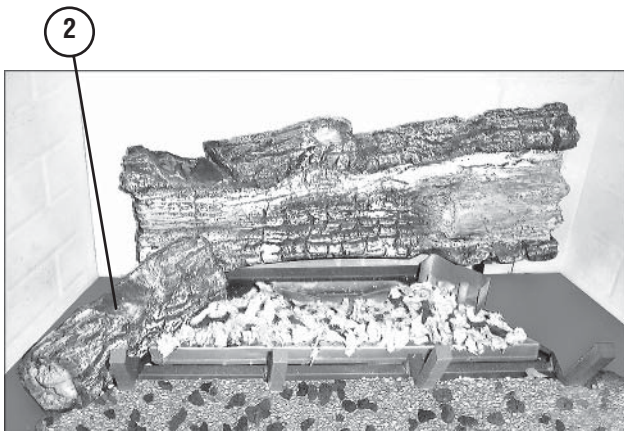
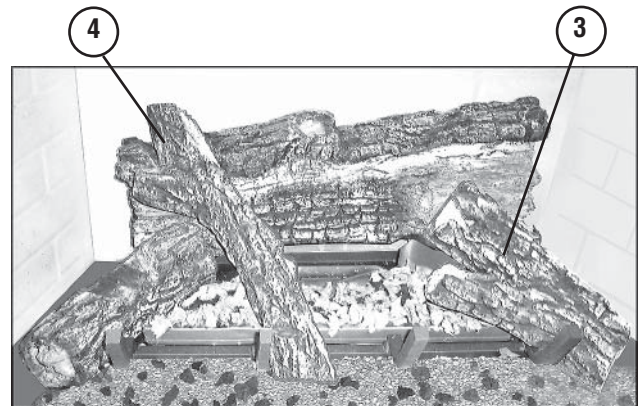
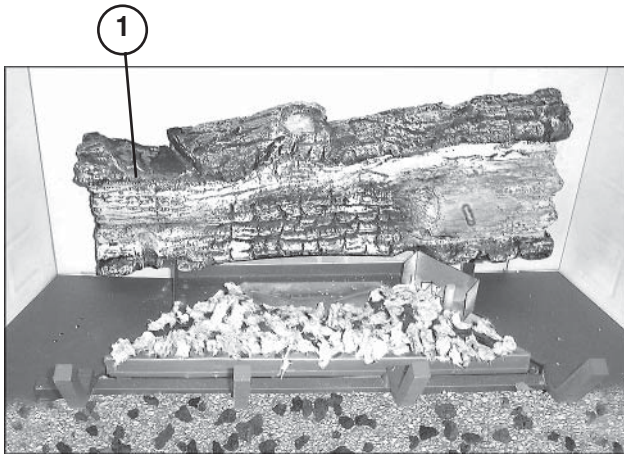
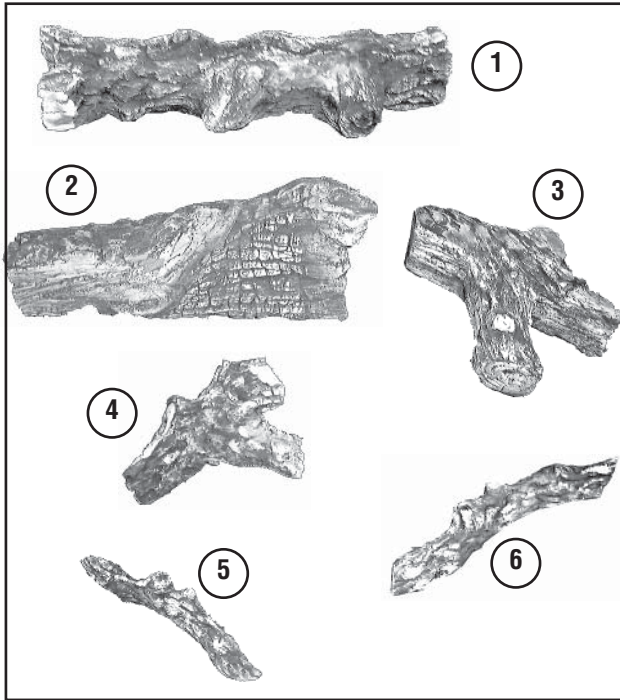

Figure 17

MPB-4035 & MPB-4540 LOG PLACEMENT



LOG SET Catalog Number 24M2501	
* Item	Description (stamped #)
1	Log, Center (39-8)
2	Log, Rear (138)
3	Log, Right (39-10)
4	Log, Left (39-9)
5	Log, Top/Left (39-11)
6	Log, Top/Right (39-11)

* Item numbers above correspond to photos

Position the individual logs as shown below. Logs should be placed in the order shown. Position the center log on the burner first, then place the glowing embers as shown in **Figure 15**. Place the rear log, both the right and left, and then the smaller left and right top logs. All logs that have notches should be positioned with these notches over the grate tines should be positioned with these notches directly against the grate. All top logs that rest on lower logs, do so over flattened mounting faces in the bottom logs.

Proper log and twig placement is critical to encourage outstanding flame appearance and prevent sooting.

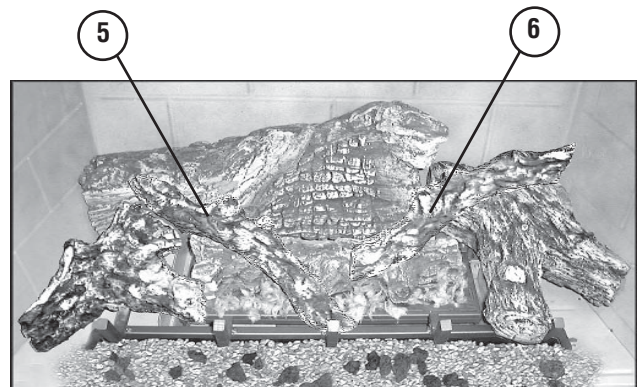
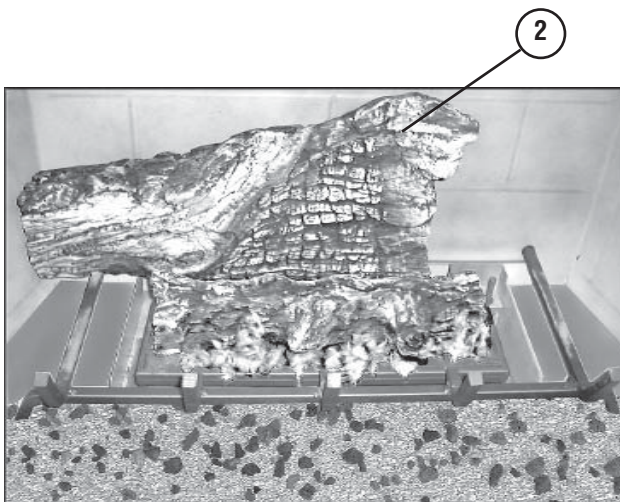
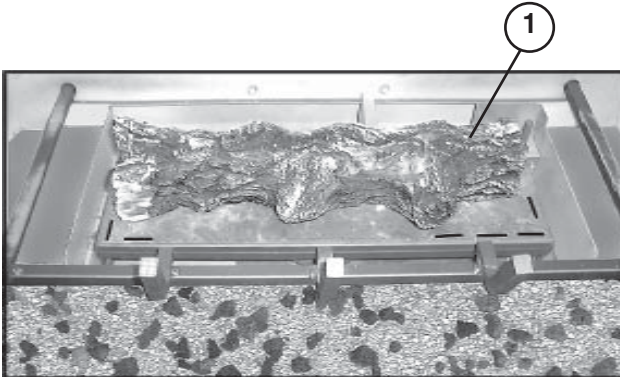
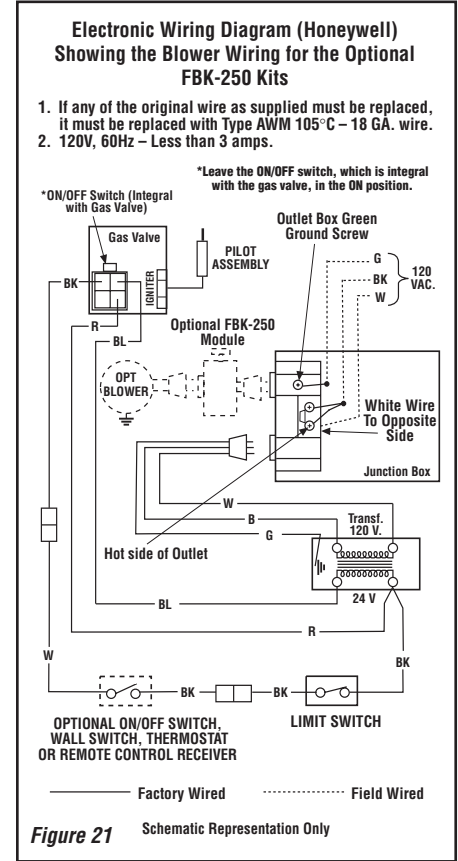
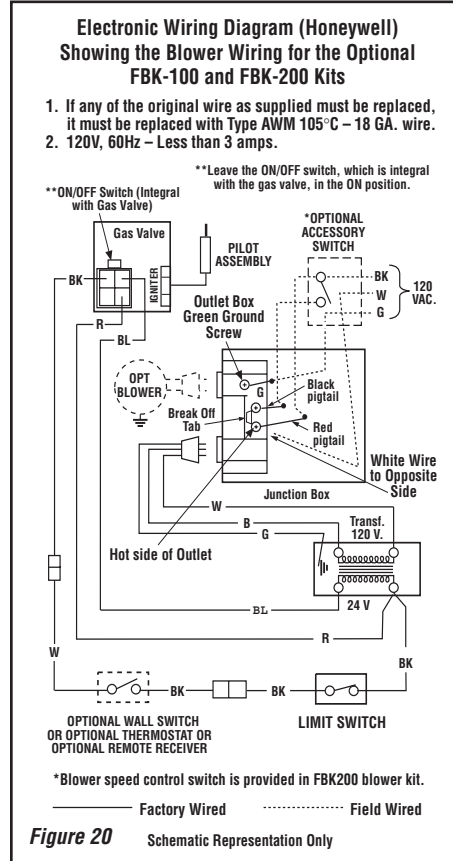
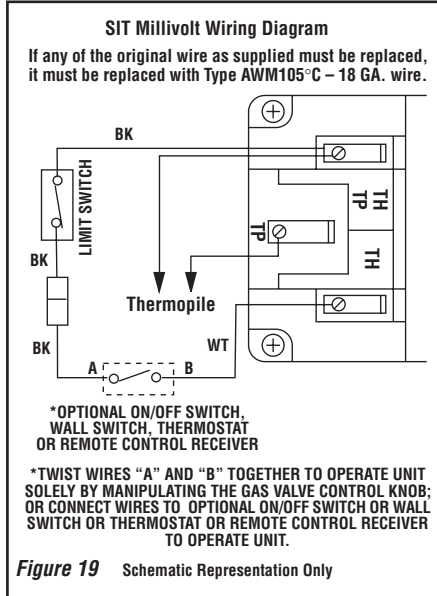

Figure 18

WIRING DIAGRAMS

Wiring diagrams are provided here for reference purposes only. This information is also provided on schematics attached directly to the appliance on a pullout panel located within the control compartment.

CAUTION: LABEL ALL WIRES PRIOR TO DISCONNECTION WHEN SERVICING CONTROLS. WIRING ERRORS CAN CAUSE IMPROPER AND DANGEROUS APPLIANCE OPERATION.



WARRANTY

Your gas appliance is covered by a limited twenty year warranty. You will find a copy of the warranty accompanying this manual. Please read the warranty to be familiar with its coverage.

Retain this manual. File it with your other documents for future reference.

REPLACEMENT PARTS

A complete parts list is found at the end of this manual. Use only parts supplied from the manufacturer.

Normally, all parts should be ordered through your Lennox distributor or dealer. Parts will be shipped at prevailing prices at time of order.

When ordering repair parts, always give the following information:

- The model number of the appliance.
- The serial number of the appliance.
- The part number.
- The description of the part.
- The quantity required.
- The installation date of the appliance.

If you encounter any problems or have any questions concerning the installation or application of this system, please contact your distributor, or Lennox directly:

LHP
1110 West Taft Avenue • Orange, CA 92865

PRODUCT REFERENCE INFORMATION

We recommend that you record the following important information about your fireplace. Please contact your Lennox dealer for any questions or concerns. For the number of your nearest Lennox dealer, please call 1-800-9-LENNOX or visit our website at www.lennox.com.

Your Fireplace's Model Number _____

Your Fireplace's Serial Number _____

The Date On Which Your Fireplace Was Installed _____

The Type of Gas Your Fireplace Uses _____

Your Dealer's Name _____

NOTE: DIAGRAMS & ILLUSTRATIONS ARE NOT TO SCALE.

ACCESSORY COMPONENTS



Remote Control Kit, Standard		
Cat. No.	Model No.	Description
H0249	RCL	Remote Control System (Standard)

Standard Remote Control System

The Model RCL (Standard) Remote Control System, features a simple On/Off control function for the fireplace. This model includes a hand-held transmitter, a remote receiver with wall-mount coverplate and all hardware required to install the unit. The remote receiver can be wall or hearth mounted.

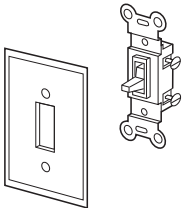

White Wall Switch Kit		
Cat. No.	Model No.	Description
85L87	FWSK	OFF/ON Wall Switch Kit

OFF/ON Wall Switch Kit

The OFF/ON wall switch kit may be used to control the operation of the fireplace burner. Install the OFF/ON wall switch in a convenient location near the fireplace.

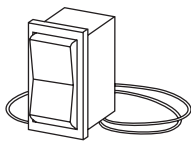

Rocker Switch Kit		
Cat. No.	Model No.	Description
80L41	FRS	Rocker Switch Kit

Unit-Mountable Rocker Switch

This rocker switch kit can be installed directly in the gas valve mounting bracket (millivolt gas valve equipped fireplaces) to provide On/Off operation in lieu of a wall switch.



Decorative Firebox Accessories (all models)		
Cat. No.	Model No.	Description
88L53	FGE	Bag of Glowing Embers (1 oz. rockwool)
80L42	FDVS	Bag of Decorative Volcanic Stone

Bag of Glowing Embers

Bag of Volcanic Stone

Replacement ember materials or volcanic stone are available for use with these appliances. Order kits as part of the periodic maintenance of the appliance.



Touch-Up Paint Kits (all models)		
Cat. No.	Model No.	Description
H4354	TPK-C	Touch-Up Paint (Charcoal)
98K67		Touch-Up Paint (Tan)

Touch-Up Paint Kit

Repair of minor scratches and discoloration of the appliance charcoal painted surfaces may be accomplished with the touch-up paint kit.

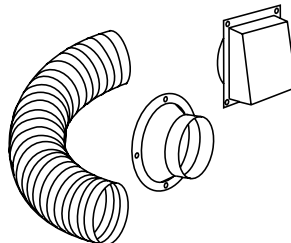

Outside Combustion Air Kits		
Cat. No.	Model No.	Description
81L87	FOAK-4	Combustion Air Kit (with duct)
81L88	FOAK-4LD	Combustion Air Kit (without duct)

Outside Combustion Air Kits

This kit includes 4" diameter duct, collar and hood for delivering outside combustion air to the fireplace.

NOTE: DIAGRAMS & ILLUSTRATIONS ARE NOT TO SCALE.

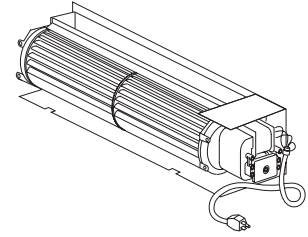

Forced Air Blower Kits		
Cat. No.	Model No.	Description
80L84	FBK-100	Blower, Standard (single speed)
80L85	FBK-200	Blower, Variable Speed (w/wall-mounted switch)
80L86	FBK-250	Blower, Variable Speed (w/unit-mounted switch)

Forced Air Kit

The FBK-100 blower provides constant velocity forced air circulation. The FBK-200 assembly with variable speed, wall-mountable switch provides variable speed forced air circulation. The FBK-250 assembly with variable speed wall- or unit-mountable switch, also provides variable speed forced air circulation.

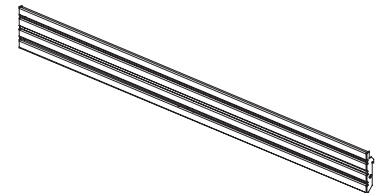

* Lennox Nameplate Logo, 12L15, is sold separately.

* Assembled 8-Piece Louver Kits				
Polished Brass		Brushed Stainless		Models Where Used
Cat. #	Model	Cat. #	Model	
H1522	LK-400B	H1523	LK-400BS	MPB-3328
H1524	LK-500B	H1525	LK-500BS	MPB-3530
H1526	LK-600B	H1527	LK-600BS	MPB-4035
H1528	LK-800B	H1529	LK-800BS	MPB-4540

Polished Brass & Brushed Stainless Louvers Kits

These kits include a top 4-louver assembly and a bottom 4-louver assembly. They provide a touch of elegance. These kits can be retrofitted to previously installed appliances.

ACCESSORY COMPONENTS

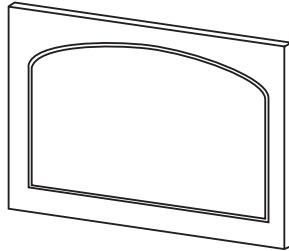

Arch Door Kit - Polished Brass		
Cat. No.	Model	Models-Where Used
98L05	ADK33CPB	MPB-3328
26M43	ADK35CMPB	MPB-3530
81L35	ADK40CPB	MPB-4035
81L36	ADK45CPB	MPB-4540

Arch Door Kit - Brushed Stainless Steel		
Cat. No.	Model	Models-Where Used
98L62	ADK33CBS	MPB-3328
26M44	ADK35CMBS	MPB-3530
98L69	ADK40CBS	MPB-4035
98L70	ADK45CBS	MPB-4540

Arch Door Kits

The arch door kits are easy to install and do not require hardware to attach them to the standard door frame. The decorative arch kits can not be used in conjunction with the screen panel kit.

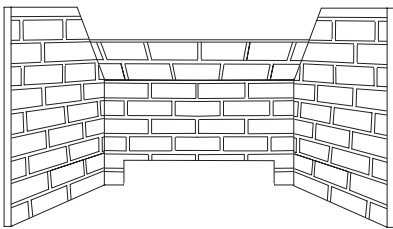

Brickaded Wall Liner Kits		
Cat. No.	Model No.	Description
H4683	MBLK-33B	Brick Liner Kit, MPB-3328
H4684	MBLK-35B	Brick Liner Kit, MPB-3530
H4685	MBLK-40B	Brick Liner Kit, MPB-4035
H4686	MBLK-45B	Brick Liner Kit, MPB-4540

Brickaded Panel Liner Kit

The brickaded liner kits include ceramic panels as shown here. The panels have brick-like features in relief.

2-PIECE LOUVER SET KITS				
Polished Brass		Brushed Stainless		Models Where Used
Cat. #	Model	Cat. #	Model	
98L09	2LVR33PB	98L08	2LVR33BS	MPB-3328
96L05	2LVR35PB	96L09	2LVR35BS	MPB-3530
96L06	2LVR40PB	96L10	2LVR40BS	MPB-4035
96L07	2LVR45PB	96L11	2LVR45BS	MPB-4540

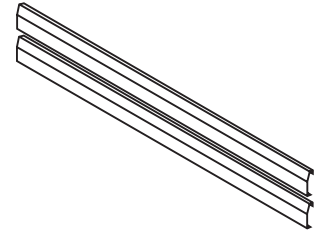

2-Piece Polished Brass and Brushed Stainless Louvers Kits

These louvers are designed to replace either the middle charcoal louver of each set or the charcoal louver in each set closest to the glass door. These kits include two narrow louvers. They provide a touch of elegance to these appliances. These kits can be retrofitted to previously installed appliances.

2- Piece Door Frame Kits				
Polished Brass		Brushed Stainless		Models Where Used
Cat. #	Model	Cat. #	Model	
98L18	2DFK33PB	98L19	2DFK33BS	MPB-3328
26M88	2DFK35PB	26M91	2DFK35BS	MPB-4035
26M89	2DFK40PB	26M92	2DFK40BS	MPB-4035
26M90	2DFK45PB	26M93	2DFK45BS	MPB-4540

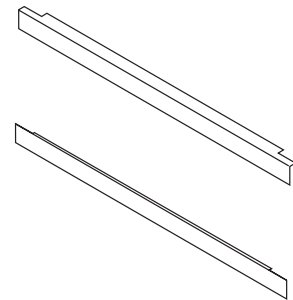

Polished Brass & Brushed Stainless 2-Piece Door Frame Kits

These kits are designed to attach directly to the front face of the appliance at the glass enclosure panel's top and bottom edges.

4 Piece Door Trim Kits				
Polished Brass		Brushed Stainless		Models Where Used
Cat. #	Model	Cat. #	Model	
98L22	4DFK33PB	98L23	4DFK33BS	MPB-3328
26M82	4DFK35PB	26M85	4DFK35BS	MPB-3530
26M83	4DFK40PB	26M86	4DFK40BS	MPB-4035
26M84	4DFK45PB	26M87	4DFK45BS	MPB-4540

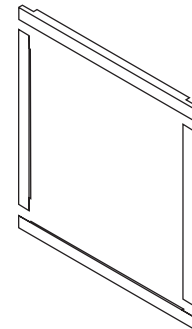

Door Frame Kits

A decorative door frame kit is available for use with these appliances. It is designed to attach directly to the front face of the appliance at the four edges of the glass enclosure panel resulting in the appearance of a picture frame.

Eyebrow Hood Kits				
Polished Brass		Brushed Stainless		Models Where Used
Cat. #	Model	Cat. #	Model	
98L10	EB33PB	98L11	EB33BS	MPB-3328 MPB-3328
96K67	EB35PB	88L49	EB35BS	MPB-4035
96K68	EB40PB	88L50	EB40BS	MPB-4035
96K69	EB45PB	88L51	EB45BS	MPB-4540

* These hood kits replace the standard hood that comes with these fireplaces.

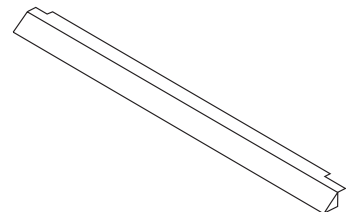

Polished Brass & Brushed Stainless Hood Kits

Attractive hoods are available in two styles. These hoods are designed to be fitted to the glass viewing sides of the appliance. In addition to providing an aesthetically pleasing appearance to your appliance installation, the hood reduces heat effects to decorative mantles and finish materials located above the fireplace opening. The hood kit replaces the standard hood that comes with these appliances and snaps into place. These kits can be retrofitted to previously installed appliances.

ACCESSORY COMPONENTS

ARCH DESIGN SCREEN DOOR KITS			
Cat. No.	Model	Description	Where Used
H0858	AD35C	35" Arch Doors, Charcoal	MPB3530
H0859	AD35TI	35" Arch Doors, Textured Iron	
H0860	AD35SP	35" Arch Doors, Satin Pewter	
H0861	AD35AB	35" Arch Doors, Antique Brass	
H0862	AD40C	40" Arch Doors, Charcoal	MPB4035
H0863	AD40TI	40" Arch Doors, Textured Iron	
H0864	AD40SP	40" Arch Doors, Satin Pewter	
H0865	AD40AB	40" Arch Doors, Antique Brass	
H0866	AD45C	45" Arch Doors, Charcoal	MPB4540
H0867	AD45TI	45" Arch Doors, Textured Iron	
H0868	AD45SP	45" Arch Doors, Satin Pewter	
H0869	AD45AB	45" Arch Doors, Antique Brass	
ARCH PANE DESIGN KITS			
H0930	APD35C	35" Arch Pane Doors, Charcoal	MPB3530
H0931	APD35TI	35" Arch Pane Doors, Textured Iron	
H0932	APD35SP	35" Arch Pane Doors, Satin Pewter	
H0933	APD35AB	35" Arch Pane Doors, Antique Brass	
H0934	APD40C	40" Arch Pane Doors, Charcoal	MPB4035
H0935	APD40TI	40" Arch Pane Doors, Textured Iron	
H0936	APD40SP	40" Arch Pane Doors, Satin Pewter	
H0937	APD40AB	40" Arch Pane Doors, Antique Brass	
H0938	APD45C	45" Arch Pane Doors, Charcoal	MPB4540
H0939	APD45TI	45" Arch Pane Doors, Textured Iron	
H0940	APD45SP	45" Arch Pane Doors, Satin Pewter	
H0941	APD45AB	45" Arch Pane Doors, Antique Brass	

SQUARE DESIGN SCREEN DOOR KITS			
Cat. No.	Model	Description	Where Used
H0946	SD35C	35" Sq. Doors, Charcoal	MPB3530
H0947	SD35TI	35" Sq. Doors, Textured Iron	
H0948	SD35SP	35" Sq. Doors, Satin Pewter	
H0949	SD35AB	35" Sq. Doors, Antique Brass	
H0950	SD40C	40" Sq. Doors, Charcoal	MPB-4035
H0951	SD40TI	40" Sq. Doors, Textured Iron	
H0952	SD40SP	40" Sq. Doors, Satin Pewter	
H0953	SD40AB	40" Sq. Doors, Antique Brass	
H0954	SD45C	45" Sq. Doors, Charcoal	MPB4540
H0955	SD45TI	45" Sq. Doors, Textured Iron	
H0956	SD45SP	45" Sq. Doors, Satin Pewter	
H0957	SD45AB	45" Sq. Doors, Antique Brass	
SQUARE PANE DESIGN KITS			
H0962	SPD35C	35" Sq. Pane Doors, Charcoal	MPB3530
H0963	SPD35TI	35" Sq. Pane Doors, Textured Iron	
H0964	SPD35SP	35" Sq. Pane Doors, Satin Pewter	
H0965	SPD35AB	35" Sq. Pane Doors, Antique Brass	
H0966	SPD40C	40" Sq. Pane Doors, Charcoal	MPB-4035
H0967	SPD40TI	40" Sq. Pane Doors, Textured Iron	
H0968	SPD40SP	40" Sq. Pane Doors, Satin Pewter	
H0969	SPD40AB	40" Sq. Pane Doors, Antique Brass	
H0970	SPD45C	45" Sq. Pane Doors, Charcoal	MPB4540
H0971	SPD45TI	45" Sq. Pane Doors, Textured Iron	
H0972	SPD45SP	45" Sq. Pane Doors, Satin Pewter	
H0973	SPD45AB	45" Sq. Pane Doors, Antique Brass	

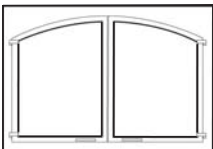

Arch Design

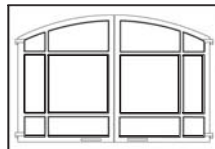

Arch Pane Design

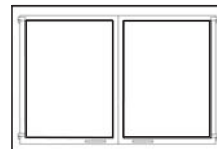

Square Design

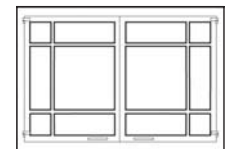

Square Pane Design



4-Piece Trim Kit



3-Piece Trim Kit

3 and 4-Piece Trim Kits

This kit contains brass trim pieces used to finish the gaps between the wall board and the fireplace, providing the appliance a brass perimeter highlight. This kit contains the trim pieces and instructions.

4 Piece Trim Kit		
Cat. No.	Model No.	Description
96K17	TK35PB4	35" 4 Piece Finish Trim Kit, Polished Brass, MPB-3530
96K18	TK40PB4	40" 4 Piece Finish Trim Kit, Polished Brass, MPB-4035
96K19	TK45PB4	45" 4 Piece Finish Trim Kit, Polished Brass, MPB-4540

3 Piece Trim Kit		
Cat. No.	Model No.	Description
H0453	TK33PB3	33" Polished Brass, MPB-3328
96K21	TK35PB3	35" Polished Brass, MPB-3530
96K22	TK40PB3	40", Polished Brass, MPB-4035
96K23	TK45PB3	45", Polished Brass, MPB-4035
H1813	TK33BS3	33" Brushed Stainless, MPB-3328
H1815	TK35BS3	35" Brushed Stainless, MPB-3530
H1816	TK40BS3	40", Brushed Stainless, MPB-4035
H1817	TK45BS3	45", Brushed Stainless, MPB-4540

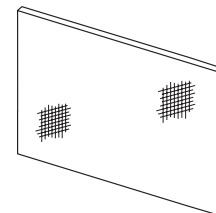

Screen Panel Kit

This easy to install optional Screen Panel installs over the standard glass enclosure panel to prevent inadvertent direct contact with the hot glass surface. These Screen Panels cannot be used in conjunction with the arch door kits or door frame kits.

Screen Panel Kits		
Cat. No.	Model No.	Models Where Used
98L04	HG33	MPB-3328
26M48	HG35M	MPB-3530
26M49	HG40M	MPB-4035
26M50	HG45M	MPB-4540

NOTE: DIAGRAMS & ILLUSTRATIONS ARE NOT TO SCALE.

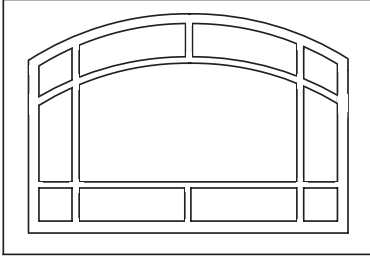

Decorative Arch Screen Panel Kit

This easy to install optional screen installs over the standard glass enclosure panel to provide protection from inadvertant direct contact with the hot glass surface. These screen panels cannot be used in conjunction with the arch door kits or door frame kits.

Decorative Arch Screen Panel Kit		
Cat. No.	Model	Model
H3593	DASPK35TI	35" Dec. Arch Screen Panel

Sunrise Style (upper grille shown)



Crescent Style (lower grille shown)



Cat. No. #	Model	Description	Model Series
H3565	SUGK35C	35" Charcoal	UPPER GRILLE KITS SUNRISE
H3566	SUGK35TI	35" Textured Iron	
H3567	SUGK35SP	35" Satin Pewter	
H3568	SUGK35AB	35" Antique Brass	

H3541	CUGK35C	35" Charcoal	UPPER GRILLE KITS CRESCENTS
H3542	CUGK35TI	35" Textured Iron	
H3543	CUGK35SP	35" Satin Pewter	
H3544	CUGK35AB	35" Ant. Brass	

H3569	SLGK35C	35" Charcoal	LOWER GRILLE KITS SUNRISE
H3570	SLGK35TI	35" Textured Iron	
H3571	SLGK35SP	35" Satin Pewter	
H3572	SLGK35AB	35" Antique Brass	

H3545	CLGK35C	35" Charcoal	LOWER GRILLE KITS CRESCENTS
H3546	CLGK35TI	35" Textured Iron	
H3547	CLGK35SP	35" Satin Pewter	
H3548	CLGK35AB	35" Antique Brass	

LIGHTING INSTRUCTIONS – SIT MILLIVOLT GAS VALVE

FOR YOUR SAFETY READ BEFORE LIGHTING

WARNING: IF YOU DO NOT FOLLOW THESE INSTRUCTIONS EXACTLY, A FIRE OR EXPLOSION MAY RESULT CAUSING PROPERTY DAMAGE, PERSONAL INJURY OR LOSS OF LIFE.

- A. This appliance has a pilot which must be lighted with a piezo igniter. When lighting the pilot, follow these instructions exactly.
- B. **BEFORE OPERATING** smell all around the appliance area for gas. Be sure to smell next to the floor because some gas is heavier than air and will settle on the floor.

WHAT TO DO IF YOU SMELL GAS

- Extinguish any open flame.
- Open windows.
- Do not light any appliance.
- Do not touch any electrical switches.

- Do not use any phone in your building.
 - Immediately call your gas supplier from a neighbor's phone.
 - If your gas supplier cannot be reached, call the fire department.
- C. Use only your hand to push in or turn the gas control knob. Never use tools. If the knob will not push in or turn by hand, do not try to repair it, call a qualified service technician. Force or attempted repair may result in a fire or an explosion.
- D. Do not use this appliance if any part has been under water. Immediately call a qualified service technician to inspect the appliance and to replace any part of the control system and any gas control which has been under water.

LIGHTING INSTRUCTIONS

1. **STOP!** Read the safety information above on this Page.
2. Access the lower control compartment.
3. Turn remote wall switch to "OFF."
4. Verify main line shut-off valve is open.
5. Push in gas control knob slightly and turn clockwise to "OFF." 

SIT MILLIVOLT GAS VALVE

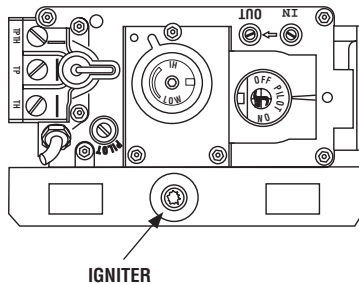

Note: Knob cannot be turned from "PILOT" to "OFF" unless the knob is pushed in slightly. Do not force.

6. Wait five (5) minutes to clear out any gas. If you then smell gas, STOP! Follow "B" in the safety information above on this Page. If you do not smell gas, go to the next step.
7. Push in gas control knob slightly and turn counterclockwise to "PILOT." 
8. Push in control knob all the way and hold in. Immediately light the pilot by triggering the spark igniter (pushing the button) until pilot lights. Continue to hold the control knob in for about 1 minutes after the pilot is lit. Release knob and it will pop back up. Pilot should remain lit. If it goes out, repeat steps 5 through 8.

SIT MILLIVOLT PILOT

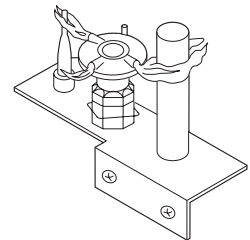

- If knob does not pop up when released, stop and immediately call your service technician or gas supplier.
 - If pilot will not stay lit after several tries, turn the control knob to "OFF" and call your service technician or gas supplier.
9. Turn gas control knob counterclockwise to "ON." 
 10. Close lower control compartment.

TO TURN OFF GAS TO APPLIANCE

1. Turn remote wall switch "OFF." The pilot will remain lit for normal service.
2. For complete shutdown, turn remote wall switch to "OFF."
3. Access the lower control compartment.
4. Depress gas control knob slightly and turn clockwise to "OFF." Do not force. 
5. Close lower control compartment.

INSTRUCTIONS D'ALLUMAGE – VANNE GAZ MILLIVOLT SIT

POUR VOTRE SÉCURITÉ, LISEZ CES INSTRUCTIONS AVANT L'ALLUMAGE

AVERTISSEMENT : SI VOUS NE SUIVEZ PAS CES INSTRUCTIONS À LA LETTRE, IL POURRAIT S'EN SUIVRE UN INCENDIE OU UNE EXPLOSION CAUSANT DES DOMMAGES MATÉRIELS, DES BLESSURES CORPORELLES OU MÊME DES PERTES DE VIE.

- A. Cet appareil est muni d'une veilleuse qui doit être allumée avec un allumeur piézo-électrique. Lorsque vous allumez la veilleuse, suivre exactement ces instructions.
- B. **AVANT L'ALLUMAGE:** Assurez-vous que vous ne détectez aucune odeur de gaz autour de l'appareil ainsi que près du sol; certains gaz, étant plus lourds que l'air, descendent au niveau du sol.
VOICI CE QUE VOUS DEVEZ FAIRE SI VOUS DÉCELEZ UNE ODEUR DE GAZ:
- Éteignez toute flamme visible.
 - Ouvrez les fenêtres.
 - N'allumez aucun appareil.
 - Ne touchez à aucun commutateur électrique.
 - Ne vous servez d'aucun téléphone dans votre édifice.
- Appelez immédiatement votre compagnie de gaz en utilisant le téléphone du voisin.
 - S'il vous est impossible de contacter votre compagnie de gaz, appelez le service des incendies.
- C. N'utilisez que votre main pour manipuler le bouton de réglage du gaz. N'utilisez jamais d'outils. Si le bouton refuse de tourner ou de bouger, n'essayez pas de le réparer. Communiquez immédiatement avec un technicien de service qualifié. Toute tentative pour le forcer ou le réparer, risquerait de provoquer un incendie ou une explosion.
- D. Ne vous servez pas de cet appareil si l'un de ses éléments a été immergé dans l'eau. Appelez immédiatement un technicien compétent pour faire inspecter l'appareil et remplacer toute pièce du système de réglage ou commande du gaz qui a été sous l'eau.

INSTRUCTIONS D'ALLUMAGE

1. **ARRÊTEZ!** Lisez les consignes de sécurité au verso de cette plaque.
2. Ouvrez le compartiment de contrôle du bas.
3. Tournez l'interrupteur mural à la position d'arrêt "OFF".
4. Assurez-vous que la soupape d'arrêt de la canalisation principale est ouverte.
5. Enfoncez légèrement le bouton de réglage du gaz et tournez-le dans le sens des aiguilles d'une montre jusqu'à la position d'arrêt "OFF".

VANNE GAZ MILLIVOLT SIT

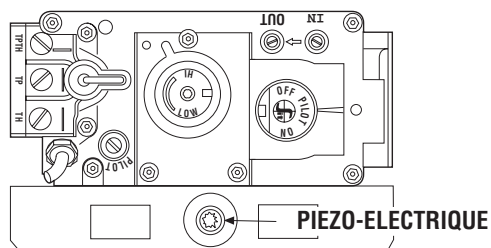

Remarque: Il est impossible de tourner le bouton de "PILOT" à "OFF" à moins qu'il ne soit légèrement enfoncé. Ne le forcez pas.

6. Attendez cinq (5) minutes pour l'évacuation du gaz. Si vous décelez une odeur de gaz, ARRÊTEZ ! Retournez au point "B" des consignes de sécurité au verso de cette plaque. Si vous ne remarquez aucune odeur de gaz, passez à l'étape suivante.
7. Enfoncez légèrement le bouton de réglage du gaz et tournez-le en sens inverse des aiguilles d'une montre jusqu'à la position de veilleuse "PILOT".

8. Enfoncez le bouton de réglage jusqu'au fond et gardez-le enfoncé. Allumez immédiatement la veilleuse en déclenchant l'allume-gaz à étincelle (en poussant le bouton) jusqu'à ce que la veilleuse s'enflamme. Continuez de tenir le bouton de réglage enfoncé pendant environ 90 secondes après l'allumage de la veilleuse. Relâchez le bouton et il sortira subitement. La veilleuse devrait rester allumée. Si elle s'éteint, répétez les étapes 5 à 8 inclusivement.

- Si le bouton ne sort pas automatiquement après avoir été relâché, arrêtez immédiatement et téléphonez à votre technicien de service ou à votre fournisseur de gaz.
- Si la veilleuse refuse de rester allumée après plusieurs tentatives, tournez le bouton de réglage jusqu'à sa position d'arrêt "OFF" et téléphonez à votre technicien de service ou à votre fournisseur de gaz.

SIT MILLIVOLT PILOT

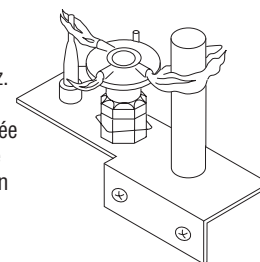

9. Tournez le bouton de réglage du gaz en sens inverse des aiguilles d'une montre jusqu'à sa position de marche "ON".
10. Fermez le compartiment de contrôle du bas.
11. Au besoin, rebrancher l'appareil au courant électrique et remettre l'interrupteur du brûleur principal à la position "ON" ou régler le thermostat à la température désirée.
12. Si l'appareil ne fonctionne pas, suivre les instructions intitulées "Pour fermer le gaz qui alimente l'appareil" et appeler un technicien ou le fournisseur de gaz.

POUR FERMER LE GAZ QUI ALIMENTE L'APPAREIL

1. Tournez l'interrupteur mural à la position d'arrêt "OFF". La veilleuse restera allumée jusqu'au retour du service normal.
2. Pour une fermeture complète, tournez l'interrupteur mural à la position d'arrêt "OFF".
3. Ouvrez le compartiment de contrôle du bas.
4. Enfoncez légèrement le bouton de réglage du gaz et tournez-le dans le sens des aiguilles d'une montre jusqu'à la position d'arrêt "OFF". Ne forcez pas le bouton.
5. Fermez le compartiment de contrôle du bas.

LIGHTING INSTRUCTIONS — ELECTRONIC

FOR YOUR SAFETY READ BEFORE LIGHTING

WARNING: IF YOU DO NOT FOLLOW THESE INSTRUCTIONS EXACTLY, A FIRE OR EXPLOSION MAY RESULT CAUSING PROPERTY DAMAGE, PERSONAL INJURY OR LOSS OF LIFE.

- A.** When lighting the appliance, follow these instructions exactly.
- B.** BEFORE OPERATING smell all around the appliance area for gas. Be sure to smell next to the floor because some gas is heavier than air and will settle on the floor.
- WHAT TO DO IF YOU SMELL GAS**
- Extinguish any open flame.
 - Open windows.
 - Do not light any appliance.
 - Do not touch any electrical switches.
 - Do not use any phone in your building.
- Immediately call your gas supplier from a neighbor's phone.
 - If your gas supplier cannot be reached, call the fire department.
- C.** Use only your hand to turn the gas control lever. Never use tools. If the lever will not turn by hand, do not try to repair it, call a qualified service technician. Force or attempted repair may result in a fire or an explosion.
- D.** Do not use this appliance if any part has been under water. Immediately call a qualified service technician to inspect the appliance and to replace any part of the control system and any gas control which has been under water.

LIGHTING INSTRUCTIONS

1. **STOP!** Read the safety information above on this page.
2. Turn remote wall switch to "OFF."
3. Open lower control compartment door.
4. Verify main line shut-off valve is open.
5. Turn the OFF/ON switch to "OFF". Do not force.
6. Wait five (5) minutes to clear out any gas. If you then smell gas, STOP! Follow "B" in the safety information above on this page. If you do not smell gas, go to the next step.
7. Turn the OFF/ON switch to "ON". Do not force.
8. Turn "ON" all electrical power to appliance (remote wall or appliance switch).
9. Close lower control compartment door.

Honeywell Electronic Gas Control Valve

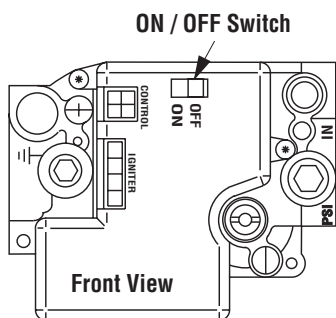

TO SHUT OFF

1. Turn off all electrical power to the appliance (remote wall switch).

TO TURN OFF GAS TO APPLIANCE

1. For complete shut-down, turn remote wall switch to "OFF."
2. Open lower control compartment door.
3. Turn the OFF/ON switch to "OFF". Do not force.
4. Close the main line shut-off valve.
5. Close lower control compartment door.

INSTRUCTIONS D'ALLUMAGE — ELECTRONIC

POUR VOTRE SÉCURITÉ, LISEZ CES INSTRUCTIONS AVANT L'ALLUMAGE

AVERTISSEMENT: SI VOUS NE SUIVEZ PAS CES INSTRUCTIONS À LA LETTRE, IL POURRAIT S'EN SUIVRE UN INCENDIE OU UNE EXPLOSION CAUSANT DES DOMMAGES MATÉRIELS, DES BLESSURES CORPORELLES OU MÊME DES PERTES DE VIE.

- A.** Lorsque vous allumez l'appareil, suivez exactement ces instructions.
- B. AVANT L'ALLUMAGE:** Assurez-vous que vous ne détectez aucune odeur de gaz autour de l'appareil ainsi que près du sol; certains gaz, étant plus lourds que l'air, descendent au niveau du sol.
- VOICI CE QUE VOUS DEVEZ FAIRE SI VOUS DÉCELEZ UNE ODEUR DE GAZ**
- Éteignez toute flamme visible.
 - Ouvrez les fenêtres.
 - N'allumez aucun appareil.
 - Ne touchez à aucun commutateur électrique.
 - Ne vous servez d'aucun téléphone dans votre édifice.
- Appelez immédiatement votre compagnie de gaz en utilisant le téléphone du voisin.
 - S'il vous est impossible de contacter votre compagnie de gaz, appelez le service des incendies.
- C.** N'utilisez que votre main pour manipuler l'interrupteur "ON/OFF" de la valve à gaz. N'utilisez jamais d'outils. Si l'interrupteur ne bouge pas manuellement, n'essayez pas de le réparer. Communiquez immédiatement avec un technicien de service qualifié. Toute tentative pour forcer l'interrupteur ou le réparer, risquerait de provoquer un incendie ou une explosion.
- D.** Ne vous servez pas de cet appareil si l'un de ses éléments a été immergé dans l'eau. Appelez immédiatement un technicien compétent pour faire inspecter l'appareil et remplacer toute pièce du système de réglage ou commande du gaz qui a été sous l'eau.

INSTRUCTIONS D'ALLUMAGE

- 1. ARRÊTEZ !** Lisez les consignes de sécurité au verso de cette plaque.
2. Tournez l'interrupteur mural à la position d'arrêt "OFF".
3. Ouvrez la porte du compartiment de contrôle du bas.
4. Assurez-vous que la soupape d'arrêt de la canalisation principale est ouverte.
5. Tournez la manette de réglage du gaz à la position d'arrêt "OFF".
6. Attendez cinq (5) minutes pour l'évacuation du gaz. Si vous décelez une odeur de gaz **ARRÊTEZ !** Retournez au point "B" des consignes de sécurité au verso de cette plaque. Si vous ne remarquez aucune odeur de gaz, passez à l'étape suivante.
7. Tournez la manette de réglage du gaz jusqu'à la position de marche "ON". Ne la forcez pas.
8. Ouvrez le courant électrique ("ON") qui alimente l'appareil (interrupteur mural).
9. Fermez la porte du compartiment de contrôle du bas.
10. Au besoin, rebrancher l'appareil au courant électrique et remettre l'interrupteur principal du brûleur à la position "ON" ou régler le thermostat à la température désirée.
11. Si l'appareil ne se met pas en marche, suivre les instructions intitulées "Pour fermer le gaz qui alimente l'appareil" et appeler un technicien ou le fournisseur de gaz.

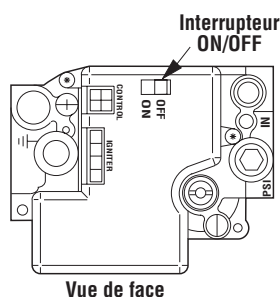

Vue de face

POUR ÉTEINDRE L'APPAREIL

1. Coupez tout le courant électrique qui alimente l'appareil (interrupteur mural).

POUR FERMER LE GAZ QUI ALIMENTE L'APPAREIL

1. Pour une fermeture complète, tournez l'interrupteur mural à la position d'arrêt "OFF".
2. Ouvrez la porte du compartiment de contrôle du bas.
3. Tournez la manette de réglage du gaz à la position d'arrêt "OFF". Ne la forcez pas.
4. Fermez la soupape d'arrêt de la canalisation principale.
5. Fermez la porte du compartiment de contrôle du bas.

TROUBLESHOOTING

Note: Before troubleshooting the gas control system, Ensure external gas shut off valve, located at gas supply inlet, (and wall switch, iff applicable), is in the “ON” position. Important: Valve system troubleshooting should only be accomplished by a qualified service technician.

TROUBLESHOOTING GUIDE - MILLIVOLT GAS CONTROL SYSTEM

SYMPTOM	POSSIBLE CAUSES	CORRECTIVE ACTION
1. Spark Igniter will not light pilot after repeated triggering of Igniter button.	A. Defective igniter (no spark at electrode).	Check for spark at electrode and pilot; if no spark and electrode wire is properly connected, replace Igniter.
	B. Defective or misaligned electrode at pilot (spark at electrode).	Using a match, light pilot. If pilot lights, turn off pilot and trigger the igniter button again. If pilot lights, an improper gas mixture caused the bad lighting and a longer purge period is recommended. If pilot will not light – check gap at electrode and pilot – should be 1/8" to have a strong spark. If gap measures 1/8", replace pilot (see Figure 8 on Page 8).
	C. Gas supply pressure errant.	Check inlet gas pressure. It should be within the limits as marked on the rating plate.
	D. Pilot orifice plugged.	Clean or replace pilot orifice.
2. Pilot will not stay lit after carefully following the lighting instructions.	A. Defective pilot generator (thermocouple).	Check pilot flame, it must impinge on thermocouple (see Figure 8 on Page 8). Clean and/or adjust pilot for maximum flame impingement on thermocouple. Ensure that the connection between the valve and thermocouple are tight and secure.
3. Pilot burning, no gas to burner, Valve knob “ON,” Wall Switch “ON.”	A. Limit Switch defective.	Isolate the “limit” switch. Disconnect the wires from the “ON/OFF” switch and the valve (label wires for reattachment). Test for continuity with a multimeter. If continuity is not indicated, switch is defective and must be replaced.
	B. Wall switch or wires defective.	Check wall switch and wires for proper connections. Jumper wire across terminals at wall switch, if burner comes on, replace defective wall switch. If okay, jumper wires across wall switch wires at valve, if burner comes on, wires are faulty or connections are bad.
	C. Thermopile may not be generating sufficient millivoltage.	Check thermopile with millivolt meter. Take reading at thermopile terminals of gas valve. Should read 325 millivolts minimum with optional wall switch “OFF.” Replace faulty thermopile if reading is below specified minimum.
	D. Plugged burner orifice.	Check burner orifice for stoppage and remove.
4. Frequent pilot/burner outage problem.	A. Pilot flame may be too low or blowing (high) causing the pilot/valve safety to drop out.	Clean and/or adjust pilot flame for maximum flame impingement on thermocouple (see Figures 8 on Page 8).

TROUBLESHOOTING GUIDE - ELECTRONIC IGNITION SYSTEM

SYMPTOM	POSSIBLE CAUSES	CORRECTIVE ACTION
1. Burner will not light.	A. Faulty Valve System.	See Below.
	B. “OFF/ON” or wall switch defective.	Disconnect the two black wires from the wire nuts. Test switch(s) for continuity with a multimeter. If continuity is not indicated, switch(s) is defective and must be replaced. Note: Before replacing “OFF/ON” switch, Ensure to check wiring for loose connections or broken wires and repair as needed.
2. Burners come “ON,” then turns “OFF.”	A. Burner orifice plugged.	Check main burner orifice(s) for blockage. Clean or replace.
	B. Obstructed vent system.	Check vent system for obstructions.

TROUBLESHOOTING PROCEDURE - ELECTRONIC IGNITION SYSTEM

START

- Turn Off Gas Supply.
- Ensure Valve Switch Is In ON Position.
- Disconnect Control Harness.
- Turn On Optional Remote Switch (if applicable)

Insert A

End View of Control Harness Connector

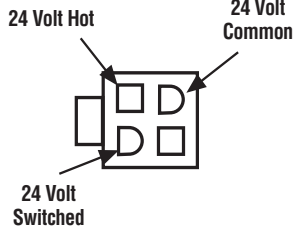

Check For Damaged or Missing Terminals in Connector

Insert B

Igniter Terminals

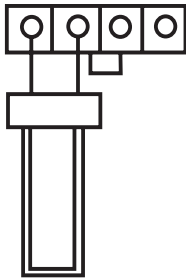

1 Igniter will cycle off and back on once during the 90 second ignition trial. All voltage measurements must be taken while the igniter is powered.

2 When measuring voltage at connections, use care to ensure terminals are not damaged.

CHECK

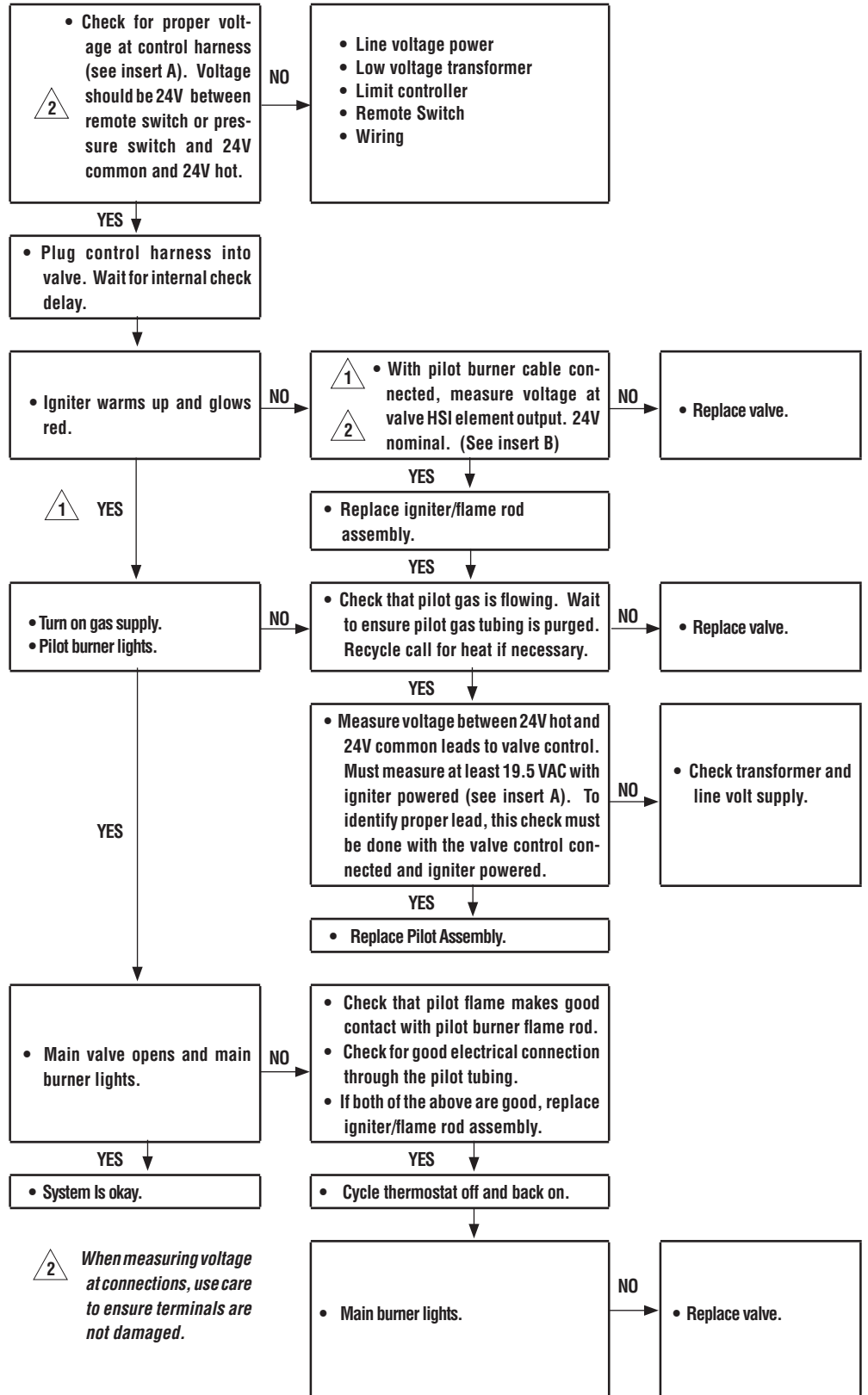

REPLACEMENT PARTS LIST

Item #	Description	MPB-3328		MPB-3530		MPB-4035		MPB-4540	
		Part No.	Qty.	Part No.	Qty.	Part No.	Qty.	Part No.	Qty.
1	Hood, Charcoal	H3898	1	H3895	1	H3896	1	H3897	1
2	Louver Assembly, Top Panel	H4332	1	H3926 (set)	1	H3899 (set)	1	H4330	1
3	Louver Assembly, Lower Panel	H4333	1		1		1	H4331	1
4	Enclosure, Glass Front (Complete)	H3889	1	H3881	1	H3941	1	H3892	1
5	Nameplate, Lennox (logo)	12L15	1	12L15	1	12L15	1	12L15	1
6	Latch	69L21	1	69L21	1	69L21	1	69L21	1
7	Catch, Door, Magnetic	69L31	2	69L31	2	69L31	2	69L31	2
8	Log Set (Complete)	24M15	1	24M22	1	24M25	1	24M25	1
9	Burner Assembly	24M58	1	24M58	1	24M59	1	24M59	1
10	Grate Assembly	H4329	1	H4329	1	H3639	1	H3639	1
11	Orifice, Main Burner - Natural Gas	39L66	1	60J80	1	24M10	1	18L40	1
11	Orifice, Main Burner - Propane Gas	99K78	1	19L52	1	21L01	1	37G00	1
12	Bag of Glowing Embers (Rockwool)	88L53	1	88L53	1	88L53	1	88L53	1
13	Bag of Decorative Volcanic Stone	80L42	1	80L42	1	80L42	1	80L42	1
14	Bag of Vermiculite	42363	1	42363	1	42363	1	42363	1
15	Gas Line Flexible Connector, FFGC	93L32	1	93L32	1	93L32	1	93L32	1
16	Spill Switch (high limit disc)	62L16	1	62L16	1	62L16	1	62L16	1

* Lennox Nameplate Logo, 12L15, is not included.

Gas Controls - SIT Millivolt					
Item #	Description	Natural Gas		Propane Gas	
		Part No.	Qty.	Part No.	Qty.
20	Gas Valve, SIT	43K07	1	88J53	1
21	Piezo Igniter	111061	1	111061	1
22	Pilot Assembly	69L17	1	69L18	1
23	Pilot Generator	60J79	1	60J79	1
24	Thermocouple	74L57	1	74L57	1
25	Pilot Tube	74L56	1	74L56	1
26	Electrode and Cable	74L58	1	74L58	1
27	Pilot Shield	H3737	1	H3737	1

Gas Controls - Honeywell Electronic					
Item #	Description	Natural Gas		Propane Gas	
		Part No.	Qty.	Part No.	Qty.
40	Gas Valve, Honeywell	62L18	1	62L19	1
41	Pilot Assembly	62L14	1	62L15	1
42	Transformer	42J32	1	42J32	1
43	Igniter Assembly (Kit)	87L54	1	87L54	1
44	Pilot Shield	H1596	1	H1596	1

REPLACEMENT PARTS

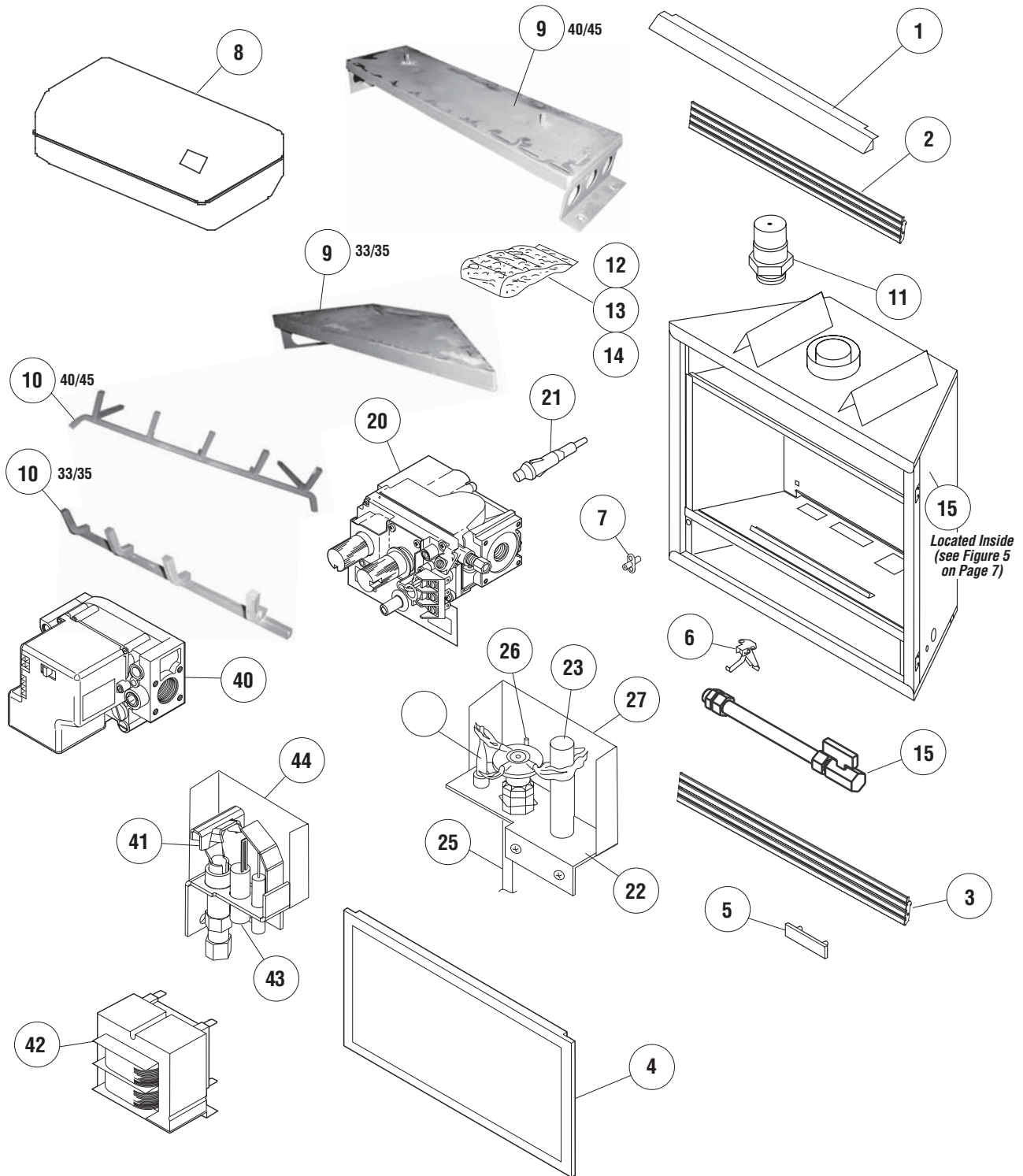

We recommend that our gas hearth products be installed and serviced by professionals who are certified in the U.S. by the National Fireplace Institute® (NFI) as NFI Gas Specialists.

NOTES

Lennox Hearth Products reserves the right to make changes at any time, without notice, in design, materials, specifications, prices and also to discontinue colors, styles and products. Consult your local distributor for fireplace code information.

Printed in U.S.A. © 2005 by Lennox Hearth Products
P/N 875,031M REV. A 02/2006



HEARTH PRODUCTS
1110 West Taft Avenue • Orange, CA 92865

Free Manuals Download Website

<http://myh66.com>

<http://usermanuals.us>

<http://www.somanuals.com>

<http://www.4manuals.cc>

<http://www.manual-lib.com>

<http://www.404manual.com>

<http://www.luxmanual.com>

<http://aubethermostatmanual.com>

Golf course search by state

<http://golfingnear.com>

Email search by domain

<http://emailbydomain.com>

Auto manuals search

<http://auto.somanuals.com>

TV manuals search

<http://tv.somanuals.com>