



VONAGE™
THE BROADBAND PHONE COMPANY™

Broadband Phone Start-Up Kit

- No Annual Contracts
- Money Back Guarantee
- Perfect for Home or Business
- Keep Your Current Number* Where available

Model: IP8100-2/81003

5.8
GHz
Digital Spread
Spectrum

Telephone Features Manual

Expandable up to 4 Handsets each with Caller ID with Handset Speakerphones
Download from www.Somanuals.com. All Manuals Search And Download.

Table Of Contents

IMPORTANT SAFETY INSTRUCTIONS	1
Parts Check List	3
The Handset Layout	4
The Base Unit Layout	5
GETTING STARTED	6
SETUP	6
Connecting power to Base Unit/Handset Charger	6
Installation of Battery Pack in Handset	6
Charging of the Handset Battery Pack	6
Reset Switch	7
Checking for Dial Tone	7
Wall Mounting	8
Installation Without A Router	9
Installation With A Router	11
BASIC OPERATION	12
Handset and Base Indicators	12
Handset Icons	12
Handset LEDs	12
Base LEDs	12
Handset Operation	13
Making Calls	13
Answering Calls	13
Adjust the Handset Volume	13
Flash Function	13
Redial Function	13
Dial Vonage Voicemail	14
Mute Function	14
Intercom Call	14
Call Forward	15
Conference Call	15
Base Operation	15
Phonebook Operation	16
Storing a New Entry	16
Reviewing/Dialing from the Phonebook	17
Editing a Phonebook entry	18
Delete a phonebook entry	18
Calls Log (Caller ID - Call Waiting)	19
Caller ID - Call Waiting ID	19
Reviewing Caller ID	19
Storing a Caller ID	20
Dialing from Caller ID	20
Deleting Caller ID	21
Handset Settings	22
Ringer Volume	22
Ringer Tone	22

Table Of Contents

Key Tone (preset to ON)	22
Language (preset to English)	23
Message Waiting	23
Clear Message waiting	23
ADVANCED OPERATION	24
Headset Operation	24
ADDITIONAL INFORMATION	25
In Case Of Difficulty	25
Maintenance	26
Warranty Statement	27
FCC and IC Regulations	30
Technical Specifications	32

Important Safety Instructions

When using your telephone equipment, basic safety precautions should always be followed to reduce the risk of fire, electric shock and injury, including the following:

1. Read and understand all instructions.
2. Follow all warnings and instructions marked on the product.
3. Unplug this product from the power outlet and broadband connection before cleaning. Do not use liquid cleaners or aerosol cleaners. Use a damp cloth for cleaning.
4. Do not use this product near water (for example, near a bath tub, kitchen sink, or swimming pool).
5. Do not place this product on an unstable cart, stand, or table. The product may fall, causing serious damage.
6. Slots and openings on the base and handset are provided for ventilation. To protect it from overheating, these openings must not be blocked by placing the product on the bed, sofa, rug, or other similar surface. This product should never be placed near or over a radiator or heat register. This product should not be placed in a built-in installation where proper ventilation is not provided.
7. This product should be operated only from the type of power source indicated on the marking label. If you are not sure of the type of power supply to your home, consult your dealer or local power company.
8. Do not allow anything to rest on the power cord. Do not locate this product where the cord will be abused by persons walking on it.
9. Never push objects of any kind into this product through the slots in the base or handset as they may touch dangerous voltage points or short out parts that could result in a risk of fire or electric shock. Never spill liquid of any kind on the product.
10. To reduce the risk of electric shock, do not disassemble this product, but take it to an authorized service facility. Opening or removing cabinet parts other than specified access doors may expose you to dangerous voltages or other risks. Incorrect reassembling can cause electric shock when the appliance is subsequently used.
11. Do not overload wall outlets and extension cords as this can result in the risk of fire or electric shock.
12. Unplug this product from the wall outlet and contact VTech under the following conditions:
 - A. When the power supply cord or plug is damaged or frayed.
 - B. If liquid has been spilled into the product.
 - C. If the product has been exposed to rain or water.
 - D. If the product does not operate normally by following the operating instructions. Adjust only those controls that are covered by the operating instructions, because improper adjustment of other controls may result in damage and will often require extensive work to restore the product to normal operation.

Important Safety Instructions

- E. If the product has been dropped and the handset and/or base unit has been damaged.
- F. If the product exhibits a distinct change in performance.
- 13. Avoid using a telephone (other than cordless) during an electrical storm. There may be a remote risk of electric shock from lightning.
- 14. Do not use this or any cordless telephone to report a gas leak in the vicinity of the leak.
- 15. Use only the power cord and batteries indicated in this manual. Do not dispose of batteries in a fire. They may explode. Check with local codes for possible special disposal instructions.

SAVE THESE INSTRUCTIONS

BEFORE USING YOUR IP 8100-2/8100-3 SYSTEM, CAREFULLY PEEL OFF THE PROTECTIVE FILM COVERING THE DISPLAYS.

Parts Check List

The IP 8100-2/8100-3 is an advanced Broadband cordless telephone set, capable of supporting four handsets.

This manual is designed to familiarize you with this Broadband cordless telephone. We strongly recommend you read the manual before using your phone.

1. Base Unit
2. Handsets
3. Handset Chargers
4. Ethernet Cable
5. Base Power Adapter
6. Charger Wall Mounting Bracket
7. Belt Clips
8. User Documentation CD
9. Quick Start Guide
10. Batteries

NOTE: USE ONLY VTech Battery 80-5808-00-00 or VTech Replacement 89-1324-00-00.

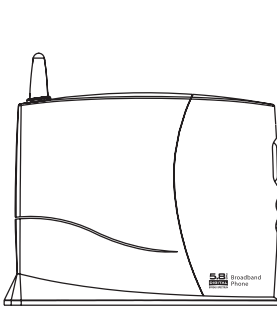

Base Unit



Handset

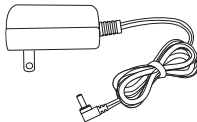
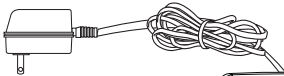

Base AC Adapter

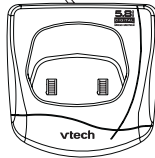

Handset Charger

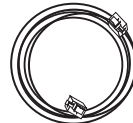

Ethernet Cable

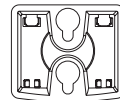

Charger Wall Mounting Bracket



Belt Clip



User Documentation CD



Quick Start Guide



Battery

NOTE: If you have purchased the IP 8100-3, please also refer to the parts list in your IP 811 User's Manual.

The Handset Layout

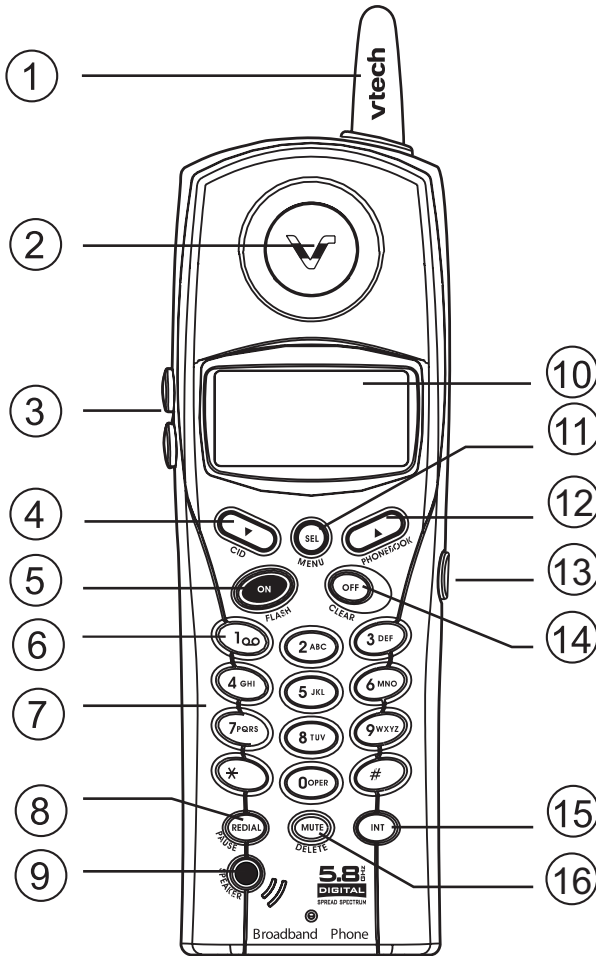

- | | |
|-----------------------------|---------------------------|
| 1. Antenna | 9. Speakerphone |
| 2. Earpiece | 10. LCD Display |
| 3. Volume Control | 11. Select (Menu) |
| 4. CID (Scroll Down) | 12. Phonebook (Scroll Up) |
| 5. On (Flash) | 13. Headset Jack (2.5mm) |
| 6. Voicemail | 14. Off (Clear) |
| 7. Dialing Keys (0-9, *, #) | 15. Intercom |
| 8. Redial (Pause) | 16. Mute (Delete) |

The Base Unit Layout

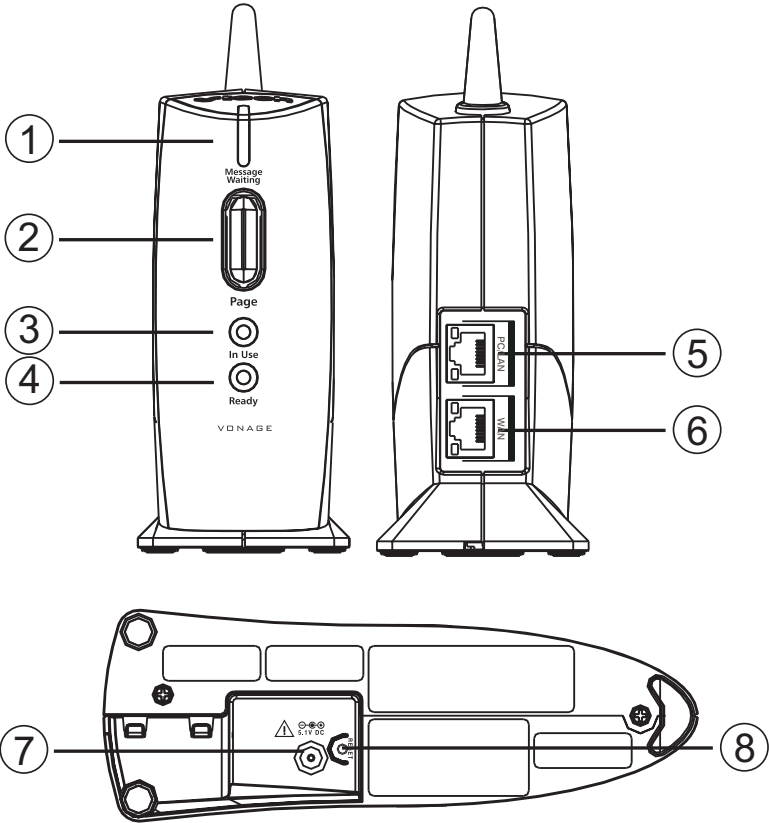

1. Message Waiting LED
2. Page key
3. In Use LED
4. Service Status LED
5. LAN Port
6. WAN Port
7. DC Connector Jack
8. Reset Switch

Setup

Connecting power to Base Unit/Handset Charger

1. Plug the power adapter into an electrical outlet, and the connector into the connector jack at the bottom of the base unit.
2. Choose the location for your handset charger, and plug its power supply into an electrical outlet.

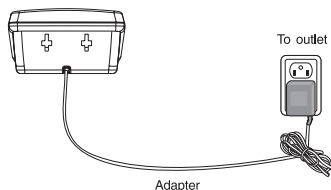

Installation of Battery Pack in Handset

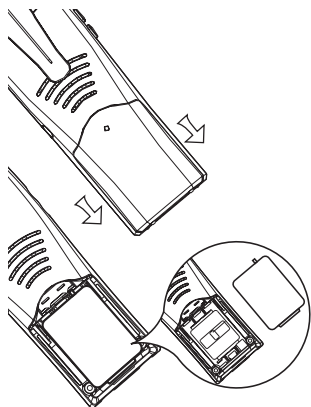

Follow the steps below:

1. Remove the battery compartment cover by pressing on the indentation and sliding downward. Place the new battery pack in the handset with the positive and negative poles aligned in the battery compartment.
2. Replace the battery cover by sliding it upwards.
3. If the new battery pack is not already charged, place the handset in its charger, and allow it to charge for 10-12 hours. After initial charge, a maintenance charge of 8 hours should be sufficient.

Charging of the Handset Battery Pack

The handset of your cordless telephone is powered by a rechargeable battery pack. It charges automatically whenever handset is in its charger.

You should charge the batteries for 10-12 hours when you first receive your phone. You will know the battery pack needs charging when:

- The low battery message is displayed:
- The handset seems completely dead, the LCD is completely clear and does not activate when you press the keys.

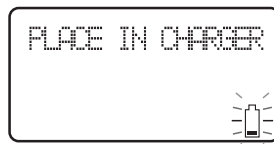

NOTE: While in **PLACE IN CHARGER** (low battery) mode, the keypad sounds, backlighting and speakerphone features will not work. When the battery has been charged, the features will return to their normal function.

IMPORTANT:

1. Do not dispose of the battery pack in a fire, it might explode.
2. Do not open or mutilate the battery pack. Toxic substances may be released, causing harm to eyes or skin.
3. Exercise care in handling batteries in order to prevent an accidental short of the charge contacts, potentially causing the batteries to overheat.

Setup

4. Do not dispose of the battery pack into household garbage. Please refer to the information concerning proper battery recycling.
5. Do not charge the battery pack with other electrical devices.

Reset Switch

The reset switch, when quickly pressed and released, will reset the phone and restart the software. Beware that when the reset switch is pressed and held for > 10 seconds and then released, the phone will restore to factory defaults. This includes clearing and resetting the password on the web configuration.

Reset switch does not affect your base unit power, RF operation, or any of the telephone handset settings.

Checking for Dial Tone

After the battery is charged, press **ON** on the handset. The LCD displays **PHONE** and shows a call timer, and you will hear a dial tone. If not, see **In Case of Difficulty**.

⚠ CAUTION: Use only the VTech power supply provided with your telephone.

IMPORTANT! MAXIMUM PERFORMANCE OF YOUR CORDLESS TELEPHONE SYSTEM:

1. Install your base unit and extension handsets away from electronic equipment, such as personal computers, television sets and microwave ovens.
2. In locations where there are multiple cordless telephones, separate the base units as far away as possible.
3. Install your telephone equipment away from heat sources and sunlight.
4. Avoid excessive moisture, dust or extreme cold.

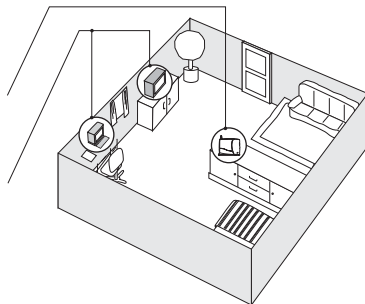

Add new handsets to make your phone more versatile

Your telephone can accommodate up to four cordless handsets. You can add new handsets (Model IP 811, sold separately) at any time. You can register a maximum of four handsets.

Wall Mounting

The wall mount brackets are designed for use on standard wall mount plates only. Wall mounting is optional. Only the handset chargers (not the main base unit) can be wall mounted.

1. Plug the power adapters into electrical outlets, and the connector to the bottom of the handset charger.
2. Line up the tabs on the wall mount brackets with the holes at the back of the handset charger. Snap the wall mount bracket firmly in place.
3. Mount the handset charger on the wall. Position the handset charger so the mounting studs will fit into the holes on the wall mount bracket. Slide handset charger down on the mounting studs until it locks into place.

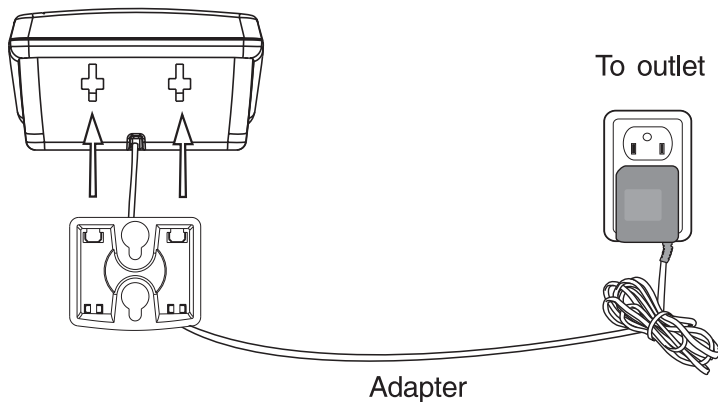

Setup

Installation Without A Router

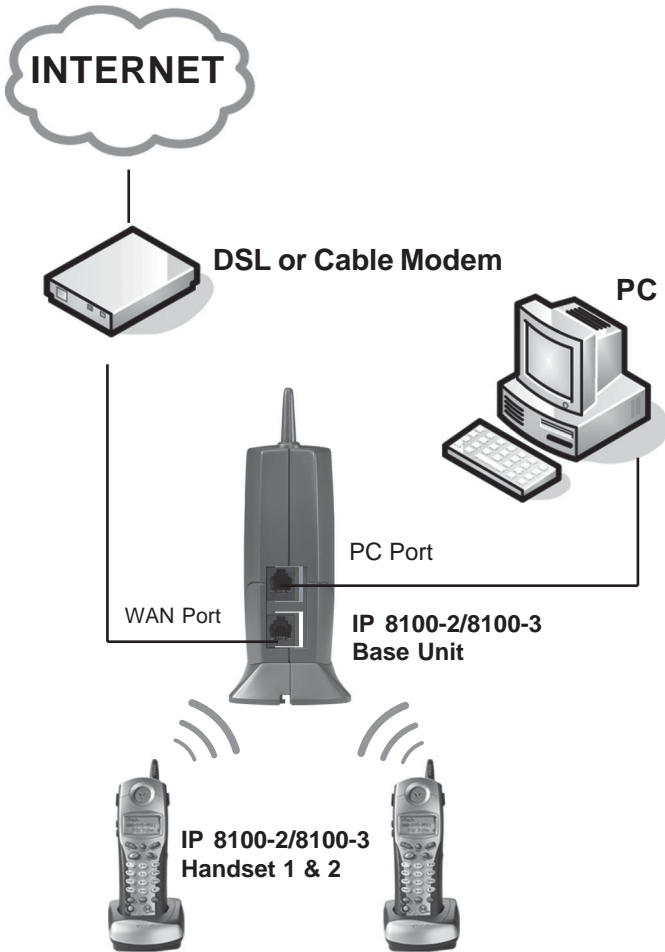

NOTE: The IP 8100-2/8100-3 is expandable up to a total of 4 handsets. Uses model IP 811 (sold separately)

Warning: Do not route the ethernet cable to outdoors, and ensure that you are using a safety approved ADSL or Cable modem with proper electrical isolation.

Setup

- STEP 1** Unplug the power cord for your cable/DSL modem. Make sure that you've turned your computer off, and that you do NOT plug in your IP 8100-2/8100-3 broadband telephone until instructed to do so.
- STEP 2** Disconnect the Ethernet cable from the back of your computer and then plug it into the WAN port (with white marking) on your IP 8100-2/8100-3.
- STEP 3** Using the Ethernet cable provided, connect one end into the PC/LAN port (with blue marking) of your IP 8100-2/8100-3, and connect the other end into the Ethernet port on your PC.
- STEP 4** Reconnect the power cord for your cable/DSL modem and turn on power to the unit.
- STEP 5** Plug the power cord into the POWER port on your IP 8100-2/8100-3 and into an electrical outlet. This turns your IP 8100-2/8100-3 broadband telephone on.
- NOTE:** After IP 8100-2/8100-3 is powered on, update files will download. DO NOT interrupt this registration process by unplugging the power or use the IP 8100-2/8100-3 handsets until the ready indicator light on the front of IP 8100-2/8100-3 base has gone from flashing yellow to a steady green.
- STEP 6** Power up the computer.
- STEP 7** If you are a DSL user who is required to enter a user name and password (PPPoE) when accessing the Internet or a user with a static IP address, you need to complete this step, otherwise skip this step.

A. Open a web browser such as Microsoft® Internet Explorer using the computer connected through your IP 8100-2/8100-3 PC port. In the address or location field, type: `http://192.168.15.1` and press ENTER. This displays the Login screen. Enter the default password 'VTech' and click on Login.

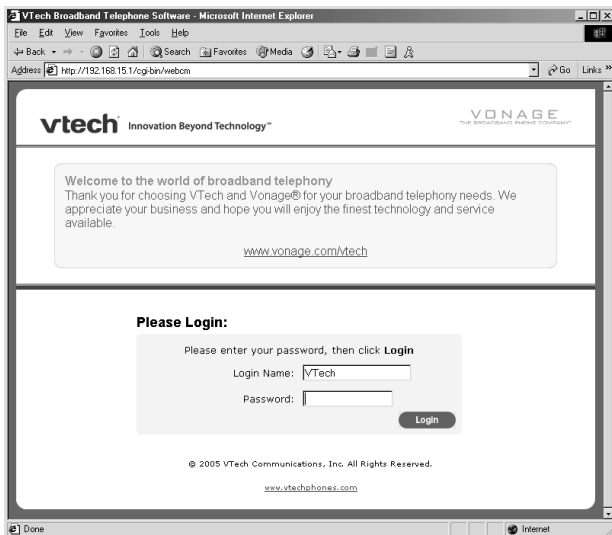

B. Click Run Wizard to start the set-up.

C. Follow Wizard screens to complete the setup.

For complete instructions on web configuration screens, please refer to the Base Unit Features section of the user manual on the enclosed CD.

Setup

Installation With A Router

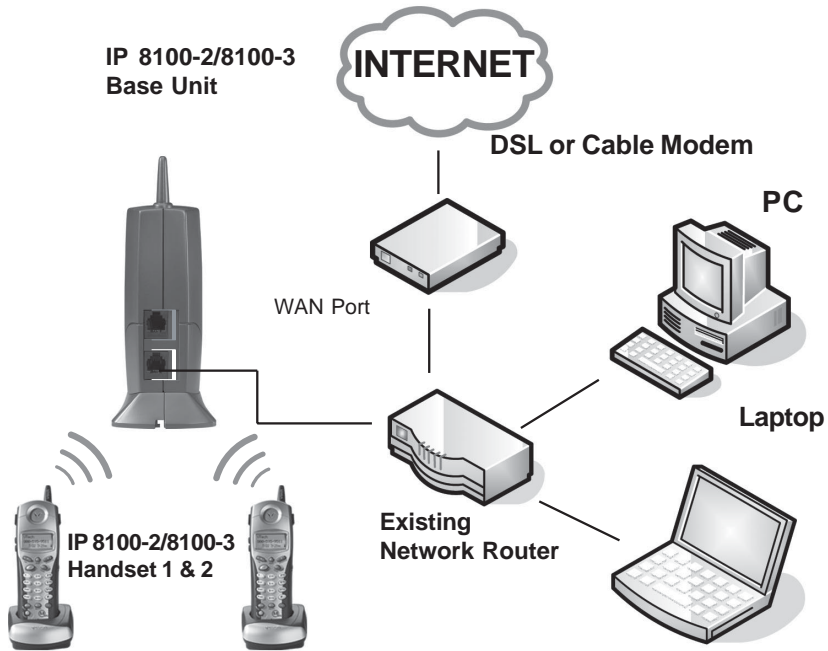

Warning: Do not route the ethernet cable to outdoors, and ensure that you are using a safety approved ADSL or Cable modem with proper electrical isolation.



STEP 1 Using the Ethernet cable provided, connect one end into the WAN port (with white marking) on the IP 8100-2/8100-3 broadband telephone, and connect the other end into an available LAN port on your router.

STEP 2 Plug the power cord into the POWER port on the IP 8100-2/8100-3 and into an electrical outlet. This turns your IP 8100-2/8100-3 on.

NOTE: After IP 8100-2/8100-3 is powered on, update files will download. DO NOT interrupt this registration process by unplugging the power or use the IP 8100-2/8100-3 Handsets until the VoIP indicator light on the front of IP 8100-2/8100-3 Base has gone from flashing yellow to a steady green.

Handset and Base Indicators

Handset Icons

Icon	Description
MUTE	<ul style="list-style-type: none"> Turns on when the microphone is muted.
NEW	<ul style="list-style-type: none"> Turns on when there are new call log entries.
	<ul style="list-style-type: none"> Turns on when the ringer is muted.
	<ul style="list-style-type: none"> Low battery indicator and charging indicator.

Handset LEDs

LED	Description
SPEAKER	<ul style="list-style-type: none"> LED is on when in handsfree mode.

Base LEDs

LED	Description
IN USE	<ul style="list-style-type: none"> On when the phone is off hook. Flashes when an extension phone is off hook.
MESSAGE WAITING	<ul style="list-style-type: none"> Flashes when you have voicemail.
Ready	<ul style="list-style-type: none"> Solid Red: Internet Service currently not available. No connection to the ISP. Either (a) wait for the connection to be completed, (b) ensure ISP configuration is correct (and user/password is entered, if PPPoE), or (c) contact ISP for assistance. Flashing Red: Error condition not related to ISP connection. Contact Vonage Customer Care 866-243-4357. Solid Yellow: Connecting to Vonage, please wait Flashing Yellow: Connecting to Vonage PLEASE DO NOT UNPLUG THE POWER TO THE ip8100. This process may take a few minutes, please wait Solid Green: Line ready to use Flashing Green: Software upgrade in progress, may make and receive calls
WAN/LAN port	<ul style="list-style-type: none"> Green: Link/activity indicator (off = no connection, on steady = connected, blinking = activity detected) Yellow: Connection speed indicator (off = 10Mb/s, on = 100Mb/s)

Handset Operation

Making Calls

- Press **ON** (or, **SPEAKER** to use the handset speakerphone feature). Dial the phone number.
- Dial the phone number first; then press **ON** (or **SPEAKER**).
- Press **OFF** to end your call.

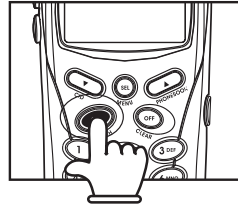

Answering Calls

- Press **ON, SPEAKER** or any dialing keys.
- Press **OFF** to end your call.

If the handset is in idle mode during an incoming call, the ringer can be temporarily muted by pressing **OFF** or **MUTE**, or by adjusting the ringer volume using the volume keys. If the ringing is muted completely (by pressing **OFF** or **MUTE**, or adjusted to ringer level 0 using the volume keys), the ringer mute icon will turn on indicating the ringing is being muted.

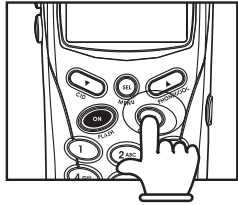

This feature is useful when you need to lower or stop the ringing quickly without actually answering the call. For example, someone is sleeping in the room and you want to check the caller ID before answering, or you want to ignore just the current call.

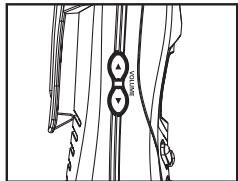

This adjustment is temporary, and only last for the current ringing call. The ringer volume will return to it's normal setting once the call is answered or when the ringing stops.

Adjust the Handset Volume (also applies to the handset speakerphone and headset)

- The volume control is on the **left** edge of the handset. During a call, press **VOLUME ▲** or **▼** keys to adjust the listening volume to a comfortable level. When you reach the maximum or minimum setting, a double-beep will sound.

Flash Function

- You can use your IP 8100-2/8100-3 with services such as call waiting. When you receive a call waiting signal, simply press the **ON/FLASH** key to switch to the new call. Press **ON/FLASH** again to switch back to the original call.

REDIAL
595-9511

Redial Function

- Press **REDIAL/PAUSE** to display the last telephone number dialed from the handset (up to 32 digits). Use **▲** or **▼** to scroll through the five previously dialed numbers. When the beginning or the end of the redial list is reached, a double beep will sound.
- When the desired number is reached, press **ON** or **SPEAKER** to dial.
- Pressing **OFF** will exit the redial review list.

NOTE: When the redial memory is empty, and **REDIAL** is pressed, a double beep will sound.

Handset Operation

- When the desired entry displays, press **DELETE**. You'll hear a confirmation beep.

Dial Vonage Voicemail

Press and hold #1 key to dial Vonage Voicemail.

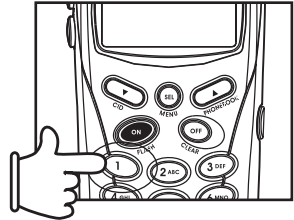

Mute Function

- During an active call, pressing the **MUTE/DELETE** key will disable the microphone. **MICROPHONE MUTED** will display briefly. The screen will display:
- Press **MUTE/DELETE** again to return to normal two-way conversation. **MICROPHONE ON** will display briefly.

PHONE 00: 00: 15
MI CROPHONE MUTED

ENTER
HANDSET #

CALLI NG
HANDSET X

HANDSET X
I S CALLI NG

I NTERCOM

I NTERCOM ENDED

UNABLE TO CALL
TRY AGAI N

Intercom Call

- From the idle (off) mode, press INT. The handset (HS1) will display:
ENTER HANDSET #
- Select a number of the handset to be called. The display will show: **CALLING HANDSET X** (Where X is the handset number.)
- The other handset will ring and the screen will display:
HANDSET X IS CALLING
- Press **INT**, **PHONE**, **SPEAKER** or any of the dial pad keys on handset X to answer the intercom call. The screens will display:
- Press **INT** or **OFF** on either handset to end the call.

NOTE: If handset X is out of range, or on an external call, when HS1 attempts to intercom it, the display of HS1 will show:

Handset Operation

Call Forward

- While on an external call, one handset (HS1) can forward it to any other handset:
- Press INT on HS1, it will display:
- Enter the handset number you wish to forward, HS1 will display:
- HS X can press **ON** to answer the call.

NOTE: If HS X does not respond in about 30 seconds, the external call will be returned to HS1 and the display will show:
If the returned call is not answered within 30 seconds, the external call will end automatically.

Conference Call

It is possible to establish a conference between two handsets and the external line.

If a handset already has a connection to the external line, and another handset goes off-hook, a conference is immediately established. Both handsets will show:

Base Operation

From the base unit, you can use the **PAGE** key to locate the handsets.

- When the handset is in idle, press **PAGE**.
The handsets will display:
- To end the page at the handset, press **ON**, **SPEAKER** or any dialing keys.
- To end the page at the base, press **PAGE**.

ENTER HANDSET #

CALL FORWARDED

CALL BACK

CONF. 00: 00: 25

BASE I S
PAGI NG

Phonebook Operation

Your IP 8100-2/8100-3 can store up to 50 numbers with names in memory. Each memory location can hold up to 32 digits for the number and 16 characters for the name.

NOTE: The handsets share a common phonebook, which is stored in the base. This means that entries inserted by one handset are available for all handsets, and if one deletes a phonebook entry, it will disappear from all handsets.

When one handset is accessing the phonebook, the other handsets cannot access it at the same time. If this is attempted, **NOT AVAILABLE AT THIS TIME** will display.

Storing a New Entry

- Press **MENU**.
- With **PHONEBOOK** highlighted, press **SEL**.
- Press ▼ to select **STORE**. Press **SEL**.
- You will be prompted to **ENTER NUMBER**. Use the dialing keys to enter the number you wish to store in the phonebook. Press the **MUTE/DELETE** key to backspace and make corrections. Press **SEL**.
- You will then be prompted to **ENTER NAME**. Use the dialing keys to spell the name. Press **SEL**.
- You will hear a confirmation tone, and the new phonebook entry will display briefly.

>STORE
REVI EW

ENTER NUMBER
800-595-9511

ENTER NAME
—

NOTES:

- If the phonebook is full, the handset will display **PHONEBOOK IS FULL**.
- You can also press **REDIAL/PAUSE** then ▲ or ▼ to scroll to the previously dialed number from the redial list you want to store in the phonebook. Pressing **SEL** will append the selected redial number to the current editing number.
- While entering numbers, press and hold **REDIAL/PAUSE** to add pauses if necessary.
- If there is a duplicate number in the phonebook, the display will show:

PHONEBOOK
IS FULL

NUMBER ALREADY
IN PHONEBOOK

Phonebook Operation

Each press of a particular key causes characters to be displayed in the following order:

Key	Characters by number of key presses								
	1	2	3	4	5	6	7	8	9
1	space	1							
2	A	B	C	2	a	b	c		
3	D	E	F	3	d	e	f		
4	G	H	I	4	g	h	i		
5	J	K	L	5	j	k	l		
6	M	N	O	6	m	n	o		
7	P	Q	R	S	7	p	q	r	s
8	T	U	V	8	t	u	v		
9	W	X	Y	Z	9	w	x	y	z
0	0								
*	*	?	!	/	()			
#	#	'	,	-	.	&			

Reviewing/Dialing from the Phonebook

- Press **MENU** With **PHONEBOOK** in the first line, press **SEL**. With the **REVIEW** in the first line, press **SEL** again.

- OR -

With the handset idle, press ▲ and the handset jumps directly into the phonebook review mode. The first phonebook entry will be displayed.

- Scroll through the phonebook entries using ▲ or ▼ keys or enter first character of the name to be searched (using the digit keys) and continue scrolling using the ▲ and ▼ keys, until you reach the entry to be dialed.

NOTE: When reviewing the phonebook, the second line of the display will show the phone number, up to 16 digits. For numbers longer than 16 digits, only the first 13 digits will be shown. Press * or # to scroll the phone number to see the additional digits.

- Press **ON** or **SPEAKER**, to dial the number.

NOTE: If there are no entries in the phonebook, when it is accessed, **PHONEBOOK IS EMPTY** will display.

VTech
595-9511

VTech Com
800-595-9511

PHONE 00: 00: 10
VTech Com

VTech Com
800-595-9511

Phonebook Operation

Editing a Phonebook Entry

- Follow the first two steps in **Reviewing/Dialing from the phonebook** (on previous page) to reach the entry to be edited.
- Press **SEL**.
- Press **MUTE/DELETE** to backspace then enter the correct number. Press and hold **REDIAL/PAUSE** to add pauses if necessary. You can also press **REDIAL/PAUSE**, then ▲ or ▼ to scroll to the previously dialed number from redial list which you want to store in the phonebook. Pressing **SEL** will append the selected redial number to the current editing number.
- Press **SEL** to confirm the number and enter name edit mode.
- Press **MUTE/DELETE** to backspace and use the digit keys to enter the correct name.
- Press **SEL** to confirm the change. A confirmation tone will sound.

EDIT NUMBER
800-595-9511_

EDIT NAME
VTech_

VTech
595-9511

Delete a Phonebook Entry

- Follow the first two steps in **Reviewing/Dialing from the Phonebook** on previous page to reach the entry to be deleted.
- Press **MUTE/DELETE** to delete the entry. A confirmation tone will sound.
- The handset will then move to the next entry, if any.

VTech Com
800-595-9511

VTech
595-9511

Calls Log (Caller ID - Call Waiting)

Caller ID - Call Waiting ID

Your IP 8100-2/8100-3 is capable of displaying the name and/or number of the party calling before you answer the phone (caller ID). It is also capable of displaying caller ID information in conjunction with a call waiting alert signal (call waiting caller ID). With call waiting caller ID, the caller ID data is displayed so you can decide whether to answer the incoming call, or continue with your current conversation. Your IP 8100-2/8100-3 can hold up to 50 CID entries.

These are subscription services, provided by Vonage.

When one handset is accessing the call log, the other handsets can not access it at the same time. If this is attempted, **NOT AVAILABLE AT THIS TIME** will display.

Due to regional incompatibilities, caller ID information may not be available for every call you receive. In addition, the calling party may intentionally block their name and/or phone number from being sent.

- As new caller ID/call waiting ID records are received, your handset displays will alert you to the new caller ID records, for example:
- After you review all new caller ID records, the **NEW** call indication will be turned off and the screen will show:
- If the call log is full, the oldest entry is deleted to make room for the new call. If the call log is empty when you try to enter to call log review, the following message is displayed:

HANDSET 1
5 NEW CALLS
NEW

HANDSET 1

CALL LOG
IS EMPTY

Reviewing Caller ID

You can review the caller ID record via the menu, as described below or by pressing the ▼ key in idle whereby the handset jumps directly to the caller ID review.

- In idle mode, press **MENU** to enter the menu.
- Press ▼ key to scroll to **CALL LOG**.

>CALL LOG
RI NGER VOLUME

Calls Log (Caller ID - Call Waiting)

- Press **SEL**. Use ▲ or ▼ to scroll through the call log entries.
- When the beginning or the end of the call log is reached, a double beep will sound.

NOTE: The NEW icon in the left down corner indicates the call is not yet reviewed.

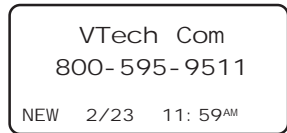

Storing a Caller ID

- Follow the steps in **Reviewing Caller ID** to scroll to the record to be stored.
- Press **SEL**.
- If the CID record contains both name and number, press **SEL** to store it into memory.
- If the CID record does not contain a name, you will be prompted to **EDIT NAME**, the screen will show: **EDIT NAME**.
- If the CID record does not contain a number, you will be prompted to **EDIT NUMBER**, the screen will show: **EDIT NUMBER**.
- You will hear a happy tone then the screen will display:
- If the caller ID isn't able to detect a name, **ENTER NAME** will be prompted. If unable to detect the number, **ENTER NUMBER** will be prompted. You will then need to add the name or the number.
- If the phone number already exists in the phonebook, the entry will not be stored, and the screen will show:
- If the phonebook is full, the screen will show:
- If both name and number are missing, for example as in a private listing, the request will be rejected with the message:

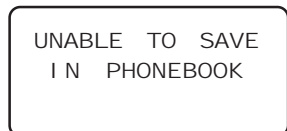
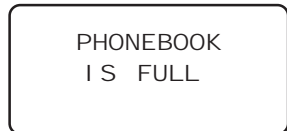
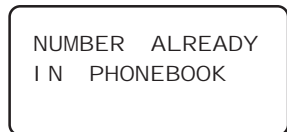
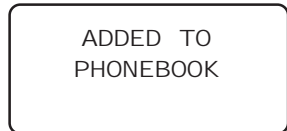
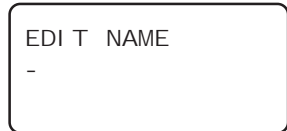

Dialing from Caller ID

- Follow the steps in **Reviewing Caller ID** to scroll to the entry to be dialed.
- Press **ON** or **SPEAKER** key to dial the number.

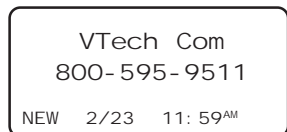

Calls Log (Caller ID - Call Waiting)

Deleting Caller ID

- Follow the steps in **Reviewing Caller ID** to scroll to the record to be deleted.
- Press **DELETE** key to delete the desired record. A confirmation tone will sound and the previous caller ID record will be displayed on the screen.
- To delete all the caller ID records, press and hold the **DELETE** key. The screen will ask you **DELETE ALL CALLS?** Press **SEL** for confirmation. Or, press **OFF** to return to the CID record previously displayed.

VTech Com
800-595-9511

NEW 2/23 11:59^{AM}

DELETE ALL
CALLS

Handset Settings

Ringer Volume

- From the idle (off) mode, press **MENU** then **▲** or **▼** key to **RINGER VOLUME**.
- Press **SEL**. The current ringer volume will be shown:
- Press **▲** and **▼** keys or enter digit 0-6 to the desired ringer volume. The current ring tone is played and the volume bar is increased/decreased each time the setting is adjusted. At the lowest setting, display will show:
- The handset will not ring when a call comes in if ringer volume is set to the lowest setting.
- Press **SEL** to confirm the setting.

>RINGER VOLUME
RINGER TONE

RINGER VOLUME
■■■■■

RINGER VOLUME



>RINGER TONE
KEY TONE

Ringer Tone

- From the idle (off) mode, press **MENU** then **▲** or **▼** key to **RINGER TONE**.
- Press **SEL**. You will be prompted to choose **INTERCOM CALL** or **OUTSIDE CALL**. Press **▲** or **▼** to select the desired option.
- Press **SEL** again. You can then use **▲** or **▼** or enter digit 0-9 to sample the ring tones. The screen, will show:
- Press **SEL** to confirm your setting.

>INTERCOM CALL
OUTSIDE CALL

>INTERCOM TONE
1

Key Tone (preset to ON)

- From the idle (off) mode, press **MENU** then **▲** or **▼** to **KEY TONE**.
- Press **SEL**. The current setting will be shown. Press **▲** or **▼** to scroll to **ON** or **OFF**. When set to on, the handset will emit a beep whenever a key is pressed.
- When the desired option is shown, press **SEL** to confirm your selection.

>KEY TONE
LANGUAGE

KEY TONE
OFF

Handset Settings

Language (preset to English)

- From the idle (off) mode, press **MENU** then **▲** or **▼** key to **LANGUAGE**.
- Press **SEL** to select this option. Press **▲** or **▼** to scroll from English to French or Spanish.
- Press **SEL** to confirm the setting.

>LANGUAGE
CLEAR MSG WAIT

LANGUAGE
FRENCH

Message Waiting

Your IP 8100-2/8100-3 is capable of detecting a message waiting signal generated by Vonage.

Once you have reviewed all new messages, the message waiting alert will automatically be turned off.

Clear Message Waiting

If, after reviewing all new voicemail messages, the message waiting alert still remains on the screen and the **MESSAGEWAITING** LED on base is still flashing, you can manually remove the indication from the screen and turn the LED off.

- From the idle (off) mode, press **MENU** then **▲** or **▼** to **CLEAR MSG WAIT**.
- Press **SEL** then the display will ask you **TURN INDICATOR OFF?** Press **SEL** again to confirm. To exit, press **OFF**.

>CLEAR MSG WAIT
DI AL TYPE

TURN I NDI CATOR
OFF?

Headset Operation

Your IP 8100-2/8100-3 handset is equipped with a 2.5mm headset jack for use with an optional accessory headset for handsfree operation. If you choose to use the headset option, you must obtain an optional accessory headset, which is compatible with the IP 8100-2/8100-3.

To purchase a headset, visit us on the web at www.vtechphones.com or call VTech Customer Service at 1-800-595-9511.

Once you have a compatible 2.5mm headset, locate the headset jack on the IP 8100-2/8100-3 handset. Connect the plug on the headset cord to the jack (under a small rubber flap) on the cordless handset. The plug should fit securely. Do not force the connection.

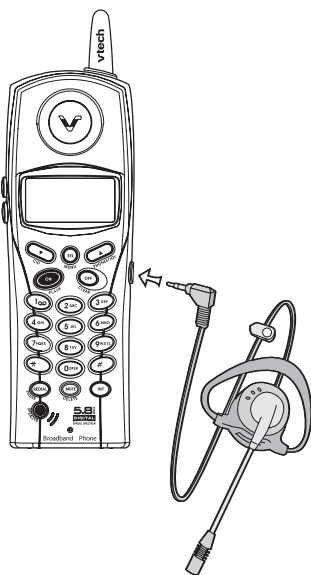

NOTE:

- Whenever a compatible headset is connected to the cordless handset, the microphone on the handset will be muted. This is done to limit the effect of background noise.
- When a compatible headset is connected to the cordless handset, your speakerphone feature will be disabled. To use your speakerphone feature, simply disconnect the headset from the handset.

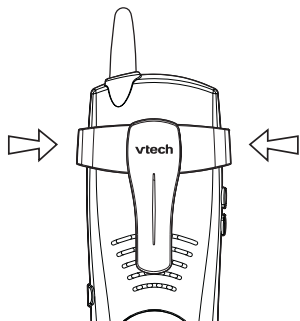

Belt Clip

The IP 8100-2/8100-3 is also equipped with a detachable belt clip. Align the pins on the inside edge of the clip with the notches on the sides of the handset. The belt clip should snap securely into place. Do not force the connection.

In Case Of Difficulty

The Phone Doesn't Work At All

- Make sure the power cord is plugged in.
- Make sure the Ethernet cable is plugged firmly into the base unit and the broadband connection.
- Make sure the batteries are properly charged. If you get a **LOW BATTERY** message or indication, the batteries need charging.

No Dial Tone

- First check all the suggestions above.
- Please refer to the **Troubleshooting** section of the **Base Unit Features Manual**.

You Get Noise, Static, Or A Weak Signal Even When You're Near The Base Unit

- Household appliances plugged into the same circuit as the base unit can sometimes cause interference. Try to move the appliance or the base unit to another outlet.

You Get Noise, Static, Or A Weak Signal When You're Away From The Base Unit

- You may be out of range. Either move closer to the base, or relocate the base unit.
- The layout of your home may be limiting the range. Try to move the base unit to another position.

The Handset Does Not Ring When You Receive A Call

- Make sure you have the ringers activated. Refer to the section(s) on **Ringer Volume** in this user's manual.
- Make sure the ethernet cable is plugged firmly into the base unit and the broadband connection. Make sure the power cord is plugged in.
- You may be too far from the base unit.

You Hear Noise In The Handset, And None Of The Keys Or Buttons Work

- Make sure the power cord is plugged in.

Common Cure For Electronic Equipment

If the unit does not seem to be responding normally, then try to put the handset in the charger. If it does not seem to respond, do the following (in the order listed):

1. Disconnect the power to the base.
2. Disconnect the handset battery pack.
3. Wait a few minutes.
4. Connect power to the base.
5. Re-install the battery pack.
6. Watch for handset to display **HANSET X**.

SEARCHING...

Maintenance

Taking Care Of Your Telephone

Your cordless telephone contains sophisticated electronic parts, so it must be treated with care.

Avoid rough treatment

Place the handset down gently. Save the original packing materials to protect your telephone if you ever need to ship it.

Avoid water

Your telephone can be damaged if it gets wet. Do not use the handset outdoors in the rain, or handle it with wet hands. Do not install your base unit near a sink, bathtub or shower.

Electrical storms

Electrical storms can sometimes cause power surges harmful to electronic equipment. For your own safety, use caution when using electric appliances during storms.

Cleaning your telephone

Your telephone has a durable plastic casing that should retain its luster for many years. Clean it only with a soft cloth slightly dampened with water or a mild soap. Do not use excess water or cleaning solvents of any kind.

Remember that electrical appliances can cause serious injury if used when you are wet or standing in water. If your base unit should fall into water, **DO NOT RETRIEVE IT UNTIL YOU UNPLUG THE POWER CORD AND ETHERNET CABLE FROM THE WALL.** Then pull the unit out by the unplugged cords.

Warranty Statement

What does this limited warranty cover?

- The manufacturer of this VTech product, VTech Communications, warrants to the holder of a valid proof of purchase (“Consumer” or “you”) that the product and all accessories provided by VTech in the sales package (“Product”) are free from material defects in material and workmanship, pursuant to the following terms and conditions, when installed and used normally and in accordance with operation instructions, This limited warranty extends only to the Consumer for Products purchased and used in the United States of America.

What will VTech Communications do if the Product is not free from material defects in materials and workmanship during the limited warranty period (“Materially Defective Product”)?

- During the limited warranty period, VTech’s authorized service representative will repair or replace at VTech’s option, without charge, a Materially Defective Product. If we repair this product, we may use new or refurbished replacement parts. If we choose to replace this product, we may replace it with a new or refurbished product of the same or similar design. VTech will return repaired or replacement products to you in working condition. VTech will retain defective parts, modules, or equipment. Repair or replacement of Product, at VTech’s option, is your exclusive remedy. You should expect the repair or replacement to take approximately 30 days.

How long is the limited warranty period?

- The limited warranty period for the product extends for ONE(1) YEAR from the date of purchase if we repair or replace a Materially Defective Product under the terms of this limited warranty. This limited warranty also applies to repaired or replacement Products for a period of either (a) 90 days from the date the repaired or replacement Product is shipped to you or (b) the time remaining on the original one-year warranty; whichever is longer.

What is not covered by this limited warranty?

This limited warranty does not cover

1. Product that has been subjected to misuse, accident, shipping or other physical damage, improper installation, abnormal operation or handling, negligent, inundation, fire, water or other liquid intrusion; or
2. Product that has been damaged due to repair, alteration or modification by anyone other than an authorized service representative of VTech; or
3. Product to the extent that the problem experienced is caused by signal conditions, network reliability or cable or antenna systems; or
4. Product to the extent that the problem is caused by use with non-VTech electrical accessories; or
5. Product whose warranty/quality stickers, Product serial numbers plates or elec

Warranty Statement

- tronic serial numbers have been removed, altered or rendered illegible; or
6. Product purchased, used, serviced, or shipped for repair from outside the United States, or used for commercial or institutional purposes (including but not limited to Products used for rental purposes); or
 7. Product returned without valid proof of purchase (see 2 below); or
 8. Charges for installation or set up, adjustment of customer controls, and installation or repair of systems outside the unit.

How do you get warranty service?

- To obtain warranty service in the United States of America, call 1- 800-595-9511 for instructions regarding where to return the Product. Before calling for service, please check the user's manual. A check of the Product controls and features may save you a service call.
- Except as provided by applicable law, you assume the risk of loss or damage during transit and transportation and are responsible for delivery or handling charges incurred in the transport of Product(s) to the service location. VTech will return repaired or replaced product under this limited warranty to you, transportation, delivery or handling charges prepaid. VTech assumes no risk for damage or loss of the Product in transit.
- If the Product failure is not covered by this limited warranty, or proof of purchase does not meet the terms of this limited warranty, VTech will notify you and will request that you authorize the cost of repair and return shipping costs for the repair of Products that are not covered by this limited warranty.

What must you return with the Product to get warranty service?

1. Return the entire original package and contents including the Product to the VTech service location along with a description of the malfunction or difficulty;
2. Include "valid proof of purchase" (sales receipt) identifying the Product purchased (Product model) and the date of purchase or receipt; and
3. Provide your name, complete and correct mailing address, and telephone number.

Other Limitations

- This warranty is the complete and exclusive agreement between you and VTech. It supersedes all other written or oral communications related to this Product. VTech provides no other warranties for this product. The warranty exclusively describes all of VTech's responsibilities regarding the product.

There are no other express warranties. No one is authorized to make modifications to this limited warranty and you should not rely on any such modification.

State Law Rights: This warranty gives you specific legal rights, and you may also have other rights, which vary from state to state.

Warranty Statement

Limitations: Implied warranties, including those of fitness for a particular purpose and merchantability (an unwritten warranty that the product is fit for ordinary use) are limited to one year from date of purchase. Some states do not allow limitations on how long an implied warranty lasts, so the above limitation may not apply to you.

- In **no** event shall VTech be liable for any indirect, special, incidental, consequential, or similar damages (including, but not limited to lost profits or revenue, inability to use the product, or other associated equipment, the cost of substitute equipment, and claims by third parties) resulting from the use of this product, some states do not allow the exclusion or limitation of incidental or consequential damages, so the above limitation or exclusion may not apply to you.

FCC and IC Regulations

This equipment complies with Parts 15 of the Federal Communications Commission (FCC) rules for the United States. It also complies with regulations RSS210 of Industry and Science Canada. Operation is subject to the following two conditions: (1) this device may not cause interference, and (2) this device must accept any interference, including interference that may cause undesired operation of the device.

FCC Part 15

Warning: Changes or modifications to this unit not expressly approved by the party responsible for compliance could void the user's authority to operate the equipment.

The equipment has been tested and found to comply with part 15 of the FCC rules. These limits are designed to provide reasonable protection against harmful interference in a residential installation. This equipment generates, uses and can radiate radio frequency energy and, if not installed and used in accordance with the instructions, may cause harmful interference to radio communications. However, there is no guarantee that interference will not occur in a particular installation. If this equipment does cause harmful interference to radio or television reception, which can be determined by turning the equipment off and on, the user is encouraged to try and correct the interference by one or more of the following measures:

- Reorient or relocate the receiving antenna.
- Increase the separation between the equipment and receiver.
- Connect the equipment into an outlet or on a circuit different from that to which the receiver is connected.
- Consult the dealer or an experienced radio/TV technician for help.

To ensure safety of users, the FCC has established criteria for the amount of radio frequency energy that can be safely absorbed by a user or bystander according to the intended usage of the product. This product has been tested and found to comply with the FCC criteria. The handset has such a low power that it does not require testing. It may be safely held against the ear of the user. The base unit shall be installed & used such that parts of the user's body other than the hands should be maintained at a comfortable distance of approximately 20 cm or more.

IC (Industry Canada)

This telephone is registered for use in Canada.

The term "IC:" before the radio certification number only signifies that Industry Canada technical specifications were met.

Before installing this equipment, users should ensure that it is permissible to be connected to the facilities of the local telecommunications company. The equip-

FCC and IC Regulations

ment must also be installed using an acceptable method of connection. The customer should be aware that compliance with the above conditions may not prevent degradation of services in some situations.

Repairs to certified equipment should be made by an authorized Canadian maintenance facility designated by the supplier. Any repairs or alterations made by the user to this equipment, or equipment malfunctions, may give the telecommunications company cause to request the user to disconnect the equipment.

Users should ensure for their own protection that the electrical ground connections of the power utility, telephone lines and internal metallic water pipe system, if present, are connected together. This precaution may be particularly important in rural areas.

Caution:

Users should not attempt to make such connections themselves, but should contact the appropriate electrical inspection authority, or electrician, as appropriate.

Your cordless phone is designed to operate at the maximum power allowed by the FCC and IC. This means your handset and base unit can communicate only over a certain distance - which will depend on the location of the base unit and handset, weather, and the construction and layout of your home or office.

Technical Specifications

FREQUENCY CONTROL

Crystal controlled
PLL synthesizer

TRANSMIT FREQUENCY

Base: 5725 - 5850 MHz
Handset: 2400 - 2483.5 MHz

RECEIVE FREQUENCY

Base: 2400 - 2483.5 MHz
Handset: 5725 - 5850 MHz

CHANNELS

95 Channels

NOMINAL EFFECTIVE RANGE

Maximum power allowed by FCC and IC. Actual operating range may vary according to environmental conditions at the time of use.

SIZE

Handset: 182mm x 55.3mm x 40mm
(including antenna)
Base: 169.1mm x 60.7mm x 157.2mm
Charger: 76.5mm x 79.4mm x 45.2mm

WEIGHT

Handset: 146 grams
(excluding batteries)
Base: 323 grams
Charger: 225 grams

POWER REQUIREMENTS

Handset: 3.6V 600mAh NiMH
(battery pack)
Base: 5.1V, 1.7A
Charger: 9 V @ 150mA

MEMORY

Phonebook: 50 Memory locations;
up to 32 digits for number, 16
characters for name
CID: 50 Memory locations

SPECIFICATIONS ARE TYPICAL AND MAY CHANGE WITHOUT NOTICE.

vtech VTECH TELECOMMUNICATIONS LTD.

vtech A member of THE VTECH GROUP OF COMPANIES.

Distributed in the U.S.A. by VTech Communications, Inc. Beaverton,
Oregon, 97008

Distributed in Canada by VTech Telecommunications Canada Ltd.,
Richmond, B.C. V6X 1Z9.

Copyright 2005 for VTECH TELECOMMUNICATIONS LTD.

Free Manuals Download Website

<http://myh66.com>

<http://usermanuals.us>

<http://www.somanuals.com>

<http://www.4manuals.cc>

<http://www.manual-lib.com>

<http://www.404manual.com>

<http://www.luxmanual.com>

<http://aubethermostatmanual.com>

Golf course search by state

<http://golfingnear.com>

Email search by domain

<http://emailbydomain.com>

Auto manuals search

<http://auto.somanuals.com>

TV manuals search

<http://tv.somanuals.com>