

# User Guide **v 1.6** (S/W v1.2.8, Bootrom v3.1.2)

*UIP312 CENTREX IP TELEPHONE*



---

## Revision History

Version	DATE	RESP.ENGR.	DESCRIPTION
1.5	04/01/03	T, Ryu	•Change the Incoming Call log [9.2.2]
1.6	07/22/03	T, Ryu	• No change

---

# Table of Contents

<b>1. Safety Information</b> .....	1
<b>2. Introduction</b> .....	2
<b>3. Package Contents</b> .....	3
<b>4. Phone Description</b> .....	4
<b>5. How the Keys Work</b> .....	5
<b>6. Quick Installation</b> .....	7
6.1 Installing the Phone .....	7
6.2 How to Use the Headset and Headset Adapter .....	8
6.3 Placement of the Phone .....	9
6.4 Using Power Over LAN .....	9
<b>7. How to Use the Multi-Line Features</b> .....	10
7.1 Description .....	10
7.2 Idle State .....	10
7.3 Making a Call .....	11
7.4 Receiving a Call .....	12
7.5 Disconnecting a call .....	15
<b>8. Phone Operation</b> .....	17
8.1 How to Use the Handset and Speakerphone .....	17
8.2 Adjusting the Handset and Speakerphone Volume .....	17
8.3 Adjusting the Ringer Volume .....	17
8.4 Muting a Call .....	19
8.5 Redialing the Last Number .....	19
8.6 Holding a Call .....	19
8.7 Caller ID .....	20
8.8 Call Information .....	20
8.9 Headset Audio Path .....	21
8.10 Inputting Characters (Dial Pad) .....	22
<b>9. Using the MENU Options</b> .....	24
9.1 Menu Structure .....	24
9.2 Call History .....	25
9.2.1 Outgoing Calls .....	26
9.2.2 Incoming Calls .....	27
9.3 Speed Dial .....	28
9.3.1 How to Set Up Your Speed Dial .....	29
9.3.2 How to Use Speed Dial .....	31

9.4	Phone Setting .....	33
9.4.1	VMS Number .....	33
9.4.2	Ring Type .....	35
9.4.3	Display Name .....	36
9.4.4	Phone Function .....	37
9.4.4.1	Do Not Disturb .....	38
9.4.4.2	Disable Redial .....	38
9.5	System .....	39
9.5.1	New Password .....	39
9.5.2	Change Password .....	41
9.5.3	Clear Password .....	42
9.5.4	Time .....	43
9.5.4.1	AUTO Mode .....	43
9.5.4.2	MANUAL Mode .....	46
9.5.5	Country & SP .....	47
9.5.6	Reboot .....	48
9.6	Information .....	49
9.6.1	Version .....	49
9.6.2	Network .....	50
9.6.3	IP Phone .....	51
<b>10.</b>	<b>Using the SETUP menus</b>	
10.1	Address Setting .....	53
10.1.1	GK Address .....	53
10.1.2	ALIAS Number .....	55
10.1.3	H235 Password .....	57
10.2	Voice .....	58
10.2.1	Select Codec .....	58
10.2.2	Jitter Buffer .....	59
10.3	Priority .....	61
10.3.1	Signal DiffServ .....	61
10.3.2	Voice DiffServ .....	62
<b>11.</b>	<b>Display Information</b> .....	<b>63</b>
<b>12.</b>	<b>Troubleshooting Guide</b> .....	<b>64</b>
<b>13.</b>	<b>Frequently Asked Questions</b> .....	<b>65</b>
<b>14.</b>	<b>FCC Statement</b> .....	<b>66</b>
<b>15.</b>	<b>Glossary</b> .....	<b>67</b>

---

# 1. Safety Information

Utmost care and attention has been devoted to quality standards in the manufacture of your new Phone. Safety is a major factor in the design of every set. But, safety is your responsibility too.

To avoid injury and damage to the phone, please follow these important safety instructions when installing, using your phone.

1. To reduce the risk of an electrical shock, do not disassemble this phone. There are no user serviceable parts. Opening or removing covers may expose you to hazardous voltages. Incorrect reassembly can cause an electrical shock.
2. Never push objects of any kind into this phone's housing slots since such objects may touch hazardous voltage points or short out parts that could result in a risk of an electrical shock.
3. Only use Unshielded Twisted Pair (UTP) Category 5 Ethernet cable to connect to this phone's RJ-45 ports (Uplink and Downlink).
4. Always use this phone with the required power source. The proper power source required for this phone is written on the power adaptor you received with this phone. If you are unsure of the type of power supplied to your premises, consult your local power company before installing this phone. Use only the adaptor provided.  
(Output: DC 18V/ 600mA, (-)---(o---(+))
5. Do not connect or disconnect cables during an electrical storm.
6. Do not connect this phone directly to a standard telephone line. Although the RJ11 connector for a traditional telephone fits into the RJ-45 ports of this phone, the electrical interfaces are not compatible and the phone will not work.
7. Do not connect to headset connector any unfloating device, such as PC or amplifier, which may result ground loop. Use non-amplifier headset only.
8. Disconnect the power to this phone and have it checked by a qualified service personnel if any of the following occurs:
  - the power supply cord or plug is damaged or frayed
  - the phone was exposed to water or had liquid spilled on it
  - the phone has been dropped or the cabinet has been damage
  - after following the User Guide, the phone does not operate properly

---

## 2. Introduction

This Phone is an advanced phone that allows users to achieve perfect voice communication over the IP network without using a personal computer. Not only does the Phone support all the conveniences and functions of a digital key system phone, it also perfectly integrates all the merits and features of analog and IP phones over the data communication system. As voice signals are automatically compressed using audio CODECs, they can be transmitted over a low bandwidth without interference from other data signals. Furthermore, to provide consistent superior voice quality over varying and congested IP network conditions, the Phone is equipped with advanced Quality of Service (QoS) technologies such as CODEC negotiation, enhanced jittering technology, lost packet reconstruction, echo cancellation, and packet delay recovery.

**For Technical Support please call 1-800-648-4921.**

### About This Guide

User's Guide version 1.6 is applicable to software release 1.2.8, which consists of Bootrom version 3.1.2 and application version 1.2.8. If a Bootrom version other than version 3.1.2 is used with application version 1.2.8, the phone may not operate properly in some cases.

---

### 3. Package Contents

The following items are included in your Phone package.

- One phone body
- One Handset Cord
- One DC 18V 600mA Adapter
- One User Guide
- One UTP Cable (2m)
- One Headset Adapter
- One Foot Stand



Phone Body

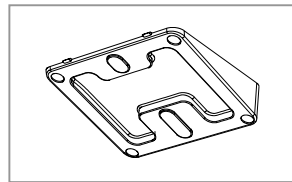

Foot Stand

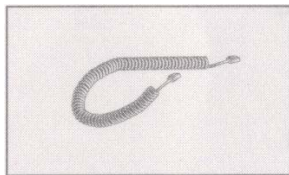

Handset Cord

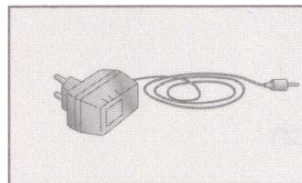

Power Adaptor

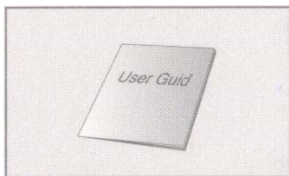

User Guide

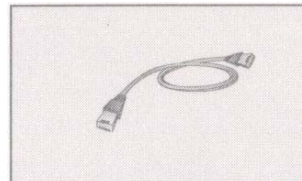

UTP Cable

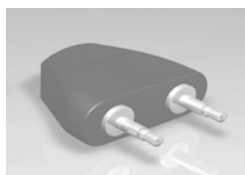

Headset Adapter

## 4. Phone Description

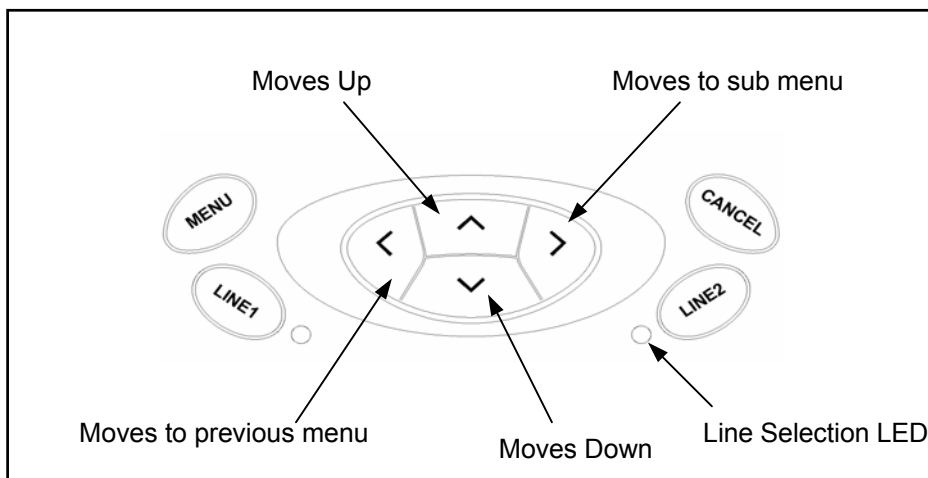
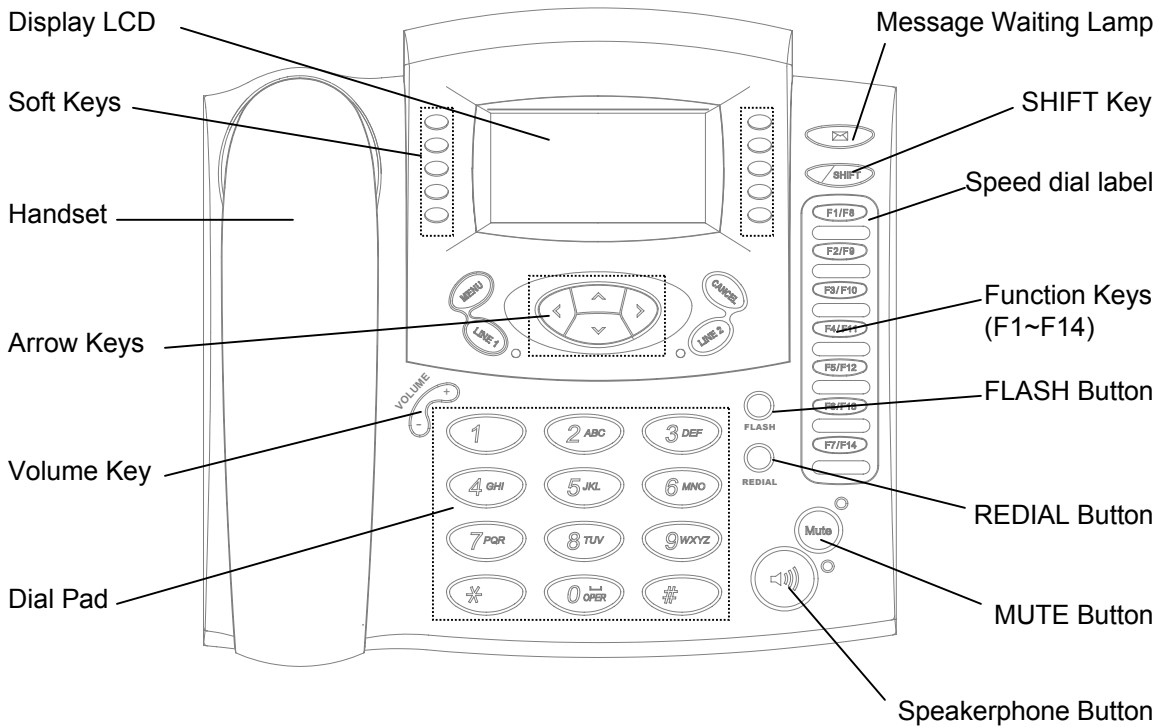



---

## 5. How the Keys Work

<b>MENU</b>	Pressing the MENU key display this phone's <b>MENU</b> items, such as Call History, Speed Dial, Phone Setting, System, Information, Setup and Exit.
<b>CANCEL</b>	Pressing the CANCEL key allows an item selected from the MENU screen to be exited or canceled
<b>LINE1</b>	Selects Line 1
<b>LINE2</b>	Selects Line 2
<b>&lt; &gt;</b> <b>( LEFT, RIGHT )</b>	<p>The LEFT and RIGHT arrow keys have multiple functions.</p> <ol style="list-style-type: none"><li>1. Menu browsing<ol style="list-style-type: none"><li>1) Pressing the LEFT arrow key changes the display to the previous screen.</li><li>2) Pressing the RIGHT arrow key changes the display to the next screen for the item you selected.</li></ol></li><li>2. Editing<ol style="list-style-type: none"><li>1) Pressing the LEFT arrow key deletes your last input.</li><li>2) Pressing the RIGHT arrow key moves the cursor to the right. In menu items such as in Speed dial Name that allow space input, the RIGHT arrow key is also used as a way to input a space along with the DTMF "0" button.</li></ol></li></ol>
<b>^ v</b> <b>( UP , DOWN )</b>	<p>The UP and DOWN arrow keys have multiple functions.</p> <ol style="list-style-type: none"><li>1. Menu browsing Pressing the UP or DOWN arrow keys allows you to scroll up or down the MENU or SETUP screen.</li><li>2. Editing Pressing the UP arrow key is equivalent to pressing the RIGHT arrow key while pressing the DOWN arrow key is the same as pressing the LEFT arrow key.</li></ol>
<b>SOFT KEYS</b>	<p>(Buttons on both sides of LCD screen) The soft keys have multiple functions. When the phone displays <b>MENU</b> screen, pressing the soft key aligned with an item will display the submenu for that item. The bottom right key is also used as the enter key in the menus where the user can enter provisioning values.</p>

---

## VOLUME

The VOLUME Keys have multiple functions.

1. Pressing the VOLUME key allows you to control the handset, speakerphone, and ringer volume. Volume levels are as follows:

Handset: 0 to 6 / Ringer: 0 to 6 / Speakerphone: 0 to 6 / Headset 0 to 6

2. While editing such menu items as Speed dial Name that allow both upper case and lower case letters, pressing the VOLUME UP key capitalize the current letter.

Pressing the key again changes the letter back to its lower case.

## FLASH

Pressing the FLASH button allows you to place the current caller on **hold** and make another call to complete a **three way call**. The hook switch does not serve as FLASH

## REDIAL

Pressing the REDIAL button instructs the phone to automatically dial the most recently dialed number.

## MUTE

Pressing the MUTE button prevents the party you are speaking to from hearing what you say

## SPEAKERPHONE

Pressing the Speakerphone button allows you to make a call without using the phone's handset.

## MESSAGE WAITING LAMP

When the Message Waiting Lamp is blinking, the phone is indicating that you have a message.

**Note:** This lamp functions as a button as well. Throughout this document, "the Lamp", "the Message Waiting Lamp", "the Message Lamp", "the Voice Message Lamp", "VMWI Lamp", and "the VMS button", all these terms are interchangeably used for this button/lamp.

## SHIFT

Pressing the SHIFT key allows you to access Function keys F8~F14.

## FUNCTION KEYS

After entering names and numbers in Speed Dial, you can use the Function keys as Speed Dial keys.

## DTMF KEYS (DIAL Pad)

Used in dialing as well as when entering alphanumeric characters in menus for names and numbers such as Speed dial menu.

## 6. Quick Installation

### WARNING

- The minimum requirements for using UIP312 are network configuration such as DHCP, IP Address, Net Mask, Gateway, DNS, etc., and GK address and alias configuration.
- If above requirements are not satisfied, consult your network administrator.

### 6.1 Installing the Phone

- Unpack all the contents you received with your Phone.
- Connect your activated Local Area Network (LAN) cable to the **UPLINK** port on the back of the Phone as shown in **Figure 1**
- Connect the power adapter to an AC outlet and connect the jack to the **DC-IN-18V** on the back of the Phone (See Note).
- If you use this phone with a PC, connect one end of the UTP cable (2m) to the **Downlink** port and the other end to your PC's LAN card. (The Phone has an internal SWITCH HUB in itself.)

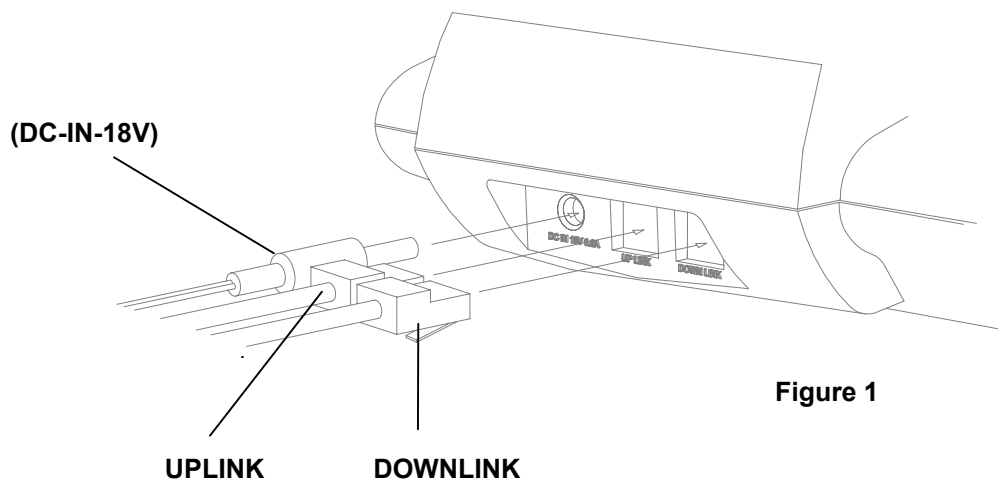

Figure 1

**Note:** Use only the power adapter provided by manufacturer. Some adapters provide too much voltage and can damage the phone. If the adapter does not provide enough power, the phone will not operate.

---

## 6.2 How to Use the Headset and Headset Adapter

- Insert the Headset Adapter into the **SPK** and **MIC** holes on the left side of the phone
- Insert the RJ-11(4-Pin) headset jack from headset into the Headset Adapter.

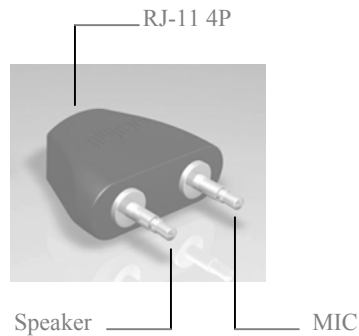

**Note:** You can use any standard headset since UIP312's headset pin map conforms to the standard.

When using RJ-11 Adapter, use a headset with the pin map following the order [MIC+, Speaker, Speaker, MIC-].

For maximum voice quality when using the headset, the following headsets are recommended.

-----  
**Plantronics TriStar H81, GN Netcom Headset**  
-----

### 6.3 Placement of the Phone

- The phone includes a footstand. When using the phone on a desk, the footstand can be used to provide optimum view of the display, as shown in **Figure 2**.
- Alternatively, you can mount the phone on the wall using the footstand as a mounting bracket as shown in **Figure 3**. In this position, the small tab that is located at the base of ear-piece rest must be removed, rotated 180 degrees, and reinserted. The tab as shown in **Figure 4** will keep the handset from falling from the phone when the phone is vertically placed.

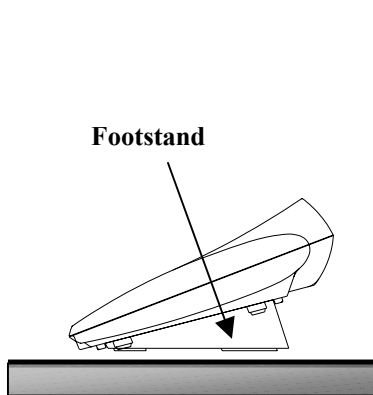

Figure 2

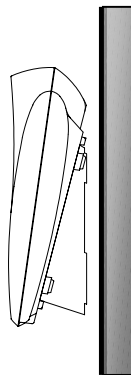

Figure 3

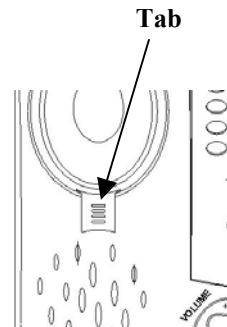

Figure 4

### 6.4 Using Power over LAN (POL)

- You may use Power Over LAN feature with a power adapter at the same time.
  1. If you plug in the adapter first to the phone, and then plug in the POL capable UTP-cable, the phone will continue to receive power from the adapter. At this point, if you disconnect the adapter from the phone, the phone will reboot, go through the POL startup procedure and start to use the POL as its power source.
  2. If you plug in the POL capable UTP-cable first to the phone, and then plug in the adapter, the phone will continue to receive power from the POL cable. At this point, if somehow the POL stops supplying power to the phone, for instance, when the user disconnects the LAN cable, the power source of the phone will switch over to the adapter in a seamless manner without rebooting.

**Note: UIP312 supports the POL service in the uplink ethernet port only, and does not support the POL service in the downlink ethernet port.**

---

## 7. How to Use the Multi-Line Features

### 7.1 Description

The UIP312 is a Multi-Line phone with two distinct numbers for making and receiving calls.

**Note: 1. In order to utilize Multi-Line feature of UIP312, both LINE 1 alias and LINE 2 alias must be registered.**

**2. A call attempt on a line that is not registered will not do anything but make the phone beep.**

### 7.2 IDLE State

In the Idle state the UIP312 will display

- 1) The time and date
- 2) The Network state ( 📶 , 🌧 )
- 3) The Registration state
- 4) The DND state ( 😊 )
- 5) The Missed Call state ( if any )



#### 7.2.1 Network state icon

If you see 🌧 icon on the screen, either UIP312's network configuration is incorrect or there is a problem in the network itself. If the problem persists, check the network cable and network configuration such as Default Gateway. Consult with your network administrator.

#### 7.2.2 Registration state

When UIP312 is registered to the Gatekeeper, you will see the phone's alias(phone number) on top of the LCD screen. If you see "Not registered" instead, check the Gatekeeper, alias, and H235Password settings. Contact your administrator for more info.

### 7.2.3 DND state

If **Do Not Disturb** function is enabled in “Do Not Disturb” submenu under Phone Function, you will see ☹️ icon and you won't hear the phone ring, and only the Lamp will be lighted for incoming calls.

### 7.2.4 Missed Call state

You will see 📧 icon when there is an unanswered incoming call.  
n of “[n]” represents number of unanswered calls.  
You can also search the call history for missed calls.  
MENU → Call History → Incoming Calls



## 7.3 Making a call

### 7.3.1 Using the handset or the speakerphone key while UIP312 is idle

- 1) If both LINE1 and LINE2 are already registered, picking up the handset or pressing the speakerphone button will let you make a call on LINE1.
- 2) If only one line between LINE1 and LINE2 is registered, picking up the handset or pressing the speakerphone button will let you make a call on the line that is registered.

### 7.2.2 Using LINE1 or LINE2 key

- Before picking up the handset, you can select either LINE 1 or LINE 2 by pressing the line selection keys.
- After selecting the desired line, you can pick up the handset and dial using either the Dial Pad or the Speed Dial Function keys.
  
- To make a second call, select the idle line by pressing the line selection keys.
- The original call will automatically be put on hold when the second line is selected.
- The phone will indicate which line is active by lighting the LED of the active line.

### [ Off hook state ]

You will see the screen to the right when the phone goes off hook by either picking up the handset or pressing the speakerphone button. You will hear dial tone. If you hear no dial tone or see no “== TALKING ==” message, there is a problem with the phone.



### [ Dialing state ]

Once you saw “== TALKING ==” message, you can start dialing. The screen shot to the right is when you dialed “4800000”. You should be hearing ring back tone shortly after.



## 7.3 Receiving a call

### 7.3.1 When there is one incoming call

- When the telephone receives a call, you will hear the phone ring and see the Caller ID displayed on the screen as well as the icon  on the upper left corner of the screen.
- The phone will indicate which line is receiving the call by lighting the LED of the active line.
- If you choose to answer, pick up the handset. Or press the speakerphone button.

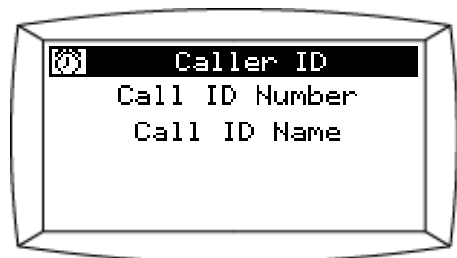



---

### 7.3.2 When there are two incoming calls at the same time

- This telephone can receive multiple calls.
- You will see the Caller IDs for both LINE1 and LINE2 on the screen.
  - 1) If you pick up the handset or press the speakerphone button, whichever call that came in first will be answered.
  - 2) If you press LINE 1 button or LINE 2 button, the call on the corresponding line will be answered regardless of the order of arrival.

When there are incoming calls on both lines at the same time, the Caller ID info on LINE1 is always displayed on top and that on LINE2 at the bottom.

[1] and [2] refers to LINE1 and LINE2 respectively.

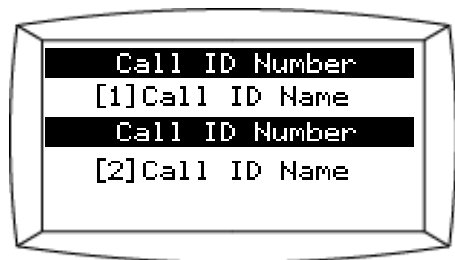

### 7.3.3 When there is an incoming call while you are talking on the other line

- When the phone receives a call while you are receiving or making another call, this phone will display Caller ID, flash the Message Waiting Lamp, and ring.
- If you choose to answer the second call, select the appropriate line to answer the call.
- The original call will automatically be put on hold. ( Note that the person on the other end of the line placed on hold will hear no sound at all. )
- To return to your original call, select the original call's line number.

### 7.3.4 Waiting Call

- You can receive a call while you are talking on the same line. This feature is called "Waiting Call".
- It works the same way as when you receive a call under normal circumstance like Caller ID display except the fact that the phone only beeps once instead of ringing.
- If you want to answer this waiting call, press the **FLASH** button.
- If you want to go back to the original call, press the **FLASH** button again.
- **The FLASH button let you switch between the two calls.**

---

### **TIP : Waiting Call**

This is an example of Waiting Call.

Let's say there are Phone A, B, and C.

Step 1. Phone B makes a call to Phone A. The connection is established between the two.

Step 2. Phone C makes a call to Phone A. You will see the Caller ID info of Phone C on the Phone A's screen.

Step 3. Phone A's user press the FLASH button, and now talk to Phone C. At this point, Phone B is put on hold and Phone B's user will be hearing some music.

Step 4. Phone A's user press the FLASH button. At this point, Phone C is placed on hold and its user will hear music. Phone A is now talking to Phone B.

Step 5. Phone A's user press the FLASH button again. Phone B is placed on hold. Phone A and Phone C are now talking to each other.

Step 6. Phone A disconnects the call with Phone C. At this point, Phone B's user will no longer hear the music, and instead, will hear ring back tone.

Step 7. Shortly after, Phone A rings. At this point, Phone A might not display the Caller ID info. If no Caller ID info is displayed, it won't be saved in Call history either. Phone A's user may pick up the phone before ringing in this case.

Step 8. Phone A's user pick up the phone and is able to resume talking to Phone B.

If this Waiting Call feature is not working, contact your administrator.

---

## 7.4 Disconnecting a call

**NOTE : You cannot disconnect existing calls by pressing the LINE1 or LINE2 key**

- Unlike the speakerphone button, LINE1 key and LINE2 key are only used for off hook or switching lines.

### 7.4.1 Disconnecting when a single line is in use:

- If you wish to disconnect a call simply hang up the handset.
- If you are using the speakerphone, simply press the speakerphone button.

**Note: While you are talking through the speakerphone with the handset off the hook, pressing the speakerphone button will let you switch to the handset.**

### 7.4.2 Disconnecting when a Multiple lines are in use:

Depending on the situation, there are different ways to disconnect a call when multiple lines are in use.

#### 1) Disconnecting a call using the handset:

- If you are on Line 1 and you receive a call on Line 2, answer Line 2 by switching lines. Line 1 will automatically be placed on hold.
- If you wish to disconnect Line 2, either press the hook switch or return the handset to the handset cradle. If you disconnect Line 2 by pressing the hook switch, you will automatically be reconnected to Line 1.
- If you disconnected Line 2 by returning the handset to the handset cradle, you will be reconnected to Line 1 when you pick up the handset. Should you forget to pick up the handset, this phone will remind you that Line 1 is on hold.
- If after answering Line 2, Line 2 disconnects the call before you do, disconnect Line 2 by using the handset or hook switch. If you do not disconnect Line 2 before reconnecting to Line 1, the phone will automatically disconnect Line 2 after several seconds.  
( **Note:** If you choose to have all lines available immediately, disconnect Line 2 using the handset or hook switch before reconnecting to Line 1.)
- If, when you are on Line 1, Line 2 is on hold and you wish to disconnect Line 2, switch to Line 2. Doing so will activate Line 2 and place Line 1 on hold automatically. To disconnect Line 2, either press the hook switch or return the handset to the cradle. If you disconnect Line 2 by pressing the hook switch, you will automatically be reconnected to Line 1. If you disconnect Line 2 by placing the handset in the cradle, you will be reconnected to Line 1 when you pick up the handset. Should you forget to pickup the handset, the phone will remind you that a call is on hold.

---

## 2) Disconnecting a call using the speakerphone button:

- If you are on the speakerphone on Line 1 and you receive a call on Line 2, answer Line 2 by switching lines as described above. To disconnect Line 2, push the speakerphone button. Doing so will automatically disconnect Line 2. To reconnect to Line 1, push the speakerphone button again or pick up the handset.

### **TIP : Reminder Ring**

- Let's say that LINE 1 and LINE 2 are both in use.
- LINE 1 is on hold and LINE 2 is the active line. The handset is being used.
- At this point, the user disconnects the LINE 2 call by hanging up. LINE 1 is still on hold and LINE1 LED keeps blinking.
- If the user doesn't pick up the handset, press the speakerphone button or press the LINE 1 button within 6 seconds, in order to remind the user of the existing call on LINE 1, UIP312 starts ringing and flashing the Message Lamp as if there is an incoming call. This is called "Reminder Ring".

(And just for your own reference, the 6 seconds of delay is derived from the interval between each ring of the regular incoming calls.)

## 8. Phone Operation

### 8.1 How to Use the Handset and Speakerphone.

- To place and answer calls on this phone using the handset, simply lift the handset.
- To place and answer calls using the speakerphone, simply press the Speakerphone button.
- To switch from the handset to the speakerphone, press the Speakerphone button and hang up the handset. To switch from the speakerphone to the handset, simply lift the handset.
- To place or answer another call when using one of two lines, simply press the line key to select the other line. The original call will automatically be put on hold.

### 8.2 Adjusting the Handset and Speakerphone Volume

- To increase or decrease the volume of your handset and speakerphone, first lift the handset or press the Speakerphone button and press the up(+) or down(-) VOLUME key to the desired level.
- The range of the handset volume is from 0 to 6. The range of the speakerphone volume is from 0 to 6.
- The VOLUME setting is saved for all future calls until you readjust the volume.

**Note: The default Volume is set to 3 and the operational quality of UIP312 is optimal at this default Volume.**

#### VOLUME

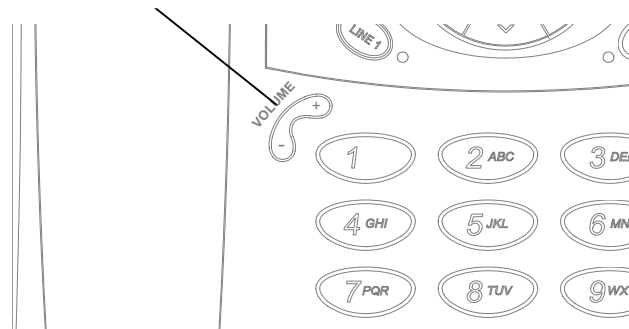

### 8.3 Adjusting the Ringer Volume

- To increase or decrease the phone's ringer volume, press the up (+) or down (-) VOLUME key with the handset in the cradle while the telephone is idle.
- The range of the ringer volume is from 0 to 6.

**Note: The volume settings will be maintained even after the IP phone's power is reset.**

---

### Handset Volume control

Press the Volume UP/DOWN keys while using the handset.



### Speakerphone Volume control

Press the Volume UP/DOWN keys while using the speakerphone.



### Headset Volume control

Press the Volume UP/DOWN keys while using the headset.



### Ringer Volume control

Press the Volume UP/DOWN keys while the phone is idle.

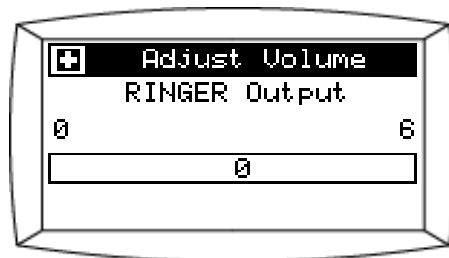

---

## 8.4 Muting a call

- During a call, you can mute the handset, headset or speakerphone by pressing the MUTE button to prevent another party from hearing what you or someone else in the room is saying (The MUTE LED will light up indicating the mute function is enabled. )
- To disable the mute function, press the MUTE button again.

**Note: (When using Multi-line service) Pressing the MUTE button will mute Lines 1 and 2 when both are active.**

## 8.5 Redialing the last number dialed

- To redial the most recently dialed number, lift the handset and press the Redial button.
- For use with the speakerphone, just press the REDIAL button.

**Note: (When using Multi-line service) The Redial button will redial the most recently dialed number regardless of whether it was dialed on Line 1 or Line 2.**

## 8.6 Holding a call

There are two ways to place the current line on hold in the multi-line phone. Let's say both LINE1 and LINE2 are registered and you were talking on LINE1.

### 1) Using the FLASH button

If you press the FLASH button while you are talking, LINE 1 is placed on hold. The person on the other end of the line will hear the hold melody and you will hear dial tone indicating it is ready to make a new call.

**Note: If you hear no dial tone after the line was placed on hold by pressing the FLASH button, please consult with your network administrator.**

### 2) Using LINE1 and LINE2 buttons

If you press LINE 2 button while you were talking on LINE 1, LINE 1 will be placed on hold and the person on the other end of the line will hear no sound at all.

---

## 8.7 Caller ID

- Caller ID service can be used with the Phone.
- Caller ID allows you to see information about the caller before you answer the phone.
- Caller ID will provide you with a caller's information even if you are already on another call.
  
- In some special circumstances, the Caller ID will display "**Private**", "**Out of Area**", or **no information** at all instead of the caller's number. For more information consult with your administrator.

**Note: The Phone provides Caller ID as default. If Caller ID does not work, contact your administrator.**

## 8.8 Call information

If you want to see the dialing info of a call you made or the Caller ID info of a received call while you are talking on a line, press the CANCEL button.

For instance, you made a call to "4800000" and are talking on LINE1 and you are having an incoming call with the Caller ID of "John" and its number "4800001". Then if you pressed the CANCEL button, you will see a display like below.

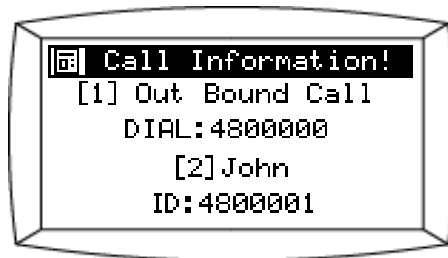

**Note: Pressing the CANCEL button while the phone is idle has no function.**



---

## 8.9 Headset audio path

- In order to use a headset, you have to plug the headset adapter in to the side of the phone.

**Note:** When using 3.5mm Jack, the headset is detected only when both Speaker and MIC are plugged in, otherwise it won't work.



**Input Headset Adapter**  
**Left : MIC**  
**Right : Speaker**

### 1. When receiving a call while the headset is connected

When receiving a call while the headset is connected to the phone, pressing the Speaker Phone button will let you talk and hear through the headset, and picking up the handset will let you talk and hear through the handset.

### 2. While you were using the handset

If you plug the headset in while you were using the handset, you will speak and hear through the headset. At this point, if the headset adapter is plugged back out, you will be able to talk and hear through the handset again.

### 3. While you were using the speaker phone

If you plug the headset in while you were using the speaker phone, you will speak and hear through the headset. If the headset is plugged back out, you will be able to talk and hear through the speaker phone again.

**TIP:** Using any headset that is not recommended by Uniden might possibly cause the other person on the line sounds relatively louder or quieter. If this happens you will have to adjust the volume using the Volume key as well as the person on the other end of the line.

## 8.10 Inputting Characters ( Dial Pad )

### 8.10.1 Alphanumeric Characters

Some menu items such as “Speed Dial Name” require you to enter characters. Each DTMF key in the dial pad is assigned an integer 0~9, \*, or #, either only or as well as 3 or 4 alphabet letters and some symbols. Once a DTMF key has been pressed, pressing it again while the rectangular cursor keeps blinking will change the current input to the next letter assigned for that specific key. See the table below for the DTMF key assignment. Note that after the rectangular cursor blinks couple of times, it will change into a vertical bar cursor. Alphabet letters are lowercase by default. To change the current letter to uppercase, press the Volume UP(+) key. Also you can press the LEFT or DOWN arrow Navigation key to delete the current character.

Let’s try entering “Uip 312”.

		Dial Pad											
		1	2	3	4	5	6	7	8	9	0	*	#
F O N T	1	1	A	D	G	J	M	P	T	W	0	/	:
	2		B	E	H	K	N	Q	U	X	SPACE		
	3		C	F	I	L	O	R	V	Y			
	4		2	3	4	5	6	S	8	Z			
	5							7		9			

Step 1. For “U” : 88 + Volume Up

Step 2. For “i” : 444

Step 3. For “p” : 77

Step 4. For “SPACE” : 00

Step 5. For “3” : 3333

Step 6. For “1” : 1111

Step 7. For “2” : 2222

**Note:** The character assignment for the DTMF “ \* “ key and DTMF “ # “ key many vary depending on the menu items.

### H235Password

H235 Password allows special symbols as well as alphabet letters and numbers. The DTMF 0 key is assigned a set of the special symbols below.

0 !\"#\$%&'()+,-./: @;<=>?\\[]^\_`{|}~

### 8.10.2 Numbers Only

Some menu items require you to input numbers only. In such menu items, you can use the DTMF keys in the dial pad to input numbers in the same way described in the previous section. Only exception is that each DTMF key is assigned an integer number 0~9, \*, or # only, and no additional characters like alphabet letters.

Also press the REDIAL button for a Pause input, and the FLASH button for a Flash input.

Let's try entering "4466P!000#".

		Dial Pad											
		1	2	3	4	5	6	7	8	9	0	*	#
FONT	1	1	2	3	4	5	6	7	8	9	0	*	#

Step 1. For "4" : 4

Step 2. For "4" : 4

Step 3. For "6" : 6

Step 4. For "6" : 6

Step 5. For "P" : REDIAL (**Press the REDIAL button for a Pause input** )

Step 6. For "!" : FLASH (**Press the FLASH button for a Flash input** )

Step 7. For "0" : 0

Step 8. For "0" : 0

Step 9. For "0" : 0

Step 10. For "#" : #

**Note: 1. The character assignment for the DTMF \* key and DTMF # key may vary depending on the menu items. When entering IP address for GateKeeper, the DTMF " \* " key is used for ".", and the DTMF " # " key is not assigned any character at all.**

**2. A pause input is displayed as " P " while a flash input is displayed as " ! " on the screen.**

## 9. Using the MENU Options

### 9.1 Menu Structure

Menu structure for each of the menus that can be selected from the idle menu.

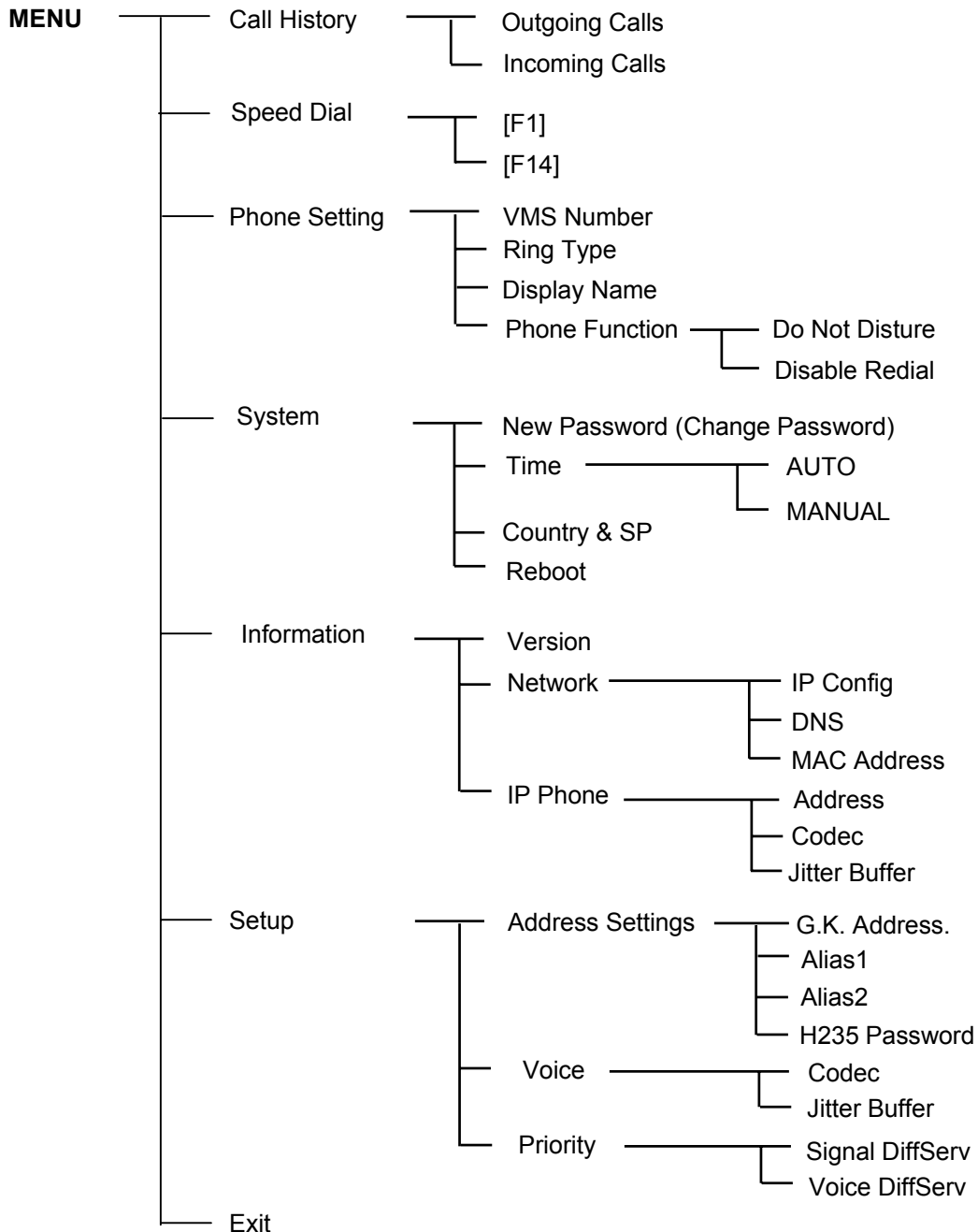

---

## 9.2 Call History

UIP312 keeps a history of the calls you have made and you have received. It let you find a specific call information and redial that number as well.

It stores up to 16 most recently dialed calls information and 16 most recently received calls information.

Call History consists of Outgoing Calls and Incoming Calls, and you can find this at MENU → Call History

### How to go to Call history Menu

1. Press the **MENU** button.
2. In the MENU screen, select **Call History**.  
Call History is user password protected



3. There are two items in the Call History menu.

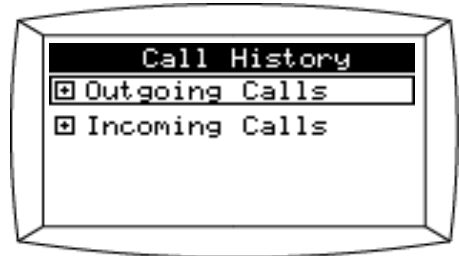

"**No Record**" is displayed when there is no call information to show.

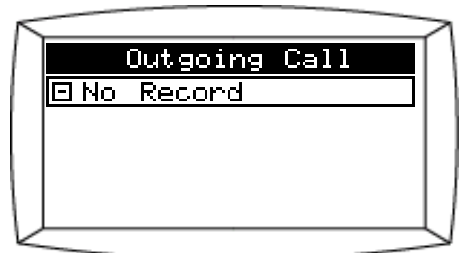

## 9.2.1 Outgoing Calls

Outgoing Calls stores up to 16 most recently dialed calls information and let you make a redial and delete a desired call information.

Press the **MENU** button.

1. In the MENU screen, select **Call History**.



2. There are two items in the Call History menu. Select **Outgoing Calls**

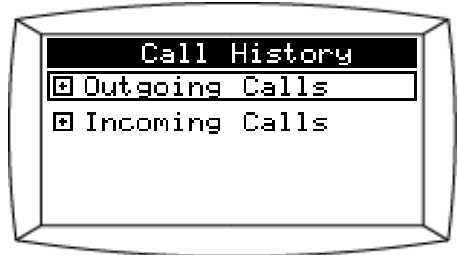

3. to see a history of the calls you have made.

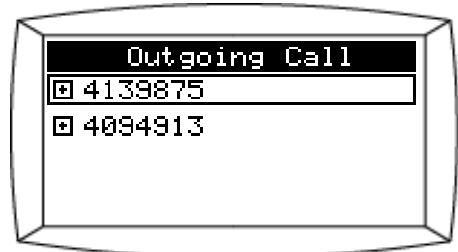

4. On the Outgoing Calls screen, select one of the following:

- **REDIAL:** to make a Redial
- **DELETE:** Call information Delete
- **JAN 01 AM 1:01:** Time info of the originated call



**Note on Menu Selection:** After selecting a target menu or option on the LCD, please press the right arrow key to access the submenu. This rule applies throughout this manual.

## 9.2.2 Incoming Calls

Incoming Calls stores up to 16 most recently received calls information.  
Incoming Calls are classified either as “**Received Call**” and “**Missed Call**”.

**Note:** Calls come in with **no Caller ID** information are not stored.

Press the **MENU** button.

1. In the MENU screen, select **Call History**.



2. Select **Incoming Calls** to see a history of the calls you have received.

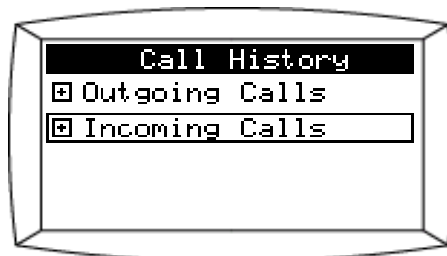

3. **Incoming Calls** does not display calls you missed while on another call.

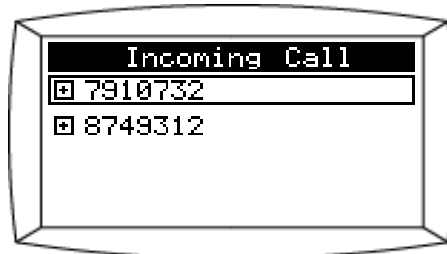

4. On the Incoming Calls screen, select one of the following:

- **DELETE:** Call information Delete
- **7910732:** Call ID Number Information
- **JAN 01 AM 1:01:** Time info of the Incoming call
- **Missed Call:** Status of the call  
Call unanswered : “ **Missed Call** “  
Call answered : “ **Received Call** “

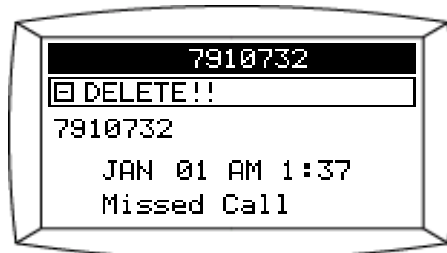

---

### 9.3 Speed Dial ( One Touch Dialing )

UIP312 provides Speed dial feature which enables you to store frequently dialed numbers and conveniently make the call with a single key press.

You can save up to 14 different phone numbers and assign a name to each of them.

#### **TIP : Smart way to use Speed dial**

In some occasions like when you use ARS machine, you have to enter additional numbers like password after some automated voice instruction. This is when you need the PAUSE feature.

In Speed dial, you can enter a desired phone number followed by appropriate number of PAUSEs followed by whatever the number you need to enter in addition.

#### **TIP : Example**

Let's say you want to use an automated telephone banking service to check you balance. You normally would have to go through the following steps.

Step 1. Dial the ARS machine's number "480111".

Step 2. You will hear automated voice instruction.

Step 3. Enter your bank account number "1-123-1234" as instructed.

Step 4. Enter your password followed by #, "0000#" as instructed.

If you use the Speed dial feature you can do all the steps above with just one touch.

Program the Speed dial [F1] key as follows.

[F1]Name : AAA Bank ( Name is not mandatory. )

[F1]Number : 4801111PPPPP11231234PPPP0000#

**Each PAUSE is equivalent to 1 second of time delay.**

**You have to decide how many PAUSEs you need to enter for duration of each voice instruction.**



### 9.3.1 How to Set Up Your Speed Dial

1. This phone allows you to customize 14 Speed Dial keys. None of the Speed Dial Keys are assigned to a specific line so that you may use the Speed Dial keys with either line.

To set up your Speed Dial keys, go to the MENU Screen, select **Speed Dial**.

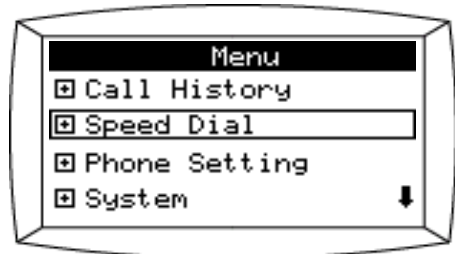

2. To program the F1key, select **[F1]No Data**.

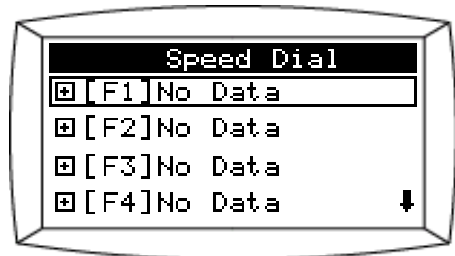

3. Select the name field and press the right arrow key.

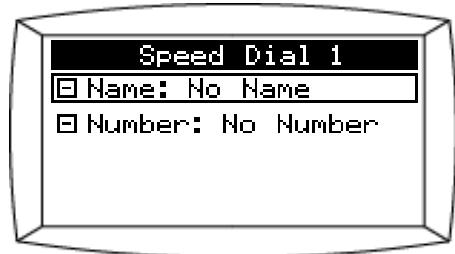

4. Input a name using the dial pad.  
Up to **18 Alphanumeric characters** can be entered in the name field.

( See 8.10 Inputting Characters )

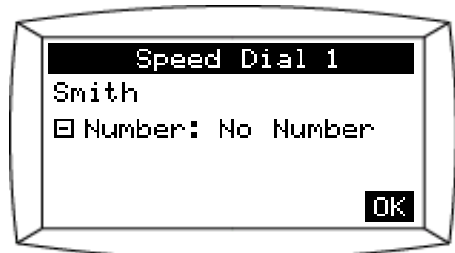

**Note: 1.** To make an upper case letter, press the + side of the Volume key after entering a lower case letter. For a space, press "0" two times. For ":", press #. For "/", press \*.

**2.** You can press the RIGHT array key or the UP arrow key for a space as well.

5. Select the number field and press the right arrow key. Then input the phone number that corresponds with the previously entered name and press **OK**. Up to **40 digits** can be entered in the number field. A pause may also be entered for convenience with automated answering systems.



( See 8.10 Inputting Characters )

5. Up to 32 digits of the phone number are visible in the read-only Speed Dial window that is shown on the right.



**Note:** 1. To enter a flash, press the FLASH button. To enter a pause, press the REDIAL button. Each time you press Redial a one-second pause will be programmed.

2. " ! " and " P " on the screen stand for a flash and a pause respectively

3. It is recommended you enter "PAUSE" following "!" input, when you want to enter "!".

**TIP:** The warning message "Read only" indicates that you cannot modify the Speed dial name and number.

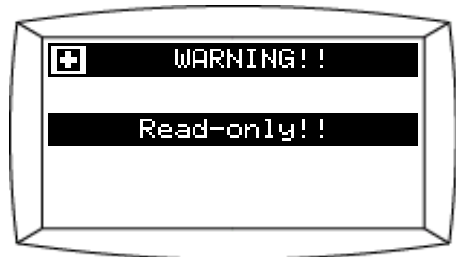

## 9.3.2 How to Use Speed Dial

### 1. Dialing & Modifying (Using MENU)

Press the **MENU** button.

1. On the MENU screen, select **Speed Dial**.



2. On the Speed Dial screen, select the number that you want to call.

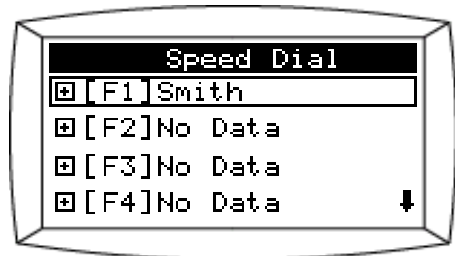

3. On the Speed Dial 1 screen, select one of the following:

- **Dialing:** to make a call
- **Name:** to change the name
- **Number:** to change the number

For the number field, up to 32 digits can be displayed in this screen.



**Note: (When using Multi-line service) The Speed Dial button shares both Lines 1 and 2, and will use whichever line you choose or that is available.**

## 2. Dialing (Using Function key)

Including the **SHIFT** key, there are 8 Function keys.

To access Function keys F1 through F7, press the desired key without pressing the **SHIFT** key.

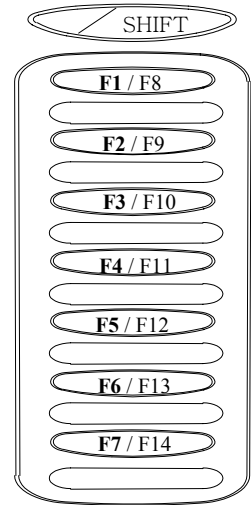

**Note:** The name information of the pressed Speed dial key is displayed for about 2 seconds. If no name, its number is displayed instead.

To access Function keys F8 through F14, first press the **SHIFT** key and then press the desired key. When the shift key is pressed, the LED light on the shift key will be turned on.

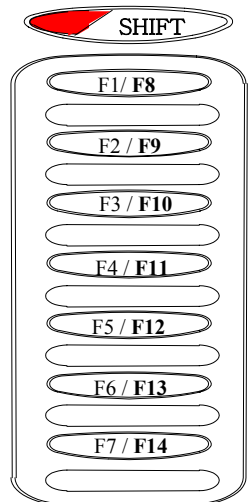

**Note:** The plastic cover of the speed dial label can be removed by inserting the tip of a pen or pencil into each of the holes at either end of the label and lifting up.

---

## 9.4 Phone Setting

UIP312 provides additional features that let you change different ring types, set names to be displayed on top of the screen, configure Do Not Disturb function and Disable Redial function.

### How to Use Phone Setting

Press the **MENU** button.  
On the MENU screen, select **Phone Setting**.

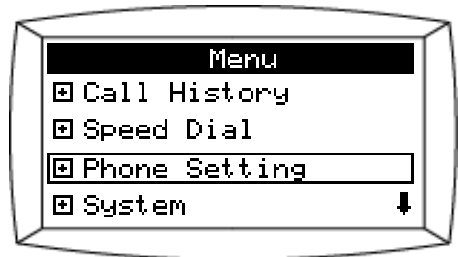

### 9.4.1 VMS (Voice Messaging System) Number

UIP312 has the Voice Message Lamp which informs you of incoming voice mails.

When the Voice Message Lamp flashes indicating you have a voice message, you can call the VMS machine and enter your password to check the message.

In order to use this VMS feature, you need to already have the VMS number set in your phone. Once the VMS number is set, you can simply press the Voice Message Lamp button to check your message.

### How to setup VMS Number

1. Press the **MENU** button.  
On the MENU screen, select **Phone Setting**.

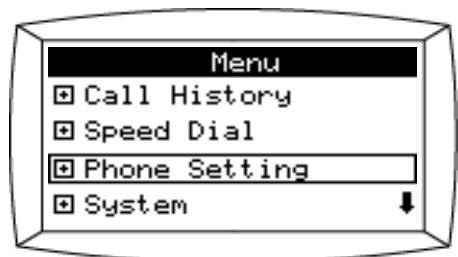

- 
2. Select **VMS Number** in Phone Setting and enter your VMS number, then press **OK**. This process sets up a speed-dial number for VMS access.

Up to **20 digits** can be programmed for the VMS number.  
VMS number is user password protected



**Note:** To program a pause press the REDIAL button.  
To program a flash, press the FLASH button.  
Input method of VMS number is basically the same as that of Speed Dial number.

3. The VMS button is lit when you have a recorded voice message waiting. Pressing the VMS button allows you to access the VMS system.

( See 8.10 Inputting Characters )

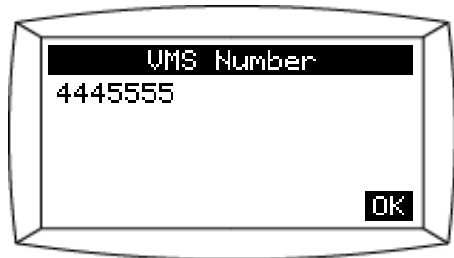

**Note:** If the VMS number field is not provisioned with VMS access number, VMS button will not work.

## 9.4.2 Ring Type

You can have different ring types for LINE1 and LINE2. Once the ring types are set differently between LINE1 and LINE2, you will hear different ring when a call came in on LINE1 from when a call came in on LINE2.

1. Press the **MENU** button.  
On the MENU screen, select **Phone Setting**.

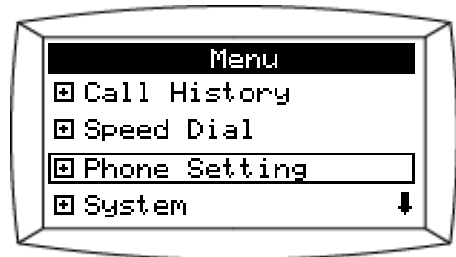

2. There are four items on the Phone Setting screen. Select **Ring Type**



3. Select Line 1 or Line 2.  
Press the up / down or left / right arrow key to select different ring types for incoming calls. There are 6 different ring types.

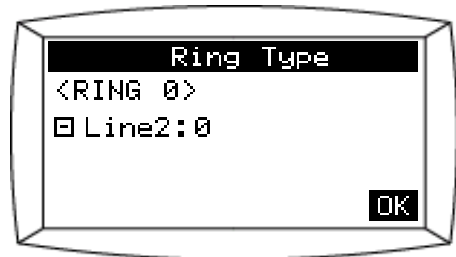

### 9.4.3 Display Name

This menu item let you set a name to be displayed for LINE1 or LINE2 on top of the main screen. If neither of the lines are registered you will see “Not registered” on top of the screen.

1. Press the **MENU** button.  
On the MENU screen, select **Phone Setting**.

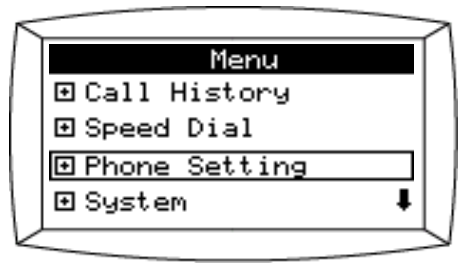

2. Then select **Display Name** to input digits or letters to display them on the top of the LCD screen when the phone is idle.



3. On the Display Name screen, select Line 1 or Line 2. Input your display name using the Dial Pad and press **OK**. Display Name is password protected. (Consult your network administrator to change your display name.)

( See 8.10 Inputting Characters )



**Note:** 1. The default of the lines' display name is the alias of each line. A line whose alias is not set is indicated by “No Alias” like in above screen shot.

2. When inputting names, the DTMF “ \* “ key and the DTMF “ # “ key are used for “/” and “.” respectively. 8.10 Inputting Characters



## 9.4.4 Phone Function

UIP312 let you make the phone not ring as well as disable its redial capability. These two functions are Do Not Disturb and Disable Redial.

**Note:** These two functions go back to their default settings after power on or reset.

1. Press the **MENU** button.  
On the MENU screen, select **Phone Setting**.



2. Select **Phone Function** to activate  
**Do Not Disturb** and **Disable Redial**.

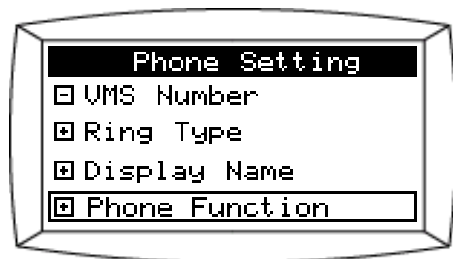

#### 9.4.4.1 Do Not Disturb

Select **Do Not Disturb** and Press **the right arrow key** to activate **Do Not Disturb**.

When **Do Not Disturb** is activated, the phone will not ring when it receives a call. Only the message lamp and LED will be lighted.

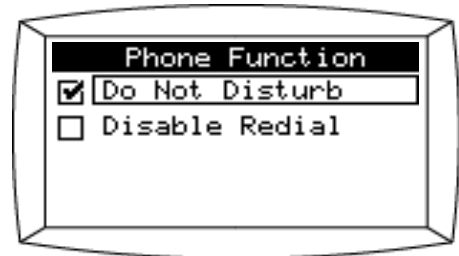

**Note :** [✓] mark in the box indicates the corresponding function is enabled.

**Note:** When Do Not Disturb is successfully activated, the smile icon ( 😊 ) will appear on your LCD screen.

#### 9.4.4.2 Disable Redial

You can incapacitate the REDIAL button by enabling Disable Redial function.

In order to disable the redial function, select **Disable Redial** and press **the right arrow key** to prevent others from using Redial on your phone.

Pressing the REDIAL button when the Disable Redial is turned on will generate a beep. The "Disable Redial" setting will be preserved even after reboot.



**Note :** [✓] mark in the box indicates the corresponding function is enabled.

**Note:** When Do Not Disturb is ON, UIP312 won't make any tone except the DTMF tones. In other words, pressing the REDIAL button while the Disable Redial is activated or, for instance, pressing the LINE 2 key when LINE 2 is not registered will make no beep.

## 9.5 System

### 9.5.1 New Password

Those configuration menu items critical to UIP312's fundamental operations are protected by a user or an administrator password.  
You can set the User password in this menu.



Menu items protected by the User or administrator password are as follows.

- Call History( User password)
- VMS Number( User password)
- Change Password( User password)
  
- Address Setting ( Administrator password)
- Voice ( Administrator password)
- Priority ( Administrator password)

1. Press the **MENU** button.  
On the MENU screen, select **System**.

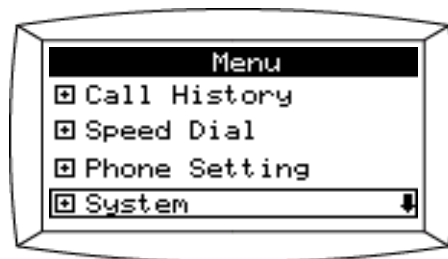

2. Select **New Password** to protect your configuration information.



**Note:** The password you set in this menu is valid once you exit this menu.

3. On the New Password screen, input your new password using the dial pad. Only numerals can be used for the password.  
**The password can be from one to four digits.**  
\* Input **Number Only**



4. When prompted, retype your password.

If you do not want the phone to be password protected, press **OK** at the **Enter New Password** prompt without entering any text. Press the **OK** again without entering any text at the **Retype Password** prompt.



**TIP:** Wrong input for old password or retype will display the following message.



**Note:** If you lost your password, consult your network administrator to reset your password.

You will lose your **Call history** and **VMS number** information as well when the administrator clears your user password. So be careful not to lose your user password.

## 9.5.2 Change Password

You are allowed to change the currently set password.  
If no password is currently set, you will see “New Password” submenu instead of “Change Password” submenu.

1. Press the **MENU** button.  
On the MENU screen, select **System**.



2. Select **Change Password**

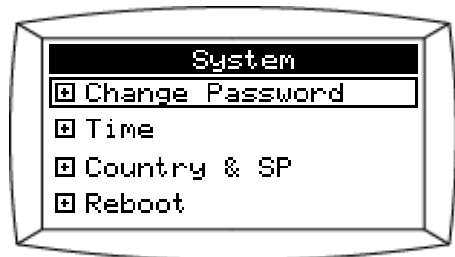

3. Type the currently set password.



4. Enter a new password.

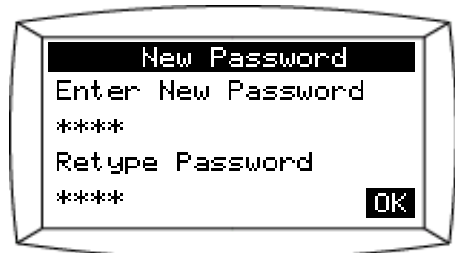

### 9.5.3 Clear Password

You can also clear the currently set password.  
If no password is currently set, you will see "New Password" submenu instead of "Change Password" submenu.

1. Press the **MENU** button.  
On the MENU screen, select **System**.



2. Select **Change Password**

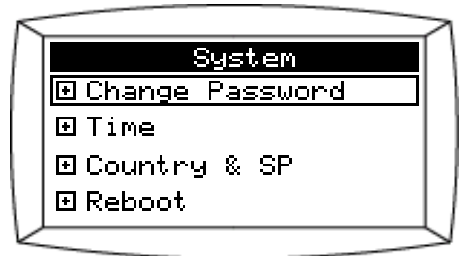

3. Type the currently set password.



4. Select **OK** twice without entering any password.



## 9.5.4 Time (Auto and Manual)

You can set the time and the date displayed on the main screen of UIP312. UIP312 provides two ways to do it. [AUTO] Mode enables UIP312 to set the time and date automatically. [MANUAL] Mode let you directly set them.

### 9.5.4.1 AUTO Mode

In this mode, the time and date are automatically set, and they are valid even after reboot. If the time and date are not automatically set after reboot even in [AUTO] Mode, consult your administrator.

1. Press the **MENU** button.  
On the MENU screen, select **System** and then select **Time**.

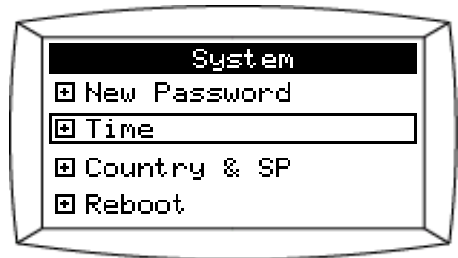

2. Select **Mode** on the Time screen and press the right arrow key until AUTO mode is selected. (The default is AUTO.)  
In the manual option, users enter the time directly. In the Auto option, the phone gets the time from the time sever.

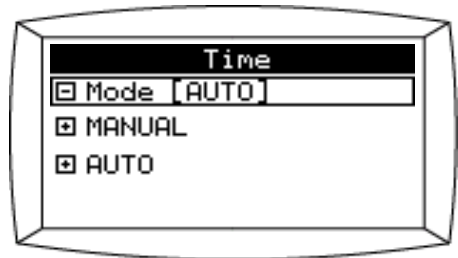

**Note:** Because when in DHCP mode, the phone obtains the time server address and the time offset from the DHCP server, the time server and time-offset entered in the menu do not take effect.

**TIP :** Accessing AUTO menu will generates "Invalid Mode" warning message when Mode is set to [MANUAL] or the phone is in DHCP mode.

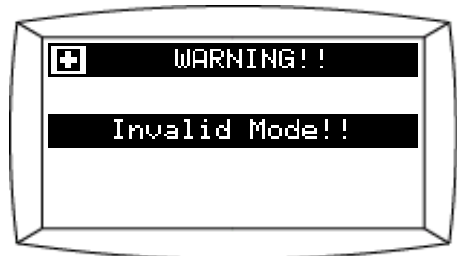

3. For **Auto**, after selecting **AUTO Mode** select **AUTO** Using the right arrow key.

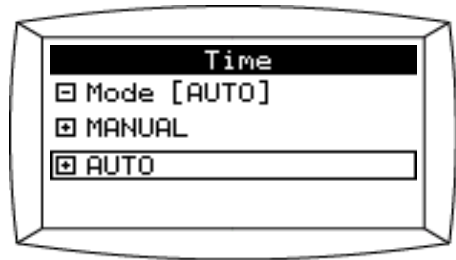

4. Select **Time Server**



5. Enter the time server's IP address.  
(Consult your network administrator for assistance.)

(This Time Server's address is valid only when the network is set to Manual IP.)

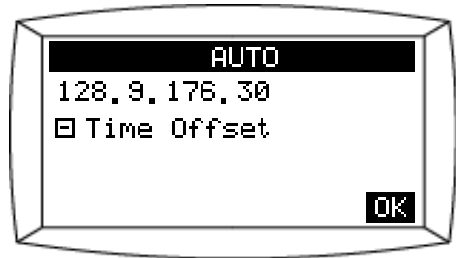

6. Follow the same process for **Time Offset**.  
After selecting **Time Offset**, search for an appropriate time offset using the arrow keys.

(This Time offset is valid only when the network is set to Manual IP.)



**Note:** See "About time offset based on the Official U.S. Time" on the next page.



---

### About time offset based on the Official U.S. Time

	<b>Standard time</b>	<b>Daylight Savings Time (Summer Time)</b>
<b>Atlantic</b>	GMT -04:00	No
<b>Eastern</b>	GMT -05:00	GMT -04:00
<b>Central</b>	GMT -06:00	GMT -05:00
<b>Mountain</b>	GMT -07:00	GMT -06:00
<b>Pacific</b>	GMT -08:00	GMT -07:00
<b>Alaska</b>	GMT -09:00	No
<b>Hawaii</b>	GMT -10:00	No
<b>Samoa</b>	GMT -11:00	No

### Daylight Saving Time( Summer Time)

When in DHCP mode, UIP312 will automatically adjust to the daylight saving time by accessing the DHCP server. If your phone does not reflect the daylight saving time, please contact your network administrator. If your UIP312 is not in DHCP mode, you will have to change the time offset for yourself.

### 9.5.4.2 MANUAL Mode

1. Press the **MENU** button.  
On the MENU screen, select **System**  
and then select **Time**

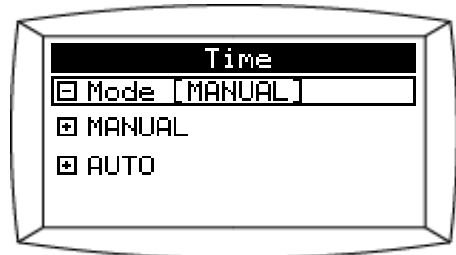

2. For **Manual**, select **MANUAL Mode**.  
Then select **MANUAL** using the  
right arrow key.

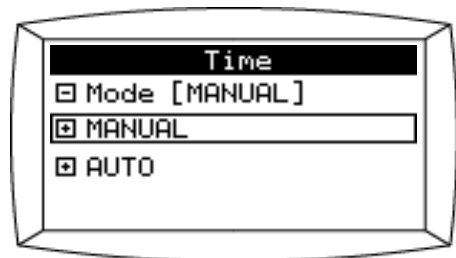

**Note:** When trying to accessing **MANUAL** submenu while **Mode** is in **[AUTO]**, you will be warned with "Invalid Mode!!" and won't be able to access it.

3. When entering the time manually, use  
military time format. For example,  
11:00 p.m. is entered as 23:00.  
  
The screen shot to the right is an  
example of setting 02:29:30 p.m Nov. 01.  
2002.

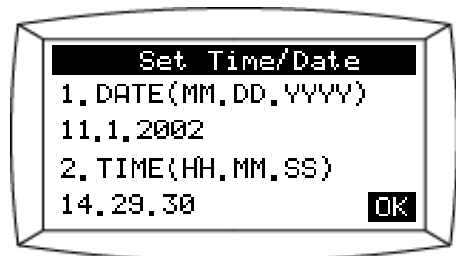

- MM : Month
- DD : Day
- YYYY : Year
- HH : Hour
- MM : Minute
- SS : Sec

**Note:** To key-in a period (.) when entering a time and date, press the " \* " button.

### 9.5.5. Country & SP (Service Provider)

1. Press the **MENU** button.

On the Menu screen, select **System** and then select **Country & SP**. (Consult your network administrator for assistance.)



2. Press the Up/Down or Left/Right arrow keys to select Country & SP. (The default is U.S.A.)



**Note:** If you are using this phone outside the U.S.A., please consult your administrator for assistance.

Country	Service Provider	Service Provider	Service Provider	Service Provider
U.S.A.	U.S.A.			
Australia	Optus			
Brazil	Brazil ABNT	Telebras	Telefonica	
China	China Guangdong	China MPT		
France	NovaXess			
Germany	ARCOR	DTAG		
Hong Kong	Hongkong Telecom	Wharf New T&T		
India	DoT	Second Operators		
Korea	Hanaro	Korea Telecom		
Mexico	MaxCom	MegaCable	Telmex	
Netherlands	NovaXess			
Philippines	Bayantel	Globe Philippines	PLDT	
Poland	Poland PTT			
Singapore	SingTel	StarHub		
Spain	Telefonica	AOP	Madridtel	
Taiwan	Chunghwa	NCIC	TFNC	
Denmark	TDC	Modilix	Tele2	TDC(Ericsson AXE)
Italy	Infostrada	Telecom Italy		
U.A.E.	ETISALAT			

### 9.5.6 Reboot

1. On the Menu screen, select **System** and then select **Reboot**.  
By doing this, the phone can be rebooted without resetting power.



2. Press the right arrow key to confirm the reboot process.

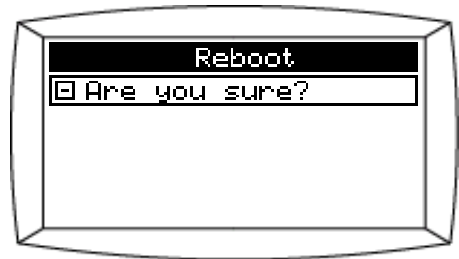

3. The phone will be rebooted with the following warning message



## 9.6 Information

### 9.6.1 Version

You can see the version info of the software and the hardware currently installed in you UIP312.

1. On the Menu screen, select **Information**.



2. On the Information screen, select **Version** to obtain information about your phone's application software, Bootrom, and hardware version.



3. A screen such as the one at the right will display your phone's information.



## 9.6.2 Network

You can see the current network setting of your UIP312.

1. On the Menu screen, select **Information**.

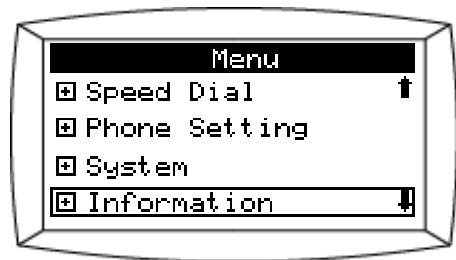

2. Select **Network**

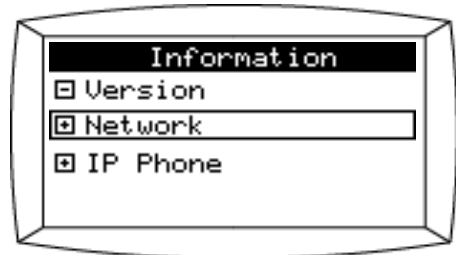

3. To obtain your IP address, select **IP Config**.

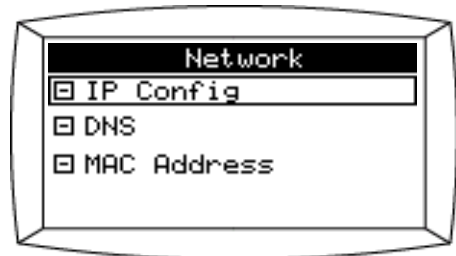

4. Follow the same procedure to obtain Information about your phone's DNS and MAC Addresses.

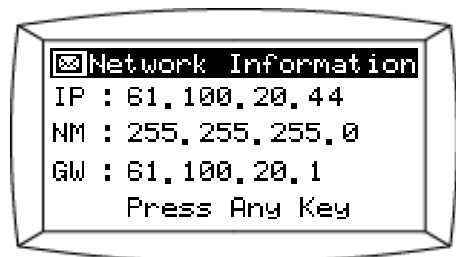

### 9.6.3 IP Phone

You can see the configuration info that enables UIP312 to make basic calls.

1. On the Menu screen, select **Information**.



2. Select **IP Phone** to verify gatekeeper address, and your phone's frame size and jitter buffer size.



3. Select **Address**.



4. The gatekeeper address and alias (telephone number) information will be displayed.



**Note:** GK address and alias of either LINE1 or LINE2 must have already been set. If you see GK not set or both LINE1 and LINE2 are "No Alias", consult with your administrator.

5. Select **Codec**



6. The Codec information will be displayed

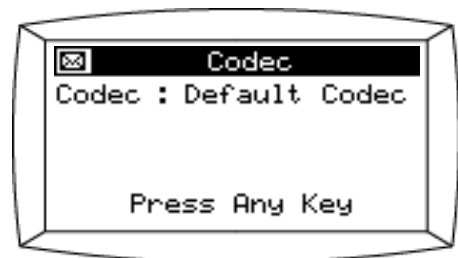

7. Select **Jitter Buffer**.

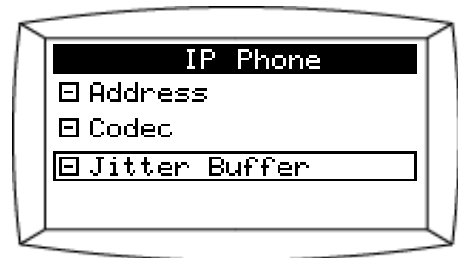

8. The default value of each jitter buffer is  
G.711 - 20 ms  
G.723.1 - 60 ms  
G.729A - 40 ms.

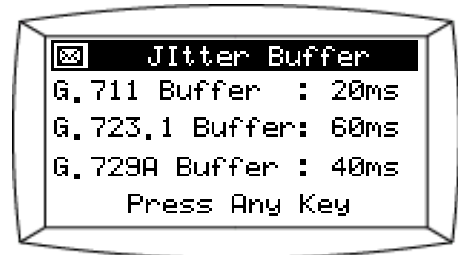



## 10. Using the Setup menus

The configuration items explained in this chapter are items that are necessary for the most fundamental operation of UIP312.

### !! WARNING !!

Since these items can be critical to the voice quality of UIP312, you are advised to consult your administrator on how to configure.

### 10.1 Address Setting

#### 10.1.1 GK (Gatekeeper) Address

UIP312 must register to GK Address in order to be able to perform basic call operations.

1. On the Menu screen, select **Setup**.



2. In the Setup menu screen, select **Address Setting**.  
Address Setting is administrator password protected.

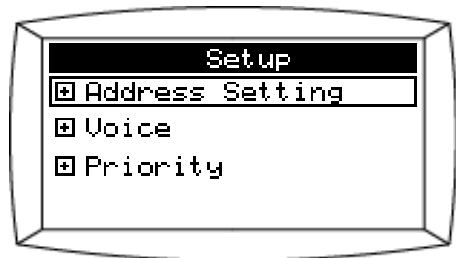

**Note:** Since Address Setting menu is protected by administrator password, if your UIP312 has the administrator password set you will be asked to enter the password.

3. Select **GK Address** to enter your GK address.  
(Please consult with your network administrator to obtain your GK address.)



4. Using the dial pad, input your **GK address**.  
To key-in a period (.) when entering an IP address, press "\*" .



**Note:** If GK Address is not correctly set, you won't be able to use the phone. Consult your administrator for more details.

### 10.1.2 ALIAS Number (Phone Number)

In order for UIP312 to function as a telephone, it needs to be assigned a telephone number. Alias refers to the telephone number.

1. On the Setup menu screen, select **Address Setting**.

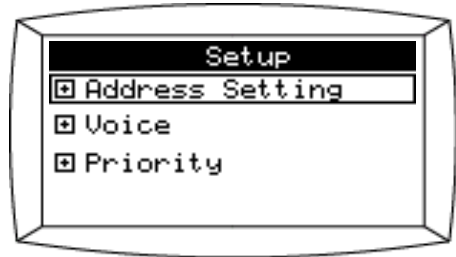

**Note:** Since Address Setting menu is protected by administrator password, if your UIP312 has the administrator password set you will be asked to enter the password.

2. Select **Alias 1**



3. Input your alias and press **OK**.  
Up to 16 digits are allowed.  
(Please consult your administrator to obtain your alias.)



4. To set up Alias 2, follow the same procedure used for Alias 1.

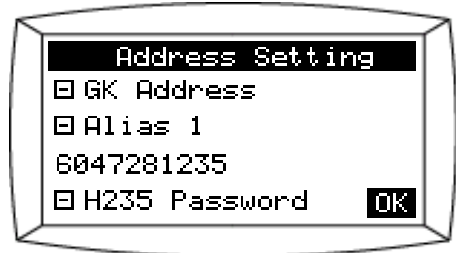

**Note:** At least either one of Alias 1 or Alias 2 must be properly set in order for UIP312 to work. Consult your administrator for more info.

---

**TIP:** Line 1 and Line 2 cannot have the same alias.  
If you enter the same alias of the other line, you  
will be notified with the warning message,  
saying "Duplicate Alias!!!", and that alias will  
not be saved.



### 10.1.3 H235 Password

H235 Password is a password used for authentication purpose during UIP312's registration process with GK. Consult your administrator for details.

1. On the Setup menu screen, select **Address Setting**.

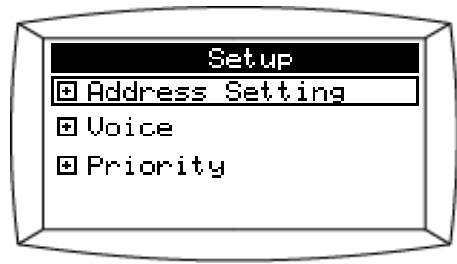

**Note:** Since Address Setting menu is protected by administrator password, if your UIP312 has the administrator password set you will be asked to enter the password.

2. Select **H235 Password**.



3. Enter your H235 password and press **OK** key. Password can have up to 15 alphanumeric characters. Please refer to your administrator for more info.

( See 8.10 Inputting Characters )

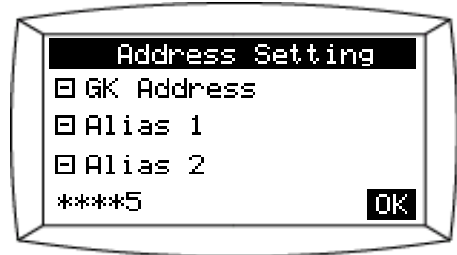

**Note:** If H235Password is not correctly set, the registration might fail. Consult with your administrator.

## 10.2 Voice

### 10.2.1 Select Codec

Codec refers to a way for UIP312 to compress voice data. Codecs supported by UIP312 are G.711, G.723.1 and G.729.A.

Because different codec setting might affect the voice quality of the phone, consult with your administrator when changing the setting.

1. On the Setup menu screen, select **Voice**.

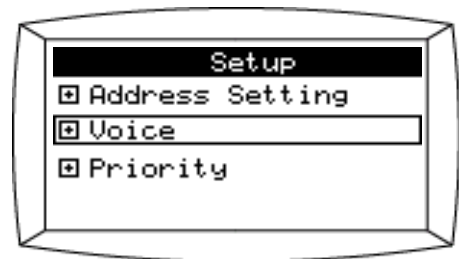

**Note:** Since Voice menu is protected by administrator password, if your UIP312 has the administrator password set you will be asked to enter the password.

2. Select **Codec**.

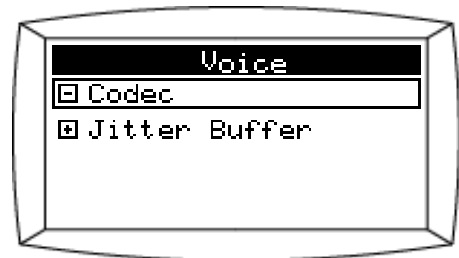

3. To manually select the Codec, select the desired G.711 frame size between 10ms and 30ms and G.723,1,G.729A by using the arrow keys.

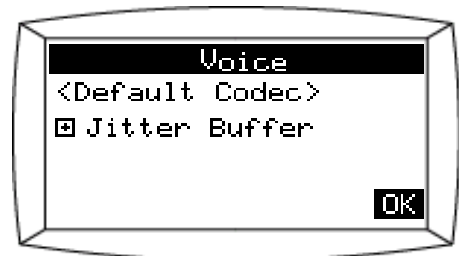

**Note:** Default Codec refers to the set of G.711 10ms, G.711 20ms, G.711 30ms, G.723.1 and G.729A that are available for use.

## 10.2.2 Jitter Buffer

Depends on the network condition, possible transmission problem may result in low voice quality. Taking such characteristics of network transfer into account, you can configure Jitter Buffer to improve the voice quality of UIP312. For details, please consult your administrator.

1. On the Setup menu screen, select **Voice**.

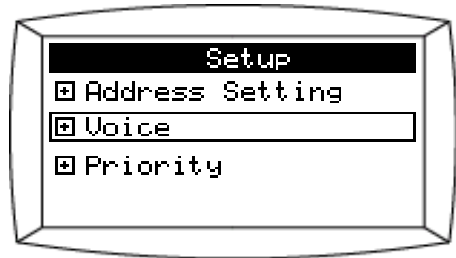

**Note:** Since Voice menu is protected by administrator password, if your UIP312 has the administrator password set you will be asked to enter the password.

2. Select **Jitter Buffer**.  
(Please consult your network administrator for assistance with your jitter buffer setting.)

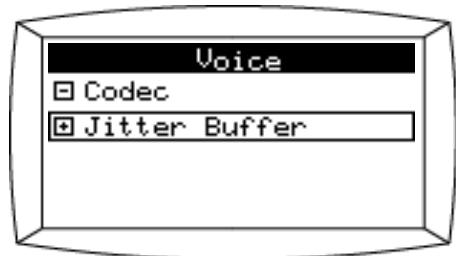

3. Select **G.711 Buffer**.

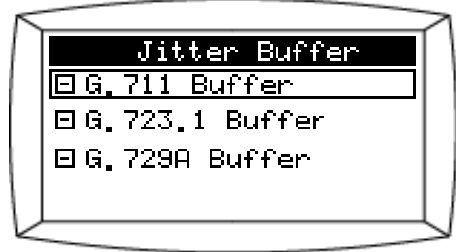

4. To manually select the **G.711 Buffer**, select the desired G.711buffer size between 10ms and 160ms by using the arrow keys.  
(The default value is 20ms.)



5. Select **G.723.1 Buffer**.

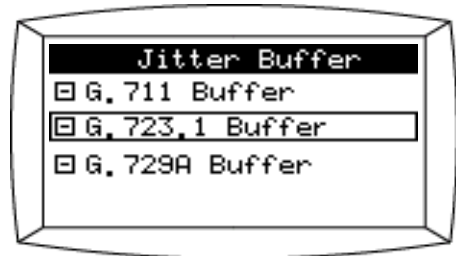

6. To manually select the **G.723.1 Buffer**, select the desired G.723.1buffer size between 10ms and 180ms by using the arrow keys. (The default value is 60ms.)



7. Select **G.729A Buffer**.

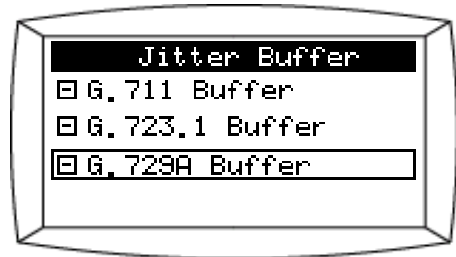

8. To manually select the **G.729A Buffer**, select the desired G.729Abuffer size between 10ms and 160ms by using the arrow keys. (The default value is 40ms.)





## 10.3 Priority

UIP312 provides a feature that gives voice data higher priority than other data when they are transmitted over the network in order to achieve QoS (Quality of Service)  
Please consult with your administrator when changing the setting.

### 10.3.1 Signal DiffServ

1. In the Setup menu screen, select **Priority**.

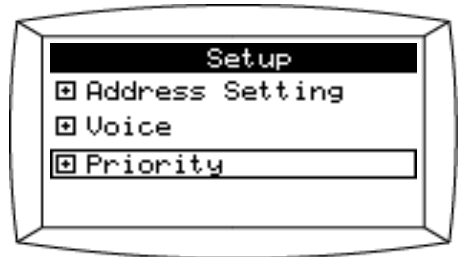

**Note:** Since Priority menu is protected by administrator password, if your UIP312 has the administrator password set you will be asked to enter the password.

2. Select **Signal DiffServ**.  
(Please consult your network administrator for assistance with your DiffServ setting.)

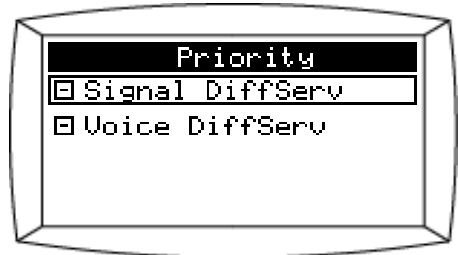

3. To manually select the **Signal DiffServ**, select the desired value between 0 and 63 by using the arrow keys.  
(The default is 32.)

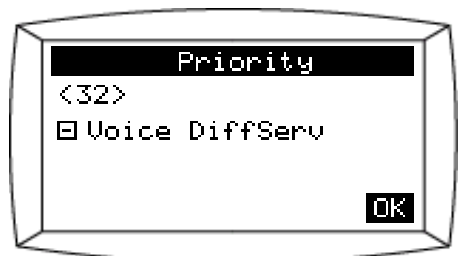

### 10.3.2 Voice DiffServ

1. In the Setup menu screen, select **Priority**.

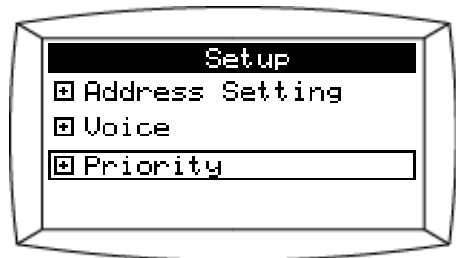

**Note:** Since Priority menu is protected by administrator password, if your UIP312 has the administrator password set you will be asked to enter the password.

2. Select **Voice DiffServ**.  
(Please consult your network administrator for assistance.)

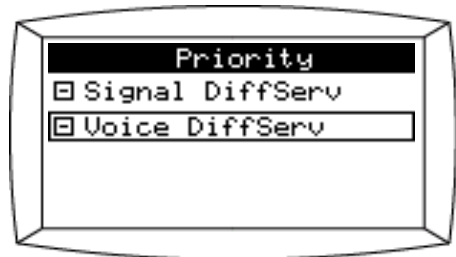

3. To manually select the **Voice DiffServ**, select the desired value between 0 and 63 by using the arrow keys.  
(The default is 40.)

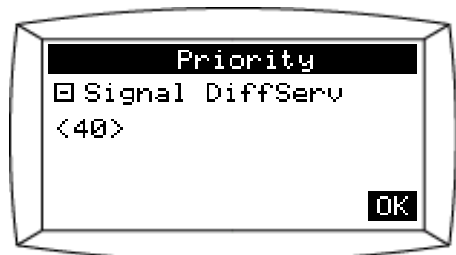

# 11. Display Information

## 11.1 “Upgrade Pending” ( Auto Upgrade )

You will see this message just prior to auto upgrade.  
When the S/W version in the TFTP server and the version currently installed in your UIP312 are different, UIP312 is automatically upgraded.

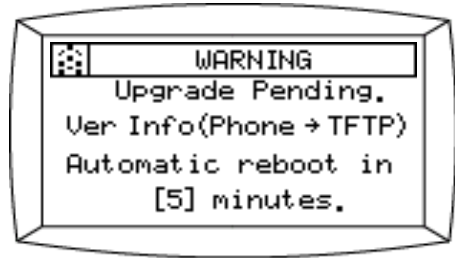

## 11.2 “DHCP Expired”

You will see this message when your UIP312 cannot receive an IP address from the DHCP server.  
UIP312 will reboot after the message.

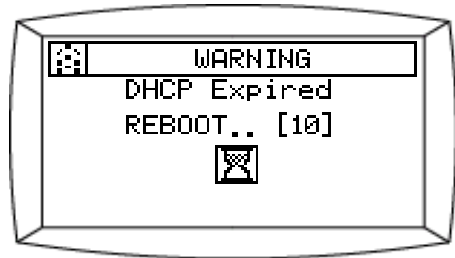

**Note: If the sequence of “DHCP Expired” message followed by reboot keeps repeating, consult your administrator for assistance.**

## 11.3 “IP Address Duplication”

You will see this message when your UIP312’s IP address and some other device’s IP address are identical.  
MAC address of the other device involved in this IP address conflict will be displayed.

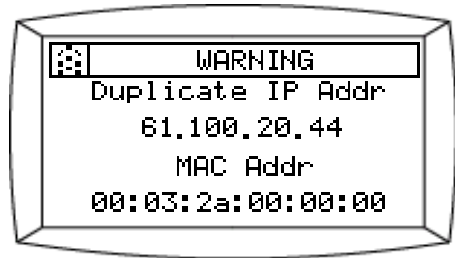

**Note: Inform your administrator of the duplicate IP address as well as the MAC address.**

 This icon indicates the message is network related.

---

## 12. Troubleshooting Guide

### While Using

Check the following:

1. Cannot make a call (there is no dial tone).  
→ Check the phone installation. Also check the connection between the Gatekeeper and the Phone.
2. Cannot make a call (there is a dial tone but no ringing).  
→ Check the connection to the Gatekeeper or contact the administrator.
3. Cannot make a call (no response).  
→ Contact the administrator.
4. Can hear through the handset but cannot hear through the speaker phone.  
→ Check if the headset adapter is plugged in.
5. Phone not ringing when there is an incoming call.  
→ Check if DND(Do Not Disturb) is enabled. You will see a smile icon on the LCD screen.
6. Set time server and offset, but time not displayed correctly.  
→ Check the network mode.  
If set to DHCP mode, the time server IP address and its offset won't be reflected.

**Note: If you keep having problems, contact your administrator.**

---

## 13. Frequently Asked Questions

### 1. Hook-switch Operation

The Uniden IP phone's hook-switch is used for re-origination only. That is, when the hook-switch is pressed and released, the existing call is released and a new call is originated. The hook-switch cannot be used for a flash operation (i.e., by pressing and releasing quickly). To initiate a flash operation, the IP phone's Flash button must be used.

### 2. VMWI (Visual Message Waiting Indication) Lamp

With the VMWI lamp illuminated, if power is removed from the phone and is reapplied, the VMWI lamp remains off until the VMWI refresh signal is applied by the CO (Central Office) switch.

### 3. Voice Message Lamp button won't work.

Check VMS Number submenu under Phone Setting. If no VMS number is stored in that menu, the button won't work. If it doesn't work even when a VMS number is stored, please consult your administrator.

### 4. Password Reset

When the user password is lost, the administrator can clear the user password by following the instruction in "3.5 Lost User Password" in the administrator guide. If the administrator forgets/does not know his/her password, the administrator can refer to the Administrative Guide to reset the password to the Clear Bootrom.

### 5. How to use Headset

Uniden has provided an adapter for the UIP312 hardware to make the headset jacks located on the left side of the main phone body function in a more universal application.  
(see 6.2 How to Use the Headset and Headset Adapter in this User Guide)

### 6. Handset Talk Volume

The user is not allowed to change the talker volume (handset microphone).

### 7. Programming PAUSE and FLASH for Speed Dial Entries

The user has the ability to program PAUSE/s and/or FLASH when inputting digits into a Speed call entry. To program a PAUSE, press the REDIAL button. To program a FLASH, press the FLASH button.

### 8. Entering Capital Letters in Speed Dial Entries

When entering letters in speed dial entries, press the *VOLUME* + key to change to capital letters. Press the *VOLUME* + key again to change back to low case letters.

### 9. How to insert "." during inputting an IP address such as GK address?

Press the DTMF \* key.

### 10. How to see Caller ID info when a call came in while using MENU?

Exit MENU by pressing the CANCEL button.

### 11. Can LINE1 and LINE2 keys be used to hang up?

No. Unlike the speakerphone button, LINE1 key and LINE2 key are only used for off hook or switching lines.

### 12. Where can I get technical support

**For Technical Support please call 1-800-648-4921.**

---

## 14. FCC Statement

### **Federal Communications Commission (FCC) Statement**

This equipment has been tested and found to comply with the limits for a Class B digital device, pursuant to part 15 of the FCC rules. These limits are designed to provide reasonable protection against harmful interference in a residential installation. This equipment generates, uses and can radiate radio frequency energy and, if not installed and used in accordance with the instructions, may cause harmful interference to radio communications. However, there is no guarantee that interference will not occur in a particular installation. If this equipment does cause harmful interference to radio or television reception, which can be determined by turning by equipment off and on, the user is encouraged to try to correct the following measures:

- Reorient or relocate the receiving antenna.
- Increase the separation between the equipment and receiver.
- Connect the equipment into an outlet on a circuit different from that to which the receiver on received.
- Consult the dealer or an experienced radio/TV technician for help.

This device complies with Part 15 of the FCC Rules. Operation is subject to the following two conditions: (1) This device may not cause harmful interference, and (2) this device must accept any interference received, including interference that may cause undesired operation.

---

## 15. Glossary

### **Alias**

Alias is the user's telephone number.

### **Centrex**

Business and personal service provided by a telephone company or service provider. Part of custom-calling services.

### **CODEC**

In this context, the term is an acronym for "**c**oder/**d**ecoder." This type of codec combines analog-to-digital conversion and digital-to-analog conversion functions in a single chip.

The term codec is also an acronym that stands for "**c**ompression/**d**ecompression.

### **Custom-calling Services**

Extra services ordered through a telephone company or service provider. May include Centrex services.

### **DHCP**

DHCP (Dynamic Host Configuration Protocol) is a protocol that lets network administrators manage centrally and automate the assignment of Internet Protocol (IP) addresses in an organization's network. Using the Internet's set of protocol(TCP/IP), each machine that can connect to the Internet needs a unique IP address.

### **DiffServ**

Differentiated Services (DiffServ, or DS) is a protocol for specifying and controlling network traffic by class so that certain types of traffic get precedence - for example, voice traffic, which requires a relatively uninterrupted flow of data, might get precedence over other kinds of traffic.

### **DNS**

The domain name system (DNS) is the way that Internet domain name are located and translated into Internet protocol addresses. A domain name is a meaningful and easy-to-remember "handle" for an Internet address.

### **Gateway**

A gateway is a network point that acts as an entrance to another network. In IP Telephony, gateway connects PSTN and IP Network.

### **H.323**

H.323 is a standard approved by the International Telecommunication Union (ITU) in 1996 to promote compatibility in videoconference transmissions over IP networks.H.323 was originally promoted as a way to provide consistency in audio, video and data packet transmissions in the event that a local area network (LAN) did not provide guaranteed service quality (QOS).

---

### **IP Telephony**

IP telephony (Internet Protocol telephony) is a general term for the technologies that use the Internet Protocol's Packet-switched connections to exchange voice, fax, and other forms of information that have traditionally been carried over the dedicated circuit-switched connections of the public switched telephone network.

### **Jitter**

Jitter is the deviation in or displacement of some aspect of the pulses in a high-frequency digital signal. As the name suggests, jitter can be thought of as shaky pulses. The deviation can be in terms of amplitude, phase timing, or the width of the signal pulse.

### **LAN**

A local area network (LAN) is a group of computers and associated devices that share a common communications line and typically share the resources of a single processor or server within a small geographic area (for example, within an office building).

### **MAC address**

On a local area network (LAN) or other network, the MAC (Media Access Control) address is your computer's unique hardware number. (On an Ethernet LAN, it's the same as your Ethernet address.) When you're connected to the Internet from your computer (or host as the Internet protocol thinks of it), a correspondence table relates your IP address to your computer's physical (MAC) address on the LAN.

### **PSTN**

The PSTN (public switched telephone network) refers to the world's collection of interconnected voice-oriented public telephone networks, both commercial and government-owned. It's also referred to as the Plain Old Telephone Service.

### **UTP**

Unshielded twisted pair is the most common kind of copper telephone wiring. Twisted pair is the ordinary copper wire that connects home and many business computers to the telephone company.

### **VoIP**

VoIP (voice over IP - that is, voice delivered using the Internet Protocol) is a term used in IP Telephony for a set of facilities for managing the delivery of voice information using the Internet Protocol(IP). In general, this means sending voice information in digital form in discrete Packet rather than in the traditional circuit-committed protocols of the public switched telephone network.



## Free Manuals Download Website

<http://myh66.com>

<http://usermanuals.us>

<http://www.somanuals.com>

<http://www.4manuals.cc>

<http://www.manual-lib.com>

<http://www.404manual.com>

<http://www.luxmanual.com>

<http://aubethermostatmanual.com>

Golf course search by state

<http://golfingnear.com>

Email search by domain

<http://emailbydomain.com>

Auto manuals search

<http://auto.somanuals.com>

TV manuals search

<http://tv.somanuals.com>