

*Industrial Line*  
**AC Inverter**™  
**5000 WATT**  
**DC to AC Power Inverter**



***User's Manual***

# Industrial Line 5000 Watt Power Inverter by Wagan Tech

USER'S MANUAL — Please read before using this equipment.

Your 5000 Watt Power Inverter converts 12-volt vehicle battery power into 115 volts of AC power. You can use the inverter in your vehicle to operate many types of appliances that use AC power such as TVs, VCRs, portable computers, power tools, and lights for emergency or camping use.

The inverter works with your vehicle's engine turned on or off (accessory mode). It provides a continuous output of up to 5000 watts.

## FRONT VIEW

- a. On/Off switch  
Leave in the OFF position during installation.
- b. Bar Graph meters  
Display battery voltage and current. Current should be in the green zone for continuous operation. The inverter will operate for several minutes when the current is in the yellow zone. Operation with battery voltage or current in the red zone of a meter will result in protective shutdown of inverter.
- c. AC outlets

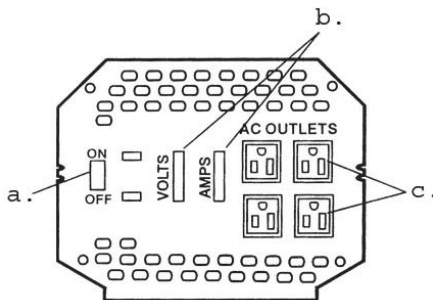

## REAR VIEW

- a. Ventilation window  
Do not obstruct, allow at least 2 inches for airflow.
- b. Battery terminals  
Connect to 12V power source. "+" is for positive connection and "-" is for negative connection. Reverse polarity connection will blow internal fuse and may damage inverter permanently.

Chassis ground lug: Connect to earth ground or to vehicle chassis using #4 AWG wire.

## Warning

Operation of the inverter without a proper ground connection may result in an electrical safety hazard.

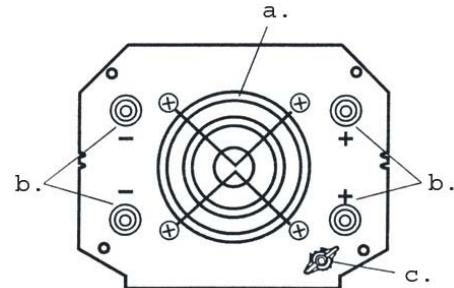

## BASIC OPERATION

Use the right operating voltage for both input and output of the inverter.

Powering devices by connecting from inverter to of battery terminal and connect from inverter to of battery terminal.

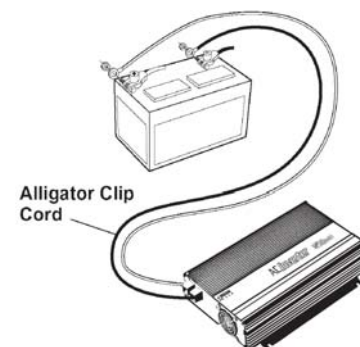

Insert the plug of your appliances into AC socket at the front of the inverter.  
Turn ON the power switch that is located at the front of the inverter, and the green LED light will light as indicator that the unit at work.



www.wagan.com

© 2003 Wagan Corporation.  
All Rights Reserved.

Wagan and Wagan.com are trademarks used by Wagan Corporation.

# Industrial Line 5000 Watt Power Inverter by Wagan Tech

USER'S MANUAL — Please read before using this equipment.

## INSTALLATION









### Where to install

The power inverter should be installed in a location that meets the following requirements:

- Dry- Do not allow water to drip or splash onto the inverter
- Cool- Ambient air temperature should be between 0C and 40C, the cooler the better
- Ventilation- Allow at least 2 inches of clearance around the inverter for airflow. Ensure the ventilation openings on the rear and bottom of the unit are not obstructed.
- Safety- Do not install the inverter in the same compartment as batteries or in any compartment capable of storing flammable liquids such as gasoline.

### Cables

DC to AC inverters requires high amperage/low voltage DC power to low amperage/high voltage AC power. To operate properly connect inverter DC input terminals direct to battery with heavies wire available see chart below:

ALPHA Neoprene Welding Cable			
Wire Size(AWG)	Overall	Outside Diameter	(inches/mm)Size
			
# 6AWG 0.35/8.89	# 2AWG 0.48/12.19	# 1/0AWG 0.58/14.77	# 3/0AWG 0.70/17.78
			
# 4AWG 0.42/10.70	# 1AWG 0.52/13.21	# 2/0AWG 0.64/16.26	# 4/0AWG 0.82/20.83

## Grounding

The power inverter has a lug on the rear panel marked "chassis ground". This is to connect the chassis of the power inverter to the ground. The ground terminals in the AC outlets on the front panel of the inverters are also connected to the ground lug.

The chassis ground lug must be connected to the grounding point, which will vary depending on where the power inverter is installed. In a vehicle, connect the chassis ground to the chassis of the vehicle. In a boat, connect to the boat's grounding systems. In a fixed location, connect the chassis ground lug to earth.

The neutral (common) conductor the power inverter AC output circuit is connected to the chassis ground. Therefore, when the chassis is connected to the ground, the neutral conductor will also be grounded. This conforms to the national electrical code requirements the separately derived AC sources (such as inverters and generators) have their neutral tied to ground in the same way that the neutral conductor from the utility line to ground at AC breaker panel.

### Caution

The negative DC input of the power inverter is connected to the chassis. Do not install the power inverter in a positive ground DC system. As positive ground DC system has the positive terminal of the battery connected to the chassis of the vehicle or to the ground point.



www.wagan.com

© 2003 Wagan Corporation.  
All Rights Reserved.

Wagan and Wagan.com are trademarks used by Wagan Corporation.

# Industrial Line 5000 Watt Power Inverter by Wagan Tech

USER'S MANUAL — Please read before using this equipment.

## QUICK HOOK UP AND TESTING

If you would like to quickly hook up the power inverter and check its performance before going ahead with your installation, please follow these guidelines:

1. Unpack and inspect the power inverter, check to see that the power switch in the OFF position.
2. Connect the cable to the power input terminals on the rear panel of power inverter. The red terminal is positive (+) and black terminal is negative (-). Connect the cable into the terminals and tighten the wing nut to clamp the wires securely.
3. Connect the cable from the negative terminal of the inverter to the negative terminal of the power source. Make a secure connection.

### Caution

Loosely tightened connectors result in excessive voltage drop and may cause overheated wires and melted insulation.

4. Before proceeding further, carefully check that the cable you have just connected connects from the negative terminal of inverter to the negative output terminal of the power source.
5. When connecting the inverter directly to your battery terminals, it is important to connect with right polarity (connect  $\oplus$  from inverter to  $\oplus$  of battery terminal and connect  $\ominus$  from inverter to  $\ominus$  of battery terminal)

### Warning

You may observe a spark when you make this connection since current may flow to charge capacitors in the power inverter. Do not make this connection in the presence of flammable fumes, as explosion or fire may result.

6. Set the power switch to the ON position. Check the meters and indicators on the front panels of the inverters. The voltage bar graph should indicate 11 to 14 volts, depending on the voltage of the power source. If it does not, check your power source and the connections to inverter. The other indicators should be off.
7. Set power inverter switch to the OFF position, the indicator lights may blink and the internal alarm may sound momentarily. This is normal. Plug the test

load into the AC receptacle on the front panel of the inverter. Leave the test load switch off.

8. Set power inverter switch to the ON position and turn the test load on, the inverter should supply power to the load. If you plan to measure the true output R.M.S. voltage of inverter, a meter such as FLUKE 87A, BACKMAN 4410 or TRIPLETT 4200 must be used.

### CAUTION:

- DO NOT USE THE INVERTER IN A POSITIVELY GROUNDED VEHICLE.

### RECOMMENDATION

- If the power inverter makes a beeping sound, turn OFF the power inverter and disconnect all appliances from inverter and disconnect the inverter from power supply. The beeping sound is simply the low battery warning, which indicates that the voltage of the battery power supply is getting low. Please restart the vehicle engine before operating the power inverter.
- When you are not using the inverter, turn the power switch to OFF and disconnect the inverter from power supply.
- Disconnect the inverter when starting the vehicle's engine.

### CAUTION:

THE FOLLOWINGS OPERATION WILL DAMAGE AND VOID THE WARRANTY OF THE INVERTER:

- REVERSE POLARITY BY CONNECTING THE WIRES TO THE INCORRECT TERMINALS.
- CONNECTING THE BATTERY CHARGER TO REPLENISH BATTERY WITHOUT DISCONNECTING THE INVERTER FIRST.
- CONNECTING THE INVERTER TO POWER SOURCE GREATER THAN 15-VOLT DC.
- OPERATING THE INVERTER AND BATTERY IN OR AROUND WATER.



www.wagan.com

© 2003 Wagan Corporation.  
All Rights Reserved.

Wagan and Wagan.com are trademarks used by Wagan Corporation.

4

# Industrial Line 5000 Watt Power Inverter by Wagan Tech

USER'S MANUAL — Please read before using this equipment.

## MEASURING THE AC VOLTAGE

The output waveform of the AC inverter is a MODIFIED SINEWAVE. To measure the AC output voltage, you must use a TRUE RMS VOLTMETER.

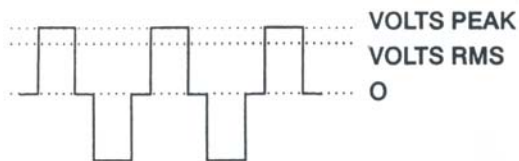

## RECOMMENDED BATTERY CONFIGURATION FOR HEAVY-DUTY APPLICATION

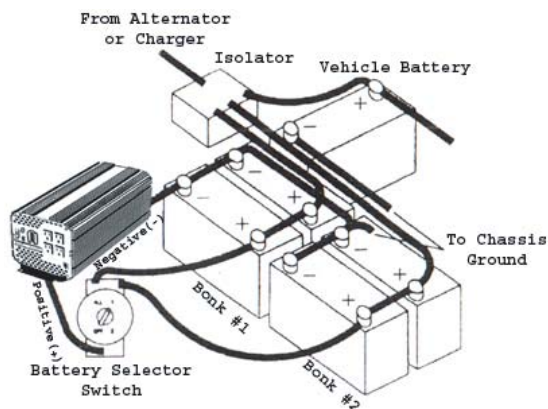

Heavy-duty alternators rated above 120 Amps should be used and they are available from RV, marine or auto parts suppliers. These alternators are designed to directly replace standard alternators but produce the higher current and voltage required to charge multiple battery systems.

An isolator is used to separate the vehicle's system batteries and the auxiliary batteries.

We recommend using the same deep cycle type of batteries in the battery banks.

### Notes

The above system should be installed properly. You need to contact the RV or auto experts for some instructions.

## SAFETY PRECAUTION

Do not open the case of the inverter. The high voltage inside the unit is the same type of power as your electrical outlets at home.

Do not let the cord of the inverter or any appliance's cord get wet.

Do not operate the inverter in or around water. The voltage of the unit makes electrical shock hazard if operated in wet conditions.

Do not connect the AC inverter directly to another AC power source.

Keep it away from children, the inverter produces power just like your AC wall outlets at home and should be treated seriously.

Allow at least 2 inch of clearance around the inverter for airflow.

If you operate the inverter in a moving vehicle, you need to secure the inverter to prevent it from shifting around while the vehicle is moving.

If there is anything wrong with the inverter, disconnect all of the power.



www.wagan.com

© 2003 Wagan Corporation.  
All Rights Reserved.

Wagan and Wagan.com are trademarks used by Wagan Corporation.

# Industrial Line 5000 Watt Power Inverter by Wagan Tech

USER'S MANUAL — Please read before using this equipment.

## TROUBLESHOOTING

Condition	Solution
Poor contact	Clean contact parts thoroughly
Battery voltage is too low	Start the engine to recharge the battery. Replace the battery if needed.
Shutdown on overload	Reduce the wattage of inverter's load
Thermal shutdown	Allow the inverter to cool down by reducing the load or turn it off for a while.
Receptacle has no power	Check the receptacle wiring.

## MAINTENANCE

Very little maintenance is required to keep the inverter operating properly.

## DESCRIPTION

**10000W Peak Power** — allow you to power appliances that require a large amount of initial (peak) power to work (such as many TVs and motor-power equipments).

**Low Battery Alarm** — the inverter sounds an audible alarm then turns itself off if the source battery becomes too low.

**Auto Shutdown/Reset Protection** — the inverter shuts itself down to protect from low battery drained.

**Overload/Short Circuit Protection** — the inverter automatically turns itself off if the connected load is too high or if it shorts.

**Fuse** — the inverter comes with fuse/s already installed.

**4 AC Outlets** — allows you to power up many appliances at the same time.

## HEAT DISPERSAL

The inverter generates heat while it is working. This is not a malfunction. However, if the inverter gets too hot while working, it will turn off by itself. Position the inverter where air flows freely around it to allow the heat to disperse. The inverter's thermal protection prevents it from operating when its temperature exceeds  $130 \pm 10$  °F /  $55 \pm 5$  °C.

## SPECIFICATION

Name	Description
Input	12V (10-15V) DC
Output	115V AC
Output waveform	Modified Sine Waveform
Continuous power	5000 Watt
Surge power	10000 Watt
Efficiency	Approx. 90 %
No load current	< 0.3 A
Battery low alarm	$10.5 \pm 0.5$ V DC
Battery low shutdown	$10 \pm 0.5$ V DC
AC output socket	4 outlets of 3-prong
Power switch	DC input ON/OFF control
Dimensions	20x9x7 in <sup>3</sup>
Net Weight	22 lb

## NOTE

All specifications are typical at nominal line, half load, and 77° F / 25° C unless otherwise noted. Specifications are subject to change without notice.



www.wagan.com

© 2003 Wagan Corporation.  
All Rights Reserved.

Wagan and Wagan.com are trademarks used by Wagan Corporation.

## WAGAN Corp. Limited Warranty Registration Form

All WAGAN Corporation products are warranted to the original purchaser of this product.  
**Warranty Duration:** This product is warranted to the original purchaser for a period of one (1)Year from the original purchase date, to be free of defects in material and workmanship. WAGAN Corporation disclaims any liability for consequential damages. In no event will WAGAN Corporation be responsible for any amount of damages beyond the amount paid for the product at retail. In the even of a defective item, please ship the item, prepaid, with a complete explanation of the problem, your name, address and daytime phone number. WAGAN Corporation will, at its option, replaces or repair the defective part. This warranty is void if the product has been damaged by accident, in shipment, unreasonable use, misuse, neglect, improper service, commercial use, repairs by unauthorized personnel or other causes not arising out of defects in materials or workmanship. This warranty is effective only if the product is purchased and operated in the USA and does not extend to any units which have been used in violation of written instructions furnished.

**Warranty Disclaimers:** This warranty is in-lieu of all warranties expressed or implied and no representative or person is authorized to assume any other liability in connection with the sale of our products. There shall be no claims for defects or failure of performance or product failure under any theory of tort, contract or commercial law including, but not limited to negligence, gross negligence, strict liability, breach of warranty and breach of contract.

**Warranty Performance:** During the above one (1)Year warranty period, a product with a defect will be replaced with a comparable model when the product is returned to WAGAN Corporation with an original store receipt. The replacement product will be in warranty for the balance of the one (1)Year warranty period.

- Please activate my limited warranty for WAGAN Corp.5000 Watt Industrial Power Inverter
- Enclosed copy of original sales receipt.

Name			
Mail Address			
City			
State, Zip Code			
Item Purchased	5000 Watt Industrial AC to DC Power Inverter		
Stores Name			
Date of Purchase			
Signature		Date	

All WAGAN Corporation Products must be registered within (30) days of purchased to activate this warranty. Mail the complete registration form, along with a copy of the original receipt to:

Attn: Customer Service  
WAGAN Corporation  
3589Yale Way  
Fremont, CA 94538

© 2003 WAGAN Corp.

## Free Manuals Download Website

<http://myh66.com>

<http://usermanuals.us>

<http://www.somanuals.com>

<http://www.4manuals.cc>

<http://www.manual-lib.com>

<http://www.404manual.com>

<http://www.luxmanual.com>

<http://aubethermostatmanual.com>

Golf course search by state

<http://golfingnear.com>

Email search by domain

<http://emailbydomain.com>

Auto manuals search

<http://auto.somanuals.com>

TV manuals search

<http://tv.somanuals.com>