

*Sunbeam*

# Bar Espresso

## Pump espresso machine

### Instruction Booklet

This book covers the use and care of the following Sunbeam Espresso machines:  
EM3500 and EM3500S (Satin Finish)

Please read these instructions carefully  
and retain for future reference.





# Contents

<b>Sunbeam's Safety Precautions</b>	<b>2</b>
<b>About espresso coffee</b>	<b>3</b>
<b>Features of your Bar Espresso</b>	<b>4</b>
<b>Operations Guide for your Bar Espresso</b>	<b>7</b>
<b>Secrets to the perfect cup</b>	<b>10</b>
<b>Easy steps for frothing milk</b>	<b>11</b>
<b>Before using your Bar Espresso</b>	<b>12</b>
<b>Functions of your Bar Espresso</b>	<b>13</b>
<b>Care and Cleaning of your Bar Espresso</b>	<b>16</b>
<b>Descaling</b>	<b>17</b>
<b>Trouble shooting guide</b>	<b>19</b>
<b>Recipes</b>	<b>22</b>

تأكد من تفهم احتياطات السلامة المذكورة اعلاه

請務必理解上述的安全預防措施。

Assurez-vous que les précautions ci-dessus relatives à la sécurité sont bien comprises

Versichern Sie sich daß die obenstehenden Sicherheitsmaßnahmen Verstanden werden

Βεβαιώνετε πως οι παραπάνω προφυλάξεις ασφαλείας γίνονται κατανοητές

Pastikan bahwa tindakan-tindakan keselamatan seperti di atas dimengerti anda

Accertatevi che le suddette norme di sicurezza siano comprese a dovere

上記の注意事項をよくお読みになり、安全を御確認ください

Уверете се дека погоре споменатите мерки на претпазливост се добро разбрани

Asegúrese de que las precauciones de seguridad precedentes sean bien comprendidas

کاری بکنید کہ احتیاطهای بالا حتماً درک بشوند

ต้องแน่ใจว่า ข้อควรระวังเรื่องความปลอดภัยข้างต้น เป็นที่เข้าใจกันดี

Yukarda belirtilen güvenliik önlemlerinin anlaşılığından emin olunuz

Xin kiểm chắc rằng những biện pháp làm an toàn kể trên được hiểu rõ

# Sunbeam's Safety Precautions

## SAFETY PRECAUTIONS FOR YOUR SUNBEAM ESPRESSO MACHINE.

- Always place the unit on a flat, level surface.
- Do not operate without water in reservoir.
- Do not remove the filter holder during water flow or coffee flow as the unit is under pressure. Removing the filter holder during operation can lead to a scalding or injury.
- Clean the steam nozzle only when the unit has been switched off and allowed to cool.

**Sunbeam are very safety conscious when designing and manufacturing consumer products, but it is essential that the product user also exercise care when using an electrical appliance. Listed below are precautions which are essential for the safe use of an electrical appliance:**

- Read carefully and save all the instructions provided with an appliance.
- Always turn the power off at the power outlet before you insert or remove a plug. Remove by grasping the plug - do not pull on the cord.
- Turn the power off and remove the plug when the appliance is not in use and before cleaning.
- Do not use your appliance with an extension cord unless this cord has been checked and tested by a qualified technician or service person.
- Always use your appliance from a power outlet of the voltage (A.C. only) marked on the appliance.
- Close supervision is necessary when your appliance is being used near children or infirm persons.
- Never leave an appliance unattended while in use.
- Young children should be supervised to ensure that they do not play with the appliance.

- Disconnect the plug from the power outlet if there is any problem during the coffee making process or prior to cleaning your appliance.
- Do not allow the power cord to come into contact with the hot parts of the appliance (cup warming plate, filter holder, steam nozzle).
- Keep hands away from hot parts of the appliance, including the cup warming plate, filter holder and steam nozzle.
- Do not use an appliance for any purpose other than its intended use.
- Do not place an appliance on or near a hot gas flame, electric element or on a heated oven. Do not place on top of any other appliance.
- Do not let the power cord of an appliance hang over the edge of a table or bench top or touch any hot surface.
- For safety reasons and to avoid maintenance by unskilled persons, some appliances are 'sealed' using tamperproof screws. Such appliances should always be returned to the nearest Sunbeam Appointed Service Centre for adjustment or repair if required.
- Do not operate any electrical appliance with a damaged cord or after the appliance has been dropped or damaged in any manner. If damage is suspected, return the appliance to the nearest Sunbeam Appointed Service Centre for examination, repair or adjustment.
- For additional protection, Sunbeam recommend the use of a residual current device (RCD) with a tripping current not exceeding 30mA in the electrical circuit supplying power to your appliances.
- Do not immerse the appliance in water or any other liquid unless recommended.

If you have any concerns regarding the performance and use of your appliance, please visit [www.sunbeam.com.au](http://www.sunbeam.com.au) or contact the Sunbeam Consumer Service Line. Ensure the above safety precautions are understood.

# About espresso coffee

The Sunbeam range of espresso machines are sure to satisfy lovers of coffee. With its powerful 15 BAR pump, 'Thermoblock' heating system and unique dual-wall 'crema' system the Sunbeam Bar Espresso will provide endless cups of quality coffee. Coffee is an integral part of Australian culture. With Café numbers increasing, the demand for the perfect cup combined with the right atmosphere is the goal of many coffee connoisseurs.

## **What makes a good coffee?**

Sunbeam have consulted with experienced coffee makers and appreciators of coffee through every stage of design, to ensure the machine delivers a great coffee every time. There are many factors that contribute to the perfect coffee. The words 'taste' and 'aroma' are consistently used when describing the perfect cup.

The sweet aroma and taste of the perfect coffee is largely due to the correct combination of temperature and pressure during the brewing process. The 'Thermoblock' heating system ensures the water is at the correct temperature, so that the full coffee flavour is extracted.

Secondly, the combination of the 15 BAR pump, dual-wall filter and stabilising baffle ensures the correct pressure at which the liquid espresso is released from the spout. The flow should consist of both liquid and cream. This cream is commonly known as the Crema. The perfect Crema should be thick and stable and preserve the coffee flavour, aroma and temperature.

We hope you have many enjoyable coffee experiences with the Sunbeam Bar Espresso. Should you need any further assistance please don't hesitate to contact the Sunbeam coffee hotline on free call 1800 025 059.

# Features of your Sunbeam Bar Espresso

## Warming plate

Gently pre-heats espresso cups.

## Operating dial

Easy to operate selector dial - turn to the right to make espresso (☕) or to the left for Steam (☁).

## Brewing head

## Filter lock

## Drip tray with water level indicator

The water level indicator floats through the drip tray indicating how full the drip tray is. The indicator is red for easy identification.

## Tamp

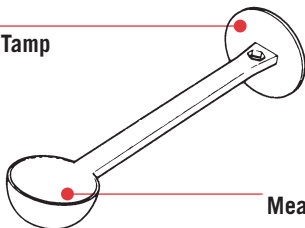

Measuring spoon

## Non-slip rubber feet

Makes the unit sturdy, preventing it from slipping on the bench top.

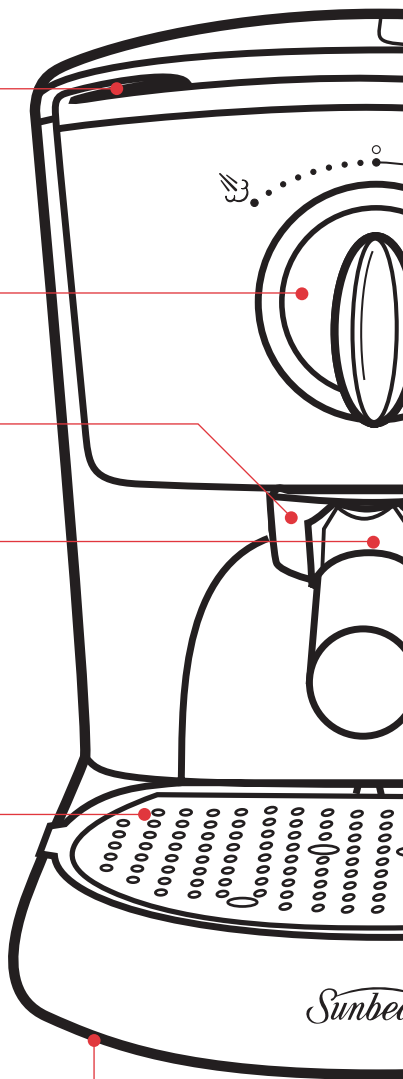

### 1.1L removable water reservoir

The 1.1 Litre water reservoir is removable for easy filling. Simply lift the hinged lid and remove.

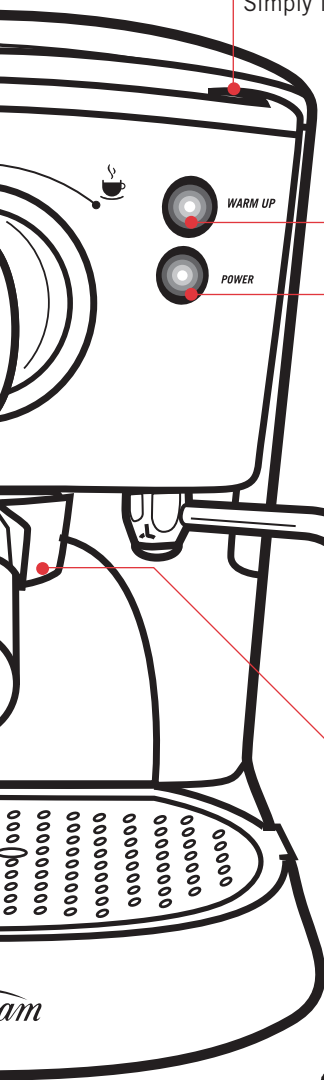

Warm Up light

Neon power switch

Steam nozzle



Froth enhancing steam attachment

Designed for ease of use, the rubber froth attachment creates thick, dense and shiny milk froth in seconds.

Filter handle

Stainless steel frothing jug

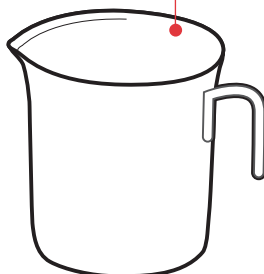

1 cup filter



2 cup filter

**15 BAR pu**

The Italian  
necessary t

**'Thermoblock' h**

Ensures the pre  
rather than boil  
it allows the w

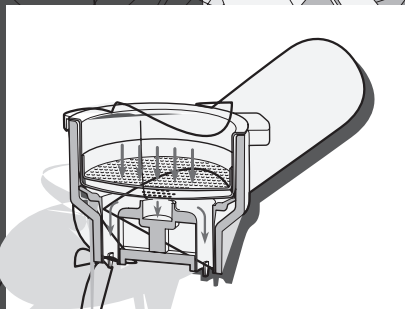
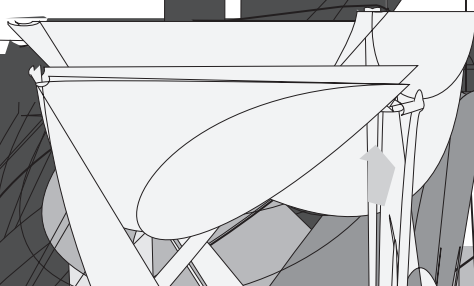



# Operations Guide for your Bar Espresso

The diagrams below and on the following pages are to assist you in using your Sunbeam Bar Espresso. Each of the diagrams is numbered. Throughout this instruction manual these numbers will be referred to.

For example: Fill the water reservoir (1) (2) (3) (4) (5) with cold tap water...

Each time you see these numbers please refer back to the diagrams at the front of the instruction manual.

## Filling the water reservoir.

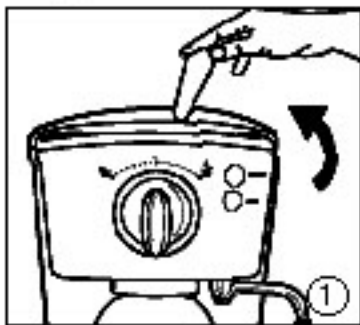

Open lid of water reservoir.



Fill in place with cold water, OR

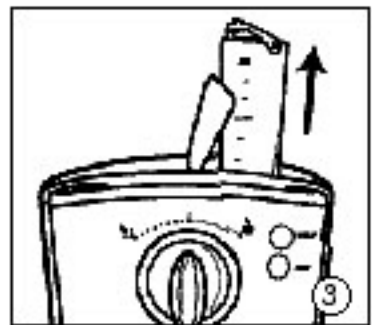

Remove water reservoir

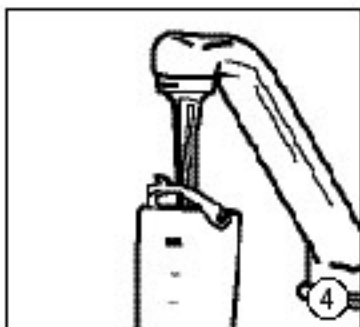

Fill at sink with cold water.

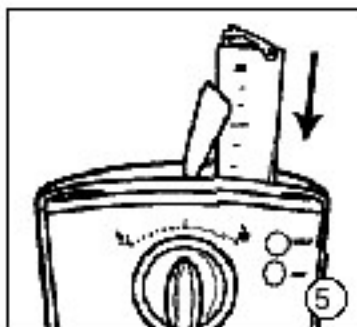

Replace the water reservoir.

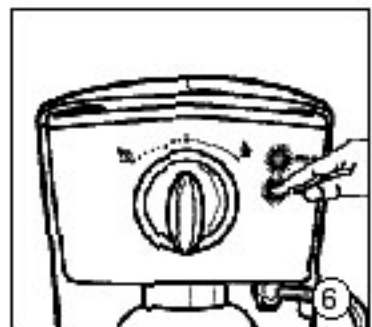

Turn on the unit.

## Preparing the espresso machine.

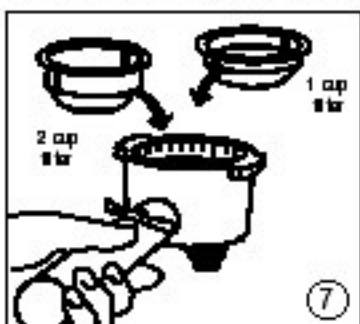

Select Filter

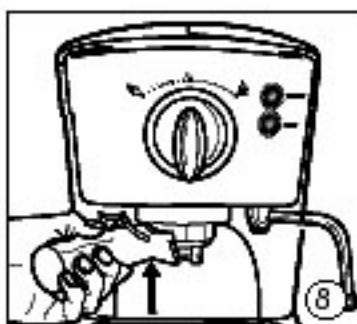

Place filter handle onto brewing head

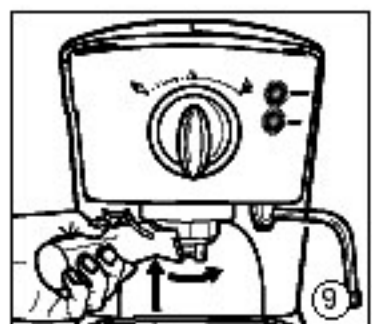

Turn filter handle to the right

## Operations Guide for your Bar Espresso (continued)

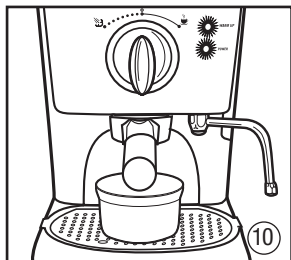

Place container under brewing head.

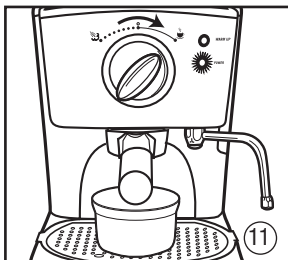

Turn operating dial to the right.

### Making an Espresso

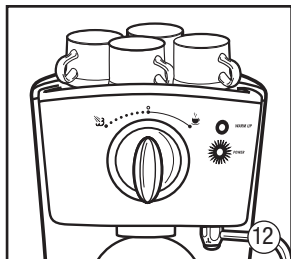

Warming espresso cups.

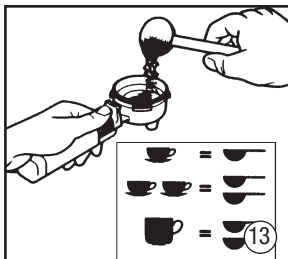

	=		13
	=		
	=		
	=		

Place coffee in filter.

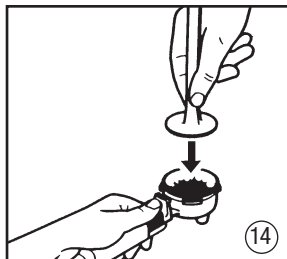

Tamp the coffee.



Wipe the edge of filter to remove any coffee grounds.

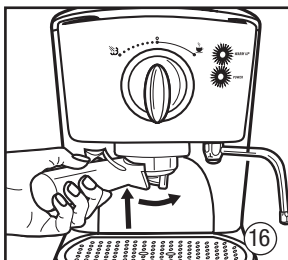

Place filter holder onto brewing head and turn handle to the right.

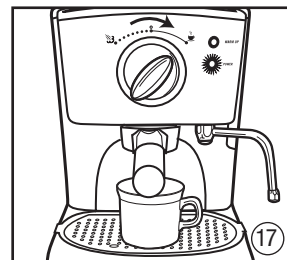

Turn the operating dial to the right to make an espresso.

Operations Guide for your Bar Espresso (continued)

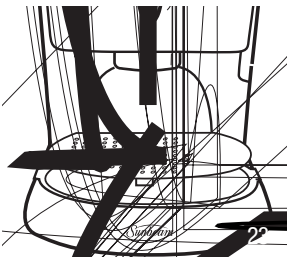
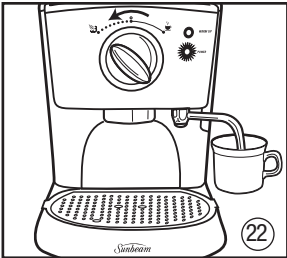
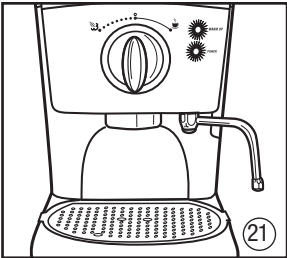
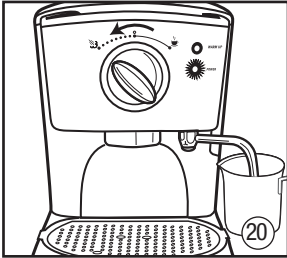
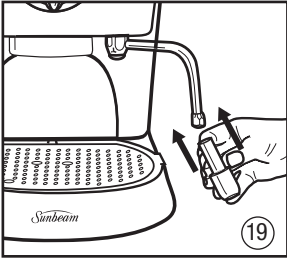
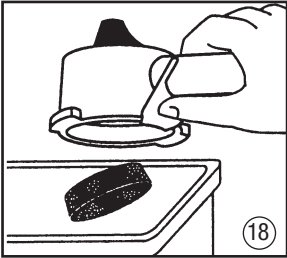

Remove the drip tray grid.

# Secrets to the perfect cup

With a Sunbeam pump espresso machine and a little experience, you can create café-quality coffee at home. Here are a few helpful suggestions:

- A single shot of espresso should result in only 30-35mls of coffee.
- The grind of coffee is critical. Use a fine to medium grind for domestic espresso machines.
- A common mistake is running too much water through the ground coffee, resulting in a thin and bitter tasting espresso.
- Ensure your coffee grinds are 'tamped' evenly. 'Tamping' refers to the amount of pressure with which coffee grinds are packed into the filter.
- If your espresso pours too slowly, tamp the coffee grind more lightly, or try a coarser grind.
- If your espresso is thin and watery, tamp the coffee grinds harder, or try a finer grind.
- Always use cold milk and a clean stainless steel jug when steaming.
- Don't boil the milk when steaming. The ideal temperature is when the jug becomes too hot to touch.
- Always use the freshest beans or ground coffee available and store in an airtight container in a cool, dry, dark place.
- Whole bean coffee stays fresh longer than ground coffee.
- When grinding your own coffee, never grind more than you will use for immediate brewing. Once ground, the coffee will begin to lose its flavour.
- Although not recommended, if you need to keep coffee for extended periods of time, it's best to freeze the coffee. Although before use, ensure that the coffee has been allowed to thaw to room temperature.
- Keep your espresso machine clean and thoroughly rinsed. Run water through the brewing head and flush the steaming nozzle in fresh water after each use.
- Little things count – warming your cups, using filtered water and serving the coffee immediately after brewing do make a difference.

# Easy steps for frothing milk

Milk texturing is the steaming of milk to heat it and to create froth. Similar to making an espresso, perfecting the art of milk texturing takes time and practice.

- Attach the froth enhancing attachment to the end of the steam nozzle on your espresso machine. You can also choose to steam the milk without the attachment.
- Using fresh, cold milk, fill the stainless steel frothing jug to no more than  $\frac{1}{3}$  full.
- The amount of milk you steam should be adequate for the coffees you are preparing. Keep in mind that the volume of milk will increase or stretch during the texturing process.
- Before inserting the steam nozzle into the milk, activate the steam function to remove any condensed water. To do this, hold an empty glass or cloth under the steam nozzle and turn the operating dial to the steam position.
- Insert the steam nozzle into the frothing jug. Lower the jug so that the tip of the steam nozzle is just below the surface of the milk and place your hand on the side of the jug.
- Move the frothing jug so that the steam nozzle is to one side, this will create a whirlwind motion in the milk. As the steam heats the milk, the milk will begin to rise. Follow the level of the milk by lowering the jug, always keeping the tip of the steam nozzle just below the surface.
- Once the milk has stretched to double its original volume, lower the steam nozzle further into the milk and continue the whirlwind motion. This will give the milk a fine texture with no big bubbles.
- Cease steaming when the frothing jug becomes too hot to continue holding the palm of your hand against the side.
- Pour the textured milk into your espresso as soon as possible.



# Before using your Bar Espresso

Before using your Bar Espresso for the first time or if you have not used it for some time, rinse the machine by running water through without coffee in the filter holder, as follows:

**Note:** Throughout these instructions the numbers you see highlighted and in brackets refer back to the diagrams at the start of this instruction manual.

- Open the lid of the water reservoir **(1)** and fill with cold tap water **(2)**. Alternatively you can open the lid and remove the water reservoir using the handle **(3)**. Then fill with cold water **(4)**.
- Replace the water reservoir firmly into the unit **(5)** and close lid.
- Insert the power cord into a 230-240V AC power outlet and turn the power on. Start the unit **(6)**. The red 'Power' light and 'Warm Up' light will both illuminate.
- Place one of the filters in the filter handle **(7)**. Then position the filter handle on the machines brewing head.
- To ensure that the filter handle is in the correct position, turn the handle so it points to the left and place the filter handle flat against the brewing head **(8)**, then turn the handle towards the right **(9)**, as far as it can go **(10)**.

**Note:** Do not over tighten.

- Place a sufficiently large container under the brewing head **(10)**.
- As soon as the orange 'Warm Up' light goes off, turn the operating dial to the  setting **(11)** and allow all the water in the water reservoir to run through.
- If necessary, you may need to stop the operation by turning the operating dial to the  'off' position to empty the container, then resume the operation.

# Functions of your Bar Espresso

## 1. ESPRESSO FUNCTION

For best results, it is ideal to pre-heat your cups, filter handle and filter as follows:

- Insert the power cord into a 230-240V AC power outlet and turn the power on.
- Fill the water reservoir **(1) (2) (3) (4) (5)** with cold water and start the appliance **(6)**.
- Put the filter handle and an empty filter in place **(7) (8) (9)**, and place cups underneath the filter handle.
- When the machine is ready, the orange 'Warm Up' light goes off, turn the operating dial to ☕ setting **(11)**.
- When the cups are full of hot water, return the operating dial to the ○ 'off' position.

**Note:** Once the appliance has been on for a while, coffee cups can be warmed by placing them upside down on the cup warming plate **(12)**.

### Preparing an espresso:

- Insert the power cord into a 230-240V AC power outlet and turn the power on.
  - Fill the water reservoir **(1) (2) (3) (4) (5)** with cold water.
  - Start the unit **(6)**. The red 'Power' light and orange 'Warm Up' light will both illuminate.
  - Pre-heat your coffee cups by placing them upside down on the cup warming plate **(12)**.
  - Select the required filter **(7)** for 1 or 2 cups of coffee and place in the filter handle.
  - Using the measuring spoon supplied, place one or two measures of ground coffee into the filter **(13)**. With the other end of the measuring spoon, use the tamper to push (pack) down the coffee grinds **(14)**. Do not apply too much pressure.
- Important:** Be sure not to over-fill the filter with too much coffee, and wipe around the edge of the filter to remove any coffee grounds **(15)**.
- Place the filter handle on the machines brewing head. Position the handle so it points to the left, place the filter handle flat against the brewing head, then turn the handle towards the right **(16)** as far as it can go.
- Note:** Do not over tighten.
- Place 1 or 2 pre-heated cups below each of the holes in the filter holder.
  - When the Bar Espresso is at the correct temperature the orange 'Warm Up' light will go out, then turn the operating dial to the ☕ setting **(17)**. You will hear the machine making a pumping noise, this is normal.
  - Once the cup/s are filled to the desired level, turn the operating dial to the ○ 'off' position.
  - Remove the filter handle and the filter by turning the filter handle to the left.
  - To remove the used coffee grounds from the filter, push the filter lock forward over the edge of the filter, turn the filter handle upside down in a bin and gently tap out the coffee **(18)**.

- After each use of the espresso machine for best results when making consecutive cups of espresso we recommend that you flush a small amount of water through the machine. With the filter handle already removed from the brewing head, simply turn the operating dial to the setting and allow the water to run through until you have a consistent flow of water. This will wash out any old or used coffee grinds stuck to the underside of the brewing head and also helps ensure the correct water temperature for your next shot of espresso.
- Once the orange 'Warm Up' light goes out your machine is ready to make the next espresso.

**Note:** Do not leave the filter handle locked in position for extended periods, or when machine is not in use. This shortens the life of the brew head rubber seals.

## 2. STEAM FUNCTION

The froth enhancing attachment makes it easy to produce textured milk.

**Note:** We recommend that you make the espresso first, then steam the milk.

- Attach the froth enhancing attachment to the end of the steam nozzle (19). You may also choose to steam the milk without the attachment.

**Important:** For the froth enhancing attachment to work you must ensure that it is pushed firmly onto the steam nozzle.

- Fill the water reservoir (1) (2) (3) (4) (5) with cold water.
- Start the unit (6). The red 'Power' light and orange 'Warm Up' light will both illuminate.
- Swing the steam nozzle to the side of the machine.
- Pour cold milk into a stainless steel frothing jug to no more than  $\frac{1}{3}$  full.

**Note:** For best results we recommend to use refrigerated milk and a stainless steel jug that is well chilled.

- When the Bar Espresso is the right temperature the orange 'Warm Up' light will go out.
  - Before inserting the steam nozzle into the milk, activate the steam function to remove any condensed water. To do this, hold an empty glass or cloth under the steam nozzle and turn the operating dial to the setting (20).
  - Once only steam is coming out, quickly insert the steam nozzle into the frothing jug. Lower the jug so that the tip of the steam nozzle is just below the surface of the milk and place your hand on the side of the jug.
- Important:** Do not allow the tip of the nozzle to touch the bottom of the container because this could obstruct the passage of the steam.
- Move the frothing jug so that the steam nozzle is to one side, this will create a whirlwind motion to the milk. As the steam heats the milk, the milk will begin to rise. Follow the level of the milk by lowering the jug, always keeping the tip of the steam nozzle just below the surface.



## Functions of your Bar Espresso (continued)

- Cease steaming when the frothing jug becomes too hot to continue holding the palm of your hand against the side. Simply turn the operating dial to the  'off' position and remove the jug.

**Note:** Do not boil the milk.

### Cleaning the steam nozzle and froth attachment



You must clean the steam nozzle and froth attachment immediately after each use. Simply wipe the stainless steel steam nozzle clean with a damp cloth and place the froth attachment under warm running water to remove any excess milk. Also, briefly turn the operating dial to  setting to clear any remaining milk out of the steam nozzle.

**Caution:** Steam from the nozzle is extremely hot and there is danger of scalding.

### Hot water drinks

You are able to heat water for hot drinks such as tea or instant soups using the steam nozzle.

**Note:** Heating liquids is done with the steam nozzle only, so ensure that the froth attachment is not in place.

- Fill the water reservoir **(1) (2) (3) (4) (5)** with cold water.
  - Start the unit **(6)**. The red 'Power' light and orange 'Warm Up' light will both illuminate.
  - Remove the froth attachment from the steam nozzle **(21)** and swing the steam nozzle to the side of the machine.
  - When the Bar Espresso is the right temperature the orange 'Warm Up' light will go out.
  - Immerse the steam nozzle in the cup or container holding the liquid to be heated and turn the operating dial to the  setting **(22)**.
  - When the liquid is hot enough, turn the operating dial to  'off' position and remove the container or cup.
- Note:** It is normal for the orange 'Warm Up' light to turn on and off during heating of water.

# Care and Cleaning

The coffee making process involves extracting oils out of coffee grinds to make espresso coffee. Deposits of these oils build up over time and affect the taste of the coffee and operation of the espresso machine.

Regular cleaning to remove these oils is essential for espresso machines to keep operating effectively. Flushing water, through the brewing head and the steam nozzle, is the easiest way to keep your machine clean after making each coffee, and at the end of your coffee making session.

**Important:** Never wash your espresso machine accessories in the dishwasher.

## Drip tray

Remove the grid and drip tray at regular intervals to empty **(22)**, **(23)**. If the red floating level indicator appears through the grid, empty the drip tray immediately.

Clean the drip tray and its grid with water and a little non-abrasive washing up liquid, rinse and dry.

Over time it is normal for the inside of the drip tray to be stained by the oils in the coffee.

## The brewing head, filters & filter handle

The filter and filter handle should be washed after each use by rinsing them under warm water. Wash at regular intervals in warm soapy water using a mild detergent.

To clean the brewing head, flush water through and wipe the head and around the inside rim with a damp cloth.

To assist in keeping the filter and the brew head clean, at the end of each coffee making session we recommend you run the machine, with the filter in place, without coffee – using water only.

Should the holes in the filters become clogged with coffee granules use a fine bristled brush to remove them.

## Brew head rubber seal

This seal is located in the brewing head and creates a seal against the filter handle when making an espresso.

**Note:** When your Bar Espresso is not being used, we recommend that you do not leave the filter handle attached to the machine as this will reduce the life of the seal.

Over time this seal loses its elasticity and will require replacement – usually every 6-12 months. Signs that the seal is deteriorating are when: the filter handle rotates to the far right and feels loose, or steam escapes from around the brewing head during use.

## The cup warming plate and exterior

Wipe over the unit with a damp cloth and wipe dry. Do not use abrasives or metal scourers, as these will scratch the exterior surface.

## Steam nozzle and froth attachment

The steam nozzle and froth attachment needs to be cleaned each time you froth milk or heat any other liquid. To clean the steam nozzle, wipe with a damp cloth and for the froth attachment, simply rinse it under warm water.

On a monthly basis we recommend thoroughly cleaning the steam nozzle.

To do this soak the nozzle in water with the stainless frothing jug resting on the drip tray. Ensure that the water level in the jug is over the nozzle. Run steam through the nozzle for 30 seconds, then leave to soak overnight. In the morning poke a pin up the steam nozzle, then turn the machine on and run steam through the nozzle again for 30 seconds.

**Important:** Do not wash parts in the dishwasher. Do not immerse the unit in water.

# Descaling

After continued use, your espresso machine may develop a build-up of mineral deposits and oils. Thus your machine will require occasional 'descaling'.

We recommend that you descale your machine every 2-3 months, although this period will depend on the hardness of water and frequency of use of the machine.

## Descaling solution

Use Sunbeam Liquid Descaler, which is available at any Sunbeam Service Centre listed at the back of this book. Alternatively, dissolve 2 dessertspoons of tartaric acid (crème of tartar) or citric acid in half a litre of lukewarm water.

**Important:** Do not use vinegar.

## Descaling the espresso machine



**Note:** Ensure that the espresso machine is turned off and the power cord is unplugged.

1. Remove the water reservoir from the machine and if necessary empty any water.
2. Remove the drip tray and place it out of the way.
3. Remove the filter holder from the machine and rinse it thoroughly under running water and set aside.
4. Place a cloth/tea towel on the bench and carefully turn the machine upside down. The machine should now be on the warming plate resting on the cloth/tea towel.
5. Using a screwdriver, unscrew the brewing filter from the brewing head.
6. Remove and set aside the brew head rubber seal and screw in a safe place.  
**Important:** Be careful not to lose the brew head rubber seal and screw once you have removed them from the brewing filter.
7. Remove the filter from the centre hole using the tip of a fork or a skewer. Wash the filter and rubber seal in hot soapy water, rinse and dry well. Set aside in a safe place.
8. Using a small brush, scrub in and around the area of the brewing head, removing all coffee granules.
9. Remove the froth enhancing steam attachment, wash thoroughly under running water and set aside. Wipe down the steam nozzle with a small brush.
10. Turn the machine upright, so that it is now sitting correctly on the bench.
11. Place the water reservoir onto the machine and fill with the descaling solution.
12. Place a large container under the brewing head and another container under the steam nozzle.
13. Insert the power cord into a 230-240V AC power outlet and turn the power 'On'.
14. Turn the selector dial to the ☕ setting. Run through about  $\frac{1}{3}$  of the liquid immediately.
15. Once you have run through about  $\frac{1}{3}$  of the liquid turn the selector dial to the ☕ setting and allow the solution to come through the steam nozzle for 2 minutes.

## Descaling (continued)

16. After 2 minutes stop the machine by flicking the power switch on the machine to the 'Off' position. Now that the machine is off, turn the selector dial to the ☕ setting.
17. Leave the machine off for 10-15 minutes to allow the descaler to take affect.
18. Flick the power switch 'On' and allow  $\frac{1}{2}$  of the rest of the descaler solution to run through the brewing head, then turn the selector dial immediately to the ☕ setting. Steam for 3-4 minutes.
19. To finish, turn the selector dial to the ☕ setting and allow the remaining water in the reservoir to run through the brewing head.
20. Remove and empty the containers placed under the brewing head and steam nozzle. Once emptied, once again place one under the brewing head and the other under the steam nozzle.
21. Remove the water reservoir from the machine and rinse thoroughly under running water, ensuring that all traces of the descaling solution is removed. Fill the water reservoir with clean water and place onto the machine.
22. Run two (2) full water reservoirs through the brewing head. Refill the water reservoir and run the steam nozzle for 4-5 minutes.  
**Note:** Ensure that you continue to run water through the machine until the water runs clean and clear.
23. When this is finished, remove the water reservoir and set aside. Remove the water containers and give the machine a good wipe over.
24. Turn the machine upside down. The machine should now be on the warming plate resting on the cloth/tea towel once again.
25. Carefully replace the brew head rubber seal, filter and screw. Tighten well.
26. Turn the machine upright, so that it is now sitting correctly on the bench.
27. Replace the drip tray and froth enhancing steam attachment onto the steam nozzle.
28. Fill the water reservoir with water and position it on to the machine.

# Trouble Shooting Guide

Problem	Possible cause	What to do
Coffee runs down the side of the filter holder	Filter holder is not inserted correctly.	See "Preparing an espresso" pg 13.
	Edge of filter insert is not free of coffee granules.	Clean around the edge of the filter and wipe the brewing head clean of coffee.
	The brewing head is dirty.	Wipe brewing head with a damp cloth.
	The brewing head is defective.	Contact a Sunbeam Service Centre.
	Brew head rubber seal is damaged	Contact a Sunbeam Service Centre.
No coffee runs through.	No water in the water reservoir.	Fill reservoir with water.
	Water reservoir not correctly assembled.	Press firmly down on the water reservoir.
	Selector set to  setting.	Ensure the selector is in the  position.
	Brewing filter may be blocked.	See "Descaling the espresso machine" pg 17.
	The filter is blocked, the coffee grounds are too fine or tamped down too hard.	Empty out the filter and rinse under water to clean. Wipe the brewing head with a cloth. Repack the filter and tamp down coffee <u>lightly</u> with compactor.
Coffee filters out in drops.	Coffee grounds are too fine or are too compacted.	Ensure you are using an evenly ground coffee and do not compact the grounds so firmly.
	Machine blocked by scale build up.	See "Descaling the espresso machine" pg 17.
Espresso does not have any Crema.	Coffee is old or dry.	Use fresh coffee and once you open the coffee be sure to store it in an airtight container.
	Coffee not compacted firmly enough.	Compact coffee grounds more firmly.
	Coffee too coarse.	Grind the coffee to a finer texture or change brands of espresso coffee to a finer grind.
Handle comes off during brewing.	Coffee tamped too hard.	Tamp the coffee grinds lighter.
	Coffee grind is too fine.	Change to a coarser grind of coffee.

## Trouble Shooting Guide (continued)

<b>Problem</b>	<b>Possible cause</b>	<b>What to do</b>
Espresso does not have any Crema (con't).	Machine is too hot.	The temperature of the espresso machine increases for frothing milk or steaming liquids. To ensure you don't burn your coffee flush the machine after frothing milk. Simply turn the control dial to the ☕ position a couple of times to release the steam. Do this until you get a steady run of water.
Coffee is too cold.	Unit is not properly preheated.	Wait for the 'warm up' light to go out.
	Cups, filter and filter holder are cold.	Pre-heat cups, filter, handle and filter. See page 13
	If making a cappuccino or latte the milk may not be heated enough.	Ensure that milk is heated properly during frothing, but be sure not to boil the milk, See page 11.
No steam from the steam nozzle.	Steam nozzle is blocked.	Remove the froth attachment and clean under running water. Wipe steam nozzle clean with a damp cloth to remove any dried milk, you may need to unblock the steam hole with a needle. Set the machine to the ☕ setting and allow it to steam until a powerful and even jet of steam is generated. Soaking the steam nozzle in hot water, may also help to dislodge any dried milk.
Not enough froth when frothing milk.	Milk is not fresh.	Ensure the milk is fresh.
	Milk temperature is too warm.	Ensure that the milk is well refrigerated before use.
	Frothing jug.	For best frothing results use a stainless steel jug and if possible refrigerate or run the jug under cold water before use.
	Steam nozzle is blocked.	Clean the steam nozzle.
	Milk has been boiled.	Start again with fresh, chilled milk.

## Trouble Shooting Guide (continued)

<b>Problem</b>	<b>Possible cause</b>	<b>What to do</b>
Not enough froth when frothing milk (con't).	Type of milk.	Try skim milk or fat-reduced milk as these make frothing easier.
	The milk is making bubbles rather than frothing.	Ensure that the froth attachment is correctly positioned on the steam nozzle. The tip of the steam nozzle or frothing attachment is positioned just below the surface of the milk.
Uneven cup filling.	Filter holder is blocked.	Clean out the filter thoroughly by holding it under running water and dry OR Run water through the filter with no coffee.
Difficult to insert the filter holder.	Build up of coffee grinds on brewing head.	Wipe over brewing head area and filter holder with a damp cloth.
Espresso tastes burnt.	Type of coffee being use.	Experiment with different brands of coffee.
	Appliance has not been rinsed properly after descaling.	Run a reservoir full of water through the machine before making another coffee.
Pump makes an unusually loud noise.	No water in reservoir.	Fill the water reservoir.
	Water reservoir not correctly positioned.	Replace the water reservoir firmly into the unit.
	Coffee old or too dry, pump does not build up enough pressure.	Use freshly ground espresso coffee.
Espresso machine does not operate.	Brewing filter may be blocked.	Remove filter holder and clean brewing head.
	Machine blocked by scale build up.	See "Descaling the espresso machine" pg 17.

Please contact Sunbeam directly on Freecall 1800 025 059, if this guide does not solve your query. We have experienced staff on hand to assist, Monday to Friday.

# Recipes

## ESPRESSO (SHORT BLACK)

Espresso is a concentrated, full bodied coffee with a stable layer of cream on top – known as 'crema'. An espresso is the foundation of all café coffee. Variations are achieved by adding different amounts of milk and froth.

- 90mL espresso glass or demitasse cup
- single espresso (30-35mL)



## LONG BLACK

A standard espresso with hot water, served in a regular coffee cup or mug. The hot water is added first so that the 'crema' is maintained.

- 190mL cup
- hot water (to taste)
- single or double espresso



## MACCHIATO

Macchiato, Italian for 'to stain or mark'. Traditionally served as a standard espresso with a dash of milk and a small dollop of froth into the middle of the 'crema'.

- 90mL espresso glass or demitasse cup
- single or double espresso
- marked with steamed milk froth



## FLAT WHITE

Another old favourite, the Flat White is an espresso with steamed milk, served in a regular coffee cup or mug. The layer of frothed milk on top should be 2mm to seal the coffee.

- 190mL cup
- single or double espresso
- steamed milk





## Recipes (continued)

### CAFFE LATTE

An espresso with steamed milk, typically served in a glass. The layer of frothed milk on top should be 10mm to seal the coffee.

- 220mL glass or cup
- single or double espresso
- steamed milk



### CAPPUCCINO

This delicious drink is an espresso with steamed milk, topped with creamy froth and a dusting of chocolate. The resulting drink is approximately two-thirds milky coffee, one-third froth.

- 190-240mL cup
- single or double espresso
- two-thirds milky coffee, one-third froth
- dusted with chocolate



### CAFFE MOCHA

Made in a similar way to a cappuccino but with the addition of drinking chocolate.

Simply stir the chocolate into the espresso prior to adding the steamed milk and froth.

- 190-240mL cup or tall glass
- single or double espresso
- two teaspoons of drinking chocolate
- two-thirds milky coffee, one-third froth



### CON PANNA

A variation on the original Vienna coffee, this delicious drink is made up of an espresso topped with lightly whipped cream. It can also be dusted with cinnamon or drinking chocolate.

- 190mL cup
- single or double espresso
- lightly whipped cream
- dusted with cinnamon or chocolate



# Notes

'Sunbeam' & 'Bar Espresso' are registered trademarks of Sunbeam Corporation.

Made in China. Engineered in Australia. Due to minor changes in design or otherwise, the product may differ from the one shown in this leaflet. Backed by Sunbeam's 12 Month Replacement Guarantee and National Service Network.

© Copyright. **SUNBEAM CORPORATION LIMITED 2002.**

(INCORPORATED IN N.S.W.) A.C.N. 000 006 771

For more information or advice on this or any other Sunbeam appliance, visit [www.sunbeam.com.au](http://www.sunbeam.com.au) or contact the Sunbeam Consumer Service Line.

**Australia 1800 025 059**

**New Zealand (09) 912 0747.**



## Consumer Hotline

Australia

1800 025 059

New Zealand

(09) 912 0747

Consumer information:

1800 025 059 or [www.sunbeam.com.au](http://www.sunbeam.com.au)

 is a registered Trademark of Sunbeam Corporation Limited. ACN 000 006 771.

© Sunbeam Corporation Limited 2002.

## Free Manuals Download Website

<http://myh66.com>

<http://usermanuals.us>

<http://www.somanuals.com>

<http://www.4manuals.cc>

<http://www.manual-lib.com>

<http://www.404manual.com>

<http://www.luxmanual.com>

<http://aubethermostatmanual.com>

Golf course search by state

<http://golfingnear.com>

Email search by domain

<http://emailbydomain.com>

Auto manuals search

<http://auto.somanuals.com>

TV manuals search

<http://tv.somanuals.com>