

This warranty is valid only in the United States.

SONY®

Portable Memory Stick Audio Player/
Portable MiniDisc Recorder/
Portable CD Player/
Portable IC Audio Player/
Portable Hard Disk Audio Player

Portable Audio

LIMITED WARRANTY

Sony Electronics Inc. ("Sony") warrants this Product (including any accessories) against defects in material or workmanship as follows:

1. LABOR: For a period of 90 days from the date of purchase, if this Product is determined to be defective, Sony will repair or replace the Product, at its option, at no charge, or pay the labor charges to any Sony authorized service facility. After the Warranty Period, you must pay for all labor charges.

2. PARTS: In addition, Sony will supply, at no charge, new or rebuilt replacements in exchange for defective parts for a period of one (1) year. After 90 days from the date of purchase, labor for removal and installation is available from Sony authorized service facilities or a Sony Service Center at your expense.

To obtain warranty service, you must take the Product, or deliver the Product freight prepaid, in either its original packaging or packaging affording an equal degree of protection, to any authorized Sony service facility.

This warranty does not cover customer instruction, installation, set up adjustments or signal reception problems.

This warranty does not cover cosmetic damage or damage due to acts of God, accident, misuse, abuse, negligence, commercial use, or modification of, or to any part of the Product, including the antenna. This warranty does not cover damage due to improper operation or maintenance, connection to improper voltage supply, or attempted repair by anyone other than a facility authorized by Sony to service the Product. This warranty does not cover Products sold AS IS or WITH ALL FAULTS, or consumables (such as fuses or batteries). This warranty is valid only in the United States.

Proof of purchase in the form of a bill of sale or receipted invoice which is evidence that the unit is within the Warranty period must be presented to obtain warranty service.

This warranty is invalid if the factory applied serial number has been altered or removed from the Product.

REPAIR OR REPLACEMENT AS PROVIDED UNDER THIS WARRANTY IS THE EXCLUSIVE REMEDY OF THE CONSUMER. SONY SHALL NOT BE LIABLE FOR ANY INCIDENTAL OR CONSEQUENTIAL DAMAGES FOR BREACH OF ANY EXPRESS OR IMPLIED WARRANTY ON THIS PRODUCT, EXCEPT TO THE EXTENT PROHIBITED BY APPLICABLE LAW. ANY IMPLIED WARRANTY OF MERCHANTABILITY OR FITNESS FOR A PARTICULAR PURPOSE ON THIS PRODUCT IS LIMITED IN DURATION TO THE DURATION OF THIS WARRANTY.

Some states do not allow the exclusion or limitation of incidental or consequential damages, or allow limitations on how long an implied warranty lasts, so the above limitations or exclusions may not apply to you. In addition, if you enter into a service contract with the Sony Partnership within 90 days of the date of sale, the limitation on how long an implied warranty lasts does not apply to you. This warranty gives you specific legal rights, and you may have other rights which vary from state to state.

For your convenience, Sony Electronics Inc. has established telephone numbers for frequently asked questions:

To locate the servicer or dealer nearest you, or for service assistance or resolution of a service problem, or for product information or operation, contact:

www.sony.com/walkmansupport

Sony Network Portable Audio Support Line
1-866-456-7669

For an accessory or part not available from your authorized dealer, call:

1-800-488-SONY (7669)

D 324343304



Printed on 100% recycled paper.



* 2 5 8 8 6 0 1 1 1 * (1)

<http://www.sony.net/>

Printed in Malaysia

SONY®

SONY

Portable MD Recorder MZ-RH10

2-588-601-11(1)

Operating Instructions

MZ-RH10

Recorder Operation **page 12**

Software Operation **page 90**

Hi-MD Walkman

Portable

MD Recorder



Hi-MD
AUDIO



"WALKMAN" is a registered trademark of Sony Corporation to represent Headphone Stereo products.
WALKMAN is a trademark of Sony Corporation.



WARNING

To prevent fire or shock hazard, do not expose the unit to rain or moisture.

Do not install the appliance in a confined space, such as a bookcase or built-in cabinet.

To prevent fire, do not cover the ventilation of the apparatus with news papers, table cloths, curtains, etc. And don't place lighted candles on the apparatus.

To prevent fire or shock hazard, do not place objects filled with liquids, such as vases, on the apparatus.

Certain countries may regulate disposal of the battery used to power this product. Please consult with your local authority.

Caution

The use of optical instruments with this product will increase eye hazard.

CAUTION — INVISIBLE LASER RADIATION WHEN OPEN

AVOID EXPOSURE TO BEAM

CAUTION — CLASS 1M INVISIBLE LASER RADIATION WHEN OPEN

DO NOT VIEW DIRECTLY WITH OPTICAL INSTRUMENTS

Information

IN NO EVENT SHALL SELLER BE LIABLE FOR ANY DIRECT, INCIDENTAL OR CONSEQUENTIAL DAMAGES OF ANY NATURE, OR LOSSES OR EXPENSES RESULTING FROM ANY DEFECTIVE PRODUCT OR THE USE OF ANY PRODUCT.

For customers who purchased this product in the USA

Owner's Record

The serial number is located at the rear of the disc compartment lid and the model number is located at the top and bottom. Record the serial number in the space provided below. Refer to them whenever you call upon your Sony dealer regarding this product.

Model No. MZ-RH10

Serial No. _____

Product registration

Please register this product on line at www.sony.com/walkmanreg
<<http://www.sony.com/walkmanreg>>

Proper registration will enable us to send you periodic mailings about software upgrades, new products, services and other important announcements. Thank you.

If you have any questions about this product, contact:

- <http://www.sony.com/walkmansupport>
- Sony Network Portable Audio Support Line
1-(866)-456-7669
- Sony Customer Information Services Center
12451 Gateway Blvd. Fort Myers, FL 33913

Declaration of Conformity

Trade Name: SONY
Model No.: MZ-RH10
Responsible Party: Sony Electronics Inc.
Address: 16450 W. Bernardo Dr, San Diego, CA 92127 USA
Telephone No.: 858-942-2230

This device complies with Part 15 of the FCC Rules. Operation is subject to the following two conditions: (1) This device may not cause harmful interference, and (2) this device must accept any interference received, including interference that may cause undesired operation.

This equipment has been tested and found to comply with the limits for a Class B digital device, pursuant to Part 15 of the FCC Rules. These limits are designed to provide reasonable protection against harmful interference in a residential installation. This equipment generates, uses, and can radiate radio frequency energy and, if not installed and used in accordance with the instructions, may cause harmful interference to radio communications. However, there is no guarantee that interference will not occur in a particular installation. If this equipment does cause harmful interference to radio or television reception, which can be determined by turning the equipment off and on, the user is encouraged to try to correct the interference by one or more of the following measures:

- Reorient or relocate the receiving antenna.
- Increase the separation between the equipment and receiver.
- Connect the equipment into an outlet on a circuit different from that to which the receiver is connected.

— Consult the dealer or an experienced radio/TV technician for help.

You are cautioned that any changes or modifications not expressly approved in this manual could void your authority to operate this equipment.

For customers in the USA and Canada only

RECYCLING NICKEL METAL HYDRIDE BATTERIES

Nickel Metal Hydride batteries are recyclable.

You can help preserve our environment by returning your used rechargeable batteries to the collection and recycling location nearest you.



For more information regarding recycling of rechargeable batteries, call toll free 1-800-822-8837 or visit <http://www.rbrc.org/>

Caution: Do not handle damaged or leaking Nickel Metal Hydride batteries.

The validity of the CE marking is restricted to only those countries where it is legally enforced, mainly in the countries EEA (European Economic Area).

Disposal of Old Electrical & Electronic Equipment (Applicable in the European Union and other European countries with separate collection systems)



This symbol on the product or on its packaging indicates that this product shall not be treated as household waste. Instead it shall be handed over to the applicable collection point for the recycling of electrical and electronic equipment. By ensuring this product is disposed of correctly, you will help prevent potential negative consequences for the environment and human health, which could otherwise be caused by inappropriate waste handling of this product. The recycling of materials will help to conserve natural resources. For more detailed information about recycling of this product, please contact your local city office, your household waste disposal service or the shop where you purchased the product.

Applicable accessories: Remote control, Earphones

Notice for users

On the supplied software

- Copyright laws prohibit reproducing the software or the manual accompanying it in whole or in part, or renting the software without the permission of the copyright holder.
- In no event will SONY be liable for any financial damage, or loss of profits, including claims made by third parties, arising out of the use of the software supplied with this recorder.
- In the event a problem occurs with this software as a result of defective manufacturing, SONY will replace it. However, SONY bears no other responsibility.
- The software provided with this recorder cannot be used with equipment other than that which is so designated.
- Please note that, due to continued efforts to improve quality, the software specifications may be changed without notice.
- Operation of this recorder with software other than that provided is not covered by the warranty.
- The ability to display the languages on the software will depend on the installed OS on your PC. For better results, please ensure that the installed OS is compatible with the desired language you want to display.
 - We do not guarantee all the languages will be able to be displayed properly on the software.
 - User-created characters and some special characters may not be displayed.
- Depending on the type of the text and characters, the text shown on the software may not be displayed properly on the device. This is due to:
 - The capability of the connected device.
 - The device is not functioning normally.

- SonicStage and SonicStage logo are trademarks or registered trademarks of Sony Corporation.
- MD Simple Burner, OpenMG, “Magic Gate”, “MagicGate Memory Stick”, “Memory Stick”, Hi-MD, Net MD, ATRAC, ATRAC3, ATRAC3plus and their logos are trademarks of Sony Corporation.
- Microsoft, Windows, Windows NT and Windows Media are trademarks or registered trademarks of Microsoft Corporation in the United States and /or other countries.
- IBM and PC/AT are registered trademarks of International Business Machines Corporation.
- Macintosh is a trademark of Apple Computer, Inc. in the United States and/ or other countries.
- Pentium is a trademark or a registered trademark of Intel Corporation.
- All other trademarks and registered trademarks are trademarks or registered trademarks of their respective holders.
- ™ and ® marks are omitted in this manual.
- CD and music-related data from Gracenote, Inc., copyright © 2000-2004 Gracenote. Gracenote CDDDB® Client Software, copyright 2000-2004 Gracenote. This product and service may practice one or more of the following U.S. Patents: #5,987,525; #6,061,680; #6,154,773, #6,161,132, #6,230,192, #6,230,207, #6,240,459, #6,330,593, and other patents issued or pending. Services supplied and/or device manufactured under license for following Open Globe, Inc. United States Patent 6,304,523. Gracenote is a registered trademarks of Gracenote. The Gracenote logo and logotype, and the “Powered by Gracenote” logo are trademarks of Gracenote.

Program © 2001, 2002, 2003, 2004, 2005
Sony Corporation

Documentation © 2005 Sony Corporation

Table of contents

About available functions and supplied manuals	10
---	-----------

Recorder Operation

Looking at controls	14
----------------------------------	-----------

Getting started	17
------------------------------	-----------

Recording a disc right away!	21
---	-----------

Playing a disc right away!	25
---	-----------

Using menus	27
--------------------------	-----------

How to use the menu items	27
---------------------------------	----

List of menus	28
---------------------	----

Various ways of recording	30
--	-----------

Before recording	30
------------------------	----

Viewing various information	31
-----------------------------------	----

Recording from a microphone	32
-----------------------------------	----

Recording from a TV or radio (Analog Recording)	34
---	----

Selecting the recording mode	34
------------------------------------	----

Adjusting the recording level manually	35
--	----

Adding track marks while recording	36
--	----

Recording without creating a new group	37
--	----

To start/stop recording in sync with the sound source (Synchro-recording)	38
--	----

Various ways of playback	39
---------------------------------------	-----------

Viewing various information	39
-----------------------------------	----

Selecting the play mode	40
-------------------------------	----

Searching for a track (Search)	43
--------------------------------------	----

Selecting the sound quality (6-Band Equalizer)	44
--	----

Editing recorded tracks	46
Before editing	46
Adding titles (Title Input)	46
Assigning tracks or groups as a new group (Group Set)	49
Releasing a group setting (Group Release)	50
Moving recorded tracks or groups (Move)	51
Erasing tracks and the entire disc (Erase)	52
Dividing a track (Divide)	54
Combining tracks (Combine)	55
Formatting the disc (Format)	56

Other operations	57
Changing the displayed menu items (Menu Mode)	57
Protecting your hearing (AVLS)	57
Turning off the beep sound	57
Preserving battery power (EL Light)	58
Storing the settings for individual discs (Disc Memory)	58
Starting the playback quickly (Quick Mode)	59
Selecting the disc mode (Disc Mode)	60
Changing the operational direction of the display	60
Selecting the display language	61

Using the recorder with a computer	62
What you can do through connection with a computer	62
Connecting the recorder to your computer	63
Storing non-audio data to a disc	64
Viewing non-audio data stored on the disc in the display window of the recorder (File List)	65

Additional information	67
Precautions	67
Specifications	69

Troubleshooting and explanations	71
Troubleshooting	71
Messages	79
Explanations	84

Software Operation

What you can do with SonicStage/MD Simple Burner	90
---	-----------

Installing	92
Providing the required system environment	92
Installing the software onto your computer	93

Using SonicStage	95
Importing audio data	95
Transferring audio data from your computer to the MD Walkman	97
Transferring back audio data from the MD Walkman to your computer ...	99
Writing audio data to a CD-R/CD-RW disc	102
Using SonicStage Help	104
Referring to SonicStage Help	106

Using MD Simple Burner	108
Before using MD Simple Burner	108
Recording using MD Walkman operations (Simple mode)	109
Recording by computer operations (Standard mode)	110

Other information	112
Uninstalling SonicStage/MD Simple Burner	112
On copyright protection	113
Troubleshooting	114

Index	117
-------------	-----

About available functions and supplied manuals

This section explains the functions of this portable MiniDisc recorder and the manuals that have been supplied with it. Please refer to the manual that applies to each use of the recorder.

Learning more about Hi-MD

“Hi-MD” is a new MiniDisc format with advanced capabilities over the standard MD format.



The “What you can do with the Hi-MD Walkman” flyer

This flyer explains the major features of Hi-MD Walkman and how it differs with standard MD Walkman.

Using the recorder

You can enjoy recording from a CD player or a microphone, then enjoy listening to the recordings that you made.

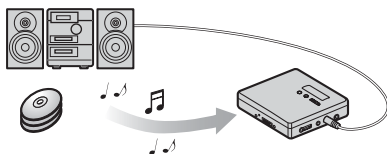

Recorder Operation (pages 12 to 88)

This section explains all of the recorder functions. It also gives details on the problems you may encounter while using the recorder and how to solve them, and about what to do when a message appears in the display.

→ **When you encounter any problems or need more explanation**
Refer to “Troubleshooting and explanations” (page 71).

Using the recorder while it is connected to a computer

The supplied SonicStage software allows you to transfer audio data between the recorder and the computer.

The supplied MD Simple Burner software allows you to record audio data to the recorder.

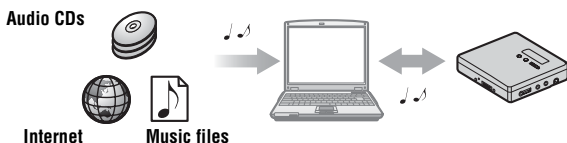

Software Operation (pages 90 to 116)

This section explains the installation and basic operations of the supplied SonicStage/MD Simple Burner software.

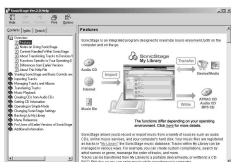

SonicStage Help

This is an online help that you can view on your computer screen.

Online help explains the detailed operations and information about SonicStage software. You can also refer to online help if you encounter any problems while using the SonicStage.

Notes on the “Software Operation” section

- In Software Operations section, “Net MD” refers to the recorder with standard disc inserted and “Hi-MD” refers to the recorder with a Hi-MD disc or a standard disc in Hi-MD mode inserted.
- The displayed items in the illustrations that appear in this section may differ from the actual items displayed by the software.
- Explanations in this section assume familiarity with basic Windows operations. For details on the use of your computer and the operating system, please refer to the respective manuals.
- Explanations in this section cover general Hi-MD/Net MD products. For this reason, some explanations (and some illustrations) may not be applicable to your Hi-MD/Net MD. Please refer to the operating instructions of your Hi-MD/Net MD as well.

Checking the supplied accessories

AC power adaptor (1)



Remote control (1)

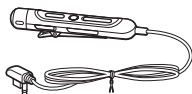

Comes attached with a clamp filter on the cord of the North American and Chinese models.

Earphones (1)



Dedicated USB cable (1)

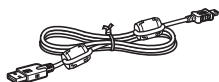

Clamp filters are not attached to the cord for the Southeast Asian, African and tourist models.

NH-14WM Nickel metal hydride rechargeable battery (1)



Battery carrying case (1)

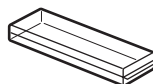

Dry battery case (1)

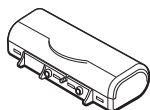

Optical cable (except for the North American model) (1)

Clamp filters (small-size)

- for the North American and Chinese models (2)
- for the European, Australian, Hong Kong and Korean models (3)

CD-ROM (SonicStage/MD Simple Burner) (1)*

Carrying pouch (1)

* Do not play a CD-ROM on an audio CD player.

Note

When using this unit, remember to follow the precautions below in order to avoid warping the cabinet or causing the unit to malfunction.

- Make sure not to sit down with the unit in your back pocket.
- Make sure not to put the unit into a bag with the remote control or the earphones cord wrapped around it and then subject the bag to strong impact.

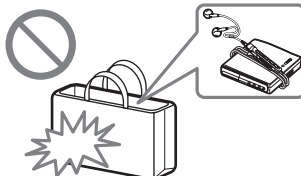

How to use the supplied clamp filters

When using the recorder connected to the computer, make sure to attach the clamp filters in the way described. (You must attach a clamp filter to comply with the applicable EMC standards.) It is unnecessary to attach the clamp filters if you use the unit without connecting it to the computer.



- For the supplied remote control: small-size clamp filter/ESD-SR-110 (for the European, Australian, Hong Kong and Korean models)



- For the optional stereo microphone (ECM-MS907/ECM-MS957): small-size clamp filter/ESD-SR-110 (except for the Southeast Asian, African and tourist models)



- For the optional line cable (RK-G129/RK-G136): small-size clamp filter/ESD-SR-110 (except for the Southeast Asian, African and tourist models)

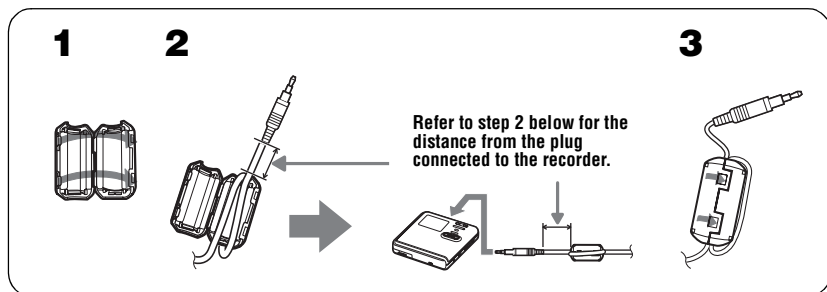

1 Open the clamp filter.

2 Attach the clamp filters as follows.

For the supplied remote control: Wind the cord around the clamp filter once/Approx. 4 cm (1.6 in.) from the plug

For the optional stereo microphone: Wind the cord around the clamp filter once/Approx. 4 cm (1.6 in.) from the plug

For the optional line cable: Pass the cord through the clamp filter/Approx. 1 cm (0.4 in.) from the plug

3 Close the clamp filter. Make sure the clasps are fully engaged.

Looking at controls

The recorder

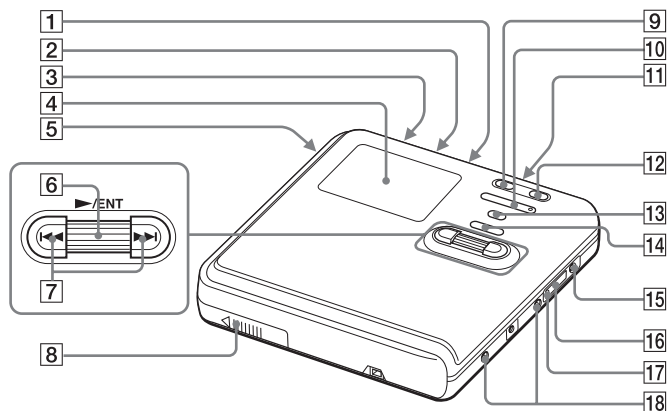

1 MIC (PLUG IN POWER) jack¹⁾

2 LINE IN (OPT) jack

3 HOLD switch

Slide the switch in the direction of the arrow to disable the buttons on the recorder. To prevent the buttons from being accidentally operated when you carry the recorder, use this function.

4 Display window

5 OPEN switch

6 Jog dial (▶) (play)/ENT)

7 ◀◀ (AMS, fast rewind), ▶▶ (AMS, fast forward) button

8 Battery compartment

9 || (pause) button

10 VOL (volume) +¹⁾, - button

11 🎧 (earphones) jack

12 REC(+▶)/T MARK button

13 •SEARCH/•LIGHT/ ●MENU button²⁾

14 ■ (stop) • CANCEL/CHG button

15 DC IN 3V jack

16 🔄 USB cable connecting jack

17 The cover of the 🔄 USB cable connecting jack

18 Terminals for attaching dry battery case

¹⁾ There are tactile dots beside the VOL + button and the MIC (PLUG IN POWER) jack.

²⁾ • indicates a function that requires a slight press of the button. ● indicates a function that requires pressing the button for 2 seconds or more.

The display window of the recorder

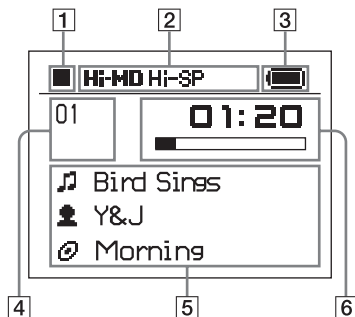

- 1** Operating condition indication display area
Displays the indications of each operating condition.
■: stop
▶: play
||: pause
◀◀: fast rewind
▶▶: fast forward
◀◀, ▶▶: AMS
REC: record/record pause
- 2** Selected operating condition display area
Displays the operating mode, play mode, or selected menu item, etc.
- 3** Battery indication
Shows the approximate remaining battery power. If the batteries are weak, the indication becomes empty and starts flashing.
- 4** Track number and group number display area
Displays the track number or group number.
- 5** Text information display area
Displays titles, menu items, error messages, etc. Titles are preceded by the following icons.
♪: track name
👤: artist name*
📀: album name*
📁: group name
📀: disc name
* Appears only for discs used in Hi-MD mode.
- 6** Time display area
Displays the elapsed time, remaining time of the track or disc, etc.

The earphones with a remote control

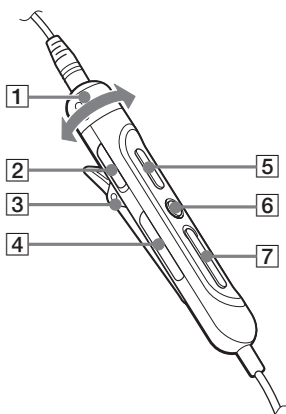



1 VOL (volume) +, – control

2 HOLD switch



Slide the switch in the direction of the arrow to disable the buttons on the remote control. To prevent the buttons from being accidentally operated when you carry the recorder, use this function.

3 Clip

4  (group) +, – button

5  (play, pause) button

6  (stop) button

7  (AMS, fast rewind),  (AMS, fast forward) button

Getting started

Charge the rechargeable battery before using.

1 Insert the rechargeable battery.

- 1 Slide OPEN to open the battery compartment lid.
- 2 Insert the NH-14WM rechargeable battery \ominus end first.
- 3 Close the lid.

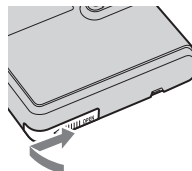
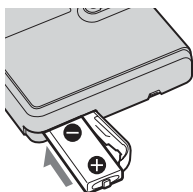
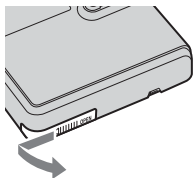

2 Charging the rechargeable battery.

- 1 Connect the AC power adaptor to DC IN 3V on the recorder and the AC power adaptor to a wall outlet.
- 2 Press \blacksquare CANCEL/CHG.
“Charging” appears in the display, and charging starts. When charging is completed, “Charging” disappears.

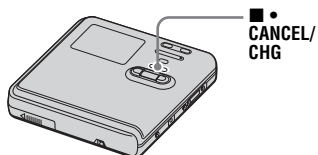
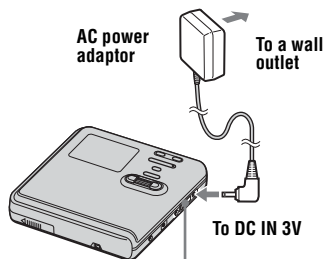

continued



- If the display disappears after a short time, the rechargeable battery is sufficiently charged.
- If the rechargeable battery is completely drained at the start of charging, it will take about 3.5 hours for the rechargeable battery become sufficiently charged. The charging time may vary, depending on the condition of the rechargeable battery.

Using the alkaline dry battery for extended operation

1 Attach the dry battery case to the recorder.

Rear of the recorder

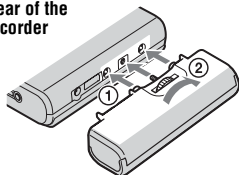

2 Insert a LR6 (size AA) alkaline dry battery. Inset the battery  end first.

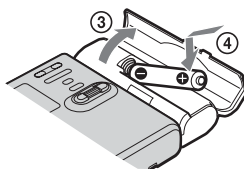

3 Make connections.

Connect the earphones with the remote control to .

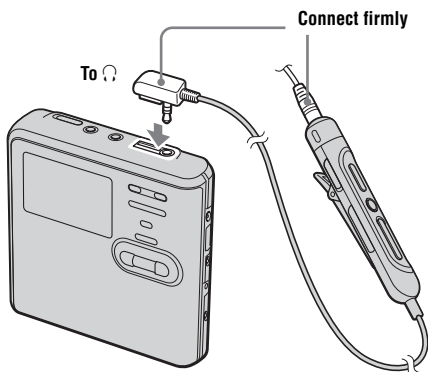

4 Unlock the control.

Slide HOLD to the opposite direction of the arrow (➡) on the recorder or the remote control to unlock the controls.

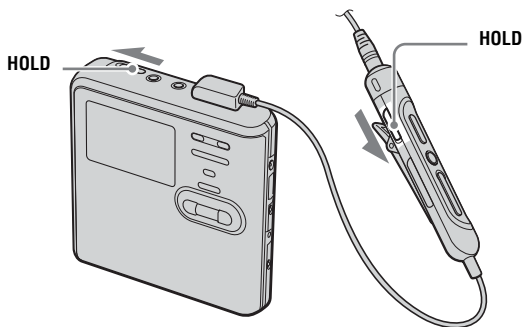

For models supplied with the AC plug adaptor



If the AC power adaptor does not fit the wall outlet, use the AC plug adaptor.

Notes

- When the rechargeable battery is being charged, the charging will stop when you operate the recorder.
- Because of the battery's characteristics, the capacity of the rechargeable battery may be smaller than normal when it is used for the first time or after a long period of disuse. In this case, charge and discharge the battery several times. The normal battery life will be restored.
- It is preferable to use the recorder on house current when recording or editing. When powering the recorder with batteries, make sure to use a fully charged rechargeable battery or a new alkaline dry battery.
- When operating the recorder with a dry battery, make sure it is an alkaline type. Use of another type may result in shorter battery life or cause a deterioration in the performance of the rechargeable battery being used in conjunction with the dry battery.

When to charge the rechargeable battery or replace the dry battery

You can check the battery condition on the display window of the recorder.

-  Battery power decreasing
-  Weak battery
-  The battery is drained. "LOW BATTERY" flashes in the display and the power goes off.

The battery level indicator is approximate. It may be more or less than the indication depending on the operating condition or the operating environment.

Battery life¹⁾

When recording continuously in Hi-MD mode

(Unit: approx.hours)(JEITA²⁾)

Disc type	Batteries	Linear PCM	Hi-SP	Hi-LP
1GB Hi-MD disc	NH-14WM ³⁾	5.5	7.5	8.5
	LR6 ⁴⁾	2	3	3
	NH-14WM + LR6	8	11.5	12.5
60/74/80-minute standard disc	NH-14WM	5	7.5	8.5
	LR6	4	6	6.5
	NH-14WM + LR6	9.5	14.5	16.5

¹⁾ Measured with "EL Light" is set to "Auto Off" (page 58).

²⁾ Measured in accordance with the JEITA (Japan Electronics and Information Technology Industries Association) standard.

³⁾ When using a 100% fully charged nickel metal hydride rechargeable battery

⁴⁾ When using a Sony LR6 (size AA) alkaline dry battery (produced in Japan)

When playing continuously in Hi-MD mode

(Unit: approx.hours)(JEITA)

Disc type	Batteries	Linear PCM	Hi-SP	Hi-LP	MP3 ¹⁾
1GB Hi-MD disc	NH-14WM	9	12.5	14.5	13
	LR6	9.5	13.5	15.5	14.5
	NH-14WM + LR6	20	28.5	33	30
60/74/80-minute standard disc	NH-14WM	7.5	12	15	13.5
	LR6	8	13	16	14.5
	NH-14WM + LR6	17	27.5	34	30.5

¹⁾ Tracks transferred at 128 kbps

When playing continuously in MD mode

(Unit: approx.hours)(JEITA)

Disc type	Batteries	SP	LP2	LP4
60/74/80-minute standard disc	NH-14WM	13.5	15	15.5
	LR6	16	17.5	18.5
	NH-14WM + LR6	32	35.5	37

Notes

- Stop the recorder before replacing the battery.
- When using a 1GB Hi-MD disc, the continuous recording time may be shortened if you repeatedly make short recordings.

Recording a disc right away!

This section explains the basic procedure for making digital recordings using an optical cable connected to a CD player, Digital TV or other digital equipment. Make sure to use the optical cable.

Note

Recording cannot be done in MD mode when you record directly with this recorder without using a computer. You can record in Hi-MD mode on this recorder.

1 Make connections. (Insert the cables firmly and completely into the appropriate jacks.)

- ① Connect the AC power adaptor to the recorder and a house current.

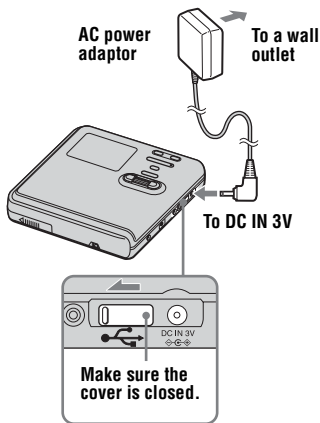

- ② Connect the optical cable to the recorder and an external component.

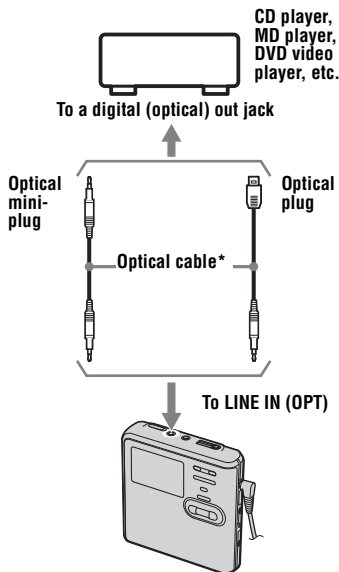

* See "Optional accessories" (page 70).

continued

2 Insert a recordable disc.

1 Slide OPEN to open the lid.

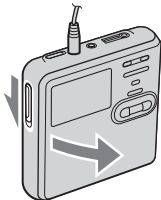

2 Insert a disc with the label side facing front, and press the lid down to close.

Make sure to check the record-protect tab is closed.

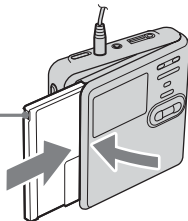

3 Confirm the operation mode.

This recorder has two operation modes, “Hi-MD mode” and “MD mode”. The operation mode is automatically recognized whenever the disc is inserted. After you insert a disc, check the operation mode on the display window of the recorder.

You can record on this recorder only in “Hi-MD mode”. It is not possible to record in “MD mode”. If you want to record in “MD mode”, for example to allow the disc to be played on another component that does not support Hi-MD, connect the recorder to a computer and use the supplied software to record in MD mode (refer to the “Software Operation” section).

“Hi-MD” lights up when the operation mode is Hi-MD and
“MD” lights up when the operation mode is MD.

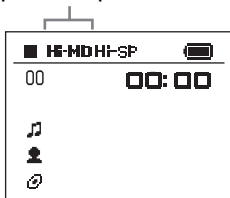

- When using a 1GB Hi-MD disc, the operation mode will only be Hi-MD.
- When using a standard disc (60/74/80 minutes), the operation mode can be set as follows.

Disc condition	Operation mode
Blank disc	The mode set for the “Disc Mode” in the menu. ¹⁾ ➔ When recording on this recorder, set “Disc Mode” to “Hi-MD” so that the operation mode will be “Hi-MD mode”.
The disc contains material recorded in Hi-MD mode	Hi-MD
The disc contains material recorded in MD mode	MD ➔ You cannot use this recorder to record in MD mode. Recording in “MD mode” is possible if you use the supplied software.

¹⁾ Refer to “Selecting the disc mode (Disc Mode)” (page 60) for the “Disc Mode” setting.

4 Record a disc.

- 1 Select and pause the sound source to be recorded.

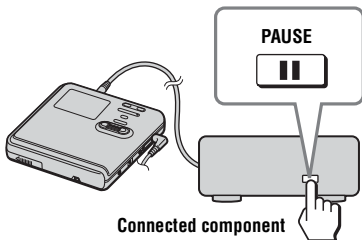

- 2 Make sure that the ■ indication appears in the display window.

Make sure the ■ indication is displayed.

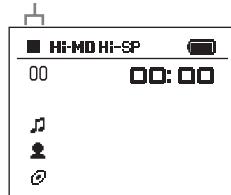

- 3 While the recorder is stopped, press the jog dial (▶/ENT) while pressing REC(+▶)/T MARK.

“REC” lights up and recording starts.

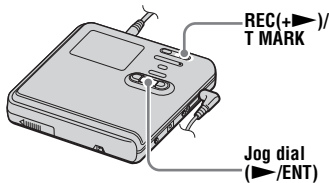

- 4 Play the source you want to record.

If you insert a previously recorded disc, the recording starts after the existing contents.



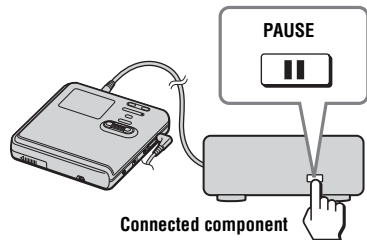

Track marks are automatically added at the same point as the sound source, and the contents are recorded together as a group.



To	Press
Stop	Press ■.
Pause	Press ■ ¹⁾ . Press ■ again to resume recording.
Remove the disc	Press ■ and open the lid. (The lid does not open while “SYSTEM FILE WRITING” is displayed.)

¹⁾ A track mark is added at the point where you press ■ again to resume recording while pausing; thus the remainder of the track will be counted as a new track.

Notes

- When you record on a 1GB Hi-MD disc, connect the AC power adaptor to the recorder, charge the rechargeable battery fully (battery level indication shows ) , or use a new alkaline dry battery (battery level indication shows ). When you attempt to start recording on a 1GB Hi-MD disc, “NOT ENOUGH POWER TO REC” may appear and recording cannot be done even if the battery level indication shows sufficient remaining power while the recorder is stopped or playing. This is because of a mechanism that disables recording when the remaining battery power is estimated by the recorder to be insufficient due to the high power consumption required for 1GB Hi-MD disc recording.
- Make sure to place the recorder at a stable, vibration-free place during recording.
- If you start recording before the  indication appears in the display, the first few seconds of the material may not be recorded. Make sure the  indication is displayed before you start recording.
- Do not move or jog the recorder or disconnect the power source while recording, or while “DATA SAVE” or “SYSTEM FILE WRITING” is displayed. If you do, the data recorded up to that point may not be recorded to the disc, or data on the disc may be damaged.
- Recording cannot be done when the disc does not have enough space for recording.
- If the power supply is disrupted (i.e. the battery is removed or becomes exhausted or the AC power adaptor is disconnected) during a recording or editing operation, or while “DATA SAVE” or “SYSTEM FILE WRITING” is displayed, then it will not be possible to open the lid until power is restored.



- The recorder is factory set to make a new group whenever recording is done. If you do not want to make a group, set “Group REC” to “Off” (page 37).
- To start recording from a specific point on the disc, pause the recorder at the desired point, and then start recording from that point.
- You can monitor the sound during recording. Changing the volume level will not affect the recording level.

Playing a disc right away!

1 Insert a recorded disc.

1 Slide OPEN to open the lid.

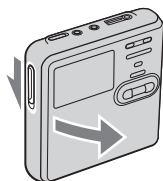

2 Insert a disc with the label side facing front, and press the lid down to close.

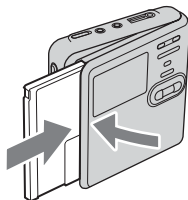

2 Play a disc.

1 Press the jog dial (▶/ENT) on the recorder.

Press ▶|| on the remote control.

2 Press VOL + or - to adjust the volume on the recorder.

Turn the VOL +, - control on the remote control.

The volume will be shown in the display.

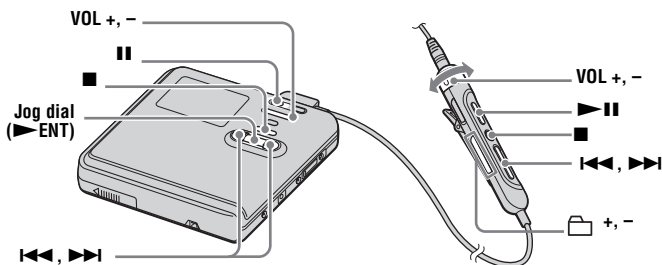

To stop play, press ■.

Playback starts from the point you last stopped playing. After you stop the recorder, the recorder will automatically turn off in about 10 seconds (when using batteries) or about 3 minutes (when using an AC power adaptor).

To	Operation on the recorder	Operation on the remote control
Stop	Press ■.	Press ■.
Pause	Press ■■. Press ■■ again to resume play.	Press ►■■. Press ►■■ again to resume play.
Select a track directly viewing track number or name	Turn the jog dial to select a track, and then press the jog dial (►/ENT) to enter.	—
Find the beginning of the current track or the previous track	Press ◀◀◀. Press ◀◀◀ repeatedly until you reach the beginning of the desired track.	Press ◀◀◀. Press ◀◀◀ repeatedly until you reach the beginning of the desired track.
Find the beginning of the next track	Press ▶▶▶.	Press ▶▶▶.
Go backwards or forward	Press and hold ◀◀◀ or ▶▶▶.	Press and hold ◀◀◀ or ▶▶▶.
Cue to the next or previous group while playing a track in a group (Group skip) ¹⁾	—	Press ◻ + or -.
Start with the first track of the disc	While the recorder is stopped, press the jog dial (►/ENT) for 2 seconds or more.	While the recorder is stopped, press ►■■ for 2 seconds or more.
Remove the disc	Press ■ and open the lid. ²⁾	Press ■ and open the lid. ²⁾

¹⁾ Cues to the beginning of every 10th track during playback of the disc with no group settings or during Bookmark play.

²⁾ Once you open the lid, the point to start play will change to the beginning of the first track.

Note

The playback sound may skip if:

- the recorder is subject to strong, repeated shocks.
- a dirty or scratched disc is played.

When using a disc in Hi-MD mode, sound may drop out for a maximum of about 12 seconds.

How to use the menu items

The recorder has many menus with useful functions for recording, playback, editing, etc. To set the menu items, do the following procedure.

If you are doing a menu operation for the first time after purchasing the recorder, “Menu Mode” appears in the display. Before the menu operation, you can set “Menu Mode” to “Advanced” (all menu items appear) or “Simple” (only basic menu items appear). Refer to “Changing the displayed menu items (Menu Mode)” (page 57) for menu mode setting.

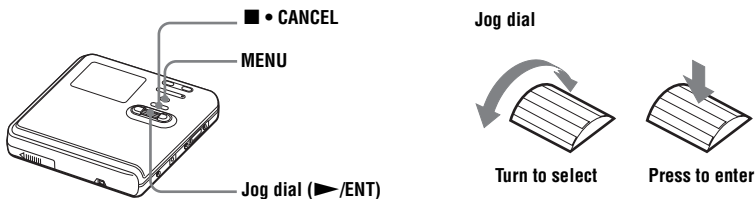

- 1 Press and hold MENU for 2 seconds or more to enter the menu.

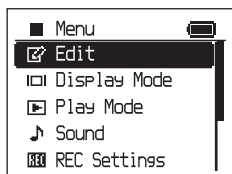

- 2 Turn the jog dial to select the item.
- 3 Press the jog dial (▶/ENT) to enter the selection.
- 4 Repeat steps 2 and 3.
The setting will be entered when you press the jog dial (▶/ENT) at the last.

To return the preceding setting

Press ■ • CANCEL.

To cancel the operation while setting

Press ■ • CANCEL for 2 seconds or more.

List of menus

The following table shows the menu items that you can select. Menu items can be set with the recorder only.



Items listed under “Menu 1” are the selectable items which appear when you enter the menu, and items listed under “Menu 2” are the selectable items which appear when you select an item in Menu 1.



It is possible to display all menu items only when “Menu Mode” is set to “Advanced”. Menu items with an asterisk (*) are not displayed when “Menu Mode” is set to “Simple”. For details, see “Changing the displayed menu items (Menu Mode)” (page 57).

Note

Different indication may be displayed depending on the operating conditions and disc settings.

The items can be displayed in other languages. For details, refer to “Selecting the display language” (page 61).

Menu 1	Menu 2	Function	Site page
 Edit	Title Input*	Adding a track name, artist name, album name, group name, or disc name.	page 46
	Group Set*	Assigns recorded tracks or groups to a new group.	page 49
	GroupRelease*	Releases group settings.	page 50
	Move*	Changes the order of tracks or groups.	page 51
	Erase	Erases tracks, groups, or the entire disc contents.	page 52
	Format*	Formats the disc and restores it to the condition it was in at the time of purchase (in Hi-MD mode only).	page 56
<input type="checkbox"/> Display	Lap Time	Displays various information such as the recorder status, etc. in the display window.	page 31, page 39
	1 Remain		
	Tr Property		
	REC Remain		
	All Remain		
 Play Mode	MainPlayMode	Selects tracks by category, such as group name or artist name.	page 40
	Sub PlayMode	Selects the type of play, such as single-track play or shuffle play.	
	Repeat	Repeats playback.	
 Sound	Normal	Plays with normal sound quality.	page 44
	Sound EQ	Customizes the sound quality.	

Menu 1	Menu 2	Function	Site page
 REC Settings	REC Mode	Selects the recording mode (PCM, Hi-SP or Hi-LP).	page 34
	REC Level*	Manually adjusts the recording level.	page 35
	MIC AGC*	Sets the microphone recording level adjustment mode.	page 33
	MIC Sens*	Sets the microphone sensitivity to suit the source sound.	page 32
	Time Mark*	Adds track marks automatically in a specific time interval.	page 36
	Group REC*	Selects or deselects creation of a new group for each recording operation (Group Recording).	page 37
	SYNC REC*	Simplifies operations during digital recording (Synchro-Recording).	page 38
 File List	—	Displays a list of the non-audio data stored on a disc used in Hi-MD mode.	page 65
 Option	Menu Mode	Changes the displayed menu items.	page 57
	AVLS*	Sets a limit on the maximum volume to protect your hearing.	page 57
	Beep*	Turns the beep sound on or off.	page 57
	EL Light	Turns the display window on or off.	page 58
	Disc Memory*	Stores the recorder settings (Disc Memory).	page 58
	Quick Mode*	Sets the recorder to start playback quickly.	page 59
	Disc Mode	Selects MD mode or Hi-MD mode when a blank disc is inserted.	page 60
	Jog Dial*	Changes the operational direction on the display when turning the jog dial.	page 60
	Language	Selects the language used in the display.	page 61

Before recording

About the operation mode

This recorder has two operation modes, “Hi-MD mode” and “MD mode”. The operation mode is automatically recognized whenever the disc is inserted. After you insert a disc, check the operation mode on the display window of the recorder.

You can record on this recorder only in “Hi-MD mode”. It is not possible to record in “MD mode”. If you want to record in “MD mode”, for example to allow the disc to be played on another component that does not support Hi-MD, connect the recorder to a computer and use the supplied software to record in MD mode (refer to the “Software Operation” section).

“Hi-MD” lights up when the operation mode is Hi-MD and “MD” lights up when the operation mode is MD.

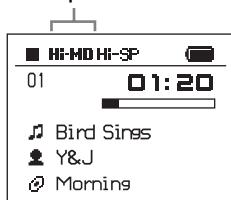





For details on the operation mode for different disc conditions, refer to “Confirm the operation mode.” (page 22).

Selecting the Menu Mode

If the “Simple” menu mode is selected, some menu items will not be displayed. If you cannot find certain menu items while operating the recorder, make sure that the menu mode is set to “Advanced”.

For details on selecting the menu mode, see “Changing the displayed menu items (Menu Mode)” (page 57).

Notes

- When you record on a 1GB Hi-MD disc, connect the AC power adaptor to the recorder, charge the rechargeable battery fully (battery level indication shows ) , or use a new alkaline dry battery (battery level indication shows ). When you attempt to start recording on a 1GB Hi-MD disc, “NOT ENOUGH POWER TO REC” may appear and recording cannot be done even if the battery level indication shows sufficient remaining power while the recorder is stopped or playing. This is because of a mechanism that disables recording when the remaining battery power is estimated by the recorder to be insufficient due to the high power consumption required for 1GB Hi-MD disc recording.
- Make sure to disconnect the dedicated USB cable before recording. Recording may not occur if the dedicated USB cable is connected to the recorder.
- If you start recording before the  indication appears in the display, the first few seconds of the material may not be recorded. Make sure the  indication is displayed before you start recording.
- Do not move or jog the recorder or disconnect the power source while recording, or while “DATA SAVE” or “SYSTEM FILE WRITING” is displayed. If you do, the data recorded up to that point may not be recorded to the disc, or data on the disc may be damaged.

Viewing various information

You can check the remaining time, track number, etc. when recording or during stop.

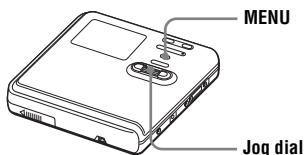

1 Enter the menu and select “Display”.

2 Turn the jog dial to select the information you want, and then press the jog dial to enter the selection. Each turn selects the menu item as follows:

While the recorder is stopped:
 “Lap Time” → “1 Remain” → “Tr Property” → “REC Remain” → “All Remain”

While recording:
 “Lap Time”

When you press the jog dial, the selected information appears at **A**, **B** and **C**.

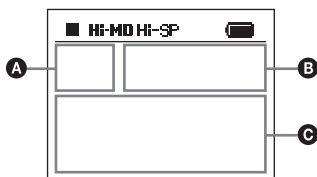

While the recorder is stopped

Lap Time	
A	Track number Group number ¹⁾
B	Elapsed time
C	🎵 Track name 👤 Artist name (Hi-MD)/ 📁 Group name (MD) 🎧 Album name (Hi-MD)/ 📀 Disc name (MD)

1 Remain	
A	Track number Group number ¹⁾
B	Remaining time after the current location in the track
C	🎵 Track name 👤 Artist name (Hi-MD)/ 📁 Group name (MD) 🎧 Album name (Hi-MD)/ 📀 Disc name (MD)

Tr Property	
A	Track number Group number ¹⁾
B	Elapsed time
C	🎵 Track name 📁 Group name Codec information (Hi-MD) ²⁾ / Track mode information (MD) and time and date of recording ³⁾

REC Remain	
A	Track number Group number ¹⁾
B	Elapsed time
C	📀 Disc name Remaining recording time and remaining free space (in Hi-MD mode only)

continued

All Remain	
A	Track number Group number ¹⁾
B	Elapsed time
C	 Disc name ⁴⁾ Remaining time after the current location on the disc and number of tracks after the current track

- 1) Appears when the Main play mode is set to "Group Play".
- 2) If the case of an MP3 track that supports VBR (Variable Bit Rate), the bit rate that appears here may not match the one displayed by the SonicStage software.
- 3) Appears for tracks that have time stamp information.
- 4) The title that is displayed varies according to the selected Main play mode.

While recording

Lap Time	
A	Track number Group number ¹⁾
B	Elapsed time Time mark indication ²⁾
C	Type of recording and remaining recording time Recording level meter (L • R)

- 1) Appears only during group recording
- 2) Appears when "Time Mark" is set to "On".

Notes

- When a disc used in Hi-MD mode is inserted in the recorder, the free space will show as "2.0MB" when the remaining recording time becomes "-00:00". This is a system limitation, "2.0MB" being the capacity of the reserve domain.
- Depending on the group settings, the operating conditions, and the disc settings, you may not be able to select certain indications or the indications may appear differently.



If you want to check the playing position or track name while playing, see "Viewing various information" (page 39).

Recording from a microphone

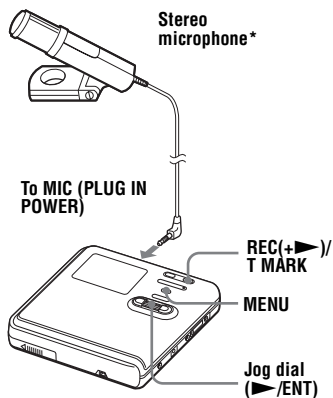

* See "Optional accessories" (page 70).

- 1** Connect the stereo microphone to the MIC (PLUG IN POWER) jack.
- 2** Press the jog dial (>)/ENT while pressing REC(+>)/T MARK to start recording.

To select microphone sensitivity

You can select the microphone sensitivity depending on the volume of the sound source.

- 1** While the recorder is recording or stopped, enter the menu and select "REC Settings" - "MIC Sens".

2 Turn the jog dial to select “Sens High” or “Sens Low”, and then press the jog dial to enter the selection.

Sens High: When recording a soft sound or a sound with a normal volume.

Sens Low: When recording with a loud or close-range sounds, such as those during an oral recording or a music concert.

To change the microphone recording level adjustment mode

When recording with a microphone, you can select automatic adjustment mode which sets the microphone recording level to suit the sound source.

1 While the recorder is recording or stopped, enter the menu and select “REC Settings” - “MIC AGC”.

2 Turn the jog dial to select “Standard” or “ForLoudMusic”, and then press the jog dial to enter the selection.

Standard: When recording a sound source with a normal volume, such as a conversation or soft music.

ForLoudMusic: When recording a sound source with a comparatively high volume, such as a music concert or a practice session with a musical instrument.



- When “MIC AGC” is set to “ForLoudMusic”, sound can be recorded with less distortion during high volume input, and with natural volume transitions similar to those of the original.
- When using a plug-in power-type microphone, the microphone can be operated even when its power switch is turned off since power is supplied from the recorder itself.

Notes

- The recorder automatically switches input in the following order; optical input, microphone input, and analog input. You cannot record through the microphone while an optical cable is connected to the LINE IN (OPT) jack.
- You cannot set the “MIC AGC” setting if you are recording with the recording level manually adjusted (page 35).
- The microphone may pick up the operating sound of the recorder itself. Use the microphone away from the recorder in such cases. Please note that the sound of recorder operations may be picked up if the microphone that you use has a short connector.
- Only the left-channel sound is recorded when a monaural microphone is used.
- Make sure not to touch the plug or the cord of the microphone when recording with the AC power adaptor connected. Doing so may introduce noise into the recording.
- When recording a normal volume sound (soft music, etc.), set “MIC AGC” to “Standard”. If an unexpectedly loud sound is input when “MIC AGC” is set to “ForLoudMusic”, the recorded volume thereafter may drop very low, depending on the sound source.

Recording from a TV or radio (Analog Recording)

This section explains how to record from equipment with analog output, such as a cassette recorder, radio, or TV.

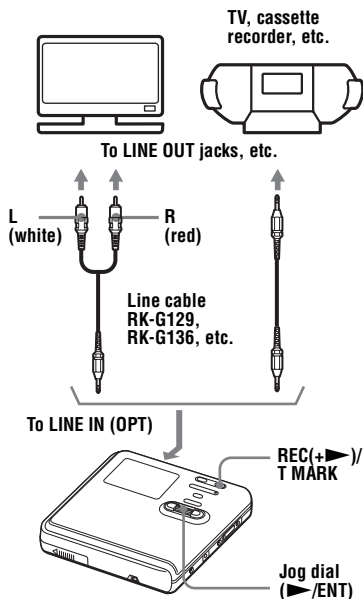

- 1** Make connections.
Use the appropriate connecting cord to suit the source equipment. For details, see “Optional accessories” (page 70).
- 2** Press the jog dial (▶/ENT) while pressing REC(+▶)/T MARK to start recording.
- 3** Play the source you want to record.

Selecting the recording mode

Select each recording mode according to the recording time that you want.

You can record only in Hi-MD mode on this recorder. If you want to record in MD mode, connect the recorder to a computer and record or transfer audio data using the supplied software (refer to the “Software Operation” section).

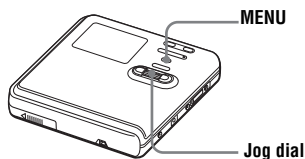

- 1** While the recorder is stopped, enter the menu and select “REC Settings” - “REC Mode”.
- 2** Turn the jog dial to select the desired recording mode, and then press the jog dial to enter the selection.
The recording mode is saved on the recorder until it is next changed.

Recording mode	Display	Recording time
Linear PCM	PCM	<ul style="list-style-type: none"> • Approx. 28 min. on an 80-minute standard disc • Approx. 1 hour and 34 min. on a 1 GB Hi-MD disc
Hi-SP	Hi-SP	<ul style="list-style-type: none"> • Approx. 2 hours and 20 min. on an 80-minute standard disc • Approx. 7 hours and 55 min. on a 1 GB Hi-MD disc

Recording mode	Display	Recording time
Hi-LP	Hi-LP	<ul style="list-style-type: none"> • Approx. 10 hours and 10 min. on an 80-minute standard disc • Approx. 34 hours on a 1GB Hi-MD disc



Audio components that support the linear PCM, Hi-SP and Hi-LP mode are indicated by the or logo mark.

Notes

- It is recommended that you use the AC power adaptor for long recordings.
- It is recommended that you use the recorder to edit (dividing or combining) long tracks recorded in linear PCM. Transferring such tracks and editing them on a computer may require an extremely long time.

Adjusting the recording level manually

The recording level is adjusted automatically while recording. If necessary, you can set the recording level manually during both analog and digital recording.

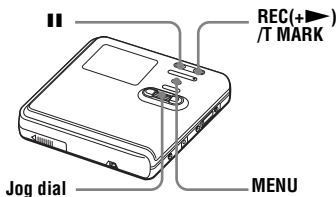

- 1 Press REC(+>)/T MARK while pressing **II**.
The recorder stands by for recording.
- 2 Enter the menu and select “REC Settings” - “REC Level” - “Manual”.

3 Play the source.

4 While observing the level meter in the display, adjust the recording level by turning the jog dial.

Set the level so that the meter segments light up around -12dB segment. If high sound input causes the segments beyond the “OVER” segment to light up, lower the recording level.

Each level meter shows the following.

Upper — L channel input level
Lower — R channel input level

Volume increases (→)
or decreases (←)

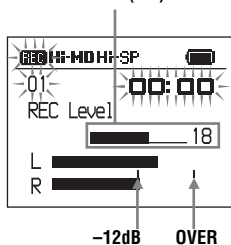

5 Press **II** again to start recording.

If your source is an externally connected component, play the source to the beginning of the material to be recorded, and then start recording.

To switch back to automatic level control

Select “Auto (AGC)” in step 2.

Notes

- You cannot adjust the left and right channel levels separately.
- Once you stop recording, the recorder will revert to automatic recording level adjustment mode the next time you start a recording operation.
- To adjust the recording level manually when synchro-recording, do steps 1 to 4 of the procedure in this section with “SYNC REC” is set to “Off”. Afterwards, set “SYNC REC” setting to “On”, and start recording (page 38).

Adding track marks while recording

You can add track marks (track number) while recording to divide the material into separate parts, that allow you to go to specific track quickly and easily.

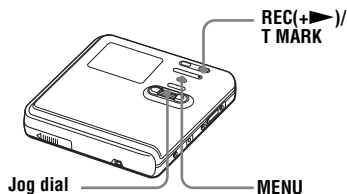

Adding track marks manually

While the recorder is recording, press REC(+▶)/T MARK at the point you want to add a track mark.

Adding track marks automatically

Use this feature to add track marks automatically at specified intervals when recording through the analog input connector or a microphone. This function is convenient for recording long period of time, such as lectures, meetings, etc.

- 1 While the recorder is recording or in recording pause, enter the menu and select “REC Settings” - “Time Mark” - “On”.
- 2 Turn the jog dial to select the desired time interval, and then press the jog dial to enter the selection.

One rotation changes the time setting (Time __ min) by 1 minute, within the range of 1 to 60 minutes.

To cancel Time Mark

Select “Off” in step 1.

Using Time Mark to add track marks while recording

When the elapsed recording time exceeds the time interval for Time Mark:

The recorder adds track marks at the point you set the time interval and from that point the recorder adds a track mark whenever the time interval has elapsed.

Example: Eight minutes of recording has been completed when the Time Mark time interval is set to 5 minutes. A track mark will be added at the 8-minute point (after the start of recording) and after each 5-minute interval thereafter.

When the time interval set for Time Mark exceeds the elapsed recording time:

The recorder adds track marks when the set Time Mark time interval has elapsed.

Example: Three minutes of recording has been completed when the Time Mark time interval is set to 5 minutes. A track mark will be added at the 5-minute point (after the start of recording) and after each 5-minute interval thereafter.



“T MARK” appears before the time display for track marks added automatically.

Notes

- If you add a track mark by pressing REC(+▶)/T MARK or II, etc. while recording, the recorder will start adding track mark automatically each time the selected time interval as elapsed.
- The setting is canceled when you connect a digital optical cable to the recorder.

Recording without creating a new group

The recorder is factory set to automatically create a new group for each recording. To record without creating a new group, set the recorder as follows.

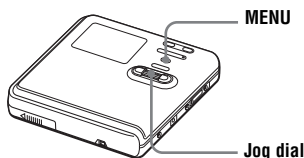

While the recorder is stopped, enter the menu and select "REC Settings" - "Group REC" - "Off".

What is the group function?

The group function allows you to place several tracks into one unit.

For example, if you create a group for all your favorite tracks, then you can select that group to play those tracks.

The following figure shows the difference between a disc on which groups are recorded and a disc on which no groups are recorded.

Disc with no groups recorded

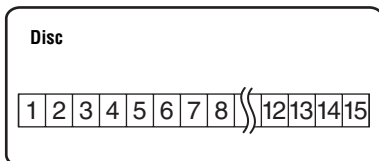

You can record a maximum of 255 groups on a disc.

If you record a track without creating a group, but then later want to create a group for that track, refer to "Assigning tracks or groups as a new group (Group Set)" (page 49).

Disc with groups recorded

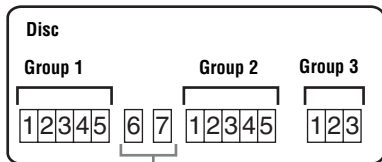

Tracks that were not assigned to a group are treated as being part of "Group - -".

To start/stop recording in sync with the sound source (Synchro-recording)

When making a digital recording (e.g., from a CD), this function automatically starts and stops the recorder in synchronization with the sound source. This eliminates the need for separate operation of the recorder and the sound source.

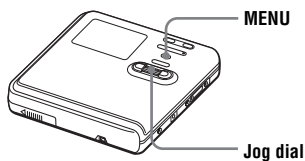

While the recorder is stopped, enter the menu and select “REC Settings” - “SYNC REC” - “On”.



When there is no sound from the player for about 3 seconds during synchro-recording, the recorder goes into the standby mode automatically. When the sound comes from the player again, the recorder resumes synchro-recording. If the recorder is kept in the standby mode for 5 minutes or longer, the recorder stops automatically.

Notes

- The pause function cannot be turned on or off manually during synchro-recording.
- Do not switch the “SYNC REC” setting while recording. Recording may not be done properly.
- Even when there is no sound on the sound source, there may be cases when recording does not pause automatically during synchro-recording due to the noise level emitted from the sound source.
- If a silent portion is encountered for approximately 2 seconds during synchro-recording from a sound source other than a CD or an MD, a new track mark is automatically added at the point where the silent portion ends.

Viewing various information

You can check the track name, disc name, etc. during playback.

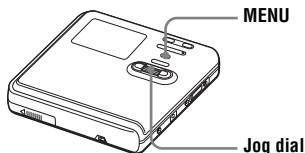

1 Enter the menu and select “Display”.

2 Turn the jog dial to select the information you want, and then press the jog dial to enter the selection.

Each turn selects the display as follows.

“Lap Time” → “1 Remain” → “Tr Property”

When you press the jog dial, the selected information appears at **A**, **B** and **C**.

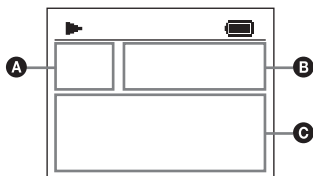

While the recorder is stopped

Lap Time	
A	Track number Group number ¹⁾
B	Elapsed time
C	🎵 Track name 👤 Artist name (Hi-MD)/ 📁 Group name (MD) 🎧 Album name (Hi-MD)/ 📀 Disc name (MD)

1 Remain	
A	Track number Group number ¹⁾
B	Remaining time of the current track
C	🎵 Track name 👤 Artist name (Hi-MD)/ 📁 Group name (MD) 🎧 Album name (Hi-MD)/ 📀 Disc name (MD)

Tr Property	
A	Track number Group number ¹⁾
B	Elapsed time
C	🎵 Track name 📁 Group name Codec information (Hi-MD) ^{2)/} Track mode information (MD) and time and date of recording ³⁾

¹⁾ Appears when the Main play mode is set to “Group Play”.

²⁾ If the case of an MP3 track that supports VBR (Variable Bit Rate), the bit rate that appears here may not match the one displayed by the SonicStage software.

³⁾ Appears for tracks that have time stamp information.

Note

Depending on the group settings, the operating conditions, and the disc settings, you may not be able to select certain indications or the indications may appear differently.



If you want to check the remaining time or the recording position while recording or in stop mode, see “Viewing various information” (page 31).

Selecting the play mode

You can listen to tracks in various play modes. The play mode can consist of a combination of Main play mode, Sub play mode and Repeat play.

- Main play mode: selects the playback unit, such as tracks or groups
- Sub play mode: selects the type of play
- Repeat play: selects Repeat play

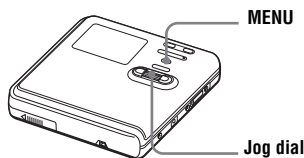

Playing tracks in Main play mode

Selects the first track to be played in Main play mode.

- 1** While playing, enter the menu and select “Play Mode” - “MainPlayMode”.
The Main play mode display appears.
- 2** Turn the jog dial to select the desired play mode, and then press the jog dial to enter the selection.

Display	Play mode
Normal Play	All tracks after the selected track are played.
Group Play	Tracks in a specified group are played.
Artist Play ¹⁾	Tracks by a specified artist are played.
Album Play ¹⁾	Tracks in a specified album are played.
BookmarkPlay	Bookmarked tracks are played.

¹⁾ Appears only for discs used in Hi-MD mode.

Playing tracks in normal mode (Normal Play)

- 1** Do step 1 and select “Normal Play” in step 2 of “Playing tracks in Main play mode” (page 40).
- 2** When selecting a track out of a group, skip this step.
When selecting a track within a group, turn the jog dial to select the group that the desired track belongs, and then press the jog dial to enter.
A list of the tracks in the selected group appears in the display.
- 3** Turn the jog dial to select the desired track, and then press the jog dial to enter the selection.
The selected track starts playing. The recorder plays from the selected track to the last track in the disc.

Listening to tracks in a specific group (Group Play)

- 1** Do step 1 and select “Group Play” in step 2 of “Playing tracks in Main play mode” (page 40).
A list of the groups on a disc appears.
- 2** Turn the jog dial to select the desired group, and then press the jog dial to enter.
A list of the tracks in the selected group appears.
- 3** Turn the jog dial to select the desired track, and then press the jog dial to enter the selection.
The selected track starts playing. The recorder plays the tracks in that group, from the selected track to the last track.



Tracks that do not belong to a group are placed together in “Group - -” and displayed at the last of the list of groups.

Listening to tracks by a specific artist (Artist Play) (in Hi-MD mode only)

If the track data includes the artist name, you can listen to tracks by a specific artist only.

- 1 Do step 1 and select “Artist Play” in step 2 of “Playing tracks in Main play mode” (page 40).

A list of the artists on the disc appears in alphabetical order.

- 2 Turn the jog dial to select the desired artist name, and then press the jog dial to enter.

A list of the tracks of the selected artist appears in recorded order.

- 3 Turn the jog dial to select the desired track, and then press the jog dial to enter the selection.

The selected track starts playing. The recorder plays the tracks by the same artist on the disc, from the selected track to the last track.



Tracks without artist name data are placed together in “ _ (space)” and are displayed at the last of the list of artists.

Listening to tracks of a selected album (Album Play) (in Hi-MD mode only)

If the track data includes the album name, you can listen to tracks of a selected album only.

- 1 Do step 1 and select “Album Play” in step 2 of “Playing tracks in Main play mode” (page 40).

A list of the albums on the disc appears in alphabetical order.

- 2 Turn the jog dial to select the desired album name, and then press the jog dial to enter.

A list of the tracks in the selected album appears in recorded order.

- 3 Turn the jog dial to select the desired track, and then press the jog dial to enter the selection.

The selected track starts playing. The recorder plays the tracks in that album, from the selected track to the last track.



Tracks without album name data are placed together in “ _ (space)” and are displayed at the last of the list of albums.

Listening to selected tracks only (Bookmark Play)

You can bookmark tracks on a disc and play them only. The sequence of bookmarked tracks cannot be changed.

To bookmark the tracks

- 1 While playing the track you want to bookmark, press the jog dial for 2 seconds or more.

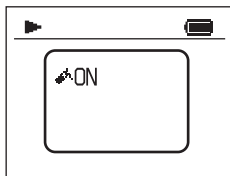

- 2 Repeat step 1 to bookmark the other tracks.

To play the bookmarked tracks

- 1 Do step 1 and select “BookmarkPlay” in step 2 of “Playing tracks in Main play mode” (page 40).

continued

- Turn the jog dial to select a track, and then press the jog dial to enter the selection.

To erase bookmarks

While playing the track for which you want to erase the bookmark, press the jog dial for 2 seconds or more.

Playing tracks in Sub play mode

By specifying Sub play modes, you can listen to tracks selected in Main play mode in various ways.

For example, by selecting “Group Play” in Main play mode and “Shuffle” in Sub play mode, the recorder will play the tracks in the selected group in random order.

- Enter the menu and select “Play Mode” - “Sub PlayMode”.
- Turn the jog dial to select the desired play mode, and then press the jog dial to enter the selection.

Display	Play mode
Normal	Normal play (All tracks are played once.)
1 Track	Single-track play (A single track is played.)
Shuffle	Shuffle play (All tracks in the selected Main Play Mode are played in random order.)
A-B Repeat ¹⁾	A-B Repeat play (Tracks between the selected points A and B are played repeatedly.)

¹⁾“A-B Repeat” does not appear when the “Menu Mode” is set to “Simple” (page 57).

Listening to a section of a track repeatedly (A-B Repeat)

Make sure that points A and B are within the same track.

- While playing a track that contains the section you want to repeat, do step 1 and select “A-B Repeat” in step 2 of “Playing tracks in Sub play mode” (page 42).
“A➔” flashes in the display.
- Press the jog dial at the starting point (A).
Point A is entered and “B” flashes in the display.
- Press the jog dial at the ending point (B).
Point B is entered, “A➔B” and “⏮” lights up, and the section between point A and B starts playing repeatedly.



You can reset points A and B by pressing the ►► button during A-B Repeat play.

Note

If the recorder comes to the end of the last track on the disc while you are selecting point A, the setting is canceled.

Playing tracks repeatedly (Repeat Play)

You can use the Repeat play function to repeat tracks in all play modes except when selecting A-B Repeat play.

- While playing, enter the menu and select “Play Mode” - “Repeat”.
- Turn the jog dial to select “On”, and then press the jog dial to enter the selection.
⏮ appears in the display.

To cancel Repeat Play

Select "Off" in step 2.

Searching for a track (Search)

You can easily search for a track by track name, group name, artist name, or album name.

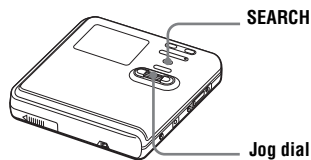

- 1 Press SEARCH.
- 2 Turn the jog dial to select the item you want to use for searching, and then press the jog dial to enter.

Display	To
by Track	search by track name
by Group	search by group name
by Artist ¹⁾	search by artist name
by Album ¹⁾	search by album name

¹⁾ Appears only for discs used in Hi-MD mode.

- 3 If you select "by Track" in step 2, skip this step.
If you select an item other than "by Track" in step 2, turn the jog dial to select the desired group, artist, or album, and then press the jog dial to enter.
A list of tracks for the selected group, artist, or album appears in the display.
- 4 Turn the jog dial to select the desired track, and then press the jog dial to enter the selection.
The selected track starts playing.

Searching for a track by initial character (Initial Search)

You can search for a track, group, artist, or album by its initial character.

- 1 Do steps 1 and 2 of "Searching for a track (Search)".
- 2 Turn the jog dial to select "Initial Search", and then press the jog dial to enter.



- 3 Turn the jog dial to select the first character of the name to be searched for, and then press the jog dial to enter the letter.

The following characters can be entered for an initial search.

Display	To
Alphabet (A to Z)	Searches for a name starting with an English letter.
Num (Numbers)	Searches for a name starting with a number.
Other	Searches for a name starting with a character other than an English letter or a number.

When you press the jog dial, a list of tracks, groups, artists, or albums with names starting with the selected initial character appears in the display.

- 4 Turn the jog dial to select the desired track, and then press the jog dial to enter the selection.

Notes

- After step 4, Bookmark play is canceled.
- After step 4, A-B Repeat play is canceled.
- During a search, unlabeled tracks appear at the end of each list.
- During a search, ungrouped tracks are placed together as “Group - -” and appear at the end of the list of groups.
- During a search, tracks without artist name data are placed together as “ 👤 _ (space)”, and tracks without album name data are placed together as “ 🎵 _ (space)” and appear at the end of the list.
- While the recorder is sorting the selected items, “SORTING” appears in the display.
- The Search function is automatically canceled if no operation is made for 3 minutes.

Selecting the sound quality (6-Band Equalizer)

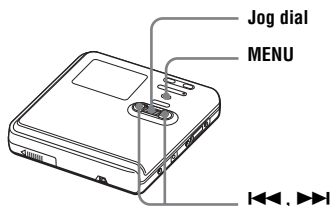

- 1 While playing, enter the menu and select “Sound” - “Sound EQ”.
- 2 Turn the jog dial to select the desired sound mode, and then press the jog dial to enter the selection.

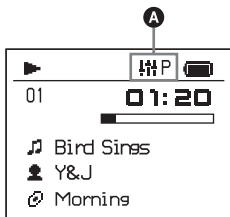

When you press the jog dial, the selected sound mode will appear at **A**.

The icon “H P” indicates that a sound mode has been set.

Sound mode	A
Heavy	H H
Pops	H P
Jazz	H J
Unique	H U
Custom 1 ¹⁾	H 1
Custom 2 ¹⁾	H 2

¹⁾ “Custom 1” and “Custom 2” do not appear on European models.
 “Custom 1” and “Custom 2” do not appear when the “Menu Mode” is set to “Simple” (page 57).

To cancel the setting

Select “Normal” in step 1.

To modify and store the sound (For models except European models)

You can modify the sound and store the results in “Custom 1” and “Custom 2”.

- 1 Do steps 1 and select “Custom 1” or “Custom 2” in step 2 of “Selecting the sound quality (6-Band Equalizer)” (page 44).
- 2 Press **◀◀** or **▶▶** repeatedly to select the frequency.

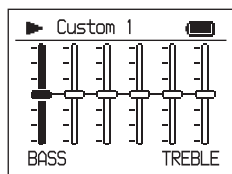

← →
Frequency (100 Hz)
From the left, you can select 100 Hz, 250 Hz, 630 Hz, 1.6kHz, 4 kHz, or 10 kHz

- 3 Turn the jog dial to adjust the level.

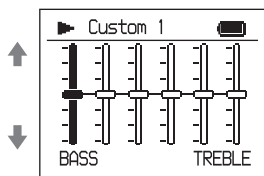

↑ ↓
Level (+10 dB)
You can select from among seven levels. -10 dB, -6 dB, -3 dB, 0 dB, +3 dB, +6 dB, +10 dB



- 4 Repeat steps 2 and 3 to adjust the level for each frequency.
- 5 Press the jog dial to enter the selection.

Note

6-Band Equalizer will not function during recording.

Before editing

Notes

- When you edit the contents of a 1GB Hi-MD disc, connect the AC power adaptor to the recorder, charge the rechargeable battery fully (battery level indication shows ) , or use a new alkaline dry battery (battery level indication shows ). When you attempt to edit on a 1GB Hi-MD disc, “NOT ENOUGH POWER TO EDIT” may appear and editing cannot be done even if the battery level indication shows sufficient remaining power while the recorder is stopped or playing. This is because of a mechanism that disables editing when the remaining battery power is estimated by the recorder to be insufficient due to the high power consumption required for 1GB Hi-MD disc editing.
- Close the record-protect tab on the side of the disc before editing.
- Do not move or jog the recorder or disconnect the power source while editing or “SYSTEM FILE WRITING” is displayed. If you do, the data edited up to that point may not be recorded to the disc, or data on the disc may be damaged. “SYSTEM FILE WRITING” is displayed while the editing results are being recorded.
- While “SYSTEM FILE WRITING” is displayed, the lid becomes locked.

Adding titles (Title Input)

You can add titles to tracks, groups and discs. You can also add artist names and album names to tracks on a disc used in Hi-MD mode.

Some features depend on the model, such as the number of characters that can be input and the character palette on the recorder. Refer to the following items to verify what input characters are supported, the maximum number of characters that can be input and the character palette.

For the European and North American models

Available characters

- Capital and small letters of the alphabet for English and European languages¹⁾
- Numbers 0 to 9
- Symbols²⁾

¹⁾ European alphabets appear only for discs used in Hi-MD mode.

²⁾ The available symbols will differ for Hi-MD mode and MD mode (see “Character palette” (page 47)).

Maximum number of characters per name

Track names, group names, and disc name: Approx. 200 each (containing a mixture of all available characters)

Maximum number of characters that can be input per disc*

In Hi-MD mode:

A maximum of about 55,000 characters

In MD mode:

A maximum of about 1,700 characters

* The number of titles that can be stored on a disc depends on the number of characters that are input for track names, group names, artist names, album names and disc name.

Character palette

The character palette has the following configuration.

Character palette for Hi-MD mode

```
ABCDEFGHIJ
KLMNOPQRST
UVWXYZ ?!&
abcdefghijklmnopq
rst
uvwxyz"'. ,
0123456789
: ; ( ) { } [ ] < >
À Á Â Ã Ä Å Æ Ç È É
Ê Ë Ì Í Î Ï Ñ Ò Ó
Ô Õ Ö Ø Ù Ú Û Ü Ý Þ
ß à á â ã ä å æ ç è
é ê ë ì í î ï ð ñ ò
ó ô õ ö ø ù ú û ü ý
þ ÿ ÿ ÿ % $ £ ¥ ¤
+ - ± * × ÷ = < >
\ @ # ¢ ° ' " : ;
¼ ½ ¾ ~ ¯ µ ¶ · ¸ ¹
: ; ( ) % $ + - *
/ = < > @ # ` _
```

Character palette for MD mode

```
ABCDEFGHIJ
KLMNOPQRST
UVWXYZ ?!
abcdefghijklmnopq
rst
uvwxyz"'. ,
0123456789
: ; ( ) % $ + - *
/ = < > @ # ` _
```

Maximum number of characters that can be input per disc*

In Hi-MD mode:

A maximum of about 27,000 characters

In MD mode:

A maximum of about 1,700 characters

* The number of titles that can be stored on a disc depends on the number of characters that are input for track names, group names, artist names, album names and disc name.

Character palette

The character palette has the following configuration.

Character palette for Hi-MD mode

```
ABCDEFGHIJ
KLMNOPQRST
UVWXYZ ?!&
abcdefghijklmnopq
rst
uvwxyz"'. ,
0123456789
: ; ( ) { } [ ]
% $ + - * / = < > \
@ # | _
```

Character palette for MD mode

```
ABCDEFGHIJ
KLMNOPQRST
UVWXYZ ?!
abcdefghijklmnopq
rst
uvwxyz"'. ,
0123456789
: ; ( ) % $ + - *
/ = < > @ # ` _
```

For the Asian, African, Australian and tourist models

Available characters

- Capital and small letters of the English alphabet
- Numbers 0 to 9
- Symbols*

* The available symbols will differ for Hi-MD mode and MD mode (see "Character palette" on page 47).

Maximum number of characters that can be input per title

Track names, group names, and disc name: Approx. 100 each in Hi-MD mode and 200 each in MD mode (containing a mixture of all available characters)

About the character palette

During operations on the recorder, characters can be selected from the character palette in the display window. (See "Character palette" for the configuration of the character palette.) Since only a part of the character palette is visible on the display, use the controls or buttons to move the cursor and enter characters.

Letter input area

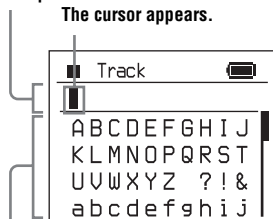

Character palette

Notes

- If you enter the symbol “/” between the characters in disc names such as “abc//def”, you may be unable to use the group function (in MD mode only).
- For the Asian, African and tourist models, Chinese characters can be displayed but cannot be input. You can input Chinese characters with the SonicStage software.

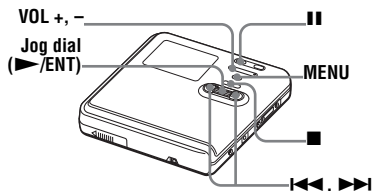

Labeling

You can do a labeling operation while the recorder is stopped or playing. You can also label artist names and album names to tracks in a disc used in Hi-MD mode. To label a track with a track name, artist name, or album name, you must first select the track that you want to label. To add a group name, you must first select a track that belongs to the group you want to label.

- 1 Enter the menu and select “Edit” - “Title Input”.
- 2 Turn the jog dial to select one of the following, and then press the jog dial.

Title	Display
Track name	Track
Group name	Group
Artist name (to a track)	Artist ¹⁾
Album name (to a track)	Album ¹⁾
Disc name	Disc

¹⁾ Appears only for discs used in Hi-MD mode.

The cursor flashes in the letter input area.

The cursor flashes.



- 3 Turn the jog dial downward. The cursor shifts from the letter input area to the character palette.

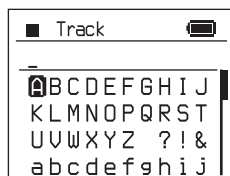

- 4 Select a letter and press the jog dial to enter.

The selected letter appears in the letter input area and the cursor moves to the next input position.

The cursor flashes at the next input position.



The buttons used for character input and their functions are listed below.

Functions ¹⁾	Operations
To move the cursor to the left or to the right.	Press ◀◀ or ▶▶.

Functions ¹⁾	Operations
To move the cursor up or down	Turn the jog dial.
To enter a letter.	Press the jog dial (▶/ENT).
To insert a blank space.	Press VOL +.
To delete a letter.	Press VOL -.
To move the cursor from the character palette to the letter input area.	Press ■.
To switch between capital letters and small letters.	Press ■■.

¹⁾ Functions of the buttons or the control may differ depending on when the cursor is in the letter input area or in the character palette.

- 5** Repeat step 4, and then enter all characters of the label name.
- 6** Press the jog dial for 2 seconds or more to enter the title.

Re-labeling

You can change the titles by doing the procedure for “Labeling” (page 48).

Notes

- The recorder is able to display, but cannot label using Japanese “Katakana” characters.
- The recorder cannot rewrite a disc or track name of more than 200 letters that was created by another device (in MD mode only).

Assigning tracks or groups as a new group (Group Set)

With this function, you can assign existing tracks or groups to a new group, and also you can assign a track that currently belongs to no group to an existing group.

You can create a maximum of 255 groups on a disc used in Hi-MD mode and 99 groups on a disc used in MD mode.

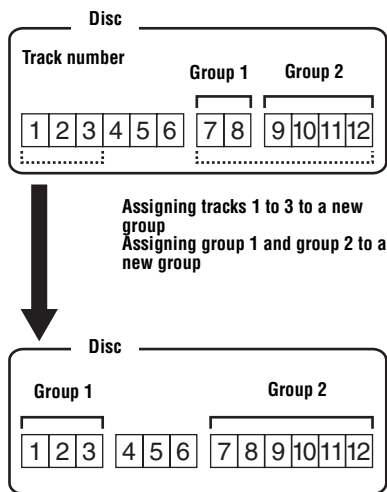

Registration of non-consecutive tracks is not possible (for example, track 3 and tracks 7 and 8 cannot be assigned to a new group).

It is not possible to make a new group if the first track or last track of the group has been selected from the middle of an existing group.

Track numbers appear according to their order on the disc, not their order within the group.

Notes

- When the total number of characters in the titles on a disc exceed the maximum that can be input:
 - If the disc is being used in Hi-MD mode, you can make a group setting, but cannot add a group name in step 4.
 - If the disc is being used in MD mode, you cannot make a group setting.
- The tracks or groups must be sequential. If the desired tracks or groups are not consecutive, you must move them to make them consecutive before you can assign them (“Moving recorded tracks or groups (Move)”, page 51).

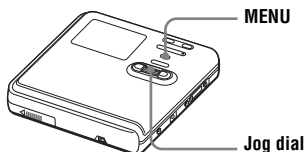

- 1** While the recorder is stopped, enter the menu and select “Edit” - “Group Set”.
- 2** Turn the jog dial to select the number of the desired first track, and then press the jog dial to enter.

This selects the first track of a new group. If the disc contains groups, only the first track number of each group is displayed.

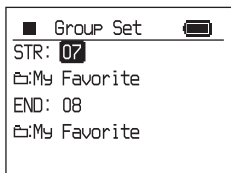

- 3** Turn the jog dial to select the number of the desired last track, and then press the jog dial to enter.

This selects the last track of the new group and the group can be labeled. If the disc contains groups, only the last track number of each group is displayed.

- 4** Label a group (see “Adding titles (Title Input)” (page 46)).

Notes

- In step 2, the first track must be either the first track of an existing group or a track that does not belong to a group.
- When selecting the last track in step 3, make sure the track comes after the one selected in step 2. The last track must be either the last track of an existing group or a track that does not belong to a group.

Releasing a group setting (Group Release)

Select a group you want to release and check the contents (see “Listening to tracks in a specific group (Group Play)” on page 40).

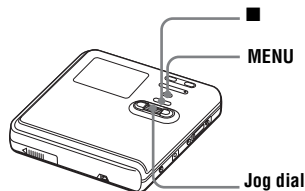

- 1** Select a group that you want to release and check the contents (see page 40).
- 2** Press ■.
- 3** Enter the menu and select “Edit” - “GroupRelease”.

- 4** Turn the jog dial to select “OK”, and then press the jog dial to release a group.

The group setting of the selected group is released.

Moving recorded tracks or groups (Move)

You can change the order of the recorded tracks or groups.

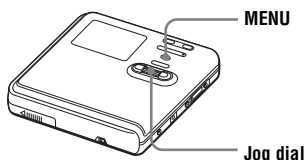

Moving a track on a disc

You can move a track from one group to another or from inside a group to outside the group. When you move tracks, track numbers are automatically renumbered.

- 1** While playing the track you want to move, enter the menu and select “Edit” - “Move” - “Track Move”. If the selected track is in the group, the name of the group to which the currently selected track belongs appears on the 3rd line in the display.

When the currently selected track is in a group

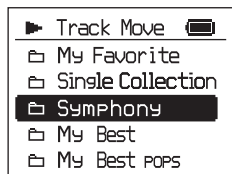

If the selected track is not in the group, the name of the currently selected track appears on the 3rd line in the display.

When the currently selected track is not in a group



- 2** If you are moving a track from inside a group to outside the group, or if there is no group on a disc, skip this step.

If you are moving a track to a different group, turn the jog dial to select the destination group, and then press the jog dial to enter.

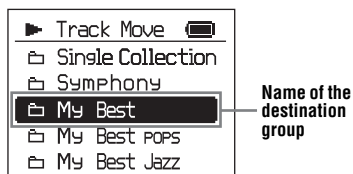

If you are moving a track within the same group, select the group to which the currently selected track belongs.

- 3** Turn the jog dial to select the destination position, and then press the jog dial to enter the selection. The track moves to the selected destination.

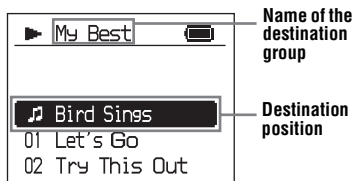

Changing the order of a group on a disc

- 1 While playing a track within a group whose order you want to change, enter the menu and select "Edit" - "Move" - "Group Move".

The name of the group to which the currently selected track belongs appears on the 3rd line in the display.

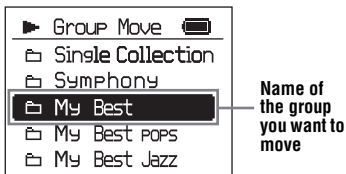

- 2 Turn the jog dial to select the destination position, and then press the jog dial to enter the selection.

Example: When moving the group "My Best" to the position after the group "Single Collection"

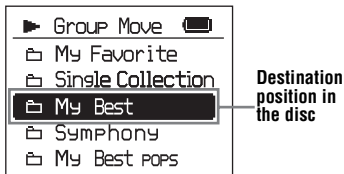

Note

If all tracks are moved out of the group, the group automatically disappears from the disc.

Erasing tracks and the entire disc (Erase)

Note that once a recorded item has been erased, it cannot be recovered. Make sure to confirm the contents of the selected item before erasing it.

When erasing tracks that have been transferred from the computer

When you try to erase tracks that have been transferred from the computer, "TRK FROM PC ERASE OK?" appears in the display. If you erased tracks that have been transferred from the computer, the transfer authorization of the tracks will be as follows.

- If the tracks were transferred in Hi-MD mode, the transfer authorization of the tracks are restored automatically when you insert the disc into the recorder and then connect the recorder to the computer.
- If the tracks were transferred in MD mode, the transfer authorization of the tracks is lost. If you do not want to lose the transfer authorization, restore the authorization by transferring the tracks to the computer again before erasing them.

Note

You cannot erase non-audio data (for example, text data or image data) on a disc used in Hi-MD mode.

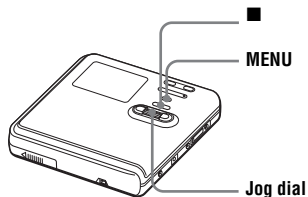

To erase a track

- 1** While playing the track you want to erase, enter the menu and select “Edit” - “Erase” - “Track Erase”.
- 2** Turn the jog dial to select “OK”, and then press the jog dial to erase the track.
The track is erased and the next track starts to play. All the tracks after the one erased are automatically renumbered.

Note

If all tracks in a group are erased, the group is automatically deleted from the disc.

To erase a part of a track

Add track marks at the beginning and the end of the part you want to erase, then erase the part (page 54).

To erase a group

- 1** Select a group you want to erase and check the contents (see page 40).
- 2** Press ■.
- 3** Enter the menu to select “Edit” - “Erase” - “Group Erase”.
- 4** Turn the jog dial to select “OK”, and then press the jog dial to erase the group.
The group is erased.

To erase the whole disc

- 1** Play the disc you want to erase to check the contents.
- 2** Press ■.
- 3** Enter the menu to select “Edit” - “Erase” - “All Tr Erase”.
“ALL TRACKS WILL BE ERASED” appears in the display.
- 4** Turn the jog dial to select “OK”, and then press the jog dial to erase the whole disc.
“SYSTEM FILE WRITING” appears in the display, and all the tracks will be erased.
When erasing completes, “NO TRACK” appears in the display in Hi-MD mode and “BLANKDISC” appears in MD mode.

Dividing a track (Divide)

You can divide a track with a track mark, creating a new track from the part following the track mark. You can also make fine adjustments to the track mark position before making the actual division. The track numbers will increase as follows.

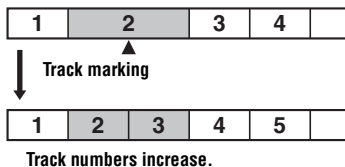

Note

You cannot divide a track if:

- the track has been transferred from a computer.
- the track has been recorded in Hi-MD mode using the MD Simple Burner software.
- the dividing point is at the beginning or end of the track.
- the division would cause the total number of tracks on the disc to exceed the maximum allowed (2,047 tracks for a disc used in Hi-MD mode or 254 tracks for a disc used in MD mode).

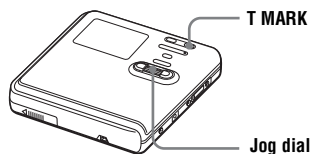

Dividing a track directly

While playing or pausing, press T MARK at the point you want to mark.

Adjusting the dividing point before dividing a track (Divide Rehearsal)

- 1 While playing, press T MARK for 2 seconds or more. Four seconds of the track from the point T MARK is pressed is played back repeatedly.

The point T MARK is pressed.

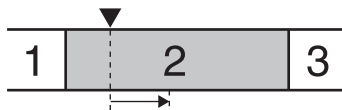

Four seconds of the track plays back repeatedly.

- 2 Turn the jog dial to adjust the point to divide.

Turning the jog dial moves the dividing point forward or backwards. The dividing point can be moved up to a maximum of 8 seconds forward or backwards from the point T MARK was pressed in step 1.

The point T MARK is pressed in step 1.

The dividing point shifts a maximum of 8 seconds forward or backwards.

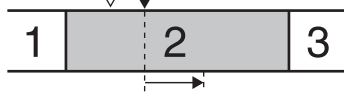

The moved four-second interval plays back repeatedly.

- 3 Press the jog dial to enter the dividing point.

To add track marks while recording (except while synchro-recording)

Press T MARK on the recorder at the point you want to add a track mark. You can use the “Time Mark” setting to add track marks automatically at specified intervals (except while digital recording) (page 36).

Combining tracks (Combine)

When you record with analog (line) input, unnecessary track marks may be recorded where recording level is low. You can erase a track mark to combine the tracks before and after the track mark. The track numbers will change as follows.

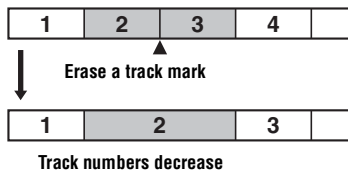

Note

You cannot combine tracks if:

- one of the two tracks or the both tracks have been transferred from the computer.
- one of the two tracks or the both tracks have been recorded in Hi-MD mode using the MD Simple Burner software.
- the tracks are recorded in different recording mode.

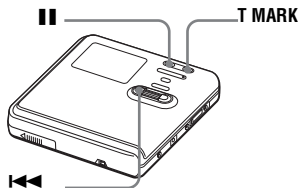

1 While playing the track with the track mark you want to erase, press **II** to pause.

2 Find the track mark by pressing **II** slightly.

For example, to erase the third track mark, find the beginning of the third track. “00:00” appears in the display. “MARK” appears in the display for a few seconds.

3 Press T MARK to erase the mark. “MARK OFF” appears in the display. The track mark is erased and the two tracks are combined.



When a track mark is erased when you combine two tracks, the title and the recording date of the second track changes to those of the first track.

Note

When you erase a track mark between the two consecutive tracks that are assigned into different groups, the second track is re-assigned into the group containing the first track. In addition, if you combine a track that is assigned to a group with a track that is not assigned to a group (two consecutive tracks), the second track takes the same registration setting as the first track.

Formatting the disc (Format)

When using a disc in Hi-MD mode, you can use the Format function to restore a disc to the condition it was in at the time of purchase.

You can use this function only when using a disc in Hi-MD mode.

Disc type	After disc formatting
1GB Hi-MD disc	"NO TRACK" appears. All data including non-audio data will be erased.
	NOTE: Transfer authorization of the transferred tracks can be restored by inserting the disc into the recorder and connecting the recorder to the computer.
60/74/80-minute standard disc	"BLANKDISC" appears. All data including non-audio data will be erased.
	NOTE: Transfer authorization of the transferred tracks will decrease by one.

Notes

- By formatting a disc, all data (including non-audio data) will be erased. If you think a disc contains such data, insert the disc into the recorder and connect the recorder to the computer to check the contents of the disc.
- If you format a disc, the transferred tracks on the disc will also be erased and the number of transfer authorizations for those tracks will be decreased by one. To prevent the reduction in transfer authorizations, restore the transfer authorization by transferring the tracks to the computer again before formatting the disc.
- The operation mode set in the "Disc Mode" menu is applied to a blank 60/74/80-minute standard disc used on the recorder even if a different operation mode was selected in the SonicStage software or a different operation mode appeared on the display after the disc was formatted by the SonicStage software.

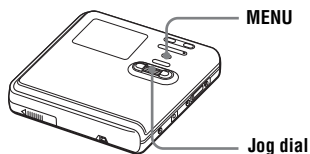

- 1** While the recorder is stopped, enter the menu and select "Edit" - "Format".
"ALL DATA WILL BE DELETED" appears in the display.
- 2** Turn the jog dial to select "OK", and then press the jog dial to enter the selection.
"SYSTEM FILE WRITING" appears in the display, and a disc will be formatted.
When formatting completes, "NO TRACK" appears in the display if a 1GB Hi-MD disc is inserted in the recorder, or "BLANKDISC" appears if a standard disc in Hi-MD mode is inserted.

Changing the displayed menu items (Menu Mode)

You can specify the display of all items in the menu (Advanced mode) or only basic items (Simple mode).

Refer to "List of menus" (page 28) to check the menu items that cannot be displayed.

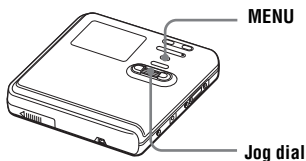

- 1 Enter the menu and select "Option" - "Menu Mode".
- 2 Turn the jog dial to select "Advanced" or "Simple", and then press the jog dial to enter the selection.

Protecting your hearing (AVLS)

The AVLS (Automatic Volume Limiter System) function prevents the volume from being raised above a given level to minimize sound leakage, sound pressure on the ears and the danger connected with the failure to hear important exterior sounds.

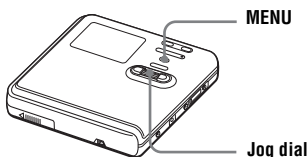

- 1 Enter the menu and select "Option" - "AVLS".

- 2 Turn the jog dial to select "On", and then press the jog dial to enter the selection.

When you try to turn the volume too high, "AVLS NO VOLUME OPERATION" appears in the display. The volume is kept to a moderate level.

To cancel the AVLS

Select "Off" in step 2.

Turning off the beep sound

You can turn off/on the beep sound on the recorder and the remote control.

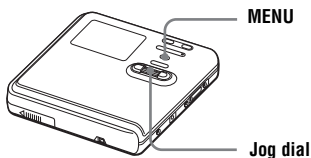

- 1 Enter the menu and select "Option" - "Beep".

- 2 Turn the jog dial to select "Off", and then press the jog dial to enter the selection.

To turn on the beep sound

Select "On" in step 2.

Preserving battery power (EL Light)

With this function, you can set the display window to turn off automatically or to stay lit during battery-powered operation. Power consumption is reduced when the display turns off automatically.

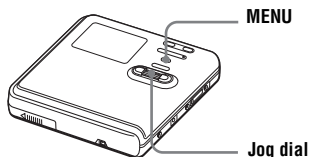

- 1 Enter the menu and select “Option” - “EL Light”.
- 2 Turn the jog dial to select “Auto Off” or “On”, and then press the jog dial to enter the selection.

Display	Setting
Auto Off (factory setting)	The display window darkens when no operation has occurred for 10 seconds. If no operation occurs for 5 more seconds, the display window turns off automatically (only the indication showing the operating condition remains lit).
On	The display window remains lit even it becomes dark when no operation has been made for 10 seconds.

Lighting up the display window when necessary, even with “EL Light” set to “Auto Off”

Press LIGHT.

The display window lights up.

Notes

- The display window will not turn off while:
 - the recorder is being used with the AC power adaptor.
 - charging the rechargeable battery.
 - the recorder is connected to a computer.
 - a menu item is being selected.
 - a track is being selected directly,
 - the recorder is searching for a track.
 - the recorder is fast forwarding, fast rewinding, or using AMS.
 - the Divide Rehearsal function is being performed.
 - messages are displayed.
 - the A-B Repeat play is being set.
- If the battery power grows weak during recording (battery level indication shows ) , the display window darkens to conserve battery power.

Storing the settings for individual discs (Disc Memory)

The recorder is factory set to automatically store settings for each disc. The recorder automatically stores the settings for a disc and retrieves them whenever the disc is inserted.

The following setting can be stored:

- Bookmark
- “Custom 1” and “Custom 2” settings of 6-Band Equalizer (for models except European models)

You can check the setting as follows.

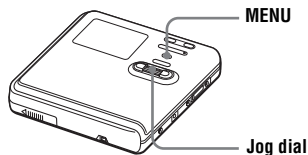

1 Remove the disc from the recorder, enter the menu and select “Option” - “Disc Memory”.

2 Turn the jog dial to select “On”, and then press the jog dial to enter the selection.

To set the recorder so that disc settings are not stored

Select “Off” in step 2.

Erasing the disc information

1 Insert the disc whose information is to be erased and verify its contents.

2 Select “1MemoryErase” in step 2.
The disc information is erased.

Notes

- Settings for up to 64 discs can be stored. Any settings stored afterwards will replace the settings with the lowest frequency of use among the 64. The numbers of discs that can be stored depend on the numbers of tracks recorded on the discs. More tracks recorded per disc means fewer discs can be stored.
- If you try to erase the disc information of a disc that have never been stored, “NO DISC MEMORY” appears in the display for a few seconds.

Starting the playback quickly (Quick Mode)

The recorder is factory set to quickly start playback after the playback button is pressed.

You can check the setting as follows.

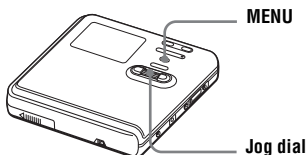

1 While the recorder is stopped or playing, enter the menu and select “Option” - “Quick Mode”.

2 Turn the jog dial to select “On”, and then press the jog dial to enter the selection.

If you will not use the recorder for a long time

Select “Off” in step 2.

You can minimize battery drain while the recorder is not being used.

Note

When “Quick Mode” is set to “On”, power continues to flow in the recorder even when it is not being operated. The power is automatically cut off when the batteries become drained.

Selecting the disc mode (Disc Mode)

When you insert a 60/74/80-minute standard disc (blank) into the recorder, you can use this function to specify use of the disc in Hi-MD mode or MD mode. When recording on this recorder without using a computer, set “Disc Mode” to “Hi-MD”. Recording is not possible if “Disc Mode” is set to “MD”. To allow a disc recorded on this recorder to be used on another component that does not support Hi-MD, set “Disc Mode” to “MD” and use a computer to record in MD mode (refer to the “Software Operation” section).

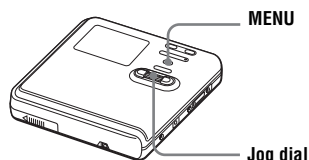

- 1 Enter the menu and select “Option” - “Disc Mode”.
- 2 Turn the jog dial until “Hi-MD” (factory setting) or “MD” appears in the display, and then press the dial to enter the selection.

Notes

- Even if you select “MD” as the “Disc Mode” setting, the operation mode can only be “Hi-MD” when using a 1GB Hi-MD disc.
- The operation mode set in the “Disc Mode” menu is applied to a blank 60/74/80-minute standard disc used on the recorder even if a different operation mode was selected in the SonicStage software or a different operation mode appeared on the display after the disc was formatted by the SonicStage software.

Changing the operational direction of the display

When you turn the jog dial downward, the display scrolls downward. This is the factory setting. You can change the factory setting to scroll in the opposite direction.

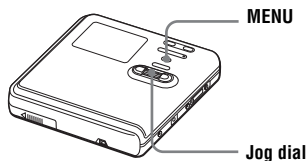

- 1 Enter the menu and select “Option” - “Jog Dial”.
- 2 Turn the jog dial to select “Reverse”, and then press the jog dial to enter the selection.

To turn the setting to normal

Select “Default” in step 2.

Selecting the display language

You can select the language used in the display window.

The languages available will depend on model that you purchased.

For the European and North American models

English (factory setting), French, German, Italian and Spanish

For the Asian, African, Australian and tourist models

Japanese, English (factory setting), French, German, Italian, Spanish, Traditional Chinese and Simplified Chinese

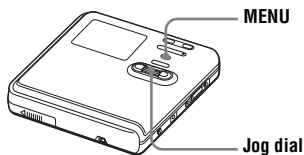

- 1** Enter the menu and select “Option” - “Language”.
- 2** Turn the jog dial to select the desired language, and then press the jog dial to enter the selection.

What you can do through connection with a computer

To use the recorder connected to a computer, you must install the software from the supplied CD-ROM. For details on the installation procedure, refer to the “Software Operation” section.

When using the supplied software

For detailed explanations, see the “Software Operation” section or online help.

- **Transfer audio data between the computer and the recorder**

The supplied SonicStage software enables you to transfer audio data between the recorder and the computer. When a disc used in Hi-MD mode is inserted in the recorder, tracks recorded with a microphone or from a CD player to the recorder can also be migrated to your computer.

- **Record directly from a CD to an MD**

The supplied MD Simple Burner software enables you to record a CD in the computer’s CD drive directly to a disc in the recorder.

When using the disc in the recorder as a storage device

When a disc used in Hi-MD mode is inserted in the recorder, the recorder appears in the Windows Explorer as an external drive, allowing you to transfer non-audio data such as text and image files. For details, refer to “Storing non-audio data to a disc” (page 64).



If you play audio files using the software, the sound is output from the computer speakers when a disc used in Hi-MD mode is inserted, and from the earphones connected to the recorder when a disc used in MD mode is inserted in the recorder.

Charging the rechargeable battery of the recorder

You can charge the rechargeable battery while the recorder is connected to a computer (using USB bus power). When you connect the recorder to the computer, power (bus power) from the computer begins to charge the recorder’s rechargeable battery. However, this charge is only provisional and cannot be used to fully charge the rechargeable battery. For example, if you charge a completely drained rechargeable battery in this way, the recorder will stop charging after about 6 hours, and will reach about half of its full capacity. The charging time may vary according to the condition of the rechargeable battery and the surrounding temperature.

Display window while USB bus power charging

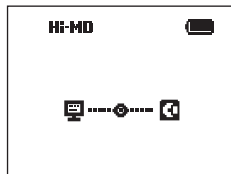

Note

Charging by USB bus power charge is not possible when the battery level indication () is flashing in the display.

- Reinsert the rechargeable battery and close the battery compartment lid firmly.
- The temperature of the battery-charging location is too low or too high. The rechargeable battery should be charged within a temperature range of +5°C (+41°F) to +35°C (+95°F).

Connecting the recorder to your computer

When you connect the dedicated USB cable directly to the USB connecting jack on the recorder, power (bus power) is supplied from the USB port of the computer. This allows the recorder to be used without power being supplied from the battery.

Note

When using Windows ME or Windows 98SE

- If you connect the recorder to the computer with the disc mode on the recorder set to "Hi-MD" (factory setting), and then insert a 60/74/80-minute standard disc, the operation mode of the disc may automatically change to Hi-MD mode even if you do not record anything.
- When you disconnect the dedicated USB cable, the message "Unsafe Removal of Device" appears in the computer display. This is not a problem. Merely click "OK" to make the message disappear.

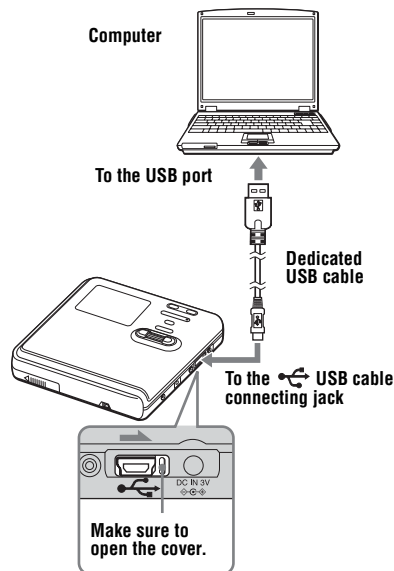

- 1 Insert a recordable disc into the recorder.
- 2 Make sure the recorder is stopped and HOLD is released.
- 3 Open the cover of the USB connecting jack on the recorder and connect the dedicated USB cable to the recorder and to the computer.
- 4 Check the connections.
When the connections have been properly made, "Hi-MD" appears in the display.

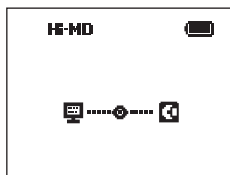

When you unplug the dedicated USB cable from the computer or remove the disc from the recorder

Be sure to remove the recorder or the disc as follows. If not, damage to the data may occur.

- 1 Make sure that the "REC" indication is not displayed in the display window of the recorder.
- 2 Press **■** on the recorder. "EJECT DISC OK" appears in the display. Depending on the conditions, it may take some time until "EJECT DISC OK" appears in the display.
- 3 Unplug the dedicated USB cable from the computer or remove the disc from the recorder.

Notes

- If you use the recorder connected to the computer, it is recommended that you insert a fully charged rechargeable battery as a precaution against power failures, disconnection of the dedicated USB cable or other unforeseen occurrences. We do not assure the results should there be a misoperation, transfer failures, or destruction of audio data caused by unforeseen occurrences.
- If you disconnect the dedicated USB cable from the recorder and want to reconnect it, make sure to wait at least 2 seconds before connecting it again.
- Make sure to place the recorder at a stable, vibration-free place during recording.
- Make sure not to connect the recorder to your computer during recording or playing.
- The system may malfunction if your computer changes to system suspend, sleep, or hibernation mode while connecting to the recorder. Make sure to disable any changes to suspend, sleep, or hibernation mode.
- Make sure not to connect the recorder and the computer through a USB hub.
- When the recorder is connected to a computer, power (bus power) is supplied to the recorder through the computer's USB port. If the computer (a laptop PC, for example) is operating on battery power, this connection may cause the computer's battery to drain. It is thus recommended to use the computer with an AC power adaptor.
- We do not ensure trouble-free operation on all computers that satisfy the system requirements.

Storing non-audio data to a disc

If you connect the recorder to a computer with a disc in Hi-MD mode inserted, the disc is recognized as storage media by the Windows Explorer, allowing you to store non-audio data such as text data or image data.

For the storage space for each disc, refer to the page 66.

When you insert a disc in Hi-MD mode into the recorder and make connection with the computer, the recorder is recognized as an external device and can be viewed on the Windows Explorer. You can use the recorder in the same way as other devices.



You can view non-audio data stored on a disc in the display window of the recorder. For details, refer to “Viewing non-audio data stored on the disc in the display window of the recorder (File List)” (page 65).

Notes

- When the SonicStage software is active, the recorder is not recognized as a data storage device.
- If you format a disc on the computer, make sure to format the disc using the SonicStage software.
- Make sure not to delete the file management folder (HMDHIFI folder and HI-MD.IND file) on the Windows Explorer.

Viewing non-audio data stored on the disc in the display window of the recorder (File List)

When using a disc in Hi-MD mode, you can view non-audio data stored on the disc in the display window of the recorder. The name and size of files are displayed.

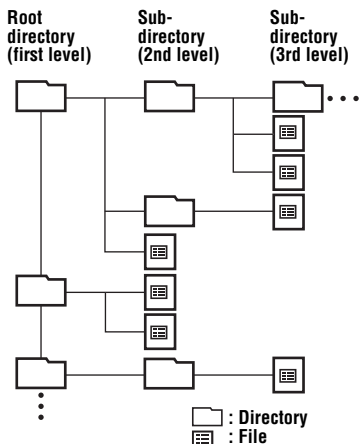

- Up to 16 levels of directories can be viewed.
- Up to 512 files or folders can be viewed in a root directory in the order saved.
- Up to 1,024 files or folders can be viewed in each sub-directory.

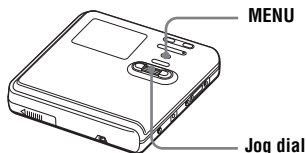

- 1 While the recorder is stopped, enter the menu and select "File List".

The root directories appear in the order saved.

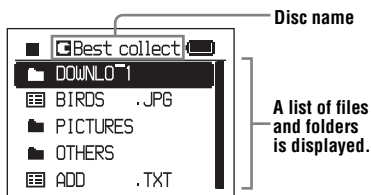

- 2 Turn the jog dial to select the file you want to confirm, and then press the jog dial to enter the selection.

File size appears.

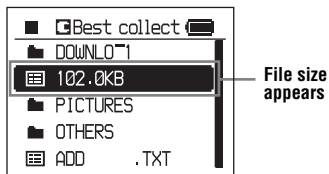

If you want to go deeper, select the folder containing the file you want to check, and then press the jog dial. A list of files and folders in the selected folder appears in the display. Afterwards, perform the operation in step 2 again.

Notes

- This function cannot be used to open files.
- Text containing characters that are not supported by the recorder will not be displayed correctly.
- File or directory names more than 9 characters long will be shortened.
- If you select "File List" while playing or recording a track, "CANNOT SET" appears in the display and no list will appear.

The storage space for each disc (formatted with the recorder/the SonicStage software)

Disc type	Total size	Disc management space ¹⁾²⁾	Free space
60-minute standard disc	219 MB (229,965,824 bytes)	832 KB (851,968 bytes)	218 MB (229,113,856 bytes)
74-minute standard disc	270 MB (283,312,128 bytes)	832 KB (851,968 bytes)	269 MB (282,460,160 bytes)
80-minute standard disc	291 MB (305,856,512 bytes)	832 KB (851,968 bytes)	290 MB (305,004,544 bytes)
1GB Hi-MD disc	964 MB (1,011,613,696 bytes)	832 KB (851,968 bytes)	963 MB (1,010,761,728 bytes)

¹⁾ This is space that is used for managing the files on the disc.

²⁾ The size of the disc management space changes according to the operating conditions of your computer and other factors. Therefore, the actual space available for use may be lower than that displayed by Windows Explorer.

Precautions

On safety

Do not put any foreign objects in the DC IN 3V jack.

On power sources

- Use house current, nickel metal hydride rechargeable battery, or LR6 (size AA) battery.
- For use in your house: Use the AC power adaptor supplied with this recorder. Do not use any other AC power adaptor since it may cause the recorder to malfunction.

Polarity of the plug



- Connect the AC power adaptor to an easily accessible AC outlet. Should you notice an abnormality in the AC power adaptor, disconnect it from the AC outlet immediately.
- The recorder is not disconnected from the AC power source (mains) as long as it is connected to the wall outlet, even if the recorder itself has been turned off.
- If you are not going to use this recorder for a long time, be sure to disconnect the power supply (AC power adaptor, dry battery, or rechargeable battery). To remove the AC power adaptor from the wall outlet, grasp the adaptor plug itself; never pull the cord.

On heat build-up

Heat may build up in the recorder if it is used for an extended period of time. This, however, is not a malfunction.

On installation

- If you use the recorder at a place subject to static or electrical noise, the recording may not be properly done or the recorded data may be lost. If you perform a transfer operation at such a place, the track's transfer authorization may be lost.
- Never use the recorder where it will be subjected to extremes of light, temperature, moisture or vibration.

- Never wrap the recorder in anything when it is being used with the AC power adaptor. Heat build-up in the recorder may cause malfunction or damage.

On the earphones

Road safety

Do not use earphones while driving, cycling, or operating any motorized vehicle. It may create a traffic hazard and is illegal in many areas. It can also be potentially dangerous to play your recorder at high volume while walking, especially at pedestrian crossings. You should exercise extreme caution or discontinue use in potentially hazardous situations.

Preventing hearing damage

Avoid using earphones at high volume. Hearing experts advise against continuous, loud and extended play. If you experience a ringing in your ears, reduce the volume or discontinue use.

Caring for others

Keep the volume at a moderate level. This will allow you to hear outside sounds and to be considerate of the people around you.

On the remote control

The supplied remote control is designed for use with this recorder only. The recorder cannot be operated with a remote control that was supplied with another device.

On charging

- Do not charge any other battery beside the supplied one or the one designated for it (NH-14WM).
- Be sure to use the supplied AC power adaptor.
- Charge the rechargeable battery at a temperature of +5°C (+41°F) to +35°C (+95°F).
- The recorder may become hot during the charging procedure; this, however poses no danger.
- Because of the battery's characteristics, the capacity of the rechargeable battery may be smaller than normal when it is used for the first time or after a long period of disuse. In this case, charge and discharge the battery several times. The normal battery life will be restored.

- If the capacity of the rechargeable battery drops to half the normal amount, replace with the new one.
- If the recorder will be unused for a long time, remove the rechargeable battery and remove the AC power adaptor from the wall outlet.

On the dry battery case

The supplied dry battery case is designated for this recorder only.

On the MiniDisc cartridge

- When carrying or storing the MiniDisc, keep it in its case.
- Do not break open the shutter.
- Do not place the cartridge where it will be subject to light, extreme temperatures, moisture or dust.
- Attach the supplied disc label only in the space designated for it on the disc. Do not stick it on any other disc surface.

On cleaning

- Clean the recorder casing with a soft cloth slightly moistened with water or a mild detergent solution. Do not use any type of abrasive pad, scouring powder or solvent such as alcohol or benzene as it may mar the finish of the casing.
- Wipe the disc cartridge with a dry cloth to remove dirt.
- Dust on the lens may prevent the unit from operating properly. Be sure to close the disc compartment lid after inserting or ejecting a disc.
- To obtain the best sound quality, use a dry cloth to wipe the plugs of the earphones or the remote control. Dirty plugs may cause sound distortion or intermittent breaks in the sound.

On batteries

Incorrect battery usage may lead to leakage of battery fluid or bursting battery. To prevent such accidents, observe the following precautions:

- Install the + and – poles of the batteries correctly.
- When the recorder is not to be used for a long time, be sure to remove the batteries.

- If a battery leak should develop, carefully and thoroughly wipe away battery fluid from the battery compartment before inserting new ones.

On mechanical noise

The recorder gives off mechanical noise while operating, which is caused by the power-saving system of the recorder and it is not a problem.

To protect a recorded disc

To record-protect a disc, slide open the tab at the side of the disc. In this position, the disc cannot be recorded. To record again, slide the tab back so the tab is visible.

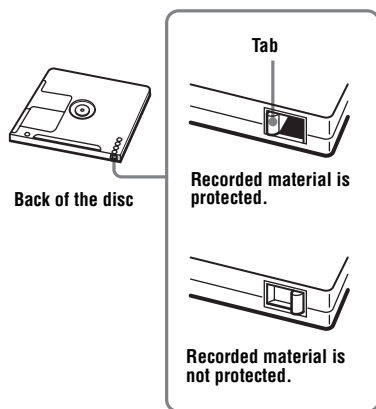

On maintenance

Clean the terminals periodically with a cotton swab or a soft cloth.

If you have any questions or problems concerning your recorder, please consult your nearest Sony dealer. (If a trouble occurred when the disc was in the recorder, we recommend that the disc be left in the recorder when you consult your Sony dealer so that the cause of trouble may be better understood.)

Specifications

Audio playing system

MiniDisc digital audio system

Laser diode properties

Material: GaAlAs

Wavelength: $\lambda = 790$ nm

Emission duration: continuous

Laser output: less than 44.6 μ W

(This output is the value measured at a distance of 200 mm from the lens surface on the optical pick-up block with 7 mm aperture.)

Recording and playback time

See "List of the recording time for each disc" (page 85).

Revolutions

350 rpm to 3,000 rpm (CLV)

Error correction

Hi-MD:

LDC (Long Distance Code)/BIS (Burst Indicator Subcode)

MD:

ACIRC (Advanced Cross Interleave Reed Solomon Code)

Sampling frequency

44.1 kHz

Sampling rate converter

Optical (digital) input: 32 kHz/44.1 kHz/
48 kHz

Audio formats supported by this recorder

Recording:

Linear PCM (44.1 kHz/16 bit)
ATRAC3plus (Adaptive TRansform
Acoustic Coding 3 plus) (Hi-SP/Hi-LP)

Playback:

Linear PCM
ATRAC3plus
ATRAC3
ATRAC
MP3 (MPEG-1 Audio Layer-3/Sampling
frequency 44.1 kHz/Bit rate 32 - 320 kbps
(constant/variable bit rate))

Modulation system

Hi-MD:

1-7RLL (Run Length Limited)/PRML
(Partial Response Maximum Likelihood)

MD:

EFM (Eight to Fourteen Modulation)

Frequency response

20 to 20,000 Hz \pm 3 dB

Inputs¹⁾

MIC: stereo mini-jack
(minimum input level 0.13 mV)

Line in:

stereo mini-jack for analog input
(minimum input level 49 mV)
optical (digital) mini-jack for optical
(digital) input

Outputs

 stereo mini-jack (dedicated remote control jack)

Maximum output (DC)

Headphones:

2.8 mW + 2.8 mW (16 Ω) (European
models)
5 mW + 5 mW (16 Ω) (Other models)

Power requirements

Sony AC Power Adaptor connected at the DC
IN 3V jack:

120 V AC, 60 Hz (Models for USA, Canada,
Mexico and Taiwan)
240 V AC, 50 Hz (Model for Australia)
220 V AC, 50 Hz (Models for China and
Argentina)
100 - 240 V AC, 50/60 Hz (Other models)

The recorder:

Nickel metal hydride rechargeable battery
NH-14WM 1.2V 1,350 mAh (MIN) Ni-MH
LR6 (size AA) alkaline battery
AC power adaptor DC 3V

Operating temperature

+5°C (+41°F) to +35°C (+95°F)

Battery operation time²⁾

See "Battery life" (page 20)

Dimensions

Approx. 80.2 \times 18.9 \times 84.1 mm (w/h/d)
(3¹/₄ \times 3³/₈ \times 3³/₈ in.) (excluding projecting parts
and controls)

Mass

Approx. 120 g (4.2 oz) (the recorder only)
Approx. 147 g (5.2 oz) (including the
rechargeable battery)

¹⁾The LINE IN (OPT) jack is used to connect
either a digital (optical) cable or a line
(analog) cable.

²⁾Measured in accordance with JEITA.

US and foreign patents licensed from Dolby
Laboratories.

Design and specifications are subject to change
without notice.

Optional accessories

Optical Cable

POC-15B, POC-15AB

Line Cable

RK-G129, RK-G136

Stereo Microphones

ECM-MS907, ECM-MS957

MDR-series Stereo headphones/earphones*

SRS-series Active Speakers

Recordable MDs MDW-series

Recordable Hi-MD disc

HMD1G

Nickel metal hydride rechargeable battery

NH-14WM

Your dealer may not handle some of the above listed accessories. Please ask the dealer for detailed information about the accessories in your country.

* When using optional headphones, use only headphones/earphones with stereo mini plugs. You cannot use headphones/earphones with micro plugs.

Troubleshooting

If a problem occurs during recorder operation, follow the steps described below before consulting the nearest Sony dealer. If any messages appear, it is recommended to take notes.

- 1 Check to see if the problem is listed in, “Troubleshooting” (page 71).
Check “Messages” (page 79) for the problem as well.
- 2 If after step 1 you still cannot solve the problem, consult your nearest Sony dealer.

While charging

Symptom	Cause/Remedy
The rechargeable battery does not start charging. The rechargeable battery cannot be fully charged.	<ul style="list-style-type: none">• The rechargeable battery has been inserted incorrectly or the AC power adaptor has been connected incorrectly. ➔ Insert the rechargeable battery correctly or connect the AC power adaptor correctly.• Because of the battery’s characteristics, the capacity of the rechargeable battery may be smaller than normal when it is used for the first time or after a long period of disuse. ➔ Charge and discharge the battery several times. The normal battery life will be restored.• The surrounding temperature is too high or too low. ➔ Charge the battery at a temperature of +5°C (+41°F) to +35°C (+95°F).• You charged the rechargeable battery using USB bus power. ➔ USB bus power charging is only provisional and cannot be used to fully charge the rechargeable battery. Disconnect the recorder from the computer and charge the rechargeable battery with the AC power adaptor.
The rechargeable battery has become drained even when the recorder was not used for a while.	<ul style="list-style-type: none">• The Quick mode was set to “On”. ➔ If you set the Quick mode to “On”, the power stays on inside recorder even when there is no operation, causing the rechargeable battery life to shorten (page 59). If the rechargeable battery is not fully charged, the battery may become drained after a while. If this happens, charge the rechargeable battery again (page 17).
Even when fully charged, the life of the battery is only about half what it normally is.	<ul style="list-style-type: none">• The useful life of the rechargeable battery may be ending. ➔ Replace the rechargeable battery with the new one.
The recorder become hot during the charging procedure.	<ul style="list-style-type: none">• This is normal and poses no danger.

While recording

Symptom	Cause/Remedy
“NOT ENOUGH POWER TO REC” appears and recording cannot be done on a 1GB Hi-MD disc.	<ul style="list-style-type: none"> Recording is not possible when using a 1GB Hi-MD disc even when the battery level indication shows enough power remaining while the recorder is stopped or playing. This is because of a mechanism that disables recording when the remaining battery power is estimated by the recorder to be insufficient due to the high power consumption required for 1GB Hi-MD disc recording. <ul style="list-style-type: none"> ➔ Connect the AC power adaptor to the recorder or insert a fully charged rechargeable battery or a new alkaline dry battery.
The remaining recording time appears as “-00:00” and recording cannot be done, even though 2.0MB of free space is displayed.	<ul style="list-style-type: none"> This is a system limitation. 2.0MB is the capacity of the reserve domain.
The recorder always creates a new group when recording.	<ul style="list-style-type: none"> The group recording (“Group REC”) is set to “On”. (You cannot overwrite tracks.) <ul style="list-style-type: none"> ➔ Set the group recording setting to “Off” (page 37).
The first few seconds of a track cannot be recorded.	<ul style="list-style-type: none"> If you start recording before the ■ indication appears in the display, data will not be recorded to the first few seconds of the first track. <ul style="list-style-type: none"> ➔ Wait until the ■ indication appears before you start recording.
Recording cannot be done correctly.	<ul style="list-style-type: none"> You tried to record in MD mode on this recorder. <ul style="list-style-type: none"> ➔ Only Hi-MD mode can be used to record directly on this recorder without using a computer. To record in MD mode, connect the recorder to a computer and use the supplied software (pages 22 and 30). Audio sources may not be securely connected. <ul style="list-style-type: none"> ➔ Disconnect the audio sources once and connect them again (pages 21 and 34). There is no digital signal from the portable CD player. <ul style="list-style-type: none"> ➔ When recording digitally from a portable CD player, use the AC power adaptor and disable the anti-skip function (such as ESP) on the CD player. The analog recording was made using a connecting cord with an attenuator. <ul style="list-style-type: none"> ➔ Use a connecting cord without an attenuator. Recording level is too small to record (when adjusting the recording level manually). <ul style="list-style-type: none"> ➔ Pause the recorder and adjust the recording level (page 35). The recorder is connected to the computer. <ul style="list-style-type: none"> ➔ Disconnect the recorder from the computer when recording. The power sources was disconnected or a power outage occurred during recording. <ul style="list-style-type: none"> ➔ The recording result is not recorded on the disc. Make recording again.

Symptom	Cause/Remedy
Recording cannot be done correctly.	<ul style="list-style-type: none"> Recording may not be done if the remaining recordable time on the disc is 48 seconds or less (“DISC FULL” appears). ➔ Replace the disc.
The lid does not open after recording.	<ul style="list-style-type: none"> The lid does not open until “SYSTEM FILE WRITING” disappears in the display.
“TRACK FULL” appears even before the disc has reached the maximum recording time and the recording cannot be done.	<ul style="list-style-type: none"> This is due to the MiniDisc system limitation. When 2,047 tracks (on a disc used in Hi-MD mode) have been recorded on the disc, “TRACK FULL” appears regardless of the total recorded time. More than 2,047 tracks cannot be recorded on the disc. ➔ To continue recording, erase unnecessary tracks.
The remaining recording time does not increase even after erasing numerous short tracks.	<ul style="list-style-type: none"> This is due to the MiniDisc system limitation (in MD mode only). Tracks of under 12 seconds (in SP mode), 24 seconds (in LP2 mode or monaural), or 48 seconds (in LP4 mode) in length are not counted and so erasing them may not lead to an increase in the recording time.
The total recorded time and the remaining time on the disc may not total the maximum recording time (60, 74, or 80 minutes).	<ul style="list-style-type: none"> This is due to the MiniDisc system limitation (in MD mode only). Normally, recording is done in minimum units of approximately 2 seconds (in SP mode), 4 seconds (in LP2 mode or monaural), or 8 seconds (in LP4 mode). When recording is stopped, the last unit of recording always uses this unit of 2 seconds, 4 seconds, or 8 seconds even if the actual recording is shorter. Likewise, when recording is restarted after the stop, the recorder will automatically insert a blank space amounting to 2 seconds, 4 seconds, or 8 seconds before the next recording. (This is to prevent accidental erasing of a previous track whenever a new recording is started). Therefore, the actual recording time will decrease whenever a recording is stopped by a maximum of 6 seconds, 12 seconds, or 24 seconds.
“TRACK FULL” appears even before the disc has reached the maximum track number or recording time.	<ul style="list-style-type: none"> This is due to the MiniDisc system limitation. Repeated recording and erasing may cause fragmentation and scattering of data. Although those scattered data can be read, each fragment is counted as a track. In this case, the number of tracks may reach 2,047 (on a disc used in Hi-MD mode) and further recording is not possible. ➔ To continue recording, erase unnecessary tracks.

While playing

Symptom	Cause/Remedy
A disc is not played normally.	<ul style="list-style-type: none"> Repeat play is selected. ➔ Set the Repeat play to “Off” to change back to the normal play (page 42). Playback mode is changed. ➔ Enter the Main play mode or Sub play mode to change back to the normal play (page 40).
A disc is not played from the first track.	<ul style="list-style-type: none"> Disc playing stopped before it came to the last track. ➔ Press the jog dial (▶/ENT) on the recorder or press ▶ on the remote control for 2 seconds or more to start playing.

Symptom	Cause/Remedy
Playback sound skips.	<ul style="list-style-type: none"> The recorder is placed where it receives continuous vibration. <ul style="list-style-type: none"> ➔ Put the recorder on a stable place. A very short track may cause sound to skip. <ul style="list-style-type: none"> ➔ Try not to create a short track.
Momentary noise is heard.	<ul style="list-style-type: none"> Due to the special digital audio compression technology used in LP4 mode, momentary noise may occur on very rare occasions with certain sound sources.
Sound has a lot of static.	<ul style="list-style-type: none"> Strong magnetism from a television or such device is interfering with operation. <ul style="list-style-type: none"> ➔ Move the recorder away from the source of strong magnetism.
The volume of the recorded track is low.	<ul style="list-style-type: none"> The track was recorded in analog mode (in digital mode, the recording level is automatically set to the same level as that of the sound source). Or you used a connecting cord with an attenuator. <ul style="list-style-type: none"> ➔ Use a correct connecting cord without an attenuator. The recording level was low. <ul style="list-style-type: none"> ➔ Adjust the recording level manually while recording (page 35).
Volume cannot be turned up.	<ul style="list-style-type: none"> AVLS is on. <ul style="list-style-type: none"> ➔ Release the AVLS settings (page 57).
No sound comes through the earphones.	<ul style="list-style-type: none"> The earphones plug is not firmly connected. <ul style="list-style-type: none"> ➔ Plug in the plug of the earphones firmly to the remote control. Plug in the plug of the remote control firmly to the  jack. The plug is dirty. <ul style="list-style-type: none"> ➔ Clean the plug.
The disc cannot be played on another component.	<ul style="list-style-type: none"> The component does not support Hi-MD. <ul style="list-style-type: none"> ➔ Discs recorded on this recorder can be played only on components that support Hi-MD.
The edited tracks may exhibit sound dropout during search operations.	<ul style="list-style-type: none"> This occurs due to the MiniDisc system limitation. The fragmentation of data may cause sound dropout while searching because the tracks are played in higher speed than normal playback.
There is no R-channel sound output when playing a track recorded from a cassette deck or through an amplifier, or when listening to sound from a cassette deck or amplifier.	<ul style="list-style-type: none"> There is no R-channel output if the cassette deck or an amplifier is connected with a monaural cord. <ul style="list-style-type: none"> ➔ Make sure to use a stereo connecting cord. If, however, the connected equipment is monaural, there will be no R-channel sound output even with a stereo connecting cord.
The recorder cannot play MP3 tracks.	<ul style="list-style-type: none"> You tried to play an MP3 track with a format not supported by this recorder. <ul style="list-style-type: none"> ➔ This recorder only supports MP3 tracks (MPEG-1 Audio Layer-3/Sampling frequency 44.1 kHz) that have been transferred using the SonicStage software.
“R” appears in the display window during playback.	<ul style="list-style-type: none"> “R” appears when the contents of an editing operation performed during recorder playback are ready to be written to the disc. <ul style="list-style-type: none"> ➔ When playback on the recorder is stopped, the edited contents are written to the disc and the “R” disappears.

While editing

Symptom	Cause/Remedy
“NOT ENOUGH POWER TO EDIT” appears and editing cannot be done on a 1GB Hi-MD disc.	<ul style="list-style-type: none"> Editing is not possible when using a 1GB Hi-MD disc even when the battery level indication shows enough power remaining while the recorder is stopped or playing. This is because of a mechanism that disables editing when the remaining battery power is estimated by the recorder to be insufficient due to the high power consumption required for 1GB Hi-MD disc editing. <ul style="list-style-type: none"> ➔ Connect the AC power adaptor to the recorder or insert a fully charged rechargeable battery or a new alkaline dry battery.
The lid does not open.	<ul style="list-style-type: none"> The recorder is saving the contents of an editing operation. The lid will not open until “SYSTEM FILE WRITING” disappears from the display.
Editing cannot be done.	<ul style="list-style-type: none"> The power source has been disconnected or a power outage has occurred during editing. <ul style="list-style-type: none"> ➔ The editing done to that point is not saved to the disc. Do the editing operation again.
Non-audio data cannot be erased.	<ul style="list-style-type: none"> Non-audio data cannot be erased with the Erase function. <ul style="list-style-type: none"> ➔ Confirm the contents by connecting the recorder to your computer. If it is okay to delete the contents, then perform the Format function (page 56).
Tracks cannot be combined.	<ul style="list-style-type: none"> This is due to the MiniDisc system limitations. When the tracks are scattered and the length of each track is short*, you may not be able to combine the tracks. <ul style="list-style-type: none"> * Combining tracks of the following lengths may not be possible. <ul style="list-style-type: none"> Hi-MD mode <ul style="list-style-type: none"> Linear PCM: 9 seconds or less Hi-SP: 8 seconds or less Hi-LP: 32 seconds or less MD mode <ul style="list-style-type: none"> SP: 12 seconds or less LP2/Monaural: 24 seconds or less LP4: 48 seconds or less You cannot combine tracks recorded in different recording modes, e.g., a track recorded in stereo and a track recorded in monaural; nor can you combine a track recorded with digital connection and a track recorded with analog connection.
The disc cannot edit on other component.	<ul style="list-style-type: none"> The component does not support Hi-MD. <ul style="list-style-type: none"> ➔ Edit on other component that support Hi-MD.

While using group function

Symptom	Cause/Remedy
The group function does not operate.	<ul style="list-style-type: none"> While using a disc without group setting, an attempt was made to select some group-related menu. <ul style="list-style-type: none"> ➔ Use a disc with group setting.

Symptom	Cause/Remedy
A new group cannot be created.	<ul style="list-style-type: none"> This is due to the MiniDisc system limitations (in MD mode only). Group information has been written to the area where the disc name is stored. The disc name and track names are recorded in the same area, which can store a maximum of approximately 1,700 characters. If the total number exceeds this amount, it is impossible to make group settings.

While the recorder is connected to the computer

Symptom	Cause/Remedy
The recorder is not recognized by the computer.	<ul style="list-style-type: none"> The dedicated USB cable is not firmly connected. <ul style="list-style-type: none"> ➔ Connect the dedicated USB cable firmly to the recorder and the computer. A USB hub is used. <ul style="list-style-type: none"> ➔ Connect the dedicated USB cable directly to the USB port of the computer. Network communication has failed. <ul style="list-style-type: none"> ➔ Disconnect the dedicated USB cable, wait at least 2 seconds, and then reconnect it. If the recorder is still not recognized, disconnect the dedicated USB cable, restart the computer, and then connect the dedicated USB cable again. When using Windows 2000 Professional, you turned on or restarted the computer while the dedicated USB cable was connected, and then disconnected it afterwards. <ul style="list-style-type: none"> ➔ Disconnect the dedicated USB cable, restart the computer, and then reconnect the dedicated USB cable. This problem may be resolved by updating your Windows operating system so that it contains all the latest features.
Charging by USB bus power cannot be done (🔋 flashes in the display).	<ul style="list-style-type: none"> The battery compartment lid is not firmly closed. <ul style="list-style-type: none"> ➔ Reinsert the rechargeable battery and close the battery compartment lid firmly. The temperature of the battery-charging location is too low or too high. <ul style="list-style-type: none"> ➔ Charge the rechargeable battery within a temperature range of +5°C (+41°F) to +35°C (+95°F).
The rechargeable battery cannot be charged sufficiently through USB bus power.	<ul style="list-style-type: none"> The rechargeable battery is charged through USB bus power. <ul style="list-style-type: none"> ➔ USB bus power only charges temporary and cannot charge the rechargeable battery sufficiently. Disconnect the recorder from the computer and charge the rechargeable battery using the AC power adaptor.
Even though the recorder is recognized by the computer, it does not operate normally.	<ul style="list-style-type: none"> A USB hub is used. <ul style="list-style-type: none"> ➔ Connect the dedicated USB cable directly to the USB port of the computer. You are using the recorder at a place with vibration. <ul style="list-style-type: none"> ➔ Use the recorder at a place with no vibration.

Symptom	Cause/Remedy
The recorder cannot be used as a storage device.	<ul style="list-style-type: none"> The SonicStage or MD Simple Burner software is active. <ul style="list-style-type: none"> ➔ Close the SonicStage or MD Simple Burner software. A disc which is not used in Hi-MD mode is inserted. <ul style="list-style-type: none"> ➔ Insert a disc used in Hi-MD mode. Only discs used in Hi-MD mode can be used as a storage media.
The playing time of a transferred track is different from the time that appears on your computer monitor.	This is due to a calculation discrepancy between the recorder and the computer.
You cannot transfer tracks that will fill up the remaining recording time on the disc.	<ul style="list-style-type: none"> The minimum recordable time on a disc is normally 2 seconds in SP mode, 4 seconds in LP2 mode, and 8 seconds in LP4 mode. When you transfer a track from your computer, the recorder needs a 2-second (or 4- or 8-second) space for a track even if the track is under 2 seconds (or 4 or 8 seconds) in length. Also, the recorder inserts a 2-second (or 4 -or 8-second) space in between tracks during transfer operation. For this reason, the recorder needs an additional 6 seconds (or 12 or 24 seconds) for each track. This reduces the maximum recording time for each track by 6 seconds (or 12 or 24 seconds) during transfer operation (in MD mode only).
The disc size displayed on the computer is not the same as the disc size printed on the disc.	<ul style="list-style-type: none"> The difference is due to the use of the binary system to indicate the disc size on the computer and the decimal system to express the disc size on the disc and other recording media. For details on the disc size, see page 66.
You cannot operate the recorder.	<ul style="list-style-type: none"> You cannot operate the recorder while the recorder is connected to the computer.
The lid does not open.	<ul style="list-style-type: none"> It happens if you disconnect the dedicated USB cable in the middle of a data transfer, recording, or editing operation on the computer, but while the rechargeable battery is missing from the recorder or is drained. <ul style="list-style-type: none"> ➔ Reconnect the dedicated USB cable or insert a fully charged rechargeable battery into the recorder, and then press ■.

Others

Symptom	Cause/Remedy
“Advanced” or “Simple” is displayed.	<ul style="list-style-type: none"> You attempted to do a menu operation for the first time after purchase of the recorder (by pressing the MENU button for 2 seconds or more). <ul style="list-style-type: none"> ➔ Select the Menu mode (page 57).
Some menu items cannot be displayed.	<ul style="list-style-type: none"> “Menu Mode” is set to “Simple”. <ul style="list-style-type: none"> ➔ Set the “Menu Mode” to “Advanced” to display all the menu items.

Symptom	Cause/Remedy
The recorder does not work or works poorly.	<ul style="list-style-type: none"> • The rechargeable battery is not charged. ➔ Charge the rechargeable battery. • The volume is low. ➔ Turn up the volume. • No disc is inserted. ➔ Insert a recorded disc. • The HOLD function is turned on (“HOLD” appears in the display when you press an operation button on the recorder). ➔ On the recorder, disable HOLD by sliding the HOLD switch to the opposite direction of the arrow (pages 14, 18). • The lid is not firmly closed. ➔ Close the lid until it clicks. Then slide OPEN to open the lid. • Moisture has condensed inside the recorder (for example, when the recorder has been brought in from a cold place to a warm place). ➔ Take the disc out and leave the recorder in a warm place for several hours until the moisture evaporates. • The AC power adaptor is not firmly connected. ➔ Connect the AC power adaptor firmly to the DC IN 3V jack on the recorder. • The rechargeable battery or dry battery is weak (“LOW BATTERY” flashes or nothing appears). ➔ Charge the rechargeable battery, replace the dry battery with a new one, or use the supplied AC power adaptor. • The disc is damaged or does not contain proper recording or editing data. ➔ Reinsert the disc. Rerecord the disc. If the error message still appears, replace it with another disc. • There is a built-in malfunction in the system. • While operating, the recorder received a mechanical shock, too much static, abnormal power voltage caused by lightning, etc. ➔ Restart the operation as follows. <ul style="list-style-type: none"> 1 Disconnect all the power sources and the dedicated USB cable. 2 Leave the recorder for about 30 seconds. 3 Connect the power source.
The display does not turn on.	<ul style="list-style-type: none"> • You tried to operate the recorder with the remote control while “EL Light” is set to “Auto Off” (page 58). ➔ Use the buttons and controls on the recorder. When “EL Light” is set to “Auto Off”, the display window turns off automatically and it does not turn on even when you operate the recorder with the remote control.
File names or folder names displayed by the File list function are different from those saved on the computer.	<ul style="list-style-type: none"> • File names and folder names that exceed the maximum display length supported by the recorder are shortened.
The file names or folder names are not correctly displayed by the File list function.	<ul style="list-style-type: none"> • The names contain characters that are not supported by the recorder.

Symptom	Cause/Remedy
The operation mode of the blank 60/74/80-minute standard disc differs from the mode following formatting or the mode selected in the SonicStage software.	<ul style="list-style-type: none"> When using a blank 60/74/80-minute standard disc in the recorder, the operation mode set in the "Disc Mode" menu is applied. <ul style="list-style-type: none"> ➔ Use the "Disc Mode" menu to change the operation mode as desired.

Messages

If the following messages flash in the display window on the recorder, check the chart below.

Message	Meaning/Remedy
AVLS NO VOLUME OPERATION	<ul style="list-style-type: none"> AVLS is set to "On" and so the volume cannot rise higher. <ul style="list-style-type: none"> ➔ Set AVLS to "Off" (page 57).
BLANKDISC	<ul style="list-style-type: none"> A disc with no recording on it is inserted.
BUSY WAIT A MOMENT	<ul style="list-style-type: none"> The recorder is accessing disc information. You tried to operate the recorder while it was accessing the recorded data. <ul style="list-style-type: none"> ➔ Wait until the message goes out (in rare cases, it may take a few minutes).
CANNOT EDIT	<ul style="list-style-type: none"> You selected, "Group Set", "GroupRelease", "Move", or "Erase" while recording. You tried to erase the track mark at the beginning of the first track or group. You tried to erase a track mark to combine tracks the recorder cannot combine (a track recorded in stereo and in mono, for example). You tried to overwrite a track marks. You tried to change a title that includes characters the recorder cannot edit. <ul style="list-style-type: none"> ➔ Editing titles cannot be done if the title includes characters that cannot be input on the recorder.
CANNOT OPERATE	<ul style="list-style-type: none"> You tried to press II or T MARK during synchro-recording.
CANNOT PLAY	<ul style="list-style-type: none"> You tried to play a track that is subject to play restrictions. You tried to play an MP3 track with a format not supported by this recorder. <ul style="list-style-type: none"> ➔ This recorder only supports MP3 tracks (MPEG-1 Audio Layer-3/ sampling frequency 44.1 kHz) that have been transferred using the SonicStage software.
CANNOT RECORD	<ul style="list-style-type: none"> You tried to record on a disc that has already been recorded in MD mode. <ul style="list-style-type: none"> ➔ On this recorder, you cannot do additional recording on a disc that is already recorded in MD mode. If you want to do additional recording on such a disc, connect the recorder to a computer and use the supplied software.

Message	Meaning/Remedy
CANNOT RECORD OR PLAY	<ul style="list-style-type: none"> • There is no audio data that can be played on the recorder. • The audio data or disc management file has been damaged. ➔ Erase the whole disc (page 53) or perform the Format function (page 56).
CANNOT SET	<ul style="list-style-type: none"> • You tried to set “Time Mark” during synchro-recording. • You selected “REC Level” while the recorder is not in recording-pause. ➔ Set “REC Level” while the recorder is in recording-pause. • You tried to make the following settings while recording. <ul style="list-style-type: none"> — Recording mode — Disc Memory — Play mode — Selection of “Group REC” in menu
Charging	<ul style="list-style-type: none"> • The rechargeable battery is being charged.
DATA SAVE	<ul style="list-style-type: none"> • The recorder is writing information to the system file, such as the recorded data or editing information. ➔ Wait until the message disappears from the display.
DC IN TOO HIGH	<ul style="list-style-type: none"> • Voltage of the power supply is too high (The supplied AC power adaptor is not used). ➔ Use the supplied AC power adaptor.
DISC FULL	<ul style="list-style-type: none"> • Recording may not be done if the remaining recordable time on the disc is 48 seconds or less. ➔ Replace the disc.
DOWNLOAD READY	<ul style="list-style-type: none"> • MD Simple Burner is now ready to record an audio CD to the disc in the recorder using Simple mode. (Refer to “Software Operation” section.)
EJECT DISC OK	<ul style="list-style-type: none"> • The recorder has finished communicating with the computer and it is safe to eject the disc from the recorder or disconnect the dedicated USB cable.
END	<ul style="list-style-type: none"> • The recorder reached to the end of the disc while playing or pressing ►►.
ERROR	<ul style="list-style-type: none"> • There is an internal malfunction in the system. ➔ Restart the operation by doing steps 1 to 3 on page 78.
ERROR XX	<ul style="list-style-type: none"> • There is an internal malfunction in the system. ➔ Restart the operation by doing steps 1 to 3 on page 78. If the message appears again, please consult your nearest Sony dealer.
FOLDER NO EXPAND	<ul style="list-style-type: none"> • You tried to use the File List function to expand a folder that is already at the 16th level. ➔ Files and folders can be expanded down to 16 levels. Expansion beyond this level is not possible.
FORMAT ERROR DISC	<ul style="list-style-type: none"> • A disc with a format that the recorder does not support was inserted. ➔ Insert a disc used in Hi-MD mode. • A disc formatted on the computer was inserted. ➔ When formatting a disc on the computer, make sure to use the SonicStage software.

Message	Meaning/Remedy
GROUP FULL	<ul style="list-style-type: none"> You tried to create a 256th group on a disc used in Hi-MD mode or 100th group on a disc used in MD mode. <ul style="list-style-type: none"> ➔ You can create only up to 255 groups (on a disc used in Hi-MD mode) or 99 groups (on a disc used in MD mode) on a disc. Keep the group number within 255 or 99.
HOLD	<ul style="list-style-type: none"> The recorder is locked. <ul style="list-style-type: none"> ➔ Slide HOLD against the arrow to unlock the recorder (page 18).
IN MENU	<ul style="list-style-type: none"> You pressed a key on the remote control while selecting a menu on the recorder.
LOW BATTERY	<ul style="list-style-type: none"> Batteries are weak. <ul style="list-style-type: none"> ➔ Charge the rechargeable battery or replace the dry battery (page 17).
MEMORY OVER	<ul style="list-style-type: none"> You tried to record with the recorder placed where it receives continuous vibration. <ul style="list-style-type: none"> ➔ Put the recorder on a stable place, and start recording again.
NO BOOKMARKED TRACK	<ul style="list-style-type: none"> You selected bookmark play without setting bookmarks. <ul style="list-style-type: none"> ➔ Set bookmarks (page 41).
NO DIGITAL COPY	<ul style="list-style-type: none"> You tried to make a copy from a disc that is protected by the Serial Copy Management System. You cannot make copies from a digitally connected source which was itself recorded using digital connection. <ul style="list-style-type: none"> ➔ Use analog connection instead (page 34).
NO DISC	<ul style="list-style-type: none"> You tried to play or record with no disc in the recorder. <ul style="list-style-type: none"> ➔ Insert a disc.
NO DISC MEMORY	<ul style="list-style-type: none"> You tried to erase a setting in the Disc Memory on a disc that contains no settings in the Disc Memory (page 58).
NO FILE	<ul style="list-style-type: none"> While viewing the file list, you selected a folder that have no folders or files
NO GROUP	<ul style="list-style-type: none"> You selected "Group Erase" with a disc without group setting. <ul style="list-style-type: none"> ➔ You cannot erase groups with a disc with no groups. You tried to release a group setting with a disc that has no groups. <ul style="list-style-type: none"> ➔ Insert a disc with group settings.
NO INPUT SIGNAL	<ul style="list-style-type: none"> The recorder could not detect digital input signals. <ul style="list-style-type: none"> ➔ Make sure that the source is connected firmly (page 21).
NON GROUPED TRACK	<ul style="list-style-type: none"> You selected "Group Move" or "Group Erase", or you tried to label a group while selecting a track that does not belong to a group. <ul style="list-style-type: none"> ➔ Select a track within a group you want to edit, and then do the editing operation again.
NOT ENOUGH POWER TO EDIT	<ul style="list-style-type: none"> You tried to edit the contents of a 1GB Hi-MD disc with insufficient battery power for editing (page 75). <ul style="list-style-type: none"> ➔ Connect the AC power adaptor to the recorder or insert a fully charged rechargeable battery or a new alkaline dry battery.
NOT ENOUGH POWER TO REC	<ul style="list-style-type: none"> You tried to record on a 1GB Hi-MD disc with insufficient battery power for recording (page 72). <ul style="list-style-type: none"> ➔ Connect the AC power adaptor to the recorder or insert a fully charged rechargeable battery or a new alkaline dry battery.

Message	Meaning/Remedy
NO TRACK	<ul style="list-style-type: none"> You tried to play a disc with no recorded tracks. ➔ Insert a recorded disc.
NO TRACK IS SELECTED	<ul style="list-style-type: none"> You selected “Track Move” or “Track Erase”, or you tried to label a track without first selecting a track. ➔ Do the editing operation again after selecting the desired track first.
P/B ONLY DISC	<ul style="list-style-type: none"> You tried to record or edit on a premastered disc (P/B stands for “playback”). ➔ Insert a recordable disc.
PROTECTED DISC	<ul style="list-style-type: none"> You tried to record or edit on a disc with the tab in the record-protect position. ➔ Slide the tab back (page 68).
PUSH STOP BUTTON	<ul style="list-style-type: none"> You tried to open the lid by sliding the OPEN switch or operate the recorder while the recorder was storing disc information with the dedicated USB cable connecting the recorder to a computer. ➔ Operation must be done only after pressing ■ and “SYSTEM FILE WRITING” has disappeared from the display.
READ ERROR	<ul style="list-style-type: none"> The recorder cannot read the disc information correctly. ➔ Reinsert the disc.
REC ERROR	<ul style="list-style-type: none"> Recording was not correctly done. ➔ Place the recorder at a place with no vibrations and record again. The disc is soiled with an oil film or finger prints, is scratched, or is not a standard disc. ➔ Try recording again with another disc.
SEARCH	<ul style="list-style-type: none"> You pressed a button or a control on the remote control while using the Search function on the recorder. ➔ Use the buttons and controls on the recorder.
SYSTEM FILE WRITING	<ul style="list-style-type: none"> The recorder is storing information (track start and end position) from the memory to the disk. ➔ Wait until this process is completed. Do not expose the player to physical shock, nor disrupt power supply.
TEMP OVER REC STOP	<ul style="list-style-type: none"> Heat has built up in the recorder. ➔ Let the recorder cool down.
TITLE FULL	<ul style="list-style-type: none"> You tried to enter characters that exceeds the maximum number for a title. <ul style="list-style-type: none"> —For the European and North American models: More than 200 characters to label a single track, group, or disc. —For the Asian, African, Australian and tourist models: More than 100 characters (in Hi-MD mode) or 200 characters (in MD mode) to label a single track, group, or disc. You tried to enter characters that exceeds the maximum number for a disc. <ul style="list-style-type: none"> —For the European and North American models: A total of more than approximately 55,000 characters (in Hi-MD mode) or 1,700 characters (in MD mode) for titles in a disc. —For the Asian, African, Australian and tourist models: A total of more than approximately 27,000 characters (in Hi-MD mode) or 1,700 characters (in MD mode) for titles in a disc.

Message	Meaning/Remedy
TOC DATA ERROR	<ul style="list-style-type: none"> • The recorder cannot read the disc information correctly. <ul style="list-style-type: none"> ➔ Insert another disc. ➔ If it is no problem to erase the entire disc, do so (page 53).
TRACK FULL	<ul style="list-style-type: none"> • You tried to record more than 2,047 tracks on a disc used in Hi-MD mode. <ul style="list-style-type: none"> ➔ Erase unnecessary tracks (page 53).
TRK FROM PC NO EDIT	<ul style="list-style-type: none"> • You tried to combine or divide tracks that were transferred from the computer. <ul style="list-style-type: none"> ➔ You cannot combine or divide transferred tracks. • You tried to combine or divide tracks that were recorded in Hi-MD mode using the MD Simple Burner software. <ul style="list-style-type: none"> ➔ You cannot combine or divide tracks recorded in Hi-MD mode with the MD Simple Burner software.
TRK FROM PC NO REC	<ul style="list-style-type: none"> • You tried to record in the middle of a protected track that has been transferred from the computer. • You tried to record in the middle of a track that was recorded in Hi-MD mode with the MD Simple Burner software. <ul style="list-style-type: none"> ➔ You cannot record new material in the middle of a protected track or a track that was recorded in Hi-MD mode with the MD Simple Burner software.

Explanations

About Hi-MD

“Hi-MD” is a new MiniDisc format.

Incorporating the new ATRAC3plus audio compression technology, Hi-MD is a new recording format that delivers longer recording times than ordinary MDs. Hi-MD discs can also be used as a computer storage medium for non-audio data such as text and images. This recorder supports Hi-MD only. For more details on Hi-MD, refer to the supplied flyer “What you can do with the Hi-MD Walkman”.

About ATRAC3plus

ATRAC3plus is an enhanced version of ATRAC3.

Compared to ATRAC3 (used in LP2 and LP4 recording mode of MiniDisc components), which attains a compression ratio 10 times higher than that of a CD, ATRAC3plus (used in Hi-SP and Hi-LP mode of the recorder) achieves a higher compression ratio that is 20 times higher than that of a CD, but with no loss in sound quality.

“Hi-MD mode” and “MD mode”

This recorder has two operation modes, “Hi-MD mode” and “MD mode”. The operation mode is automatically recognized whenever the disc is inserted.

- When using a 1GB Hi-MD disc, the operation mode will only be Hi-MD.
- When using a standard disc (60/74/80 minutes), the operation mode can be set as follows.

Disc condition	Operation mode
Blank disc	The mode set for the “Disc Mode” in the menu. ¹⁾ ➔ When recording on this recorder without using a computer, set “Disc Mode” to “Hi-MD” so that the operation mode will be “Hi-MD mode”.
The disc contains material recorded in Hi-MD mode	Hi-MD
The disc contains material recorded in MD mode	MD ➔ You cannot use this recorder to record in MD mode without using a computer. Recording in “MD mode” is possible if you use the supplied software.

¹⁾ Refer to “Selecting the disc mode (Disc Mode)” (page 60) for the “Disc Mode” setting.

About Linear PCM

Linear PCM is a digital, non-compressed audio coding system. You can enjoy high-quality sound equal to that of CDs by recording in this mode.

The meaning of “no sound”

“No sound” describes a recorder condition in which the input level is about 4.8 mV during analog input or less than -89 dB during optical (digital) input (with 0 dB as full bit (the maximum recordable level for a MiniDisc)).

About “System File”

The system file is space on the disc that is used to store information other than audio files; for instance, track numbers.

If the MiniDisc were a book, the system file would correspond with the index or table of contents.

The recorder rewrites the system file whenever an operation such as recording, adding or deleting track marks, or moving tracks has been done. (“SYSTEM FILE WRITING” appears in the display when the recorder is rewriting the system file.) While the recorder is writing disc information, make sure not to move or jog the recorder or disconnect the power source as this may cause the information to be incorrectly recorded or the disc contents to be lost.

List of the recording time for each disc

When using a disc in Hi-MD mode

When recording on the recorder		Recording time ¹⁾			
Recording mode on the recorder	Codec/Bit rate	1GB Hi-MD disc	80-minute standard disc	74-minute standard disc	60-minute standard disc
PCM	Linear PCM/1.4Mbps	1 hour and 34 minutes	28 minutes	26 minutes	21 minutes
Hi-SP	ATRAC3plus/256kbps	7 hours and 55 minutes	2 hours and 20 minutes	2 hours and 10 minutes	1 hour and 40 minutes
Hi-LP	ATRAC3plus/64kbps	34 hours	10 hours and 10 minutes	9 hours and 20 minutes	7 hours and 40 minutes
When transferring from the computer		Recording time ¹⁾²⁾			
Codec/Bit rate		1GB Hi-MD disc	80-minute standard disc	74-minute standard disc	60-minute standard disc
Linear PCM/1.4Mbps		1 hour and 34 minutes	28 minutes	26 minutes	21 minutes
ATRAC3plus/256kbps		7 hours and 55 minutes	2 hours and 20 minutes	2 hours and 10 minutes	1 hour and 40 minutes
ATRAC3plus/64kbps		34 hours	10 hours and 10 minutes	9 hours and 20 minutes	7 hours and 40 minutes
ATRAC3plus/48 kbps		45 hours	13 hours and 30 minutes	12 hours and 30 minutes	10 hours
ATRAC3/132kbps		16 hours and 30 minutes	4 hours and 50 minutes	4 hours and 30 minutes	3 hours and 40 minutes
ATRAC3/105kbps		20 hours and 40 minutes	6 hours and 10 minutes	5 hours and 40 minutes	4 hours and 40 minutes
ATRAC3/66kbps		32 hours and 40 minutes	9 hours and 50 minutes	9 hours	7 hours and 20 minutes
MP3/128kbps		17 hours	5 hours	4 hours and 30 minutes	3 hours and 30 minutes

¹⁾ Approximate time

²⁾ When transferring 4-minute tracks

When using a disc in MD mode

You cannot record in MD mode on this recorder.

When transferring from the computer	Recording time ¹⁾²⁾		
	80-minute standard disc	74-minute standard disc	60-minute standard disc
ATRAC(stereo)/292kbps	80 minutes	74 minutes	60 minutes
ATRAC3/132, 105kbps	2 hours and 40 minutes	2 hours and 28 minutes	2 hours
ATRAC3/66kbps	5 hours and 20 minutes	4 hours and 56 minutes	4 hours



¹⁾ Approximate time



²⁾ When transferring 4-minute tracks

About recordable audio formats

The audio formats that can be recorded on this recorder vary according to the disc type and recording method. Check the following table for details.

Disc type	Recording method	Format	Component used for playback		
			Component that supports Hi-MD ¹⁾	Component that supports MDLP ²⁾	MD component
1GB Hi-MD disc	When recording on the recorder	Hi-MD	✓		
	When transferring from the computer	Hi-MD	✓		
60/74/80-minute standard disc	When recording on the recorder	Hi-MD	✓		
	When transferring from the computer	Hi-MD	✓		
		MDLP	✓	✓	
		MD	✓	✓	✓

¹⁾ Audio components marked with the  or  logo mark

²⁾ Audio components marked only with the  or  logo mark

Note on digital recording

This recorder uses the Serial Copy Management System, which allows only first-generation digital copies to be made from premastered software. You can only make copies from a home-recorded disc by using the analog (line out) connections.

Premastered software such as CDs or MDs.

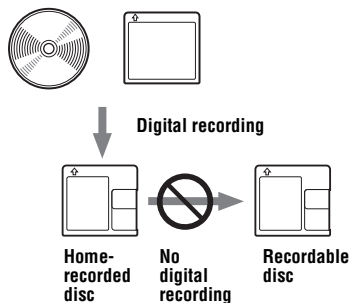

Microphone, record player, tuner, etc. (with analog output jacks).

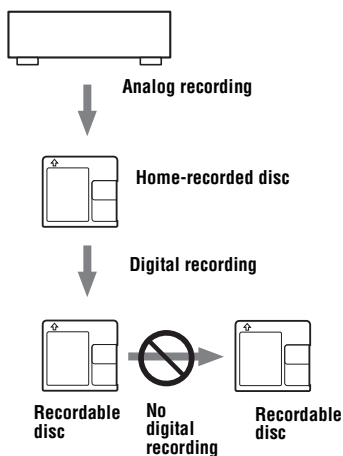

Restrictions on the editing of tracks transferred from your computer

This unit was designed so that editing functions (i.e., adding track marks and erasing track marks) do not function for tracks that have been transferred from your computer. This is to prevent the loss of transfer authorization by the transferred tracks. To edit these tracks, first transfer them into the computer, and then edit them on the computer.

About the DSP TYPE-S for ATRAC/ATRAC3

This recorder supports DSP TYPE-S, a specification for high-level Sony MiniDisc decks equipped with digital signal processors (DSP). This specification allows the recorder to produce high-quality sound from tracks recorded in MDLP mode. Since it retains DSP TYPE-R support, the recorder produces superior results during playback in SP (normal stereo) mode.

Suppressing the skips of the sound (G-PROTECTION)

The G-PROTECTION function was developed to provide a higher level of shock resistance than that of existing players.

Difference between digital (optical) and analog (line) inputs

The input jack of this recorder works as both digital and analog input jacks. Connect the recorder to a CD player or a cassette recorder using either digital (optical) input or analog (line) input. To record, see “Recording a disc right away!” (page 21) to record using digital (optical) input, and “Recording from a TV or radio (Analog Recording)” (page 34) to record using analog (line) input.

Difference	Digital (optical) input	Analog (line) input
Connectable source	Equipment with a digital (optical) output jack (CD player, DVD player, etc.)	Equipment with an analog (line) output jack (Cassette deck, radio, record player, etc.)
Usable cord	Optical cable (with an optical or an optical-mini plug) (page 21)	Line cable (with 2 phono plugs or a stereo-mini plug) (page 34)
Signal from the source	Digital	Analog Even when a digital source (such as a CD) is connected, the signal sent to the recorder is analog.
Track marks ¹⁾	Marked (copied) automatically <ul style="list-style-type: none">• at the same positions as the source (when the sound source is a CD or an MD).• after more than 2 seconds of no sound (page 84) or low-level segment (with a sound source other than a CD or an MD).• when the recorder is paused (3 seconds of no sound is encountered while synchro-recording)	Marked automatically <ul style="list-style-type: none">• after more than 2 seconds of no sound (page 84) or low-level segment.• when the recorder is paused while recording.
Recorded sound level	Same as the source. Can also be adjusted manually (Digital REC level control) (“Adjusting the recording level manually”, page 35).	Adjusted automatically. Can also be adjusted manually (“Adjusting the recording level manually”, page 35).

¹⁾ You can erase unnecessary marks after recording. (“Combining tracks (Combine)”, page 55).

Note

Track marks may be copied incorrectly:

- when you record from some CD players or multi disc players using digital (optical) input.
- when the source is in shuffle or program play mode while recording using digital (optical) input. In this case, play the source in normal play mode.
- when programs with audio that is digitally broadcast (e.g., digital TV) are recorded through the digital (optical) input.

What you can do with SonicStage/ MD Simple Burner

What you can do with SonicStage

SonicStage allows you to import audio data to your computer from music sources such as audio CDs and the Internet, and then transfer the audio data stored in your computer to an MD.

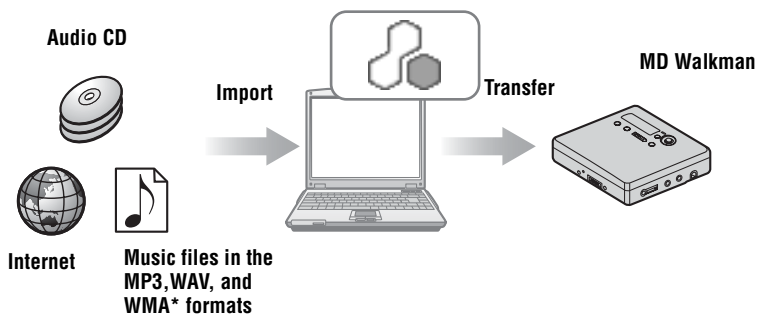

* Copyright-protected WMA files cannot be transferred.

What you can do with MD Simple Burner

MD Simple Burner allows you to record music tracks from an audio CD in the CD drive of your computer to an MD Walkman, without first recording the music tracks to the computer.

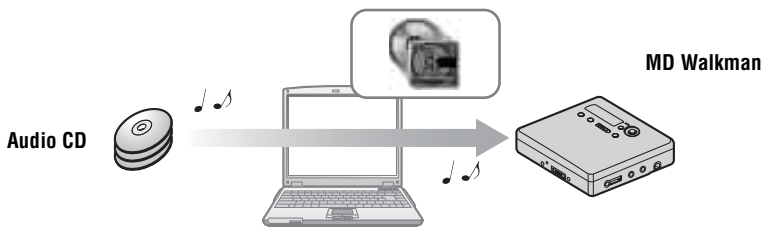

Basic operational flow using an MD Walkman

 **SonicStage**

 **MD Simple Burner**

Providing the required system environment (page 92)



Installing the software onto your computer (page 93)



Importing audio data to your computer (page 95)



Connecting an MD walkman to your computer (see page 63 on "Recorder Operation")



Transferring audio data from your computer (page 97)



Listening to an MD

Connecting an MD walkman to your computer (see page 63 on "Recorder Operation")



Recording music tracks from an audio CD in the CD drive of your computer (page 108)



Providing the required system environment

System requirements

The following system environment is required in order to use the SonicStage Ver. 3.0/MD Simple Burner Ver. 2.0 software for the MD Walkman.

Computer	IBM PC/AT or Compatible
	<ul style="list-style-type: none">• CPU: Pentium III 450 MHz or higher• Hard disk drive space: 200 MB or more (1.5 GB or more is recommended) (The amount space will vary according to Windows version and the number of music files stored on the hard disk.)• RAM: 128 MB or more
	Others <ul style="list-style-type: none">• CD drive (capable of digital playback by WDM) (A CD-R/RW drive is necessary for CD writing)• Sound Board• USB port
Operating System	Factory installed: Windows XP Media Center Edition 2005/Windows XP Media Center Edition 2004/Windows XP Media Center Edition/Windows XP Professional/Windows XP Home Edition/Windows 2000 Professional/Windows Millennium Edition/Windows 98 Second Edition
Display	High Color (16bit) or higher, 800 × 600 dots or better (1024 × 768 dots or better is recommended)
Others	<ul style="list-style-type: none">• Internet access: for Web registration, EMD services and CDDB• Windows Media Player (version 7.0 or higher) installed for playing WMA files

This software is not supported by the following environments:

- OSs other than the indicated above
- Personally constructed PCs or operating systems
- An environment that is an upgrade of the original manufacturer-installed operating system
- Multi-boot environment
- Multi-monitor environment
- Macintosh

Notes

- We do not ensure trouble-free operation on all computers that satisfy the system requirements.
- The NTFS format of Windows XP/Windows 2000 Professional can be used only with the standard (factory) settings.
- For Windows 2000 Professional users, install Service Pack 3 or later version before using the software.
- We do not ensure trouble-free operation of the system suspend, sleep, or hibernation function on all computers.

Installing the software onto your computer

Before installing the software

- Make sure to close any virus-check software, as such software usually demands a large amount of system resources.
- When you use the MD Walkman, make sure to install the software with the supplied CD-ROM.
 - If OpenMG Jukebox, SonicStage or Net MD Simple Burner is installed already, the previous software will be overwritten by the new version. The new version retains the functions of the older version, but with new functions added.
 - If SonicStage Premium or SonicStage Simple Burner is installed already, the previous software will co-exist with the new version.
 - You will still be able to use music data registered by an older software version even after SonicStage has been installed. As a precaution, we recommend that you back up your music data. To back up the data, refer to [Backing Up My Library] on SonicStage Help.
The method for managing music data differs in part from conventional methods. For details, refer to [For Users of Earlier Versions of SonicStage] in SonicStage Help.
- If the MD Walkman is connected to the computer with the USB cable, make sure to disconnect the USB cable first before installing the software.

1 Turn on your computer and start up Windows.

2 Insert the supplied CD-ROM into the CD drive of your computer.
The setup program starts up automatically and the installation window appears.

3 When the [Region Selection] screen appears, select the region where the SonicStage software will be used, and then click [Next].

-
- 4** Click [Install SonicStage and MD Simple Burner] and then follow the displayed instructions.

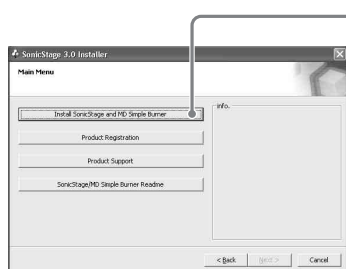

Click [Install SonicStage and MD Simple Burner]

Read the instructions carefully.

Depending on your region, the buttons other than [Install SonicStage and MD Simple Burner] may differ from those in the illustration above.

The installation may take 20 to 30 minutes, depending on your system environment. Make sure to restart your computer only after the installation is completed.

Was the installation successful?

If any trouble occurs during the installation, see “Troubleshooting” (page 114).

Importing audio data

This section explains how to record and store audio data from an audio CD to My Library of SonicStage on the hard disk drive of your computer. You can also assign cover art for imported albums.

You can record or import music from other sources such as the Internet and your computer's hard disk. Refer to SonicStage Help for details.

Notes

- Only audio CDs with a  mark can be used with SonicStage.
- We do not guarantee normal operation in the case of the copy-controlled CDs.

Playback control section

Cover art display

[CD Info]

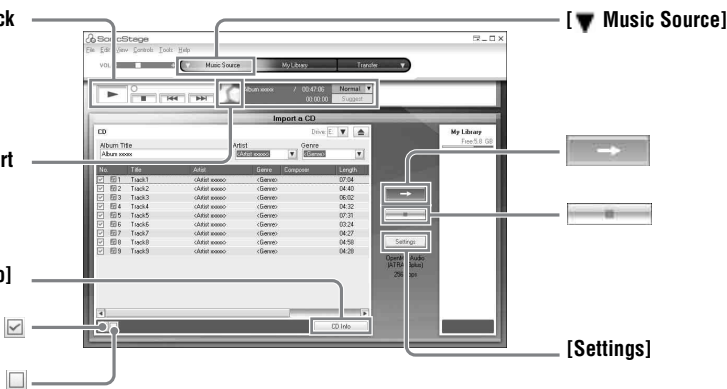

1 Start up SonicStage.

Select [Start] - [All Programs]* - [SonicStage] - [SonicStage].

*[Programs] in the case of Windows 2000 Professional/Windows Millennium Edition/Windows 98 Second Edition

SonicStage starts up and the main window appears.



You can also start SonicStage with double click  ([SonicStage] icon) on the desktop.

2 Insert the audio CD that you want to record into the CD drive of your computer.

continued

-
- 3** Point to [ Music Source] on the upper-left side of the screen and click [Import a CD].

The screen switches to the “Music Source” (Importing CD) screen and all the tracks on the audio CD are listed.

- 4** If necessary, click to uncheck tracks you do not want to record.

If you unchecked a box by mistake, click it again to restore the check.

To check all boxes, click .

To uncheck all boxes, click .

- 5** If necessary, change the format and bit rate for audio CD recording.

When you click [Settings] on the right side of the screen, “CD Importing Format” dialog box will appear. The dialog box will ask you to select the format and bit rate for recording an audio CD.

- 6** Click .

The recording of the tracks selected in step 4 starts.

To stop recording

Click .

To assign cover art for imported albums

Find the desired image file (jpg, gif, bmp file) using Windows Explorer and drag it to the cover art display in the playback control section.



If CD information such as album title, artist name, and track names could not be obtained automatically, click [CD Info] on the right side of the screen. When you do this, your computer must be connected to the Internet.

Transferring audio data from your computer to the MD Walkman

Audio data stored in My Library of SonicStage can be transferred to your MD Walkman an infinite number of times.

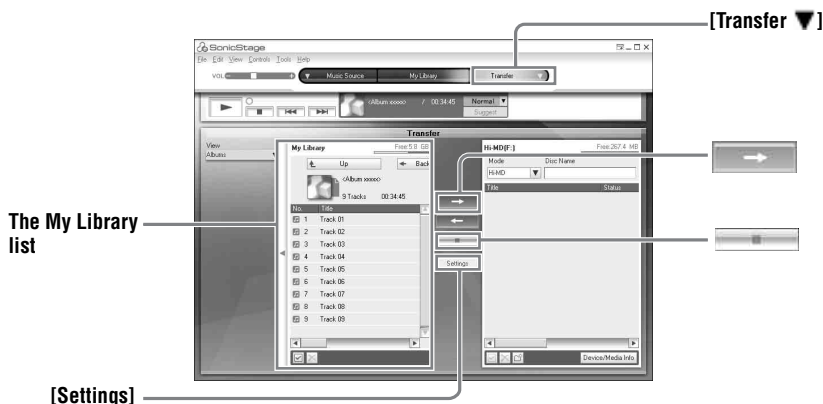

- 1 Insert a disc into the MD Walkman and connect the MD Walkman to your computer.

Use the supplied MD Walkman-dedicated USB cable to connect the MD Walkman to your computer.

For details about connections, see page 63 on “Recorder Operation”.

Do not disconnect the power source or the dedicated USB cable before the transfer has completed.

- 2 Point to [Transfer ▼] on the upper-right side of the screen and click [Hi-MD] or [Net MD].

The screen is switched to the transfer (Hi-MD or Net MD) screen.

- 3 Click the tracks you want to transfer in the My Library list on the left side of the screen.

To transfer more than one track, hold down the [Ctrl] key while selecting the tracks.

To transfer all tracks of the album, click the album.

continued

4 If necessary, change the transfer mode.

As the default setting, tracks in the OpenMG (PCM/ATRAC3/ATRAC3plus) format will be transferred in the same format and bit rate (normal transfer).

If the device connected to the computer does not support the above format, the format and bit rate will be converted to those of the device. In some case, this process may take time.

If you want to change the format and bit rate, click [Settings] in the center of the screen to display “Transfer Mode Settings” dialog box.

5 Click .

Transfer of the tracks selected in step 3 begins.

To stop transferring

Click .

To play a disc on a Net MD device that does not support Hi-MD

If you want to play the transferred tracks on a Net MD Walkman that does not support Hi-MD, select [Net MD] for the mode (operation mode) on the right side of the screen after step 2. This operation mode can be selected only when using a 60/74/80-minute standard disc in Hi-MD mode for recording.

Notes

- A transfer will fail and an error message will appear in the following cases:
 - When there is no enough free space on the disc.
 - When the track is subject to playback restrictions.
- During the transfer, the system suspend, sleep, or hibernation function will not operate.
- Depending on the type of the text and number of characters, the text entered by SonicStage may not be displayed on the connected MD Walkman. This is due to the limitations of the connected MD Walkman.



If you are using a camera-equipped Hi-MD Walkman in Hi-MD mode, whenever you select an album for which album art has been registered, the cover art is transferred to the Hi-MD Walkman along with the album. Cover art is not be transferred in the case of individual tracks.

Transferring back audio data from the MD Walkman to your computer



Transferring from the MD Walkman back to your computer

Audio data that has been transferred from your computer and stored on the MD can be transferred back to My Library of SonicStage on your computer.

- 1** Insert a disc into the MD Walkman and connect the MD Walkman to your computer.
Use the supplied dedicated USB cable for the MD Walkman to connect the MD Walkman to your computer.
For details about connections, see page 63 on “Recorder Operation”.
Do not disconnect the power source or the dedicated USB cable before the transfer has completed.
- 2** Point to [Transfer ▼] on the upper-right side of the screen and click [Hi-MD] or [Net MD].
The screen is switched to the transfer (Hi-MD or Net MD) screen.
- 3** In the list on the right side of the screen (Hi-MD or Net MD), click to select the tracks you want to transfer to your computer.

continued

4 Click  in the middle of the screen.

The transferring of the tracks selected in step 3 starts.

To stop transferring

Click .

To import cover art set using a camera-equipped Hi-MD Walkman to My Library

If you are using a camera-equipped Hi-MD Walkman in Hi-MD mode, you can modify the cover art for any group transferred from My Library, as well as register the cover art for another group. The following two ways can be used to import the cover art to My Library.

- Insert the disc with the updated cover art, and then press the [ Auto Import] button on the bottom-right side of the screen.

The cover art in My Library is automatically updated.

- Select the group for which you want to import the cover art by clicking it on the right side (Hi-MD side) of the display, select [Import Cover Art] from the right-click menu, and then select the album for which you want to add the cover art from the “Select an Album” dialog box.

Note

Tracks transferred to the MD Walkman from another computer cannot be transferred back to My Library on your computer.

Importing tracks recorded on a Hi-MD Walkman* to your computer

Tracks that have been recorded on a Hi-MD Walkman* can be imported to My Library of SonicStage on your computer only once.

* Only tracks recorded in Hi-MD mode

1 Insert recordable disc into the Hi-MD Walkman and connect the Hi-MD Walkman to your computer.

2 Point to [Transfer ▼] on the upper-right side of the screen and click [Hi-MD].
The screen is switched to the transfer (Hi-MD) screen.

3 Click the tracks you want to transfer in the Hi-MD list on the right side of the screen.

To transfer more than one track, hold down the [Ctrl] key while selecting the tracks.

To transfer all tracks of the group, click the group.

4 Click  in the middle of the screen.

The “Import” dialog box appears.

5 Click [Yes].

The importing of the tracks selected in step 3 starts.

To stop importing

Click .



When tracks recorded in analog are included on a Hi-MD, a dialog box appears confirming whether to save those tracks in WAV format. To save the tracks as WAV format music files, select the check box next to “Save in WAV format when importing”, click Browse button and specify a destination folder as necessary, and click the [OK] button.

Notes

- You cannot import tracks that were recorded in a Net MD mode (MD mode) to your computer, or tracks that have been recorded on a device that does not support Hi-MD mode.
- Before importing tracks recorded on the Hi-MD Walkman to the computer, click [Settings] in the middle of the screen to display “Transfer Mode Settings” dialog box, and then confirm the status of the [Import settings] check box (it is checked by default) in [Advanced...]. Then do as follows:
 - To import tracks to My Library while deleting them on the Hi-MD Walkman, uncheck the box.
 - To import tracks to My Library while leaving the copy of them on the Hi-MD Walkman, check the box. Tracks left on the Hi-MD Walkman are treated the same as tracks that have been automatically transferred from the computer. For this reason, they cannot be divided or combined on the Hi-MD Walkman.
- When you transfer tracks recorded in linear PCM on the Hi-MD Walkman to a computer for editing (dividing or combining) in My Library, the editing may take a long time, depending on the length of the tracks and capabilities of your computer. This is due to limitations in the MiniDisc system. If you want to edit long tracks recorded in linear PCM, we recommend that you do the editing on the Hi-MD Walkman first, and then transfer the edited data to a computer afterwards.

Writing audio data to a CD-R/CD-RW disc

You can write tracks in My Library of SonicStage to a CD-R/CD-RW disc. Analog tracks recorded on a Hi-MD device and imported to My Library can be written to and enjoyed on a CD-R/CD-RW. The number of times data can be written may be limited due to copyright restrictions.

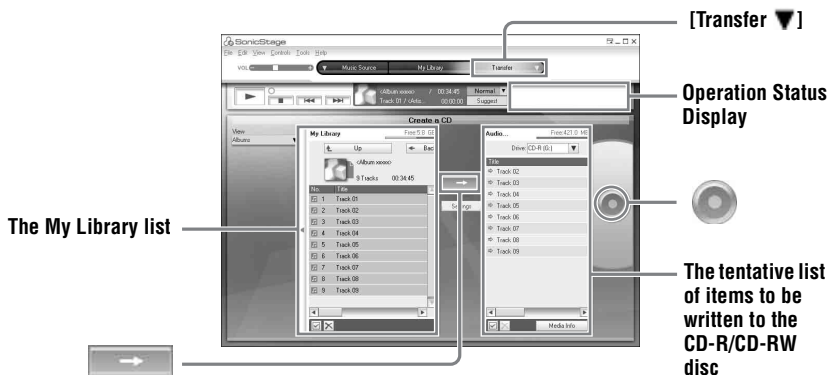

- 1** Point to [Transfer ▼] on the upper-right side of the screen, and then select the type of CD to be created.

To create an audio CD, select [Create an Audio CD]. To create an ATRAC CD, select [Create an ATRAC CD]. To create an MP3 CD, select [Create an MP3 CD].

ATRAC CDs can be played only on devices that support ATRAC CDs. MP3 CDs can be played only on devices that support MP3 CDs.

- 2** Insert a blank CD-R/CD-RW disc into the disc drive of your computer.

Use a CD-R/CD-RW with a recording capacity of 650MB or 700MB. Data may not be correctly written if a disc of another capacity is used.

- 3** Select the albums or tracks to be written to the CD-R/CD-RW disc by clicking them in the My Library list on the left side of the screen.

By double-clicking an album, you can see a list of the tracks on the album and select the tracks you want.

-
- 4** Click  in the middle of the screen.

The selected albums or tracks appear on the right side of the screen (the CD-R/CD-RW) as a tentative list of items to be written.

- 5** Click  in the right of the screen.

The “Writing Settings” dialog box appears allowing you to set options for writing.

- 6** Click [OK].

Writing to the disc begins.

A message appears when writing has completed.

- 7** Click [OK].

The disc is automatically ejected, and the screen returns to the Transfer (CD Creation) screen.

To cancel track writing

- 1** Click  in the Operation Status Display while tracks are being written to the disc.

Writing to the disc is canceled and a message appears.

- 2** Click [OK].

The disc is automatically ejected, and the screen returns to the Transfer (CD Creation) screen.

Notes

- Only tracks in MP3 format can be written to an MP3 CD.
- Tracks that have been digitally recorded on a Hi-MD device and then imported to SonicStage cannot be written to an audio CD. However, analog tracks recorded on a Hi-MD device can be written to a CD.

Using SonicStage Help

SonicStage Help provides further details on how to use SonicStage. SonicStage Help allows you to search easily for information from a list of operations, such as “Importing Tracks” or “Transferring Tracks”, or from large list of keywords, or by typing in words that might lead you to the appropriate explanations.

To display SonicStage Help

Click [Help] – [SonicStage Help] while SonicStage is running.

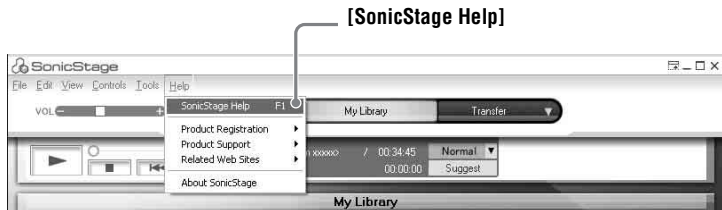

You can display SonicStage Help by selecting the following:
[Start] – [All Programs]* – [SonicStage] – [SonicStage Help].

* [Programs] in the case of Windows 2000 Professional/Windows Millennium Edition/Windows 98 Second Edition

Notes

- In SonicStage Help, “Device/Media” is the general term for the external device such as the MD Walkman, the Network Walkman, and the CD Walkman.
- Follow the instructions of your internet provider regarding such things as recommended system environment when using EMD services.

Understanding SonicStage Help

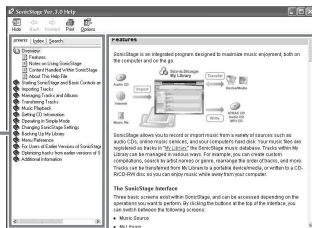

The left side frame

The right side frame

- 1 Double click [Overview] in the left-side frame.
- 2 Click [About This Help File].
The explanation will appear in the right-side frame.
- 3 Read the text.
Scroll the display if necessary.
Click underlined words to jump to their explanations.

Searching for a word inside an explanation

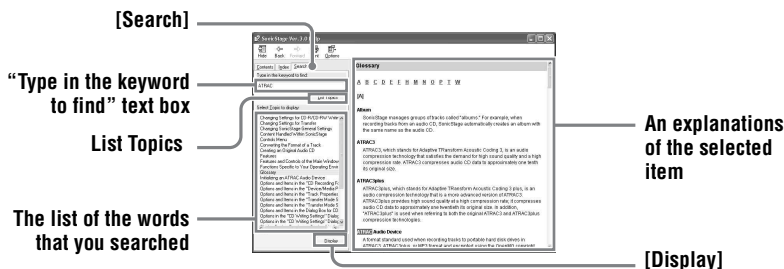

[Search]

“Type in the keyword to find” text box

List Topics

The list of the words that you searched

An explanations of the selected item

[Display]

- 1 Click [Search] to open the “Search” window.
- 2 Type in the words.
- 3 Click [List Topics].
A list of the words that were searched is displayed.
- 4 Click to select the desired item among those displayed.
- 5 Click [Display].
An explanation of the selected item is displayed.

Referring to SonicStage Help

Click [Contents] on the left side of the Help window to view a list of items for each operation. Click on any items for details.

Importing audio data to the computer

To	SonicStage Help
Import audio data from the Internet	[Importing Tracks] – [Purchasing Tracks from a Music Service Site]
Import audio files on the computer in SonicStage	[Importing Tracks] – [Importing Music Files]

Listening to audio data on the computer

To	SonicStage Help
Listen to audio data from the CD drive or My Library	[Music Playback] – [Playing Back an Audio CD] or [Playing Back a Track in My Library]
Listen to audio data on the MD Walkman connected to the computer	[Music Playback] – [Playing Back a Track on a Device/Media]

Managing and editing imported tracks

To	SonicStage Help
Change information related to CD information downloading	[Changing SonicStage Settings] – [Changing Settings for the CD Drive]
Edit an album Delete the tracks	[Managing Tracks and Albums] – [Creating/Editing Albums]
Change the destination directly for track storage	[Changing SonicStage Settings] – [Changing the Location for Saving Imported Files]

Backing up audio data

We recommend that you back up your music data as a precaution against hard disk crashes or computer replacement.

To	SonicStage Help
Back up audio data in My Library	[Backing Up My Library] – [Backing Up Data to a Disk]
Look up about SonicStage backup	[Backing Up My Library] – [FAQ-About SonicStage Backup Tool]

Troubleshooting

To	SonicStage Help
Look up troubleshooting procedure	[Additional Information] – [Troubleshooting]

When you want to know

To	SonicStage Help
Look up unknown words	[Additional Information] – [Glossary]
Look up the kinds of audio data that can be managed by SonicStage	[Overview] – [Content Handled Within SonicStage]
Look up the kinds of functions that can be used with SonicStage	[Overview] – [Features]
Look up changes since an earlier version	[For Users of Earlier Versions of SonicStage] – [Differences from Earlier Versions]

Before using MD Simple Burner

MD Simple Burner allows you to record music tracks from an audio CD in the CD drive of your computer to the MD Walkman.

There are two ways to record from an audio CD.

• Simple mode (page 109)

You can use MD Walkman operations to record an entire CD or only the first track without launching MD Simple Burner.

• Standard mode (page 110)

You can launch MD Simple Burner to record using computer operations. Record an entire CD or selected tracks.

Notes

- You cannot record in simple mode while the MD Simple Burner in standard mode or OpenMG software (SonicStage, OpenMG Jukebox, etc.) is active.
- Only audio CDs with a  mark can be used with MD Simple Burner.
- We do not guarantee normal operation in the case of the copy-controlled CDs.

Recording using MD Walkman operations (Simple mode)

- 1** Insert a recordable disc into the MD Walkman and then connect the MD Walkman to the computer.
For details about connections, see page 63 on “Recorder Operation” section.
Do not disconnect the power source or the dedicated USB cable before the transfer has completed.
 - 2** Insert the audio CD that you want to record into the CD drive of your computer.
The CDDB registration window appears when you use the CDDB for the first time.
You need to connect the computer to the Internet in order to use the CDDB.
 - 3** Press the jog dial (▶/ENT) while pressing REC(+▶)/T MARK on the MD Walkman.
The recording starts.
All tracks on the CD are recorded as a new group.
-

To stop recording

Click ▶ **Abort** on the computer display.

While the first track is being recorded, you can use ■ (stop) button to stop on the MD Walkman.

Setting the recording mode

Before starting recording, right-click the  MD Simple Burner icon in the task tray, and then select in [recording mode].

- [Net MD]: [LP2] or [LP4]
- [Hi-MD]: [PCM], [Hi-SP], [Hi-LP], or [48kbps]

Recording first track only

Before starting recording, right-click the  MD Simple Burner icon in the task tray, and then select [Recording settings] – [Record 1st Track Only].

Setting when the CDDB has more than one item of information

Right-click the  MD Simple Burner icon in the task tray, and then select the setting by clicking [CDDB(r)] – [Multiple Matches].

- [User Selection]: A selection window is displayed
- [No Resolve]: No CD information is downloaded
- [First Choice]: The first item is downloaded



Recording by computer operations (Standard mode)

To start MD Simple Burner, click [Start] – [All Programs]* – [MD Simple Burner] – [MD Simple Burner].

* [Programs] in the case of Windows 2000 Professional/Windows Millennium Edition/Windows 98 Second Edition



There are other ways to start up MD Simple Burner as follows:

- Double-click the  MD Simple Burner icon in the task tray, or right-click and select [Show Standard Mode].
- Double-click the  MD Simple Burner shortcut icon on the desktop.

The window for recording all tracks on the CD

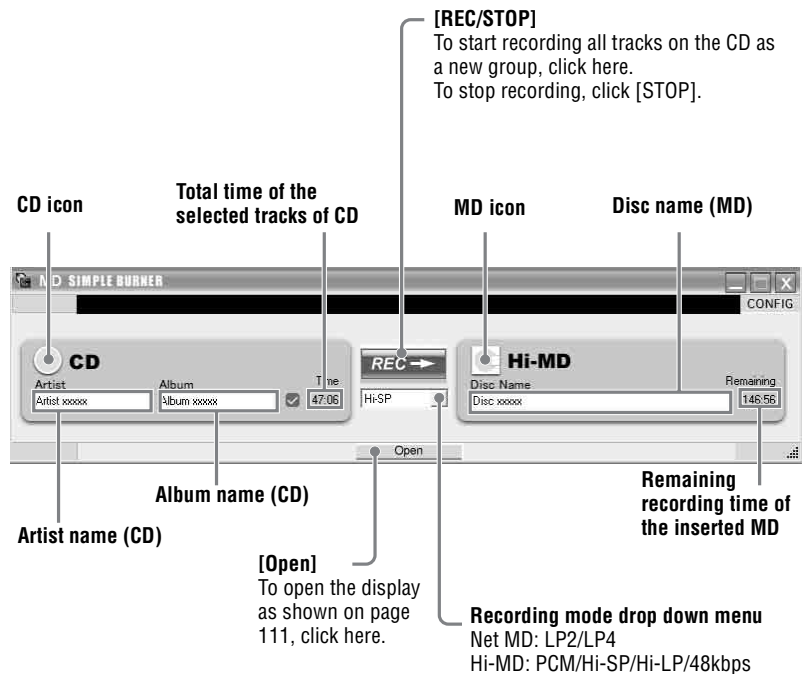

The window for recording selected tracks from an audio CD

Track information (CD)

[CONFIG]

Click here to do the following:

- Set the CD-ROM drive
- View version information for MD Simple Burner
- Confirm CD information registered in the CDDB

Artist name

Total time of the selected tracks of CD

Track information (MD)

You can change the track name and track number

Album Title

[REC/STOP]

Disc name (MD)

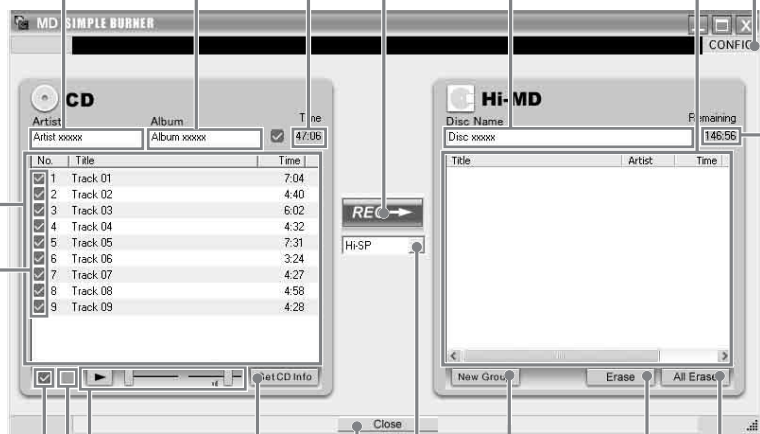

[Get CD Info]

Information of an audio CD (album name, track title, etc.) will be reflected in the track list.

[New Group]

Recording mode drop down menu

[Close]

To close the display as shown on page 110, click here.

CD operating section

Use these controls to confirm the tracks on audio CD to be recorded

To deselect all tracks, click here.

To select all tracks, click here.

[Erase]

[All Erase]

Check boxes

Check the box of the tracks that you want to record

Remaining time of the inserted MD

Uninstalling SonicStage/MD Simple Burner

To uninstall SonicStage/MD Simple Burner, follow the procedures below.

1 Click [Start]–[Control Panel]*.

* [Settings]–[Control Panel] in the case of Windows 2000 Professional/Windows Millennium Edition/Windows 98 Second Edition

2 Double-click [Add/Remove Programs].

3 Click [SonicStage 3.0.xx] or [MD Simple Burner 2.0.xx] in the “Currently Installed Programs” list, and then click [Change and Remove]*.

Follow the displayed instruction and restart your computer. The uninstallation is completed when the computer has restarted.

* [Change/Remove] in the case of Windows 2000 Professional, [Add/Remove] in the case of Windows Millennium Edition/Windows 98 Second Edition

Note

When you install SonicStage Ver. 3.0/MD Simple Burner Ver. 2.0, OpenMG Secure Module 4.1 is installed at the same time. Do not delete OpenMG Secure Module 4.1 since it may be used by other software.

On copyright protection

The OpenMG technology allows you to enjoy digital music, while maintaining the copyrights of its holders.

Restrictions on audio content

High-quality digital audio content is widely available through music distribution services on the Internet. To protect the copyrights of its holders from unauthorized distribution, some audio content is distributed with certain restrictions on recording and playback. For example, the playback period or playback count for the data may be limited.

Troubleshooting

Please refer to the following steps if you encounter a problem while using SonicStage/MD Simple Burner.

- 1 Check the symptoms in this “Troubleshooting” section.
- 2 Check the symptoms in SonicStage Help when you use SonicStage.
- 3 If the problem cannot be solved after checking the above references, check the following table and then consult your nearest Sony dealer.

Computer <ul style="list-style-type: none">• Manufacturer:• Model:• Type: Desktop type / Laptop type
Name of operating system:
RAM capacity:
Hard disk drive (containing SonicStage/MD Simple Burner and audio data) <ul style="list-style-type: none">• Capacity of the drive:• Free space:
Version of the software <ul style="list-style-type: none">• SonicStage Ver. 3.0¹⁾• MD Simple Burner Ver. 2.0²⁾
Error Message (if one appear):
If an externally connected CD-ROM drive is used <ul style="list-style-type: none">• Manufacturer:• Model:• Type: CD-ROM / CD-R/RW / DVD-ROM / Other ()• Type of connection to the computer: PC card / USB / IEEE1394 / Other ()
If another device with USB connection is used <ul style="list-style-type: none">• Name of the device (or devices):

¹⁾ To check the SonicStage software version, go to [Help] – [About SonicStage] in the SonicStage window.

²⁾ To check the MD Simple Burner software version, go to [CONFIG] – [Version] in the MD Simple Burner window.

The software cannot be installed onto your computer

Problem	Cause/Remedy
The installation was not successful.	You are using an OS that does not support this software. →See page 92 for more details. All windows applications are not closed. →If you start the installation while other programs are running, a malfunction may occur. This is especially true for programs that require large amounts of system resources, such as virus-check software. There is not enough hard disk space on your hard disk. →You need 200MB or more free space on your hard disk.
The installation appears to have stopped before it has completed.	Check for the appearance of an error message beneath the installation window. →Press the [Tab] key while holding down the [Alt] key. If an error message has appeared, press the [Enter] key. The installation will resume. If there is no message, the installation is still in progress. Wait a little while longer.
The progress bar on the display is not moving. The access lamp has not lit for a few minutes.	The installation is progressing normally. →Please wait. The installation may take 30 minutes or more, depending on your CD drive or system environment.

Using a MD Walkman connected to the computer

Problem	Cause/Remedy
Your computer does not recognize the MD Walkman.	<p>The MD Walkman is not firmly connected with the supplied dedicated USB cable to the computer.</p> <ul style="list-style-type: none"> →Reconnect the MD Walkman to the computer firmly. →Remove and reconnect the MD Walkman. If the computer still does not recognize the MD Walkman, disconnect the cable, restart the computer, and then make the connection again. <p>A disc is not inserted in the MD Walkman.</p> <ul style="list-style-type: none"> →Check if a disc is inserted in the MD Walkman. <p>The Net MD driver is not be installed.</p> <ul style="list-style-type: none"> →Install the SonicStage/MD Simple Burner software using the supplied CD-ROM. <p>The software installation failed.</p> <ul style="list-style-type: none"> →Disconnect the connected device and install the software again using the supplied CD-ROM. <p>The supplied dedicated USB cable is disconnected.</p> <ul style="list-style-type: none"> →Connect the supplied dedicated USB cable firmly. <p>The connections are made through a USB hub.</p> <ul style="list-style-type: none"> →Operations are not guaranteed for USB-hub connections. Connect the MD Walkman directly to the USB connector on the computer.
Even though the dedicated USB cable is used to connect the MD Walkman to the computer, the display on the MD Walkman does not indicate it is connected.	<p>It takes time to recognize SonicStage.</p> <ul style="list-style-type: none"> →Please wait. <p>The other application software is running.</p> <ul style="list-style-type: none"> →Reconnect the supplied dedicated USB cable after a while. If the computer still does not recognize the MD Walkman, disconnect the MD Walkman, restart the computer, and connect the dedicated USB cable again.
Even though your computer recognize the MD Walkman, it does not operate normally.	<p>The supplied dedicated USB cable is disconnected.</p> <ul style="list-style-type: none"> →Connect the supplied dedicated USB cable firmly. <p>The connections are made through a USB hub.</p> <ul style="list-style-type: none"> →Operations are not guaranteed for USB-hub connections. Connect the MD Walkman directly to the USB connector on the computer.

Index

A

- A-B Repeat 42
- Accessories
 - optional 70
 - supplied 12
- ATRAC3plus 84
- AVLS 57

B

- Battery 17, 18
- Battery life 20
- BEEP 57
- Bookmark 41

C

- CD drive 92
- CDDDB 92, 109
- CD-R/RW drive 92
- CD-ROM 93
- Character palette 47
- Charging 17
- Clamp filter 13
- Cleaning 68
- Combining tracks 55
- Computer 62
- Connecting 109
 - analog 34
 - computer 63
 - digital 21
 - when charging 17
- Copyright protection 113

D

- Data storage 64
- Disc memory 58
- Disc Mode 60
- Display 15, 31, 39
- Display language 61
- Divide rehearsal 54

E

- EMD service 92
- Erasing 53

F

- File list 65
- Format 56

G

- Group
 - erasing 53
 - moving 52
 - recording 37
 - releasing 50
 - setting 49
- Group skip 26

H

- Hard disk
 - free space 92
- Hi-MD 84
- HOLD 14, 16, 19

I

- Importing 95
- Initial Search 43
- Installing 92

L

- Linear PCM 84

M

- MD Simple Burner 108
- Menu list 28
- Menu Mode 57
- Move

- groups 52
- tracks 51

- My Library 95

O

- OpenMG Secure Module 4.1 112
- Operation mode 22

P

- Play mode
 - Main Play Mode 40
 - Repeat Play 42
 - Sub Play Mode 42

Q

- Quick mode 59

R

Recording

- analog 34
- digital 21
- from microphone 32
- level 33, 35
- recording mode 34
- Synchro-recording 38
- time 85

Recording mode 109

Recording mode (Bit rate) 96

S

Simple mode 109

SonicStage 95

SonicStage Help 104

Start (software)

MD Simple Burner 110

SonicStage 95

Storage space 66

System environment 92

System limitations 92

T

Title 46

Track mark

add 36, 54

erase 55

Track search 43

Transferring

to the MD Walkman 97

to your computer 99

U

Uninstalling 112

USB bus power 63

USB cable 12

USB port 92

W

WAV 101

Windows 2000 Professional 92, 95, 104, 110, 112

Windows 98 Second Edition 92, 95, 104, 110, 112

Windows Media Player 92

Windows Millennium Edition 92, 95, 104, 110, 112

Windows XP Home Edition 92

Windows XP Media Center Edition 92

Windows XP Media Center Edition 2004 92

Windows XP Media Center Edition 2005 92

Windows XP Professional 92

WMA 90, 92

This warranty is valid only in Canada.

SONY[®]

Network Walkman ATRAC CD Player
Net MD Walkman ATRAC CD Walkman
Hi-MD Walkman IC Recorder

LIMITED WARRANTY

Sony of Canada ("Sony") warrants this Product (including any accessories) against defects in material or workmanship as follows:

1. **LABOUR:** For a period of 90 days from the date of purchase, if this Product is determined to be defective, Sony will repair or replace the Product, at its option, at no charge, or pay the labour charges to any Sony authorized service facility. After the Warranty Period, you must pay for all labour charges.

2. **PARTS:** In addition, Sony will supply, at no charge, new or rebuilt replacements in exchange for defective parts for a period of one (1) year. After 90 days from the date of purchase, labour for removal and installation is available from Sony authorized service facilities or a Sony Service Centre at your expense.

You can extend the warranty period for an additional nine months by registering your product (www.sonymstyle.ca). Once you register your product, the limited warranty period is twelve months from the original date of purchase from Sony or a Sony authorized dealer. The ninety (90) day warranty period is extend-able only to the original purchaser, for an additional period of nine (9) months, for a total of twelve (12) months from the date of purchase when the Product is registered electronically. After the applicable period you must pay for all parts and labour charges.

To obtain warranty service, you must take the Product, or deliver the Product freight prepaid, in either its original packaging or packaging affording an equal degree of protection, to any authorized Sony service facility.

This warranty does not cover customer instruction, installation, set up adjustments or signal reception problems.

This warranty does not cover cosmetic damage or damage due to acts of God, accident, misuse, abuse, negligence, commercial use, or modification of, or to any part of the Product, including the antenna. This warranty does not cover damage due to improper operation or maintenance, connection to improper voltage supply, or attempted repair by anyone other than a facility authorized by Sony to service the Product. This warranty does not cover Products sold AS IS or WITH ALL FAULTS, or consumables (such as fuses or batteries). This warranty is valid only in Canada.

Proof of purchase in the form of a bill of sale or receipted invoice which is evidence that the unit is within the Warranty period must be presented to obtain warranty service.

This warranty is invalid if the factory-applied serial number has been altered or removed from the Product.

REPAIR OR REPLACEMENT AS PROVIDED UNDER THIS WARRANTY IS THE EXCLUSIVE REMEDY OF THE CONSUMER. SONY SHALL NOT BE LIABLE FOR ANY INCIDENTAL OR CONSEQUENTIAL DAMAGES FOR THE BREACH OF ANY EXPRESS OR IMPLIED WARRANTY ON THIS PRODUCT, EXCEPT TO THE EXTENT PROHIBITED BY APPLICABLE LAW, ANY IMPLIED WARRANTY OF MERCHANTABILITY OR FITNESS FOR A PARTICULAR PURPOSE ON THIS PRODUCT IS LIMITED IN DURATION TO THE DURATION OF THIS WARRANTY.

Some provinces do not allow the exclusion or limitation of incidental or consequential damages, or allow limitations on how long an implied warranty lasts, so the above limitations or exclusions may not apply to you. This warranty gives you specific legal rights, and you may have other rights which vary from province to province.

For your convenience, Sony of Canada Ltd. has established telephone numbers for frequently asked questions:

To locate the service or dealer nearest you, or for service assistance or resolution of a service problem, or for product information or operation, call:

Sony Customer Information Center

1-877-770-7669

or write to:

Sony of Canada Ltd.

115 Gordon Baker Road, Toronto, Ontario M2H 3R6 CANADA

or visit:

www.sonymstyle.ca/registration

Portable Audio

This information is used to process your warranty registration and for aftersales support purposes. It may also be used by Sony of Canada Ltd. and affiliated Sony companies for customer relationship development and analysis, and to provide you with information and promotional offers on other products and services that may be of interest to you. For a copy of our Privacy Code, please visit our website at www.sonymstyle.ca/privacy or call 1-877-899-7669.

D 324511302

Free Manuals Download Website

<http://myh66.com>

<http://usermanuals.us>

<http://www.somanuals.com>

<http://www.4manuals.cc>

<http://www.manual-lib.com>

<http://www.404manual.com>

<http://www.luxmanual.com>

<http://aubethermostatmanual.com>

Golf course search by state

<http://golfingnear.com>

Email search by domain

<http://emailbydomain.com>

Auto manuals search

<http://auto.somanuals.com>

TV manuals search

<http://tv.somanuals.com>