

# Microcassette™ - Corder

## Operating Instructions

Инструкция по эксплуатации  
(обратная сторона)

M-670V

©2004 Sony Corporation Printed in China

<http://www.sony.net/>

## Preparing Power Sources

Choose one of the following power sources.

### Dry Batteries

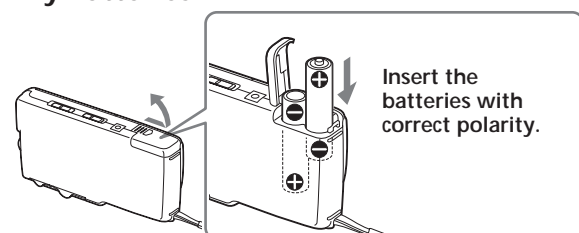

Make sure that nothing is connected to the DC IN 3V jack.

- 1 Open the battery compartment lid.
- 2 Insert two R03 (size AAA) batteries with correct polarity and close the lid.

### To take out the batteries

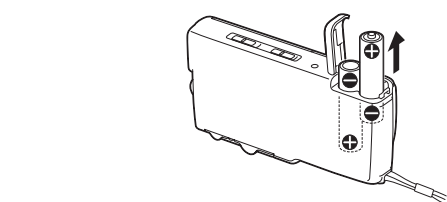

To attach the battery compartment lid if it is accidentally detached

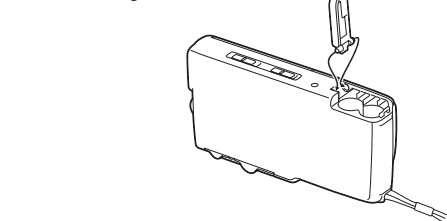

### When to replace the batteries

Replace the batteries with new ones of the same kind when the REC/BATT lamp dims and the (Battery alert LED) lamp flashes.

### Notes

- The unit will play back normally for a while, even after the (Battery alert LED) lamp flashes. However, replace the batteries as soon as you can. Otherwise, the built-in speaker may emit a loud noise and recordings may not be made correctly.
- In the following cases you do not need to replace the batteries:
  - if the (Battery alert LED) lamp flashes with the playback sound when you turn up the volume.
  - if the (Battery alert LED) lamp lights momentarily when the tape starts running or at the end of the tape.
  - if the (Battery alert LED) lamp flashes during FF/REW or CUE/REVIEW.

### Battery life\* (Approx. hours)

Batteries	Recording	Playback**
Sony alkaline LR03 (SG)***	14.5	9
Sony manganese R03 (SB)	5	2.5

\* Measured valued by the standard of JEITA (Japan Electronics and Information Technology Industries Association) (Using a Sony Microcassette)

\*\* Using a tape on which music has been recorded is played at volume setting 7 using speaker

\*\*\*When using Sony LR03 (SG) alkaline dry batteries (produced in Japan)

### Note

The battery life may be shorter depending on the operating condition, the surrounding temperature and battery type.

For maximum performance we recommend that you use alkaline batteries.

### House current

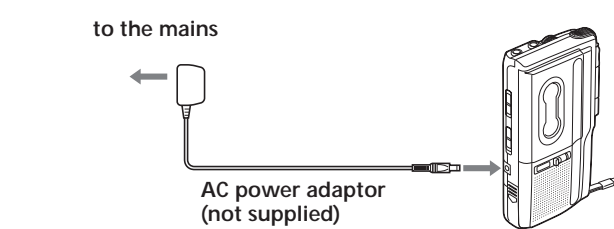

Connect the AC power adaptor to DC IN 3V and to the mains. Use the AC-E30HG AC power adaptor (not supplied). Do not use any other AC power adaptor.



### Notes

- Specifications for AC-E30HG vary for each area. Check your local voltage and the shape of the plug before purchasing.
- Do not touch the AC power adaptor with wet hands.
- Connect the AC power adaptor to the easily accessible mains. Should you notice an abnormality in the AC power adaptor, disconnect it from the mains immediately.

## Recording

You can record right away with the built-in microphone. Make sure that nothing is connected to the MIC jack.

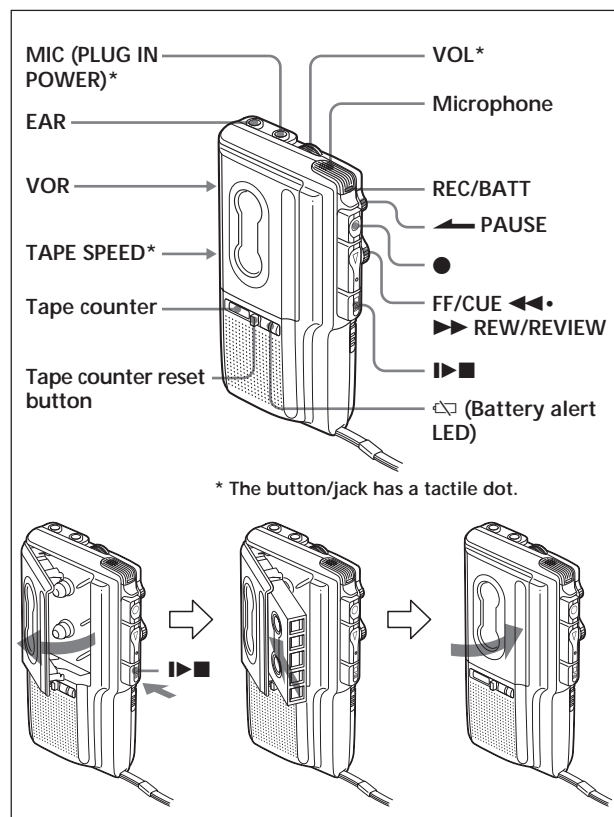

- 1 Press the reset button of the tape counter.
- 2 Press (Play/Pause) and insert a standard microcassette with the side to start recording facing the lid.
- 3 Select the desired tape speed.
  - 2.4 cm for optimum sound (recommended for normal use): A 30-minute recording can be made using both sides of the MC-30 microcassette (supplied for the United States and Europe only). *There is a tactile dot on this side.*
  - 1.2 cm for longer recording time: A 60-minute recording can be made using both sides of the MC-30 microcassette (supplied for the United States and Europe only).
- 4 Set VOR to OFF.
  - If you set VOR to ON, the unit automatically starts recording the sound and pauses when there is no sound (you can save tapes and batteries). When the sound is not loud enough, set it to OFF, or the unit may not start recording.
- 5 Press (Record).
  - (Record) is pressed simultaneously and recording starts. While the tape runs, the REC/BATT lamp lights and flashes depending on the strength of the sound. Recording level is fixed.

At the end of the tape, recording stops and the unit turns off automatically (Automatic shut-off mechanism).

To	Press or slide
Stop recording	(Play/Pause)
Pause recording	Slide (Pause) in the direction of the arrow. To release pause recording, release (Pause).
Start recording during playback	(Record) during playback (the unit enters the recording mode)
Review the portion just recorded	Push up FF/CUE (Fast Forward) or REW/REVIEW (Rewind) during recording. Release the button at the point to start playback.
Take out a cassette	(Play/Pause)

\* (Pause) will also be automatically released when (Play/Pause) is pressed (stop-pause-release function).

### Note

Select the 2.4 cm tape speed for recording, if you play back the recorded tape with another unit. Otherwise, the sound quality may be changed.

### Notes on VOR (Voice Operated Recording)

- The VOR system is affected by the environmental recording conditions. When you use the system in a noisy place, the unit will stay in the recording mode. If the sound is too soft, on the contrary, the unit will not start recording. If you cannot get the results you want, set it to OFF.
- The VOR system may not record the beginning of the sound you want to record because it starts recording only after it catches the sound. For an important recording, set it to OFF.

### To monitor the sound

Connect an earphone (not supplied) to the EAR jack. The monitor volume cannot be adjusted by VOL.

### To prevent a cassette from being accidentally recorded over

Break off and remove the cassette tabs. To reuse the cassette for recording, cover the tab hole with adhesive tape.

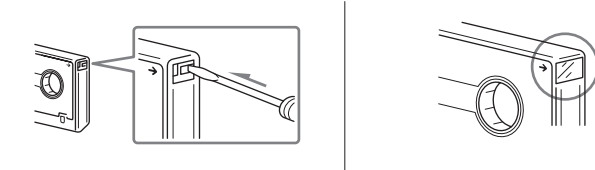

## Recording from Various Sound Sources

### Notes

- When you are going to record something that you may not have an opportunity to record again, test the unit first before you actually start recording.
- When recording with an external microphone, the VOR system may not work properly because of the difference in sensitivity.

### Recording with an External Microphone

Connect a microphone firmly to the MIC jack.

Use a microphone of low impedance (less than 3 kΩ). When using a plug-in-power system microphone, the power to the microphone is supplied from this unit.

### Recording from another equipment

Connect another equipment firmly to the MIC jack using the connecting cord (not supplied). Set this unit to the recording mode and another equipment to the playback mode.

## Playing a Tape

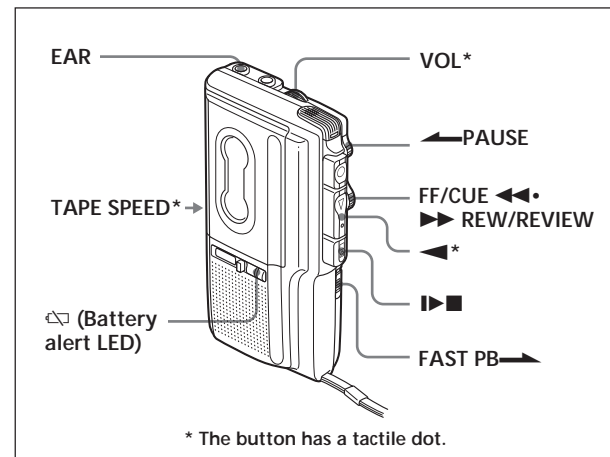

- 1 Insert a cassette with the side to start playing facing the lid.
- 2 Select the tape speed to the same speed as that used for recording.
- 3 Press (Play/Pause).
- 4 Turn VOL to adjust the volume. *There is a tactile dot beside VOL to show the direction to turn up the volume.*

At the end of the tape, playback stops and the unit turns off automatically (Automatic shut-off mechanism). After the tape has been wound or rewound, be sure to press (Play/Pause).

If you plug in headphones (not supplied) to the EAR jack, you will get monaural output from both left and right channels.

To	Press or slide
Stop playback/stop fast forward or rewind	(Play/Pause)
Pause playback	Slide (Pause) in the direction of the arrow. REC/BATT lamp goes off. To release pause playback, release (Pause).
Fast forward** (FF)	Slide FF/CUE (Fast Forward) toward FF/CUE (Fast Forward) during stop.
Rewind** (REW)	Slide FF/CUE (Fast Forward) toward REW/REVIEW during stop.
Search forward during playback (CUE)	Keep FF/CUE (Fast Forward) or REW/REVIEW pushed toward FF/CUE (Fast Forward) during playback and release it at the point you want.
Search backward during playback (REVIEW)	Keep FF/CUE (Fast Forward) or REW/REVIEW pushed toward REW/REVIEW during playback and release it at the point you want.
Start recording during playback	(Record)

\* (Pause) will also be automatically released when (Play/Pause) is pressed (stop-pause-release function).

\*\*If you leave the unit after the tape has been wound or rewound, the batteries will be consumed rapidly. Be sure to press (Play/Pause).

### Note

If the tape is completely rewound while searching backward during playback (REVIEW), the FF/CUE (Fast Forward) or REW/REVIEW switch may not return to the center position when you release the switch. In this case, push back the switch to the center to start playback.

### To increase the playback speed

Slide the FAST PB (Fast Playback) switch in the direction of the arrow. The playback speed will be increased. To return to the original speed, slide the FAST PB (Fast Playback) switch to the original position.

## Precautions

### On power

- Operate the unit only on 3 V DC. For AC operation, use the AC power adaptor recommended for the unit. Do not use any other type. For battery operation, use two R03 (size AAA) batteries.

### On the unit

- Use only the (MICROCASSETTE™) (standard microcassettes) with this unit. Non-standard cassettes cannot be used because their "L" dimension (see illustration) is different.

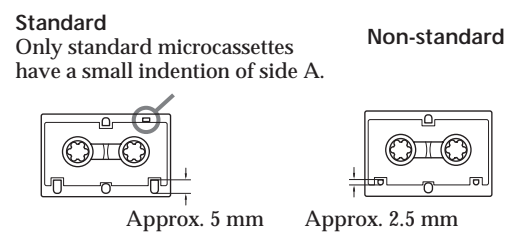

- Do not leave the unit in a location near heat sources, or in a place subject to direct sunlight, excessive dust or mechanical shock.
- Should any solid object or liquid fall into the unit, remove the batteries or disconnect the AC power adaptor, and have the unit checked by qualified personnel before operating it any further.
- Keep personal credit cards using magnetic coding or spring-wound watches, etc. away from the unit to prevent possible damage from the magnet used for the speaker.
- When you do not use the unit for long, remove the batteries to avoid damage caused by battery leakage and subsequent corrosion.
- If the unit has not been used for long, set it in the playback mode and warm it up for a few minutes before inserting a cassette.

If you have any questions or problems concerning your unit, please consult your nearest Sony dealer.

## Troubleshooting

Should any problem persist after you have made these checks, consult your nearest Sony dealer.

### You cannot close the cassette compartment lid.

- The cassette is being inserted in the wrong way.
- (Play/Pause) has been already pressed.
- The cassette is not being inserted completely.

### The unit does not operate.

- The batteries have been inserted with incorrect polarity.
- The batteries are weak. Replace both batteries with new ones.
- (Pause) is slid in the direction of the arrow.
- The AC power adaptor is not firmly connected.
- The unit will not run on dry batteries if the AC power adaptor is left plugged into the DC IN 3V jack even though you disconnect the AC power adaptor from the power source.

### Recording cannot be made.

- There is no cassette in the cassette compartment.
- The tab on the tape has been removed. To reuse the tape for recording, cover the tab hole with adhesive tape.
- The batteries are weak. Replace both batteries with new ones.

### Recording is interrupted.

- The VOR switch is set to ON. When you do not use VOR, set it to OFF.

### Recording cannot be erased completely.

- The head is contaminated. See "Maintenance".

### Playback cannot be made.

- The tape has reached the end. Rewind the tape.

### No sound comes from the speaker.

- The earphone is plugged in. Unplug it.
- The volume is turned down completely.

### The sound drops out or comes with excessive noise.

- The volume is turned down completely.
- The batteries are weak. Replace both batteries with new ones.
- The head is contaminated. See "Maintenance".
- Direct placement of the cassette tape on the speaker resulted in magnetization and deteriorated tonal quality.
- Use the unit away from radiowave-emitting devices such as cellular phones.

### Tape speed is too fast or too slow or the sound is distorted in the playback mode.

- Improper setting of the TAPE SPEED switch. Set it to the same speed as that used for recording.
- The FAST PB (Fast Playback) switch is slid in the direction of the arrow.
- The batteries are weak. Replace both batteries with new ones.

### During CUE/REVIEW the tape stops or does not run. You cannot fast-forward or rewind.

- The batteries are weak. Replace both batteries with new ones.

## Maintenance

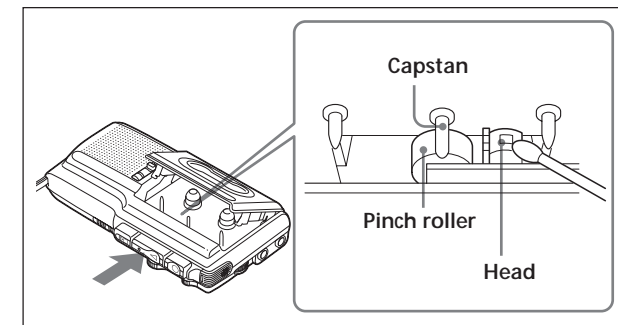

### To clean the tape head and path

Press (Play/Pause) and wipe the head, capstan and the pinch roller with a cotton swab, moistened with alcohol every 10 hours of use.

### To clean the exterior

Use a soft cloth slightly moistened in water. Do not use alcohol, benzine or thinner.

## Specifications

### Tape

(MICROCASSETTE™) (normal position type)

### Recording system

2-track 1-channel monaural

### Speaker

Approx. 2.8 cm dia.

### Tape speed

2.4 cm/s, 1.2 cm/s

### Frequency range

300 - 4 000 Hz (with TAPE SPEED switch at 2.4 cm/s)

### Input

Microphone input jack (minijack/monaural/PLUG IN POWER) sensitivity 0.2 mV for 3 kΩ or lower impedance microphone

### Output

Earphone jack (minijack/monaural) for 8 - 300 Ω earphone  
Power output (at 10% harmonic distortion)

450 mW

### Power requirements

3 V DC batteries R03 (size AAA) × 2/External DC 3V power sources

### Dimensions (w/h/d) (incl. projecting parts and controls)

Approx. 54.8 × 106.8 × 21.5 mm

### Mass (main unit only)

Approx. 92 g

### Supplied accessories

Microcassette tape MC-30 (1) (for the United States and Europe only)  
Alkaline batteries LR03 (SG) (2) (for the United States only)

Design and specifications are subject to change without notice.



## Free Manuals Download Website

<http://myh66.com>

<http://usermanuals.us>

<http://www.somanuals.com>

<http://www.4manuals.cc>

<http://www.manual-lib.com>

<http://www.404manual.com>

<http://www.luxmanual.com>

<http://aubethermostatmanual.com>

Golf course search by state

<http://golfingnear.com>

Email search by domain

<http://emailbydomain.com>

Auto manuals search

<http://auto.somanuals.com>

TV manuals search

<http://tv.somanuals.com>