

SONY®

IC Recorder

Operating Instructions

IC RECORDER
ICD-UX60/UX70/UX80

© 2007 Sony Corporation

3-283-649-11(1)

Getting Started

Basic Operations

Various Recording Modes

Playback/Erasing

Editing Messages

Utilizing the Menu Function

Utilizing Your Computer

Troubleshooting

Additional Information

Index

For customers in Europe

Disposal of Old Electrical & Electronic Equipment (Applicable in the European Union and other European countries with separate collection systems)



This symbol on the product or on its packaging indicates that this product shall not be treated as household waste. Instead it shall be handed over to the applicable collection point for the recycling of electrical and electronic equipment. By ensuring this product is disposed of correctly, you will help prevent potential negative consequences for the environment and human health, which could otherwise be caused by inappropriate waste handling of this product. The recycling of materials will help to conserve natural resources. For more detailed information about recycling of this product, please contact your local Civic Office, your household waste disposal service or the shop where you purchased the product.

Applicable accessories: Headphones, USB connection support cable

Disposal of waste batteries (applicable in the European Union and other European countries with separate collection systems)



This symbol on the battery or on the packaging indicates that the battery provided with this product shall not be treated as household waste. By ensuring these batteries are

disposed of correctly, you will help prevent potentially negative consequences for the environment and human health which could otherwise be caused by inappropriate waste handling of the battery. The recycling of the materials will help to conserve natural resources.

In case of products that for safety, performance or data integrity reasons require a permanent connection with an incorporated battery, this battery should be replaced by qualified service staff only. To ensure that the battery will be treated properly, hand over the product at end-of-life to the applicable collection point for the recycling of electrical and electronic equipment.

For all other batteries, please view the section on how to remove the battery from the product safely. Hand the battery over to the applicable collection point for the recycling of waste batteries.

For more detailed information about recycling of this product or battery, please contact your local Civic Office, your household waste disposal service or the shop where you purchased the product.

Notice for the customers in the countries applying EU Directives

The manufacturer of this product is Sony Corporation, 1-7-1 Konan, Minato-ku, Tokyo, Japan. The Authorized Representative for EMC and product safety is Sony Deutschland GmbH, Hedelfinger Strasse 61, 70327 Stuttgart, Germany. For any service or guarantee matters please refer to the addresses given in separate service or guarantee documents.

Table of Contents

Checking the contents of the package.....	5
Index to Parts and Controls.....	6

Getting Started

Step 1: Preparing a Power Source	11
Inserting the battery.....	11
When replacing/charging the battery.....	13
Step 2: Setting the Clock.....	15

Basic Operations

Recording Messages.....	17
-------------------------	----

Various Recording Modes

Starting to Record Automatically in Response to Sound – the VOR Function	21
Recording with an External Microphone	22
Recording from Other Equipment.....	23
Recording sound from a telephone or a cell phone	24

Playback/Erasing

Playing Back Messages.....	25
Adjusting the playback speed – DPC (the Digital Pitch Control function).....	28
Playing back a specified section repeatedly – A-B Repeat	29
Playing Back a Message at a Desired Time with an Alarm.....	29
Erasing Messages.....	31
Erasing messages one by one.....	32
Erasing all messages in a folder	32

Editing Messages

Moving Message to a Different Folder.....	33
---	----

Utilizing the Menu Function

Making Settings for the Menu.....	34
-----------------------------------	----

Utilizing Your Computer

Using the IC Recorder with Your Computer.....	44
System requirements.....	44
Connecting the IC recorder to your computer.....	45
Disconnecting the IC recorder from your computer.....	46
Using Voice Recognition Software.....	46
Introducing the voice recognition software.....	46
Creating a user file adapted to your recorded speech (Training).....	47
Playing Back Transferred MP3 Files Using the IC Recorder.....	48
Construction of folders and files.....	50
Using the IC Recorder as a USB Mass Storage Device.....	51

Troubleshooting

Troubleshooting.....	52
Error messages.....	56
System limitations.....	58

Additional Information

Recording with Other Equipment.....	59
Using a USB AC Adaptor (not supplied).....	60
Disconnecting the IC recorder from the AC outlet.....	61
Precautions.....	62
Specifications.....	63
Index.....	65

Checking the contents of the package

IC Recorder (1)

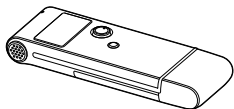

LR03 (size AAA) alkaline battery (1)



Stereo headphones (1)



USB connection support cable (1)

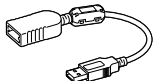

Carrying pouch (1)

Operating Instructions

You are cautioned that any changes or modifications not expressly approved in this manual could void your authority to operate this equipment.

Index to Parts and Controls

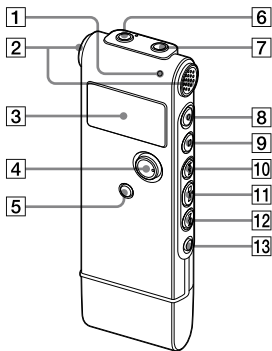

Refer to the pages indicated in parentheses for details.

Front

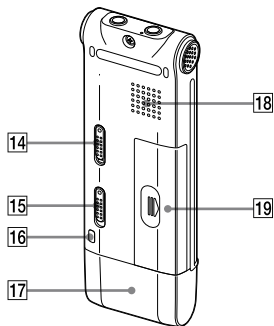

Rear



- 1** Operation indicator (15, 17, 18, 25, 40, 61)
- 2** Built-in microphones (stereo) (17)
- 3** Display window (8)
- 4** Control key (▲, ▼/VOL (volume) +, VOL -)/ENT (enter) button*¹
- 5**  (folder)/MENU button (17, 25, 32, 33, 34, 49)
- 6**  (headphone) jack*² (17, 19, 25, 26, 59)
- 7**  (microphone) jack (22, 23)

- 8 ● (record/pause) button (17, 18, 21, 37)
- 9 ■ (stop) button (18, 26, 27, 30, 33, 34)
- 10 ►► (cue/fast forward) button (25, 26, 27)
- 11 ►■ (play/stop) button (18, 25, 27)
- 12 ◀◀ (review/fast backward) button (18, 25, 26, 27)
- 13 ↶ (repeat) A-B button (25, 29)
- 14 HOLD switch*³
- 15 DPC switch (25, 28, 38)
- 16 Opening for a handstrap (A handstrap is not supplied.)
- 17 USB cap
- 18 Speaker
- 19 Battery compartment (11)

***1 How to use the control key**

Press the key toward the left or right to adjust the volume.

Also use the key to change the menu settings or to select a folder. In the menu setting window or folder selection window, press the key upward or downward to select the item or the folder you want, and then press the center of the key (ENT) to confirm the setting.

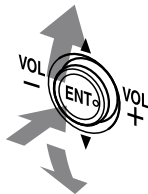

- *2** Connect the supplied or commercially available stereo headphones to the ♪ (headphone) jack. If unwanted noise is heard, wipe the headphones plug clean.

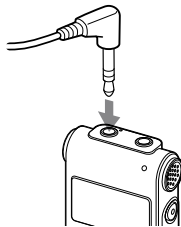

- *3 When you slide the HOLD switch in the direction of the arrow in the stop mode, the IC recorder turns off within a few seconds. To turn the IC recorder on, slide the HOLD switch in the opposite direction from that of the arrow. During recording and playback slide the switch in the direction of the arrow to lock all the functions of all the buttons so that you can prevent inadvertent operations.

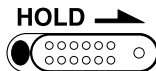

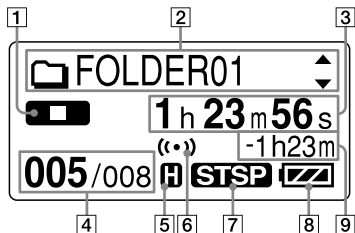

Display window



- 1** Operation mode indicator
Displays the following, depending on the current operation mode
- : stop
 - : playback
 - REC** : recording
 - : recording standby/recording pause
 - REC VOR** : recording with the VOR function
 - VOR** : recording pause with the VOR function (flashing)
- If you press ● (record/pause) to pause recording when "VOR" is set to "ON" in the menu, only " " flashes.

◀◀ ▶▶ : review/fast backward, cue/fast forward

◀◀ ▶▶ : going backward/forward continuously

2  Folder name/  Message title name/  Artist name indication
Press the control key toward **▲** or **▼** to display a folder name, message title name, and artist name in sequence.

3 Elapsed time/Remaining time/
Recording date and time indication

4 Selected message number/Total number of messages in the folder

5 Microphone sensitivity indicator
Displays the microphone sensitivity.
H (high) : To record at a meeting or in a quiet/spacious place.
L (low) : To record for dictation or in a noisy place.

6 Alarm indicator
Appears when the alarm is set for a message.

7 Recording mode indicator
Displays the recording mode set using the menu when the IC recorder is in the stop mode, and displays the current recording mode when the IC recorder is in the playback or recording mode.

ST : Standard play stereo recording mode with high quality sound

STSP : Standard play stereo recording mode

STLP : Long play stereo recording mode

SP : Standard play monaural recording mode

LP : Long play monaural recording mode

8 Remaining battery/Charging indicator

When a dry battery is used, the indicator shows the remaining battery power.

While charging the rechargeable battery an animation appears.

9 Remaining recording time indication

Displays the remaining recording time in hours, minutes, and seconds.

If there is more than 10 hours time remaining, the time is displayed in hours.

If there is more than 10 minutes and less than 10 hours time remaining, the time is displayed in hours and minutes.

If there is less than 10 minutes time remaining, the time is displayed in minutes and seconds.

Step 1: Preparing a Power Source

Inserting the battery

- 1 Slide and lift the battery compartment lid.

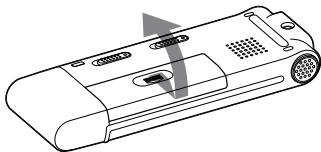

- 2 Insert one LR03 (size AAA) alkaline battery with correct polarity, and close the lid.

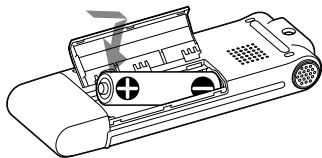

When using Sony NH-AAA rechargeable battery (not supplied)

- 1 Follow the steps 1 and 2 on the left, and then insert a NH-AAA rechargeable battery (not supplied).
- 2 Charge the battery by connecting the USB connector of the IC recorder to your computer.

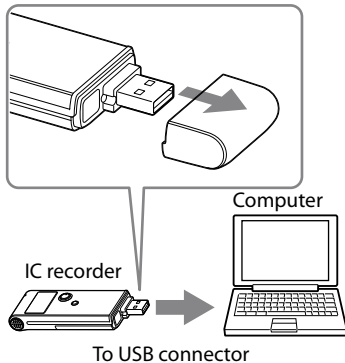

While the battery is charging, "CONNECTING" and the remaining battery/charging indicator are displayed in an animation.

When the remaining battery/charging indicator indicates “**FULL**” charging is completed. (Charging time: approx. 8 hours*)

When you use the IC recorder for the first time, or after you have not used the IC recorder for a certain time, it is recommended that you charge the battery repeatedly until “**FULL**” is displayed.

If the remaining battery/charging indicator is not displayed, charging has not been done properly. Proceed from step 1 again.

* This is an approximation for the time it takes to charge from no remaining battery power to full battery power at room temperature. It varies depending on the remaining power and the condition of the battery. It also takes more time if the temperature of the battery is low, or if the battery is charged while you are transferring data to the IC recorder.

If the IC recorder cannot be connected to your computer directly, use the supplied USB connection support cable.

Tip

You can charge the rechargeable battery by connecting the IC recorder to an AC outlet using a USB AC adaptor (not supplied) (page 60).

Notes

- While “**COLD**” or “**HOT**” is flashing instead of the remaining battery/charging indicator, you cannot charge the battery. Charge the battery in an environment with a temperature of 5 °C - 35 °C.
- If “USB CHARGE” in the “DETAIL MENU” menu is set to “OFF”, you cannot charge the battery using your computer. Set “USB CHARGE” to “ON” (page 43).
- Do not use manganese battery for this IC recorder.
- During playback using the built-in speaker, you cannot charge the battery.
- When you use the IC recorder with a rechargeable battery, the remaining battery/charging indicator may not light fully.

Clock setting display appears and the year section flashes when you insert battery for the first time, or when you insert battery after the IC recorder has been without battery for a certain period of time. Please refer to step 3 in “Step 2: Setting the Clock” on page 16 to set the date and time.

When replacing/charging the battery

The remaining battery/charging indicator on the display shows the battery condition.

Battery remain indication

 : Replace the old battery with a new one or charge the rechargeable battery.



 : "LOW BATTERY" appears and the IC recorder will stop operation.

Battery life*¹

When using Sony LR03 (SG) (size AAA) alkaline battery

Recording mode	ST ³	STSP ⁴
Recording	Approx. 9 hr. 30 min.	Approx. 9 hr. 30 min.
Playback* ² through speaker	Approx. 14 hr.	Approx. 14 hr.
Playback using the headphones	Approx. 30 hr.	Approx. 30 hr.

Recording mode	STLP ⁵	SP ⁶
Recording	Approx. 11 hr.	Approx. 10 hr.
Playback* ² through speaker	Approx. 14 hr. 30 min.	Approx. 14 hr. 30 min.
Playback using the headphones	Approx. 32 hr.	Approx. 32 hr.

Recording mode	LP ⁷	Music file (128 kbps/ 44.1 kHz)
Recording	Approx. 12 hr.	–
Playback* ² through speaker	Approx. 15 hr.	Approx. 14 hr.
Playback using the headphones	Approx. 34 hr.	Approx. 30 hr.

(hr. : hours/min. : minutes)

When using Sony NH-AAA rechargeable battery

Recording mode	ST³	STSP⁴
Recording	Approx. 9 hr.	Approx. 9 hr.
Playback ² through speaker	Approx. 13 hr.	Approx. 13 hr.
Playback using the headphones	Approx. 28 hr.	Approx. 28 hr.

Recording mode	STLP⁵	SP⁶
Recording	Approx. 10 hr. 30 min.	Approx. 9 hr.
Playback ² through speaker	Approx. 13 hr. 30 min.	Approx. 13 hr. 30 min.
Playback using the headphones	Approx. 30 hr.	Approx. 30 hr.

Recording mode	LP⁷	Music file (128 kbps/44.1 kHz)
Recording	Approx. 11 hr.	–
Playback ² through speaker	Approx. 14 hr.	Approx. 13 hr.
Playback using the headphones	Approx. 31 hr. 30 min.	Approx. 28 hr.

(hr. : hours/min. : minutes)

¹ The battery life may shorten depending on how you operate the IC recorder.

² When playing back through the built-in speaker with the volume level set to 5

³ ST : Stereo high quality recording mode

⁴ STSP : Stereo standard recording mode

⁵ STLP : Stereo long play recording mode

⁶ SP : Monaural standard play recording mode

⁷ LP : Monaural long play recording mode

Note while accessing

The IC recorder is accessing data when an updating animation appears in the display window or the operation indicator flashes in orange or is lit in red. While the IC recorder is accessing data, do not remove the battery or connect or disconnect the USB AC adaptor (not supplied). Doing so may damage the data.

Note

If the IC recorder is required to process a large amount of data, an updating animation may be displayed for an extended period of time. This is not a malfunction of the IC recorder. Wait until the animation disappears before starting operation.

Step 2: Setting the Clock

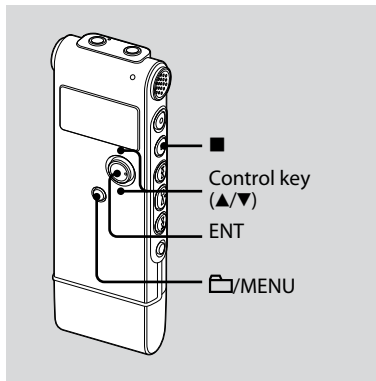

You need to set the clock to use the alarm function or record the date and time.

Clock setting display appears when you insert battery for the first time, or when you insert a battery after the IC recorder has been without battery for a certain period of time. In this case, proceed from step 3.

1 Select "DATE & TIME" in the menu.

- 1 Press and hold /MENU for more than one second.
The menu mode will be displayed in the display window.

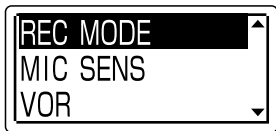

- 2 Press the control key toward ▲ or ▼ to select "DETAIL MENU," and then press ENT.
- 3 Press the control key toward ▲ or ▼ to select "DATE & TIME," and then press ENT.

2 Press the control key toward ▲ or ▼ to select "07y 1m 1d," and then press ENT.

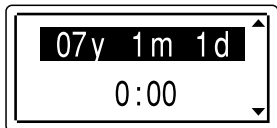

3 Press the control key toward ▲ or ▼ to set the year, month, day, hour, and minute in sequence, and then press ENT.

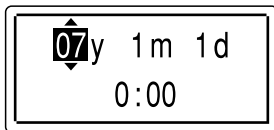

4 Press (stop) to return to the normal display.

Tip

Press /MENU to return to the previous operation.

Note

If you do not press ENT within one minute of entering the clock setting data, the clock setting mode is cancelled and the window will return to the normal display.

To display the current date and time

Press  (stop) to display the current date and time.

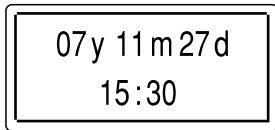

Recording Messages

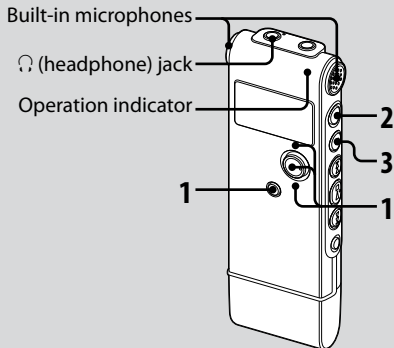

1 Select a folder.

- ① Press /MENU to display the folder selection window.
- ② Press the control key toward ▲ or ▼ to select the folder in which you want to record messages, and then press ENT.

2 Start recording.

- ① Press ● (record/pause) in the stop mode. The operation indicator lights in red. You do not need to press and hold ● (record/pause) while recording. The new message will be automatically recorded after the last recorded message.
- ② Speak into the built-in microphone.

3 Press **■** (stop) to stop recording.

The IC recorder stops at the beginning of the current recording.

Tips

- While recording you can lock all the functions of all the buttons so that you can prevent inadvertent operations by sliding the HOLD switch in the direction of the arrow.
- Messages recorded using this IC recorder will be recorded as MP3 files.
- When you purchase the IC recorder, there are 5 folders already available, and you can record up to 99 messages in each folder.

Notes

- While the operation indicator is flashing or is lit in red or orange, do not remove the battery or connect or disconnect the USB AC adaptor. Doing so may damage the data.
- Noise may be recorded if an object, such as your finger, etc., accidentally rubs or scratches the IC recorder during recording.
- Before making a recording, be sure to check the remaining battery/charging indicator (page 13).
- To avoid replacing battery during a long recording session, use a USB AC adaptor (not supplied) (page 60).
- The maximum recording time varies if you record messages in mixed recording mode.

To	Do this
pause recording*	Press ● (record/pause). During recording pause, the operation indicator flashes in red and " ● " flashes in the display window.
release pause and resume recording	Press ● (record/pause) again. Recording resumes from that point. (To stop recording after pausing recording, press ■ (stop).)
review the current recording instantly	Press ▶■ . Recording stops and playback starts from the beginning of the message just recorded.
review during recording	Press and hold ◀◀ during recording or recording pause. Recording stops and you can search backwards while listening to fast playback sound. After you release ◀◀ , playback starts from that point.

- * One hour after you pause recording, recording pause is automatically released and the IC recorder enters the stop mode.

Selecting the recording mode

Select the recording mode in the "REC MODE" menu.

- ST : High-quality stereo recording mode (44.1 kHz/192 kbps)
You can record with stereo high-quality sound.
- STSP : Standard play stereo recording mode (44.1 kHz/128 kbps)
You can record with stereo sound.
- STLP : Long play stereo recording mode (22.05 kHz/48 kbps)
You can record for a longer time with stereo sound.
- SP : Standard play monaural recording mode (44.1 kHz/32 kbps)
You can record with standard quality sound.
- LP : Long play monaural recording mode (11.025 kHz/8 kbps)
You can record for a longer time with monaural sound.

To record with better sound quality, select the ST or STSP mode.

Monitoring the recording

Connect the supplied headphones to the  (headphone) jack and monitor the recording. You can adjust the monitoring volume by pressing the control key toward VOL + or VOL -, but the recording level is fixed.

Maximum recording time

The maximum recording time of all the folders is as follows.

ICD-UX60

ST mode	STSP mode	STLP mode
6 hr.	9 hr.	24 hr. 5 min.
SP mode	LP mode	
36 hr. 5 min.	144 hr. 30 min.	

ICD-UX70

ST mode	STSP mode	STLP mode
12 hr. 5 min.	18 hr. 5 min.	48 hr. 20 min.
SP mode	LP mode	
72 hr. 30 min.	290 hr. 10 min.	

(hr. : hours/min. : minutes)

ICD-UX80

ST mode	STSP mode	STLP mode
----------------	------------------	------------------

24 hr. 10 min. 36 hr. 20 min. 96 hr. 50 min.

SP mode	LP mode
----------------	----------------

145 hr. 20 min. 581 hr. 20 min.

(hr. : hours/min. : minutes)

Starting to Record Automatically in Response to Sound – the VOR Function

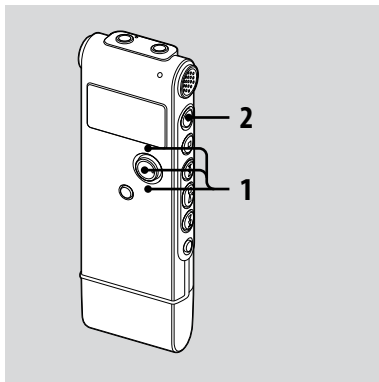

- 1 Press the control key toward ▲ or ▼ to set "VOR" to "ON" in the menu, and then press ENT.
- 2 Press ● (record/pause).
"REC" and "VOR" appear in the display window.

The recording starts when the IC recorder detects sound. The recording pauses when no sound is detected and "VOR" and "●||" flash. When the IC recorder detects sound again, the recording starts again.

To cancel the VOR function

Set "VOR" to "OFF" in the menu.

Notes

- The VOR function is affected by the sound around you. Set "MIC SENS" in the menu according to the recording conditions. If recording is not satisfactory after you have changed the microphone sensitivity, or for an important recording, set "VOR" to "OFF" in the menu.
- If you press ● (record/pause) to pause recording when "VOR" is set to "ON" in the menu, only "●||" flashes.

Recording with an External Microphone

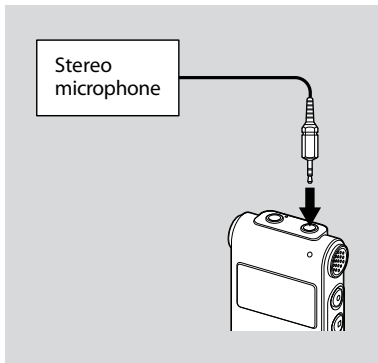

- 1 Connect an external microphone to the  (microphone) jack when the IC recorder is in the stop mode.**

"SELECT INPUT" appears in the display window.

- 2 Press the control key toward  or  to select "MIC IN," and then press ENT.**

- 3 Speak into the external microphone and start recording.**

The built-in microphone is automatically cut off.

If the input level is not strong enough, adjust the microphone sensitivity on the IC recorder.

When a plug in power type microphone is connected, power is automatically supplied to the microphone from the IC recorder.

Recommended microphones

You can use the Sony ECM-CS10 or ECM-CZ10 electret condenser microphone (not supplied).

Recording from Other Equipment

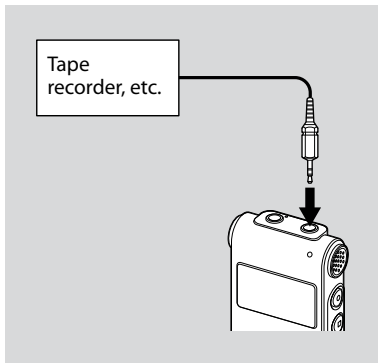

1 Connect other equipment to the IC recorder when the IC recorder is in the stop mode.

Connect the audio output connector (stereo mini-plug) of other equipment to the  (microphone) jack of the IC recorder using an audio connecting cable*.

"SELECT INPUT" appears in the display window.

2 Press the control key toward or to select "AUDIO IN," and then press ENT.

3 Start recording.

The built-in microphone is automatically cut off and the sound from the connected equipment is recorded.

Notes

- When recording from other equipment, the microphone sensitivity cannot be adjusted.
- If the input level is not strong enough, connect the headphone jack (minijack, stereo) of other equipment to the  (microphone) jack of the IC recorder and adjust the volume level on the equipment connected to the IC recorder.

* **Optional audio connecting cables (not supplied)**

	To the IC recorder	To the other equipment
RK-G139 HG	Stereo mini-plug (without resistor)	Mini-plug (monaural) (without resistor)
RK-G136 HG	Stereo mini-plug (without resistor)	Stereo mini-plug (without resistor)

Note

Your dealer may not handle some of the above listed optional accessories. Please ask the dealer for detailed information.

Recording sound from a telephone or a cell phone

You can use the ECM-TL1 headphone-type electret condenser microphone (not supplied) to record sound from a telephone or a cell phone.

For details on how to make the connection, see the operating instructions supplied with the ECM-TL1 microphone.

Notes

- After you have made the connection, check the sound quality of the conversation and the recording level before you start recording.
- If the beep of the telephone or a dial tone is recorded, the conversation may be recorded with lower level of sound. In this case, start recording after the conversation has started.
- The VOR function may not work, depending on the kind of telephone used or the line condition.
- We assume no responsibility whatsoever for any inconvenience, even if you cannot record a conversation using the IC recorder.

Playing Back Messages

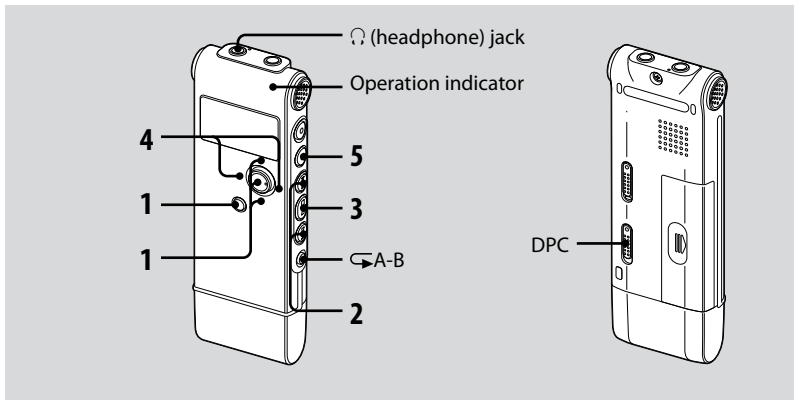

1 Select a folder.

- 1 Press /MENU.
- 2 Press the control key toward ▲ or ▼ to select the folder, and then press ENT.

2 Press or to select the message you want to play.

3 Press to start playback.

The operation indicator lights in green. (When "LED" is set to "OFF" in the menu (page 40), the operation indicator does not light.)

4 Press the control key toward VOL + or VOL - to adjust the volume.

5 Press ■ (stop) to stop playback.

After playing back the last message in the selected folder, the IC recorder stops at the beginning of that message.

Tip

During playback you can lock all the functions of all the buttons so that you can prevent inadvertent operations by sliding the HOLD switch in the direction of the arrow.

Listening with better sound quality



• To listen with the headphones :



Connect the supplied headphones to the  (headphone) jack. The built-in speaker will be automatically disconnected.

• To listen from an external speaker:



Connect an active or passive speaker (not supplied) to the  (headphone) jack.

Quickly locating the point you wish to start playback (Easy Search)

When "EASY SEARCH" is set to "ON" (page 39) in the menu, you can quickly locate the point at which you wish to start playback by pressing  or  repeatedly during playback.



You can go back approx. 3 seconds by pressing  once, or advance approx. 10 seconds by pressing  once. This function is useful for locating a desired point in a long recording.







Searching forward/backward during playback (Cue/Review)

- **To search forward (Cue):** Press and hold  during playback and release it at the point you wish to resume playback.
- **To search backward (Review):** Press and hold  during playback and release it at the point you wish to resume playback.

The IC recorder searches at slow speed with playback sound. This is useful to check one word forward or back. Then, if you press and hold the button, the IC recorder starts to search at higher speed.

When messages are played back to the end of the last message

- When you play back or fast play back to the end of the last message, "MESSAGE END" lights up for 5 seconds and the operation indicator lights up in green. (You cannot hear the playback sound.)
- When "MESSAGE END" and the operation indicator go off, the IC recorder will stop at the beginning of the last message.
- If you press and hold  while "MESSAGE END" is lit, the messages are played back rapidly, and normal playback will start at the point you release the button.
- If the last message is long and you wish to start playback at a later part of the message, press and hold  to go to the end of the message and then press  while "MESSAGE END" is lit to go back to the desired point.
- For messages other than the last one, go to the beginning of the next message and play backward to the desired point.



To	Do this
stop at the current position (Playback Pause function)	Press  (stop) or  . To resume playback from that point, press  .
go back to the beginning of the current message	Press  once.*
go back to previous messages	Press  repeatedly. (During stop mode, keep the button pressed to go back the messages continuously.)
skip to the next message	Press  once.*
skip to the succeeding messages	Press  repeatedly. (During stop mode, keep the button pressed to skip the messages continuously.)

* These operations are for when "EASY SEARCH" is set to "OFF" (page 39).

Various playback modes

You can select "1 FILE" playback (one message/file is played back once), "FOLDER" playback (all the messages/files in the selected folder are played back continuously), "ALL" playback (all the recorded messages/files are played back continuously) in the "PLAY MODE" menu (page 40).

Playing back a message repeatedly

During playback, press and hold  until " 1" appears. The selected message will be played back repeatedly. To resume normal playback, press  again.

Playback with "EFFECT"

Set "EFFECT" to the setting you want in the menu (page 39). However, when you play back using the built-in speaker, the setting is invalid.

Adjusting the playback speed – DPC (the Digital Pitch Control function)

When you slide the DPC switch to "ON," you can adjust the playback speed between +100% and -50% of normal speed in the menu. The message is played back in natural tones thanks to the digital processing function.

1 Slide the DPC switch to "ON."

2 Adjust the playback speed in the "DPC" menu (page 38).

To resume normal playback

Slide the DPC switch to "OFF."

Playing back a specified section repeatedly – A-B Repeat

- 1 During playback, press ↶ (repeat) A-B to specify the starting point A.**
“A-B B?” is displayed.
- 2 Press ↶ (repeat) A-B again to specify the finishing point B.**
“↶ A-B” is displayed and the specified section is played back repeatedly.

To resume normal playback

Press ►■.

To stop A-B Repeat playback

Press ■ (stop).

To change the segment specified for A-B Repeat playback

During A-B Repeat playback, press ↶A-B again to specify a new starting point A. Then specify a new finishing point B, as in step 2.

Note

You cannot specify the finishing point B before the starting point A that has been set.

Playing Back a Message at a Desired Time with an Alarm

You can sound an alarm and start playback of a selected message at a desired time.

You can have the message played back on a specified date, once every week, or at the same time every day.

- 1 Select the message you want to play back with an alarm.**
- 2 Enter the alarm setting mode.**
 - ① Select “ALARM” in the menu and press ENT.
 - ② Press the control key toward ▲ or ▼ to select “ON,” and then press ENT.

3 Set the alarm date and time.

- ① Press the control key toward ▲ or ▼ to select "DATE," a day of the week, or "DAILY," and then press ENT.
- ② **When you select "DATE":**
Set the year, month, day, hour, and minute in sequence, as described in "Step 2: Setting the Clock" on page 15, then press ENT.
When you select a day of the week or "DAILY":
Press the control key toward ▲ or ▼ to set the hour and then press ENT, press the control key toward ▲ or ▼ to set the minute and then press ENT.

The setting process is finished and "(●)" (alarm indicator) appears in the display window.

When the set date and time comes

At the set time, the alarm will sound for about 10 seconds while "ALARM" is displayed in the display window and the selected message will be played back. When the playback ends, the IC recorder will stop automatically at the beginning of that message.

To listen to the same message again

Press ►■, and the same message will be played back from the beginning.

To stop the alarm before the playback starts

Press ■ (stop) while the alarm sound is heard. You can stop the alarm playback even when the HOLD function is activated.

To change the alarm setting

Start from step 2 on page 29.

To cancel the alarm setting

Follow steps 1 and 2-① on page 29. In step 2-②, press the control key toward ▲ or ▼ to select "OFF," and press ENT. The alarm will be cancelled and the alarm indicator will disappear from the display window.

Notes

- You can set only one alarm.
- When the clock has not been set or no messages are recorded, you cannot set the alarm.
- The alarm sounds even if you set "BEEP" to "OFF" in the menu (page 40).
- If the alarm time comes during recording, the alarm will sound after the recording is finished. "🔊" will flash when the alarm time comes.
- When the alarm time comes when the IC recorder is in the menu mode, the alarm will sound and the menu mode will be cancelled.
- The alarm set for "DATE" will be cancelled when the alarm playback finishes.
- If you delete a message on which you have set an alarm, that alarm will be also cancelled.

Erasing Messages

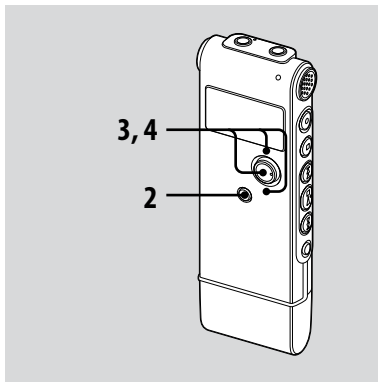

You can erase the recorded messages one by one or all messages in a folder at a time.

Note

Once a recording has been erased, you cannot retrieve it.

Erasing messages one by one

You can erase unwanted messages, retaining all other messages when the IC recorder is in the stop or playback mode. When a message is erased, the remaining messages will advance and be renumbered so that there will be no space between messages.

- 1 Select the message you want to erase.**
- 2 Press and hold /MENU for more than one second to enter the menu mode.**

The menu mode window will be displayed.

- 3 Press the control key toward ▲ or ▼ to select “ERASE A FILE,” and then press ENT.**

The message to be erased will be played back.

- 4 Press the control key toward ▲ or ▼ to select “EXECUTE,” and then press ENT.**

“ERASING ...” appears in the display window and the selected message will be erased.

Erasing all messages in a folder

- 1 Select the folder containing the messages you want to erase when the IC recorder is in the stop mode.**
- 2 Press and hold /MENU for more than one second to enter the menu mode.**

The menu mode window will be displayed.

- 3 Press the control key toward ▲ or ▼ to select “ERASE ALL,” and then press ENT.**
- 4 Press the control key toward ▲ or ▼ to select “EXECUTE,” and then press ENT.**

“ERASING ...” appears in the display window and all messages in the selected folder will be erased.

Moving Message to a Different Folder

Note

When  is displayed for the folder indicator, you cannot move a message (page 50).

- 1 Select the message you want to move.**
- 2 Press and hold /MENU for more than one second to enter the menu mode.**

The menu mode window will be displayed.
- 3 Press the control key toward ▲ or ▼ to select "MOVE," and then press ENT.**

The message to be moved will be played back.
- 4 Press the control key toward ▲ or ▼ to select the folder that you want to move the message into, and then press ENT.**

"EXECUTING..." is displayed and the message is moved to the last position in the destination folder.

When you move a message to another folder, the original message in the previous folder will be deleted.

To cancel moving the message



Press  (stop) before step 4.

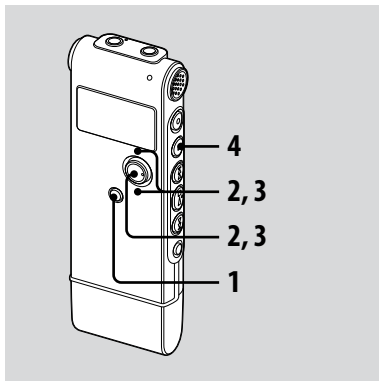

Making Settings for the Menu



- 1** Press and hold /MENU for more than one second to enter the menu mode.

The menu mode window will be displayed.

- 2** Press the control key toward  or  to select the menu item for which you want to make setting, and then press ENT.

- 3** Press the control key toward  or  to select the setting that you want to set, and then press ENT.

- 4** Press  (stop) to exit the menu mode.

Note

If you do not press any button for one minute, the menu mode is automatically cancelled and the window will return to the normal display.

To return to the previous window

Press /MENU during menu mode.

Menu settings

Menu items	Settings	Operation mode (○ : the setting can be made/ — : the setting cannot be made)		
		Stop mode	Playback mode	Recording mode
REC MODE	ST, STSP, STLP, SP, LP	○	—	—
MIC SENS	HIGH (H), LOW (L)	○	—	○
VOR	ON, OFF	○	—	○
DISPLAY	ELAPSE, REMAIN, REC DATE, REC TIME	○	○	○
DPC	n% (n=-50 - +100)	○	○	—
EFFECT	POP, ROCK, JAZZ, BASS1, BASS2, OFF	○	○	—
EASY SEARCH	ON, OFF	○	○	—
PLAY MODE	1 FILE, FOLDER, ALL	○	○	—
BEEP	ON, OFF	○	—	—
LED	ON, OFF	○	—	—
BACKLIGHT	ON, OFF	○	—	—
MOVE	(Folder to be moved)	○	○	—
ALARM	ON, OFF	○	○	—
ERASE ALL	EXECUTE, CANCEL	○	—	—
ERASE A FILE	EXECUTE, CANCEL	○	○	—

Menu items	Settings	Operation mode (○ : the setting can be made/ — : the setting cannot be made)		
		Stop mode	Playback mode	Recording mode
DETAIL MENU		○	—	—
SELECT INPUT	MIC IN, AUDIO IN	○	—	—
DATE&TIME	__y__m__d__:__	○	—	—
FORMAT	EXECUTE, CANCEL	○	—	—
USB CHARGE	ON, OFF	○	—	—

Menu items	Settings (*: Initial setting)
REC MODE	Sets the recording mode. ST: Stereo high-quality recording mode. STSP*: Stereo standard recording mode. STLP: Stereo long play recording mode. SP: Monaural standard play recording mode. LP: Monaural long play recording mode.
MIC SENS	Sets the microphone sensitivity. HIGH (H)*: To record at meeting or in a quiet and/or spacious place. LOW (L): To record dictation, or record in a noisy place.
VOR	Sets the VOR (Voice Operated Recording) function. ON: Recording starts when the IC recorder detects sound and pauses when no sound is heard, eliminating recording during soundless periods. The VOR function is activated when ● (record/pause) is pressed. OFF*: The VOR function does not work.

Menu items	Settings (*: Initial setting)
DISPLAY	<p>Changes the display mode.</p> <p>ELAPSE*: Elapsed playback time of one message</p> <p>REMAIN: During playback, the remaining time of the message When stopped and during recording, the available recording time</p> <p>REC DATE: Date recorded</p> <p>REC TIME: Time recorded</p>
DPC	<p>Sets the DPC (Digital Pitch Control) function.</p> <p>When you set the DPC switch to "ON," you can adjust the speed of the playback in a range from +100% to -50%. Set the speed by 10% for + setting and by 5% for - setting.</p> <p>-30%*</p>

Menu items	Settings (*: Initial setting)
EFFECT	<p>POP: Stresses middle ranges, ideal for vocals.</p> <p>ROCK: Emphasizes high and low ranges for a powerful sound.</p> <p>JAZZ: Emphasizes high ranges for a lively sound.</p> <p>BASS1: The bass sound is emphasized.</p> <p>BASS2: The bass sound is emphasized even more.</p> <p>OFF*: The EFFECT function does not work.</p> <p>Note When playing back messages using a built-in speaker, the EFFECT function does not work.</p>
EASY SEARCH	<p>Sets the easy search function.</p> <p>ON: You can go forward for about 10 seconds by pressing ▶▶▶ and go back for about 3 seconds by pressing ◀◀◀. This function is useful when attempting to locate desired point in a long recording.</p> <p>OFF*: The easy search function does not work. When you press ◀◀◀ or ▶▶▶, a message will be moved forward or backward.</p>

Menu items	Settings (*: Initial setting)
PLAY MODE	<p>Sets the playback mode.</p> <p>1 FILE: When a message is played back, the IC recorder stops at the beginning of the next message.</p> <p>FOLDER*: Messages in one folder are played back continuously.</p> <p>ALL: All messages are played back continuously.</p>
BEEP	<p>Sets whether a beep will be heard or not.</p> <p>ON*: A beep will sound to indicate that an operation has been accepted.</p> <p>OFF: No beep sound will be heard.</p> <p>Note The alarm sounds even if you set "BEEP" to "OFF" in the menu.</p>
LED	<p>Turns the operation indicator on or off during operation.</p> <p>ON*: During recording or playback, the operation indicator lights or flashes.</p> <p>OFF: The operation indicator does not light or flash, even during operation.</p> <p>Note When the IC recorder is connected to a computer, the operation indicator lights or flashes even if "LED" is set to "OFF."</p>

Menu items	Settings (*: Initial setting)
BACKLIGHT	Turns the backlight in the display window on or off. ON*: The backlight in the display window lights up for 10 seconds. OFF: The backlight in the display window does not light, even during operation.
MOVE	The selected message will be moved to the selected folder (page 33). Before attempting to move a message, select the message to be moved and then go to the menu window.
ALARM	Sets the alarm (page 29). ON: To set the alarm, select "ON" and set the date, time or day of the week or choose daily for playback. OFF*: The alarm is cancelled.
ERASE ALL	All messages in the selected folder will be erased (page 32). Press  /MENU to return to the folder window before erasing the messages and select a folder from which all messages are to be erased, and then go to the menu window and select "EXECUTE."
ERASE A FILE	The selected message will be erased (page 32). Before erasing the message, select a message to be erased, and then go to the menu window and select "EXECUTE."

Menu items	Settings (*: Initial setting)
------------	-------------------------------

DETAIL MENU

SELECT INPUT Selects the external input to be recorded that is connected to the  (microphone) jack.

MIC IN*:

Select when you record messages using an external microphone.

AUDIO IN:

Select when you record using other equipment.

DATE & TIME Sets the clock by setting year, month, day, hour, and minute in sequence (page 15).

FORMAT Sets the formatting of the drive.

EXECUTE:

"FORMATTING ..." appears and the drive will be formatted.

CANCEL*:

The drive will not be formatted.

Notes

- Use the IC recorder formatting function to format the memory.
 - When the memory is formatted, all the data stored in the IC recorder will be erased. Once the memory has been erased, you cannot retrieve the data that was erased.
-

Menu items	Settings (*: Initial setting)
USB CHARGE	<p>Sets whether battery will be charged using a USB connection or not.</p> <p>ON*: The battery will be charged.</p> <p>OFF: The battery will not be charged.</p> <p>Note If you use a USB AC adaptor (not supplied) to connect the IC recorder to the AC outlet, you can charge battery regardless this setting.</p>

Using the IC Recorder with Your Computer

System requirements

Operating systems:

Windows Vista® Home Basic
Windows Vista® Home Premium
Windows Vista® Business
Windows Vista® Ultimate
Windows® XP Home Edition Service Pack 2 or higher
Windows® XP Professional Service Pack 2 or higher
Windows® XP Media Center Edition Service Pack 2 or higher
Windows® XP Media Center Edition 2004 Service Pack 2 or higher
Windows® XP Media Center Edition 2005 Service Pack 2 or higher
Windows® 2000 Professional Service Pack 4 or higher
Mac OS X (v10.2.8-v10.4)
Pre-Installed

Note

64 bit OS is not supported.

Hardware environment:

- Port: USB port
- Sound board: Sound cards compatible with any of the supported operating systems

Note

The following systems are not supported:

- Operating systems other than the ones indicated on the left
- Personally constructed computers or operating systems
- Upgraded operating systems
- Multi-boot environment
- Multi-monitor environment

When you are using Windows® 2000 Professional

Install the driver using “SonyRecorder_Driver.exe” in the IC recorder.

Connecting the IC recorder to your computer

You can transfer the IC recorder data onto your computer by connecting the IC recorder to the computer. Remove the USB cap from the IC recorder and then connect the IC recorder to the USB connector of your computer. The IC recorder is recognized by the computer as soon as the connection is made. While the IC recorder is connected to the computer, "CONNECTING" is displayed in the display window of the IC recorder.

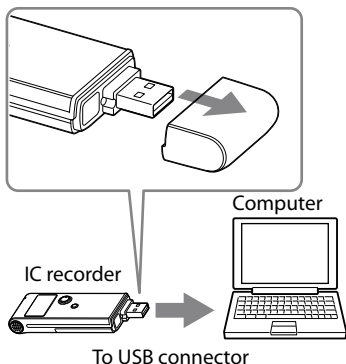

Tip

If the IC recorder cannot be connected to the USB connector of your computer directly, use the supplied USB connection support cable.

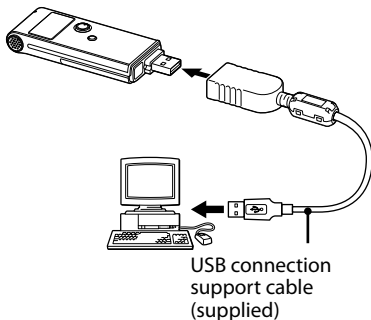

Notes

- If you connect more than two USB devices to your computer, normal operation will not be guaranteed.
- Use of this IC recorder with a USB hub or a USB connection support cable other than the supplied cable is not guaranteed.
- A malfunction may occur depending on the USB devices connected at the same time.
- Before connecting the IC recorder to the computer, make sure that the battery is inserted in the IC recorder.
- It is recommended that you disconnect the IC recorder from the computer when you are not using the IC recorder connected to the computer.

Disconnecting the IC recorder from your computer

Follow the procedures below; otherwise, data may be damaged.

- 1 Make sure that the operation indicator is not flashing.**
- 2 Disconnect the IC recorder from the USB connector of the computer.**

Using Voice Recognition Software

When voice recognition software (not supplied) is installed on your computer, you can transcribe a message into a text file.

Introducing the voice recognition software

Dragon NaturallySpeaking is a speech-recognition software application that allows you to recognize and transcribe your recorded voice in a message and convert it into a text file. For details on Dragon NaturallySpeaking, refer to the operating instructions supplied with Dragon NaturallySpeaking. For information on using Dragon NaturallySpeaking, refer to the documentation supplied with the software. For the latest version and information on the availability of Dragon NaturallySpeaking in each region, please refer to the following home page: <http://www.nuance.com>

■ Notes

- You can use the transcribing feature only when you have installed Dragon NaturallySpeaking Select or Professional Edition (not supplied) on your computer. To install Dragon NaturallySpeaking, your computer should meet the specified system requirements.
- You can transcribe the following messages saved in your IC recorder or on your computer;
 - ST, STSP, STLP or SP recording mode messages (MP3 files)
 - 44.1/16/11 kHz 16-bit WAV files saved on your computer
- You cannot transcribe a message recording the voices of more than one person.

Creating a user file adapted to your recorded speech (Training)

What is “Training”?

Before you can transcribe recorded messages using Dragon NaturallySpeaking, you must create a user file specifically adapted to the sound of your recorded speech. This procedure is called “training.”

When training is complete, Dragon NaturallySpeaking creates a user speech file containing information about your recorded speech.

- Refer to the operating instructions or the help supplied with Dragon NaturallySpeaking, as some parts of training are the same as those required for dictating directly to the computer using a headset microphone.
- Even if you have already created a user speech file with a headset microphone, you should create a separate speech file for the IC recorder to get better recognition accuracy.

Tips on using the IC recorder

When transcribing messages recorded using the IC recorder, the following tips will help you obtain maximum recognition accuracy.

- **Set “REC MODE” to “ST,” “STSP,” “STLP” or “SP” in the menu.**

When creating a user speech file (training), set “REC MODE” to the mode you normally use for voice recognition software.

- **Set “MIC SENS” to “LOW (L)” in the menu.**

- **Hold the IC recorder firmly and start recording.**

Hold the IC recorder so that the microphone is about an inch (2 - 3 cm) from the corner of your mouth, not directly in front of it. This minimizes the sound of your breath in the recordings, enabling maximum recognition accuracy.

Note

Avoid recording in a noisy place, such as on a subway platform, in order to obtain maximum recognition accuracy.

Playing Back Transferred MP3 Files Using the IC Recorder

You can play back MP3 files on your computer using the IC recorder. The maximum playback time (tracks*), when playing MP3 files using the IC recorder, is as follows.

	48 kbps	128 kbps
ICD-UX60	24 hr. (360 tracks)	9 hr. (135 tracks)
ICD-UX70	48 hr. 20 min. (725 tracks)	18 hr. 5 min. (271 tracks)
ICD-UX80	96 hr. 50 min. (1452 tracks)	36 hr. 20 min. (545 tracks)

(hr. : hours/min. : minutes)

* In the case where tracks of 4 minutes each are transferred to the IC recorder.

1 Connect the IC recorder to your computer (page 45).

On the Windows screen; open "My Computer" and make sure that "IC RECORDER" has been newly recognized.

On the Macintosh screen; make sure that a "IC RECORDER" drive is displayed on the desk top.

2 Copy the folder in which the MP3 files are stored to the IC recorder.

On the Windows screen using Explorer, and on the Macintosh screen using Finder, drag and drop the folder onto the IC recorder.

The IC recorder can recognize up to 500 folders. You can copy up to 999 files to one folder and up to 5000 files in total.

3 Remove the IC recorder from your computer, press /MENU, press the control key toward ▲ or ▼ to select the folder you want, and then press ENT.

4 Press or to select the file you want to play.

5 Press to start playback.

6 Press (stop) to stop playback.

To copy MP3 files (Drag and drop)

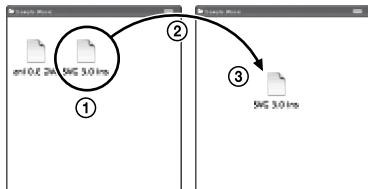

- ① Click and hold,
- ② drag,
- ③ and then drop.

Construction of folders and files

The folders and files are displayed on the computer screen as shown.

The folder indicators in the display window of the IC recorder are as follows:

📁: Folder in which you can record using the IC recorder (They have been already made when you purchase the IC recorder.)

📁: Playback only folders (They are displayed when MP3 files have been transferred to them using a computer.)

Note

You can record messages in up to 5 folders using the IC recorder.

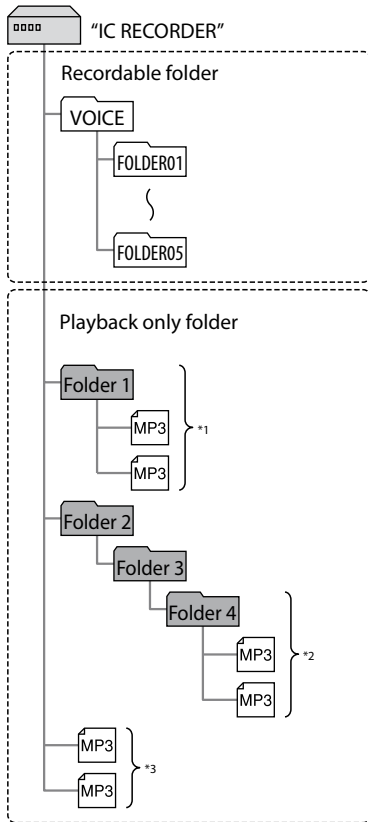

- ¹ The name of a folder in which MP3 files are stored will be displayed on the IC recorder as it is, so it is convenient if you put an easy-to-remember name on the folder in advance.
- ² The IC recorder can recognize up to three levels of folders copied to the IC recorder, that is, up to Folder 4 shown in the figure.
- ³ If you copy MP3 files separately, they are classified as being in "NO FOLDER."

Tips

- You can enter title name or artist name, etc., into MP3 files as ID3 tag information. The ID3 tag information can be displayed on the IC recorder. It is useful if you input the ID3 tag information using the software you use to make the MP3 files on your computer.
- You can display the ID3 tag information in sequence by pressing the control key toward ▲ or ▼.

Notes

- You cannot copy 511 or more folders (except VOICE folders) or files to the root directory that is located immediately below "IC RECORDER" on the computer. This is due to Windows system limitations.
- If no title name or artist name has been entered into the ID3 tag information, "Unknown" will be displayed.



Using the IC Recorder as a USB Mass Storage Device

When the IC recorder is connected to your computer directly or using a USB connection support cable, image data or text data on the computer, as well as messages or files recorded using the IC recorder can be temporarily stored in the IC recorder.

Troubleshooting

Before taking the IC recorder for repair, check the following sections. Should any problem persist after you have made these checks, consult your nearest Sony dealer.

Symptom	Remedy
The IC recorder cannot be turned on.	<ul style="list-style-type: none">• The HOLD switch is set. Slide the HOLD switch in the direction opposite that of the arrow.
The IC recorder does not operate.	<ul style="list-style-type: none">• The battery has been inserted with incorrect polarity (page 11).• The battery is weak (page 13).• The buttons are locked with the HOLD switch (page 8).
No sound comes from the speaker.	<ul style="list-style-type: none">• The volume is turned down completely (page 25).• Headphones are plugged in (page 26).
Sound comes from the speaker even when the headphones are plugged in.	<ul style="list-style-type: none">• If you plug in the headphones not securely during playback, the sound may come from the speaker. Unplug the headphones and then insert them securely.
The operation indicator does not light.	<ul style="list-style-type: none">• "LED" is set to "OFF" (page 40). Display the menu and set "LED" to "ON".
"MEMORY FULL" is displayed and you cannot start recording.	<ul style="list-style-type: none">• The memory is full. Erase some of the messages (page 31) or erase all the messages after you store them on your computer.

Symptom	Remedy
"FILE FULL" is displayed and you cannot operate the IC recorder.	<ul style="list-style-type: none"> • 99 messages have been recorded in the selected  folder or 495 messages (when there are 5 folders) in total have been recorded. Therefore you cannot record another message, or move a message. Erase some of the messages (page 31) or erase all the messages after you store them on your computer.
Recording is interrupted.	<ul style="list-style-type: none"> • The VOR function (page 21) is activated. Set "VOR" to "OFF" in the menu (page 37).
Noise is heard.	<ul style="list-style-type: none"> • An object, such as your finger, etc., accidentally rubbed or scratched the IC recorder during recording so that noise was recorded. • The IC recorder was placed near an AC power source, a fluorescent lamp or a mobile phone during recording or playback. • Plug of the connected microphone was dirty when recording. Clean the plug. • The  (headphones) plug is dirty. Clean the plug.
Recording level is low.	<ul style="list-style-type: none"> • "MIC SENS" (microphone sensitivity) is set to "LOW (L)". Display the menu and set "MIC SENS" to "HIGH (H)" (page 37).
When recording from other equipment, the input level is too strong or not strong enough.	<ul style="list-style-type: none"> • Connect the headphone jack of other equipment to the  (microphone) jack of the IC recorder and adjust the volume level on the equipment connected to the IC recorder.
Playback speed is too fast or too slow.	<ul style="list-style-type: none"> • The playback speed is adjusted in DPC. Slide the DPC switch to "OFF" or display the menu and adjust the speed in DPC again (pages 28, 38).
"--:--" is displayed.	<ul style="list-style-type: none"> • You have not set the clock (page 15).
"--y--m--d" or "--:--" is displayed on the REC DATE display.	<ul style="list-style-type: none"> • The date of recording will not be displayed if you recorded the message when the clock was not set.



Symptom	Remedy
There are fewer menu items displayed in the menu mode.	<ul style="list-style-type: none"> The menu items displayed are different depending on the operation modes (stop mode, playback mode, and recording mode) (pages 35, 36).
The battery life is short.	<ul style="list-style-type: none"> The battery life on pages 13 and 14 is based on playback with the volume level set to 5 (using Sony alkaline battery LR03 (SG)). The battery life may shorten depending on the operation of the IC recorder.
There is no battery power remaining after you have left the battery inserted for long time without using the IC recorder.	<ul style="list-style-type: none"> Even if you do not use the IC recorder, the battery is consumed slightly. The battery life in this case varies depending on humidity or other environmental conditions. Usually, the battery lasts about four months. If you do not intend to use the IC recorder for an extended period of time, it is recommended that you remove the battery.
The charging indicator is not displayed.	<ul style="list-style-type: none"> You are not using rechargeable battery. Rechargeable battery has been inserted with incorrect polarity. "USB CHARGE" of "DETAIL MENU" is set to "OFF" in the menu. To charge the battery using your computer, set it to "ON." While playing back messages using the built-in speaker, you cannot charge the battery.
The charging indicator disappears in the middle of charging.	<ul style="list-style-type: none"> Rechargeable battery other than NH-AAA has been inserted. The rechargeable battery has deteriorated. While playing back messages using the built-in speaker, you cannot charge the battery.

Symptom	Remedy
'COLD' or 'HOT' is flashing instead of the remaining battery/charging indicator.	<ul style="list-style-type: none">• The environmental temperature is out of the range for charging. Charge the battery in an environment with a temperature of 5 °C - 35 °C.
The battery life of the rechargeable battery is short.	<ul style="list-style-type: none">• You are using the rechargeable battery in an environment with a temperature of under 5 °C. Charge the battery in an environment with a temperature of 5 °C - 35 °C.• The IC recorder has not been used for a certain time. Charge and discharge the rechargeable battery using the IC recorder several times.• Replace the old one with new rechargeable battery.• The remaining battery/charging indicator is displayed only for a short time, however, the rechargeable battery is not charged completely. It takes about 8 hours to fully charge exhausted battery.
The changed menu setting does not function.	<ul style="list-style-type: none">• If the battery is removed just after the menu setting is changed, the menu setting may not function.
It takes a long time for the IC recorder to start.	<ul style="list-style-type: none">• If the IC recorder is required to process a large amount of data, it may take longer for the IC recorder to start. This is not a malfunction of the IC recorder. Wait until the start-up display disappears.
The IC recorder does not operate correctly.	<ul style="list-style-type: none">• Take out the battery and insert it again (page 11).
The IC recorder does not operate.	<ul style="list-style-type: none">• You may have formatted the memory of the IC recorder using the computer. Use the IC recorder formatting function to format the memory (page 42).

Please note that recorded messages may be erased during service or repair work.

Error messages

Error message	Cause/Remedy
BATTERY LOW	<ul style="list-style-type: none">You cannot format the memory or erase all the files in a folder because of insufficient battery power. Prepare a new battery to replace the current one.
LOW BATTERY	<ul style="list-style-type: none">Battery is exhausted. Replace the old battery with a new one. Or charge the rechargeable battery or replace the old rechargeable battery with a new one.
MEMORY FULL	<ul style="list-style-type: none">The remaining memory capacity of the IC recorder is insufficient. Erase some messages before recording.
FILE FULL	<ul style="list-style-type: none">When there are already 99 messages in the selected folder or the total number of the file stored in the IC recorder becomes maximum, you cannot record a new message. Erase some messages before recording a message.
FILE DAMAGED	<ul style="list-style-type: none">You cannot play or edit messages, because the data of the selected file is damaged.
FORMAT ERROR	<ul style="list-style-type: none">The IC recorder cannot be turned on using the computer because there is no copy of the control file required for operation. Format the IC recorder using the formatting function in the menu.
PROCESS ERROR	<ul style="list-style-type: none">The IC recorder failed in memory access. Remove and then re-insert the battery.Save a backup copy of your data and format the IC recorder using the menu.

Error message	Cause/Remedy
SET DATE&TIME	<ul style="list-style-type: none">• Set the clock; otherwise, you cannot set the alarm.
NO FILE	<ul style="list-style-type: none">• The selected folder does not have any messages. You cannot move a message or set the alarm, etc., because of this.
PAST DATE/TIME	<ul style="list-style-type: none">• You set the alarm when the time has already passed. Check it and set the appropriate date and time.
FILE PROTECTED	<ul style="list-style-type: none">• The selected message is protected and is now a "Reading only" file. You cannot erase it. Cancel "Reading only" on your computer to edit the message using the IC recorder.
UNKNOWN DATA	<ul style="list-style-type: none">• The data does not have a file format which the IC recorder supports.
CANNOT OPERATE	<ul style="list-style-type: none">• You cannot move a message, because there is more than one folder that has files with same name. Change the file names.• A message in the  folder cannot be moved.
CHANGE FOLDER	<ul style="list-style-type: none">• If there are no MP3 files in the  folder, no folders are displayed in the display window, therefore, the folder setting will be changed.
SYSTEM ERROR	<ul style="list-style-type: none">• A system error other than the above has occurred. Remove the battery and re-insert it.

System limitations

There are some system limitations of the IC recorder. Troubles as mentioned below are not malfunctions of the IC recorder.

Symptom	Cause/Remedy
You cannot record messages up to the maximum recording time.	<ul style="list-style-type: none">• If you record messages in a mixture of ST, STSP, STLP, SP and LP modes, the recordable time varies from the maximum ST mode recording time to the maximum LP mode recording time.• The sum of the number on the counter (elapsed recording time) and the remaining recording time may be less than the IC recorder's maximum recording time.
You cannot display MP3 files in order.	<ul style="list-style-type: none">• If you have transferred MP3 files using your computer, those files may not be copied in order of transfer because of the System limitation.
You cannot enter lower-case characters.	<ul style="list-style-type: none">• Depending on the combination of the characters used for the folder name that was made on your computer, those characters may change to all capitals.
You cannot specify the finishing point B.	<ul style="list-style-type: none">• You cannot specify the finishing point B before the starting point A that has been set.

Recording with Other Equipment

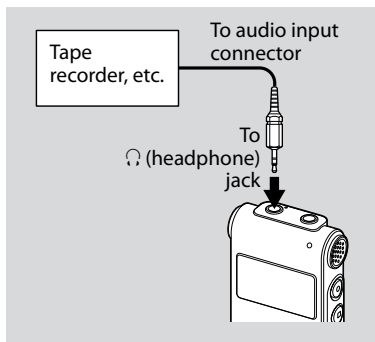

To record the sound of the IC recorder with other equipment, connect the ♪ (headphone) jack of the IC recorder to the audio input connector (mini-jack, stereo) of other equipment using an audio connecting cable*.

* Optional audio connecting cables (not supplied)

	To the IC recorder	To the other equipment
RK-G139 HG	Stereo mini-plug (without resistor)	Mini-plug (monaural) (without resistor)
RK-G136 HG	Stereo mini-plug (without resistor)	Stereo mini-plug (without resistor)

Note

Your dealer may not handle some of the above listed optional accessories. Please ask the dealer for detailed information.

Using a USB AC Adaptor (not supplied)

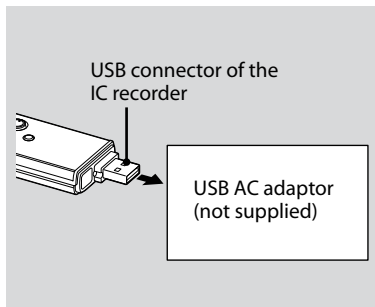

You can charge the rechargeable battery by connecting the IC recorder to an AC outlet using a USB AC adaptor AC-U50A/AC-U50AD (not supplied).

You can charge the battery while you are using the IC recorder, so that it is useful when you want to record for a long time.

Note

Your dealer may not handle some of the above listed optional accessories. Please ask the dealer for detailed information.

1 Remove the USB cap from the IC recorder and connect the IC recorder to a USB AC adaptor (not supplied) .

2 Connect the USB AC adaptor to an AC outlet.

Now you can use the IC recorder while changing the battery.

While the battery is charging, the remaining battery/charging indicator are displayed in an animation.

When the remaining battery/charging indicator indicates "~~full~~", charging is completed. (Charging time: approx. 8 hours*)

When you use the IC recorder for the first time, or after you have not used the IC recorder for a certain time, it is recommended that you charge the battery repeatedly until "~~full~~" is displayed.

If the remaining battery/charging indicator is not displayed, charging has not been done properly. Proceed from step 1 again.

* This is an approximation for the time it takes to charge from no remaining battery power to full battery power at room temperature. It varies depending on the remaining power and the condition of the battery. It also takes more time if the temperature of the battery is low, or if the battery is charged while you are transferring data to the IC recorder.

Disconnecting the IC recorder from the AC outlet

Follow the procedures below; otherwise, data may be damaged.

- 1 If you are recording or playing back a message, press ■ (stop) to put the IC recorder into the stop mode.**
- 2 Make sure that the operation indicator is not flashing.**
- 3 Disconnect the USB AC adaptor from the AC outlet, and then disconnect the IC recorder from the USB AC adaptor.**

■ Notes

- While “**COLD**” or “**HOT**” is being displayed instead of the remaining battery/charging indicator, you cannot charge the battery. Charge the battery in an environment with a temperature of 5 °C - 35 °C.
- While playing back messages using the built-in speaker, you cannot charge the battery.
- During recording (the operation indicator lights or flashes in red) or accessing data (the operation indicator flashes in orange),
 - the IC recorder should not be connected to or disconnected from the USB AC adaptor connected to the AC outlet.
 - the USB AC adaptor connected to the IC recorder should not be connected to or disconnected from the AC outlet.

Doing so may damage the data. If the IC recorder is required to process a large amount of data, the start-up window may be displayed for an extended period of time. This is not a malfunction of the IC recorder. Wait until the start-up display disappears from the display window.

- While a USB AC adaptor (not supplied) is being used, the remaining battery/charging indicator does not appear in the display window.

Precautions

On power

- Operate the unit only on 1.5 V or 1.2 V DC. Use one LR03 (size AAA) alkaline battery or one NH-AAA rechargeable battery.

On safety

- Do not operate the unit while driving, cycling or operating any motorized vehicle.

On handling

- Do not leave the unit in a location near heat sources, or in a place subject to direct sunlight, excessive dust or mechanical shock.
- Should any solid object or liquid fall into the unit, remove the battery and have the unit checked by qualified personnel before operating it any further.

On noise

- Noise may be heard when the unit is placed near an AC power source, a fluorescent lamp or a mobile phone during recording or playback.
- Noise may be recorded when an object, such as your finger, etc., rubs or scratches the unit during recording.

On maintenance

- To clean the exterior, use a soft cloth slightly moistened in water. Do not use alcohol, benzine or thinner.

If you have any questions or problems concerning your unit, please consult your nearest Sony dealer.

Backup recommendations

To avoid potential risk of data loss caused by accidental operation or malfunction of the IC recorder, we recommend that you save a backup copy of your recorded messages on a tape recorder or to a computer, etc.

Specifications

Capacity (User available capacity)

ICD-UX60:

512 MB (approx. 496 MB=520,454,144 Byte)

ICD-UX70:

1 GB (approx. 996 MB =1,044,611,072 Byte)

ICD-UX80:

2 GB (approx. 1.94 GB =2,093,056,000 Byte)

A part of the memory capacity is used as a management area.

Recording time*1

See page 19.

Frequency range

- ST : 40 Hz - 20,000 Hz
- STSP : 40 Hz - 15,000 Hz
- STLP : 60 Hz - 7,500 Hz
- SP : 60 Hz - 10,000 Hz
- LP : 60 Hz - 3,400 Hz

Bit rates and sampling frequencies for MP3 files

Bit rate: 32 - 320 kbps*2, VBR

Sampling frequencies*3: 16/22.05/24/32/44.1/48 kHz

*1 When you are going to record continuously for a long time, you may have to replace the battery with a new one in the midst of recording. For details on the battery life, refer to page 13.

*2 The playback of MP3 files recorded using the IC recorder is also supported.

*3 Not all encoders are supported.

Speaker

Approx. 10 mm dia.

Power output

90 mW

Input/Output

- Microphone jack (minijack, stereo)
 - input for plug in power, minimum input level 0.6 mV, 3 kilohms or lower impedance microphone
- Headphone jack (minijack, stereo)
 - output for 8 - 300 ohms headphones
- USB connector
 - High-Speed USB compatible

Playback speed control

+100% to -50% (DPC)

Power requirements

One LR03 (size AAA) alkaline battery (supplied):

1.5 V DC

One NH-AAA rechargeable battery (not supplied): 1.2 V DC

Operating temperature

5°C - 35°C

Dimensions (w/h/d) (not incl. projecting parts and controls) (JEITA)*4

34.4 × 99.0 × 13.4 mm

Mass (incl. battery) (JEITA)*4

48 g

*4 Measured value by the standard of JEITA (Japan Electronics and Information Technology Industries Association)

Supplied accessories

See page 5.

Optional accessories

Active speaker SRS-T88, SRS-T80

Electret condenser microphone ECM-CS10,
ECM-CZ10, ECM-TL1

Audio connecting cable RK-G136HG,
RK-G139HG (excluding Europe)

Rechargeable battery NH-AAA-2BE

USB AC adaptor AC-U50A/AC-U50AD

Your dealer may not handle some of the above listed optional accessories. Please ask the dealer for detailed information.

Design and specifications are subject to change without notice.

Index

A

A-B Repeat	29
Adjusting the volume	19, 25
Alarm	29, 35, 41

B

Battery	11
Battery life	13
Built-in microphones	6, 17

C

Connecting the IC Recorder to your Computer	45
Cue/Review	26

D

DPC (the Digital Pitch Control function)	28, 35, 38, 63
---	----------------

E

Easy Search	26
Editing Messages	33
Erasing Messages	31
Error Messages	56
External Microphone	22

F

Folder	25, 32, 33
--------------	------------

H

HOLD	8
------------	---

I

Index to Parts and Controls	
Display window	8
Front	6
Rear	6

L

LP	9, 14, 19, 35, 37, 58, 63
----------	---------------------------

M

Maintenance.....62

Menu

ALARM.....35, 41

BACKLIGHT35, 41

BEEP35, 40

DATE & TIME.....36, 42

DETAIL MENU.....36, 42

DISPLAY.....35, 38

DPC.....35, 38

EASY SEARCH.....35, 39

EFFECT.....35, 39

ERASE A FILE35, 41

ERASE ALL35, 41

FORMAT36, 42

LED35, 40

MIC SENS.....35, 37

MOVE35, 41

PLAY MODE.....35, 40

REC MODE.....35, 37

SELECT INPUT36, 42

USB CHARGE.....36, 43

VOR.....35, 37

Message number.....8, 9

Microphone sensitivity.....9, 35, 37

Monitoring the recording19

Moving Message.....33, 35, 41

N

Noise.....62

P

Pause recording.....18, 21

Playback modes.....28

Playing Back Message.....25

Playing Back MP3.....48

Precautions.....62

Preparing a Power Source.....11

R

Rechargeable battery.....11, 14

Recording Messages.....17

Recording mode19, 35, 37

Recording time19

Recording with an External Microphone...22

Recording with Other Equipment59

Remaining battery/Charging indicator8, 9

S

Setting the Clock	15
SP	9, 14, 19, 35, 37, 58, 63
Specifications	63
ST	9, 14, 19, 35, 37, 58, 63
STLP	9, 14, 19, 35, 37, 58, 63
STSP	9, 14, 19, 35, 37, 58, 63
System Limitations	58

T

Troubleshooting.....	52
----------------------	----

U

USB AC Adaptor.....	60
USB Mass Storage Device.....	51

V

VOR Function	21, 35, 37
--------------------	------------

Trademarks

- Microsoft, Windows and Windows Vista are registered trademarks or trademarks of the Microsoft Corporation in the United States and/or other countries.
- Apple, Macintosh and Mac OS are trademarks of Apple Inc., registered in the USA and other countries.
- Nuance, the Nuance logo, Dragon NaturallySpeaking, and RealSpeak are trademarks and/or registered trademarks of Nuance Communications, Inc., and/or its affiliates in the United States and/or other countries.
© 2007 Nuance Communications, Inc.
All rights reserved.
- MPEG Layer-3 audio coding technology and patents licensed from Fraunhofer IIS and Thomson.

All other trademarks and registered trademarks are trademarks or registered trademarks of their respective holders. Furthermore, "™" and "®" are not mentioned in each case in this manual.

<http://www.sony.net/>

Download from [Www.Somanuals.com](http://www.Somanuals.com). All Manuals Search And Download.

Free Manuals Download Website

<http://myh66.com>

<http://usermanuals.us>

<http://www.somanuals.com>

<http://www.4manuals.cc>

<http://www.manual-lib.com>

<http://www.404manual.com>

<http://www.luxmanual.com>

<http://aubethermostatmanual.com>

Golf course search by state

<http://golfingnear.com>

Email search by domain

<http://emailbydomain.com>

Auto manuals search

<http://auto.somanuals.com>

TV manuals search

<http://tv.somanuals.com>