

SHURE®

Owner's Manual

VIDEO/HI-FI SYSTEM EXPANDER

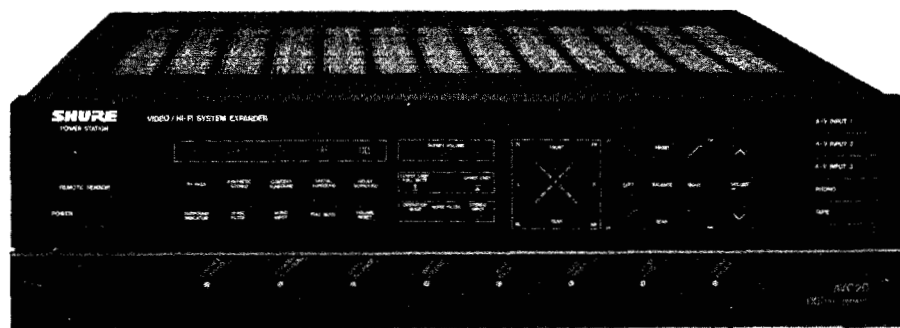

AVC20

222 HARTREY AVENUE EVANSTON, ILLINOIS 60202-3696 U.S.A TELEPHONE (312) 866-2200 CABLE SHUREMICRO

SPECIAL FEATURES

- The AVC20 offers the choice of three different types of surround-sound effects: Dolby Surround, Spatial Surround, or Concert Surround.
- The AVC20 is equipped with Four Power amplifiers.
- The AVC20 allows central control of most video equipment.
- 4 types of easy to operate volume balance controls.
- The AVC20 is equipped with a sound memory circuit.
- The Surround Indicator can be switched on or off.
- The AVC20 can be used as a high output stereo amplifier when in the Balanced Transformerless (BTL) mode.

NOTICE

This equipment generates and uses radio frequency energy and if not installed and used properly, that is, in strict accordance with the manufacturer's instructions, may cause interference to radio and television reception. It has been type tested and found to comply with the limits for Class B computing device in accordance with the specifications in Subpart J of Part 15 of FCC Rules, which are designed to provide reasonable protection against such interference in a residential installation. However, there is no guarantee that interference will not occur in a particular installation. If this equipment does cause interference to radio or television reception, which can be determined by turning the equipment off and on, the user is encouraged to try to correct the interference by one or more of the following measures:

- reorient the receiving antenna
- relocate the equipment with respect to the receiver
- move the equipment away from the receiver
- plug the equipment into a different outlet so that equipment and receiver are on different branch circuits.

If necessary, the user should consult the dealer or an experienced radio/television technician for additional suggestions. The user may find the following booklet prepared by the Federal Communications Commission helpful:

"How to Identify and Resolve Radio-TV Interference Problems"





"This booklet is available from the US Government Printing Office, Washington, D.C., Stock No. 004-000-00345-4"

Caution: To prevent electric shock do not use this (polarized) plug with an extension cord, receptacle or other outlet unless the blades can be fully inserted to prevent blade exposure.

Attention: Pour prévenir les chocs électriques ne pas utiliser cette fiche polarisée avec un prolongateur, une prise de courant ou une autre sortie de courant, sauf si les lames peuvent être insérées à fond sans en laisser aucune partie à découvert.

TABLE OF CONTENTS

Special features	2
Surround-sound effects	3
Installing the glass door	3
Locating speakers	4
Connection of speakers	5
Function names and operations — Front panel	6
Function names and operations — Rear panel	8
Volume — Balance control	10
Use of wireless remote control	11
Use of the image enhancer switch	14
Applications	15
Example of use with a variety of different equipment	
(Monophonic video deck)	20
(STEREO video deck)	21
(Two video decks)	22
(Video deck and video disc player)	24
(TV equipped with video input terminal)	26
(Overall connections)	28
Cautions on usage	30
Troubleshooting	31
Specifications	31

 <div style="border: 1px solid black; padding: 5px; text-align: center; margin: 5px 0;"> CAUTION RISK OF ELECTRIC SHOCK DO NOT OPEN </div> 	<p>WARNING: TO PREVENT FIRE OR SHOCK HAZARD, DO NOT EXPOSE THIS APPLIANCE TO RAIN OR MOISTURE</p> <p> The lightning flash with arrowhead symbol, within an equilateral triangle, is intended to alert the user to the presence of uninsulated "dangerous voltage" within the product's enclosure that may be of sufficient magnitude to constitute a risk of electric shock to persons.</p> <p> The exclamation point within an equilateral triangle is intended to alert the user to the presence of important operating and maintenance (servicing) instructions in the literature accompanying the appliance</p>
<p>Caution: To reduce the risk of electric shock, do not remove cover (or back). No user serviceable parts inside. Refer servicing to qualified service personnel.</p>	

SURROUND-SOUND EFFECTS

Surround-sound

- The AVC20 is equipped with three types of surround processors which provide a sense of presence and expansion.
- Every day, we are exposed to sounds coming from our surroundings. Some sounds reach our ears directly from the source, some indirectly reflected off of walls or the ceiling. Sounds of voices reach us from behind, sounds of cars reach us from the side. Sounds coming from all around us are called "surround-sounds".
- In order to recreate with as much precision as possible, that special sound heard in movie theaters, speakers are placed both in front of and behind the listeners. The reason that sound from the television in our homes is so different from the sound in movie theaters is because sound from a television only comes from in front of the viewer. With a surround system, the spatial information encoded in a film's sound track will be reproduced in the home listening area.
- The sound from a TV equipped with a single speaker (or two speakers with stereo televisions) sounds very different from the actual, "live" sound.
- The AVC20 is equipped with three types of surround processors to recreate that sense of presence and let you enjoy surround-sound in the privacy of your own home.

Surround Processors

■ DOLBY SURROUND*

Provides the optimal sound when watching recent movies, especially those encoded with the DOLBY SURROUND or DOLBY STEREO process. The front speakers provide the normal stereo effect, while the rear speakers reproduce the surround signals. This position provides excellent results when watching television programs, video software, video discs, or videotapes of stereo television broadcasts.

■ CONCERT SURROUND

This provides the best results when watching old movies or video recordings of concerts. The front speakers provide the normal stereo effect, while the rear speakers provide reverberation like that heard in concert halls. The reverberation time can be adjusted using the CONCERT SURROUND Control.

■ SPATIAL SURROUND

Use this when watching live sports games to reproduce that stadium feeling.

* Manufactured under license from Dolby Laboratories Licensing Corporation. Additionally licensed under one or more of the following patents: U.S. numbers 3,632,886, 3,746,792, and 3,959,590; Canada numbers 1,004,603 and 1,037,877. "Dolby" and the double-D symbol are trademarks of Dolby Laboratories Licensing Corporation.

INSTALLING THE GLASS DOOR

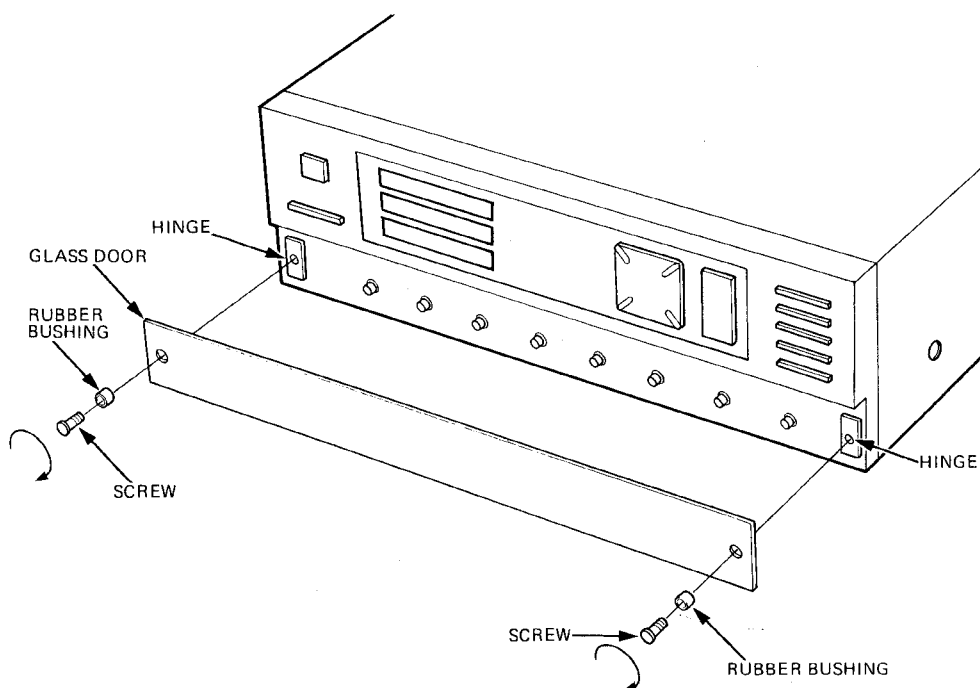

LOCATING SPEAKERS

Speaker location will depend in each case on the size and shape of the specific room in which the Home Theater System is installed. The diagrams below may be used as a general guide to speaker placement in rooms of various shapes. To avoid interference with the tv picture, speakers without special magnetic shielding should ordinarily be more than 0.6m (2 ft) from the screen. In each case, it is best to consult the tv and loudspeaker manufacturers.

When a Center speaker is employed (See page 18), it is most conveniently mounted above or below the screen, but always as close to the screen centerline as possible.

Because very low frequencies are nondirectional in a room, a subwoofer (See page 8) can usually be located almost anywhere convenient in the room. However, depending on room acoustics and the particular subwoofer, some locations may be clearly superior to others. Consult the subwoofer manufacturer for specifics.

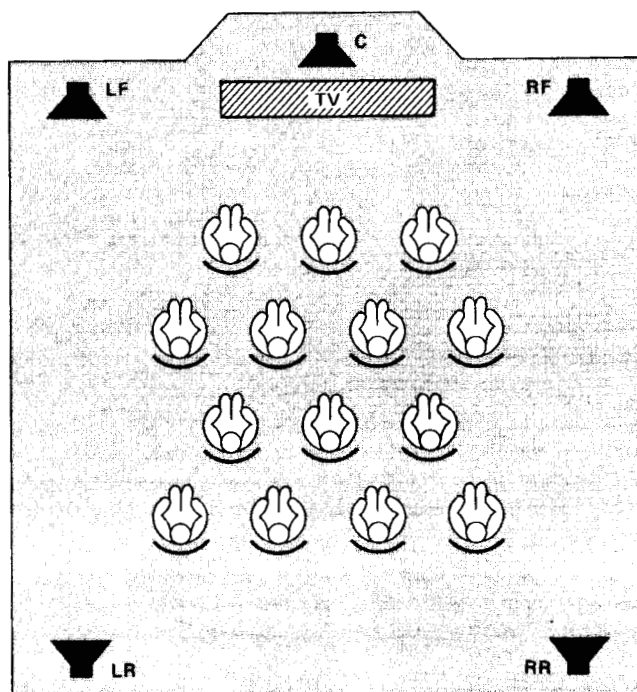
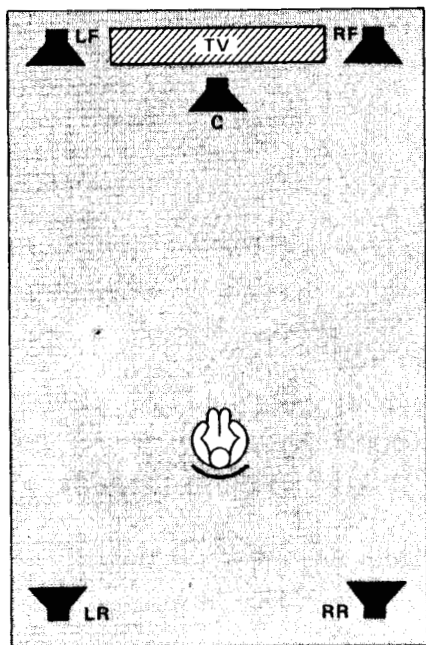
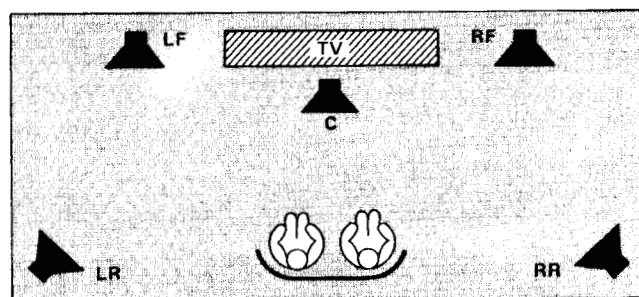
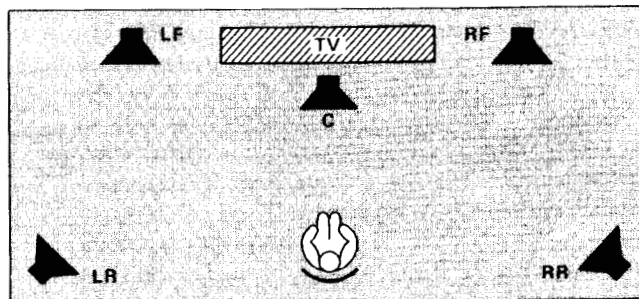
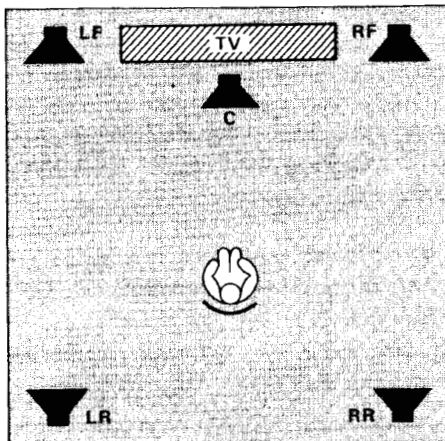

LOCATING SPEAKERS

CONNECTION OF SPEAKERS

Connection of 4 Speakers

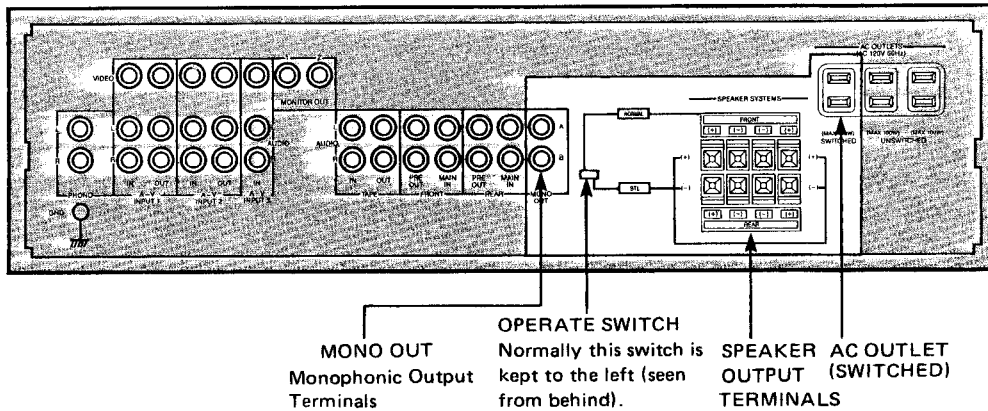

There is one set of four speaker output terminals. Use speakers with an impedance of 8 to 16 ohms.

Normal Speaker Connection

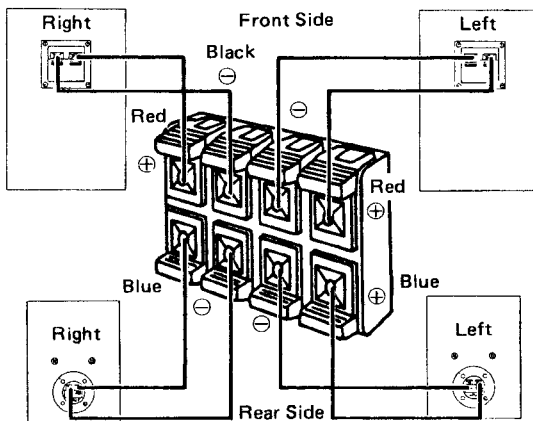

Remove your finger from the lever, and pull on the cord to be sure that it is properly connected.

Put the Operation Switch in the **NORMAL** position.

Connection of Speaker Cables

1. If the bare speaker wire is too short, strip off the vinyl and make the exposed wires the same length. 10mm (3/8 in.)



EXAMPLE: With a speaker terminal on the bottom side.

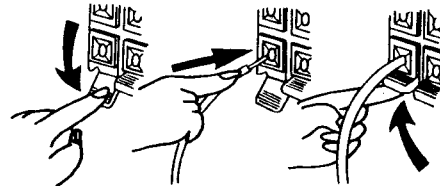

2. Press down the lever and insert the cord. Use a "+" terminal for the + side of the speaker and a "-" terminal for the - side.
3. Raise the lever.
Be sure that the wire does not stick out from the cord and come into contact with wire of another cord, as this may damage the equipment.

FUNCTION NAMES AND OPERATIONS-FRONT PANEL

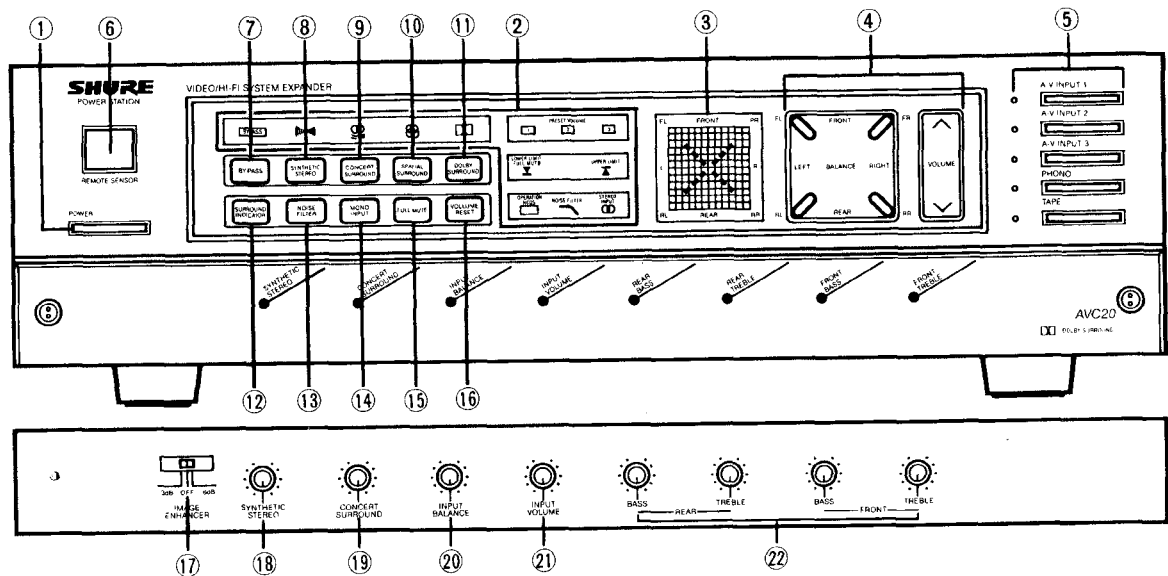

Function Names and Operations

① Power Switch (POWER)

Use this switch to turn the power of the AVC20 on and off. After turning on, allow approximately 4 seconds to pass before using. During this time, the FULL MUTE indicator  on the concentrated indicator panel will flash, indicating that the set is in the stand-by mode.

② Concentrated Indicator Panel

Indicators light up according to the operations performed on the AVC20.

③ SURROUND INDICATOR

Three red LEDs are displayed, depending on the level at the AVC20 speaker outputs.

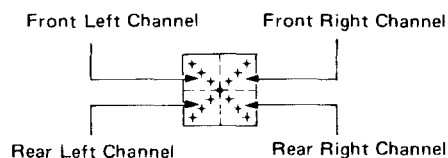

④ Volume and Balance Controls

(For details, refer to page 10)

⑤ Input Selector Switches and Indicators (AUDIO/VIDEO SELECTOR)

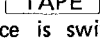
- Use these switches to select the program source.
- When the  switch is pressed, the sound source is switched to the component connected to the TAPE input terminals while the video source is provided by the A-V INPUT whose selector switch is pressed.
(For details, refer to page 18)

⑥ REMOTE SENSOR

This is the window used for receiving the signal from the supplied wireless remote control unit.

⑦ BYPASS

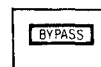

- Use this position when you wish to obtain stereo sound without any surround effect.
- Sound is produced only from the two front speakers.

⑧ SYNTHETIC STEREO

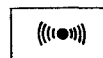

- Use this switch to obtain simulated stereo sound from monophonic signals.
- Use the SYNTHETIC STEREO volume control located inside the control panel door to adjust the stereo effect.

- This function can also be used to expand a stereo source.

⑨ CONCERT SURROUND



- This is the best position for viewing televised concerts or old movies.
- Use the CONCERT SURROUND volume control located inside the control panel door to adjust the reverberation time.



⑩ SPATIAL SURROUND

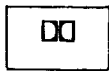

- This is the best position for viewing sports or music programs.

- ⑪ **DOLBY SURROUND** ● This is the best position for viewing movies.



- The AVC20 is equipped with the proper Dolby Surround decoder for use especially with video software containing the DOLBY SURROUND mark  or movies in which the DOLBY STEREO mark  appears at the end.
- The Dolby Surround system is manufactured under licence from Dolby Laboratories Licencing Corporation.
- * Refer to page 3 for more detailed information.

⑫ **Surround Indicator Switch (SURROUND INDICATOR)**

- Use this switch to turn the SURROUND INDICATOR on or off.
- Press once to turn the SURROUND INDICATOR off if it is distracting.

⑬ **NOISE Filter Switch (NOISE FILTER)**



- This filter reduces the hissing noise produced when viewing old movies for example.

⑭ **MONO INPUT**

- Depress when using a monophonic video deck.
- The STEREO indicator  will turn off.

⑮ **FULL MUTE**

- Depress to cut off sound momentarily.
- When depressed, the  indicator will light.
- Press again to return to the original volume.

⑯ **Volume Reset Switch (VOLUME RESET)**

- Use this to make the volume from each speaker equal.
- As the volume will be low when this is done, use the volume switches ④ to readjust the balance.

⑰ **Image Enhancer Switch (IMAGE ENHANCER)**

- Use this switch to make the contours of the picture clearer.
- 3 dB
- 6 dB
- OFF
- * As the image enhancer makes all details of the picture clearer, small white spots on the screen may also stand out, thus making the picture actually harder to see. If this is the case, turn the function OFF.

⑱ **Synthetic Stereo Control (SYNTHETIC STEREO)**

- Use this control to adjust the effect when the SYNTHETIC STEREO switch ⑧ is turned on.
- Expansion becomes greater when turned clockwise, and lower when turned counterclockwise.

⑲ **Concert Surround Control (CONCERT SURROUND)**

- Use this control to adjust the effect when the CONCERT SURROUND button ⑨ is depressed.
- The reverberation time is increased when turned clockwise.

⑳ **Input Balance Control (INPUT BALANCE)**

- Use this to balance the left and right channels of the input source.

㉑ **INPUT VOLUME**

- Use this control to set the maximum volume. (Refer to page 10 for details.)

㉒ **Tone Control**

Treble and bass tones can be controlled for both the front and rear speakers.

- Use the FRONT control to adjust the tone of the front speakers, and the REAR control for the rear speakers.
- Use the TREBLE and BASS controls to adjust treble or bass.
- Turn clockwise to increase the effect, or counterclockwise to decrease.

FUNCTION NAMES AND OPERATIONS-REAR PANEL

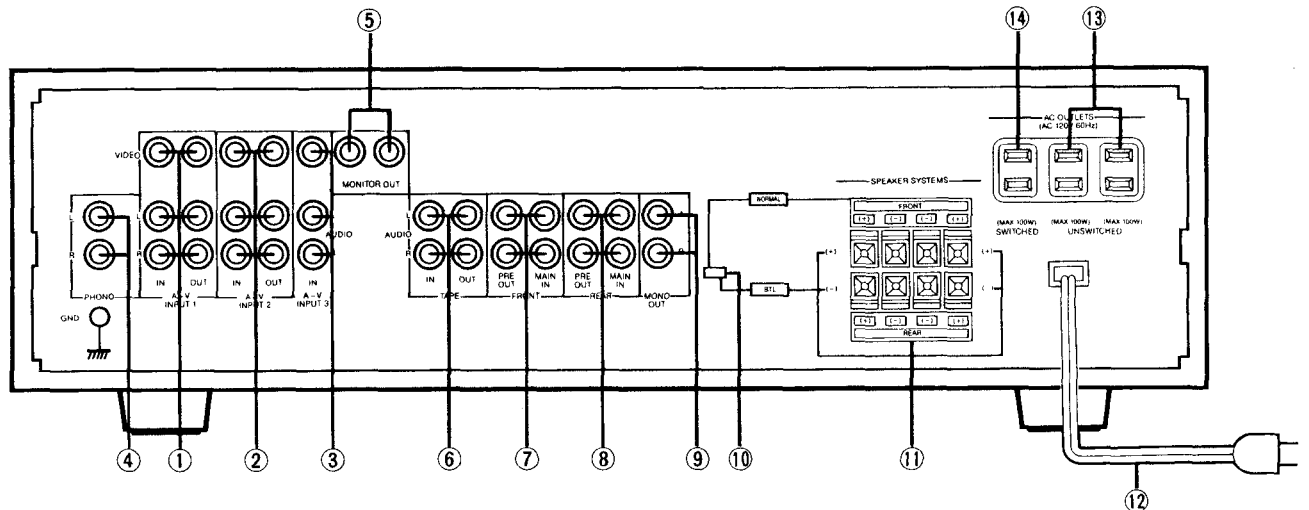

Function Names and Operations

- ① **A-V INPUT 1 Input/Output Terminals**
- ② **A-V INPUT 2 Input/Output Terminals**
A-V INPUT ① and ② Input/Output Terminals are used for connection of components on which recording is possible, such as a video deck.
- ③ **A-V INPUT 3 Input Terminals**
A-V INPUT ③ Input Terminals are used for connection of components for which only playback is possible, such as video disc players compact disc players, or television tuners.
- ④ **PHONO Input Terminals**
PHONO Input Terminals are used for connection of a Phono Turntable without preamp.
NOTE: Selected input signals (including PHONO and TAPE) appear at output jacks of A-V INPUT 1, A-V INPUT 2 and TAPE.
- ⑤ **Monitor Output Terminals (MONITOR OUT)**
 - These are used for connection to video input terminals of color monitors or televisions equipped with video input terminals.
 - There are two independent output terminals, making possible the connection to two components.
- ⑥ **Tape Input/Output Terminals (TAPE IN/OUT)**
 - Connect an audio cassette deck or the like to these terminals.
(For details, refer to page 18)
- ⑦ **These are front speaker pre-amplifier output and main amplifier input terminals.**
- ⑧ **These are rear speaker pre-amplifier output and main amplifier input terminals.**
 - Use these for connection of an equalizer or signal processor or of a pre-amplifier or main amplifier other than those of the AVC20.
 - Usually, use the AVC20 with the pre-amplifier output terminals connected to the main amplifier input terminals with the supplied U-shaped connecting pin.
 - The AVC20 can also be used in the BTL mode or as a surround processor. For details, refer to pages 15 and 17.
- ⑨ **Monophonic output Terminal MONO OUT A, B**
 - Use these outputs for connection to a Sub-woofer or center channel amplifier and speaker (A sub-woofer will transduce only low-frequency signals, a full-range speaker will handle the complete audio spectrum.)
 - The output level is approximately 1V at a rated input. Match with the input sensitivity of the speaker or other component to be connected.
 - The output signal of terminals ⑨ is a mixture of the front left and right channels. When the volume of the front speakers is high, the MONO output level also increases. This can be used as a center channel output.
(For details, refer to page 18).

⑩ **Operation Selector Switch**

Use this switch to select NORMAL or Balanced Transformerless (BTL) operation.

● **NORMAL Operation**

- Use this position for independent operation of the four power amplifiers.
- This is the position in which the AVC20 is normally used.
- In this position, the AVC20's output is 30W x 4.

● **BTL Operation**

- Use this position to use the AVC20 as a stereo amplifier, with the four power amplifiers combined in groups of two.
- In this position, the AVC20's output is 60W x 2.

CAUTION
TURN OFF AVC20 POWER BEFORE
OPERATING THIS SWITCH.
(For details, refer to page 15)

⑪ **Speaker Connection Terminals**

Use these to connect speakers.

(Refer to page 5 for details.)

⑫ **Power Cord**

Plug this into an ac wall outlet, 120 Vac 60Hz.

⑬ **Supplementary Power Outlets (AC OUTLETS)**

■ **SWITCHED**

- This outlet operates only when the AVC20 power is on.
- Use this outlet to plug in equipment with a maximum power consumption of 100W.
- Use this outlet for example for a self-powered subwoofer.

⑭ **Supplementary Power Outlets (AC OUTLETS)**

■ **UNSWITCHED**

- These outlets can be used regardless of whether the AVC20 power is on or not.
- Use these outlets to plug in equipment with a maximum power consumption of 100W.

WARNING



■ **Power Consumption of Outlets**
Never use the AC OUTLETS with equipment which consumes more power than is indicated on the panel (for example, toasters or hair dryers). This could damage the equipment or result in a fire.

VOLUME-BALANCE CONTROL

The AVC20 is equipped with 4 built-in power amplifiers. The volume of each of these can be controlled separately.

Volume Control



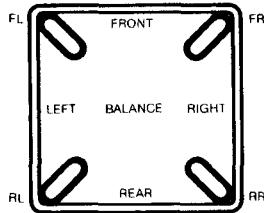

- Press the upper side  to simultaneously increase the volume of all four speakers.
- Press the lower side  to simultaneously decrease the volume of all four speakers.
- Volume increases faster than it decreases.

Balance Control





- FL:** Increases the volume of the front left speaker.
- FR:** Increases the volume of the front right speaker.
- RL:** Increases the volume of the rear left speaker.
- RR:** Increases the volume of the rear right speaker.
- FRONT:** Causes the surround image to slowly travel towards the front.
- REAR:** Causes the surround image to slowly travel towards the rear.
- LEFT:** Causes the surround image to slowly travel towards the left.
- RIGHT:** Causes the surround image to slowly travel towards the right.

- When the volume of one of the four speakers reaches the maximum level, the  indicator flashes. When the volume of one of the four speakers reaches the minimum level, the  indicator flashes.

Input Volume

- The Input Volume control located behind the control panel door is used to set the maximum volume so that the volume of none of the speakers exceeds a certain level.

Adjusting the Input Volume

- ① First set the INPUT VOLUME control to the minimum. (Number ② inside the control panel door)
- ② Use the Volume up control and set the AVC20 volume to the maximum (the  indicator will flash), then bring it down 5 steps. (Press the Volume down  button 5 short times)
- ③ Next gradually increase the Input Volume until a comfortable listening level is reached.

This is described by the following diagram.

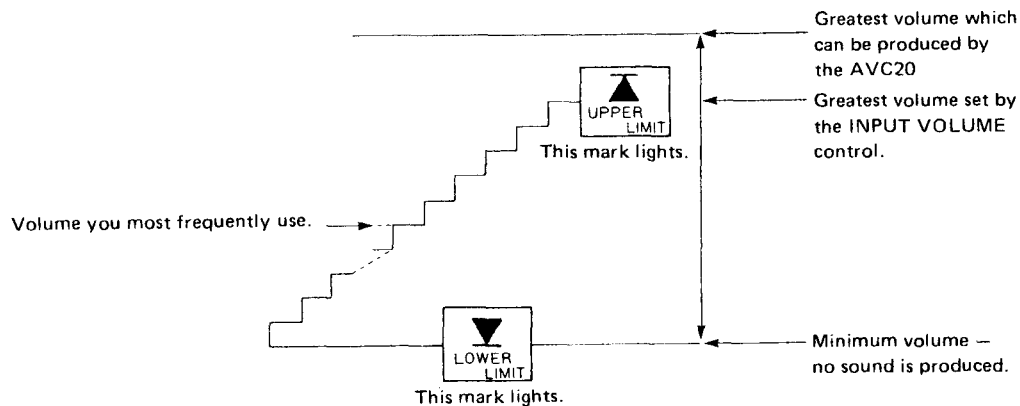

Dolby Surround and Input Volume

The output level on some VHD video disc players or laser disc players is quite high. When this is the case, DOLBY SURROUND sound may be distorted. Should this happen, lower the INPUT VOLUME.

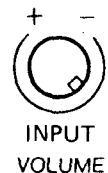

USE OF WIRELESS REMOTE CONTROL

A variety of operations are possible from a comfortable distance when using the wireless remote control unit.

Remote Control Sensor

- When using the wireless remote control, always point it toward the remote control sensor on the AVC20.
- This wireless remote control unit uses infrared rays. Exposure of the sensor on the AVC20 to strong fluorescent light or the like could result in malfunction. Locate the AVC20 to minimize exposure to surrounding light.
- The wireless remote control unit should be used within vertical or horizontal angles of approximately 30° with respect to the sensor on the AVC20 at a distance up to 7m (20ft).

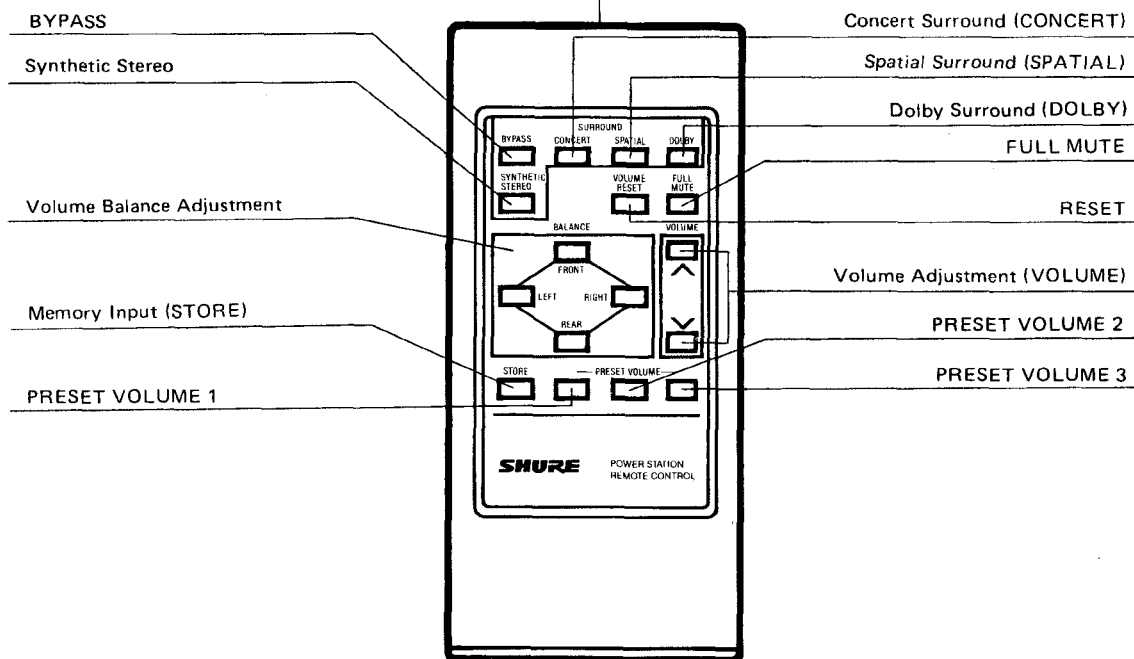
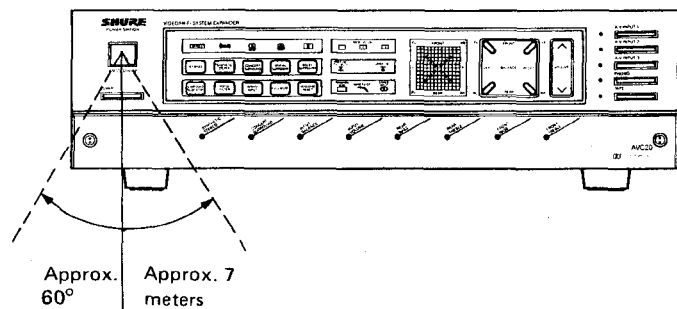

INSERTING BATTERIES

- Remove the cover on the rear.
- Insert two size "AA" batteries, pay close attention to the correct polarity (+ and -).
- Replace the cover.

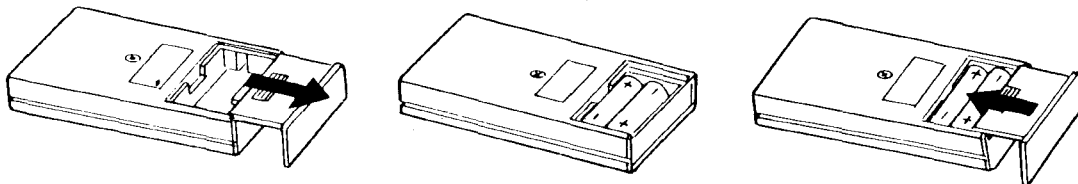

CAUTIONS ON BATTERIES

- Use size "AA" batteries.
- Replace the batteries when distance of operation decreases.
- The replacement interval depends on the number of times used, but it is recommended that the batteries be replaced at least once every year.
- When not using the remote control unit for an extended period of time, remove the batteries.
- Do not use an old battery with a new one or two batteries of different types (for example, one dry cell and one alkaline battery), as this may result in leakage or damage to the unit.
- Should leakage occur, wipe thoroughly and insert new batteries.
- Do not short circuit, disassemble, or throw batteries into flames.
- Do not place objects on top of the remote control unit, as the batteries will wear out if a key is held down.
- Always strictly observe cautions written on batteries.
- Do not dispose of batteries together with flammable garbage (where applicable).

1. SURROUND-SOUND EFFECT SELECTION

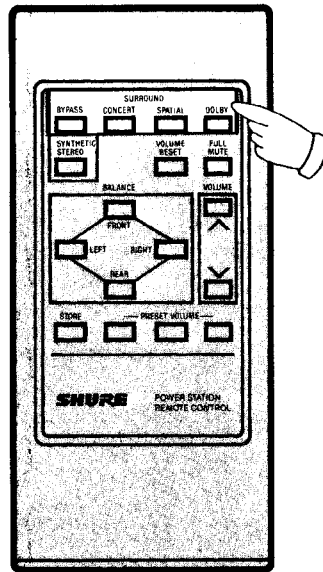

The AVC20 provides a choice of 3 surround effects, depending upon the program or software being viewed.

- For programs for which the surround effect is not necessary, such as news broadcasts, press the **BYPASS** button. Sound can be heard from the front speakers only.
- **DOLBY** – Press this button for movies, etc.
- **SPATIAL** – Press this button for sports programs etc.
- **CONCERT** – Press this button for concerts or old movies.

**Refer to page 3 for more detailed information.*

2. Use of Volume Button

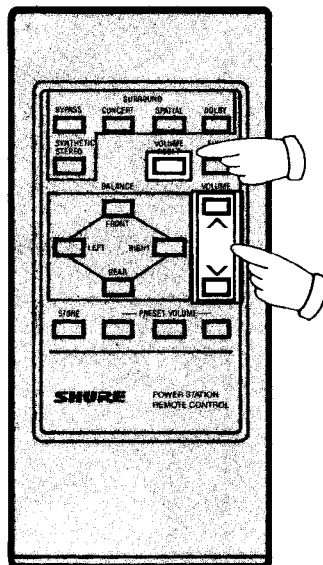

First press the **RESET** button (there is no need to keep it pressed down), then press the ▲ side of the **VOLUME** button. When held down, the volume gradually increases. If the volume becomes too loud, press the ▼ side. When the desired volume is reached, release the button.

3. Adjusting Volume Balance

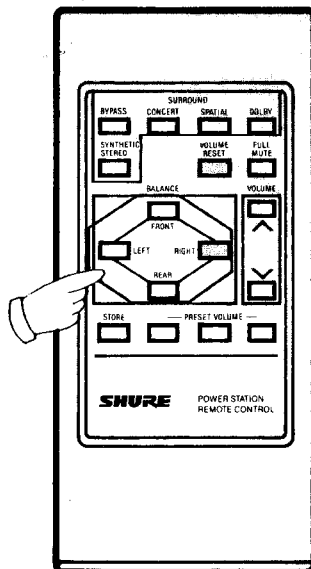

From the listening position, adjust the volume balance, using the controls described below, to feel engulfed from all sides while maintaining a good front stage orientation. Readjust the overall volume.

- FRONT** Causes the surround image to slowly travel towards the front.
- REAR** Causes the surround image to slowly travel towards the rear.
- LEFT** Causes the surround image to slowly travel towards the left.
- RIGHT** Causes the surround image to slowly travel towards the right.

4. Use of the Preset Volume Buttons

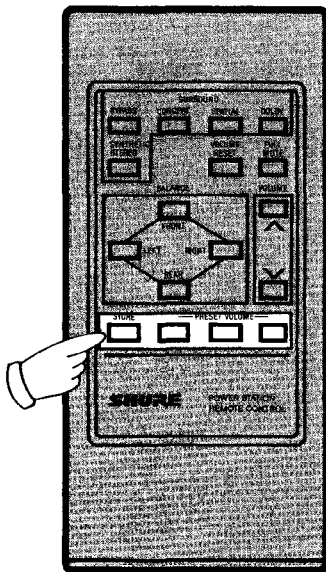

It is possible to place in the memory three different volume adjustment settings. When the optimal adjustment is reached as shown in number 3 above, press the STORE button. (There is no need to keep it pressed in.) When this is done, the PRESET VOLUME indicators (1 , 2 , and 3) on the AVC20 will flash. While the indicators are flashing (approximately 5 seconds), press one of the PRESET VOLUME buttons on the wireless remote control unit. The volume adjustment is now stored in the memory. Simply press the desired button to obtain the preset volume adjustment later on.

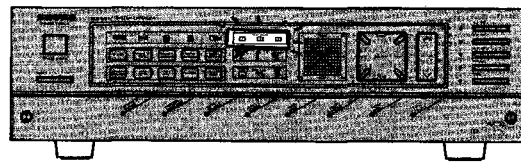

A volume adjustment setting will remain stored in the memory for approximately one week after the power is turned off.

To change a preset volume adjustment setting, adjust the volume as desired, and follow the same procedure as in step 4 above. The previous setting in the memory will be erased.

The preset volume adjustment setting can only be obtained by using the remote control unit.

5. Use of Full Mute Button

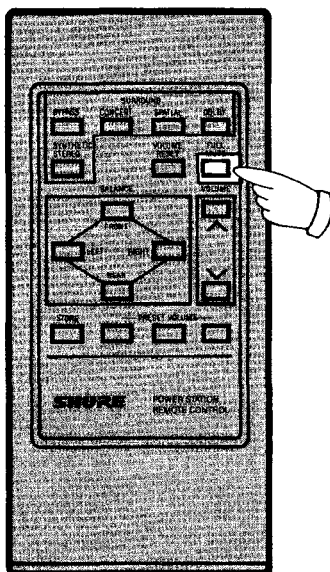

Press this button when you wish to turn off the volume momentarily, such as when a visitor arrives unexpectedly or when the telephone rings. The FULL MUTE indicator on the AVC20 will flash. Press the button once again to return to the previous volume.

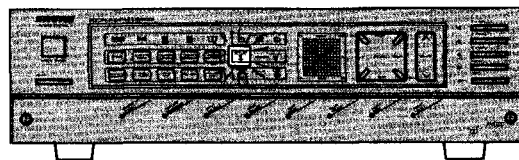

USE OF THE IMAGE ENHANCER SWITCH

■ Use of the IMAGE ENHANCER Switch

- The Image Enhancer function is very effective for cleaning up fuzzy pictures, or when watching foreign films, making movie subtitles clearer.
- The switch works in three steps:
 - 3 dB (decibels) For lesser effect.
 - 6 dB (decibels) For greater effect.
 - OFF Switch is tuned off.

When watching old movies or video software and white shimmering appears on the screen, using the Image Enhancer Switch to clear this up may make the screen hard to see. Use the switch only when the picture is improved.

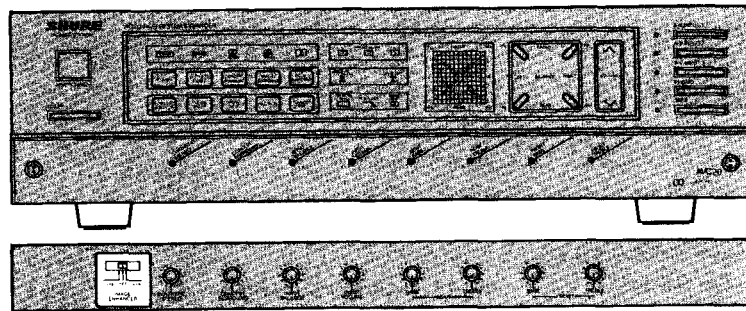

APPLICATIONS

(1) Balanced Transformerless (BTL) Mode

The AVC20 has a built-in 4-way 30W amplifier system, but by switching to BTL operation, it can be used as a 2-way 60W amplifier system.

BTL . . . Balanced Transformerless

Switching

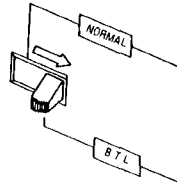

CAUTION
TURN OFF AVC20 POWER BEFORE OPERATING
BTL SWITCH.

■ Adding Amplifiers in the BTL Mode

Adding amplifiers while in the BTL mode makes possible the creation of a sound system with total output greater than 120 watts.

- Only use this switch when the power is off.
- Set the NORMAL/BTL switch to the BTL side.
- Connect the speakers as shown in the diagram.
- Sound is produced from the outside speaker terminals when using the AVC20 in the BTL mode. (The rear “+” speaker terminals become BTL “-” speaker terminals.)

Connection (A)

- ① To use the AVC20 on the two front channels and use the two rear channels with other amplifiers, remove the U-shaped short pins as shown in the diagram. (In order not to lose the pins, use cellophane adhesive tape or the like to fix them to the rear panel.)
- ② Connect the REAR- PRE OUT terminals to the AUX IN terminals of the added stereo amplifier using pin plug cables.
- ③ When this is done, the AVC20 volume control can be operated, but the volume of the other amplifier must be increased to match that of the AVC20.

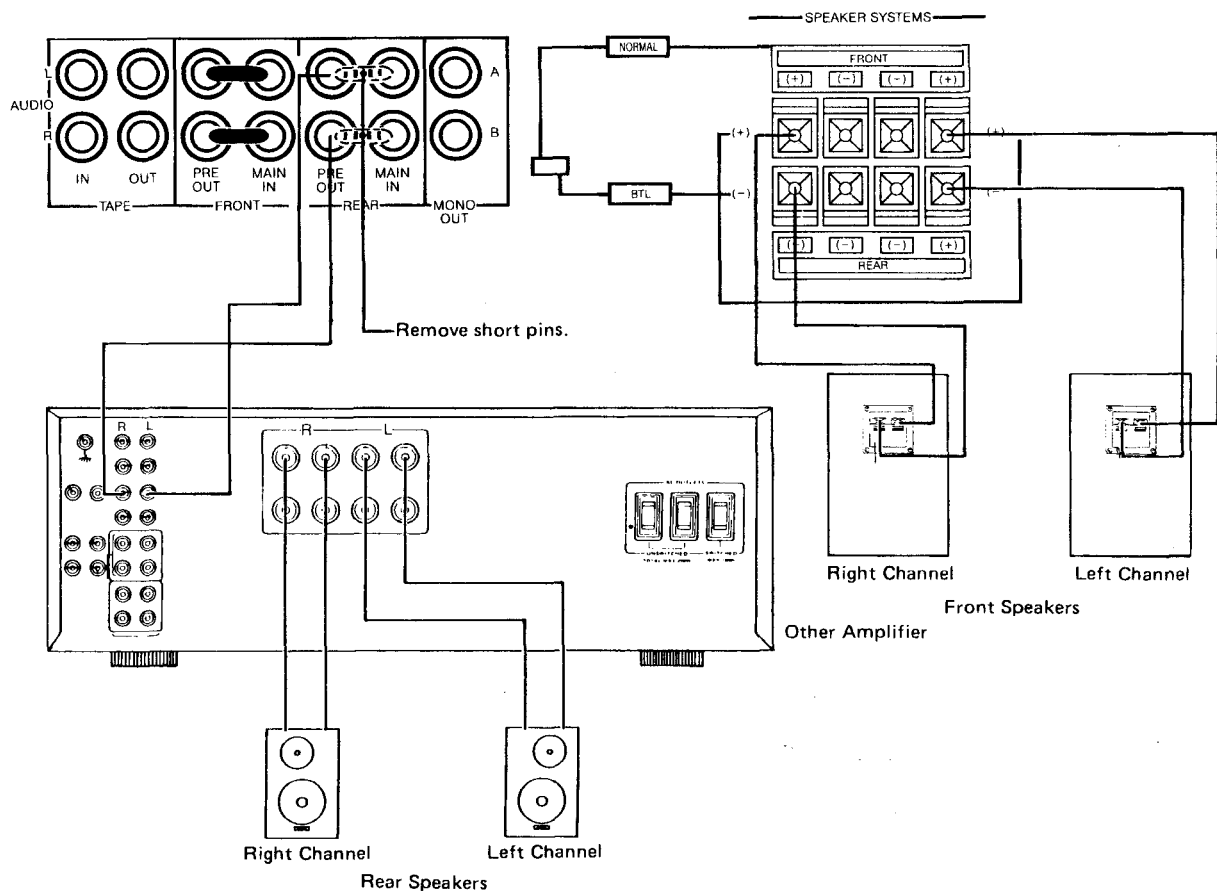

Connection (B)

- ① To use the AVC20 on the two rear channels and use the two front channels with an added amplifier, change the U-shaped short pins as shown in the diagram.
- ② Connect the FRONT-PRE OUT terminals to the input terminals of the other amplifier using pin plug cables.
- ③ Use the outside speaker terminals for the Rear speakers.
- ④ When this is done, the AVC20 volume control can be operated, but the volume of the other amplifier must be increased to a suitable level.

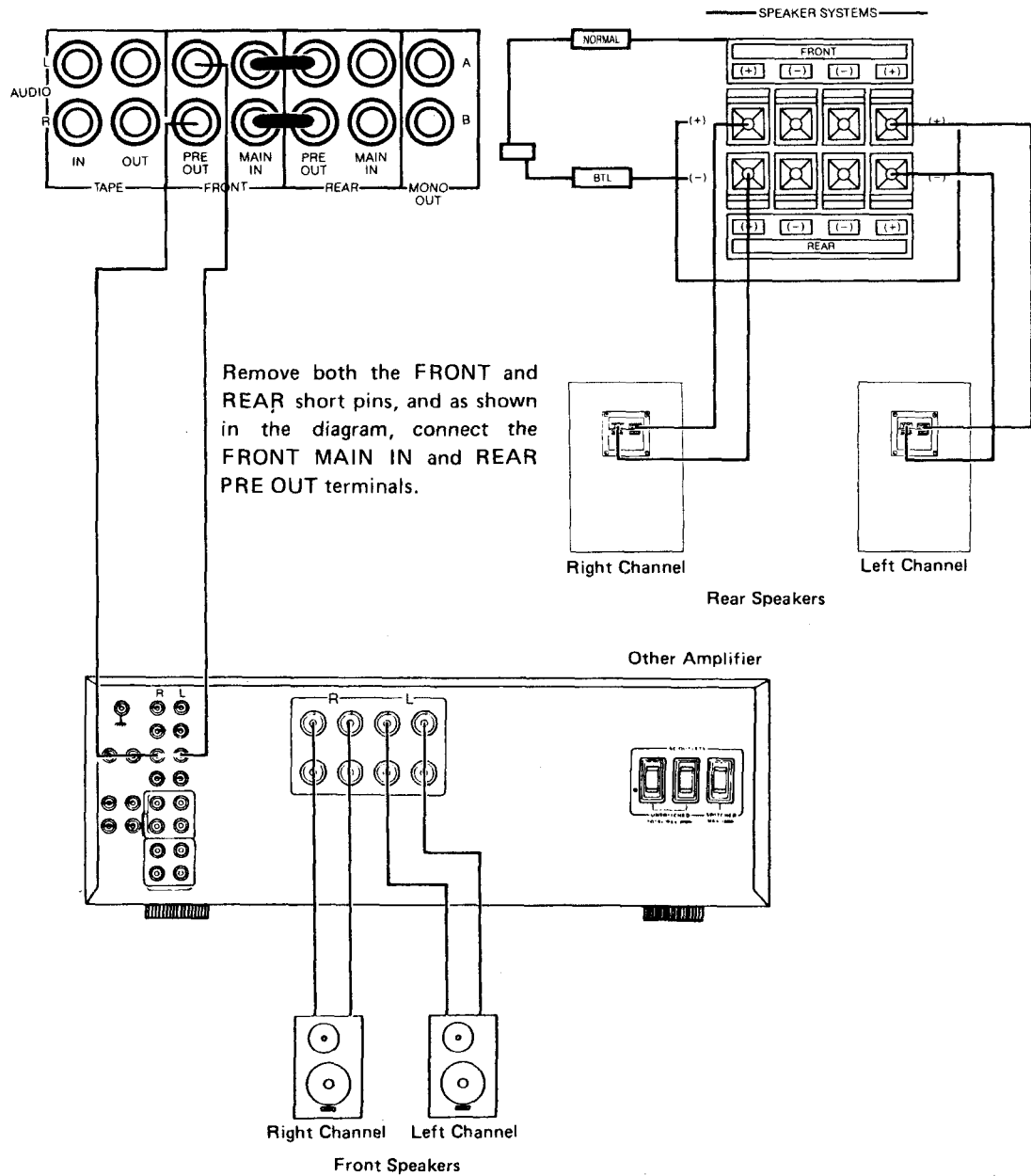

(2) Using as Surround Processor

The AVC20 can be used by disconnecting both the front and rear pre-amplifiers and main amplifiers.

To use the AVC20 as a surround processor with different main amplifiers, remove the four short pins as shown in the diagram, and use pin cords to connect the PRE OUT terminals to the input terminals of the other amplifiers.

When this is done, the AVC20 volume control can be operated, but the volume of the other amplifiers must be increased to a suitable level. The AVC20 amplifiers can also be used by connecting Aux level outputs of audio devices to the MAIN inputs.

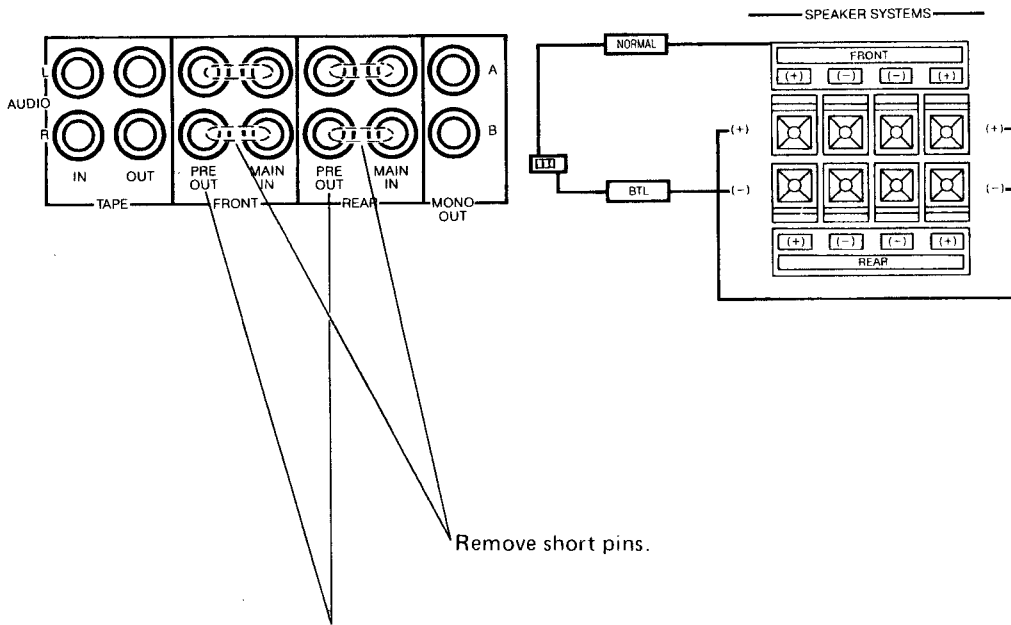

Connect the AVC20 PRE OUT terminals to the input terminals of the other amplifiers using cables with phono plugs at the AVC20 side and appropriate connectors at the amplifier side.

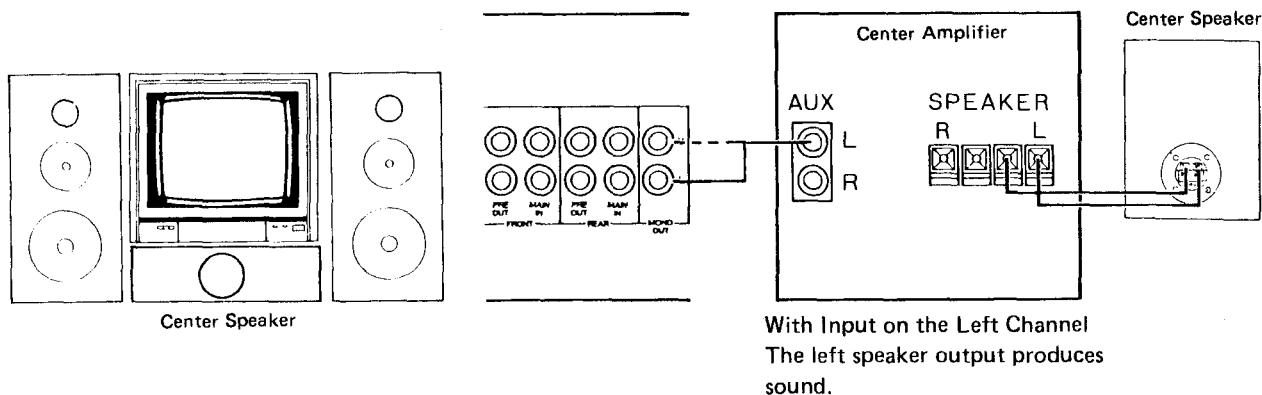

(3) MONO OUT

- Many audio/video systems are set up with a television centered between two speakers. Sometimes, however, if the speakers are located far away from the television, the resultant center localization can become confusing. To provide better center localization, connect one of the AVC20's mono outputs to an external amplifier and speaker, placing the speaker under, or as close as possible to, the television.
- Use a shielded magnet type speaker as the center speaker, and keep as close as possible to the monitor screen for best results.
- When using a monophonic main amplifier as the center channel, use the AVC20's MONO output terminal for best results.

(4) Use of **TAPE** Input/Output Terminals – 1

- It is possible to add a different audio source to video software. It is also possible to dub onto a video deck using a different audio source.
- Connect as shown in the diagram.
- Connect a playback video component (for example, a video disc player) to the A-V INPUT 3 Input terminals and depress the A-V INPUT 3 button on the front panel.
- Connect an audio component, such as a compact disc player or cassette deck to the **TAPE** input terminals.
- When the **TAPE** selector button of the front panel is depressed, the image from the video component connected to **3** appears on the monitor. The sound of the component connected to the **TAPE** terminals is produced from the speakers. The audio signal from the TAPE input overrides the audio signal from AV INPUTS 1, 2, and 3.
- This can be recorded on to a video deck connected to the output of either A-V INPUT 1 or 2.

(5) Use of **TAPE** Input/Output Terminals – 2

- These can be used as input/output terminals for a signal processor such as a graphic equalizer.
- Connect as shown in the diagram.
- Depress one of the A-V INPUT 1-3 or PHONO to choose which component is to be played back, and then depress the **TAPE** button.
- Control by the signal processor is possible.
- Refer to the signal processor instruction manual for details on its use.

(4) Connections for "Use of **TAPE** Input/Output Terminals – Example 1"

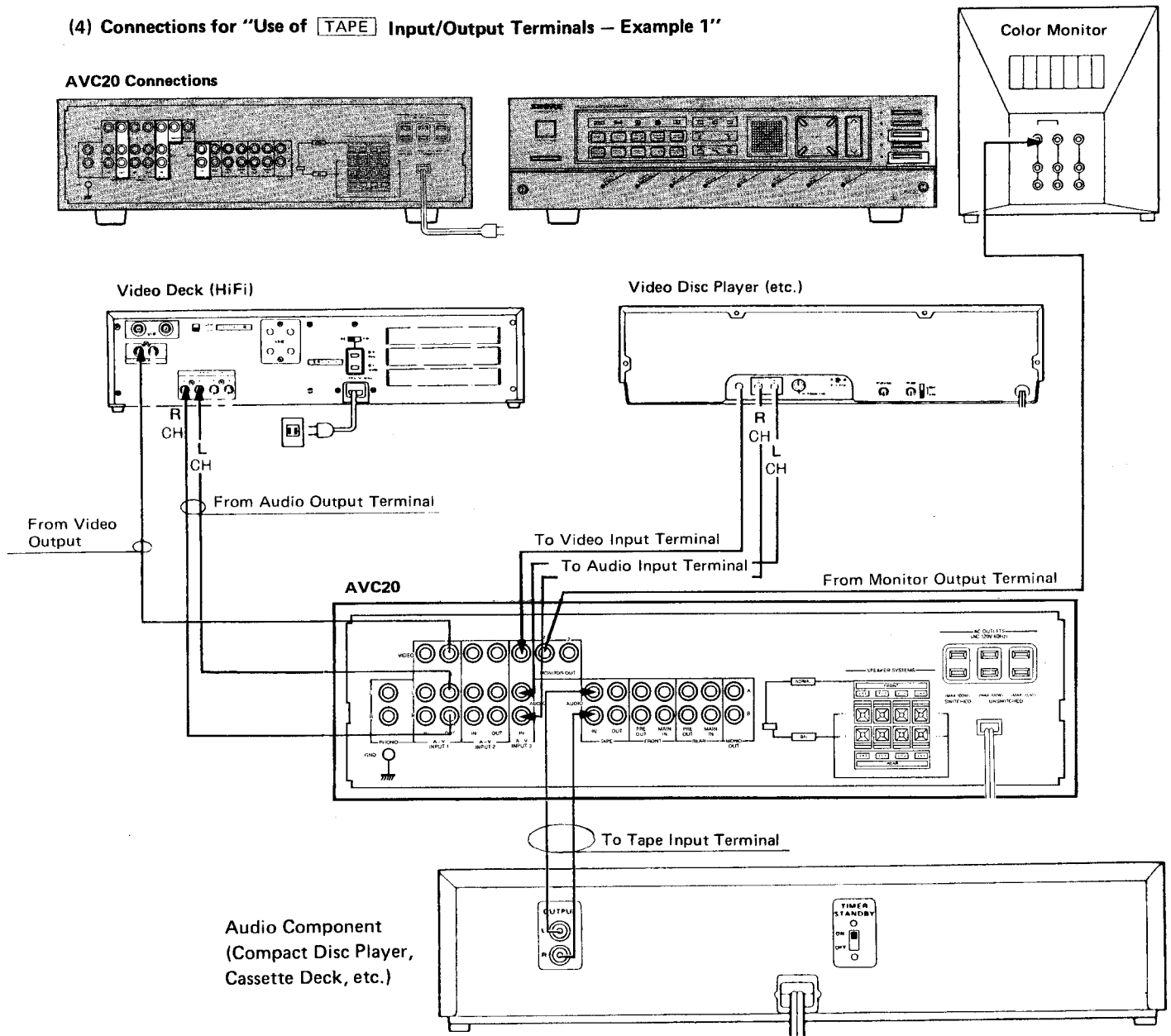

(5) Connections for "Use of **TAPE** Input/Output Terminals – Example 2"

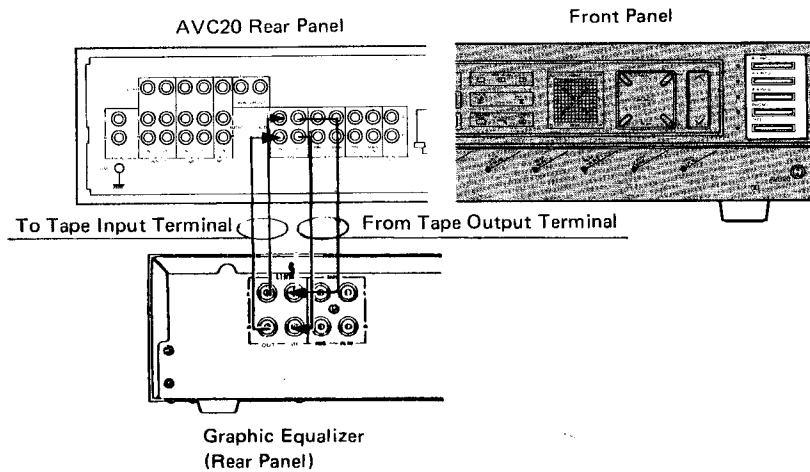

EXAMPLES OF USE WITH A VARIETY OF DIFFERENT EQUIPMENT

(Monophonic Video Deck)

As shown in the diagrams below, video signals are supplied to the television through the antenna line, and audio signals pass through the AVC20 to produce sound from the speakers. Turn down the TV Volume whenever the AVC20 amps are used.

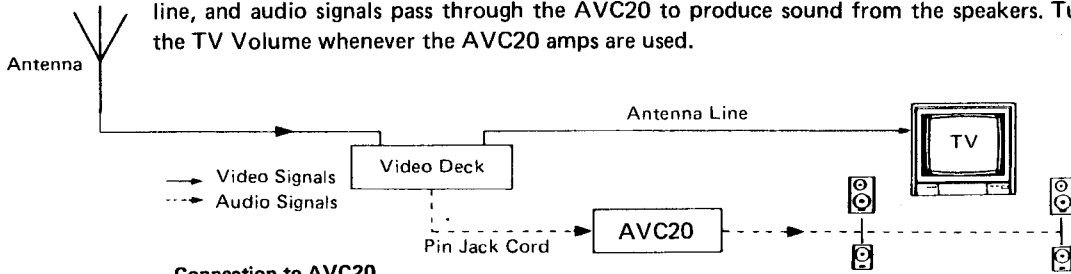

Connection to AVC20

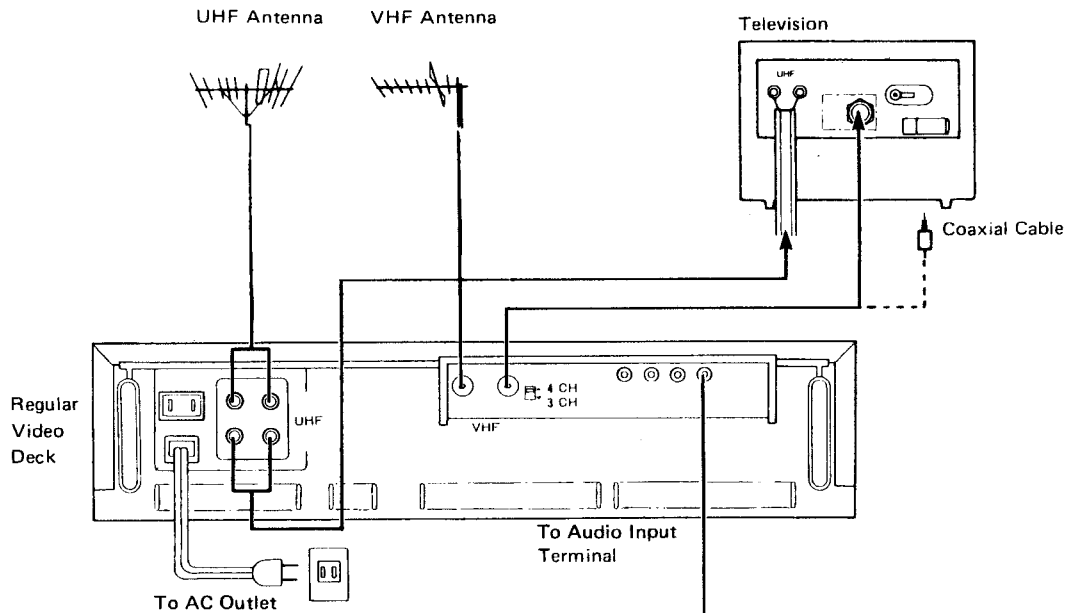
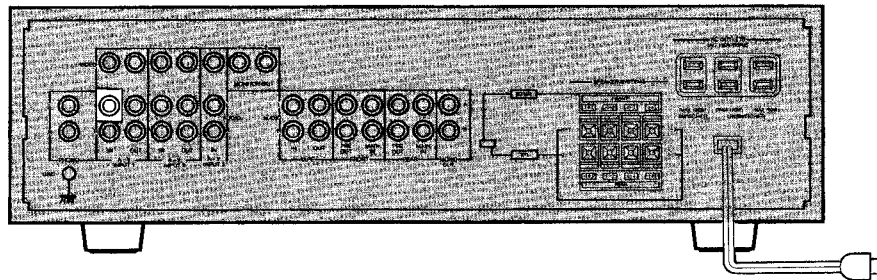

- Set the AVC20 AUDIO/VIDEO SELECTOR to A-V INPUT 1.
- Set front panel switch to MONO or SYNTHETIC STEREO. Choose the one that sounds best to you.
- Operate the video deck.
- For operation of the video deck, refer to its instruction manual.

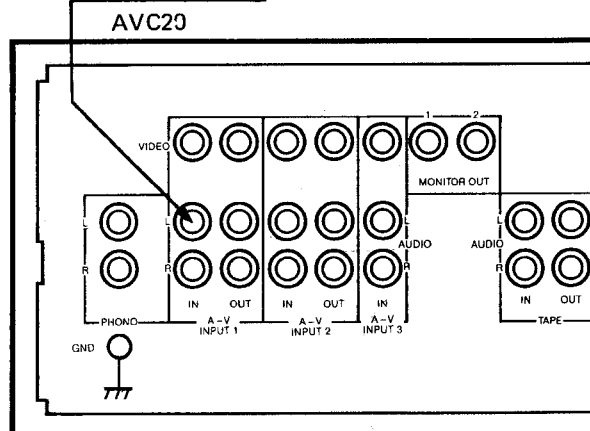

EXAMPLES OF USE WITH A VARIETY OF DIFFERENT EQUIPMENT

(Stereo Video Deck)

USE OF INPUT SELECTOR SWITCHES

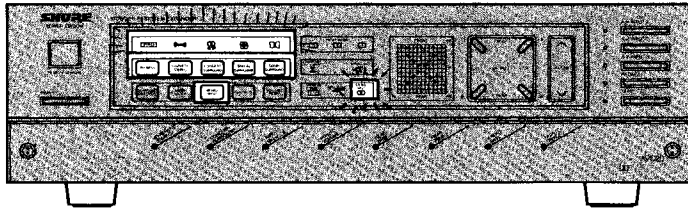

SOURCE	SELECTOR SWITCH	DISPLAY
Mono	MONO	Off
Mono	SYNTHETIC STEREO	
Stereo	BYPASS	
Stereo	CONCERT SURROUND	
Stereo	SPATIAL SURROUND	
Stereo	DOLBY SURROUND	

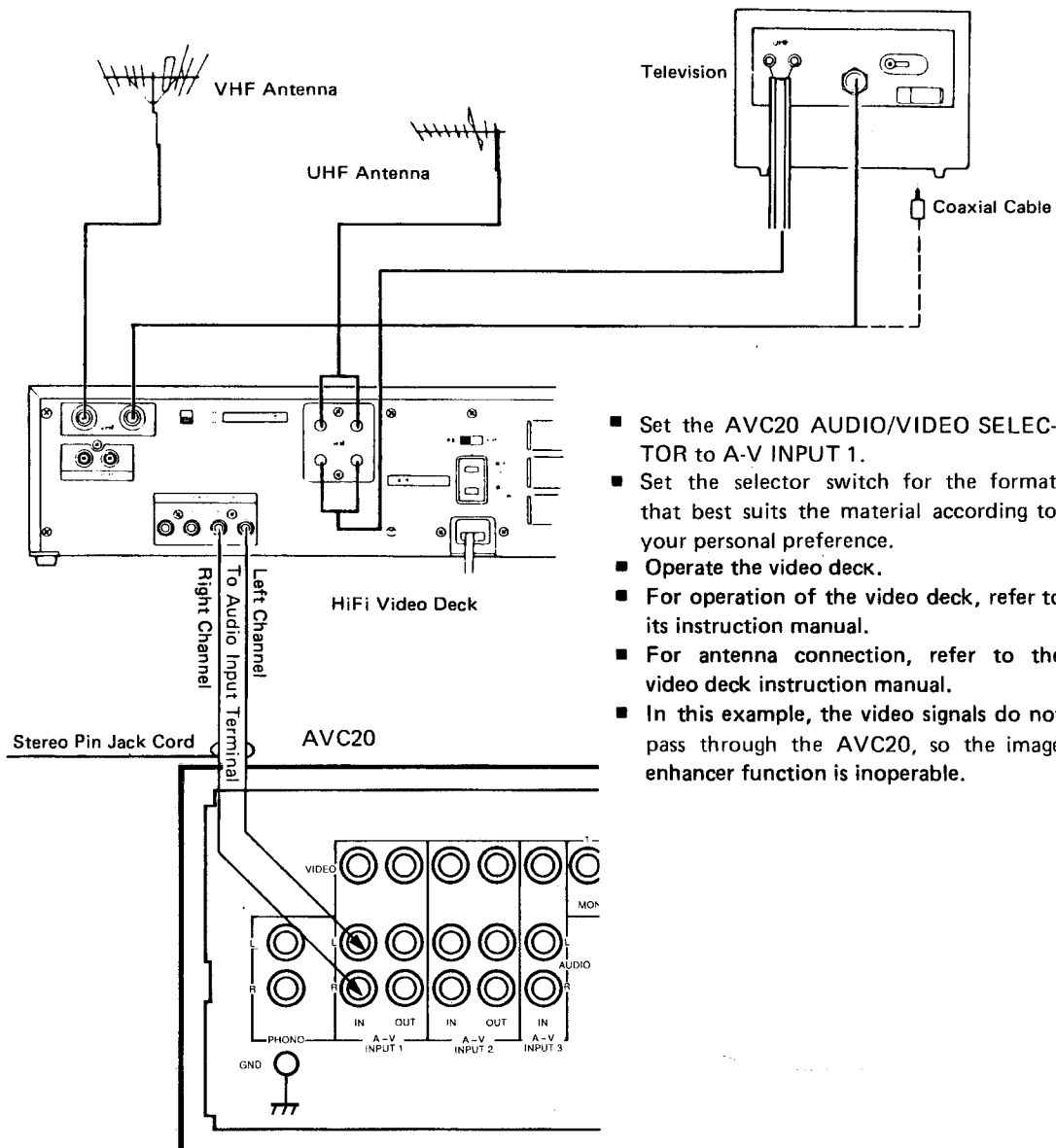

- Set the AVC20 AUDIO/VIDEO SELECTOR to A-V INPUT 1.
- Set the selector switch for the format that best suits the material according to your personal preference.
- Operate the video deck.
- For operation of the video deck, refer to its instruction manual.
- For antenna connection, refer to the video deck instruction manual.
- In this example, the video signals do not pass through the AVC20, so the image enhancer function is inoperable.

EXAMPLES OF USE WITH A VARIETY OF DIFFERENT EQUIPMENT

(Two Video Decks)

First, decide which deck is to be used primarily. In the example below, a stereo video deck is used as the primary deck, while a monophonic video deck is used as the secondary deck. The monophonic video deck's video signals pass through the AVC20 into the LINE input terminal of the stereo video deck, whose VHF output terminal is connected to the television.

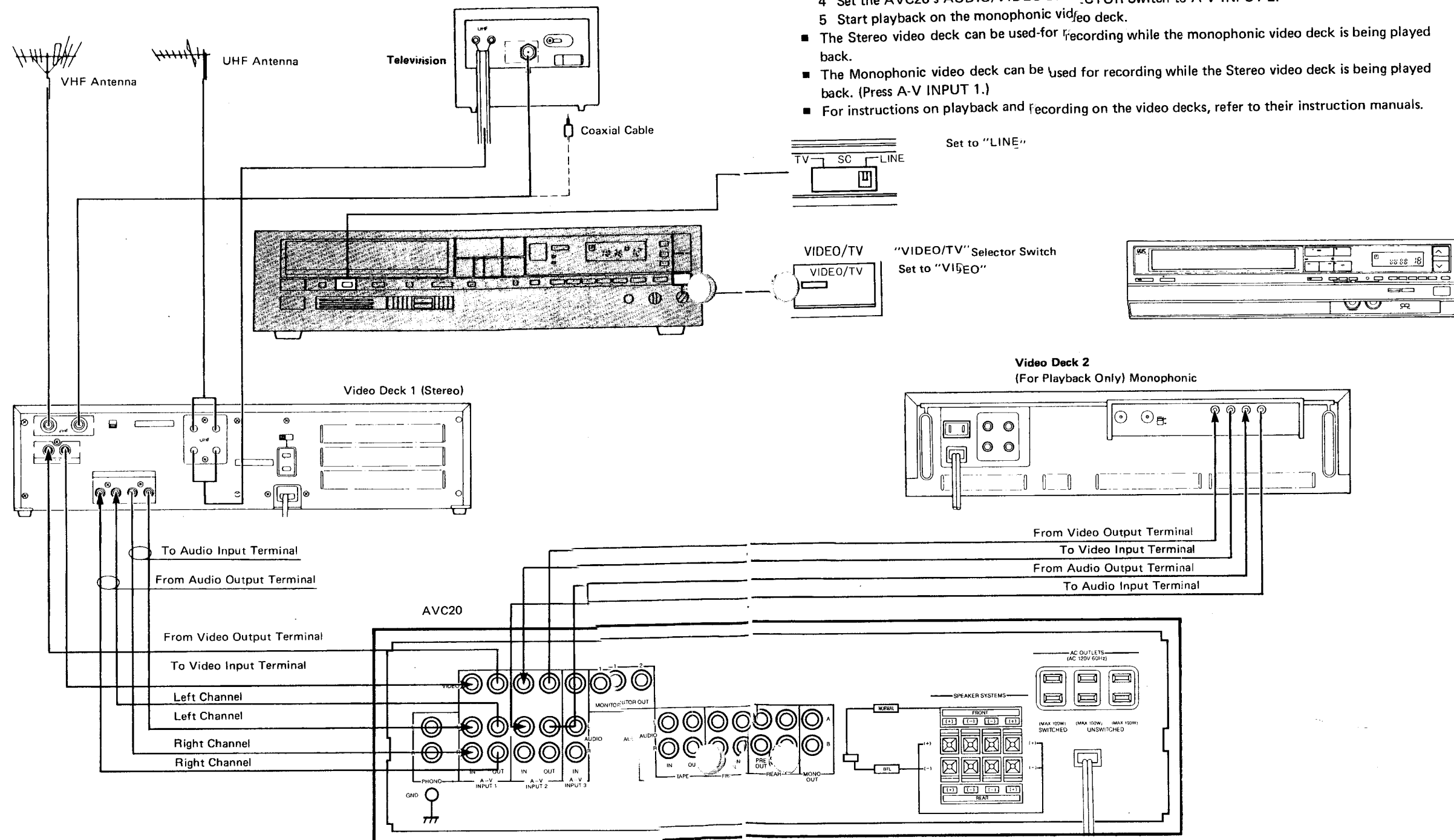
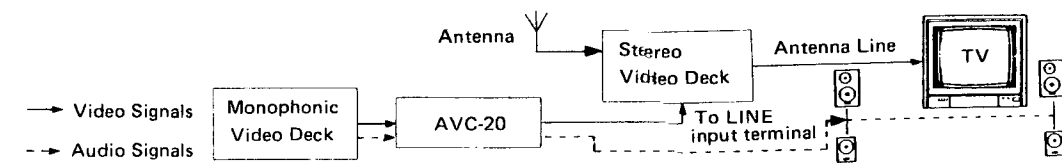

Operation of the AVC20

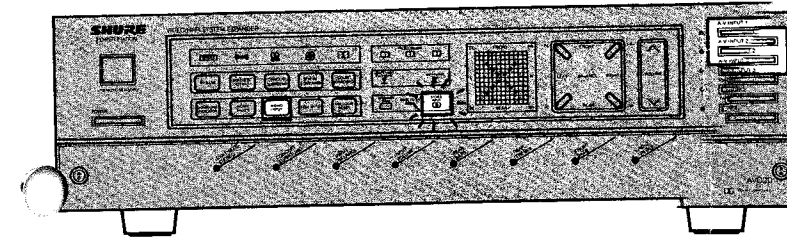

- When playing back on the Stereo video deck, the AVC20's STEREO INPUT SELECTOR Switch should be in the BYPASS position (the indicator lights). Any of the Surround switches may be chosen instead, depending on personal preference.
- For playback on the monophonic video deck:
 - 1 Place Stereo video deck's input selector switch to LINE.
 - 2 Set the Stereo video deck's VIDEO/TV selector switch to VIDEO.
 - 3 Press the AVC20's MONO INPUT switch (the indicator will remain off).
 - 4 Set the AVC20's AUDIO/VIDEO SELECTOR Switch to A-V INPUT 2.
 - 5 Start playback on the monophonic video deck.
- The Stereo video deck can be used for recording while the monophonic video deck is being played back.
- The Monophonic video deck can be used for recording while the Stereo video deck is being played back. (Press A-V INPUT 1.)
- For instructions on playback and recording on the video decks, refer to their instruction manuals.

EXAMPLES OF USE WITH A VARIETY OF DIFFERENT EQUIPMENT

(Video Deck and Video Disc Player)

The video disc player's video signals entering the AVC20, are sent from the AVC20 output terminals to the video deck's LINE input terminals, and then from the video deck's VHF terminal to the television.

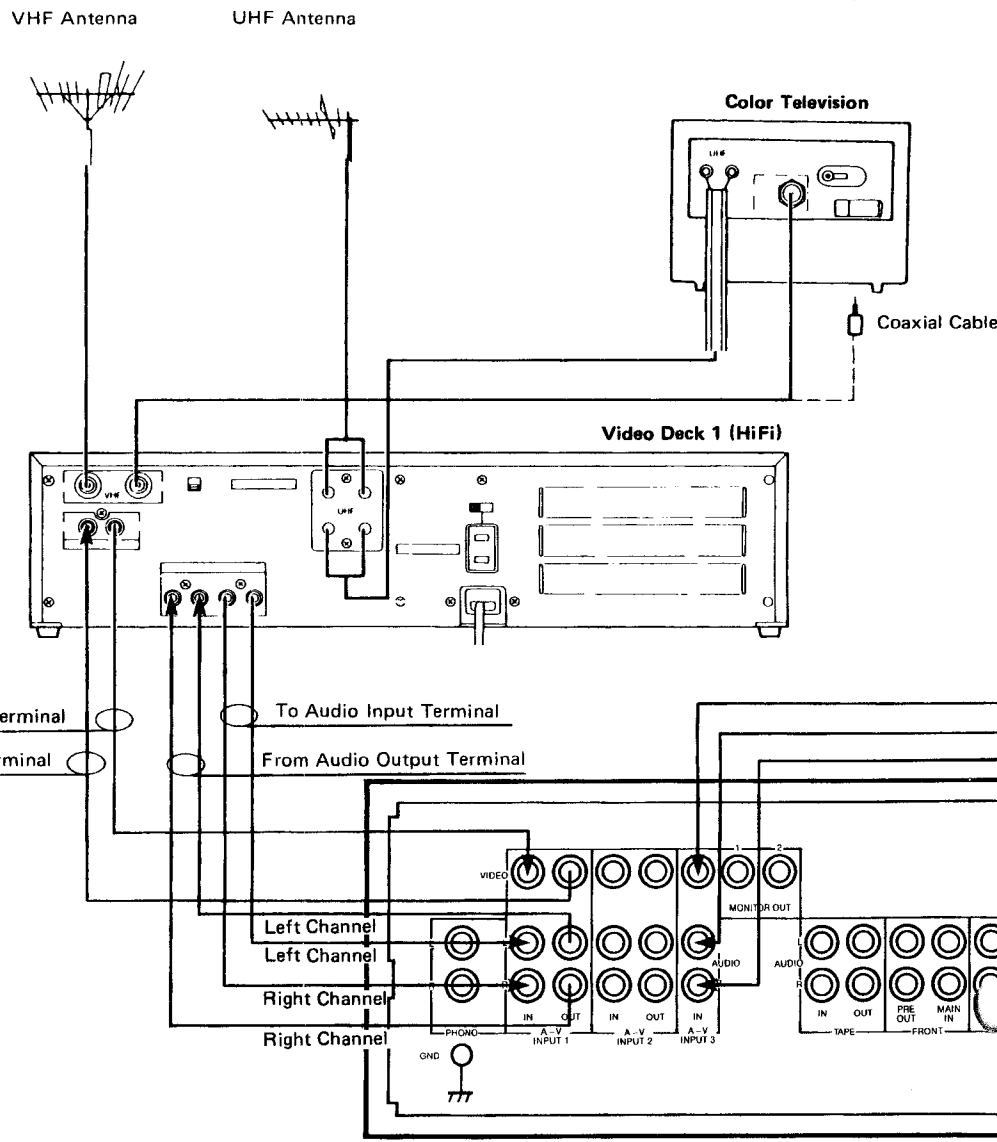
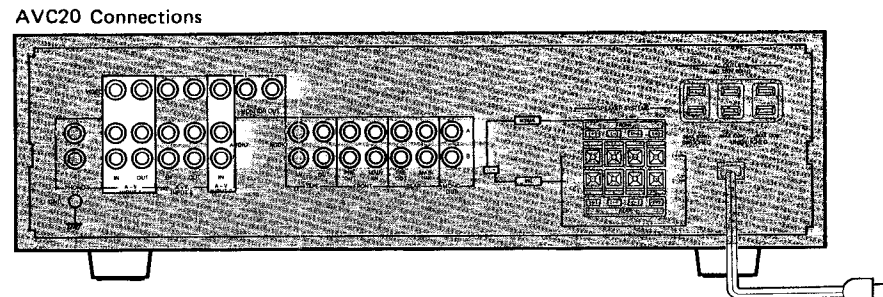
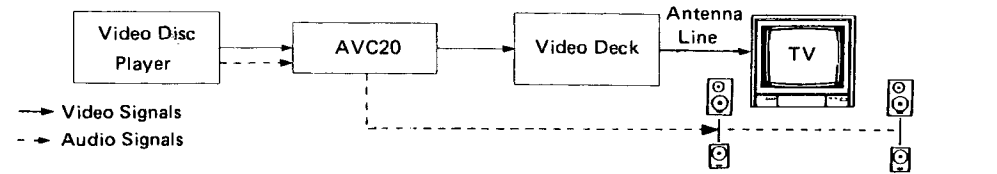

Operation of Video Deck 1 (HiFi)

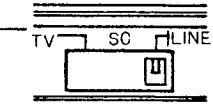
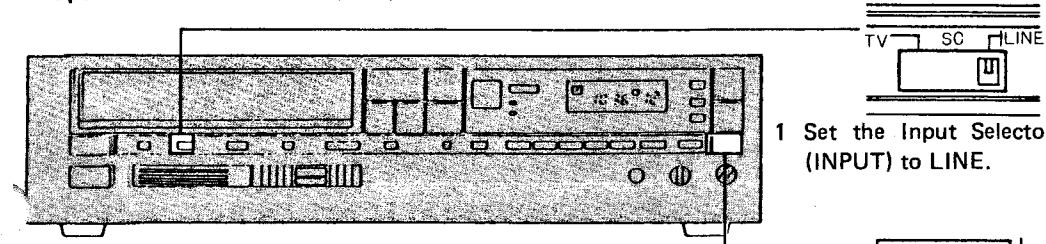

Operation of AVC20

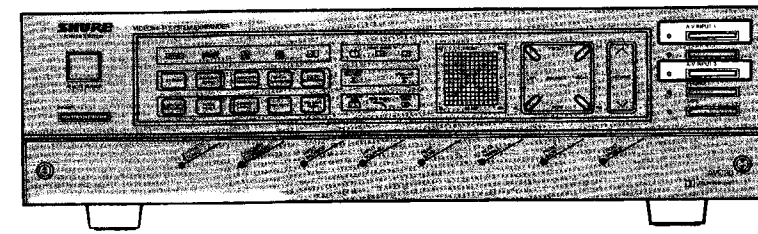

2 Set the VIDEO/TV Selector Switch to VIDEO.

- 1 When playing back on the video disc player, press A-V INPUT 3 button.
 - 2 The video deck can be used for recording while playing back the video disc player.
 - 3 To play back a recorded video tape, press the A-V INPUT 1 button.
- For instructions on playback or recording on the video deck, refer to its instruction manual.

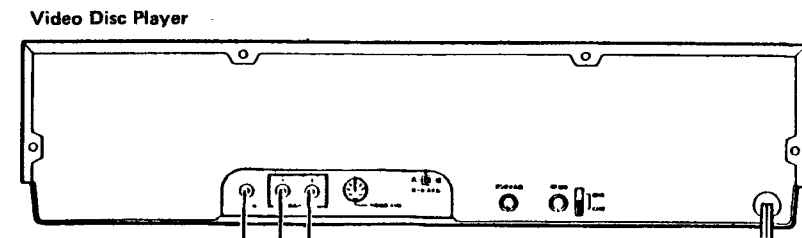

EXAMPLES OF USE WITH A VARIETY OF DIFFERENT EQUIPMENT

(TV Equipped with Video Input Terminal)

This combination brings out the best in the AVC20. Output from all audio/video equipment is input to the AVC20, the video signals are sent from the Monitor Output Terminal to the television's Video Input Terminal, and the audio signals are sent to the speakers.

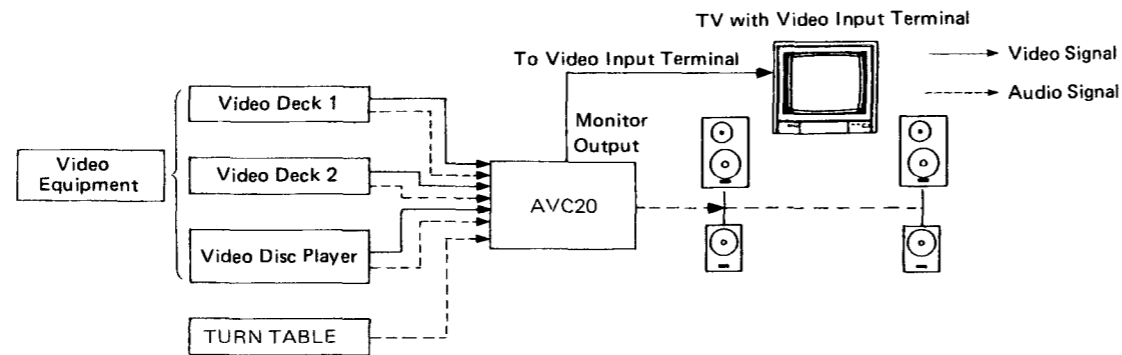

When using a television equipped with a video input terminal, set the VIDEO/TV Selector Switch to VIDEO.

AVC20 Connections

For connection of antennas, refer to page 20 or the video deck's instruction manual.

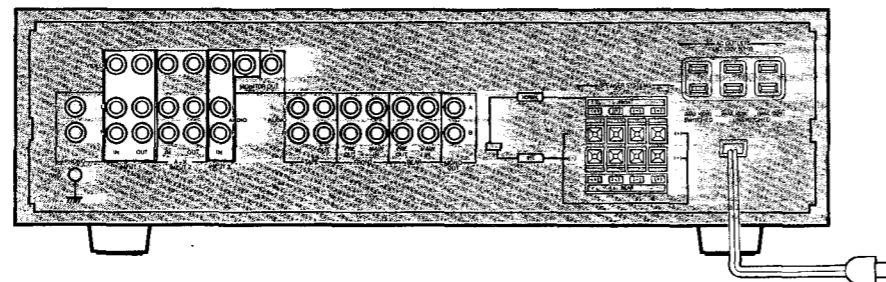

Color Monitor, TV with Video Input Terminal, etc.

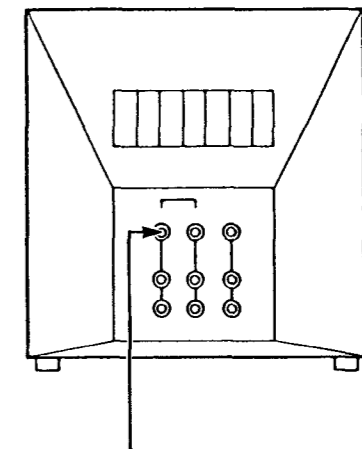

Video Deck (HiFi)

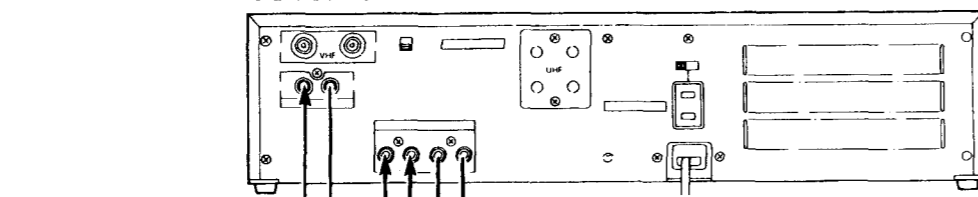

Video Disc Player, etc.

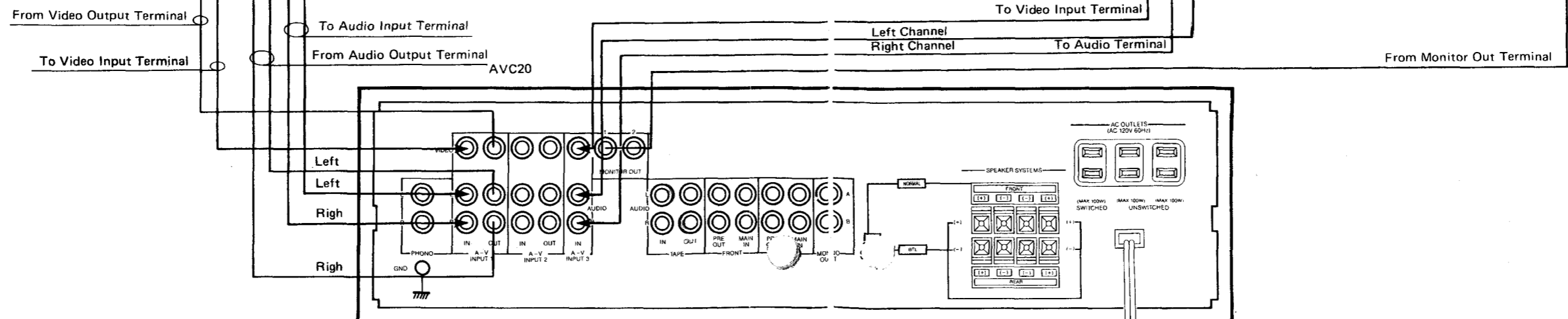
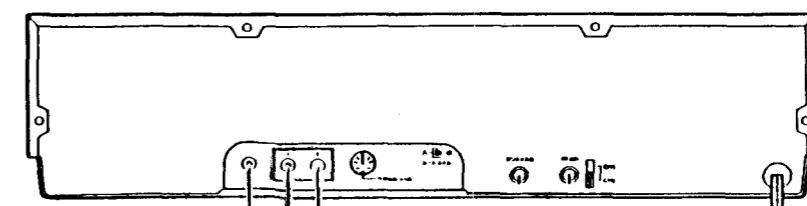

EXAMPLES OF USE WITH A VARIETY OF DIFFERENT EQUIPMENT (Overall Connections)

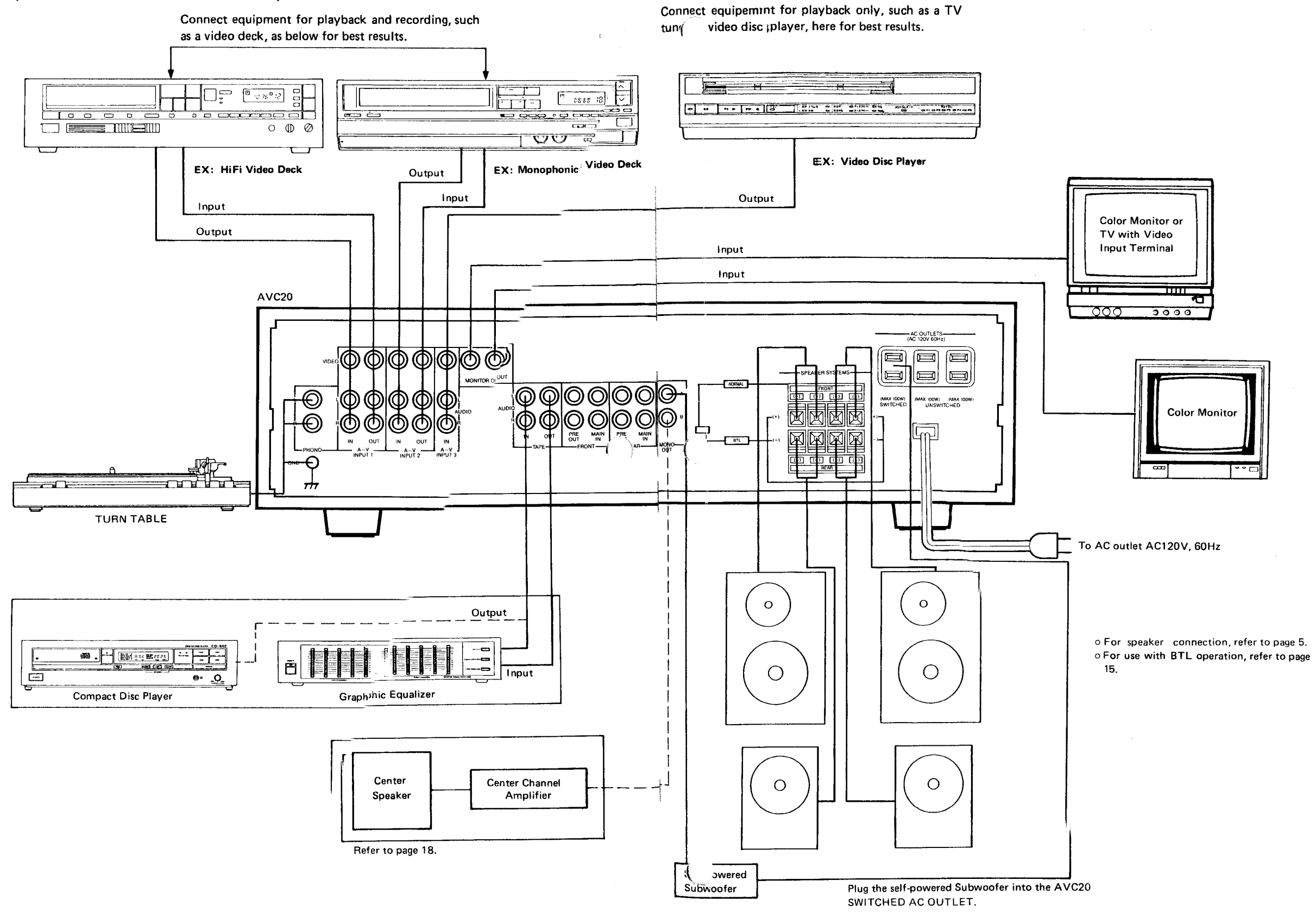

CAUTIONS ON USAGE

For Safety

Power Source

Connect to a household power ac outlet.



Power Cord

Do not bend or twist the power cord or place heavy objects on top of it. A damaged cord may result in fire or electric shock.

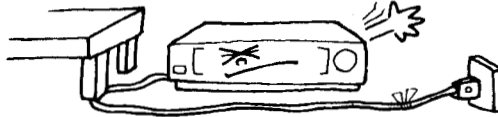

Do Not Open

Do not remove the cabinet, as this is both dangerous and could damage the AVC20. Leave inspection and service to authorized service personnel.

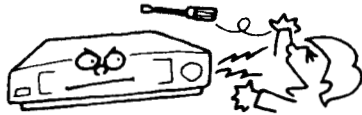

When Not At Home

When not using the AVC20 for an extended period of time, such as when traveling, be sure to unplug the AVC20 from the power supply.



Problems

Should any irregular noise, smell, or smoke be discovered, turn off the power switch, unplug, and contact your dealer or qualified service personnel.



Normal Care

■ Cleaning the Cabinet

- To clean the cabinet and front panel, wipe gently with a soft cloth (flannel for example). For tough dirt, apply medium strength detergent diluted in water to a soft cloth, wring out thoroughly, wipe off dirt, then wipe with a dry cloth.
- If the surface of the cabinet comes in contact with a volatile substance such as benzine, thinner, or insecticide, or if wiped with a chemical rag or the like, it could be damaged, or the paint could peel off.

Take Care When Installing

Do not use the AVC20 in such places as follows:

- Cold places (Below 5°C [40°F])



- Hot places (above 40°C [105°F]) or in direct sunlight



- Wet or humid places



- Places in which dust, grease or smoke are present.

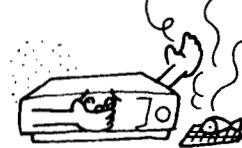

- Places in which vibrations are strong



- Place in which magnetic force is generated

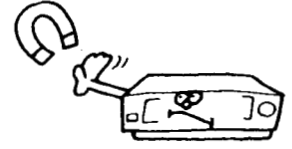

- Places in which ventilation is poor

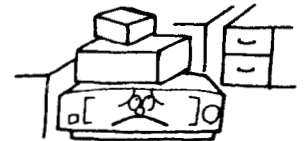

- Unstable places. (Avoid placing on unsteady stands).

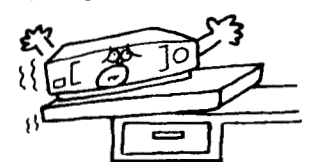

Handling

- Do not block the ventilation openings.

Ventilation openings in the cabinet are designed to prevent overheating of internal parts. Do not place a tablecloth or cover on top of the AVC20, or place the AVC20 on a blanket.

- Do not place against a wall.

Keep at a distance of at least 10 cm (4 in.) from the wall.

- Do not place heavy objects on top of the AVC20.

- For transporting and storage,

Avoid excessive shocks. When moving, turn the power switch off.



TROUBLESHOOTING

Symptom	Cause	Measures
<ul style="list-style-type: none"> Power does not come on 	<ul style="list-style-type: none"> Power plug is not connected properly to an ac outlet. Power switch is off. 	<ul style="list-style-type: none"> Plug in firmly. Press power switch on.
<ul style="list-style-type: none"> No sound or picture is produced 	<ul style="list-style-type: none"> Connection cords are disconnected. Connection cords are connected improperly. The position of the input selector switch does not match the input of the component being used. 	<ul style="list-style-type: none"> Connect firmly in the socket. Check the connections. Change the switch to match the input.
<ul style="list-style-type: none"> No sound is produced 	<ul style="list-style-type: none"> The input selector switch <input type="checkbox"/> TAPE button is on. The FULL MUTE switch is on. (<input type="checkbox"/> indicator flashes) Balance adjustment is incorrect. 	<ul style="list-style-type: none"> Press the <input type="checkbox"/> TAPE switch to turn off. Press the FULL MUTE switch to turn off. Press the RESET button, then adjust the volume.
<ul style="list-style-type: none"> No SURROUND is produced 	<ul style="list-style-type: none"> The BYPASS button has been depressed. 	<ul style="list-style-type: none"> Depress one of the CONCERT, SPATIAL, or DOLBY switches. For monophonic audio input, when the MODE switch is set to MONO, sound is very weak when in the DOLBY position.

After a power outage, operation of the AVC20 may be irregular. Turn the power off for a moment, then turn back on.

SPECIFICATIONS

Amplifier Section

Rated Output (all channels driven, Main Amplifier Input)

In Normal Operation Front 30W + 30W
 (20 – 20 kHz 8 Ohm)
 Rear 30W + 30W
 (20 – 20 kHz 8 Ohm)

In BTL Operation 60W + 60W (20 – 20 kHz 8 Ohm)

Harmonic Distortion

In Normal Operation (at rated output) <0.1%

Frequency Response 10Hz – 40kHz (+0, -2dB)
 (Main Amplifier Input)

Tone Control BASS ±10dB
 TREBLE ±10dB

SN Ratio (IHF short-circuit, "A" network)

Audio/Video Input (BY PASS) 90dB
 Main Amplifier Input 100dB

Input/Output Section

Input Terminal (Sensitivity, Input Impedance)

A-V INPUT 1, 2, 3 Video 1Vpp/75 Ohm
 Audio 150mV/47k Ohm
 PHONO 8mV/47k Ohm
 TAPE 150mV/47k Ohm
 Main Amplifier Input 1V/20k Ohm

Output Terminals (Output Level, Output Impedance)

Audio/Video 1, 2 Video 1Vpp/75 Ohm
 Audio/Video 1, 2 Audio 150mV/2.2k Ohm
 Monitor Output (1, 2) 1Vpp/75 Ohm
 Pre-Amplifier Output 1V/1k Ohm
 Monophonic Output A, B 1V/500 Ohm

• The above specifications are subject to change without notice.

Others

Power Source Voltage 120 Vac, 60Hz
 Power Consumption 300W
 Supplementary Power Source Outlets Switched: 1 (100W)
 Unswitched: 2 (100W x 2)
 Outer Dimensions (W x H x D) 430 x 110 x 340 mm
 (16-15/16 x 4-5/16 x 13-3/8 in.)
 Weight 9.5 kg (20 lb. 14 oz.)

Accessories

Owner's Manual 1
 Wireless Remote Control Unit 1
 AA Batteries (SUM-3) 2
 Pin Plug Cord for Video Signals 2
 Glass Door 1
 Rubber Bushing 2
 Screw 2

Free Manuals Download Website

<http://myh66.com>

<http://usermanuals.us>

<http://www.somanuals.com>

<http://www.4manuals.cc>

<http://www.manual-lib.com>

<http://www.404manual.com>

<http://www.luxmanual.com>

<http://aubethermostatmanual.com>

Golf course search by state

<http://golfingnear.com>

Email search by domain

<http://emailbydomain.com>

Auto manuals search

<http://auto.somanuals.com>

TV manuals search

<http://tv.somanuals.com>