

SHARP

PORTABLE CD STEREO SYSTEM

MODEL

QT-CD180

OPERATION MANUAL

Thank you for purchasing this SHARP product.
To obtain the best performance from this product, please read this manual carefully. It will guide you in operating your SHARP product.

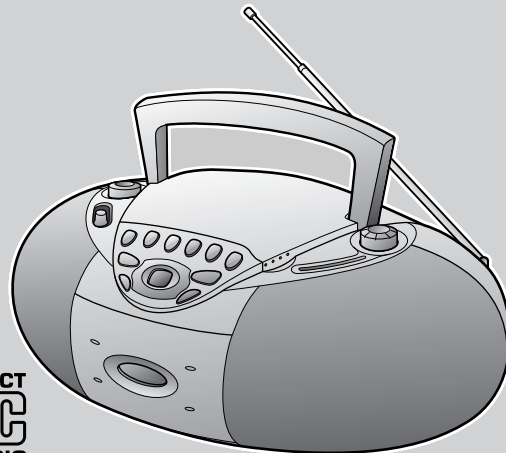

**COMPACT
disc
DIGITAL AUDIO**

Quick Guide / Guía rápida Pages 10-11 / Página 10-11

NOTE

This equipment has been tested and found to comply with the limits for a Class B digital device, pursuant to Part 15 of the FCC Rules. These limits are designed to provide reasonable protection against harmful interference in a residential installation.

This equipment generates, uses, and can radiate radio frequency energy and, if not installed and used in accordance with the instructions, may cause harmful interference to radio communications.

However, there is no guarantee that interference will not occur in a particular installation. If this equipment does cause harmful interference to radio or television reception, which can be determined by turning the equipment off and on, the user is encouraged to try to correct the interference by one or more of the following measures:

- Reorient or relocate the receiving antenna.
- Increase the separation between the equipment and receiver.
- Connect the equipment into an outlet on a circuit different from that to which the receiver is connected.
- Consult the dealer or an experienced radio/TV technician for help.

WARNING

FCC Regulations state that any unauthorized changes or modifications to this equipment not expressly approved by the manufacturer could void the user's authority to operate this equipment.

NOTES

- It is the intent of Sharp that this product be used in full compliance with the copyright laws of the United States and that prior permission be obtained from copyright owners whenever necessary.
- The letters in brackets contained in the model number indicate the color of the product only. Operation and specifications are unaffected.

FOR YOUR RECORDS

For your assistance in reporting this unit in case of loss or theft, please record below the model number and serial number which are located on the bottom of the unit.

Please retain this information.

Model number

Serial number

Date of purchase

Place of purchase

Special Notes



CAUTION

RISK OF ELECTRIC SHOCK
DO NOT OPEN



CAUTION: TO REDUCE THE RISK OF ELECTRIC SHOCK, DO NOT REMOVE COVER (OR BACK). NO USER-SERVICEABLE PARTS INSIDE. REFER SERVICING TO QUALIFIED SERVICE PERSONNEL.

Explanation of Graphical Symbols:



The lightning flash with arrowhead symbol, within an equilateral triangle, is intended to alert the user to the presence of uninsulated "dangerous voltage" within the product's enclosure that may be of sufficient magnitude to constitute a risk of electric shock to persons.



The exclamation point within an equilateral triangle is intended to alert the user to the presence of important operating and maintenance (servicing) instructions in the literature accompanying the appliance.

WARNING: TO REDUCE THE RISK OF FIRE OR ELECTRIC SHOCK, DO NOT EXPOSE THIS APPLIANCE TO RAIN OR MOISTURE.

Caution - use of controls or adjustments or performance of procedures other than those specified herein may result in hazardous radiation exposure.

Precautions

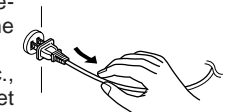
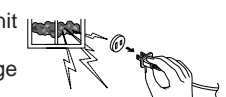
- Do not use oil, solvents, gasoline, paint thinners or insecticides on the unit.
- Do not expose the unit to moisture, to temperatures higher than 140°F (60°C) or to extreme low temperatures.
- Keep the unit away from direct sunlight, strong magnetic fields, excessive dust, humidity and electronic/electrical equipment (home computers, facsimiles, etc.) which generates electrical noise. 
- Hold the AC power plug by the head when removing it from the AC outlet, as pulling the cord can damage internal wires. 
- When cleaning the heads, pinch roller, etc., remove the AC power plug from the AC outlet as the unit contains high voltages. Do not remove the outer cover, as this may result in electric shock. Refer internal service to your local SHARP service facility.
- Use the unit on a firm, level surface free from vibration, and do not place anything on the top of the unit.
- If the unit does not work properly, set the FUNCTION switch to OFF and then to ON again.
- In case of an electrical storm, unplug the unit for safety. 
- This unit should only be used within the range of 41°F - 95°F (5°C - 35°C).

Warning:

The voltage used must be the same as that specified on this unit. Using this product with a higher voltage other than which is specified is dangerous and may result in a fire or other type of accident causing damage. SHARP will not be held responsible for any damage resulting from use of this unit with a voltage other than that which is specified.

Warning:

CD players use a laser pickup which can damage the eyes if viewed directly. Do not look at the pickup, and do not touch the pickup directly.



Important Safeguards

CAUTION

All the safety and operating instructions should be read before the appliance is operated, and should be retained for future reference.

Electrical energy can perform many useful functions. This unit has been engineered and manufactured to assure your personal safety. Improper use can result in potential electrical shock or fire hazards. In order not to defeat the safeguards, observe the following basic rules for its installation, use and servicing.

- 1 Heed Warnings - All warnings on the appliance and in the operating instructions should be adhered to.
- 2 Follow Instructions - All operating and use instructions should be followed.
- 3 Water and Moisture - The appliance should not be used near water - for example, near a bathtub, washbowl, kitchen sink, laundry tub, in a wet basement, or near a swimming pool, etc.
- 4 Carts and Stands - The appliance should be used only with a cart or stand that is recommended by the manufacturer.
 - An appliance and cart combination should be moved with care. Quick stops, excessive force, and uneven surfaces may cause the appliance and cart combination to overturn. 
- 5 Wall or Ceiling Mounting - The appliance should be mounted to a wall or ceiling only as recommended by the manufacturer.
- 6 Ventilation - The appliance should be situated so that its location or position does not interfere with its proper ventilation. For example, the appliance should not be situated on a bed, sofa, rug, or similar surface that may block the ventilation openings; or, placed in a built-in installation, such as a bookcase or cabinet that may impede the flow of air through the ventilation openings.
- 7 Heat - The appliance should be situated away from heat sources such as radiators, heat registers, stoves, or other appliances (including amplifiers) that produce heat.
- 8 Power Sources - The appliance should be connected to a power supply only of the type described in the operating instructions or as marked on the appliance.
- 9 Power-Cord Protection - Power-supply cords should be routed so that they are not likely to be walked on or pinched by items placed upon or against them, paying particular attention to cords at plugs, convenience receptacles, and the point where they exit from the appliance.
- 10 Do not use liquid cleaners or aerosol cleaners. Use a damp cloth for cleaning.
- 11 Power Lines - An outdoor antenna should be located away from power lines.

- 12 Outdoor Antenna Grounding - If an outside antenna is connected to the receiver, be sure the antenna system is grounded so as to provide some protection against voltage surges and built-up static charges. Section 810 of the National Electrical Code, ANSI/NFPA No. 70-1984, provides information with respect to proper grounding of the mast and supporting structure, grounding of the lead-in wire to an antenna discharge unit, size of grounding conductors, location of antenna-discharge unit, connection to grounding electrodes, and requirements for the grounding electrode.

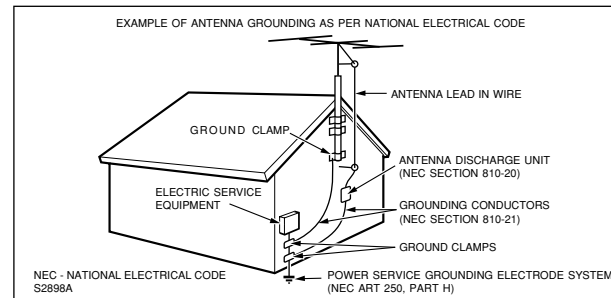

- 13 Nonuse Periods - The power cord of the appliance should be unplugged from the outlet when left unused for a long period of time.
- 14 Object and Liquid Entry - Care should be taken so that objects do not fall and liquids are not spilled into the enclosure through openings.
- 15 Damage Requiring Service - The appliance should be serviced by qualified service personnel when:
 - A The power-supply cord or the plug has been damaged; or
 - B Objects have fallen, or liquid has been spilled into the appliance; or
 - C The appliance has been exposed to rain; or
 - D The appliance does not appear to operate normally or exhibits a marked change in performance; or
 - E The appliance has been dropped, or the enclosure damaged.
- 16 Servicing - The user should not attempt to service the appliance beyond that described in the operating instructions. All other servicing should be referred to qualified service personnel.
- 17 Grounding or Polarization - Precautions should be taken so that the grounding or polarization means of an appliance is not defeated.



Controls and Indicators

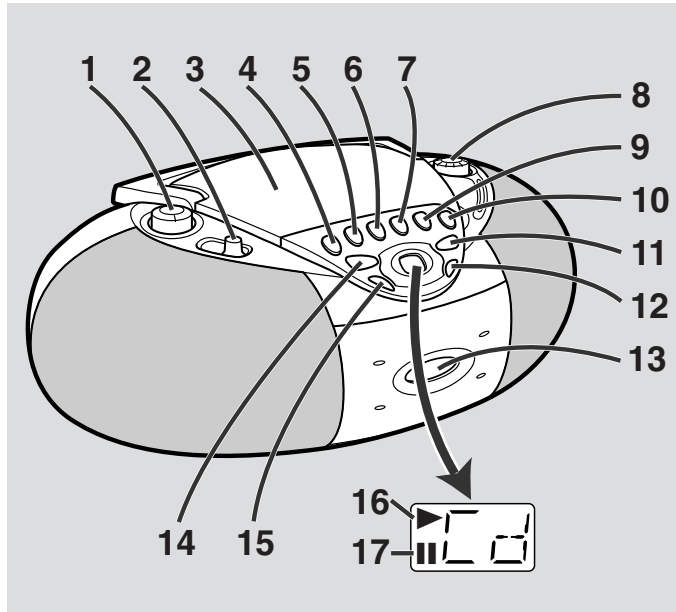

- | | |
|-------------------------------|-----------------------------------|
| 1. Volume Control | 10. (TAPE) Record Button |
| 2. Function Switch | 11. (CD) Play/Pause Button |
| 3. CD Compartment | 12. (CD) Track Up/Cue Button |
| 4. (TAPE) Pause Button | 13. Cassette Compartment |
| 5. (TAPE) Stop/Eject Button | 14. (CD) Stop Button |
| 6. (TAPE) Fast Forward Button | 15. (CD) Track Down/Review Button |
| 7. (TAPE) Rewind Button | 16. (CD) Play Indicator |
| 8. Tuning Control | 17. (CD) Pause Indicator |
| 9. (TAPE) Play Button | |

Accessory

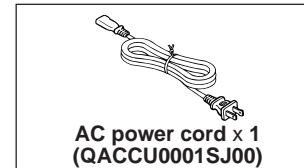

Notes:

- The AC power cord is located in the battery compartment.
- Only the accessory in the drawing is included.

Operation with AC power

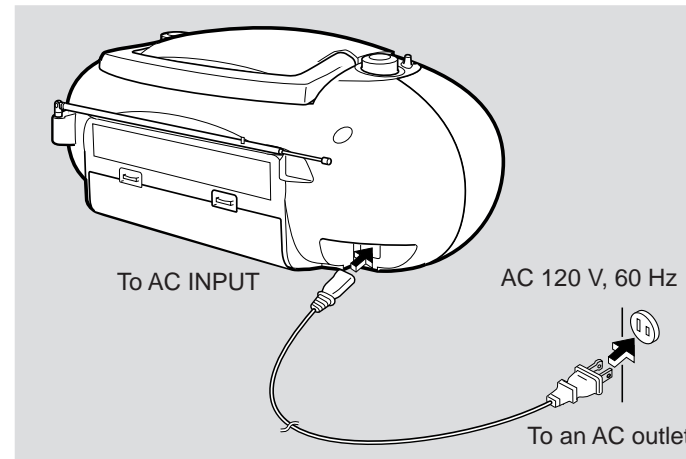

Notes:

- If the unit will not be used for a long period of time, remove the AC power cord from the AC outlet.
- Connection of the AC power cord to the unit disconnects the batteries.
- Never use a power cord other than the one supplied. It may cause an electric shock or fire.



Operation with batteries

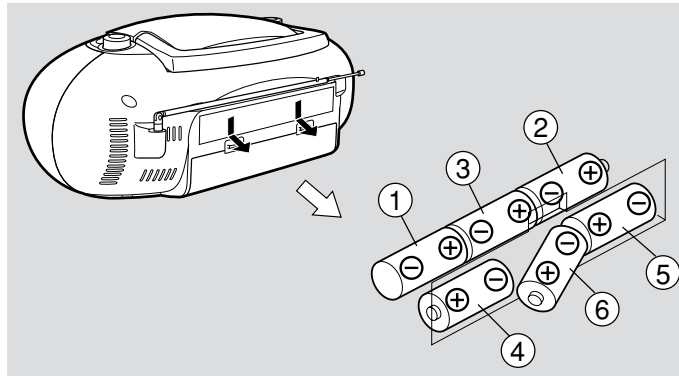

- 1 Disconnect the AC power cord, and remove the battery compartment cover.
- 2 Insert 6 "D" size batteries (UM/SUM-1, R20, HP-2 or similar) into the battery compartment.
 - Insert the batteries according to the direction indicated on the rear panel.
 - When inserting or removing the batteries ③ and ⑥, push them toward the ⊖ battery terminals.
 - Installing the batteries incorrectly may cause the unit to malfunction.

3 Replace the battery compartment cover.

Battery replacement:

Replace the batteries when they become weak and/or recording or playback is impaired. This may occur even though radio broadcasts are audible. Remove the battery compartment cover, and insert your finger in the hole on the bottom of the unit to remove batteries.

Notes:

- Replace all old batteries with new ones at the same time.
- Do not mix old and new batteries.
- Remove the batteries if they are weak or if the unit will not be used for long periods of time. This will prevent potential damage due to battery leakage.
- Batteries are not included.

Caution:

Do not use rechargeable batteries (nickel-cadmium battery, etc.).

Listening to the Radio

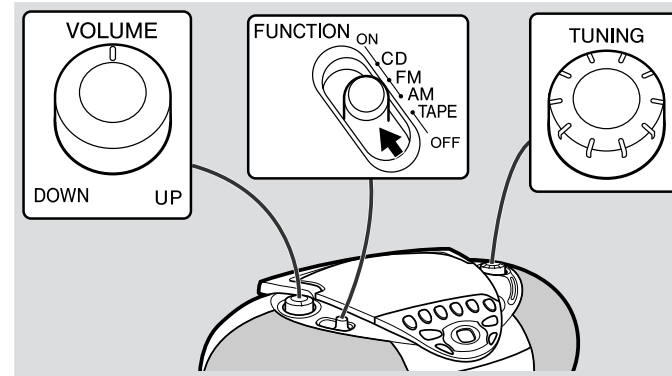

- 1 Set the FUNCTION switch to FM or AM.
- 2 Turn the TUNING control to tune in to the desired station.
During FM stereo reception, it automatically switches to monaural when the signal is weak.
- 3 Turn the VOLUME control to increase or decrease the volume.

Antenna adjustment:

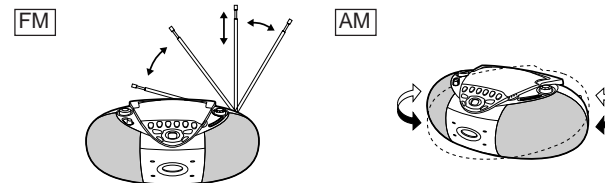

After use:

Set the FUNCTION switch to OFF.

Listening to a CD

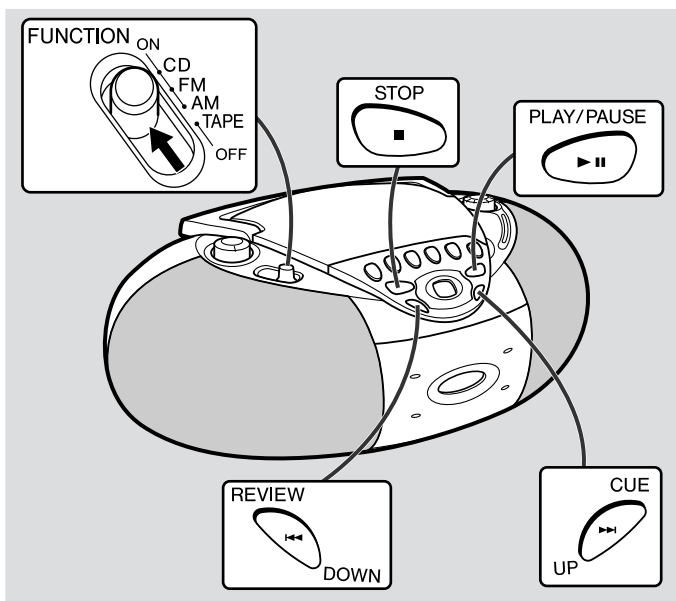

Precautions:

- When "Cd" or track number is displayed, the power is connected. If you will not be using the CD player, set the FUNCTION switch to OFF.
- Do not open the CD compartment while the disc is rotating.
- If the disc is damaged, dirty, or loaded upside down, the total number of tracks will not appear. Clean, replace, or reload the disc properly.
- Keep foreign objects out of the CD compartment.
- Subjecting the unit to shock or vibration may cause mistracking.
- Keep the CD compartment closed except when loading discs.
- Playing certain compact discs at a high volume may cause mistracking. In this case, listen at a lower volume.
- If TV or radio interference occurs during CD operation, move the unit away from the TV or radio.

- 1 Set the FUNCTION switch to CD.
- 2 Open the CD compartment.
- 3 Place a compact disc on the spindle, label side up. 3" (8 cm) discs may be played without an adaptor.
- 4 Close the CD compartment.



- 5 Press the PLAY/PAUSE ►|| button to start playback from track 1.

To interrupt playback:

Press the PLAY/PAUSE ►|| button during playback. Press the PLAY/PAUSE ►|| button again to resume playback.

To stop playback:

Press the STOP ■ button.

To listen to the track being played again:

During playback, press the REVIEW/DOWN ◀◀ button.

To move to the beginning of the next track:

During playback, press the CUE/UP ▶▶ button.

Notes:

- To skip a number of tracks at one time, press the REVIEW/DOWN ◀◀ or CUE/UP ▶▶ button repeatedly until the desired track number is shown.
- To start playing a desired track, press the REVIEW/DOWN ◀◀ or CUE/UP ▶▶ button while in the stop mode to select the track number, and then press the PLAY/PAUSE ►|| button.

To fast forward audibly (Cue):

During playback, hold down the CUE/UP ▶▶ button.

To fast reverse audibly (Review):

During playback, hold down the REVIEW/DOWN ◀◀ button.

Notes:

- When the end of the disc is reached while cueing, "En" will appear in the display and CD operation is paused. Press the REVIEW/DOWN ◀◀ button for fast reverse or press the STOP ■ button to stop CD operation.
- If the beginning of the disc is reached while reviewing, the mode will automatically switch to normal playback at that point.



Listening to a Cassette Tape

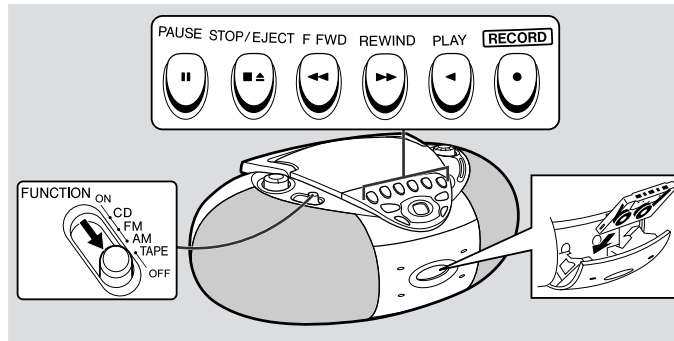

- 1 Set the FUNCTION switch to TAPE.
- 2 Load a cassette into the cassette compartment with the side to be played facing toward you.
- 3 Press the PLAY ◀ button.
- 4 To advance the tape, press the STOP/EJECT ■▲ button, then press the F FWD ◀◀ button. To rewind, press the STOP/EJECT ■▲ button, then press the REWIND ▶▶ button.

To interrupt playback:

Press the PAUSE || button during playback.
Press the PAUSE || button again to resume playback.

To stop playback:

Press the STOP/EJECT ■▲ button.

Precautions:

- Be sure not to press the PLAY ◀ and REWIND ▶▶ buttons simultaneously, or the tape will become damaged.
- Before changing from one tape operation to another, press the STOP/EJECT ■▲ button.
- Do not press the PAUSE || button while the fast forward or rewind operations are in progress. The F FWD ◀◀ or REWIND ▶▶ button will not be released when the tape end is reached. Once this occurs, press the STOP/EJECT ■▲ button.

About a Cassette and a CD

■ Cassette tape

- For playback, use normal or low-noise tape for the best sound. (Metal or CrO₂ tape is not recommended.) For recording, use only normal tape.
- Do not use C-120 tapes, or poor-quality tapes, as they may cause malfunctions.
- Before loading a tape into the cassette compartment, tighten the slack with a pen or pencil.
- Cassettes have removable tabs which prevent accidental recording or erasing from taking place. Removing the tab will protect the corresponding side from being erased. Cover the tab holes with adhesive tape to erase or record again.

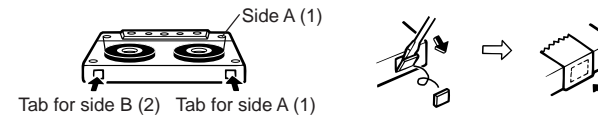

■ Care of compact discs

Compact discs are fairly resistant to damage, however mistracking can occur due to an accumulation of dirt on the disc surface. Follow the guidelines below for maximum enjoyment from your CD collection and player.

- Do not write on either side of the disc, particularly the non-label side. Signals are read from the non-label side. Do not mark this surface.
- Keep your discs away from direct sunlight, heat, and excessive moisture.
- Always hold the CDs by the edges. Fingerprints, dirt, or water on the CDs can cause noise or mistracking. If a CD is dirty or does not play properly, clean it with a soft, dry cloth, wiping straight out from the center, along the radius.

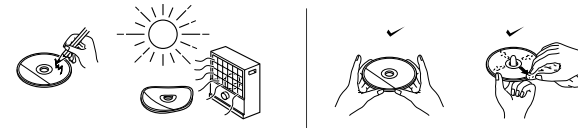

Recording to a Cassette Tape

Before recording:

- When recording important selections, make a preliminary test to ensure that the desired material is properly recorded.
- SHARP is not liable for damage or loss of your recording arising from malfunction of this unit.
- The ALC (Automatic Record Level Control) circuit automatically controls the level of the input signal used for recording.
- The VOLUME control may be adjusted with no effect on the recorded signal. (Variable Sound Monitor)
- Metal and CrO₂ tapes cannot be used for recording.

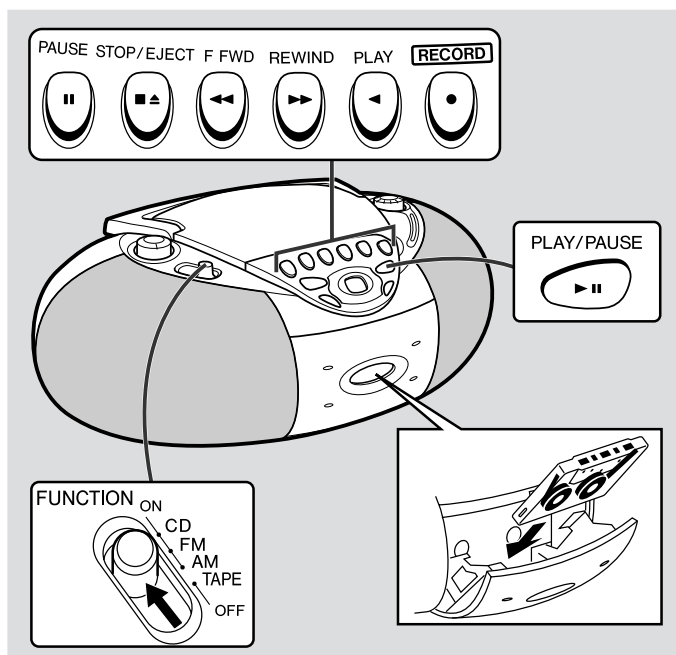

8

Recording from a CD

- 1 Set the FUNCTION switch to CD.
- 2 Load the disc to be recorded.
- 3 Load a blank cassette into the cassette compartment with the side to be recorded facing toward you.
- 4 Press the RECORD ● button.
- 5 Press the PLAY/PAUSE ► || button on the CD.

To stop recording:

Press the STOP/EJECT ■▲ button. If the STOP ■ or PLAY/PAUSE ► || button is pressed while recording, or if the CD comes to its end, the tape deck will not stop.

To record a specific track:

Press the REVIEW/DOWN ◀◀ or CUE/UP ▶▶ button until the desired track number is displayed, then start recording.

Recording from the radio

- 1 Set the FUNCTION switch to FM or AM.
- 2 Tune in to the station to be recorded.
- 3 Load a blank cassette into the cassette compartment with the side to be recorded facing toward you.
- 4 Press the PAUSE || button.
- 5 Press the RECORD ● button.
- 6 Press the PAUSE || button again.

To stop recording:

Press the STOP/EJECT ■▲ button.

Erasing a recorded tape

- 1 Set the FUNCTION switch to TAPE.
- 2 Load a tape into the cassette compartment with the side to be erased facing toward you.
- 3 Press the RECORD ● button.



Maintenance

■ Cleaning the lens and tape-handling parts

- Do not touch the laser pickup lens. If fingerprints or dust accumulate on the pickup, clean it gently with a dry cotton swab.
- Dirty heads, capstan or pinch roller can cause poor sound and tape jams. Clean these parts with a cotton swab moistened with commercial head/pinch roller cleaner or isopropyl alcohol.
- After long use, the deck's heads and capstan may become magnetized, causing poor sound. Demagnetize these parts once every 30 hours of playing/recording by using a commercial tape head demagnetizer. Read the demagnetizer's instructions carefully before use.

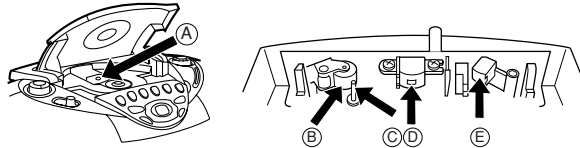

Ⓐ Laser pickup lens Ⓑ Pinch roller Ⓒ Capstan
Ⓓ Recording/Playback head Ⓔ Erase head

■ Cleaning the cabinet

Periodically wipe the cabinet with a soft cloth and a diluted soap solution, then wipe with a dry cloth.

Caution:

Do not use chemically treated cleaning cloths or other chemicals.

■ Condensation

Sudden temperature changes, storage or operation in an extremely humid environment may cause condensation inside the cabinet (CD pickup, tape heads, etc.).

Condensation can cause the unit to malfunction.

If this happens, leave the power on with no disc (or cassette) in the unit until normal playback is possible (about 1 hour).

Specifications

SHARP reserves the right to make design and specification changes for product improvement without prior notice.

■ General

Power source	AC 120 V, 60 Hz DC 9 V ["D" size (UM/SUM-1, R20 or HP-2) battery x 6]
Power consumption	11 W
Output power	FTC; 2.0 W min. RMS per channel into 4 ohms from 150 Hz to 20 kHz, with no more than 10 % total harmonic distortion. RMS; 2.3 W/CH (DC operation, 10 % T.H.D.)
Speakers	3-1/8" (8 cm) full-range speaker x 2
Dimensions	Width: 14-6/8" (376 mm) Height: 5-7/8" (150 mm) Depth: 9" (230 mm)
Weight	5.5 lbs. (2.5 kg) without batteries

■ Compact disc player

Type	Compact disc
Signal readout	Non-contact, 3-beam semi-conductor laser pickup
Audio channels	2
Filter	8-time oversampling digital filter
D/A converter	1-bit D/A converter
Wow and flutter	Unmeasurable (less than 0.001% W. peak)

■ Radio

Frequency range	FM; 87.5 - 108 MHz AM; 530 - 1,720 kHz
------------------------	---

■ Tape recorder

Frequency response	50 - 14,000 Hz (Normal tape)
Signal/noise ratio	50 dB
Wow and flutter	0.25 % (WRMS)
Motor	DC 9 V electric governor
Bias system	AC bias
Erase system	Magnet erase

Quick Guide / Guía rápida

1 Preparation for use / Preparación para su uso

■ Operation with AC power
 ■ *Funcionamiento con corriente alterna*

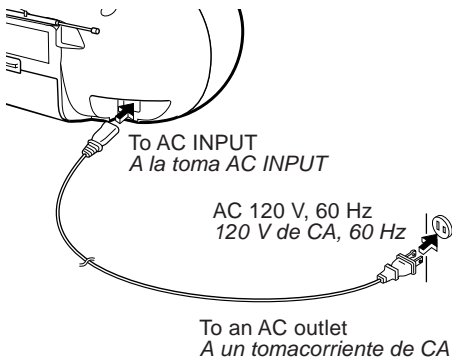

■ Operation with batteries
 ■ *Funcionamiento con pilas*

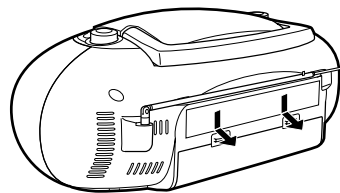

- 6 "D" size batteries (UM/SUM-1, R20, HP-2 or similar)
- Batteries are not included.
- 6 pilas del tamaño "D" (UM/SUM-1, R20, HP-2 o similares)
- Las pilas no están incluidas.

■ Turning the power ON and OFF
 ■ *Conexión (ON) y desconexión (OFF) de la alimentación*

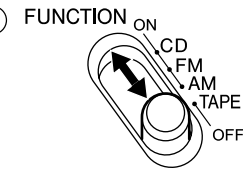
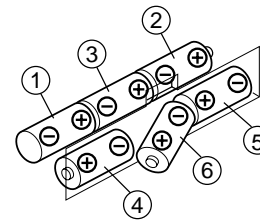





2 Listening to a CD / Audición de CD

<p>1</p>	<p>2</p>	<p>3</p> <ul style="list-style-type: none"> ● Label side up. ● <i>Con el lado de la etiqueta encarada hacia arriba.</i> 	<p>4</p>	<p>5 PLAY/PAUSE</p> <p>To stop playback Press the STOP ■ button. <i>Para detener la reproducción</i> Pulse el botón STOP ■.</p>
-----------------	-----------------	--	-----------------	--

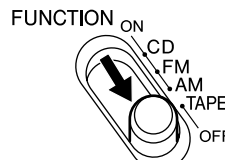





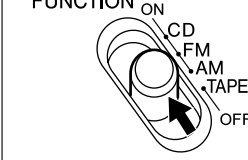
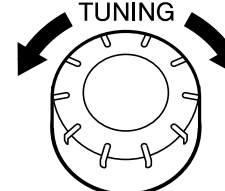

3 Listening to a tape / Audición de una cinta

<p>1</p> 	<p>2</p> <p>STOP/EJECT</p>   	<p>3</p> <p>PLAY</p>  <p>To stop playback Press the STOP/EJECT ■▲ button. <i>Para detener la reproducción Pulse el botón STOP/EJECT ■▲.</i></p>
---	---	--

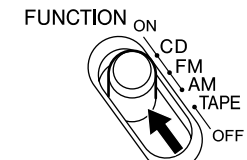
4 Listening to the radio / Audición de la radio

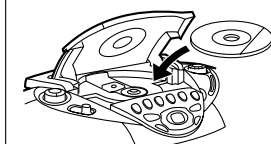
<p>1</p> 	<p>2</p> <p>TUNING</p> 
---	---

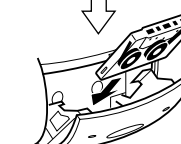
5 Recording from a CD / Grabaciones de CD

<p>1</p> 	<p>2</p>   <ul style="list-style-type: none"> ● Load the disc to be recorded. ● <i>Introduzca el disco que va a grabar.</i> 	<p>3</p> <p>STOP/EJECT</p>   	<p>4</p> <p>RECORD</p> 	<p>5</p> <p>PLAY/PAUSE</p>  <p>To stop recording Press the STOP/EJECT ■▲ button. <i>Para detener la grabación Pulse el botón STOP/EJECT ■▲.</i></p>
--	--	--	--	---



CONSUMER LIMITED WARRANTY

SHARP ELECTRONICS CORPORATION warrants to the first consumer purchaser that this Sharp brand product (the "Product"), when shipped in its original container, will be free from defective workmanship and materials, and agrees that it will, at its option, either repair the defect or replace the defective Product or part thereof with a new or remanufactured equivalent at no charge to the purchaser for parts or labor for the period(s) set forth below.

This warranty does not apply to any appearance items of the Product nor to the additional excluded item(s) set forth below nor to any Product the exterior of which has been damaged or defaced, which has been subjected to improper voltage or other misuse, abnormal service or handling, or which has been altered or modified in design or construction.

In order to enforce the rights under this limited warranty, the purchaser should follow the steps set forth below and provide proof of purchase to the servicer.

The limited warranty described herein is in addition to whatever implied warranties may be granted to purchasers by law. ALL IMPLIED WARRANTIES INCLUDING THE WARRANTIES OF MERCHANTABILITY AND FITNESS FOR USE ARE LIMITED TO THE PERIOD(S) FROM THE DATE OF PURCHASE SET FORTH BELOW. Some states do not allow limitations on how long an implied warranty lasts, so the above limitation may not apply to you.

Neither the sales personnel of the seller nor any other person is authorized to make any warranties other than those described herein, or to extend the duration of any warranties beyond the time period described herein on behalf of Sharp.

The warranties described herein shall be the sole and exclusive warranties granted by Sharp and shall be the sole and exclusive remedy available to the purchaser. Correction of defects, in the manner and for the period of time described herein, shall constitute complete fulfillment of all liabilities and responsibilities of Sharp to the purchaser with respect to the Product, and shall constitute full satisfaction of all claims, whether based on contract, negligence, strict liability or otherwise. In no event shall Sharp be liable, or in any way responsible, for any damages or defects in the Product which were caused by repairs or attempted repairs performed by anyone other than an authorized servicer. Nor shall Sharp be liable or in any way responsible for any incidental or consequential economic or property damage. Some states do not allow the exclusion of incidental or consequential damages, so the above exclusion may not apply to you.

THIS WARRANTY GIVES YOU SPECIFIC LEGAL RIGHTS. YOU MAY ALSO HAVE OTHER RIGHTS WHICH VARY FROM STATE TO STATE.

Model Specific Section

Your Product Model Number & Description: QT-CD180 Portable CD Stereo System
(Be sure to have this information available when you need service for your Product.)
One (1) year parts and ninety (90) days labor.

Warranty Period for this Product:
Additional Item(s) Excluded from Warranty Coverage (if any):

Non-functional accessories, supplies, and consumable items.

Where to Obtain Service:

At a Sharp Authorized Servicer located in the United States.

To find a location of the nearest Sharp Authorized Servicer, call Sharp toll free at 1-800-BE-SHARP.

What to do to Obtain Service:

Ship prepaid or carry in your Product to a Sharp Authorized Servicer.

Be sure to have **Proof of Purchase** available. If you ship the Product, be sure it is insured and packaged securely.

TO OBTAIN SUPPLY, ACCESSORY OR PRODUCT INFORMATION, CALL 1-800-BE-SHARP.

TINSE0053SJZZ

ENERGY STAR® Program Information

As an ENERGY STAR® Partner, SHARP has determined that this product meets the ENERGY STAR® guidelines for energy efficiency. ENERGY STAR® is a U.S. registered mark.



WHY PURCHASE ENERGY STAR® LABELED PRODUCTS?

Many Electrical /Electronic Products use energy both when they are on and when they are off. Americans spend more than \$3 billion a year on energy consumed by home electronic products when they are not in use. The new ENERGY STAR® labeled models will reduce that energy "leakage" by up to 75 percent. Ultimately, this will mean more than \$1 billion a year in energy savings for consumers.

The energy savings will help reduce the burning of fossil fuels and the related carbon dioxide pollution that contributes to global warming. If every American family replaced their electronic equipment with ENERGY STAR® labeled models, it would reduce air pollution equivalent to eliminating more than two million cars.

By using ENERGY STAR® labeled products, you will save money on your electric bills and use less energy.

That makes good economic sense and it's good for our environment.

ENERGY STAR® is a U.S. registered mark.

SHARP

SHARP ELECTRONICS CORPORATION

Sharp Plaza, Mahwah, New Jersey 07430-2135

SHARP CORPORATION

Printed in China
B0011.TO

Free Manuals Download Website

<http://myh66.com>

<http://usermanuals.us>

<http://www.somanuals.com>

<http://www.4manuals.cc>

<http://www.manual-lib.com>

<http://www.404manual.com>

<http://www.luxmanual.com>

<http://aubethermostatmanual.com>

Golf course search by state

<http://golfingnear.com>

Email search by domain

<http://emailbydomain.com>

Auto manuals search

<http://auto.somanuals.com>

TV manuals search

<http://tv.somanuals.com>