

# LC-32SB28UT-A LC-42SB48UT-A

## LIQUID CRYSTAL TELEVISION

### ENGLISH

## OPERATION MANUAL

#### IMPORTANT:

To aid reporting in case of loss or theft, please record the TV's model and serial numbers in the space provided. The numbers are located at the rear of the TV.

Model No.:

Serial No.:

## IMPORTANT INFORMATION

**WARNING:** TO REDUCE THE RISK OF FIRE OR ELECTRIC SHOCK, DO NOT EXPOSE THIS PRODUCT TO RAIN OR MOISTURE.



#### CAUTION

RISK OF ELECTRIC SHOCK  
DO NOT OPEN



This "bolt of lightning" indicates uninsulated material within your unit may cause an electric shock. For the safety of everyone in your household, please do not remove product covering.

CAUTION: TO REDUCE THE RISK OF ELECTRIC SHOCK,  
DO NOT REMOVE COVER (OR BACK).  
NO USER-SERVICEABLE PARTS INSIDE.  
REFER SERVICING TO QUALIFIED SERVICE  
PERSONNEL.



The "exclamation point" calls attention to features for which you should read the enclosed literature closely to prevent operating and maintenance problems.

# IMPORTANT INFORMATION

**WARNING:** FCC Regulations state that any unauthorized changes or modifications to this equipment not expressly approved by the manufacturer could void the user's authority to operate this equipment.

**CAUTION:**

This product satisfies FCC regulations when shielded cables and connectors are used to connect the unit to other equipment. To prevent electromagnetic interference with electric appliances such as radios and televisions, use shielded cables and connectors for connections.

**DECLARATION OF CONFORMITY:**

SHARP LIQUID CRYSTAL TELEVISION, MODEL LC-32SB28UT-A / LC-42SB48UT-A

This device complies with Part 15 of the FCC Rules. Operation is subject to the following two conditions: (1) This device may not cause harmful interference, and (2) this device must accept any interference received, including interference that may cause undesired operation.

RESPONSIBLE PARTY:

SHARP ELECTRONICS CORPORATION  
Sharp Plaza, Mahwah, New Jersey 07495-1163  
TEL: 1-800-BE-SHARP

For Business Customers: URL <http://www.sharppusa.com>

**INFORMATION:**

This equipment has been tested and found to comply with the limits for a Class B digital device, pursuant to Part 15 of the FCC Rules. These limits are designed to provide reasonable protection against harmful interference in a residential installation. This equipment generates, uses and can radiate radio frequency energy and, if not installed and used in accordance with the instructions, may cause harmful interference to radio communications. However, there is no guarantee that interference will not occur in a particular installation. If this equipment does cause harmful interference to radio or television reception, which can be determined by turning the equipment off and on, the user is encouraged to try to correct the interference by one or more of the following measures:

- Reorient or relocate the receiving antenna.
- Increase the separation between the equipment and receiver.
- Connect the equipment into an outlet on a circuit different from that to which the receiver is connected.
- Consult the dealer or an experienced radio/TV technician for help.

Note to CATV system installer: This reminder is provided to call the CATV system installer's attention to Article 820-40 of the National Electrical Code that provides guidelines for proper grounding and, in particular, specifies that the cable ground shall be connected to the grounding system of the building, as close to the point of cable entry as practical.

This product qualifies for ENERGY STAR when "Home" is selected for "TV Location".

Setting "TV Location" to "Home" allows the TV to achieve an energy-saving status for household use.

# TRADEMARKS

• HDMI, the HDMI logo, and High-Definition Multimedia Interface are trademarks or registered trademarks of HDMI Licensing LLC in the United States and other countries.

• Manufactured under license from Dolby Laboratories. Dolby and the double-D symbol are trademarks of Dolby Laboratories.

• Products that have earned the ENERGY STAR® are designed to protect the environment through superior energy efficiency.

# DEAR SHARP CUSTOMER

Thank you for your purchase of the Sharp Liquid Crystal Television. To ensure safety and many years of trouble-free operation of your product, please read the Important Safety Instructions carefully before using this product.

## IMPORTANT SAFETY INSTRUCTIONS

Electricity is used to perform many useful functions, but it can also cause personal injuries and property damage if improperly handled. This product has been engineered and manufactured with the highest priority on safety. However, improper use can result in electric shock and/or fire. In order to prevent potential danger, please observe the following instructions when installing, operating and cleaning the product. To ensure your safety and prolong the service life of your Liquid Crystal Television, please read the following precautions carefully before using the product.

- 1) Read these instructions.
- 2) Keep these instructions.
- 3) Heed all warnings.
- 4) Follow all instructions..
- 5) Do not use this apparatus near water.
- 6) Clean only with dry cloth.
- 7) Do not block any ventilation openings. Install in accordance with the manufacturer's instructions.
- 8) Do not install near any heat sources such as radiators, heat registers, stoves, or other apparatus (including amplifiers) that produce heat.
- 9) Do not defeat the safety purpose of the polarized or grounding-type plug. A polarized plug has two blades with one wider than the other. A grounding type plug has two blades and a third grounding prong. The wide blade or the third prong are provided for your safety. If the provided plug does not fit into your outlet, consult an electrician for replacement of the obsolete outlet.
- 10) Protect the power cord from being walked on or pinched particularly at plugs, convenience receptacles, and the point where they exit from the apparatus.
- 11) Only use attachments/accessories specified by the manufacturer.
- 12) Use only with the cart, stand, tripod, bracket, or table specified by the manufacturer, or sold with the apparatus. When a cart is used, use caution when moving the cart/apparatus combination to avoid injury from tip-over.
- 13) Unplug this apparatus during lightning storms or when unused for long periods of time.
- 14) Refer all servicing to qualified service personnel. Servicing is required when the apparatus has been damaged in any way, such as power-supply cord or plug is damaged, liquid has been spilled or objects have fallen into the apparatus, the apparatus has been exposed to rain or moisture, does not operate normally, or has been dropped.



### Additional Safety Information

- 15) Power Sources—This product should be operated only from the type of power source indicated on the marking label. If you are not sure of the type of power supply to your home, consult your product dealer or local power company. For products intended to operate from battery power, or other sources, refer to the operating instructions.
- 16) Overloading—Do not overload wall outlets, extension cords, or integral convenience receptacles as this can result in a risk of fire or electric shock.
- 17) Object and Liquid Entry—Never push objects of any kind into this product through openings as they may touch dangerous voltage points or short-out parts that could result in a fire or electric shock. Never spill liquid of any kind on the product.

# IMPORTANT SAFETY INSTRUCTIONS

- 18) Damage Requiring Service—Unplug this product from the wall outlet and refer servicing to qualified service personnel under the following conditions:
  - a) When the AC cord or plug is damaged,
  - b) If liquid has been spilled, or objects have fallen into the product,
  - c) If the product has been exposed to rain or water,
  - d) If the product does not operate normally by following the operating instructions.  
Adjust only those controls that are covered by the operating instructions as an improper adjustment of other controls may result in damage and will often require extensive work by a qualified technician to restore the product to its normal operation,
  - e) If the product has been dropped or damaged in any way, and
  - f) When the product exhibits a distinct change in performance - this indicates a need for service.
- 19) Replacement Parts—When replacement parts are required, be sure the service technician has used replacement parts specified by the manufacturer or have the same characteristics as the original part. Unauthorized substitutions may result in fire, electric shock, or other hazards.
- 20) Safety Check—Upon completion of any service or repairs to this product, ask the service technician to perform safety checks to determine that the product is in proper operating condition.
- 21) Wall or ceiling mounting—When mounting the product on a wall or ceiling, be sure to install the product according to the method recommended by the manufacturer.

## CAUTION

- These servicing instructions are for use by qualified service personnel only. To reduce the risk of electric shock do not perform any servicing other than that contained in the operating instructions unless you are qualified to do so.

- Outdoor Antenna Grounding — If an outside antenna is connected to the television equipment, be sure the antenna system is grounded so as to provide some protection against voltage surges and built-up static charges.  
Article 810 of the National Electrical Code, ANSI/NFPA 70, provides information with regard to proper grounding of the mast and supporting structure, grounding of the lead-in wire to an antenna discharge unit, size of grounding conductors, location of antenna-discharge unit, connection to grounding electrodes, and requirements for the grounding electrode.

EXAMPLE OF ANTENNA GROUNDING AS PER NATIONAL ELECTRICAL CODE, ANSI/NFPA 70

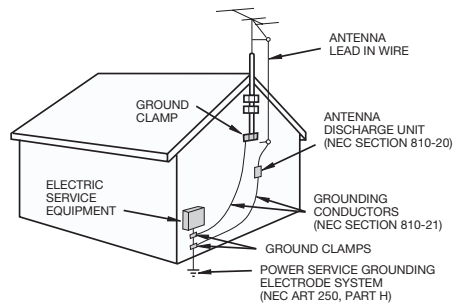

- Warning statement indicating that Class I apparatus shall be connected to a mains socket outlet with a protective earthing connection.
- Statement indicating that when the mains plug or appliance coupler shall remain readily operable.
- Where the MAINS plug or an appliance coupler is used as the disconnect device, the disconnect device shall remain readily operable.
- Where an all-pole MAINS SWITCH is used as the disconnect device, the location on the apparatus and the function of the switch shall be described, and the switch shall remain readily operable.

# IMPORTANT SAFETY INSTRUCTIONS

- **Water and Moisture** — Do not use this product near water - for example, near a bath tub, wash bowl, kitchen sink, or laundry tub; in a wet basement; or near a swimming pool; and the like.
- **Stand** — Do not place the product on an unstable cart, stand, tripod or table. Placing the product on an unstable base can cause the product to fall, resulting in serious personal injuries as well as damage to the product. Use only a cart, stand, tripod, bracket or table recommended by the manufacturer or sold with the product. When mounting the product on a wall, be sure to follow the manufacturer's instructions. Use only the mounting hardware recommended by the manufacturer.
- **Selecting the location** — Select a place with no direct sunlight and good ventilation.
- **Ventilation** — The vents and other openings in the cabinet are designed for ventilation. Do not cover or block these vents and openings since insufficient ventilation can cause overheating and/or shorten the life of the product. Do not place the product on a bed, sofa, rug or other similar surface, since they can block ventilation openings. This product is not designed for built-in installation; do not place the product in an enclosed place such as a bookcase or rack, unless proper ventilation is provided or the manufacturer's instructions are followed.
- **The Liquid Crystal panel used in this product is made of glass.** Therefore, it can break when the product is dropped or applied with impact. Be careful not to be injured by broken glass pieces in case the panel breaks.
- **Heat** — The product should be situated away from heat sources such as radiators, heat registers, stoves, or other products (including amplifiers) that produce heat.
- **The Liquid Crystal panel is a very high technology product with 1,049,088 pixels (LC-32SB28UT-A) / 2,073,600 pixels (LC-42SB48UT-A), giving you fine picture details.** Occasionally, a few non-active pixels may appear on the screen as a fixed point of blue, green or red. Please note that this does not affect the performance of your product.
- **Lightning** — For added protection for this television equipment during a lightning storm, or when it is left unattended and unused for long periods of time, unplug it from the wall outlet and disconnect the antenna. This will prevent damage to the equipment due to lightning and power-line surges.
- **Power Lines** — An outside antenna system should not be located in the vicinity of overhead power lines or other electric light or power circuits, or where it can fall into such power lines or circuits. When installing an outside antenna system, extreme care should be taken to keep from touching such power lines or circuits as contact with them might be fatal.
- **To prevent fire, never place any type of candle or flames on the top or near the TV set.**
- **To prevent fire or shock hazard, do not place the AC cord under the TV set or other heavy items.**
- **Do not display a still picture for a long time, as this could cause an afterimage to remain.**
- **To prevent fire or shock hazard, do not expose this product to dripping or splashing.**  
No objects filled with liquids, such as vases, should be placed on the product.
- **Do not insert foreign objects into the product.** Inserting objects in the air vents or other openings may result in fire or electric shock. Exercise special caution when using the product around children.



## Precautions when transporting the TV

- **When transporting the TV, never carry it by holding or otherwise putting pressure onto the display.** Be sure to always carry the TV by two people holding it with two hands — one hand on each side of the TV.

# IMPORTANT SAFETY INSTRUCTIONS

## Caring for the Cabinet

- Use a soft cloth (cotton, flannel, etc.) and gently wipe the surface of the cabinet.
- Using a chemical cloth (wet/dry sheet type cloth, etc.) may deform the components of the main unit cabinet or cause cracking.
- Wiping with a hard cloth or using strong force may scratch the surface of the cabinet.
- If the cabinet is very dirty, wipe with a soft cloth (cotton, flannel, etc.) soaked in neutral detergent diluted with water and thoroughly wrung out, and then wipe with a soft dry cloth.
- The cabinet is primarily made of plastic. Avoid using benzene, thinner, and other solvents, as these may deform the cabinet and cause the paint to peel off.
- Do not apply insecticides or other volatile liquids.  
Also, do not allow the cabinet to remain in contact with rubber or vinyl products for a long period of time. Plasticizers inside the plastic may cause the cabinet to deform and cause the paint to peel off.

## Caring for the Liquid Crystal panel

- Turn off the main power and unplug the AC cord from the wall outlet before handling.
- Gently wipe the surface of the display panel with a soft cloth (cotton, flannel, etc.).  
To protect the display panel, do not use a dirty cloth, liquid cleaners, or a chemical cloth (wet/ dry sheet type cloth, etc.). This may damage the surface of the display panel.
- Wiping with a hard cloth or using strong force may scratch the surface of the display panel.
- Use a soft damp cloth to gently wipe the display panel when it is really dirty. (It may scratch the surface of the display panel when wiped strongly.)
- If the display panel is dusty, use an anti-static brush, which is commercially available, to clean it.
- To avoid scratching the frame or screen, please use a soft, lint free cloth for cleaning. Approved cleaning cloths are available directly from Sharp in single (00Z-LCD-CLOTH) or triple (00Z-LCD-CLOTH-3) packs.  
Call 1-800-BE-SHARP for ordering, or VISIT <http://www.sharpusa.com/SharpDirect>.

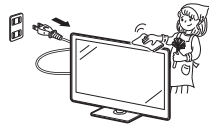

# IMPORTANT SAFETY INSTRUCTIONS

## CHILD SAFETY

### It Makes A Difference How and Where You Use Your Flat Panel Display

Congratulations on your purchase! As you enjoy your new product, please keep these safety tips in mind:



#### THE ISSUE

- The home theater entertainment experience is a growing trend and larger flat panel displays are popular purchases. However, flat panel displays are not always supported on the proper stands or installed according to the manufacturer's recommendations.
- Flat panel displays that are inappropriately situated on dressers, bookcases, shelves, desks, speakers, chests or carts may fall over and cause injury.

#### THIS MANUFACTURER CARES!

- The consumer electronics industry is committed to making home entertainment enjoyable and safe.

#### TUNE INTO SAFETY

- One size does NOT fit all. Follow the manufacturer's recommendations for the safe installation and use of your flat panel display.
- Carefully read and understand all enclosed instructions for proper use of this product.
- Don't allow children to climb on or play with furniture and television sets.
- Don't place flat panel displays on furniture that can easily be used as steps, such as a chest of drawers.
- Remember that children can become excited while watching a program, especially on a "larger than life" flat panel display. Care should be taken to place or install the display where it cannot be pushed, pulled over, or knocked down.
- Care should be taken to route all cords and cables connected to the flat panel display so that they cannot be pulled or grabbed by curious children.



#### WALL MOUNTING: IF YOU DECIDE TO WALL MOUNT YOUR FLAT PANEL DISPLAY, ALWAYS:

- Use a mount that has been recommended by the display manufacturer and/or listed by an independent laboratory (such as UL, CSA, ETL).
- Follow all instructions supplied by the display and wall mount manufacturers.
- If you have any doubts about your ability to safely install your flat panel display, contact your retailer about professional installation.
- Make sure that the wall where you are mounting the display is appropriate. Some wall mounts are not designed to be mounted to walls with steel studs or old cinder block construction. If you are unsure, contact a professional installer.
- A minimum of two people are required for installation. Flat panel displays can be heavy.



**Note:** CEA is the preeminent trade association promoting growth in the \$161 billion U.S. consumer electronics industry. More than 2,200 companies enjoy the benefits of CEA membership, including legislative advocacy, market research, technical training and education, industry promotion and the fostering of business and strategic relationships.

# QUICK REFERENCE

## Supplied Accessories

Make sure the following accessories are provided with the product.



Remote control unit  
(× 1)  
Page 11



"AA" size battery  
(× 2)  
Page 13

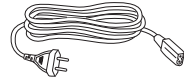

AC cord  
(× 1)  
Page 10

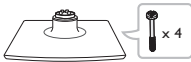

Stand (× 1)  
with Screws  
Page 8



Operation manual  
(× 1)

### NOTE

- Always use the AC cord supplied with the TV.
- The illustrations above are for explanation purposes and may vary slightly from the actual accessories.

## Attaching/Detaching the Stand

- Before attaching (or detaching) the stand, unplug the AC cord from the AC INPUT terminal.
- Before performing work spread cushioning over the base area to lay the TV on. This will prevent it from being damaged.

### CAUTION

- **Attach the stand in the correct direction.**
- **Be sure to follow the instructions. Incorrect installation of the stand may result in the TV falling over.**

1. Put the TV face down on a safe surface that is covered by a soft and smooth cloth.
2. Adjust the TV stand to the bottom of the TV.
3. Fasten the screws by using a cross-head screwdriver (Not supplied).

### CAUTION

- **Do not push to hard or put excessive pressure to the stand neck to avoid the damages when you turn the TV for the most comfortable viewing angle.**

### NOTE

- To detach the stand, perform the steps in reverse order.

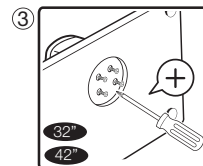
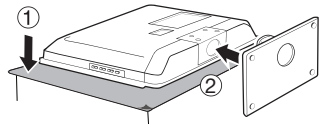



## QUICK REFERENCE

### Detaching the stand neck for wall mounting

#### CAUTION

- Please use care when disassembling cabinet, stand, and pillar for wall mounting.
  - Detach the stand neck in the correct direction.
  - Do not remove the stand neck from the TV unless using an optional wall mount bracket to mount it.
1. Loosen the 4 screws that secure the stand neck by using a cross-head screwdriver. Remove stand cover from the TV set.

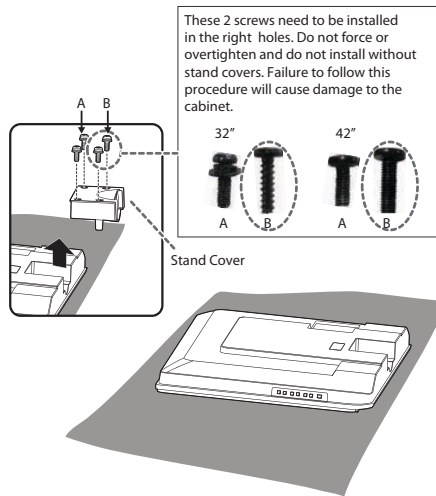

#### NOTE

- To attach the stand neck, perform the steps in reverse order.
- Do not force or overtighten and do not install without stand covers.

## QUICK REFERENCE

### Quick Installation Tips

- 1 Attach your antenna to the back of the television. (See page 12.)
- 2 Connect the AC plug for the television into the AC outlet.

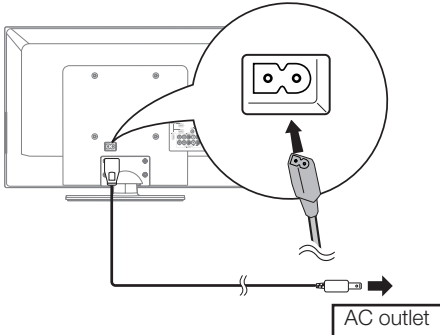

- Place the TV close to the AC outlet, and keep the power plug within reach.
- This product must only be connected to a 120V, 60Hz. Connecting it to any other kind of outlet will damage the product and invalidate the warranty.

#### NOTE

- **TO PREVENT RISK OF ELECTRIC SHOCK, DO NOT TOUCH UN-INSULATED PARTS OF ANY CABLES WITH THE AC CORD CONNECTED.**

- 3 Bundle the cords properly with the cable tie.

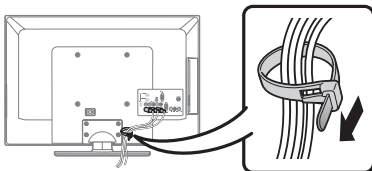

- 4 How to turn on the television for the first time.
  - A) Press **POWER** on the television.
  - B) The POWER indicator on the front of the television lights BLUE.

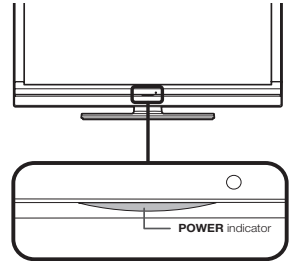
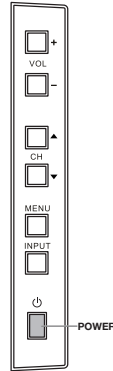

#### NOTE

- Speakers cannot be detached from the TV.

## QUICK REFERENCE

### Using the Remote Control Unit

Use the remote control unit by pointing it towards the remote control sensor on the TV. Objects between the remote control unit and the remote control sensor may prevent proper operation.

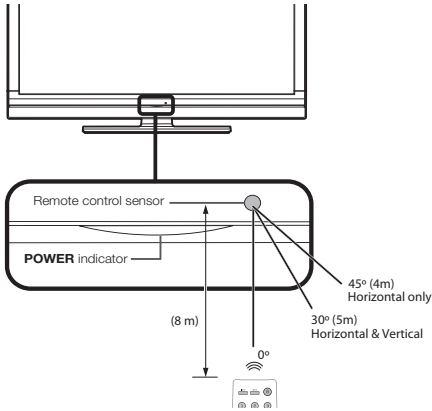

#### ■ Cautions regarding the remote control unit

- Do not expose the remote control unit to shock. In addition, do not expose the remote control unit to liquids, and do not place in an area with high humidity.
- Do not install or place the remote control unit under direct sunlight. The heat may cause deformation of the remote control unit.
- The remote control unit may not work properly if the remote control sensor on the TV is under direct sunlight or strong lighting. In such cases, change the angle of the lighting or the TV, or operate the remote control unit closer to the remote control sensor.

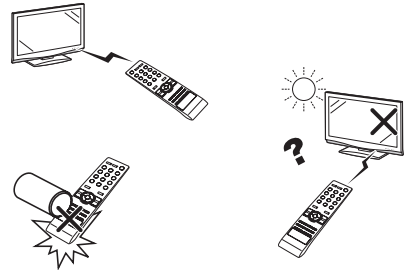

#### IMPORTANT:

If the POWER indicator on the television still does not light up, press **POWER** on the remote control to turn the power on.

#### IMPORTANT:

IF THE UNIT DOES NOT POWER ON - UNPLUG THE TELEVISION FROM THE OUTLET AND REPEAT THE INSTALLATION STEPS.

IF YOU STILL ENCOUNTER NO POWER, PLEASE CONTACT US AT 1-800-BE-SHARP.

# Preparation

## Antennas

To enjoy a clearer picture, use an outdoor antenna. The following is a brief explanation of the types of connections that are used for a coaxial cable. If your outdoor antenna uses a 75-ohm coaxial cable with an F-type connector, plug it into the antenna terminal at the rear of the TV set.

1. A 75-ohm system is generally a round cable with F-type connector that can easily be attached to a terminal without tools (Commercially available).
2. A 300-ohm system is a flat "twin-lead" cable that can be attached to a 75-ohm terminal through a 300/75-ohm adapter (Commercially available).

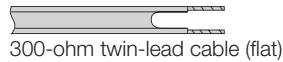
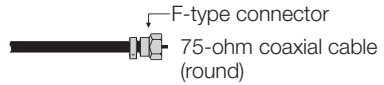

### NOTE

When connecting the RF cable to the TV set, do not tighten F-type connector with tools. If tools are used, it may cause damage to your TV set. (The breaking of internal circuit, etc.)

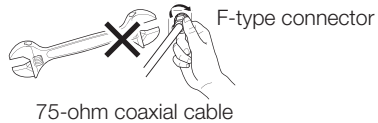

## Connecting Antenna

- Connect the antenna cable to the TV using one of the methods in the illustration as shown (1, 2, 3 or 4).

### ① Cable without a CATV converter



### ② VHF/UHF antenna



### ③ Combination VHF/UHF antenna

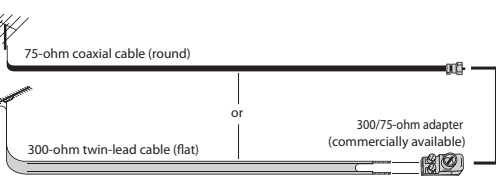

### ④ Separate VHF/UHF antenna

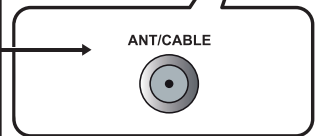
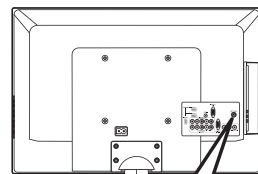
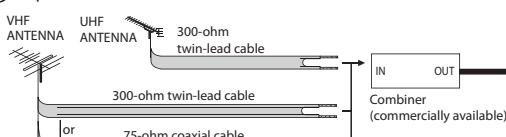

To TV antenna terminal

## Preparation

### Installing Batteries in the Remote Control Unit

If the remote control fails to operate TV functions, replace the batteries in the remote control unit.

1 Open the battery cover.

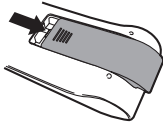

3 Close the battery cover.

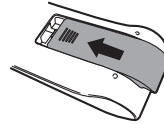

2 Insert two “AA” size batteries (supplied with the product).

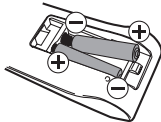

- Place the batteries with their terminals corresponding to the (+) and (–) indications in the battery compartment.

#### CAUTION

Improper use of batteries can result in chemical leakage or explosion. Be sure to follow the instructions below.

- Do not mix batteries of different types. Different types of batteries have different characteristics.
- Do not mix old and new batteries. Mixing old and new batteries can shorten the life of new batteries or cause chemical leakage in old batteries.
- Remove batteries as soon as they are worn out. Chemicals that leak from batteries come in contact with skin can cause a rash. If you find any chemical leakage, wipe thoroughly with a cloth.
- The batteries supplied with this product may have a shorter life expectancy due to storage conditions.
- If you will not be using the remote control unit for an extended period of time, remove batteries from it.
- The batteries (batteries installed) shall not be exposed to excessive heat such as sunshine, fire or the like.

# Contents

---

<b>IMPORTANT INFORMATION</b> .....	<b>1</b>
<b>TRADEMARKS</b> .....	<b>2</b>
<b>IMPORTANT SAFETY INSTRUCTIONS</b> .....	<b>3</b>
<b>QUICK REFERENCE</b> .....	<b>8</b>
Supplied Accessories .....	8
Attaching/Detaching the Stand .....	8
Detaching the stand neck for wall mounting .....	9
Quick Installation Tips .....	10
Using the Remote Control Unit .....	11
Antennas .....	12
Connecting Antenna Cable .....	12
Installing Batteries in the Remote Control Unit .....	13
<b>Contents</b> .....	<b>14</b>
<b>Part Names</b> .....	<b>15</b>
TV (Front) .....	15
TV (Side/Rear) .....	15
Remote Control Unit .....	16
<b>Connecting to External Equipment</b> .....	<b>17</b>
<b>Watching TV</b> .....	<b>19</b>
Turning On/Off the Power .....	19
Initial Setup .....	19
<b>Direct Button Operation</b> .....	<b>21</b>
<b>On-Screen Display Menu</b> .....	<b>25</b>
Menu Items .....	25
On-Screen Display Menu Operation .....	27
Menu Operation Button .....	28
Video Menu .....	28
Audio Menu .....	30
TV Menu .....	31
Setup Menu .....	32
Parental Menu .....	34
USB Menu .....	38
<b>Appendix</b> .....	<b>40</b>
Troubleshooting .....	40
Specifications .....	41
PC Compatibility Chart .....	42
RS232 Port Specifications .....	43
Information on the Software License for This Product .....	44
Legal notices .....	45
<b>Calling for Service</b> .....	<b>46</b>
<b>LIMITED WARRANTY</b> .....	<b>46</b>

## Dimensional Drawings

- The dimensional drawings for the LCD TV set are shown on the inside back cover.

# Part Names

## TV (Front)

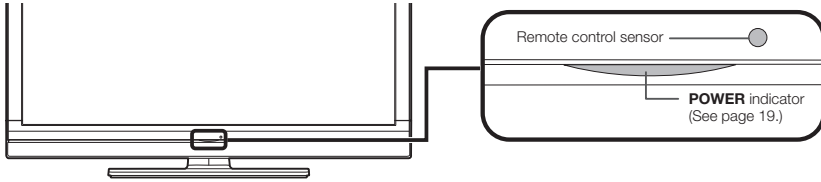

## TV (Side/Rear)

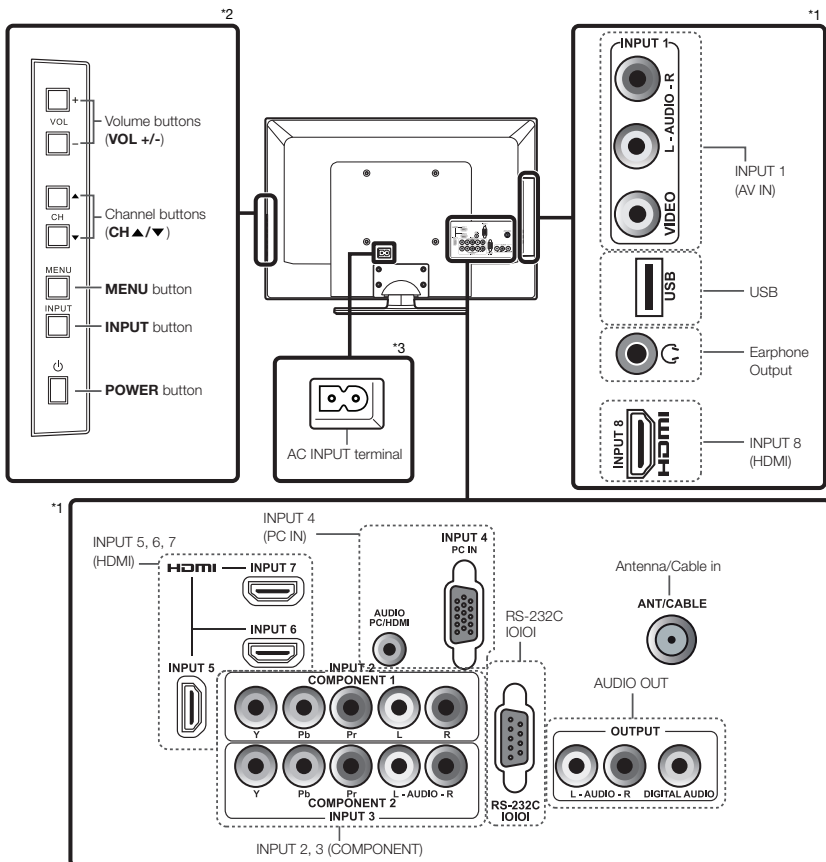

\*1: See pages 12, 17, and 18 for external equipment connection.

\*2: See page 19 and 28 for button operations.

\*3: See page 10 for connecting the AC cord.

### NOTE

- The illustrations in this operation manual are for explanation purposes and may vary slightly from the actual operations.

## Part Names

### Remote Control Unit

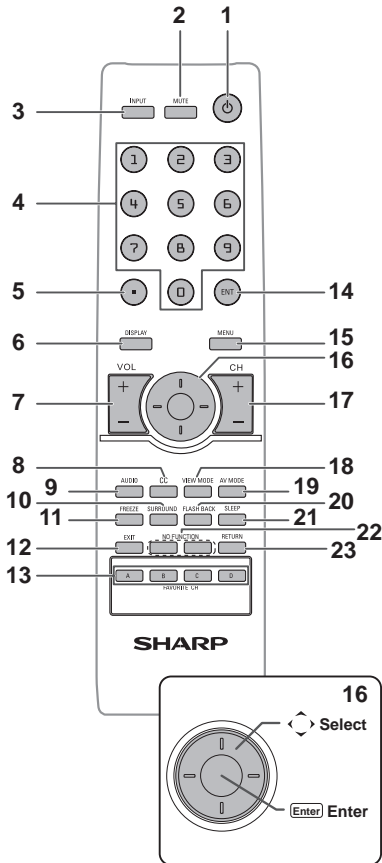

#### NOTE

- When using the remote control unit, point it at the TV.
- 1 **POWER:** Switch the power on or enters standby mode. (See page 19.)
  - 2 **MUTE:** Mute the sound. (See page 21.)
  - 3 **INPUT:** Select a TV input source. (See page 21.)
  - 4 **0-9:** Set the channel.
  - 5 • **(DOT):** (See page 21.)

- 6 **DISPLAY:** Display the current channel (or input source) information on the screen.
- 7 **VOL +/- :** Set the volume. (See page 21.)
- 8 **CC:** Display captions during closed-caption source. (See page 23.)
- 9 **AUDIO:** Display the MTS/SAP setting menu. (See page 22-23.)
- 10 **SURROUND:** Display the surround setting menu. (See page 22.)
- 11 **FREEZE:** Set the still image. Press again to return to normal screen.
- 12 **EXIT:** Turn off the menu screen.
- 13 **FAVORITE CH:**  
A, B, C, D: Select 4 preset favorite channels in 4 different categories. (See page 31 for details.) While watching, you can toggle the selected channels by pressing A, B, C and D.
- 14 **ENT:** Jumps to a channel after selecting with the 0-9 buttons.
- 15 **MENU:** Display the menu screen.
- 16 **(Select/Enter):** Select a desired item on the screen. / Confirms an entry or selection.
- 17 **CH +/- :** Select the channel. (See page 21.)
- 18 **VIEW MODE:** Select the Picture Mode. (See page 24.)
- 19 **AV MODE:** Select an adjusted picture settings. (**Standard, Movie, Power Saver, User, Sports**) (See page 22.)
- 20 **FLASHBACK:** Press to switch to the previously tuned channel. Press again to switch back to the currently tuned channel.
- 21 **SLEEP:** Allows you to set a time when the TV automatically switches to standby. This display will disappear after a few seconds, and the sleep timer automatically starts counting down. (See page 21.)
- 22 These buttons do not function.
- 23 **RETURN:** Return to the previous menu screen.













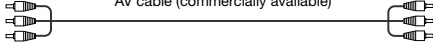

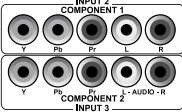
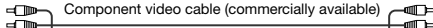
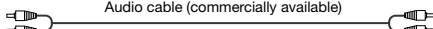
# Connecting to External Equipment

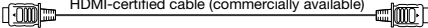
You can connect many types of external equipment to your TV like a Blu-ray disc player, HD-DVD player, DVD player, VCR, HDMI equipment, game console or camcorder. To view external source images, select the input source from **INPUT** on the remote control unit or **INPUT** on the TV. (See page 21.)

## CAUTION

- To protect equipment, always turn off the TV before connecting any external equipment.
- Please read the relevant operation manual (Blu-ray disc player, etc.) carefully before making connections.

Connecting a Blu-ray disc player, HD-DVD player, DVD player, VCR, game console or camcorder.

Terminal on the TV	Cable	Terminal on external equipment
<b>INPUT 1 (AV IN)</b> 	 AV cable (commercially available)	
<b>INPUT 2, 3 (COMPONENT)</b> 	 Component video cable (commercially available)  Audio cable (commercially available)	
<b>INPUT 5, 6, 7, 8</b> 	 HDMI-certified cable (commercially available)	<b>HDMI</b> 
<b>AUDIO OUT</b> 	 Audio cable (commercially available)	
<b>HEADPHONE OUTPUT</b> 	 Headphone cable (commercially available)	







\*1

## NOTE

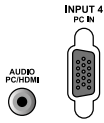
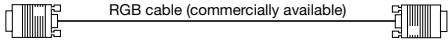
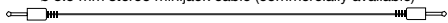
- Digital Audio Output cannot be used for all HDMI Inputs.
- \*1 When using an HDMI-DVI conversion cable, input the audio signal to AUDIO terminal of PC IN.
- To enjoy the 1080p display capability, connect your Blu-ray disc player, HD-DVD player or other external equipment using an HDMI-certified cable and set the equipment to 1080p output.

## Connecting to External Equipment

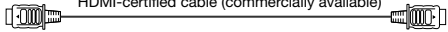
### Connecting a PC

Terminal on the TV	Cable	Terminal on PC
<p>INPUT 4 (PC IN)</p> 	<p>RGB cable (commercially available)</p>  <p>ø 3.5 mm stereo minijack cable (commercially available)</p> 	 <p>ANALOG RGB</p>  <p>AUDIO</p>
<p>INPUT 5, 6, 7, 8</p> 	<p>HDMI-certified cable (commercially available)</p> 	

### NOTE

- The HDMI terminals only support digital signal.
- Refer to page 42 for a list of PC signals compatible with the TV.
- When using an HDMI-DVI conversion cable, input the audio signal to AUDIO terminal of PC IN.
- To enjoy the 1080p display capability, connect your Blu-ray disc player, HD-DVD player or other external equipment using an HDMI-certified cable and set the equipment to 1080p output.

# Watching TV

## Turning On/Off the Power

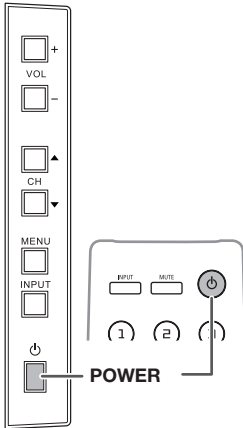

Press **POWER** on the TV, or **POWER** on the remote control unit to turn the power on.

- POWER indicator (Blue): The TV is on.

Press **POWER** on the TV, or **POWER** on the remote control unit again to turn the power off.

- The TV enters standby and the image on the screen disappears.

### NOTE

- If you are not going to use this TV for a long period of time, be sure to remove the AC cord from the AC outlet.
- Small amount of electric power is still consumed even when the TV is turned off.
- If there is no signal input for 30 minutes, the power will turn to standby mode automatically.

## Initial Setup

When you turn on the TV for the first time, the Initial Setup will guide you through the setup process. Perform the following steps before you press **POWER** on the remote control unit.

1. Insert the batteries into the remote control unit. (See page 13.)
2. Connect the antenna cable to the TV. (See page 12.)
3. Plug in the AC cord to the AC outlet. (See page 10.)

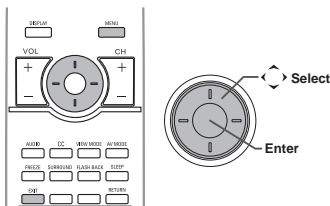

### 1. Initial Setup

- The Initial Setup screen display at the first use. Press **Enter** to start the initial setup.

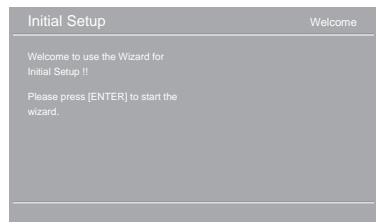

### 2. Language setting

- Select the OSD menu language from English, Spanish, or French.
- Press **▲/▼** to select the desired language listed on the screen, and then press the **▶** button to the next step.

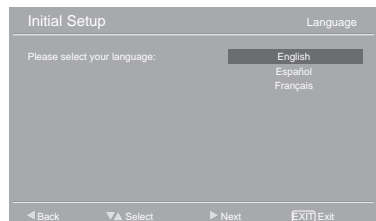

# Watching TV

## 3. Location setting

- Press ▲/▼ to select “Home” or “Store” and press ► to the next step.

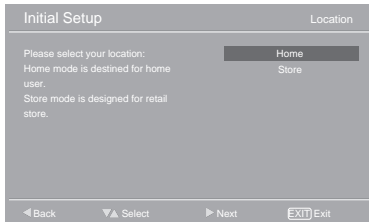

## 4. Time Zone setting

- Press ▲/▼ to select your current location for time zone.

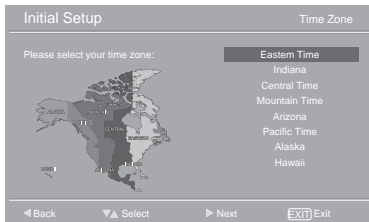

## 5. Tuner setting

- Make sure what kind of connection is made with your TV when selecting “Air” or “Cable”.
- Press ▲/▼ to select “Air” or “Cable” and press ► to the next step.

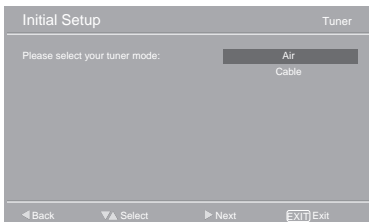

## 5. Channel scan setting

- Press ▲/▼ to select “Scan” or “Skip Scan” and press ► to continue.

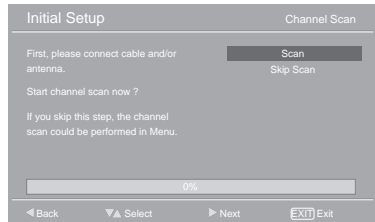

## 6. Start channel searching

- Wait until the channel scan to complete.
- If you press **EXIT**, the process will return to the previous step.
- If you skip this step, the channel search can be performed in the TV Menu. (See page 31.)

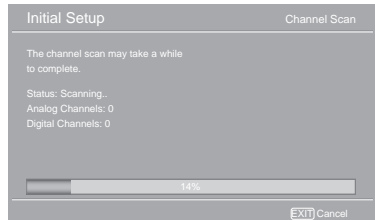

## 7. Initial setup completed

- Press **Enter** to exit the setup wizard.

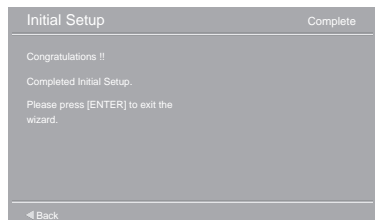

### NOTE

- Auto programming may take 20+ minutes to complete. Please wait until you see the Auto programming complete message. The TV will then switch automatically to the first channel found.

# Direct Button Operation

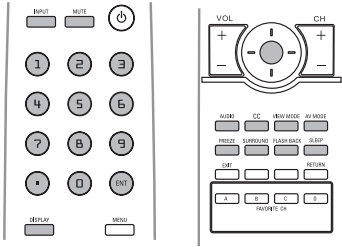

## Changing Channels

You can change channels by pressing **CH +/-** or **0-9**, or **• (DOT)**.

### Examples:

To select a 1 or 2-digit channel number

(e. g., Channel 5):

Press **5** → **ENT**.

To select a 3-digit channel number

(e. g., Channel 115):

Press **1** → **1** → **5** → **ENT**.

To select a 4-digit channel number

(e. g., Channel 22.1):

Press **2** → **2** → **• (DOT)** → **1** → **ENT**.

### NOTE

- When selecting a 1-digit channel number, it is not necessary to press **0** before the number.

## Changing Volume

You can change the volume by pressing **VOL +/-** on the TV or on the remote control unit.

- To increase the volume, press **VOL +**.
- To decrease the volume, press **VOL -**.

## INPUT

To view external source images, select the input source using **INPUT** on the remote control unit or **INPUT** on the TV.

- Press **INPUT**.
  - A list of selectable sources appears.
- Press **INPUT** again to select the input source.

- An image from the selected source automatically displays.
- Each time **INPUT** is pressed, the input source toggles.
- If you press **▲/▼** to select the input source, press **Enter** to confirm your selection.

### NOTE

- See page 17-18 for external equipment connection.

## MUTE

Mutes the current sound output. Press **MUTE**.

### NOTE

- Mute can be canceled by using the method below.
  - Mute will be canceled if you press **VOL +/-** or **MUTE**.

## SLEEP

Allows you to set a time when the TV automatically switches to standby. Press **SLEEP**.

Press **SLEEP**.

- The remaining time displays when the sleep timer has been set.
- Each time you press **SLEEP**, the remaining time switches as shown below.  
**Off, 10, 20, 30, 40, 50, 60, 90, 120**
- When set, the time automatically starts counting down.
- If you want to adjust the sleep timer, you can press **SLEEP** twice then change the time setting.
- One minute before the time expires, the remaining time displays every second.

### NOTE

- Select **"Off"** by pressing **SLEEP** to cancel the sleep timer.
- The TV will enter standby mode (power indicator lights red) when the remaining time reaches zero.

## Direct Button Operation

### FLASHBACK

Press **FLASHBACK** to switch to the previously tuned channel.

- Press **FLASHBACK** again to switch back to the currently tuned channel.

### SURROUND

The surround function produces Surround effect from the speakers. Each time you press **SURROUND**, the mode changes between On and Off.

- **On:** Makes it possible to enjoy natural, realistic surround sound.
- **Off:** Outputs the normal sound.

### NOTE

- You can have the same settings by choosing "Surround" on the menu items. (See page 30.)

### FREEZE

Allows you to capture and freeze a moving image that you are watching.

Press **FREEZE**.

- A moving image is captured.
- Press **FREEZE** again to cancel the function

### AV MODE

AV MODE gives you several viewing options to choose from to best match the surrounding environment of the TV, which can vary due to factors like room brightness, type of program watched or the type of image input from external equipment.

Press **AV MODE**. Current AV MODE displays.

- Press **AV MODE** again before the mode displayed on the screen disappears.

### AUDIO

#### ■ MTS/SAP stereo mode

The TV has a feature that allows reception of sound other than the main audio for the program. This feature is called Multi-channel Television Sound (MTS). The TV with MTS can receive mono sound, stereo sound and Secondary Audio Programs (SAP). The SAP feature allows a TV station to broadcast other information, which could be audio in another language or something completely different like weather information.

#### You can enjoy Hi-Fi stereo sound or SAP broadcasts when available.

- **Stereo broadcasts:** View programs like live sporting events, shows and concerts in dynamic stereo sound.
- **SAP broadcasts:** Receive TV broadcasts in either MAIN or SAP sound.  
**MAIN sound:** The normal program soundtrack (either in mono or stereo).  
**SAP sound:** Listen to a second language, supplementary commentary or other information. (SAP is mono sound.)

#### If stereo sound is difficult to hear.

- Obtain a clearer sound by manually switching to fixed mono-sound mode.

You can change MTS as shown below to match the television broadcast signal.

Press **AUDIO** to toggle between audio modes.

#### Examples: when receiving MTS and SAP

MAIN + SAP mode: MAIN  $\longleftrightarrow$  SAP

MONO mode: MONO

## Direct Button Operation

### ■ Digital broadcasting audio mode

The types of audio transmitted in a digital broadcast include SURROUND as well as MONO and STEREO. In addition, it is possible for multiple audio tracks to accompany a single video track.

Press **MTS/SAP** to toggle between audio modes.

### Example: when receiving Digital broadcasting

STEREO (Audio1) → STEREO (Audio2)  
← SURROUND (Audio3) ←

#### NOTE

- MTS only operates while in TV mode.

## Closed Captions (CC)

Your TV is equipped with an internal Closed Caption decoder. It allows you to view conversations, narration and sound effects as subtitles on your TV. Closed Captions are available on some TV programs and on some VHS home video tapes at the discretion of the program provider.

Digital Closed Caption service is a new caption service available only on digital TV programs (also at the discretion of the service provider). It is a more flexible system than the original Closed Caption system, because it allows for a variety of caption sizes and font styles. When the Digital Closed Caption service is in use, it will be indicated by the appearance of a 3-letter abbreviation that also indicates the language of the Digital Closed Captions: ENG (English), SPA (Spanish), FRA (French) or other language codes.

Not all programs and VHS videotapes offer closed captions.

In the Closed Caption system, there can be more than one caption service provided. Each is identified by its own number. The “CC1” to “CC4” services display subtitles of TV programs superimposed over the program's picture.

In the Closed Caption system, the “TEXT1” to “TEXT4” services display text that is unrelated to the program being viewed (e.g., weather or news). These services are also superimposed over the program currently being viewed.

### 1. Press **CC**.

- This will display the current Closed Caption information. Press CC to turn the Closed Caption on or off.

#### NOTE

- Caption Display will not work when viewing a 480i, 480p, 720p, 1080i or 1080p input via the COMPONENT: Y-PbPr or HDMI inputs.
- Closed Captions availability and content depends on the broadcaster. Closed Caption are available when the Closed Caption icon is displayed on screen.
- Closed Captions and Digital Captions availability and content depends on the broadcaster. Closed Caption are available when the Closed Caption icon is displayed on screen

## Direct Button Operation

### VIEW MODE

You can select the screen size.

Press **VIEW MODE**.

- You can sequentially select a viewing mode that has its own aspect ratio.
- Press **VIEW MODE** to toggle between Stretch, Side Bar, Smart stretch, Zoom, Dot by Dot, or Automatic.

#### ■ For 4:3 programs

**Example: Screen size images**

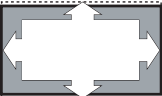
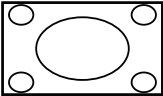
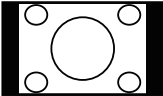
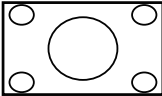
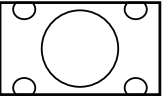
Automatic	Stretch	Side Bar	Smart stretch	Zoom
 <p>Suitable for viewing subtitles and enlarging picture automatically to fill the screen</p>	 <p>This mode is useful for 1.78:1 DVDs. When viewing 1.85:1 DVDs, stretch mode will still show very thin black bands at the top and bottom of the screen.</p>	 <p>Suitable for viewing conventional 4:3 programs in their normal format.</p>	 <p>Suitable for stretching 4:3 programs to fill the screen.</p>	 <p>Suitable for viewing wide-screen 2.35:1 anamorphic DVDs in full screen.</p>

#### ■ For PC input

**Example: Screen size images**

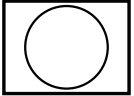
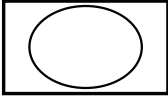
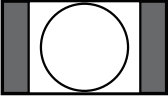
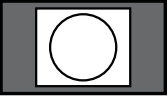
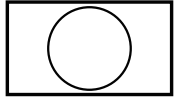
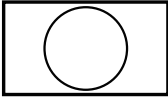
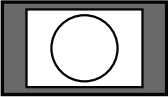
<p><b>Input signal</b></p>  <p>4:3</p>	<p><b>Stretch</b></p>  <p>An image fully fills the screen.</p>	<p><b>Side Bar</b></p>  <p>Suitable for viewing conventional 4:3 programs in their normal format.</p>	<p><b>Dot by Dot</b></p>  <p>Detects the resolution of the signal and displays an image with the same number of pixels on the screen.</p>
<p><b>Input signal</b></p>  <p>16:9</p>	<p><b>Stretch</b></p>  <p>An image fully fills the screen.</p>	<p><b>Dot by Dot</b></p>  <p>Detects the resolution of the signal and displays an image with the same number of pixels on the screen.</p>	



# On-Screen Display Menu

## Menu Items

### For TV Mode

<b>Video Menu</b> .....	<b>28</b>
AV Mode .....	29
Backlight .....	28
Brightness .....	28
Contrast .....	28
Saturation .....	28
Hue .....	28
Sharpness .....	28
Color Temperature .....	29
Warm .....	29
Normal .....	29
Cool .....	29
User .....	29
Advanced Video .....	29
DNR .....	29
MPEG NR .....	29
Adaptive Luma Control .....	29
Flesh Tone .....	29
DI Film Mode .....	29
Blue Stretch .....	29
Game Mode .....	29
HDMI Mode .....	29
Adaptive Backlight .....	29
<b>Audio Menu</b> .....	<b>30</b>
Balance .....	30
Bass .....	30
Treble .....	30
Sound Surround .....	30
Equalizer .....	30
Speaker .....	30
SPDIF Type .....	30
Auto Volume Control .....	30
<b>TV Menu</b> .....	<b>31</b>
Tuner Mode .....	31
Auto CH Search .....	31
CH Skip .....	31
Audio Mode .....	31
Audio Language .....	31
Favorite Channels .....	31

<b>Setup Menu</b> .....	<b>32</b>
OSD Language .....	32
View Mode .....	24
Automatic .....	24
Stretch .....	24
Side Bar .....	24
Smart stretch .....	24
Zoom .....	24
Blue Mute .....	32
Time Setup .....	32
Time Zone .....	32
Time .....	32
Sleep Timer .....	32
Auto Sleep .....	32
Caption .....	32
Analog Closed Caption .....	32
Digital Closed Caption .....	33
Digital Caption Style .....	33
Location .....	33
Version Info .....	33
Reset .....	33
<b>Parental Menu</b> .....	<b>34</b>
Channel Block .....	34
Program Block .....	34
Rating Enable .....	35
U.S. TV Ratings .....	35
U.S. Movie Ratings .....	36
Canadian English Ratings .....	36
Canadian French Ratings .....	37
Open V-Chip .....	37
Block Unrated .....	37
Input Block .....	37
Change Password .....	37
Clean All .....	37
<b>USB Menu</b> .....	<b>38</b>
Multi-Media .....	38

### NOTE

- Some menu items may not be displayed depending on the selected input source.

# On-Screen Display Menu

---

## For PC Mode

<b>Video Menu .....</b>	<b>28</b>
AV Mode .....	29
Backlight .....	28
Brightness .....	28
Contrast .....	28
Saturation .....	28
Hue .....	28
Color Temperature .....	29
Warm .....	29
Normal .....	29
Cool .....	29
User .....	29
VGA .....	29
<b>Audio Menu .....</b>	<b>30</b>
Balance .....	30
Bass .....	30
Treble .....	30
Sound Surround .....	30
Equalizer .....	30
Speaker .....	30
SPDIF Type .....	30
Auto Volume Control .....	30
<b>Setup Menu .....</b>	<b>32</b>
OSD Language .....	32
View Mode .....	24
Stretch .....	24
Side Bar .....	24
Dot by Dot .....	24
Blue Mute .....	32
Time Setup .....	32
Time Zone .....	32
Time .....	32
Sleep Timer .....	32
Auto Sleep .....	32
Location .....	33
Version Info .....	33
Reset .....	33
<b>Parental Menu .....</b>	<b>34</b>
Program Block .....	34
Rating Enable .....	35
U.S. TV Ratings .....	35
U.S. Movie Ratings .....	36
Canadian English Ratings .....	36
Canadian French Ratings .....	37
Block Unrated .....	37
Input Block .....	37
Change Password .....	37
Clear All .....	37
<b>USB Menu .....</b>	<b>38</b>
Multi-Media .....	38

# On-Screen Display Menu

## On-Screen Display Menu Operation

### Example

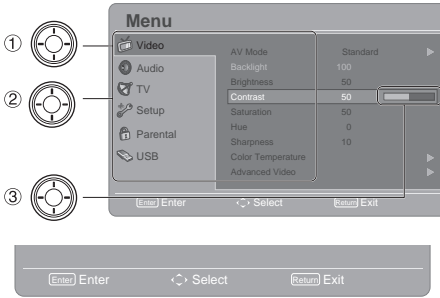

The bar above is an operational guide for the remote control. The bar will change in accordance with each menu setting screen.

- ① Press **◀/▶** to enter the desired item or return to the upper level menu.
- ② Press **▲/▼** to select the desired item.
- ③ Press **◀/▶** to adjust the item.

### Example

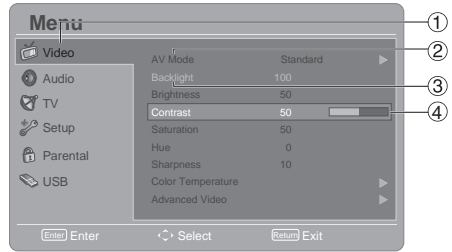

- ① Item displayed in yellow
  - This indicates the item currently selected.
  - Press **▶** to go to the adjustment screen for this item.
- ② Item displayed in blue
  - This indicates that the item can be selected.
- ③ Item displayed in gray
  - This indicates that the item cannot be selected.

There are various reasons why the items cannot be selected, but the main reasons are as follows:

  - Nothing is connected to the selected input terminal.
  - The function is not compatible with the current input signal.
- ④ Item displayed in box
  - This indicates the item currently selected.

### NOTE

- Menu options differ in the selected input modes, but the operating procedures are the same.

## On-Screen Display Menu

### Menu Operation Button

#### Using the remote control

Use the following buttons on the remote control to operate the menu.

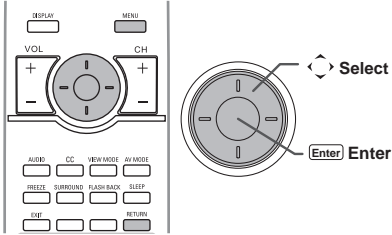

**MENU:** Press to open or close the menu screen.

**▲▼◀▶:** Press to select a desired item on the screen or adjust a selected item.

**Enter:** Press to go to the next step or complete the setting.

**RETURN:** Press to return to the previous step.

#### Using the control panel of the main unit

You can also operate the menu with the control panel of the main unit. Button operations on the control panel correspond to the ones on the remote control as shown below.



**CH ▲/▼:** Cursor ▲/▼ on the remote control.

**VOL +/-:** Cursor ▶/◀ on the remote control.

**MENU:** MENU on the remote control or **EXIT** on the remote control while OSD menu is on.

**INPUT:** Enter on the remote control.

### Video Menu

Adjusts the picture to your preference with the following picture settings.

#### Example

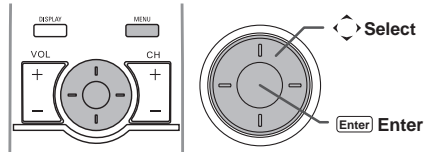
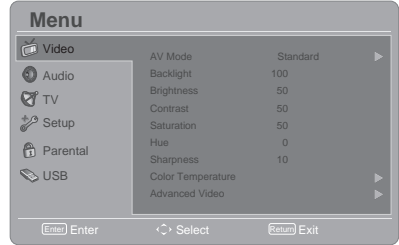

1. Press **MENU** to display the MENU screen, and then press **▲/▼** to select "Video" and press **Enter** or **▶** to enter it.
2. Press **▲/▼** to select a specific adjustment item and press **Enter** or **▶** to enter the setting.
3. Press **◀/▶** to adjust the setting.
4. Press **MENU** to exit.

Selected item	◀ button	▶ button
<b>Backlight</b>	For darker background	For brighter background
<b>Brightness</b>	For less brightness	For more brightness
<b>Contrast</b>	For less contrast	For more contrast
<b>Saturation</b>	For less color intensity	For more color intensity
<b>Hue</b>	Skin tones become reddish	Skin tones become greenish
<b>Sharpness</b>	For less sharpness	For more sharpness

#### NOTE

- Backlight control is disabled when Adaptive Backlight is "On".

## On-Screen Display Menu

### AV Mode

Adjust the best picture appearance from selecting the preset value of **Standard**, **Movie**, **Power Saver**, **User**, or **Sports**.

### Color Temperature

For a better white balance, use color temperature correction.

**Warm:** White with reddish tone

**Normal:**



**Cool:** White with bluish tone

#### • **User:**

White balance can be adjusted manually through the R/G/B Gain between a maximum of +100 and a minimum of -100 for each color temperature.

### Advanced Video

Provide various advanced functions for optimizing the picture quality.

#### **DNR**

DNR (Digital Noise Reduction) enables you to “soften” the screen representation of a weak signal to reduce the noise effect. Select effect degrees from **Low**, **Medium**, **Strong**, **Auto**, or **Off**. The default setting is **Medium**.

#### **MPEG NR**

If the receiving signal of MPEG has a grained noise depending on the compression and conversion, the noise may be reduced when using this function.

#### **Adaptive Luma Control**

Automatically adjusts the brightness and contrast after analyzing the input signal. This function enriches the colors and the depth of the picture.

#### **Flesh Tone**

You can adjust the skin color to be more natural.

### DI Film Mode

Automatically detects a film-based source (originally encoded at 24 frames/seconds), analyzes it then recreates each still film frame for high-definition picture quality.

### Blue Stretch

When Blue Stretch is selected, the brightest part of the screen will be leveled down to reduce the saturation.

### Game Mode

The Game Mode enhances the gaming experience by reducing game controller delay.

### HDMI Mode

HDMI Mode only shows and is available when HDMI device is connected. Select from **Auto**, **Graphic**, or **Video**.

#### NOTE

- **Auto:** The HDMI input timing is set to Video mode or Graphic mode automatically
- **Graphic:** HDMI input timing set to Graphic mode (PC). The image is full scan
- **Video:** HDMI input timing set to Video mode. The image is over scan.
- HDMI Mode is only workable for HDMI Video & Progressive timing as followed: 1920x1080p, 1280x720p, 720x480p, 720x576p.

### Adaptive Backlight

When Adaptive Backlight is activated, it will automatically optimize the backlighting levels for dark scenes.

### VGA

The VGA adjustment is only available when the input source is PC and your TV is receiving a computer signal. Select **Auto Adjust** for adjusting the settings automatically, or select **H. Position**, **V. Position**, **Phase** or **Clock** and use ◀ or ▶ to adjust your preference.

## On-Screen Display Menu

### Audio Menu

Adjusts the sound quality to your preference with the following settings.

#### Example

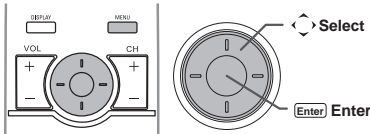
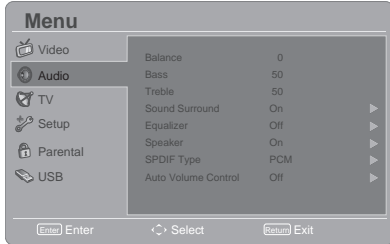

1. Press **MENU** to display the MENU screen, and then press **▲/▼** to select "Audio" and press **Enter** or **▶** to enter it.
2. Press **▲/▼** to select a specific adjustment item and press **Enter** or **▶** to set.
3. Press **◀/▶** to adjust the desired setting.
4. Press **MENU** to exit.

Selected item	◀ button	▶ button
<b>Balance</b>	Decrease audio from the right speaker	Decrease audio from the left speaker
<b>Bass</b>	For weaker bass	For stronger bass
<b>Treble</b>	For weaker treble	For stronger treble

### Sound Surround

The surround function produces Surround effect from the speakers.

**On:** Makes it possible to enjoy natural, realistic surround sound.

**Off:** Outputs the normal sound.

- You can choose Surround by pressing **SURROUND** on the remote control unit. (See page 22.)

### Equalizer

Select the preset audio mode from **Off**, Rock, Pop, Live, Dance, Techno, Classic, or Soft.

### Speaker

Choose to turn on or off the TV internal speaker. The audio output signals will not be turned off even though the TV speaker is off. The default setting is On.

### SPDIF Type

Select the type of digital audio output. The default setting is **PCM**.

- **Off:** Disables digital audio output.
- **PCM:** Outputs audio to PCM type.
- **Dolby Digital:** Outputs audio to Dolby Digital type if the source supports Dolby digital audio.

#### NOTE

- **SPDIF Type** is disabled when HDMI is selected from the input source.

### Auto Volume Control

Choose On or Off to adjust volume to be consistent across programs and channels automatically.

## On-Screen Display Menu

### TV Menu

#### Example

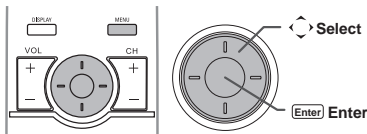
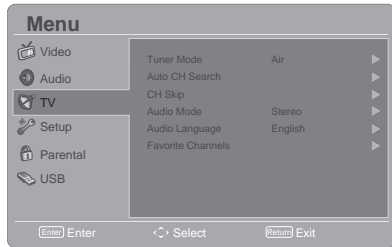

1. Press **MENU** to display the MENU screen, and then press **▲/▼** to select "TV" and press **Enter** or **▶** to enter it.
2. Press **▲/▼** to select a specific item and press **Enter** or **▶** to set the item.
3. Press **MENU** to exit.

### Tuner Mode

Select TV source signal from the Air (antenna) or Cable (CATV).

### Auto CH Search

If initial setup does not memorize all the channels, follow the instructions below to manually memorize the channels.

**Air/Cable:** Make sure what kind of connection is made with your TV when selecting Air/Cable.

- When Air is selected, the TV detects antenna signals. It searches for NTSC, ATSC, and QAM modulated channels available in your area.
- When Cable is selected, the TV detects signals supplied by cable. It searches for NTSC, ATSC, and QAM modulated channels available in your area.

### CH Skip

To prevent certain programs from being viewed by pressing **CH +/-** buttons on the remote control, the selected channel can be skipped.

#### NOTE

- The skipped channel may not be found by pressing **CH +/-** buttons but can be access by pressing number buttons directly.

### Audio Mode

Select the audio mode from **Stereo**, **SAP**, or **Mono**.

### Audio Language

Gives you the possibility to swap between main and alternative language, when it is available in digital channel.

### Favorite Channels

This function allows you to program 4 favorite channels, in 4 different categories. By setting the favorite channels in advance, you can select your favorite channels easily.

#### To register your favorite channel:

1. Press **MENU** on the remote control and select "**TV**"/"**Favorite channels**".
2. Press **▲/▼** to select the category that you want to store your favorite channel.
3. Press **▲/▼** to select your desired channel and press **Enter** button to confirm.

#### To delete your favorite channel:

1. Press **MENU** on the remote control and select "**TV**"/"**Favorite channels**".
2. Press **▲/▼** to select "**All data clear**" and press **Enter** to start clearing all favorite channel data.

#### NOTE

- While watching, you can toggle the selected channels by pressing the **A**, **B**, **C**, and **D** button on the remote control.

## On-Screen Display Menu

### Setup Menu

#### Example

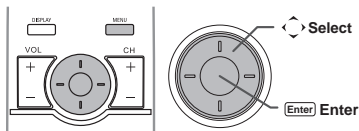
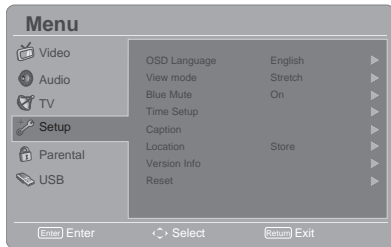

1. Press **MENU** to display the MENU screen, and then press **▲/▼** to select "Setup" and press **Enter** or **▶** to enter it.
2. Press **▲/▼** to select a specific item and press **Enter** or **▶** to set the item.
3. Press **MENU** to exit.

#### OSD Language

Select the OSD menu display language. (English/Français/Español)

#### View mode

Change the format of the picture. (See page 24.)

#### Blue Mute

When Blue Mute is selected, the screen will turn blue and the sound will be muted when no signal is received.

#### Time Setup

Set current time.

#### Time Zone

Set your current location for time zone.

#### Time

- Set Auto Synchronization to On to set the time automatically, or turn the Auto Synchronization off to set the time manually.
- Set the Date and Time manually.
- Timer: Set the timer to switch the TV on/off automatically at a preset time.

#### Sleep Timer

Allows you to set a time when the TV automatically switches to standby. (See page 21.)

#### Auto Sleep

Set the TV to put itself to sleep after it has not been used for 1, 2, or 5 hours.

#### Caption

#### Analog Closed Caption

This allows you to select the Closed Captions service levels of analog broadcasting to be displayed.

Closed captioning allows you to read the voice content of television programs on the TV screen. Designed to help the hearing impaired, this feature uses on-screen "text boxes" to show dialogues and conversations while the TV program is in progress. Captions will appear on the screen during captioned broadcasts.

- **CC1, 2, 3, or 4**

Dialogues (and descriptions) for the action on the captioned TV program shows on screen. Usually CC1 is the most used. CC2 can be used for alternate languages if they are being transmitted.

- **TEXT1, 2, 3, or 4**

Often used for channel guide, schedules, bulletin board information for Closed captions programs, news, weather information, or stock market reports. Not all Caption services are necessarily being used by a TV channel during the transmission of a Closed Caption program.



## On-Screen Display Menu

### Digital Closed Caption

This allows you to configure the way you choose to view digital captioning. Select one of the digital service channels made available by the caption provider. There are six standard services. Service 1 is designated as the Primary Caption Service. This service contains the verbatim, or near-verbatim captions for the primary language being spoken in the accompanying program audio. Service 2 is designated as the Secondary Language Service. This service contains captions in a secondary language, which is a translation of the captions in the primary Caption Service. The other service sub channels are not pre-assigned. It is up to the discretion of the individual caption provider to utilize the remaining service channels.

### Digital Caption Style

This allows you to modify how digital captions are displayed on your TV. Select from the following options to change the visual characteristics of the TV's digital captioning

- **Caption Style:**  
Set to As Broadcaster or Custom mode. If Custom mode is selected, user can modify the detail styles described below. The setting result will be shown immediately on the bottom of the submenu OSD.  
Note: This feature is only available in Digital TV (ATSC) mode.
- **Font Size:**  
Selects this option to choose a caption display size according to your own preference. Select "**Small**", "**Medium**", or "**Large**".
- **Font Style:** Select digital closed caption font style.
- **Font Color:** Choose the caption display text color.
- **Font Opacity:** Select the text opacity.

- **Background Color:** Choose caption display character background color.
- **Background Opacity:** Choose one of the background opacity options.
- **Window Color:** Choose one of the display windows color.
- **Window Opacity:** Select one of the display windows color.

### Location

Select from Store or Home mode. Store mode is recommended for displaying in a retail showroom, and Home mode is recommended for normal home use for Energy Saving.

### Version Info

Display the Software information.

### Reset

Restore all the default Setup settings.

## On-Screen Display Menu

### Parental Menu

Before entering the Parental Control sub-menu, user has to key in the password first. After entering the parental sub-menu, the user can modify the restricted table. While exiting the sub-menu, the parental control function is activated.

Enter a 4-digit password with the number buttons on the remote control.

#### NOTE

- The default password is 0000.

#### Example

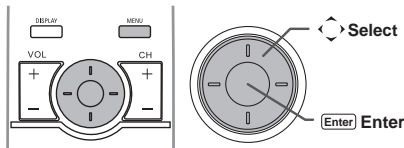

1. Press **MENU** to display the MENU screen, and then press **▲/▼** to select “Parental” and press **Enter** or **▶** to enter it.
2. Enter the master password “0000”.
3. Press **▲/▼** to select a specific item and press **Enter** or **▶** to select the item.
4. Press **MENU** to exit.

### Channel Block

This function prevents children from watching certain channels.

#### NOTE

- Restart the TV for the change to take effect.
- If you access the blocked channels from the number buttons on the remote control, a screen prompting you to enter your current password appears.

### Program Block

Your TV is equipped with a V-chip that allows you to control access to individual programs based on their age rating and content rating. The program content advisory data are sent by the broadcaster or by the program provider

Block certain programs to prevent children from watching.

## On-Screen Display Menu

---

### Rating Enable

Set the Enable Rating to On to activate the program rating system.

### U.S. TV Ratings

If you are receiving channels through a set-top box or cable receiver box connected by HDMI, you cannot use the TV ratings lock. Your set-top box or cable receiver box must be connected through RF or AV connectors.

Age rating	Content rating
<b>NONE</b>	None
<b>TV-Y</b> Appropriate for children of all ages with themes and elements suitable for children aged 2-6.	None
<b>TV-Y7</b> Programs designed for children age 7 and older.	Fantasy Violence (FV)
<b>TV-G</b> Programs suitable for all ages. These programs contain little or no violence, no strong language and little or no sexual dialog or situations.	None
<b>TV-PG</b> Programs contain elements that some parents may find unsuitable for younger children and which may need parental guidance. The program may contain moderate violence, sexual dialog and/or situations and some strong language.	Dialog (D) Language (L) Sex (S) Violence (V)
<b>TV-14</b> Programs contain elements that may not be suitable for children under 14 years of age. These programs include one or more of the following: intense violence, intense sexual situations, suggestive dialog and strong language.	Dialog (D) Language (L) Sex (S) Violence (V)
<b>TV-MA</b> Programs are designed to be viewed by adults and may be unsuitable for children under the age of 17. These programs may contain graphical violence, explicit sexual activity and/ or crude or indecent language.	Language (L) Sex (S) Violence (V)

## On-Screen Display Menu

### U.S. Movie Ratings

This section describes how to control viewing of movies based on their Motion Picture Association of America (MPAA) rating.

Movie rating	Description
<b>NONE</b>	Clear all the checked ratings. All ages admitted.
<b>G</b>	General audiences. All ages admitted.
<b>PG</b>	Parental guidance suggested. Some material may not be suitable for children.
<b>PG-13</b>	Parents strongly cautioned. Some material may be inappropriate for children under 13.
<b>R</b>	Restricted. Under 17 requires accompanying parent or adult guardian (age varies in some jurisdictions).
<b>NC-17</b>	No one 17 and under admitted.
<b>X</b>	X is an older rating that is unified with NC-17 but may be encoded in the data of older movies.

### Canadian Rating Systems (Canadian English ratings and Canadian French ratings).

- The TV rating systems in Canada are based on the Canadian Radio-Television and Telecommunications Commission (CRTC) policy on violence in television programming.
- While violence is the most important content element to be rated, the structure developed takes into consideration other program content, like language, nudity, sexuality and mature themes.
- When setting the V-CHIP on the Canadian system, you can choose either the Canadian English ratings or the Canadian French ratings.

### Canadian English Ratings

Movie rating	Description
<b>E</b>	Exempt: Includes news, sports, documentaries and other information programming; talk shows, music videos, and variety programming.
<b>C</b>	Children: Intended for younger children under the age of 8 years. Pays careful attention to themes that could threaten their sense of security and well being.
<b>C8+</b>	Children over 8 years old: Contains no portrayal of violence as the preferred, acceptable, or only way to resolve conflict; nor encourage children to imitate dangerous acts which they may see on the screen.
<b>G</b>	General: Considered acceptable for all age groups. Appropriate viewing for the entire family, contains very little violence, physical, verbal or emotional.
<b>PG</b>	Parental Guidance: Intended for a general audience, but may not be suitable for younger children (under the age of 8) because it could contain controversial themes or issues.

## On-Screen Display Menu

Movie rating	Description
<b>14+</b>	Over 14 years: Could contain themes where violence is one of the dominant elements of the storyline, but it must be integral to the development of plot or character. Language usage could be profane and nudity present within the context of the theme.
<b>18+</b>	Adults: Intended for viewers 18 years and older and might contain depictions of violence, which while related to the development of plot, character or themes, are intended for adult viewing. Could contain graphic language and portrayals of sex and nudity.

## Canadian French Ratings

Movie rating	Description
<b>E</b>	Exempt programming.
<b>G</b>	General: All ages and children, contains minimal direct violence, but may be integrated into the plot in a humorous or unrealistic manner.
<b>8 ans+</b>	General but inadvisable for young children: May be viewed by a wide public audience, but could contain scenes disturbing to children under 8 who cannot distinguish between imaginary and real situations. Recommended for viewing with parent.
<b>13 ans+</b>	Over 13 years: Could contain frequent violent scenes and therefore recommended for viewing with parent.
<b>16 ans+</b>	Over 16 years: Could contain frequent violent scenes and intense violence.
<b>18 ans+</b>	Over 18 years: Only for adult viewing. Could contain frequent violent scenes and extreme violence.

## Open V-Chip

The inhibitive channels or source signals can be unlock.

## Block Unrated

When Block Unrated is set to on, the channel can be selected using the **CH+/-** and the number buttons.

### Input Block

Disable the specific external input signals.

### Change Password

1. Enter a 4-digit New Password with the number buttons on the remote control.  
If you lost your password, enter master code 0000.
2. Enter your new 4-digit password again to confirm.

### Clean All

Clean all the parental blocks to default settings.

# On-Screen Display Menu

## USB Menu

### Example

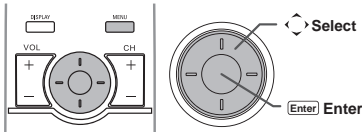
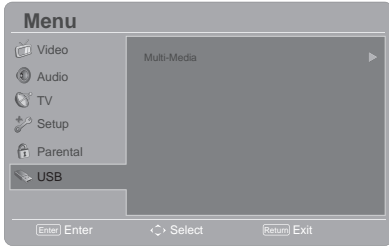

1. Press **MENU** to display the MENU screen, and then press **▲/▼** to select "USB" and press **Enter** or **▶** to enter it.
2. Press **▲/▼** to select "**Multi-Media**" and press **Enter** or **▶** to set the item.
3. To exit the USB menu, press **INPUT** to select other sources.

### NOTE

- You can also press **INPUT** to select USB from the input list.
- Some of the USB storage devices may not be supported to this function.
- USB storage device compatibility:
  - Photo file format: jpg, jpeg, png, bmp.
  - Music file format: mp3.

## Multi-Media

This TV is fitted with a USB connector that enables you to view photos and play music that stored on a USB storage device.

### Browse the file folder

1. Press **MENU** on the remote control and select "**USB**"/"**Multi-Media**". The USB thumbnail browser appears.



2. Press **MENU** to display the sub-menu. You can browse the files by the following options.
  - Sort
  - Media type
  - Thumbnail Size

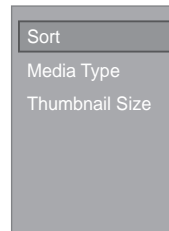

### NOTE

- You can also use the short keys on the remote control and follow the on-screen instructions to operate.
  - **Color Keys:** RED: media type, GREEN: Size, YELLOW: Sort.
  - **CH +/-:** Page up/down.
  - **▲/▼/◀/▶:** For normal moving.

## On-Screen Display Menu

### View Photos

1. In the photo thumbnail browser, press **▲/▼/◀/▶** to select a photo or a photo album.
2. Press **Enter** to view a full screen image. The slide show begins.
3. When the slide show begins, use the **color buttons** on the remote control and follow the on-screen instructions to view photos.

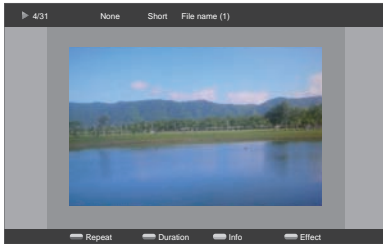

4. Press **MENU** to display the sub-menu. You can select the following options to display the photos.
  - Pause
  - Repeat
  - Shuffle
  - Duration
  - Effect
  - Show Info

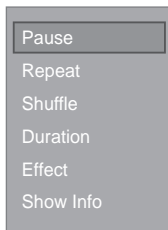

5. Press **EXIT** or **RETURN** key to return to the previous page or exit the option menu.

### NOTE

- You can also use the short keys on the remote control and follow the on-screen instructions to operate.
  - **Enter**: Play/Pause.
  - **Color Keys**: RED: Repeat, GREEN: Duration, BLUE: Info, YELLOW: Effect.
  - **CH +/-**: Go to the next/previous photo.
  - **DISPLAY**: Display the information.
  - When slide show is paused: GREEN: Rotate the photo.

### Play Audio

1. In the file thumbnail browser, press **▲/▼/◀/▶** to select a music file.
2. Press **Enter** to play the music file.
3. While the music is playing, use the **color buttons** on the remote control and follow the on-screen instructions to operate.
4. Press **MENU** to display the sub-menu and select the following options to operate.
  - Pause
  - Stop
  - Repeat
  - Shuffle Off
  - Show Info
  - Show Spectrum
  - Audio Only

### NOTE

- You can also use the short keys on the remote control to operate.
  - **Enter**: Play/Pause.
  - **Color Keys**: RED: Repeat, GREEN: Shuffle, BLUE: Info, YELLOW: Audio only.
  - **CH +/-**: Next/Previous track.
  - **DISPLAY**: Info.
  - **◀/▶**: Forward/Backward seek.

# Appendix

## Troubleshooting

Problem	Possible Solution
<ul style="list-style-type: none"> <li>No power</li> </ul>	<ul style="list-style-type: none"> <li>Check if you pressed <b>POWER</b> on the remote control unit. (See page 19.) If the indicator on the TV does not light up, press <b>POWER</b> on the TV.</li> <li>Is the AC cord disconnected? (See page 10.)</li> <li>Has the power been turned on? (See page 19.)</li> </ul>
<ul style="list-style-type: none"> <li>Unit cannot be operated.</li> </ul>	<ul style="list-style-type: none"> <li>External influences such as lightning, static electricity, may cause improper operation. In this case, operate the unit after first turning off the power of the TV or unplugging the AC cord and re-plugging it after 1 or 2 minutes.</li> </ul>
<ul style="list-style-type: none"> <li>Remote control unit does not operate.</li> </ul>	<ul style="list-style-type: none"> <li>Is the <b>SOURCE</b> set correctly? Set it to the TV setting position.</li> <li>Are batteries inserted with polarity (+, -) aligned? (See page 13.)</li> <li>Are batteries worn out? (Replace with new batteries.)</li> <li>Are you using it under strong or fluorescent lighting?</li> <li>Is a fluorescent light illuminated near the remote control sensor?</li> </ul>
<ul style="list-style-type: none"> <li>Picture is cut off/with sidebar screen.</li> </ul>	<ul style="list-style-type: none"> <li>Are screen mode adjustments such as picture size made correctly? (See page 24.)</li> </ul>
<ul style="list-style-type: none"> <li>Strange color, light color, or color misalignment</li> </ul>	<ul style="list-style-type: none"> <li>Adjust the picture tone. (See page 28.)</li> <li>Is the room too bright? The picture may look dark in a room that is too bright.</li> </ul>
<ul style="list-style-type: none"> <li>Power is suddenly turned off.</li> </ul>	<ul style="list-style-type: none"> <li>Is the sleep timer set? (See page 21.)</li> <li>The unit's internal temperature has increased. Remove any objects blocking vent.</li> </ul>
<ul style="list-style-type: none"> <li>No picture</li> </ul>	<ul style="list-style-type: none"> <li>Is connection to other components correct? (See page 17.)</li> <li>Is the correct input selected? (See page 21.)</li> <li>Is picture adjustment correct? (See page 28.)</li> </ul>
<ul style="list-style-type: none"> <li>No sound</li> </ul>	<ul style="list-style-type: none"> <li>Is the volume too low? (See page 21.)</li> <li>Have you pressed <b>MUTE</b> on the remote control unit? (See page 21.)</li> </ul>
<ul style="list-style-type: none"> <li>The TV sometimes makes a cracking sound.</li> </ul>	<ul style="list-style-type: none"> <li>This is not a malfunction. This happens when the cabinet slightly expands and contracts according to change in temperature. This does not affect the TV's performance.</li> </ul>

### Cautions regarding use in high and low temperature environments

- When the unit is used in a low temperature space (e.g. room, office), the picture may leave trails or appear slightly delayed. This is not a malfunction, and the unit will recover when the temperature returns to normal.
- Do not leave the unit in a hot or cold location. Also, do not leave the unit in a location exposed to direct sunlight or near a heater, as this may cause the cabinet to deform and the Liquid Crystal panel to malfunction.  
Storage temperature: -4°F to +140°F (-20°C to +60°C)



## Appendix

### Specifications

Item		LC-32SB28UT-A	LC-42SB48UT-A
LCD screen size		32" Class (31 1/2" Diagonal) Active Matrix (a-Si TFT LCD)	42" Class (42 1/50" Diagonal) Active Matrix (a-Si TFT LCD)
Resolution		1,049,088 pixels (1,366 x 768)	2,073,600 pixels (1,920 x 1080)
TV Function	Receiving System		American TV Standard ATSC/NTSC System
	Receiving Channel	VHF/UHF	VHF 2-13ch, UHF 14-69ch
		CATV	1-125ch (non-scrambled channel only)
		Digital Terrestrial Broadcast (8VSB)	2-69ch
		Digital cable*1 (64/256 QAM)	1-135ch (non-scrambled channel only)
Audio multiplex		BTSC System	
Audio out		5W x 5W	5W x 5W
Terminals	Rear	ANT/CABLE	75 $\Omega$ Unbalance, F Type x 1 for Analog (VHF/UHF/CATV) and Digital (AIR/ CABLE)
		INPUT 2	COMPONENT in, AUDIO in
		INPUT 3	COMPONENT in, AUDIO in
		INPUT 4	15-pin mini D-sub female connector, Audio in ( $\varnothing$ 3.5mm jack)
		INPUT 5	HDMI in with HDCP, Audio in ( $\varnothing$ 3.5mm jack)
		INPUT 6	HDMI in with HDCP, Audio in ( $\varnothing$ 3.5mm jack)
		INPUT 7	HDMI in with HDCP, Audio in ( $\varnothing$ 3.5mm jack)
		OUTPUT	RCA (L/R) jack / Digital Audio output
	RS-232C	D-sub 9 pin for service & Hotel mode using	
	Side	INPUT 1	AV in, AUDIO in
		USB	Multi-Media use, Software update
Earphone Output		$\varnothing$ 3.5mm jack (Audio output)	
INPUT 8		HDMI in with HDCP, Audio in ( $\varnothing$ 3.5mm jack)	
OSD language		English/French/Spanish	
Power Requirement		120V @ 60Hz	
Power Consumption		85 W ( $<$ 0.3 W Standby with AC 120 V)	185 W ( $<$ 0.3 W Standby with AC 120 V)
Weight	TV + stand	23.71 lbs. /10.755 kg	40.03 lbs. /18.16 kg
	TV only	20.4 lbs. /9.255 kg	34.83 lbs. /15.8 kg
Dimension <sup>*2</sup> (W / H / D)	TV + stand	31 <sup>1</sup> / <sub>8</sub> x 22 <sup>7</sup> / <sub>16</sub> x 9 <sup>7</sup> / <sub>16</sub> (inch)	39 <sup>31</sup> / <sub>32</sub> x 27 <sup>11</sup> / <sub>16</sub> x 10 <sup>5</sup> / <sub>8</sub> (inch)
	TV only	31 <sup>1</sup> / <sub>8</sub> x 20 <sup>3</sup> / <sub>4</sub> x 3 <sup>9</sup> / <sub>16</sub> (inch)	39 <sup>31</sup> / <sub>32</sub> x 25 <sup>25</sup> / <sub>32</sub> x 3 <sup>13</sup> / <sub>16</sub> (inch)
Operating temperature		32°F to + 95°F (0°C to + 35°C)	

\*1 Emergency alert messages via Cable are unreceivable.

\*2 The dimensional drawings are shown on the inside back cover.

- As part of policy of continuous improvement, SHARP reserves the right to make design and specification changes for product improvement without prior notice. The performance specification figures indicated are nominal values of production units. There may be some deviations from these values in individual units.

## Appendix

### PC Compatibility Chart

It is necessary to set the PC correctly to display XGA and WXGA signal. Refer to page 17-18 to set PC input signals.

PC	Resolution		Horizontal Frequency	Vertical Frequency	VESA Standard
PC	VGA	720 x 400	31.469 kHz	70.087 Hz	—
		640 x 480	31.469 kHz	59.940 Hz	O
			37.861 kHz	72.809 Hz	O
			37.500 kHz	75.000 Hz	O
	SVGA	800 x 600	35.156 kHz	56.250 Hz	O
			37.879 kHz	60.317 Hz	O
			48.077 kHz	72.188 Hz	O
			46.875 kHz	75.000 Hz	O
	XGA	1024 x 768	48.363 kHz	60.004 Hz	O
			56.476 kHz	70.069 Hz	O
			60.023 kHz	75.029 Hz	O
	WXGA	1280 x 768	47.396 kHz	59.995 Hz	O
SXGA	1280 x 1024	63.981 kHz	60.020 Hz	O	
WXGA	1360 x 768	47.712 kHz	60.015 Hz	O	
HDMI	Resolution		Horizontal Frequency	Vertical Frequency	Pixel Clock Frequency
HDMI	VGA	640 x 480	31.469 kHz	60.000 Hz	25.175 MHz
	SVGA	800 x 600	37.879 kHz	60.000 Hz	40.000 MHz
	XGA	1024 x 768	48.363 kHz	60.000 Hz	65.000 MHz
	WXGA	1280 x 768	47.712 kHz	60.000 Hz	85.500 MHz
	1080P	1920 x 1080P	67.500 kHz	60.000 Hz	148.500 MHz
	720P	1280 x 720P	45.000 kHz	60.000 Hz	74.250 MHz
	1080i	1920 x 1080i	33.750 kHz	60.000 Hz	74.250 MHz
	480P	720 x 480P	31.500 kHz	60.000 Hz	27.030 MHz
	480i	720 x 480i	15.750 kHz	60.000 Hz	13.510 MHz
Component	Resolution		Horizontal Frequency	Vertical Frequency	Pixel Clock Frequency
Component	720P	1280 x 720P	45.000 kHz	60.000 Hz	74.250 MHz
	1080i	1920 x 1080i	33.750 kHz	60.000 Hz	74.250 MHz
	480P	720 x 480P	31.500 kHz	60.000 Hz	27.030 MHz
	480i	720 x 480i	15.750 kHz	60.000 Hz	13.510 MHz

DDC is a registered trademark of Video Electronics Standards Association.

# Appendix

## RS232 Port Specifications

### ■ PC control of the TV

- Attach an RS-232C cable cross-type (commercially available) to the supplied Din/D-Sub RS-232C for the connections.

#### NOTE

- This operation system should be used by a person who is accustomed to using computers.

### ■ Communication conditions

Set the RS-232C communication settings on the PC to match the TV's communication conditions. The TV's communication settings are as follows:

<b>Baud rate:</b>	9,600 bps
<b>Data length:</b>	8 bits
<b>Parity bit:</b>	None
<b>Stop bit:</b>	1 bit
<b>Flow control:</b>	None

### ■ Communication procedure

Send the control commands from the PC via the RS-232C connector.

The TV operates according to the received command and sends a response message to the PC. Do not send multiple commands at the same time. Wait until the PC receives the OK response before sending the next command.

### ■ Command table

- Commands not indicated here are not guaranteed to operate.

CONTROL ITEM	COMMAND	PARAMETER	CONTROL CONTENTS
POWER ON COMMAND SETTING	R : S : P : W	0 : : : : Off 1 : : : : On	The Power On command rejected. The Power On command accepted. It shifts to standby.
POWER SETTING	P : O : W : R	0 : : : : Power Off 1 : : : : Power On	Power On
INPUT SELECTION A	T O G G L E	I : T : G : D : x : : : : (Toggle)	It input-switches by the toggle. (It is the same as an input change key)
TV	I : T : V : D	0 : : : : Input-switches to TV. (A channel remains as it is. (Last memory))	
INPUT1-8	I : A : V : D	* : : : : Input terminal number (1-8)	It input-switches to INPUT1-INPUT8.
AV MODE SELECTION	A : V : M : D	* : : : : 0: (Toggle), 1: STANDARD, 2: MOVIE, 3: GAME, 4: USER, 5: DYNAMIC (fixed), 6: DYNAMIC, 7: PC, 100: AUTO	Although it can choose now, it is toggle operation in inside.
VOLUME	V : O : L : M	* : * : : : Volume (0-60)	
POSITION	H-POSITION V-POSITION CLOCK PHASE	H : P : O : S : * : * : * : V : P : O : S : * : * : * : C : L : C : K : * : * : * : P : H : S : E : * : * : * :	The screen position variable ranges depend on the View Mode or the signal type. The ranges can be seen on the position-setting screen. Only PC mode. (0-180) Only PC mode. (0-40)
VIEW MODE	W : I : D : E	* : * : * : : 0: (Toggle) [AV], 1: Side Bar [AV], 2: S.Stretch [AV] 3: Zoom [AV], 4: Stretch [AV], 5: Normal [PC] 6: Zoom [PC], 7: Stretch [PC], 8: Dot by Dot [PC] [AV], 9: Full Screen [AV]	0: Although it can choose now, it is toggle operation in inside. 1: Only available when 4-3 signal is being input. 5, 6: Only available when 4-3 signal is being input. 8: [PC] Available except when UKGA is being input. [AV] Only available when 1080i/p is being input. 9: Only available when 720p is being input.
MUTE	M : U : T : E	* : : : : 0: (Toggle), 1: On, 2: Off	
SURROUND	A : C : S : U	* : : : : 0: (Toggle), 1: On, 2: Off	
AUDIO SELECTION	A : C : H : A	x : : : : (Toggle)	
SLEEP TIMER	O : F : T : M	* : * : * : : 0: Off, 1: OFF TIMER - 30 MIN., 2: OFF TIMER - 60 MIN., 3: OFF TIMER - 90 MIN., 4: OFF TIMER - 120 MIN.	
CHANNEL	DIRECT CHANNEL (ANALOG)	D : C : C : H : * : * : * : : The channel number of TV (1-135)	An input change is included if it is not TV display. In Air, 2-69ch is effective. In Cable, 1-135ch is effective.
DIRECT CHANNEL (DIGITAL)	D : A : 2 : P D : C : 2 : U D : C : 2 : L D : C : 1 : 0 D : C : 1 : 1	* : * : * : * : (0100-9999) * : * : * : * : (1-999) * : * : * : * : (0-999) * : * : * : * : (0-9999) * : * : * : * : (0-6383)	DIGITAL Air (Two-Part numbers, 2-digit plus 2-digit) DIGITAL Cable (Two-Part numbers, 3-digit plus 3-digit) Front half of DIGITAL CABLE CHANNEL_NO. (Designate major channel) DIGITAL Cable (Two-Part numbers, 3-digit plus 3-digit) Rear half of DIGITAL CABLE CHANNEL_NO. (Designate minor channel) DIGITAL Cable (One-Part numbers, 5-digit, less than 10,000) DIGITAL Cable (One-Part numbers, 5-digit, more than 10,000)
CH UP	C : H : U : P	x : : : : The channel number of TV +1	If it is not TV display, it will input-switch to TV. (same function as CH +)
CH DOWN	C : H : D : W	x : : : : The channel number of TV -1	If it is not TV display, it will input-switch to TV. (same function as CH -)
CC	C : L : C : P	x : : : : (Toggle)	Toggle operation of a closed caption.

#### NOTE

- If an underbar ( ) appears in the parameter column, enter a space.
- If an asterisk (\*) appears, enter a value in the range indicated in brackets under CONTROL CONTENTS.
- Any numerical value can replace the "x" on the table.

### ■ Command format

Eight ASCII codes + CR

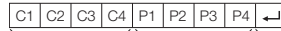

Command 4-digits      Parameter 4-digits      Return code

Command 4-digits: Command. The text of four characters.  
Parameter 4-digits: Parameter 0-9, x, blank, ?

### ■ Parameter

Input the parameter values, aligning left, and fill with blank(s) for the remainder. (Be sure that 4 values are input for the parameter.)

When the input parameter is not within an adjustable range, "ERR" returns. (Refer to "Response code format".) Any numerical value can replace the "x" on the table.

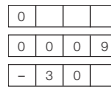

When "?" is input for some commands, the present setting value responds.

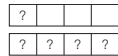

### ■ Response code format

Normal response



Return code (ODH)

Problem response (communication error or incorrect command)



Return code (ODH)

### Information on the Software License for This Product

#### ■ Software composition

The software included in this product is comprised of various software components whose individual copyrights are held by SHARP or by third parties.

#### ■ Software developed by SHARP and open source software

The copyrights for the software components and various relevant documents included with this product that were developed or written by SHARP are owned by SHARP and are protected by the Copyright Act, international treaties, and other relevant laws. This product also makes use of freely distributed software and software components whose copyrights are held by third parties. These include software components covered by a GNU General Public License (hereafter GPL), a GNU Lesser General Public License (hereafter LGPL) or other license agreement.

#### ■ Obtaining source code

Some of the open source software licensors require the distributor to provide the source code with the executable software components. GPL and LGPL include similar requirements. For information on obtaining the source code for the open source software and for obtaining the GPL, LGPL, and other license agreement information, visit the following website:

<http://www.sharpusa.com/gpl>

We are unable to answer any questions about the source code for the open source software. The source code for the software components whose copyrights are held by SHARP is not distributed.

#### ■ Acknowledgements

The following open source software components are included in this product:

- linux kernel/busybox/uClibc/zlib/libpng/libjpeg

### CLEARING THE SECRET NUMBER

If you forget the secret number, clear the secret number using the following procedure.

1. Press **MENU** to display the MENU screen, and then press **▲/▼** to select "Parental" and press **▶** to enter it.
2. Press 0000 as a master code, and then press **▲/▼** to select "Change Password" and press **▶** to enter it.
3. Enter a new PIN. (See page 37.)

The secret number is 

--	--	--	--

 .

#### NOTE

- As a precautionary measure, make a note of your secret number above, cut it from this manual, and keep it in a safe place.

## Appendix

### Legal notices

#### ■ FCC Part 15

This device complies with Part 15 of the FCC Rules. Operation of this product is subject to the following two conditions: (1) this device may not cause harmful interference, and (2) this device must accept any interference received, including interference that may cause undesired operation.

This equipment has been tested and found to comply within the limits for a class B digital device, pursuant to Part 15 of the FCC Rules. These limits are designed to provide reasonable protection against harmful interference in a residential installation. This equipment generates, uses, and can radiate radio frequency energy and, if not installed and used in accordance with the instructions, may cause harmful interference to radio communications. However, there is no guarantee that interference will not occur in a particular installation. If this equipment does cause harmful interference to radio or television reception, which can be determined by turning the equipment off and on, the user is encouraged to try to correct the interference by one or more of the following measures:

- Reorient or relocate the receiving antenna.
- Increase the separation between the equipment and receiver.
- Connect the equipment into an outlet on a circuit different from that to which the receiver is connected.
- Consult the dealer or an experienced radio/TV technician for help.

#### ■ FCC warning

Changes or modifications not expressly approved by the party responsible for compliance with the FCC Rules could void the user's authority to operate this equipment.

#### ■ Cables

Connections to this device must be made with shielded cables with metallic RF/EMI connector hoods to maintain compliance with FCC Rules and Regulations.

#### ■ Canadian notice

This Class B digital apparatus complies with Canadian ICES-003.

Cet appareil numérique de la classe B est conforme à la norme NMB-003 du Canada.  
"Standard Television Receiving Apparatus-Appareil de réception télévision ordinaire, Canada BETS-7 / NTMR-7".

#### ■ DOLBY



Manufactured under license from Dolby Laboratories. "Dolby" and the double-D symbol are trademarks of Dolby Laboratories.

#### ■ HDMI



HDMI, the HDMI logo, and High-Definition Multimedia Interface are trademarks or registered trademarks of HDMI Licensing LLC in the United States and other countries.

# Calling for Service

For location of the nearest Sharp Authorized Service, or to obtain product literature, accessories, supplies, or customer assistance, please call 1-800-BE-SHARP.

## LIMITED WARRANTY

### CONSUMER LIMITED WARRANTY

SHARP ELECTRONICS CORPORATION warrants to the first consumer purchaser that this Sharp brand Liquid Crystal Display product (the "Product"), when shipped in its original container, will be free from defective workmanship and materials, and agrees that it will, at its option, either repair the defect or replace the defective Product or part thereof with a new or remanufactured equivalent at no charge to the purchaser for parts or labor for the period(s) set forth below.

This warranty does not apply to any appearance items of the Product or if the serial number or model number affixed to the Product has been removed, defaced, changed, altered or tampered with. This warranty does not cover installation or signal reception problems. This limited warranty will not apply if the Product has been or is being used in a commercial setting or application; this warranty is meant solely for the non-commercial, household use of the Product by consumers in their home or residence. If you intend to or already use this Product for commercial purposes or in a commercial setting, there are warranties available to cover your use of this Product, the terms of which may vary. Please contact **1-888-GO-SHARP** for further information.

In order to enforce your rights under this limited warranty, you should follow the steps set forth below. You must be able to provide proof of purchase to the servicer, which proof must include the date of purchase.

To the extent permitted by applicable state law, the warranties set forth are in lieu of, and exclusive of, all other warranties, express or implied. Specifically ALL OTHER WARRANTIES OTHER THAN THOSE SET FORTH ABOVE ARE EXCLUDED, ALL EXPRESS AND IMPLIED WARRANTIES INCLUDING THE WARRANTIES OF MERCHANTABILITY, FITNESS FOR USE, AND FITNESS FOR A PARTICULAR PURPOSE ARE SPECIFICALLY EXCLUDED. IF, UNDER APPLICABLE STATE LAW, IMPLIED WARRANTIES MAY NOT VALIDLY BE DISCLAIMED OR EXCLUDED, THE DURATION OF SUCH IMPLIED WARRANTIES IS LIMITED TO THE PERIOD(S) FROM THE DATE OF PURCHASE SET FORTH BELOW. THIS WARRANTY GIVES YOU SPECIFIC LEGAL RIGHTS. YOU MAY ALSO HAVE OTHER RIGHTS WHICH VARY FROM STATE TO STATE.

The warranties given herein shall be the sole and exclusive warranties granted by Sharp and shall be the sole and exclusive remedy available to the purchaser and only for the time periods set forth herein. No other representations or promises made by anyone are permitted. Correction of defects, in the manner and for the period of time described herein, shall constitute complete fulfillment of all liabilities and responsibilities of Sharp to the purchaser with respect to the Product, and shall constitute full satisfaction of all claims, whether based on contract, negligence, strict liability or otherwise. Sharp does not warrant nor shall Sharp be liable, or in any way responsible, for Products which have been subject to abuse (including, but not limited to, improper voltage), accident, misuse, negligence, lack of reasonable care, alteration, modification, tampering, misuse, improper operation or maintenance or any damages or defects in the Product which were caused by repairs or attempted repairs performed by anyone other than a Sharp authorized servicer. Nor shall Sharp be liable or in any way responsible for any incidental or consequential economic or property damage. Some states do not allow limits on warranties or on remedies for breach in certain transactions; in such states, the limits herein may not apply.

**THIS LIMITED WARRANTY IS VALID ONLY IN THE FIFTY (50) UNITED STATES, THE DISTRICT OF COLUMBIA AND PUERTO RICO.**

#### Model Specific Section

##### Your Product Model Number & Description:

LC-32SB28UT / LC-42SB48UT LCD Color Television  
(Be sure to have this information available when you need service for your Product.)

##### Warranty Period for this Product:

One (1) year parts and labor from the date of purchase.

##### Additional Exclusions from Warranty Coverage (if any):

In order for the Product to be serviced, the Product must be readily available to the servicer, free and clear of any complex or non-standard installation, mounting or other encumbrance which would unreasonably interfere with servicing the Product. The Servicer will remove the Product after service, provided that such remounting is not into a complex or non-standard installation. Any additional labor and materials required to remove and/or reinstall a Product above and beyond the foregoing are not covered by this warranty, may result in additional charges and are the responsibility of the consumer. Image Retention resulting from a fixed image being displayed for long periods of time is not covered by this Limited Warranty (see Operation Manual on how to prevent this).

##### Where to Obtain Service:

From a Sharp Authorized Servicer located in the United States. To find the location of the nearest Sharp Authorized Servicer, please call Sharp toll free at 1-800-BE-SHARP.

##### What to do to Obtain Service:

LC-32SB28UT

Contact your Sharp Authorized Servicer to obtain carry in service for this product. The Servicer will come to your location and if necessary remove the unit for repair at the Servicer's facility and return the set to you once completed. Be sure to have **Proof of Purchase** available.

LC-42SB48UT

Contact your Sharp Authorized Servicer to obtain in home service for this product. The Servicer will come to your location and if necessary remove the unit for repair at the Servicer's facility and return the set to you once completed. Be sure to have **Proof of Purchase** available.

TO OBTAIN PRODUCT INFORMATION OR PURCHASE ACCESSORIES AND EXTENDED WARRANTIES, CALL **1-800-BE-SHARP** OR VISIT [www.sharpsusa.com](http://www.sharpsusa.com)

# SHARP®

## SHARP ELECTRONICS CORPORATION

Sharp Plaza, Mahwah, New Jersey 07495-1163

## SHARP CORPORATION

## Free Manuals Download Website

<http://myh66.com>

<http://usermanuals.us>

<http://www.somanuals.com>

<http://www.4manuals.cc>

<http://www.manual-lib.com>

<http://www.404manual.com>

<http://www.luxmanual.com>

<http://aubethermostatmanual.com>

Golf course search by state

<http://golfingnear.com>

Email search by domain

<http://emailbydomain.com>

Auto manuals search

<http://auto.somanuals.com>

TV manuals search

<http://tv.somanuals.com>