

SHARP®

LC-19SK25U LC-19SK25U-W

LIQUID CRYSTAL TELEVISION
TÉLÉVISEUR ACL
TELEVISOR CON PANTALLA DE
CRISTAL LÍQUIDO

OPERATION MANUAL
MODE D'EMPLOI
MANUAL DE OPERACIÓN



ENGLISH

FRANÇAIS

ESPAÑOL

SHARP®

SHARP ELECTRONICS CORPORATION

Sharp Plaza, Mahwah, New Jersey 07430-2135

SHARP CORPORATION

LC-19SK25U/LC-19SK25U-W

OPERATION MANUAL

MODE D'EMPLOI

MANUAL DE OPERACIÓN

SHARP®

Printed in China
Imprimé au Chine
Impreso en China

TINS-D631WJZZ
08P03-CH



Dimensional drawings

Unit: inch (mm)

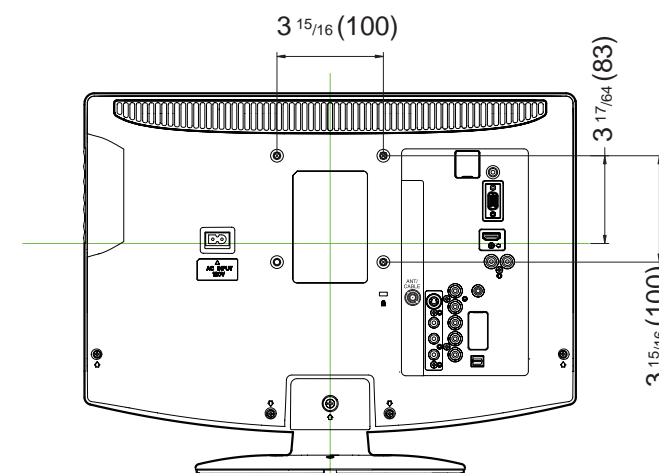
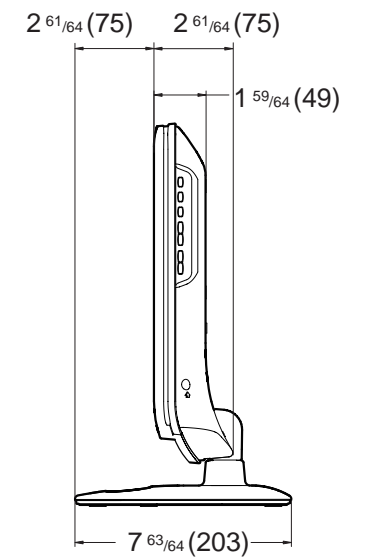
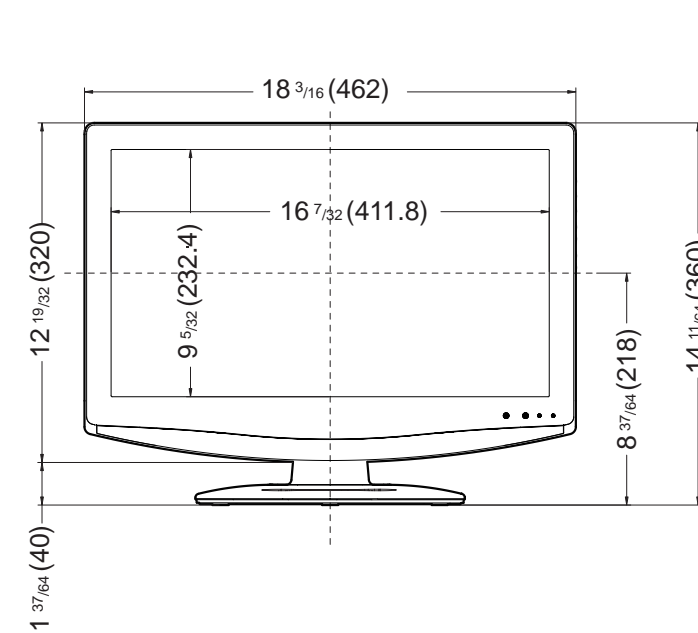
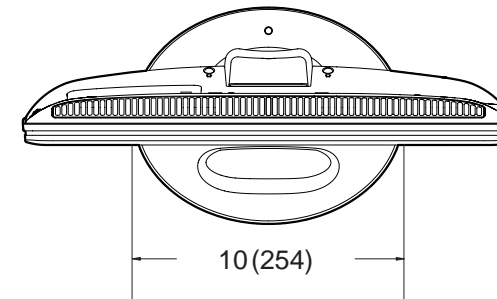

LC-19SK25U LC-19SK25U-W

LIQUID CRYSTAL TELEVISION

ENGLISH

OPERATION MANUAL

IMPORTANT:





To aid reporting in case of loss or theft, please record the TV's model and serial numbers in the space provided. The numbers are located at the rear of the TV.

Model No.:

Serial No.:

IMPORTANT INFORMATION

WARNING: TO REDUCE THE RISK OF FIRE OR ELECTRIC SHOCK, DO NOT EXPOSE THIS PRODUCT TO RAIN OR MOISTURE.

  	 <p>The lightning flash with arrow-head symbol, within an equilateral triangle, is intended to alert the user to the presence of uninsulated "dangerous voltage" within the product's enclosure that may be of sufficient magnitude to constitute a risk of electric shock to persons.</p>
<p>CAUTION: TO REDUCE THE RISK OF ELECTRIC SHOCK, DO NOT REMOVE COVER (OR BACK). NO USER-SERVICEABLE PARTS INSIDE. REFER SERVICING TO QUALIFIED SERVICE PERSONNEL.</p>	 <p>The exclamation point within a triangle is intended to alert the user to the presence of important operating and maintenance (servicing) instructions in the literature accompanying the product.</p>

IMPORTANT INFORMATION

CAUTION: TO PREVENT ELECTRIC SHOCK, MATCH WIDE BLADE OF PLUG TO WIDE SLOT, FULLY INSERT.

CAUTION:

DO NOT PLACE THIS PRODUCT ON AN UNSTABLE CART, STAND, TRIPOD, BRACKET, OR TABLE. THE PRODUCT MAY FALL CAUSING SERIOUS PERSONAL INJURY AND SERIOUS DAMAGE TO THE PRODUCT. USE ONLY WITH A CART, STAND, TRIPOD, BRACKET, OR TABLE RECOMMENDED BY THE MANUFACTURER OR SOLD WITH THE PRODUCT. FOLLOW THE MANUFACTURER'S INSTRUCTIONS WHEN INSTALLING THE PRODUCT AND USE MOUNTING ACCESSORIES RECOMMENDED BY THE MANUFACTURER. A PRODUCT AND CART COMBINATION SHOULD BE MOVED WITH CARE. QUICK STOPS, EXCESSIVE FORCE, AND UNEVEN SURFACES MAY CAUSE THE PRODUCT AND CART COMBINATION TO OVERTURN.



WARNING: FCC Regulations state that any unauthorized changes or modifications to this equipment not expressly approved by the manufacturer could void the user's authority to operate this equipment.

CAUTION:

This product satisfies FCC regulations when shielded cables and connectors are used to connect the unit to other equipment. To prevent electromagnetic interference with electric appliances such as radios and televisions, use shielded cables and connectors for connections.

DECLARATION OF CONFORMITY:

SHARP LIQUID CRYSTAL TELEVISION, MODEL LC-19SK25U/LC-19SK25U-W

This device complies with Part 15 of the FCC Rules. Operation is subject to the following two conditions:

(1) This device may not cause harmful interference, and (2) this device must accept any interference received, including interference that may cause undesired operation.

RESPONSIBLE PARTY:

SHARP ELECTRONICS CORPORATION
Sharp Plaza, Mahwah, New Jersey 07430-2135
TEL: 1-800-BE-SHARP

For Business Customers: URL <http://www.sharpsusa.com>

INFORMATION:

This equipment has been tested and found to comply with the limits for a Class B digital device, pursuant to Part 15 of the FCC Rules. These limits are designed to provide reasonable protection against harmful interference in a residential installation. This equipment generates, uses and can radiate radio frequency energy and, if not installed and used in accordance with the instructions, may cause harmful interference to radio communications. However, there is no guarantee that interference will not occur in a particular installation. If this equipment does cause harmful interference to radio or television reception, which can be determined by turning the equipment off and on, the user is encouraged to try to correct the interference by one or more of the following measures:

- Reorient or relocate the receiving antenna.
- Increase the separation between the equipment and receiver.
- Connect the equipment into an outlet on a circuit different from that to which the receiver is connected.
- Consult the dealer or an experienced radio/TV technician for help.

"Note to CATV system installer: This reminder is provided to call the CATV system installer's attention to Article 820-40 of the National Electrical Code that provides guidelines for proper grounding and, in particular, specifies that the cable ground shall be connected to the grounding system of the building, as close to the point of cable entry as practical."

This product utilizes tin-lead solder, and fluorescent lamp containing a small amount of mercury. Disposal of these materials may be regulated due to environmental considerations. For disposal or recycling information, please contact your local authorities, the Electronic Industries Alliance: www.eiae.org, the lamp recycling organization: www.lamprecycle.org or Sharp at 1-800-BE-SHARP (For U.S.A. Only)

Trademarks

- Manufactured under license from Dolby Laboratories. "Dolby" and the double-D symbol are trademarks of Dolby Laboratories.
- "HDMI, the HDMI logo and High-Definition Multimedia Interface are trademarks or registered trademarks of HDMI Licensing LLC."
- Products that have earned the ENERGY STAR® are designed to protect the environment through superior energy efficiency.

DEAR SHARP CUSTOMER

Thank you for your purchase of the Sharp Liquid Crystal Television. To ensure safety and many years of trouble-free operation of your product, please read the Important Safety Instructions carefully before using this product.

IMPORTANT SAFETY INSTRUCTIONS

Electricity is used to perform many useful functions, but it can also cause personal injuries and property damage if improperly handled. This product has been engineered and manufactured with the highest priority on safety. However, improper use can result in electric shock and/or fire. In order to prevent potential danger, please observe the following instructions when installing, operating and cleaning the product. To ensure your safety and prolong the service life of your Liquid Crystal Television, please read the following precautions carefully before using the product.

- 1) Read these instructions.
- 2) Keep these instructions.
- 3) Heed all warnings.
- 4) Follow all instructions.
- 5) Do not use this apparatus near water.
- 6) Clean only with dry cloth.
- 7) Do not block any ventilation openings. Install in accordance with the manufacturer's instructions.
- 8) Do not install near any heat sources such as radiators, heat registers, stoves, or other apparatus (including amplifiers) that produce heat.
- 9) Do not defeat the safety purpose of the polarized or grounding-type plug. A polarized plug has two blades with one wider than the other. A grounding type plug has two blades and a third grounding prong. The wide blade or the third prong are provided for your safety. If the provided plug does not fit into your outlet, consult an electrician for replacement of the obsolete outlet.
- 10) Protect the power cord from being walked on or pinched particularly at plugs, convenience receptacles, and the point where they exit from the apparatus.
- 11) Only use attachments/accessories specified by the manufacturer.
- 12) Use only with the cart, stand, tripod, bracket, or table specified by the manufacturer, or sold with the apparatus. When a cart is used, use caution when moving the cart/apparatus combination to avoid injury from tip-over.
- 13) Unplug this apparatus during lightning storms or when unused for long periods of time.
- 14) Refer all servicing to qualified service personnel. Servicing is required when the apparatus has been damaged in any way, such as power-supply cord or plug is damaged, liquid has been spilled or objects have fallen into the apparatus, the apparatus has been exposed to rain or moisture, does not operate normally, or has been dropped.



Additional Safety Information

- 15) Power Sources—This product should be operated only from the type of power source indicated on the marking label. If you are not sure of the type of power supply to your home, consult your product dealer or local power company. For products intended to operate from battery power, or other sources, refer to the operating instructions.
- 16) Overloading—Do not overload wall outlets, extension cords, or integral convenience receptacles as this can result in a risk of fire or electric shock.
- 17) Object and Liquid Entry—Never push objects of any kind into this product through openings as they may touch dangerous voltage points or short-out parts that could result in a fire or electric shock. Never spill liquid of any kind on the product.
- 18) Damage Requiring Service—Unplug this product from the wall outlet and refer servicing to qualified service personnel under the following conditions:
 - a) When the AC cord or plug is damaged,
 - b) If liquid has been spilled, or objects have fallen into the product,
 - c) If the product has been exposed to rain or water,
 - d) If the product does not operate normally by following the operating instructions.
Adjust only those controls that are covered by the operating instructions as an improper adjustment of other controls may result in damage and will often require extensive work by a qualified technician to restore the product to its normal operation,
 - e) If the product has been dropped or damaged in any way, and
 - f) When the product exhibits a distinct change in performance - this indicates a need for service.
- 19) Replacement Parts—When replacement parts are required, be sure the service technician has used replacement parts specified by the manufacturer or have the same characteristics as the original part. Unauthorized substitutions may result in fire, electric shock, or other hazards.
- 20) Safety Check—Upon completion of any service or repairs to this product, ask the service technician to perform safety checks to determine that the product is in proper operating condition.
- 21) Install the product on the place where the AC cord can be unplugged easily from the AC outlet, or from the AC INPUT terminal on the rear of the product.

IMPORTANT SAFETY INSTRUCTIONS

- **Water and Moisture** — Do not use this product near water - for example, near a bath tub, wash bowl, kitchen sink, or laundry tub; in a wet basement; or near a swimming pool; and the like.



- **Stand** — Do not place the product on an unstable cart, stand, tripod or table. Placing the product on an unstable base can cause the product to fall, resulting in serious personal injuries as well as damage to the product. Use only a cart, stand, tripod, bracket or table recommended by the manufacturer or sold with the product. When mounting the product on a wall, be sure to follow the manufacturer's instructions. Use only the mounting hardware recommended by the manufacturer.

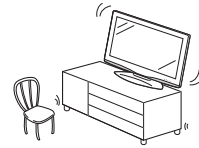

- **Selecting the location** — Select a place with no direct sunlight and good ventilation.

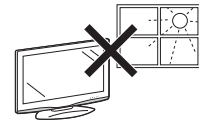

- **Ventilation** — The vents and other openings in the cabinet are designed for ventilation. Do not cover or block these vents and openings since insufficient ventilation can cause overheating and/or shorten the life of the product. Do not place the product on a bed, sofa, rug or other similar surface, since they can block ventilation openings. This product is not designed for built-in installation; do not place the product in an enclosed place such as a bookcase or rack, unless proper ventilation is provided or the manufacturer's instructions are followed.

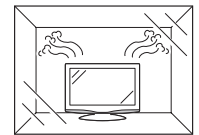

- **The Liquid Crystal panel** used in this product is made of glass. Therefore, it can break when the product is dropped or applied with impact. Be careful not to be injured by broken glass pieces in case the panel breaks.



- **Heat** — The product should be situated away from heat sources such as radiators, heat registers, stoves, or other products (including amplifiers) that produce heat.



- The Liquid Crystal panel is a very high technology product with 1,049,088 pixels, giving you fine picture details. Occasionally, a few non-active pixels may appear on the screen as a fixed point of blue, green or red. Please note that this does not affect the performance of your product.

- **Lightning** — For added protection for this television equipment during a lightning storm, or when it is left unattended and unused for long periods of time, unplug it from the wall outlet and disconnect the antenna. This will prevent damage to the equipment due to lightning and power-line surges.



- **Power Lines** — An outside antenna system should not be located in the vicinity of overhead power lines or other electric light or power circuits, or where it can fall into such power lines or circuits. When installing an outside antenna system, extreme care should be taken to keep from touching such power lines or circuits as contact with them might be fatal.

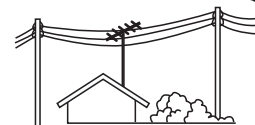

IMPORTANT SAFETY INSTRUCTIONS

- Outdoor Antenna Grounding — If an outside antenna is connected to the television equipment, be sure the antenna system is grounded so as to provide some protection against voltage surges and built-up static charges. Article 810 of the National Electrical Code, ANSI/NFPA 70, provides information with regard to proper grounding of the mast and supporting structure, grounding of the lead-in wire to an antenna discharge unit, size of grounding conductors, location of antenna-discharge unit, connection to grounding electrodes, and requirements for the grounding electrode.

EXAMPLE OF ANTENNA GROUNDING AS PER NATIONAL ELECTRICAL CODE, ANSI/NFPA 70

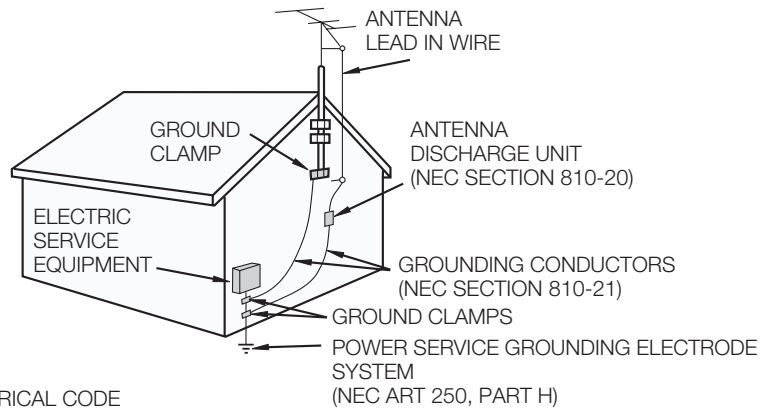

NEC — NATIONAL ELECTRICAL CODE

- To prevent fire, never place any type of candle or flames on the top or near the TV set.

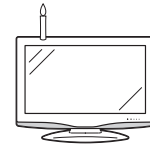

- To prevent fire or shock hazard, do not expose this product to dripping or splashing. No objects filled with liquids, such as vases, should be placed on the product.



- To prevent fire or shock hazard, do not place the AC cord under the TV set or other heavy items.

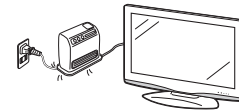

- Turn off the main power and unplug the AC cord from the wall outlet before handling.
- Use a soft cloth and gently wipe the surface of the display panel. Using a hard cloth may scratch the panel surface.
- Use a soft damp cloth to gently wipe the panel when it is really dirty. (It may scratch the panel surface when wiped strongly.)
- If the panel is dusty, use an anti-static brush, which is commercially available, to clean it.
- To protect the panel, do not use a dirty cloth, liquid cleaners or chemical cloth to clean it, such materials may damage the panel surface.
- To clean the outer cabinet, use the same method. Do not use liquid or aerosol cleaners.



- Do not display a still picture for a long time, as this could cause an afterimage to remain.

- When cleaning the TV or the stand, use the cloth supplied with the TV.

- When transporting the TV, never carry it by holding or otherwise putting pressure onto the display.

IMPORTANT SAFETY INSTRUCTIONS

CHILD SAFETY:

It Makes A Difference How and Where You Use Your Flat Panel Display

Congratulations on your purchase! As you enjoy your new product, please keep these safety tips in mind:



THE ISSUE

- The home theater entertainment experience is a growing trend and larger flat panel displays are popular purchases. However, flat panel displays are not always supported on the proper stands or installed according to the manufacturer's recommendations.
- Flat panel displays that are inappropriately situated on dressers, bookcases, shelves, desks, speakers, chests or carts may fall over and cause injury.

THIS MANUFACTURER CARES!

- The consumer electronics industry is committed to making home entertainment enjoyable and safe.

TUNE INTO SAFETY

- One size does NOT fit all. Follow the manufacturer's recommendations for the safe installation and use of your flat panel display.
- Carefully read and understand all enclosed instructions for proper use of this product.
- Don't allow children to climb on or play with furniture and television sets.
- Don't place flat panel displays on furniture that can easily be used as steps, such as a chest of drawers.
- Remember that children can become excited while watching a program, especially on a "larger than life" flat panel display. Care should be taken to place or install the display where it cannot be pushed, pulled over, or knocked down.
- Care should be taken to route all cords and cables connected to the flat panel display so that they cannot be pulled or grabbed by curious children.



WALL MOUNTING: IF YOU DECIDE TO WALL MOUNT YOUR FLAT PANEL DISPLAY, ALWAYS:









- Use a mount that has been recommended by the display manufacturer and/or listed by an independent laboratory (such as UL, CSA, ETL).
- Follow all instructions supplied by the display and wall mount manufacturers.
- If you have any doubts about your ability to safely install your flat panel display, contact your retailer about professional installation.
- Make sure that the wall where you are mounting the display is appropriate. Some wall mounts are not designed to be mounted to walls with steel studs or old cinder block construction. If you are unsure, contact a professional installer.
- A minimum of two people are required for installation. Flat panel displays can be heavy.



Note: CEA is the preeminent trade association promoting growth in the \$161 billion U.S. consumer electronics industry. More than 2,200 companies enjoy the benefits of CEA membership, including legislative advocacy, market research, technical training and education, industry promotion and the fostering of business and strategic relationships.

Supplied accessories

Make sure the following accessories are provided with the product.

 <p>Remote control unit (×1) “AA” size manganese battery (×2) Page 9</p>	 <p>Kitchen Remote control unit (×1) “AA” size alkaline battery (×2) Page 51</p>	 <p>AC cord (×1) Page 8</p>	 <p>Cable Clamp (×1) Page 8</p>	
 <p>Stand (×1) Page 7</p>	 <p>Screws (×3) Page 7</p>	 <p>Hex key (×1) Page 7</p>	 <p>Cleaning cloth (×1) Page 5</p>	 <p>Operation manual (×1)</p>

NOTE

- Always use the AC cord supplied with the TV.

Before using the TV unit

Attaching the stand

- Before attaching (or detaching) the stand, unplug the AC cord from the AC INPUT terminal.
- Before performing work spread cushioning over the base area to lay the TV on. This will prevent it from being damaged.

CAUTION

- Attach the stand in the correct direction.**
- Be sure to follow the instructions. Incorrect installation of the stand may result in the TV falling over.**

1 Confirm the 3 screws supplied with the TV.

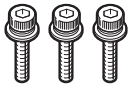

Screws (×3)
(Used in step 2)

- 2**
- Insert the stand into the openings on the bottom of the TV.
 - Insert and tighten the 3 screws into the 3 holes on the rear of the stand.

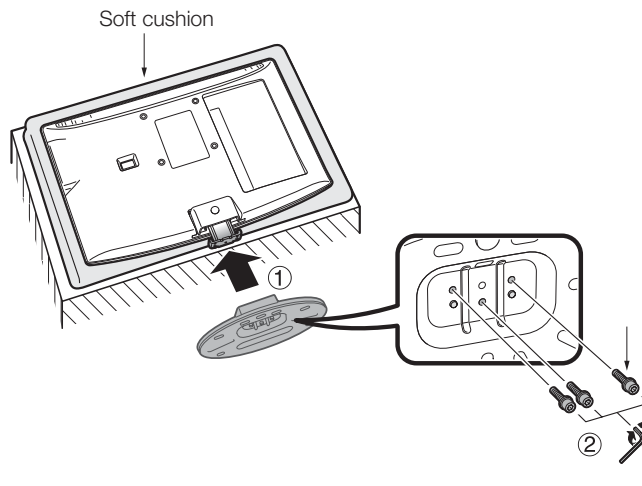

NOTE

- To detach the stand, perform the steps in reverse order.

QUICK REFERENCE

Ventilation & Cleaning Tips

Keep your television in a well ventilated area and make sure not to place it by a heat source or use near water. The television is designed for AC use only and should be used with supplied AC cord.

Clean the screen by spraying a soft lint free cloth with water to lightly moisten. Gently wipe and avoid pressing on the screen. To clean the outer cabinet, use the same method. Do not use liquid or aerosol cleaners.

The screen is glass and can be scratched or broken when dropped or impacted.

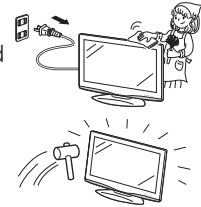

Notes on installing the TV

- Avoid direct sunlight and place the TV in a well-ventilated location.
- Place the TV in a level location.
- Do not turn on the power of the TV before connecting the AC cord.

QUICK INSTALLATION TIPS

- 1** Attach your antenna to the back of the television. (See page 14.)

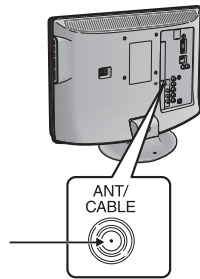

- 2** Connect the AC plug for the television into the AC outlet.

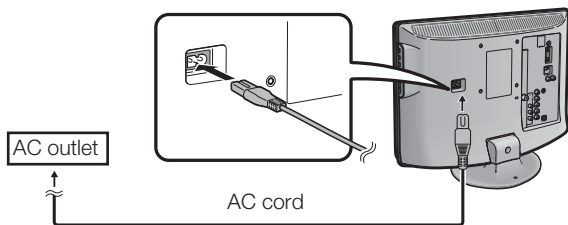

- Place the TV close to the AC outlet, and keep the power plug within reach.

NOTE

- **TO PREVENT RISK OF ELECTRIC SHOCK, DO NOT TOUCH UN-INSULATED PARTS OF ANY CABLES WITH THE AC CORD CONNECTED.**

- 3** Bundle the cords properly with cable clamps .

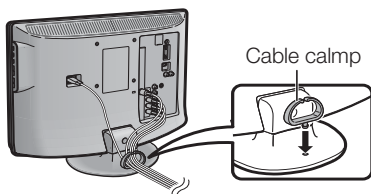

- 4** How to turn on the television for the first time.
A) Press **POWER** on television.

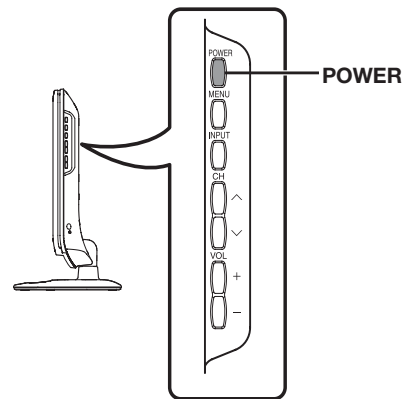

- B) POWER indicator on the front of the television lights GREEN.

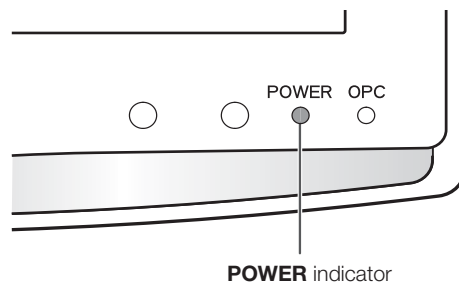

NOTE

- Speakers cannot be detached from the TV.
- To change the vertical angle of the LCD TV set, tilt the screen up to 2.5 degrees forward or 10 degrees backwards. Please adjust the angle so that the LCD TV set can be watched most comfortably.

QUICK REFERENCE

If the remote control fails to operate TV functions, replace the batteries in the remote control unit.

1 Open the battery cover.

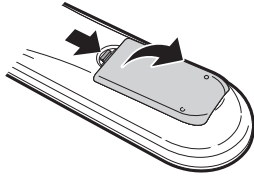

2 Insert two "AA" size batteries (supplied with the product).

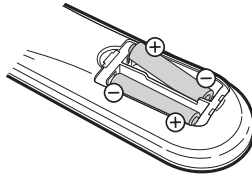

3 Close the battery cover.

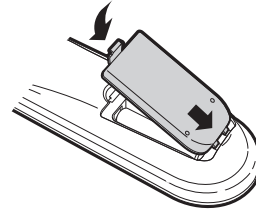

- Place the batteries with their terminals corresponding to the (+) and (-) indications in the battery compartment.

CAUTION

Improper use of batteries can result in chemical leakage or explosion. Be sure to follow the instructions below.

- Do not mix batteries of different types. Different types of batteries have different characteristics.
- Do not mix old and new batteries. Mixing old and new batteries can shorten the life of new batteries or cause chemical leakage in old batteries.
- Remove batteries as soon as they are worn out. Chemicals that leak from batteries that come in contact with skin can cause a rash. If you find any chemical leakage, wipe thoroughly with a cloth.
- The batteries supplied with this product may have a shorter life expectancy due to storage conditions.
- If you will not be using the remote control unit for an extended period of time, remove batteries from it.

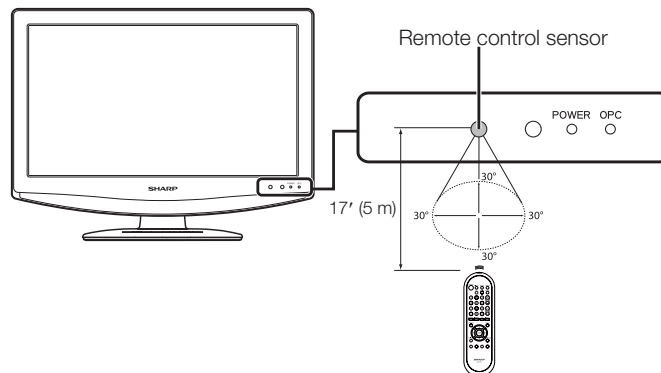

IMPORTANT:

The POWER indicator on the television should light GREEN indicating you have power to the television.

If the POWER indicator on the television still does not light up, press **POWER** on the remote control to turn the power on.

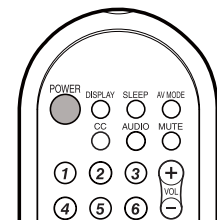

IMPORTANT:

IF THE UNIT DOES NOT POWER ON - UNPLUG THE TELEVISION FROM THE OUTLET AND REPEAT THE INSTALLATION STEPS.

IF YOU STILL ENCOUNTER NO POWER, PLEASE CONTACT US AT 1-800-BE-SHARP.

Contents

IMPORTANT INFORMATION	1	Using external equipment	31
Trademarks	2	Displaying an external equipment image	31
DEAR SHARP CUSTOMER	3	Displaying an image from HDMI equipment.....	32
IMPORTANT SAFETY INSTRUCTIONS	3	Useful adjustment settings	33
Supplied accessories	7	Auto Sync. Adjustment	
Before using the TV unit	7	(for Analog PC input mode only)	33
QUICK REFERENCE	8	Fine Sync. Adjustment	33
Contents	10	Picture Rotate.....	34
Part names	11	Language setting	35
TV (Front).....	11	Image position	35
TV (Side/Rear).....	11	Reset.....	35
Remote control unit	12	Input Label.....	36
Kitchen Remote control unit.....	13	Sleep Timer	36
Preparation	14	View Mode for 4:3 Programs	37
Using the remote control unit.....	14	View Mode for HD Programs	37
Cautions regarding the remote control		View Mode (for PC input mode)	38
unit	14	Advanced Option settings.....	39
Antennas	14	DNR.....	39
Connecting a VCR, game console		Audio Only	39
or camcorder.....	15	Color System	39
Connecting a Blu-ray disc player, HD-DVD player,		Digital Audio	40
DVD player or a Digital TV STB (Air or Cable)...	15	AV MODE	41
Using Digital Audio Output.....	15	Input Signal (for Analog PC input mode only)	41
Connecting HDMI equipment.....	16	Closed Captions and Digital Closed	
Connecting a PC	16	Captions.....	42
PC compatibility chart.....	16	Digital Caption Setup	43
Watching TV	17	Secret number setting for parental control	44
Turning on the power.....	17	Parental control (setting V-CHIP level)	46
Turning off the power.....	17	How to temporarily release	
Initial setup	18	the V-CHIP BLOCK	49
Simple button operations for		Reactivating the temporarily released	
changing channels	19	V-CHIP BLOCK.....	49
Displaying the receiving channel information	19	Other viewing options	50
Simple button operations for		Freezing images.....	50
changing volume/sound	20	Using the kitchen remote control unit	51
Setting MTS/SAP stereo mode	21	Kitchen Remote control unit.....	51
Setting Digital broadcasting audio mode.....	21	Clock set	52
Basic adjustment settings	22	Kitchen timer set.....	52
Menu operation buttons.....	22	Alarm set	53
On-Screen Display.....	22	Alarm off	53
Menu items for TV/INPUT 1/2	23	Backlight	53
Menu items for HDMI/PC-IN	23	Appendix	54
EZ Setup	24	Troubleshooting.....	54
Channel Setup.....	24	Troubleshooting-Digital broadcasting.....	54
Favorite channel setting	26	Specifications	55
Picture adjustments	27	Information on the software license for this	
OPC setting	27	product	57
Advanced picture settings.....	28	Calling for Service	58
C.M.S.	28	LIMITED WARRANTY	58
Color Temperature	28		
Film Mode	28	Dimensional drawings	
3D-Y/C	28	• The dimensional drawings for the LCD TV set are shown on	
Monochrome	28	the inside back cover.	
I/P Setting	28		
Sound adjustment	29		
Power Control	30		
Power Management	30		

Part names

TV (Front)

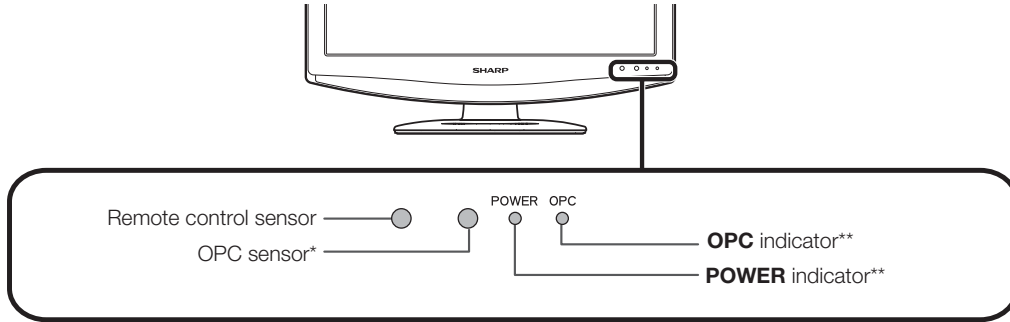

NOTE

*OPC: Optical Picture Control (See page 27.)

**See page 17 for TV status indicator.

TV (Side/Rear)

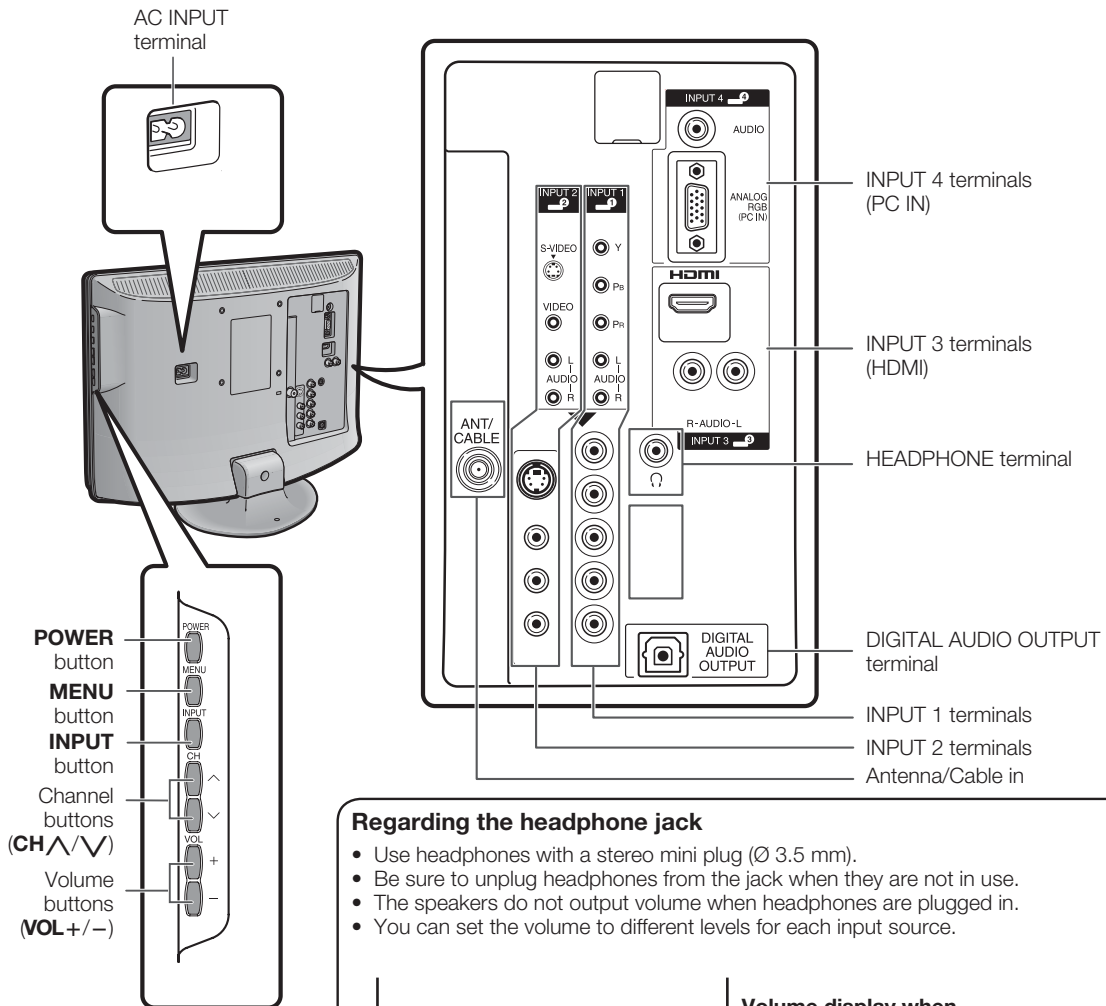

Regarding the headphone jack

- Use headphones with a stereo mini plug (Ø 3.5 mm).
- Be sure to unplug headphones from the jack when they are not in use.
- The speakers do not output volume when headphones are plugged in.
- You can set the volume to different levels for each input source.

Volume display when headphones are plugged in

- The illustrations in this operation manual are for explanation purposes and may vary slightly from the actual operations.
- The examples used throughout this manual are based on the LC-19SK25U model.

Part names

Remote control unit

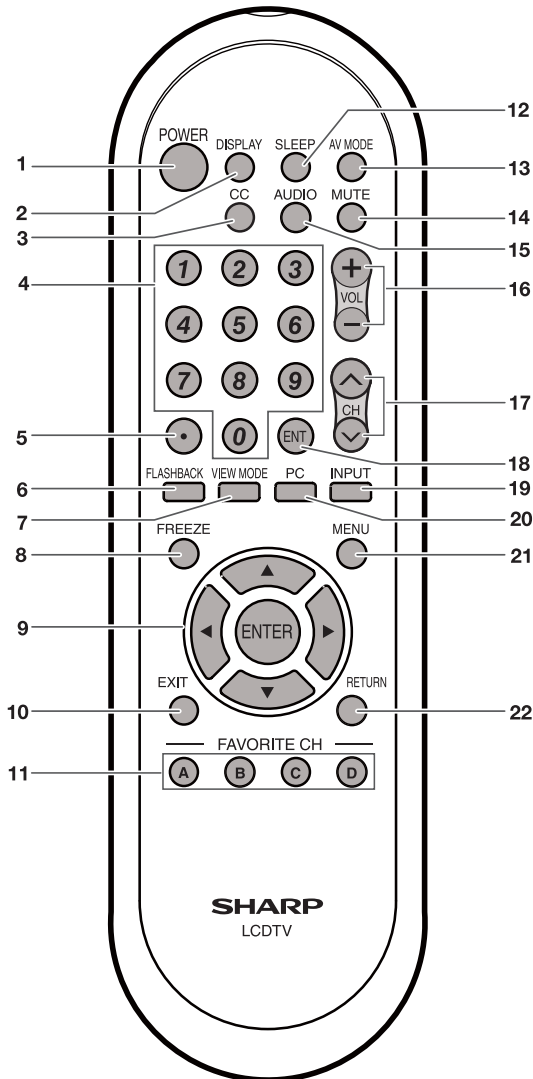

- 1 POWER:** Switch the TV power on or enters standby. (See page 17.)
- 2 DISPLAY:** Display the channel information. (See page 19.)
- 3 CC:** Display captions from a closed-caption source. (See page 42.)
- 4 0 – 9:** Set the channel. (See page 19.)
- 5 • (DOT):** (See pages 19.)
- 6 FLASHBACK:** Return to the previous channel or external input mode. (See page 19.)
- 7 VIEW MODE:** Select the screen size. (See pages 37 and 38.)
- 8 FREEZE:** Set the still image. Press again to return to normal screen. (See page 50.)
- 9 ▲/▼/◀/▶/ENTER:** Select a desired item on the screen.
- 10 EXIT:** Turn off the menu screen.
- 11 FAVORITE CH**
A, B, C, D: Select 4 preset favorite channels in 4 different categories. (See page 26 for details.)
While watching, you can toggle the selected channels by pressing A, B, C and D.
- 12 SLEEP:** Set the sleep timer. (See page 36.)
- 13 AV MODE:** Select an audio or video setting. (When the input source is TV, INPUT 1 or 2: STANDARD, MOVIE, GAME, USER, DYNAMIC (Fixed), DYNAMIC. When the input source is INPUT 3: STANDARD, MOVIE, GAME, PC, USER, DYNAMIC (Fixed), DYNAMIC. When the input source is INPUT 4: STANDARD, PC, USER) (See page 41.)
- 14 MUTE:** Mute the sound. (See page 20.)
- 15 AUDIO:** Selects the MTS/SAP or the audio mode during multi-channel audio broadcasts. (See page 21.)
- 16 VOL +/–:** Set the volume. (See page 20.)
- 17 CH ▲/▼:** Select the channel. (See page 19.)
- 18 ENT:** Jumps to a channel after selecting with the **0–9** buttons.
- 19 INPUT:** Select a TV input source. (TV, INPUT 1, INPUT 2, INPUT 3, INPUT 4) (See pages 31 and 32.)
- 20 PC:** Quickly access to PC mode. (See pages 31 and 33.)
- 21 MENU:** Display the menu screen.
- 22 RETURN:** Return to the previous menu screen.

NOTE

- When using the remote control unit, point it at the TV.

Part names

Kitchen Remote control unit

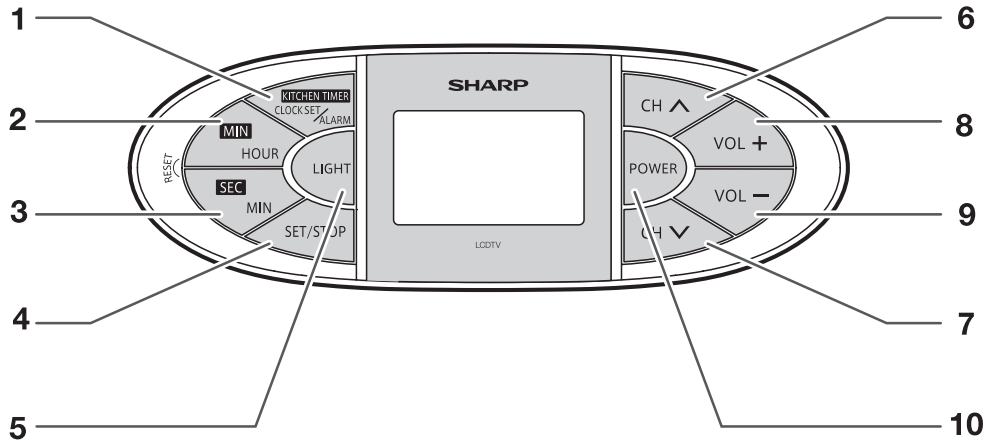

1 KITCHEN TIMER/CLOCK SET/ALARM:

Set the kitchen timer, clock or alarm. (See page 52.)

2 MIN/HOUR :

Set the minute of kitchen timer and the hour of clock or alarm. (See page 52.)

3 SEC/MIN :

Set the second of kitchen timer and the minute of clock or alarm. (See page 52.)

4 SET/STOP :

Confirm setting or stop beeper sound. (See page 52.)

5 LIGHT :

Light on the remote control LCD backlight. (See page 53.)

6,7 CH ^/CH v :

Select the channel. (See page 19.)

8 VOL+ :

To increase the volume. (See page 20.)

9 VOL- :

To decrease the volume. (See page 20.)

10 POWER :

Switch the TV power on or enters standby. (See page 17.)

NOTE

- The method of using the Kitchen Remote control unit, please see page 51~53.

Preparation

Using the remote control unit

Use the remote control unit by pointing it towards the remote control sensor on the TV. Objects between the remote control unit and the remote control sensor may prevent proper operation.

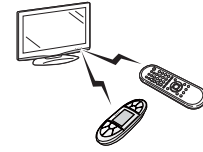

Cautions regarding the remote control unit

- Do not expose the remote control unit to shock. In addition, do not expose the remote control unit to liquids, and do not place in an area with high humidity.
- Do not install or place the remote control unit under direct sunlight. The heat may cause deformation of the remote control unit.
- The remote control unit may not work properly if the remote control sensor on the TV is under direct sunlight or strong lighting. In such cases, change the angle of the lighting or the TV, or operate the remote control unit closer to the remote control sensor.

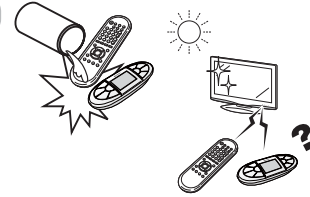

Antennas

To enjoy a clearer picture, use an outdoor antenna. The following is a brief explanation of the types of connections that are used for a coaxial cable. If your outdoor antenna uses a 75-ohm coaxial cable with an F-type connector, plug it into the antenna terminal at the rear of the TV set.

1. A 75-ohm system is generally a round cable with F-type connector that can easily be attached to a terminal without tools (Commercially available).

F-type connector



2. A 300-ohm system is a flat "twin-lead" cable that can be attached to a 75-ohm terminal through a 300/75-ohm adapter (Commercially available).

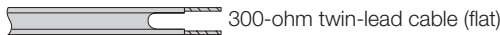

NOTICE F-type connector should be finger-tightened only.

When connecting the RF cable to the TV set, do not tighten F-type connector with tools. If tools are used, it may cause damage to your TV set. (The breaking of internal circuit, etc.)

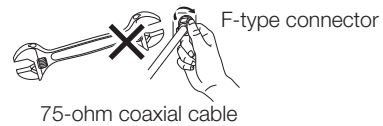

Connecting Antenna Cable

- ① Cable without a CATV converter



- ② VHF/UHF antenna

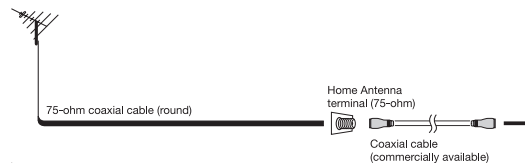

- ③ Combination VHF/UHF antenna

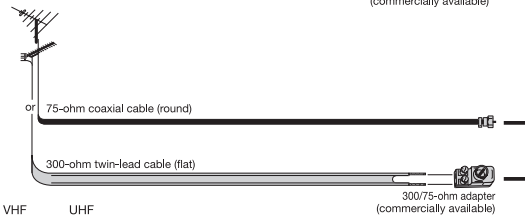

- ④ Separate VHF/UHF antenna

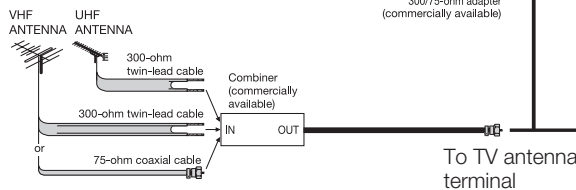

- Connect the antenna cable to the TV using one of the methods in the illustration as shown (①, ②, ③ or ④).

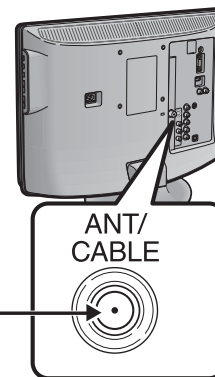

Preparation

You can connect many types of external equipment to your TV like a Blu-ray disc player, HD-DVD player, DVD player, VCR, Digital TV tuner, HDMI equipment, game console or camcorder. To view external source images, select the input source from **INPUT** on the remote control unit or on the TV. (See pages 31 and 32.)

CAUTION

- To protect equipment, always turn off the TV before connecting any external equipment.
- Please read the relevant operation manual (Blu-ray disc player, etc.) carefully before making connections.
- If your Blu-ray disc player offers a choice of output formats, please select 720p for use with this TV.

Connecting a VCR, game console or camcorder

A VCR, game console, camcorder and other audiovisual equipment can be conveniently connected using the INPUT 2 terminals.

When using S-VIDEO cable (commercially available).

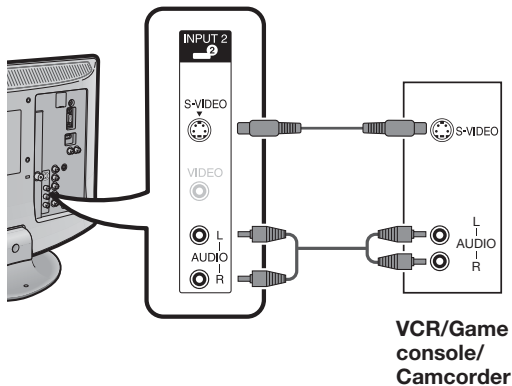

When using composite cable (commercially available).

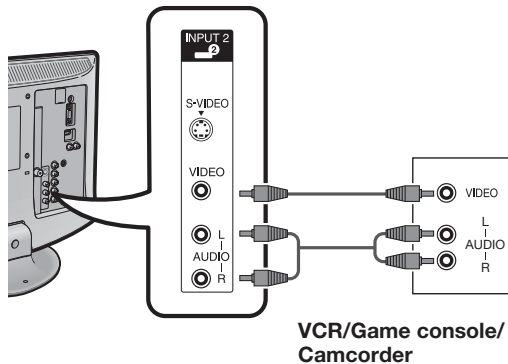

NOTE

- The S-VIDEO terminal takes priority over the video terminals. (INPUT 2 only)

Connecting a Blu-ray disc player, HD-DVD player, DVD player or a Digital TV STB (Air or Cable)

When using component cable. (INPUT 1)

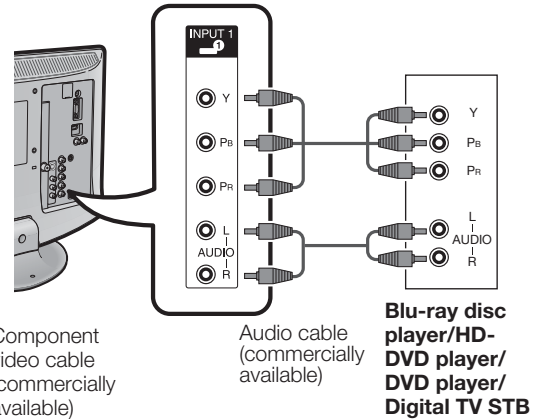

Using Digital Audio Output

It is possible to output audio through the DIGITAL AUDIO OUTPUT terminal.

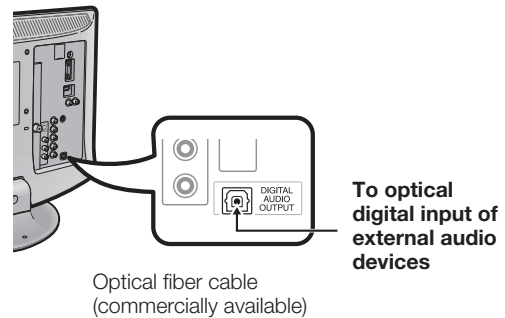

Preparation

Connecting HDMI equipment

You can use the INPUT 3 terminal when connecting HDMI equipment.

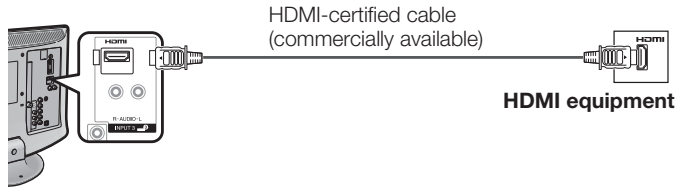

NOTE

- When using an HDMI-DVI conversion cable, input the audio signal to AUDIO terminal of INPUT 3.
- When receiving an incompatible signal, such as 1080p, the message below appears without the image on the screen.
For an incompatible video signal: "Not compatible with this signal."

Connecting a PC

When connecting to a PC with an analog RGB terminal. (INPUT 4)

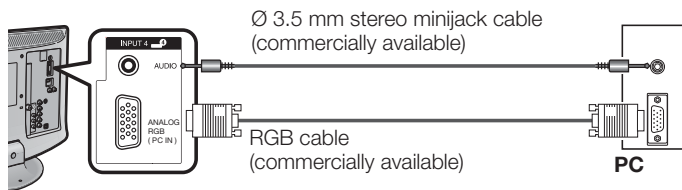

PC compatibility chart

It is necessary to set the PC correctly to display XGA and WXGA signal. Refer to page 41 to set PC input signals.

PC	Resolution	Horizontal Frequency	Vertical Frequency	VESA Standard	
PC	VGA	720 x 400	31,5 kHz	70 Hz	—
		640 x 480	31,5 kHz	60 Hz	—
			37,9 kHz	72 Hz	○
			37,5 kHz	75 Hz	○
	SVGA	800 x 600	35,1 kHz	56 Hz	○
			37,9 kHz	60 Hz	○
			48,1 kHz	72 Hz	○
			46,9 kHz	75 Hz	○
			53,7 kHz	85 Hz	○
	XGA	1024 x 768	48,4 kHz	60 Hz	○
			56,5 kHz	70 Hz	○
			60,0 kHz	75 Hz	○
			60,0 kHz	85 Hz	○
	WXGA	1280 x 768	60,0 kHz	60 Hz	○
1360 x 768		47,7 kHz	60 Hz	○	

DDC is a registered trademark of Video Electronics Standards Association.
Power Management is a registered trademark of Sun Microsystems, Inc.
VGA and XGA are registered trademarks of International Business Machines Corp.

Watching TV

Simple operations for watching a TV program

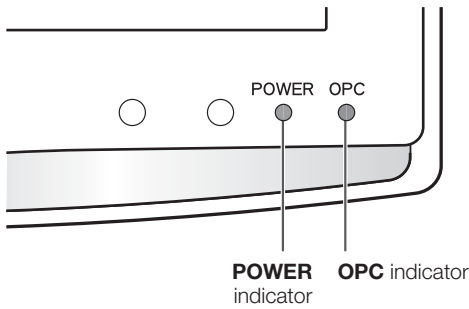
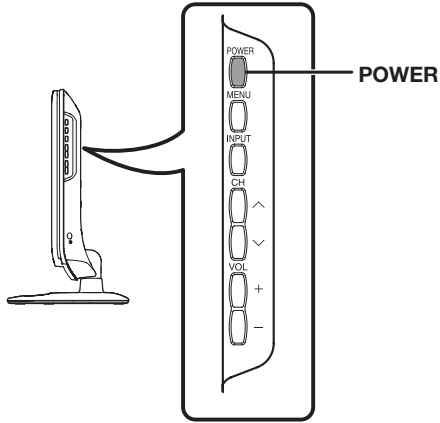

POWER (On/Standby)

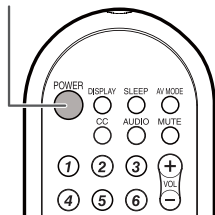

POWER (On/Standby)

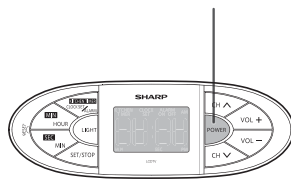

Turning on the power

Press **POWER** on the TV, or **POWER** on the remote control unit.

- **POWER indicator (Green):** The TV is on. (After a few seconds, a window appears with sound.)

NOTE

- The initial setup starts when the TV powers on for the first time. If the TV has been turned on before, the EZ Setup will not be invoked. See page 26 for performing EZ Setup from the Setup menu.

Turning off the power

Press **POWER** on the TV, or **POWER** on the remote control unit.

- The TV enters standby and the image on the screen disappears.
- The **POWER** indicator on the TV turns off.

NOTE

- If you are not going to use this TV for a long period of time, be sure to remove the AC cord from the AC outlet.
- Weak electric power is still consumed even when **POWER** is turned off.

TV status indicator (POWER)

Off	Power off, Standby mode
Green	The TV is on

TV status indicator (OPC)

Lights off	"Off" is selected in OPC setting
Lighting (Green)	"On" or "On: Display" is selected in OPC setting

- See page 27 for details.

Watching TV

Initial setup

When you turn on the TV for the first time, it will automatically memorize the broadcasting channels where you live. Perform the following steps before you press **POWER** on the remote control unit.

1. Insert the batteries into the remote control unit. (See page 9.)
2. Connect the antenna cable to the TV. (See page 14.)
3. Plug in the AC cord to the AC outlet. (See page 8.)

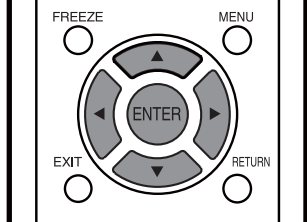

Language setting

Select from among 3 languages: English, French and Spanish.

- 1 Press **▲/▼** to select the desired language listed on the screen, and then press **ENTER**.



Antenna setting

Make sure what kind of connection is made with your TV when selecting "Air", "Cable(STD)", "Cable(HRC)" or "Cable(IRC)".

- 2 Press **▲/▼** to select "Air", "Cable(STD)", "Cable(HRC)" or "Cable(IRC)". Press **ENTER** to enter the setting.

Example

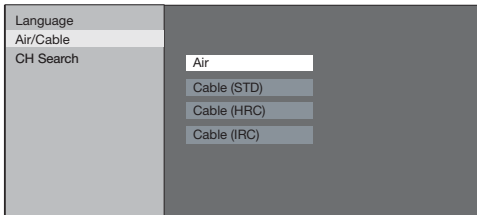

Channel search

Channel auto search makes the TV look for all channels viewable in the set area.

- 3 When "Air/Cable" has been selected in Antenna setting and then press **ENTER** again.



Press **▲/▼** to select "Analog & Digital" to search both analog and digital broadcasts or "Analog" to search only analog broadcasts or "Digital" to search only digital broadcasts, and then press **ENTER**.

Press **▲/▼** to select "Yes" or "No", and then press **ENTER**.

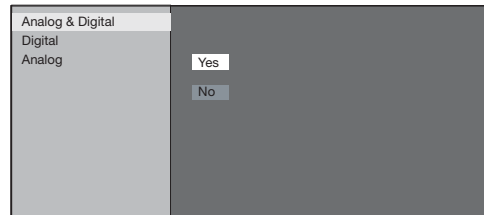

- The Channel search will start automatically.
- To exit the Channel search screen, press **RETURN**.

Example



NOTE

- If no channel is found, confirm the type of connection made with your TV and try EZ Setup again. (See page 24.)

Watching TV

Simple button operations for changing channels

You can change channels in several ways.

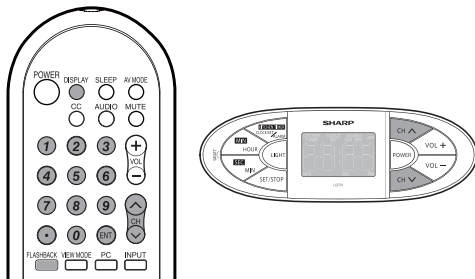
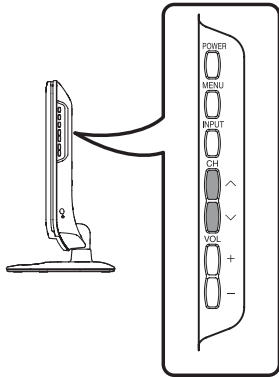

Method 1

Using **CH** \wedge / \vee on the remote control unit, on the kitchen remote control unit or on the TV.

Method 2

- 1 Press **FLASHBACK** to switch to the previously tuned channel.
- 2 Press **FLASHBACK** again to switch back to the currently tuned channel.

NOTE

- **FLASHBACK** will not work if no channel has been changed after the TV is turned on.

Method 3

Using remote control buttons **0-9**, • (DOT) to select channels for VHF/UHF/CATV/DIGITAL.

To select a 1 or 2-digit channel number (e. g., Channel 5):

Press **5**→**ENT**



NOTE

- When selecting a 1-digit channel number, it is not necessary to press **0** before the number.
- When you enter **0-9** only, channel selection will be made if there is no operation within a few seconds.

To select a 3-digit channel number (e. g., Channel 115):

Press **1**→**1**→**5**→**ENT**



To select a 4-digit channel number (e. g., Channel 22.1):

Press **2**→**2**→• (DOT)→**1**→**ENT**



NOTE

- When you enter **0-9** only, channel selection will be made if there is no operation within a few seconds.
- If you push "0" by itself, nothing will happen.
- Complete the above steps within a few seconds.
- When you enter **0-9** and • (DOT), channel selection will be made if there is no operation within a few seconds.

Displaying the receiving channel information

1

Press **DISPLAY** once. The display appears as shown on below. If the viewing channel is a digital channel, the information of channel number, audio service type, broadcast station, program information and V-Chip rating will appear.



(While viewing digital channel)

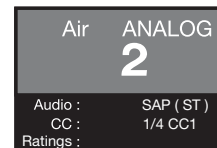

(While viewing analog channel)

2

Press **DISPLAY** again to return to normal screen.

NOTE

- The channel information will disappear if there is no operation within a few seconds.

Watching TV

Simple button operations for changing volume/sound

■ Changing the volume

You can change the volume on the TV, on the remote control unit or on the kitchen remote control unit.

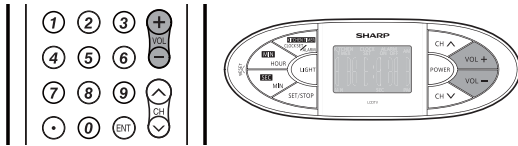
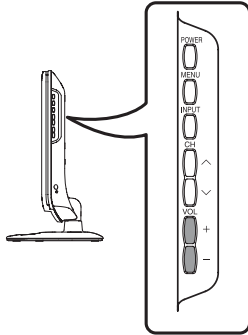

■ Using MUTE on the remote control unit

Mutes the current sound output.

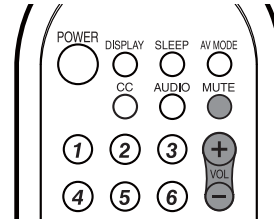

Press **MUTE**.

- will be displayed on the screen for 30 minutes, and the sound is silenced.

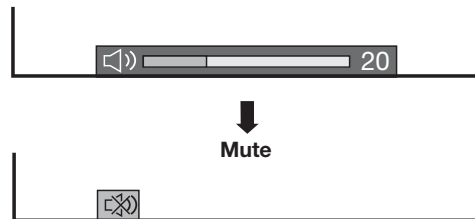

■ Using VOL +/-

- To increase the volume, press **VOL +**.
- To decrease the volume, press **VOL -**.

Volume adjustment



NOTE

- **VOL +/-** on the TV operates the same as **VOL +/-** on the remote control unit.

Volume display when headphones are plugged in.



NOTE

- Use headphones with a stereo mini-plug (ø3.5mm).
- Be sure to unplug headphones from the jack when they are not in use.
- The speakers do not output volume when headphones are plugged in.

NOTE

- Within 30 minutes of pressing **MUTE**, mute can be canceled by using one of the methods below. Mute will cancel if you press **VOL +/-** or **MUTE**.
- Mute will be canceled after 30 minutes have passed. However, the TV will not suddenly output a loud sound as the volume level is set to 0 automatically.

Watching TV

Setting MTS/SAP stereo mode

The TV has a feature that allows reception of sound other than the main audio for the program. This feature is called Multi-channel Television Sound (MTS). The TV with MTS can receive mono sound, stereo sound and Secondary Audio Programs (SAP). The SAP feature allows a TV station to broadcast other information, which could be audio in another language or something completely different like weather information.

You can enjoy Hi-Fi stereo sound or SAP broadcasts where available.

- **Stereo broadcasts**

View programs like live sporting events, shows and concerts in dynamic stereo sound.

- **SAP broadcasts**

Receive TV broadcasts in either MAIN or SAP sound. MAIN sound: The normal program soundtrack (either in mono or stereo).

SAP sound: Listen to a second language, supplementary commentary or other information. (SAP is mono sound.)

If stereo sound is difficult to hear.

- Obtain a clearer sound by manually switching to fixed mono-sound mode.

NOTE

- MTS only operates while in TV mode.

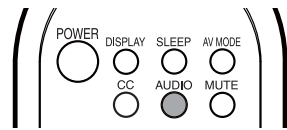

You can change MTS as shown below to match the television broadcast signal. Press **AUDIO** to toggle between audio modes.

Examples: when receiving MTS and SAP

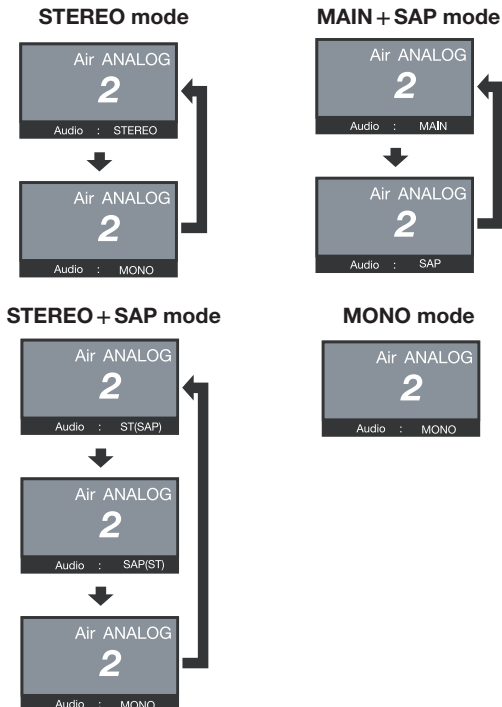

Setting Digital broadcasting audio mode

The types of audio transmitted in a digital broadcast include Language1, Language2 and Language3. In addition, it is possible for multiple audio tracks to accompany a single video track.

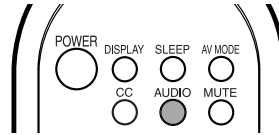

Press **AUDIO** to toggle between audio modes.

Example: when receiving Digital broadcasting

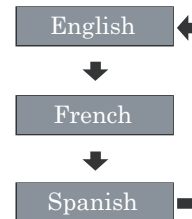

Basic adjustment settings

Menu operation buttons

Use the following buttons on the remote control to operate the menu.

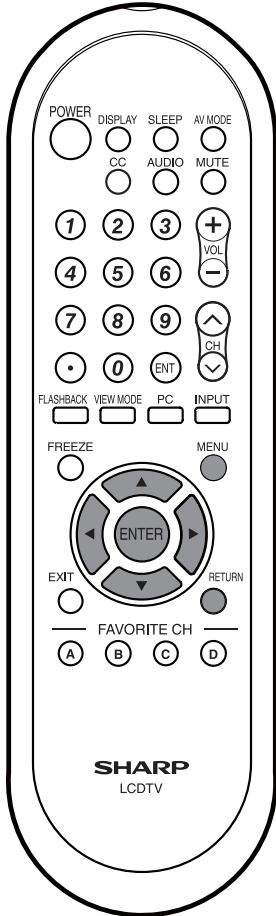

MENU: Press to open or close the menu screen.

▲/▼/◀/▶: Press to select a desired item on the screen or adjust a selected item.

ENTER: Press to go to the next step or complete the setting.

RETURN: Press to return to the previous step.

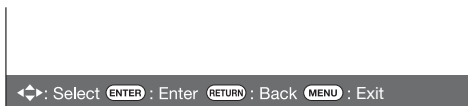

The bar above is an operational guide for the remote control. The bar will change in accordance with each menu setting screen.

On-Screen Display

Example



- ① Item displayed in yellow
 - This indicates the item currently selected.
 - Press **ENTER** to go to the adjustment screen for this item.
- ② Item in brackets
 - This indicates the current setting for the item.
- ③ Item displayed in white
 - This indicates an item can be selected.
- ④ Item displayed in gray
 - This indicates that the item cannot be selected. There are various reasons why items cannot be selected, but the main reasons are as follows:
 - Nothing is connected to the selected input terminal.
 - The function is not compatible with the current input signal.

NOTE

- Menu options differ in the selected input modes, but the operating procedures are the same.
- The screens in the operation manual are for explanation purposes (some are enlarged, others cropped) and may vary slightly from the actual screens.

Using the control panel of the main unit

You can also operate the menu with the control panel of the main unit.

Button operations on the control panel correspond to the ones on the remote control as shown below.

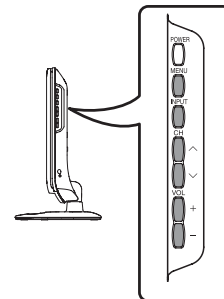

- VOL (+)/(-):** Cursor ◀/▶ on the remote control.
- CH (▲)/(▼):** Cursor ▲/▼ on the remote control.
- MENU: MENU** on the remote control.
- INPUT: ENTER** on the remote control.

Basic adjustment settings

Menu items for TV/INPUT 1/2

Picture

OPC.....	Page 27
Backlight	Page 27
Contrast	Page 27
Brightness	Page 27
Color	Page 27
Tint	Page 27
Sharpness	Page 27
Advanced	
C.M.S.....	Page 28
Color Temp.	Page 28
Film Mode	Page 28
3D-Y/C	Page 28
Monochrome	Page 28
I/P Setting.....	Page 28
Reset.....	Page 27

Audio

Treble	Page 29
Bass	Page 29
Balance.....	Page 29
Reset.....	Page 29

Power Control

No Signal Off	Page 30
No Operation Off	Page 30

Setup

EZ Setup	Page 24
CH Setup	Pages 24-25
Input Label	Page 36
Parental CTRL.....	Pages 44-49
Position.....	Page 35
Rotate	Page 34
Language.....	Page 35
Reset.....	Page 35

Option

DNR.....	Page 39
Audio Only.....	Page 39
Digital Audio.....	Page 40
Color System	Page 39
Digital Caption Setup	Page 43
Favorite CH	Page 26

Menu items for HDMI/PC-IN

Picture

OPC.....	Page 27
Backlight	Page 27
Contrast	Page 27
Brightness	Page 27
Advanced	
C.M.S.....	Page 28
Color Temp.	Page 28
Monochrome	Page 28
Reset.....	Page 27

Audio

Treble	Page 29
Bass	Page 29
Balance.....	Page 29
Reset.....	Page 29

Power Control

No Signal Off	Page 30
No Operation Off	Page 30
Power Management	Page 30

Setup

Input Label	Page 36
Parental CTRL.....	Pages 44-49
Position.....	Page 35
PC Setup	Page 33
HDMI Audio Select	Page 32
HDMI Auto View.....	Page 32
Rotate	Page 34
Language.....	Page 35
Reset.....	Page 35

Option

Audio Only	Page 39
------------------	---------

NOTE

- Some menu items may not be displayed depending on the selected input source.

Basic adjustment settings

EZ Setup

You can run EZ Setup again, even after setting up the preset channels.

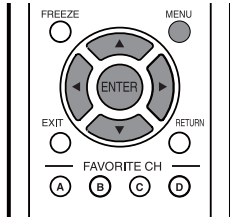

Language setting

Select from among 3 languages: English, French and Spanish.

- 1 Press **MENU** to display the MENU screen, and then press **◀/▶** to select "Setup".
- 2 Press **▲/▼** to select "EZ Setup", and then press **ENTER**.
- 3 Press **▲/▼** to select the desired language listed on the screen, and then press **ENTER**.

Antenna setting

Make sure what kind of connection is made with your TV when selecting "Air", "Cable(STD)", "Cable(HRC)" or "Cable(IRC)".

- 4 Press **▲/▼** to select "Air", "Cable(STD)", "Cable(HRC)" or "Cable(IRC)". Press **ENTER** to enter the setting.

Channel search

Channel auto search makes the TV look for all channels viewable in the set area.

- 5 **When "Air/Cable" has been selected in Antenna setting and then press ENTER again.**
Press **▲/▼** to select "Analog & Digital" to search both analog and digital broadcasts or "Analog" to search only analog broadcasts or "Digital" to search only digital broadcasts, and then press **ENTER**, and select "Yes".
 - The Channel search will start automatically.
 - To exit the Channel search screen, press **RETURN**.

- 6 Press **MENU** to exit.

NOTE

- If no channel is found, confirm the type of connection made with your TV and try EZ Setup again.

Channel Setup

If initial setup does not memorize all the channels in your region, follow the instructions below to manually memorize the channels.

Antenna setting

- 1 Press **MENU** to display the MENU screen, and then press **◀/▶** to select "Setup".
- 2 Press **▲/▼** to select "CH Setup", and then press **ENTER**.
- 3 Press **▲/▼** to select "Air/Cable", and then press **ENTER**.
- 4 Press **▲/▼** to select "Air", "Cable(STD)", "Cable(HRC)" or "Cable(IRC)", and then press **ENTER** to enter the setting.
- 5 Press **MENU** to exit.

Channel search

Channel auto search makes the TV look for all channels viewable in the set area.

- 1 Repeat steps 1 to step 4 in Antenna setting in **Channel Setup**.
- 2 Press **▲/▼** to select "CH Search", and then press **ENTER**.
- 3 **When "Air/Cable" is selected in Antenna setting:**
Press **▲/▼** to select "Analog & Digital" to search both analog and digital broadcasts or "Analog" to search only analog broadcasts or "Digital" to search only digital broadcasts, and then press **ENTER**, and select "Yes".
 - The Channel search will start automatically.
 - To exit the Channel search screen, press **RETURN**.
- 4 Press **MENU** to exit.

NOTE

- If no channel is found, confirm the type of connection made with your TV and try channel search again.

Basic adjustment settings

Channel memory setting

1 Press **MENU** to display the MENU screen, and then press **◀/▶** to select "Setup".

2 Press **▲/▼** to select "CH Setup", and then press **ENTER**.

3 Press **▲/▼** to select "CH Memory", and then press **ENTER**.

4 Press **ENTER**.

5 When viewing ANALOG broadcasts:

- 1 Press **◀/▶** to select the channel to skip, and then press **▼** to move down.
- 2 Press **◀/▶** to select "On", and then press **ENTER**.
 - On: Skips channels. (Channel selection disabled using **CH ▲/▼**.)
 - Off: Does not skip channels. (Channel selection enabled using **CH ▲/▼**.)

When viewing DIGITAL broadcasts:

- 1 Press **▲/▼** to select the channel to skip, and then press **ENTER** to select "ADD" or "ERASE".
 - ERASE: Skips channels. (Channel selection disabled using **CH ▲/▼**.)
 - ADD: Does not skip channels. (Channel selection enabled using **CH ▲/▼**.)

6 Press **MENU** to exit.

NOTE

- Make sure what kind of connection is made with your TV.

Antenna Setup Digital

In order to receive digital air broadcasts, you need a digital broadcast antenna. You can confirm the antenna configuration through the "Antenna Setup DIGITAL" screen.

If necessary, adjust the direction of the antenna to obtain the maximum signal strength.

Signal Strength

1 Press **MENU** to display the MENU screen, and then press **◀/▶** to select "Setup".

2 Press **▲/▼** to select "CH Setup", and then press **ENTER**.

3 Press **▲/▼** to select "Antenna Setup Digital", and then press **ENTER**.

4 Press **▲/▼** to select "SIGNAL STRENGTH".

- The signal strength of DIGITAL channel is displayed. The signal information is based on the current channel.

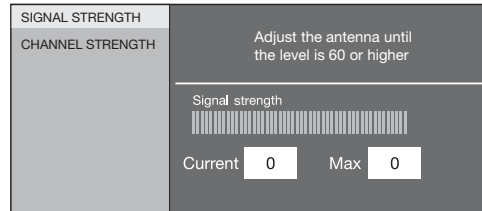

5 Press **MENU** to exit.

NOTE

- This "SIGNAL STRENGTH" display is a standard to decide the best direction of the antenna, and cannot to guarantee image/voice.

Channel Strength

1 Press **MENU** to display the MENU screen, and then press **◀/▶** to select "Setup".

2 Press **▲/▼** to select "CH Setup", and then press **ENTER**.

3 Press **▲/▼** to select "Antenna Setup Digital", and then press **ENTER**.

4 Press **▲/▼** to select "CHANNEL STRENGTH", and then press **ENTER**.

- Input the 2-digit channel number to check the strength of the selected channel.
- Make sure the appropriate signal strength of each channel received is obtained.

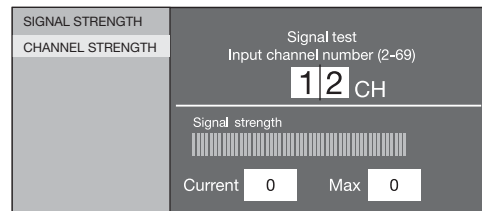

5 Press **MENU** to exit.

Basic adjustment settings

Favorite channel setting

This function allows you to program 4 favorite channels, in 4 different categories. By setting the favorite channels in advance, you can select your favorite channels easily.

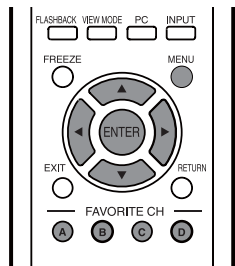

Registering your favorite channel

- 1 Select the channel you want to register as a favorite channel.
- 2 Press **MENU** to display the MENU screen, and then press **←/→** to select "Option".
- 3 Press **▲/▼** to select "Favorite CH", and then press **ENTER**.
- 4 Press **▲/▼** to select "Register", then press **ENTER**.
- 5 Press **▲/▼/ ←/→** to select the position in the category, and then press **ENTER** to register.

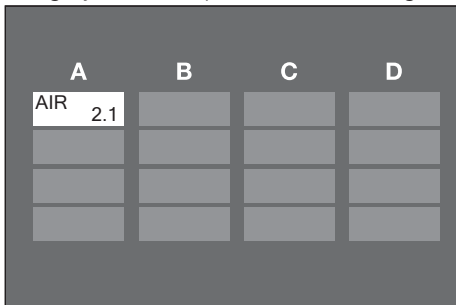

- 6 Press **MENU** to exit.

Deleting a favorite channel

- 1 Repeat steps 2 and 3 in **Registering your favorite channel**.
- 2 Press **▲/▼** to select "1 Data Clear", and then press **ENTER**.
 - To delete all the favorite channels, select "All Data Clear", and then skip to step 4.
- 3 Press **▲/▼/ ←/→** to select the channel you want to delete, and then press **ENTER**.

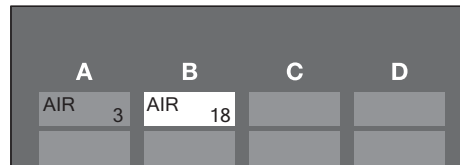

- 4 Press **←/→** to select "Yes", and then press **ENTER**.

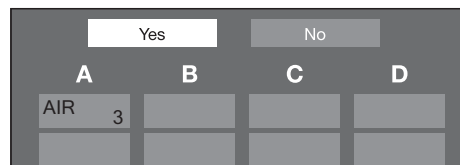

- 5 Press **MENU** to exit.

Basic adjustment settings

Picture adjustments

Adjusts the picture to your preference with the following picture settings.

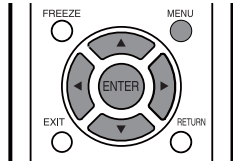

- 1 Press **MENU** to display the MENU screen, and then press **◀/▶** to select "Picture".
- 2 Press **▲/▼** to select a specific adjustment item.
- 3 Press **◀/▶** to adjust the item to the desired level.
- 4 Press **MENU** to exit.

NOTE

- For resetting all Picture adjustment items to the factory preset values, press **▲/▼** to select "Reset", press **ENTER**, press **▲/▼** to select "Yes", and then press **ENTER**.



Selected item	◀ button	▶ button
Backlight	The screen dims	The screen brightens
Contrast	For less contrast	For more contrast
Brightness	For less brightness	For more brightness
Color	For less color intensity	For more color intensity
Tint	Skin tones become purplish	Skin tones become greenish
Sharpness	For less sharpness	For more sharpness

NOTE

- Select "Advanced" and then press **ENTER** to set "C.M.S.", "Color Temp.", "Film Mode", "3D-Y/C" or "Monochrome", "I/P Setting", See page 28.

OPC (Optical Picture Control) setting

You can set the TV to automatically adjust the screen to suitable backlight brightness according to the lighting conditions.

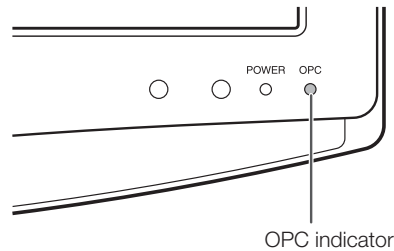

Selected item	Description
On (Display)	Displays the OPC effect on the screen while adjusting the brightness of the screen.
On	Automatically adjusts
Off	The brightness is fixed at the value set in "Backlight" (See this page).

OPC indicator

Light off	"Off" is selected in the OPC setting.
Lighted (Green)	"On" or "On (Display)" is selected in the OPC setting.

NOTE

- Make sure no object obstructs the OPC sensor, which could affect its ability to sense surrounding light.

Basic adjustment settings

Advanced picture settings

Advanced setting enables you to set the picture adjustment in more detail. There are four options you can choose from.

C.M.S. (Color Management System)

Color tone is managed using the six-color adjustment setting.

1 Press **MENU** and the MENU screen displays.

2 Press **◀/▶** to select "Picture".

3 Press **▲/▼** to select "Advanced", and then press **ENTER**.

4 Press **▲/▼** to select a specific adjustment item among "C.M.S.-Hue", "C.M.S.-Saturation" and "C.M.S.-Value", and then press **ENTER**.

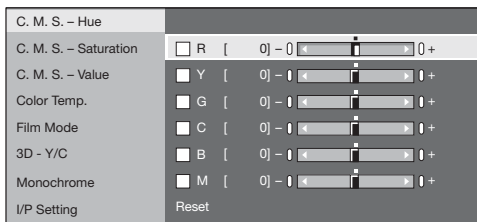

5 Press **◀/▶** to adjust the item to your desired position.

NOTE

- For resetting all adjustment items to factory preset values, press **▲/▼** to select "Reset", and then press **ENTER**.

Selected item	Description
C.M.S-Hue	This is a standard to adjust the color either more reddish or more bluish in tone.
C.M.S-Saturation	Increases or decreases the saturation of a selected color
C.M.S-Value	A higher value makes the image brighter. A lower value makes the image darker

Color Temperature

For a better white balance, use color temperature correction.

Selected item	Description
High Mid-High Middle Mid-Low Low	White with Bluish tone ↑ ↓ White with Reddish tone

Film Mode

Automatically detects a film-based source (originally encoded at 24/25 frames/second, depending on the vertical frequency), analyzes it then recreates each still film frame for high-definition picture quality.

Selected item	Description
On	Detects, analyzes, converts film source
Off	Normal viewing mode

3D-Y/C

Provides high quality images with minimal dot crawl and cross color noise.

Selected item	Description
Standard	Normal adjustment
Fast	For movie image
Slow	For still image
Off	For Game Mode

NOTE

- 3D-Y/C is not selectable depending on the input signal type.
- 3D-Y/C may not operate depending on the input signal type or noisy input signal.

Monochrome

For viewing a video in monochrome.

Selected item	Description
On	For viewing in monochrome
Off	Normal color

I/P Setting

Adjusting the image and input signal can give you a more beautiful picture.

1 Press **MENU** to display the MENU screen, and then press **◀/▶** to select "Picture".

2 Press **▲/▼** to select "Advanced", and then press **ENTER**.

3 Press **▲/▼** to select "I/P Setting", and then press **ENTER**.

4 Press **▲/▼** to select "Fast" or "Slow", and then press **ENTER**.

Selected item	Description
Fast	Suitable for fast-moving images
Slow	Suitable for smooth images with low amounts of flickers

Basic adjustment settings

Sound adjustment

You can adjust the sound quality to your preference with the following settings.

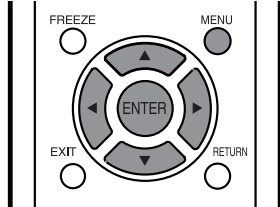

- 1 Press **MENU** to display the MENU screen, and then press ◀/▶ to select "Audio".

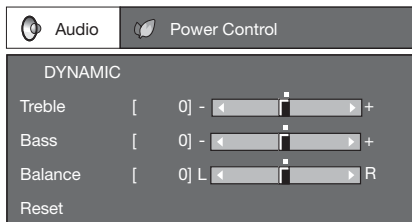

- 2 Press ▲/▼ to select a specific adjustment item.

- 3 Press ◀/▶ to adjust the item to the desired level.

Selected item	◀ button	▶ button
Treble	For weaker treble	For stronger treble
Bass	For weaker bass	For stronger bass
Balance	Decrease audio from the right speaker	Decrease audio from the left speaker

- 4 Press **MENU** to exit.

NOTE

- For resetting all Audio adjustment items to the factory preset values, press ▲/▼ to select "Reset", press **ENTER**, press ▲/▼ to select "Yes", and then press **ENTER**.

Basic adjustment settings

Power Control

Power control setting allows you to save energy.

No signal off

When set to "Enable", the power will automatically shut down if there is no signal for 15 minutes.

1 Press **MENU** to display the MENU screen, and then press **◀/▶** to select "Power Control".

2 Press **▲/▼** to select "No Signal Off", and then press **ENTER**.

3 Press **▲/▼** to select "Enable", and then press **ENTER**.

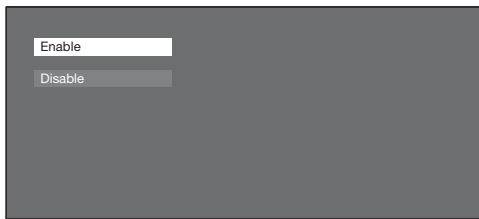

- Five minutes before the power shuts down, the remaining time displays every minute.

4 Press **MENU** to exit.

NOTE

- "Disable" is the factory preset value.
- When a TV program finishes, this function may not operate.

No operation off

The power will automatically shut down if there is no operation for 30 minutes or 3 hours after setting.

1 Press **MENU** to display the MENU screen, and then press **◀/▶** to select "Power Control".

2 Press **▲/▼** to select "No Operation Off", and then press **ENTER**.

3 Press **▲/▼** to select "30min" or "3Hour", and then press **ENTER**.

- Five minutes before the power shuts down, the remaining time displays every minute.

4 Press **MENU** to exit.

NOTE

- "Disable" is the factory preset value.

Power Management

You can set the TV to automatically power off when no image is displayed on PC.

1 Press **MENU** and the MENU screen displays.

2 Press **◀/▶** to select "Power Control", and then press **ENTER**.

- Power control menu displays.

3 Press **▲/▼** to select "Power Management", and then press **ENTER**.

4 Press **▲/▼** to select "Mode 1" or "Mode 2", and then press **ENTER**.

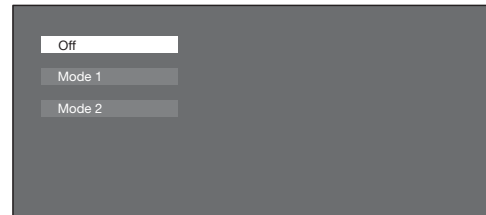

Selected item	Description
Off	<ul style="list-style-type: none"> • No power management • Factory preset value.
Mode 1	<ul style="list-style-type: none"> • If no signal inputs for approximately 8 minutes, the power shuts down. • Even if you start using the PC and the signal inputs again, the TV stays off. • The TV turns on again by pressing POWER. (See page 17.)
Mode 2	<ul style="list-style-type: none"> • If no signal inputs for approximately 8 seconds, the power shuts down. • When you start using the PC and the signal inputs again, the TV turns on. • The TV turns on again by pressing POWER. (See page 17.)

NOTE

- If you turn off the power by disconnecting AC cord when setting "Mode 2" in power management, the TV may not function properly after turning the power on again. In such case, press **POWER** on the remote control unit.
- Pressing **POWER** on the display will have the same result.
- In Mode1, five minutes before the preset of time expires, the remaining time displays each minute.

Using external equipment

Displaying an external equipment image

To view external source images, select the input source from **INPUT** on the remote control unit or on the TV.

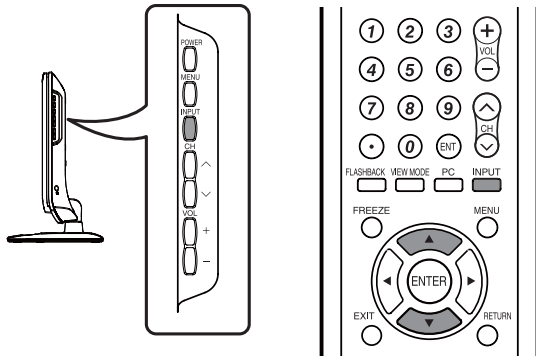

1

Press **INPUT**.

- A list of selectable sources appears.

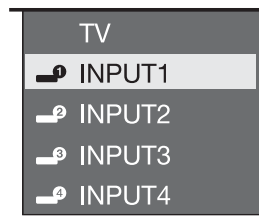

2

Press **INPUT** again to select the input source.

- An image from the selected source automatically displays.
- Each time **INPUT** is pressed, the input source toggles.
- You can also select the input source by pressing ▲/▼.

NOTE

- See pages 15 and 16 for external equipment connection.

Using external equipment

Displaying an image from HDMI equipment

- 1** To watch an HDMI equipment image, select "INPUT3" from "INPUT SOURCE" menu using **INPUT** on the remote control unit or on the TV.

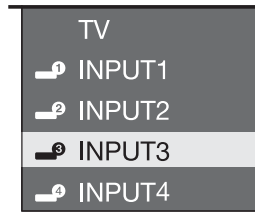

- 2** Press **MENU** to display the MENU screen, and then press **◀/▶** to select "Setup".

- 3** Press **▲/▼** to select "HDMI Audio Select" or "HDMI Auto View", and then press **ENTER**.

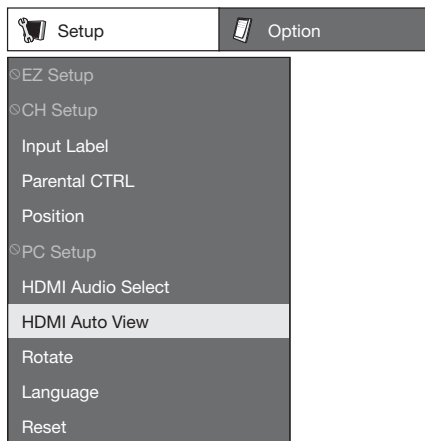

- 4** Press **▲/▼** to select the desired item and press **ENTER**.

HDMI Setup items	Selectable items	Description
Audio Select	Digital Analog	Select "Digital" for an audio signal via the HDMI terminal. Select "Analog" for an audio signal via the R-AUDIO -L terminal.
Auto View	Enable Disable	Set whether or not to use View Mode based on signal recognition, including an HDMI signal.

- 5** Press **MENU** to exit.

NOTE

- Refer to your external equipment operation manual for the signal type.

Useful adjustment settings

Auto Sync. Adjustment (for Analog PC input mode only)

This function enables the screen to be automatically adjusted to its best possible condition when the analog terminals of the TV and PC are connected with a commercially available RGB cable, etc.

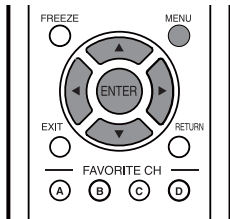

- 1 Press **MENU** and the MENU screen displays.
- 2 Press **◀/▶** to select "Setup".
- 3 Press **▲/▼** to select "PC Setup", and then press **ENTER**.
- 4 Press **▲/▼** to select "Auto Sync.", and then press **ENTER**.
- 5 Press **▲/▼** to select "Yes", and then press **ENTER**.
 - Auto Sync. starts.
- 6 Press **MENU** to exit.



NOTE

- Auto Sync. is likely to succeed when an input PC image has wide vertical stripes (e.g. pattern with high contrast stripes, or cross-hatched). It may fail when an input PC image is solid (low contrast).
- Be sure to connect the PC to the TV and switch it on before starting Auto Sync.

Fine Sync. Adjustment

Ordinarily you can easily adjust the picture as necessary to change image position using Auto Sync. In some cases, however, manual adjustment is needed to optimise the image.

- 1 Press **MENU** and the MENU screen displays.
- 2 Press **◀/▶** to select "Setup".
- 3 Press **▲/▼** to select "PC Setup", and then press **ENTER**.
- 4 Press **▲/▼** to select "Fine Sync.", and then press **ENTER**.
- 5 Press **▲/▼** to select "Yes", and then press **ENTER**.
- 6 Press **▲/▼** to select a specific adjustment item among "H-Pos.", "V-Pos.", "Clock" and "Phase".

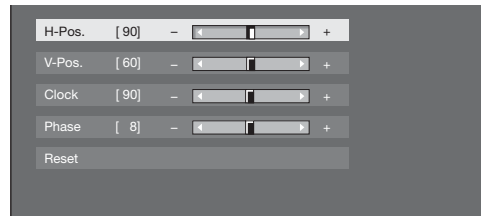

Selected item	Description
H-Pos.	Centres the image by moving it to the left or right.
V-Pos.	Centres the image by moving it up or down.
Clock	Adjusts when the image flickers with vertical stripes.
Phase	Adjusts when characters have low contrast or when the image flickers.

- 7 Press **◀/▶** to adjust the item to your desired position.
- 8 Press **MENU** to exit.

NOTE

- For resetting all adjustment items to the factory preset values, press **▲/▼** to select "Reset", and then press **ENTER**.
- Images may not be displayed properly depending on the settings and/or input signals.

Useful adjustment settings

Picture Rotate

You can set the orientation of the picture.

Setting the Rotate on the MENU screen.

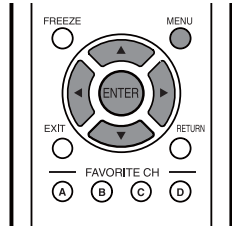

1 Press **MENU** to display the MENU screen, and then press **◀/▶** to select "Setup".

2 Press **▲/▼** to select "Rotate", and then press **ENTER**.

2 Press **▲/▼** to select the desired mode, and then press **ENTER**.



4 Press **MENU** to exit.

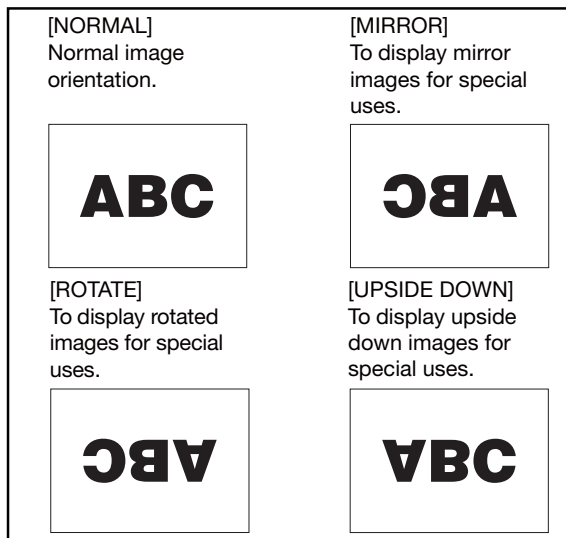

Useful adjustment settings

Language setting

You can also select a language from the Setup menu. Select from among 3 languages: English, French and Spanish.

- 1 Press **MENU** to display the MENU screen, and then press ◀▶ to select "Setup".
- 2 Press ▲/▼ to select "Language", and then press **ENTER**.
- 3 Press ▲/▼ to select the desired language listed on the screen, and then press **ENTER**.
- 4 Press **MENU** to exit.

Image position

For adjusting a picture's horizontal and vertical position.

- 1 Press **MENU** to display the MENU screen, and then press ◀▶ to select "Setup".
- 2 Press ▲/▼ to select "Position", and then press **ENTER**.
- 3 Press ▲/▼ to select "H-Pos." or "V-Pos.".

Example

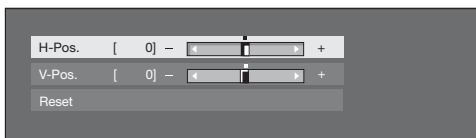

Selected item	Description
H-Pos.	Centers the image by moving it to the left or right.
V-Pos.	Centers the image by moving it up or down.

- 4 Press ◀▶ to adjust the item to the desired position.
- 5 Press **MENU** to exit.

NOTE

- For resetting adjustments to the factory preset values, press ▲/▼ to select "Reset", and then press **ENTER**.
- When connecting a PC to the HDMI terminal, the image position will be automatically adjusted. It cannot be manually adjusted.
- The screen position variable ranges depend on the ViewMode, signal source or the signal type.
- **Adjustments are stored separately according to input source.**

Reset

If complex adjustments are made and the settings cannot be restored to normal, you can reset the settings to the factory preset values.

- 1 Press **MENU** to display the MENU screen, and then press ◀▶ to select "Setup".
- 2 Press ▲/▼ to select "Reset", and then press **ENTER**.
 - If you already set the Secret No., input the 4-digit secret number here. See page 44 for setting a secret number.
 - "Return to factory pre-setting" displays on the screen.
- 3 Press ▲/▼ to select "Yes", and then press **ENTER**.
 - The TV will reset automatically.

NOTE

- The AV Mode will be set to "DYNAMIC".
- The Program Setup settings will not be changed.
- The Language settings will not be changed.

Useful adjustment settings

Input Label

Lets you set the input terminal displayed when using the INPUT SOURCE menu or channel display.

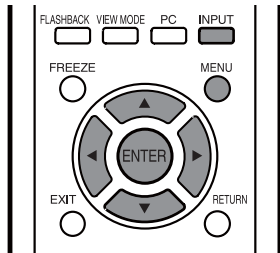

- 1 Press **INPUT** to select the desired input source.
- 2 Press **MENU** to display the MENU screen, and then press **◀▶** to select "Setup".
- 3 Press **▲/▼** to select "Input Label", and then press **ENTER**.
- 4 Press **▲/▼/◀▶** to select the new name for the input mode, and then press **ENTER**.

Example

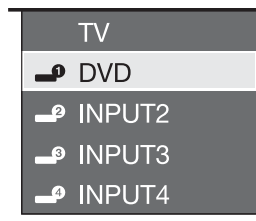

- 5 Press **MENU** to exit.

NOTE

- You cannot change labels if the INPUT SOURCE is TV.

Sleep Timer

Allows you to set a time when the TV automatically switches to standby.

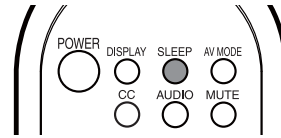

- 1 Press **SLEEP**.
 - Remaining time displays when sleep timer has been set.

Sleep Timer: Remaining 30 min.

- 2 Each time you press **SLEEP**, the remaining time switches as shown below.

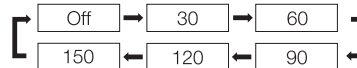

NOTE

- When the time has been set, countdown automatically starts.
- Five minutes before the preset of time expires, the remaining time displays each minute.
- Select "Off" by pressing **SLEEP** to cancel the sleep timer.

Useful adjustment settings

View Mode for 4:3 Programs

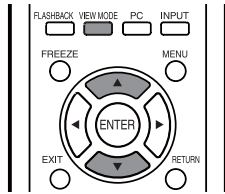

1 Press **VIEW MODE**.

- The View Mode menu displays.
- The menu lists the View Mode options selectable for the type of video signal currently being received.

Example

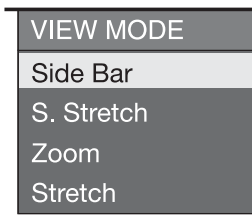

2 Press **VIEW MODE** or **▲/▼** while the View Mode menu is displayed to select a desired item on the menu.

- You can sequentially select a View Mode that has its own aspect ratio.

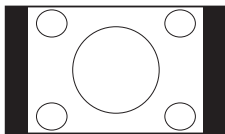

Side Bar:

Suitable for viewing conventional 4:3 programs in their normal format.

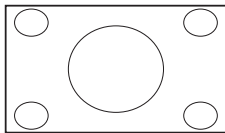

S.Stretch (Smart stretch):

Suitable for stretching 4:3 programs to fill the screen.

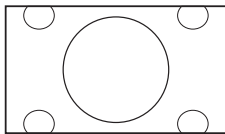

Zoom:

Suitable for viewing wide-screen 2.35:1 anamorphic DVDs in full screen.

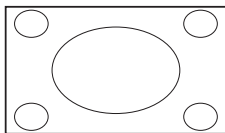

Stretch:

This mode is useful for 1.78:1 DVDs.
When viewing 1.85:1 DVDs, stretch mode will still show very thin black bands at the top and bottom of the screen.

NOTE

- When the CLOSED CAPTION mode is set to "CC1", "CC2", "T1" or "T2", "ZOOM" cannot be set for "VIEW MODE".

View Mode for HD Programs

Stretch mode is available for HD programs. Suitable for viewing wide-screen 1.78:1 aspect-ratio programs. When viewing 1.85:1 programs, the stretch mode will still show very thin black bands at the top and bottom of the screen.

Useful adjustment settings

View Mode (for PC input mode)

You can select the screen size.

NOTE

- Connect the PC before making adjustments. (See page 16.)
- Selectable screen size may vary with input signal type.

1

Press **VIEW MODE**.

- The View Mode menu displays.

Example

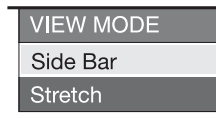

(Input 4:3 signal)

Example

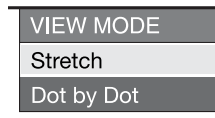

(Input 16:9 signal)

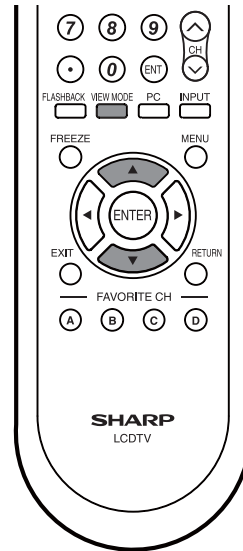

2

Press **VIEW MODE** or **▲/▼** while the View Mode menu is displayed to select a desired item on the menu.

Example: Screen size images

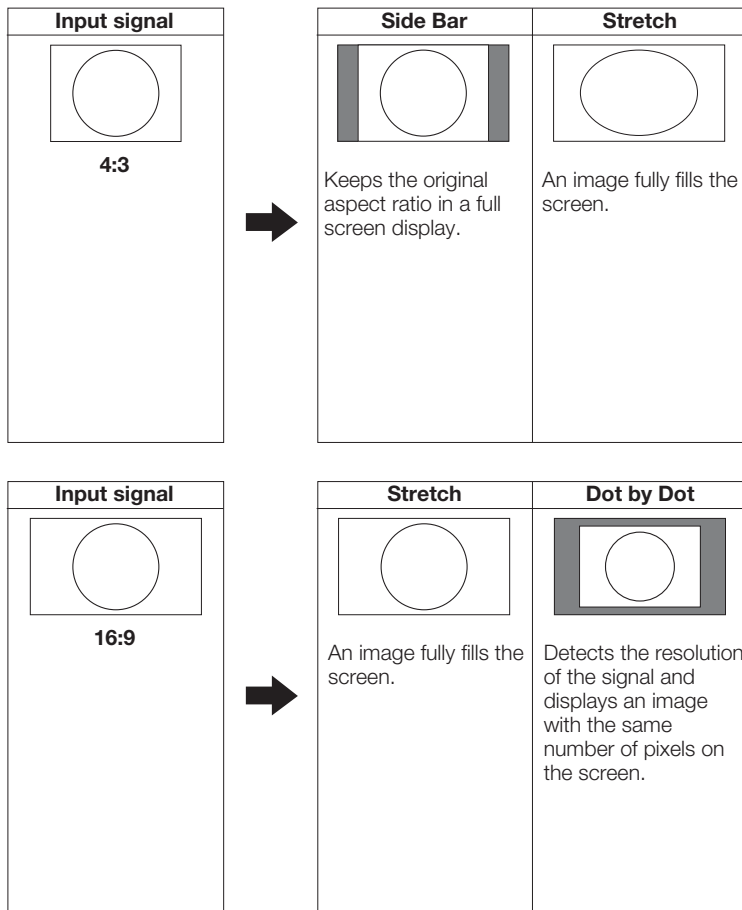

Useful adjustment settings

Advanced Option settings

Perform the following steps to set the Option menu items on this page.

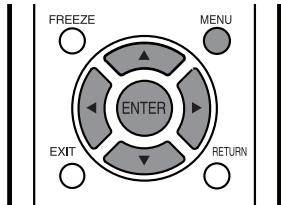

- 1 Press **MENU** to display the MENU screen, and then press **◀/▶** to select "Option".
- 2 Press **▲/▼** to select a specific adjustment item, and then press **ENTER**.
- 3 Press **▲/▼** (or **◀/▶**) to select the desired setting, and then press **ENTER**.
- 4 Press **MENU** to exit.

DNR (Digital Noise Reduction)

Produces a clearer video image.

- 1 Press **MENU** to display the MENU screen, and then press **◀/▶** to select "Option".
- 2 Press **▲/▼** to select "DNR", and then press **ENTER**.
- 3 Press **▲/▼** to select the desired level, and then press **ENTER**.



Audio Only

When listening to music from a music program, you can set the screen off and enjoy audio only.

Selected item	Description
On	Audio is output without screen image.
Off	Both screen images and audio are output.

NOTE

- The screen image will return to normal when a button (except those for audio adjustment, such as **VOL**, **MUTE**, **AUDIO**) is pressed.

Color System

Select the video signal system compatible with your equipment from the list below;

- AUTO
- NTSC
- PAL-M
- PAL-N

NOTE

- "Color System" can only be set for the INPUT 2 .

Useful adjustment settings

Digital Audio

This feature allows you to select the Primary and Secondary language and as well the type of audio transmitted in a digital broadcast. If the viewing channel is analog channel, Digital Audio cannot be selected.

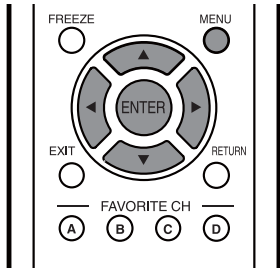

1 Press **MENU** to display the MENU screen, and then press **◀/▶** to select "Option".

2 Press **▲/▼** to select "Digital Audio", and press **ENTER** to access the DIGITAL AUDIO screen.

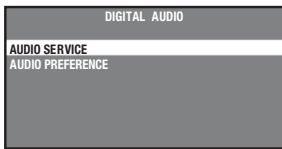

3 Press **▲/▼** to select "AUDIO SERVICE" or "AUDIO PREFERENCE", and press **ENTER** to access AUDIO SERVICE or AUDIO PREFERENCE screen.

AUDIO SERVICE

Press **▲/▼** to select the "AUDIO SERVICE", Six kinds of audio service are available to be selected. However, selectable service depends on the program content.

If a program has three services, audio service toggles like below:

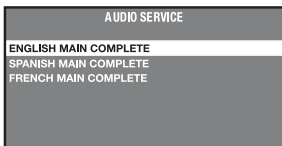

AUDIO PREFERENCE

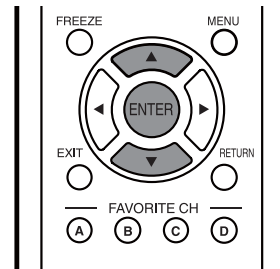

1 Press **▲/▼** to select "PRIMARY LANGUAGE" or "SECONDARY LANGUAGE".

2 Press **ENTER** to change the setting.
PRIMARY LANGUAGE



SECONDARY LANGUAGE

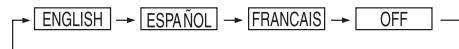

NOTE

- The language which is selected in Primary Language will not appear in Secondary Language selection mode.

Useful adjustment settings

AV MODE

AV MODE gives you 7 viewing options to choose from to best match the surrounding environment of the TV, which can vary due to factors like room brightness, type of program watched or the type of image input from external equipment.

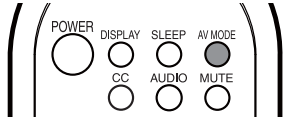

- 1 Press **AV MODE**.
 - Current AV MODE displays.
- 2 Press **AV MODE** again before the mode displayed on the screen disappears.
 - The mode changes as shown below.

TV INPUT1/2 mode (Example)

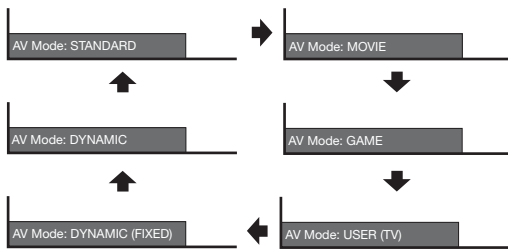

INPUT3 mode (Example)

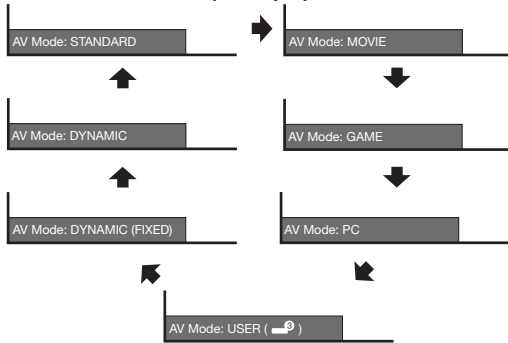

INPUT4 (PC) mode (Example)

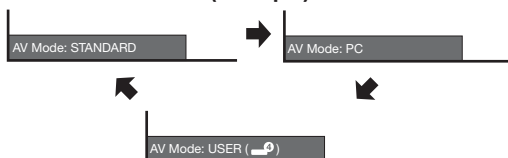

NOTE

- You can select a different AV MODE item for each input mode. (For example, select STANDARD for TV input and DYNAMIC for INPUT 1.)

Selected item	Description
STANDARD	For a highly defined image in a normal lighting
MOVIE	For a movie
GAME	Lowers image brightness for easier viewing
PC	For PC (Available only with inputting RGB signal.)
USER	Allows the user to customize settings as desired. You can set the mode for each input source.
DYNAMIC (FIXED)	Changes the image and sound settings to the factory preset values. No adjustments are allowed.
DYNAMIC	For a clear-cut image emphasizing high contrast, useful for sports viewing

Input Signal (for Analog PC input mode only)

Some input signals may have to be registered manually to display properly.

The pair of input signals (resolutions) in the list below are not distinguishable when received. In such case, you have to set the correct signal manually. After setting once, it will display when the same signal (resolution) is input again.

1024 × 768	1280 × 768	1360 × 768
------------	------------	------------

NOTE

- You can only select the "Input Signal" on the Setup menu when receiving one of the 2 input signals listed above.

- 1 Press **MENU** to display the MENU screen, and then press **◀▶** to select "Setup".
- 2 Press **▲/▼** to select "PC Setup", and then press **ENTER**.
- 3 Press **▲/▼** to select "Input Signal", and then press **ENTER**.
- 4 Press **▲/▼** to select the desired input signal on the display.
- 5 Press **MENU** to exit.

Useful adjustment settings

Closed Captions and Digital Closed Captions

Your TV is equipped with an internal Closed Caption decoder. It allows you to view conversations, narration and sound effects as subtitles on your TV. Closed Captions are available on some TV programs and on some VHS home video tapes at the discretion of the program provider.

Digital Closed Caption service is a new caption service available only on digital TV programs (also at the discretion of the service provider). It is a more flexible system than the original Closed Caption system, because it allows for a variety of caption sizes and font styles. When the Digital Closed Caption service is in use, it will be indicated by the appearance of a 3-letter abbreviation that also indicates the language of the Digital Closed Captions: ENG (English), SPA (Spanish), FRA (French) or other language codes.

Not all programs and VHS videotapes offer closed captions. Please look for the "CC" symbol to ensure that captions will be shown.

In the Closed Caption system, there can be more than one caption service provided. Each is identified by its own number. The "CC1" and "CC2" services display subtitles of TV programs superimposed over the program's picture.

In the Closed Caption system, the "TEXT1" or "TEXT2" services display text that is unrelated to the program being viewed (e.g., weather or news). These services are also superimposed over the program currently being viewed.

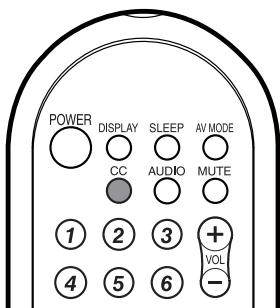

1

Press **CC**.

- This will present the Closed Caption information display.

2

Press **CC** while the Closed Caption information is still on the screen.

- Press repeatedly until you select the desired closed caption service.

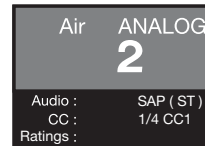

Closed Caption information

- Depending on the number of caption services in the signal being received, you will see information such as 1/4 displayed.

1/4 means "the CC1 services" is selected.

Example:

If a program has three services (Digital DTVCC1), CC1 and TEXT1), the closed caption display will toggle in this sequence:

DTVCC1 → **CC1** → **CC2** → **TEXT1** → **TEXT2** → **OFF**

- The CC button keeps a record of the last service selected in its memory. If the last closed caption mode (e.g. DTVCC1) you selected is not available for the next program, or on another channel, the closed caption service that is available is automatically selected, and this service appears in parentheses, e.g. "CC1". Closed Caption services that appear in parentheses will not be stored in the CC button's memory as your last selected service. Only services that you have selected with the CC button are stored.

Examples:

In a case where there are two closed caption services provided, (for instance, Digital DTVCC1 and CC1), and Digital DTVCC1 is displayed as your current selection, if Digital DTVCC1 is not broadcast for the next program, the other closed caption service, CC1, will be displayed in parentheses.

A closed caption service appears in parentheses because the service you selected is not available and a different service is displayed on your screen. "CC1" is displayed instead of "DTVCC1".

NOTE

- See page 43 for detailed closed caption settings.
- Four kinds of closed caption service (CC1, CC2, TEXT1, TEXT2) are potentially available, but a broadcast may contain none or only some of these services at the discretion of the program provider.

Useful adjustment settings

Digital Caption Setup

When viewing a digital channel

Setting the CLOSED CAPTION on the Menu screen

1 Press **MENU** to display the MENU screen, and then press **◀/▶** to select "Option".

2 Press **▲/▼** to select "Digital Caption Setup", and then press **ENTER**.



(CLOSED CAPTION screen)

3 Press **▲/▼** to select "CLOSED CAPTION SERVICE", and press **ENTER**, and then press **ENTER** continually to toggle the CLOSED CAPTION services like below:

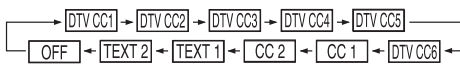

Setting the CLOSED CAPTION Preference

1 Press **MENU** to display the MENU screen, and then press **◀/▶** to select "Option".

2 Press **▲/▼** to select "Digital Caption Setup", and then press **ENTER**.

3 Press **▲/▼** to select "CLOSED CAPTION PREFERENCE", and then press **ENTER**.

4 Press **▲/▼** to select a specific adjustment item.

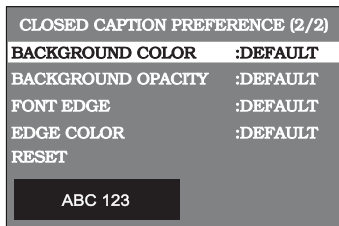
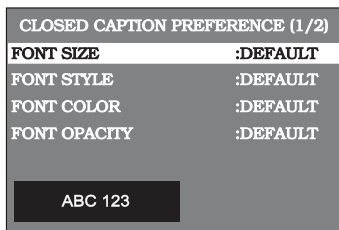

• You can adjust 9 items here; they are,

- ① "FONT SIZE",
- ② "FONT STYLE",
- ③ "FONT COLOR",
- ④ "FONT OPACITY",
- ⑤ "BACKGROUND COLOR",
- ⑥ "BACKGROUND OPACITY",
- ⑦ "FONT EDGE",
- ⑧ "EDGE COLOR" and
- ⑨ "RESET".

5 Press **ENTER** to select the desired parameter.

6 Press **MENU** to exit.

Selectable items available for "Font Style".

Selected item	Description
Default	The font specified by broadcasting station or default font.
Type 0	Proportional font used in the MENU screen.
Type 1	Monospaced with serifs.
Type 2	Proportionally spaced with serifs.
Type 3	Monospaced without serifs.
Type 4	Proportionally spaced without serifs.
Type 5	Casual font type.
Type 6	Cursive font type.
Type 7	Small capitals.

Directly setting the CLOSED CAPTION

Press **CC** to change the setting.

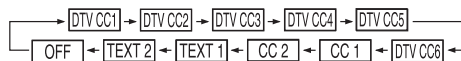

NOTE

- Closed Caption may malfunction (white blocks, strange characters, etc.) if signal conditions are poor or if there are problems at the broadcast source. This does not necessarily indicate a problem with your TV.
- If any button is pressed to call up the ON SCREEN DISPLAY while viewing a CLOSED CAPTION broadcast, the closed captions will disappear momentarily.
- In CC1, CC2, TEXT1, TEXT2, the font style is fixed.
- There is a case which doesn't become the font specified by the contents of the broadcasting.
- If the background of the character is transparent, and the character of closed_caption is hard to see, the color of the background proposes the selection of solid.

Useful adjustment settings

Secret number setting for parental control

Allows you to use a secret number to protect certain settings from being accidentally changed.

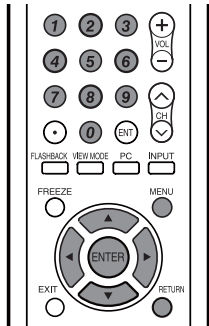

IMPORTANT:

Three conditions must be met to enable the V-Chip (see pages 46 to 49):

- 1 Secret No. is registered.
- 2 V-Chip/V-Chip (DTV Only) settings have been made.
- 3 "Status" is set to "On".

Setting a secret number

1 Press **MENU** to display the MENU screen, and then press **◀/▶** to select "Setup".

2 Press **▲/▼** to select "Parental CTRL", and then press **ENTER**.

3 Press **▲/▼** to select "Secret No.", and then press **ENTER**.



4 Select "New Secret No.", and then press **ENTER**.
Input the new 4-digit secret number by using **0–9**.

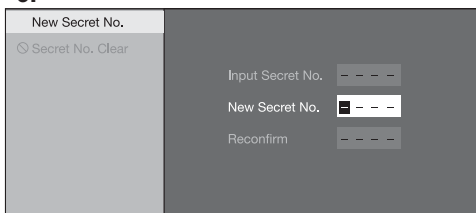

5 Input the same 4-digit number on the "Reconfirm" screen as in step 4 to confirm.

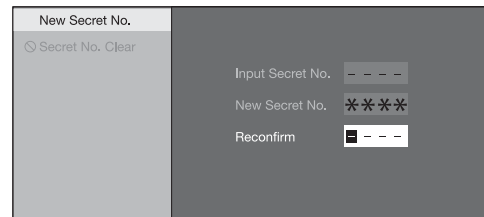

6 Press **RETURN** to start configuring the V-Chip settings. (See pages 46 and 49 for details.)

7 Press **MENU** to exit.

Setting parental control status

Used to enable or disable the parental control function.

1 Repeat steps 1 and 2 in **Setting a secret number**.

- The secret number setting menu displays.

2 Input the 4-digit secret number by using **0–9**.

3 Press **▲/▼** to select "Status", and then press **ENTER**.

4 Press **▲/▼** to select "On" or "Off", and then press **ENTER**.

- Select "On" to enable and "Off" to disable Parental CTRL.

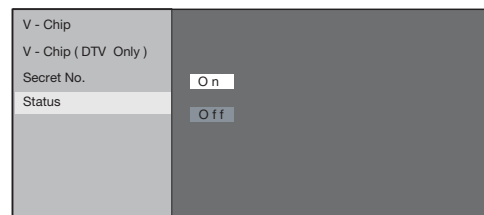

5 Press **MENU** to exit.

NOTE

- You can skip steps 1 and 2 above while in the Parental CTRL screen.
- The "V-Chip (DTV Only)" will only be selectable when a new rating system can be downloaded via digital broadcasting in the U.S.

Useful adjustment settings

Changing the secret number

Allows you to change your current secret number.

- 1 Repeat steps 1 and 2 in **Setting a secret number**.
 - The secret number setting menu displays.
- 2 Input the 4-digit secret number by using **0-9**.
- 3 Press **▲/▼** to select "Secret No.", and then press **ENTER**.
- 4 Press **▲/▼** to select "New Secret No.", and then press **ENTER**.

- 5 Input the old 4-digit secret number by using **0-9**.

New Secret No.	
Secret No. Clear	
Input Secret No.	■ - - -
New Secret No.	- - - -
Reconfirm	- - - -

- 6 Input the new 4-digit secret number by using **0-9**.

New Secret No.	
Secret No. Clear	
Input Secret No.	- - - -
New Secret No.	■ - - -
Reconfirm	- - - -

- 7 Input the same 4-digit number on the "Reconfirm" screen as in step 6 to confirm.

New Secret No.	
Secret No. Clear	
Input Secret No.	- - - -
New Secret No.	* * * *
Reconfirm	■ - - -

- 8 Press **MENU** to exit.

Clearing the secret number

Allows you to clear your secret number.

- 1 Repeat steps 1 to 2 in **Setting a secret number**.
 - The secret number setting menu displays.
- 2 Input the 4-digit secret number by using **0-9**.
- 3 Press **▲/▼** to select "Secret No.", and then press **ENTER**.
- 4 Press **▲/▼** to select "Secret No. Clear", and then press **ENTER**.

- 5 Press **▲/▼** to select "Yes", and then press **ENTER**.

New Secret No.	
Secret No. Clear	
Yes	
No	

- 6 Press **MENU** to exit.

NOTE

- See page 44 for re-registering a new secret number after being cleared.
- **As a precautionary measure, make a note of your secret number and keep it in a familiar place.**
- If the secret number is cleared, the Status setting automatically sets to "Off". "V-Chip" and "Status" will not be selectable from the menu.

Useful adjustment settings

Parental control (setting V-CHIP level)

V-CHIP is an electronic filtering device built into your TV. This tool gives parents a great degree of control over broadcasts accessed by their children. It allows parents to select programs judged suitable for child viewing while blocking ones judged not suitable. It does so automatically once you activate the V-CHIP feature in your TV.

“V-Chip” and “Status” will not be selectable from the menu if you do not first configure your secret number. (See page 44 for Secret number setting for parental control.)

- The U.S. has two rating systems for viewing content: TV Parental Guidelines and movie ratings.
- The TV Parental Guidelines work in conjunction with the V-CHIP to help parents screen out inappropriate television shows from their children.
- Movie ratings are used for original movies rated by the Motion Picture Association of America (MPAA) as watched on cable TV and not edited for television. The V-CHIP can also be set to block MPAA-rated movies.

Voluntary movie rating system (MPAA)

Rating		Description
Age	G	General audiences. All ages admitted.
	PG	Parental guidance suggested. Some material may not be suitable for children.
	PG-13	Parents strongly cautioned. Some material may be inappropriate for children under 13.
	R	Restricted. Under 17 requires accompanying parent or adult guardian (age varies in some jurisdictions).
	NC-17	No one 17 and under admitted.
	X	X is an older rating that is unified with NC-17 but may be encoded in the data of older movies.

MPAA		
TV Guidelines	G	-----
Can. English Ratings	PG	-----
Can. French Ratings	PG - 13	BLOCK
	R	BLOCK
	NC - 17	BLOCK
	X	BLOCK
	NONE	

EXAMPLE

- If you select “PG-13”, this will automatically block the higher ratings “R”, “NC-17” and “X”.

NOTE

- Voluntary movie rating system only uses an age-based rating.

TV Parental Guidelines

Rating		Content				
		FV (Fantasy violence)	V (Violence)	S (Sexual situation)	L (Adult language)	D (Sexually suggestive dialog)
Suggested age	TV-Y (All children)	☒	☒	☒	☒	☒
	TV-Y7 (Directed to older children)	×	☒	☒	☒	☒
	TV-G (General audience)		☒	☒	☒	☒
	TV-PG (Parental Guidance suggested)		×	×	×	×
	TV-14 (Parents strongly cautioned)		×	×	×	×
	TV-MA (Mature audience only)		×	×	×	

☒: The content rating can be set, but this rating is not normally broadcast by TV stations.

×: Content rating can be set.

Useful adjustment settings

Voluntary movie rating system (MPAA)

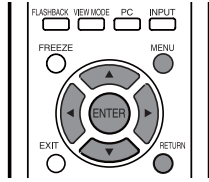

1 Press **MENU** to display the MENU screen, and then press **◀▶** to select “Setup”.

2 Press **▲/▼** to select “Parental CTRL”, and then press **ENTER**.

- The secret number setting menu displays only when “Secret No.” is set. (See page 44.)
- “V-Chip” and “Status” will not be selectable from the menu if you do not first configure your secret number. (See page 44.)

3 Input the 4-digit secret number by using **0–9**.

4 Press **▲/▼** to select “V-Chip”, and then press **ENTER**.

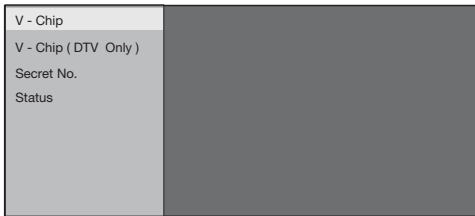

5 Press **▲/▼** to select “MPAA”, and then press **ENTER**.

6 Press **▲/▼** to adjust the item to your desired position. “BLOCK” indicates the item is blocked.

Press **RETURN**.

- The setting automatically enters “Block” for any ratings below your selection.
- If Status is not set to “On”, the configuration settings will not work. (See page 44.)

Example

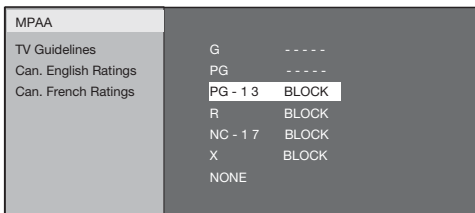

7 Press **MENU** to exit.

TV Parental Guidelines (TV Guidelines)

1 Repeat steps 1 to 4 in **Voluntary movie rating system (MPAA)**.

2 Press **▲/▼** to select “TV Guidelines”, and then press **ENTER**.

3 Press **▲/▼** to adjust the item to your desired position. “BLOCK” indicates the item is blocked.

- The setting automatically enters “Block” for any ratings below your selection.

Example

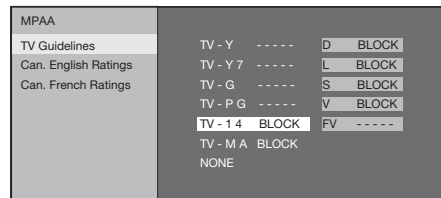

When setting an individual content-based rating item, do as follows:

- 1 Press **▶** to access blocked content items from the currently selected age-based rating item.
- 2 Press **▲/▼** to select an individual item, and then press **ENTER** to unblock it (“BLOCK” is removed). Repeat the same steps for the other items.
- 3 Press **◀** or **RETURN** to register after all individual content rating items are set.

Example

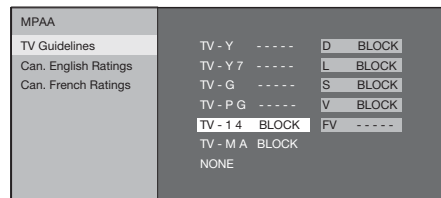

- If Status is not set to “On” the configuration settings will not work. (See page 44.)

4 Press **MENU** to exit.

Useful adjustment settings

Canadian Rating Systems

- The TV rating systems in Canada are based on the Canadian Radio-Television and Telecommunications Commission (CRTC) policy on violence in television programming.
- While violence is the most important content element to be rated, the structure developed takes into consideration other program content like language, nudity, sexuality and mature themes.
- When setting the V-CHIP on the Canadian system you can choose either the Canadian English ratings or the Canadian French ratings.

Canadian English ratings

Rating		Description
Age	E	Exempt: Includes news, sports, documentaries and other information programming; talk shows, music videos, and variety programming.
	C	Children: Intended for younger children under the age of 8 years. Pays careful attention to themes that could threaten their sense of security and well-being.
	C8+	Children over 8 years old: Contains no portrayal of violence as the preferred, acceptable, or only way to resolve conflict; nor encourage children to imitate dangerous acts which they may see on the screen.
	G	General: Considered acceptable for all age groups. Appropriate viewing for the entire family, contains very little violence, physical, verbal or emotional.
	PG	Parental Guidance: Intended for a general audience, but may not be suitable for younger children (under the age of 8) because it could contain controversial themes or issues.
	14+	Over 14 Years: Could contain themes where violence is one of the dominant elements of the story line, but it must be integral to the development of plot or character. Language usage could be profane and nudity present within the context of the theme.
	18+	Adults: Intended for viewers 18 years and older and might contain depictions of violence, which while related to the development of plot, character or themes, are intended for adult viewing. Could contain graphic language and portrayals of sex and nudity.

Canadian French ratings

Rating		Description
Age	E	Exempt programming.
	G	General: All ages and children, contains minimal direct violence, but may be integrated into the plot in a humorous or unrealistic manner.
	8ans +	General but inadvisable for young children: May be viewed by a wide public audience, but could contain scenes disturbing to children under 8 who cannot distinguish between imaginary and real situations. Recommended for viewing with parent.
	13ans +	Over 13 years: Could contain scenes of frequent violent scenes and therefore recommended for viewing with parent.
	16ans +	Over 16 years: Could contain frequent violent scenes and intense violence.
	18ans +	Over 18 years: Only for adult viewing. Could contain frequent violent scenes and extreme violence.

Useful adjustment settings

Canadian English ratings

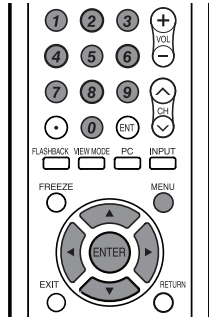

1 Press **MENU** to display the MENU screen, and then press **◀▶** to select "Setup".

2 Press **▲/▼** to select "Parental CTRL", and then press **ENTER**.

- Secret number setting menu displays only when "Secret No." is set. (See page 44.)
- "V-Chip" and "Status" will not be selectable from the menu if you do not first configure your secret number. (See page 44.)

3 Input the 4-digit secret number by using **0-9**.

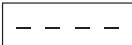

4 Press **▲/▼** to select "V-Chip", and then press **ENTER**.

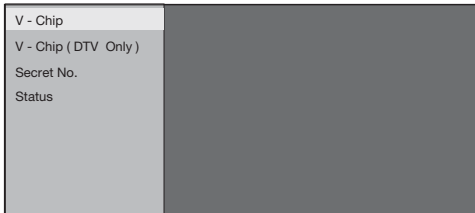

5 Press **▲/▼** to select "Can. English Ratings", and then press **ENTER**.

6 Press **▲/▼** to adjust the item to your desired position. "BLOCK" indicates the item is blocked.

- The setting automatically enters "Block" for any ratings below your selection.
- If Status is not set to "On" the configuration settings will not work. (See page 44.)

Example

MPAA	E	----
TV Guidelines	C	----
Can. English Ratings	C8 +	BLOCK
Can. French Ratings	G	BLOCK
	PG	BLOCK
	14 +	BLOCK
	18 +	BLOCK
	NONE	

7 Press **MENU** to exit.

Canadian French ratings

1 Repeat steps 1 to 4 in **Canadian English ratings**.

2 Press **▲/▼** to select "Can. French Ratings", and then press **ENTER**.

3 Press **▲/▼** to adjust the item to your desired position. "BLOCK" indicates the item is blocked.

- The setting automatically enters "Block" for any ratings below your selection.
- If Status is not set to "On" the configuration settings will not work. (See page 44.)

Example

MPAA	E	----
TV Guidelines	G	BLOCK
Can. English Ratings	8ans+	BLOCK
Can. French Ratings	13ans+	BLOCK
	16ans+	BLOCK
	18ans+	BLOCK
	NONE	

4 Press **MENU** to exit.

How to temporarily release the V-CHIP BLOCK

When the V-CHIP BLOCK is working and censors a broadcast, "V-CHIP HAS BEEN ACTIVATED." displays.

1 Press **ENTER** while the V-CHIP is working, and then the secret number setting menu displays.

2 Input the 4-digit secret number by using **0-9**. At this time V-CHIP BLOCK temporarily releases.

Reactivating the temporarily released V-CHIP BLOCK

You can reactivate the temporarily released V-CHIP BLOCK as shown below.

Method 1:

Select "Status" setting from the Parental CTRL menu to reactivate BLOCK. (See page 44.)

Method 2:

Select "V-Chip" setting ("MPAA", "TV Guidelines", "Can. English Ratings" or "Can. French Ratings") from the Parental CTRL to reactivate BLOCK. (See pages 46 and 49.)

Method 3:

Switch off the TV power.

NOTE

- Performing any of the three above will activate the V-CHIP BLOCK.

Other viewing options

Freezing images

Allows you to capture and freeze a moving image that you are watching.

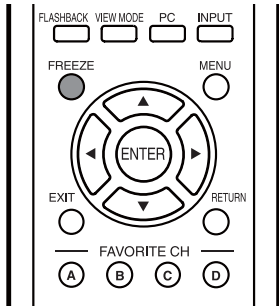

1

Press **FREEZE**.

- A moving image is captured.

2

Press **FREEZE** again to cancel the function.

NOTE

- When this function is not available, "No still image display available." will display.
- The still image automatically goes out after 30 minutes.
- If you are using the freeze function and a broadcast activates the V-CHIP BLOCK, the freeze function will be cancelled and a V-CHIP BLOCK message will appear.

Using the kitchen remote control unit

Kitchen Remote control unit

This remote control is designed for use in a kitchen area. It can remotely control SHARP LCD TV's, it is also has a timer with alarm function.

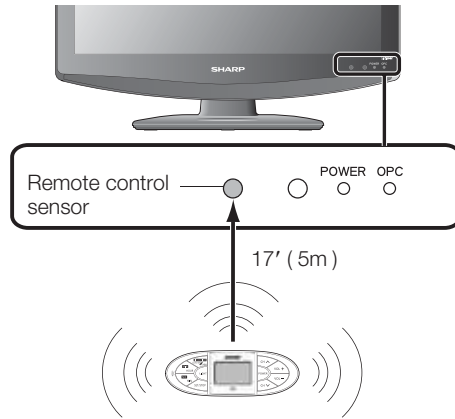

If the remote control fails to operate TV functions, replace the batteries in the remote control unit.

1 Open the battery cover.

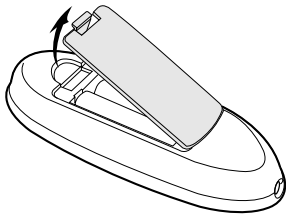

2 Insert two "AA" size **alkaline** batteries (supplied with the product).

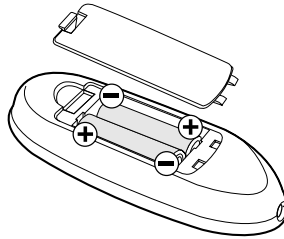

3 Close the battery cover.

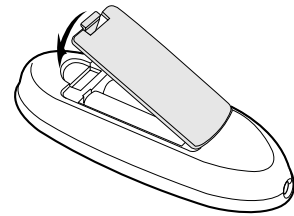

- Place the batteries with their terminals corresponding to the (+) and (-) indications in the battery compartment.

CAUTION

Improper use of batteries can result in chemical leakage or explosion. Be sure to follow the instructions below.

- Please use "AA" **alkaline** batteries for long time.
- Do not mix batteries of different types. Different types of batteries have different characteristics.
- Do not mix old and new batteries. Mixing old and new batteries can shorten the life of new batteries or cause chemical leakage in old batteries.
- Remove batteries as soon as they are worn out. Chemicals that leak from batteries that come in contact with skin can cause a rash. If you find any chemical leakage, wipe thoroughly with a cloth.
- If you will not be using the remote control unit for an extended period of time, remove batteries from it.
- If trouble occurs, take out the batteries for about 30 seconds, clear the memory by resetting it.
- The flute in stand is used to placing kitchen remote control unit.
- The Kitchen remote control unit has magnetic back so you can place it on a refrigerator or other metal surface. Be careful when placing on a metal surface for the first time.

Using the kitchen remote control unit

Clock set

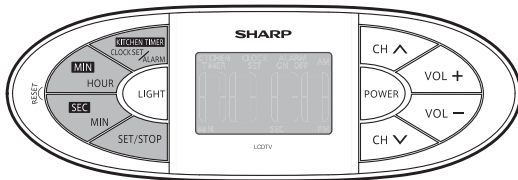

You can adjust the current time.

- 1 Press **KITCHEN TIMER/CLOCK SET/ALARM** repeatedly until **CLOCK SET** icon on LCD flashing.

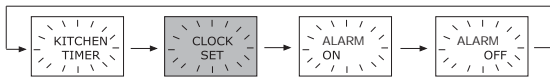

- 2 Press **MIN/HOUR** repeatedly to set hour portion of clock.

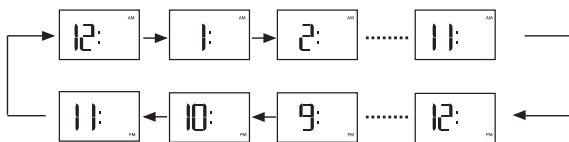

- 3 Press **SEC/MIN** repeatedly to set minute portion of clock.

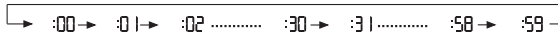

- 4 Within 30 seconds, press **SET/STOP** to confirm settings.

- 5 After **CLOCK SET**, LCD display will be showing as below.



NOTE

- If there is no operation during setup within 30 seconds, clock set procedure will be cancelled automatically.
- When inserting battery first time and/or changing new battery, **CLOCK SET** icon on LCD keeps flashing to indicate end-user set clock.
- The initial value of clock is 12:00 AM.

Kitchen timer set

You can set the kitchen time to remind the cooking time.

- 1 Press **KITCHEN TIMER/CLOCK SET/ALARM** repeatedly until **KITCHEN TIMER** icon on LCD flashing.

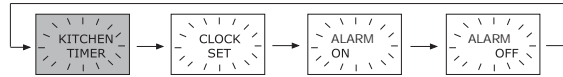

- 2 Press **MIN/HOUR** repeatedly to set minute portion of timer.

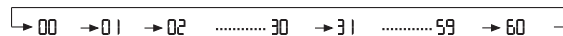

- 3 Press **SEC/MIN** repeatedly to set second portion of timer.

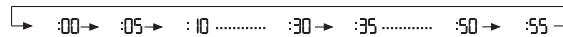

- 4 Within 30 seconds, press **SET/STOP** to confirm settings.

- 5 After **KITCHEN TIMER** set, LCD display will be showing as below.



- 6 Then **KITCHEN TIMER** starts count down and LCD displays countdown value continuously.



- 7 When **KITCHEN TIMER** counts down to zero, beeper sound about 30 seconds and then LCD returns to clock display.

NOTE

- If there is no operation during setup within 30 seconds, kitchen timer set procedure will be cancelled automatically.
- When beeper sounds, press **SET/STOP** to stop beeper sound.
- The range of kitchen timer set is from 5 seconds to 60 minutes, and step is 5 seconds.
- When kitchen timer working, hold pressing **MIN/HOUR** and **SEC/MIN** for about 2 seconds or more to cancel kitchen timer, and then LCD returns to clock display.

Using the kitchen remote control unit

Alarm set

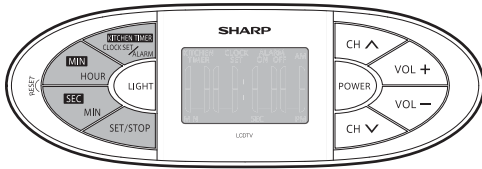

You can set the timer to automatically turn on the TV.

- 1 Press **KITCHEN TIMER/CLOCK SET/ALARM** repeatedly until ALARM ON icon on LCD flashing.

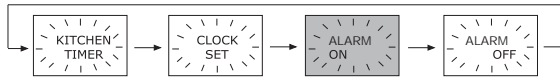

- 2 Press **MIN/HOUR** repeatedly to set hour portion of ALARM.

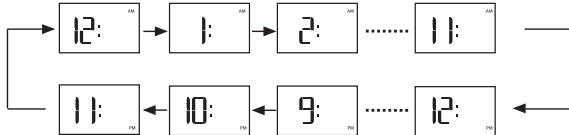

- 3 Press **SEC/MIN** repeatedly to set minute portion of ALARM.

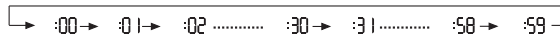

- 4 With in 30 seconds, press **SET/STOP** to confirm settings.

- 5 After ALARM set, LCD display will be showing as below.



- 6 After displaying above information for about 5 seconds, LCD returns to clock display again as below.



- 7 When time reaches ALARM set value, switch the TV power on or enters standby and make beeper sound about 30 seconds, then ALARM icon on LCD goes out.

NOTE

- If there is no operation during setup within 30 seconds, ALARM set procedure will be cancelled automatically.
- When beeper sounds, press **SET/STOP** to stop beeper sound and set ALARM icon off.

Alarm off

The ALARM set can be cancelled.

- 1 Press **KITCHEN TIMER/CLOCK SET/ALARM** repeatedly until ALARM OFF icon on LCD flashing.

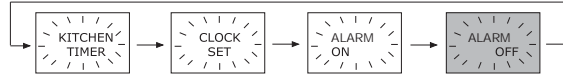

- 2 Within 30 seconds, press **SET/STOP** to cancel ALARM set and LCD returns to normal clock display as below.



NOTE

- If there is no operation during setup within 30 seconds, ALARM reset procedure will be cancelled automatically.
- The initial value of ALARM is 12:00 AM.
- The ALARM set is valid only one time.

Backlight

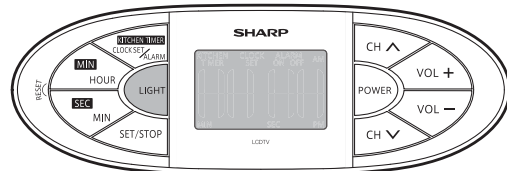

Press **LIGHT**, backlight goes on for about 5 seconds and then goes out.

Appendix

Troubleshooting

Problem	Possible Solution
<ul style="list-style-type: none"> No power 	<ul style="list-style-type: none"> Check if you pressed POWER on the remote control unit. (See page 9 and page 51.) If the indicator on the TV does not light up, press POWER on the TV. Is the AC cord disconnected? (See page 8.) Has the power been turned on? (See page 17.)
<ul style="list-style-type: none"> Unit cannot be operated. 	<ul style="list-style-type: none"> External influences such as lightning, static electricity, may cause improper operation. In this case, operate the unit after first turning off the power of the TV or unplugging the AC cord and replugging it in after 1 or 2 minutes.
<ul style="list-style-type: none"> Remote control unit does not operate. 	<ul style="list-style-type: none"> Are batteries inserted with polarity (+, -) aligned? (See page 9 and page 51.) Are batteries worn out? (Replace with new batteries.) Are you using it under strong or fluorescent lighting? Is a fluorescent light illuminated near the remote control sensor?
<ul style="list-style-type: none"> Picture is cut off/with sidebar screen. 	<ul style="list-style-type: none"> Is the image position correct? (See page 35.) Are screen mode adjustments such as picture size made correctly? (See pages 37 and 38.)
<ul style="list-style-type: none"> Strange color, light color, or color misalignment 	<ul style="list-style-type: none"> Adjust the picture tone. (See pages 27 to 28.) Is the room too bright? The picture may look dark in a room that is too bright. Check the input signal setting. (See page 41.)
<ul style="list-style-type: none"> Power is suddenly turned off. 	<ul style="list-style-type: none"> Is the sleep timer set? (See page 36.) Check the power control settings. (See page 30.) The unit's internal temperature has increased. Remove any objects blocking vent or clean.
<ul style="list-style-type: none"> No picture 	<ul style="list-style-type: none"> Is connection to other components correct? (See pages 15 and 16.) Is correct input signal source selected after connection? (See page 31.) Is the correct input selected? (See page 31.) Is picture adjustment correct? (See pages 27 to 28.) Is "On" selected in "Audio Only"? (See page 39.) Is a non-compatible signal being input? (See page 16.)
<ul style="list-style-type: none"> No sound 	<ul style="list-style-type: none"> Is the volume too low? (See page 20.) Have you pressed MUTE on the remote control unit? (See page 20.)
<ul style="list-style-type: none"> The TV sometimes makes a cracking sound. 	<ul style="list-style-type: none"> This is not a malfunction. This happens when the cabinet slightly expands and contracts according to change in temperature. This does not affect the TV's performance.

Troubleshooting-Digital broadcasting

The error message about reception of broadcast

The example of an error message displayed on a screen	Possible Solution
<ul style="list-style-type: none"> Failed to receive broadcast. 	<ul style="list-style-type: none"> Check the antenna cable. Check that the antenna is correctly setup.
<ul style="list-style-type: none"> No broadcast now. 	<ul style="list-style-type: none"> Check the broadcast time in the program guide.

Appendix

Specifications

Item		Model: LC-19SK25U/LC-19SK25U-W	
LCD panel		18.5" screen size class Advanced Super View & BLACK TFT LCD (Diagonal Measurement:18 ¹ / ₂ "	
Resolution		1,049,088 pixels (1,366 × 768)	
TV Function	TV-standard (CCIR)	American TV Standard ATSC/NTSC System	
	Receiving Channel	VHF/UHF	VHF 2-13ch, UHF 14-69ch
		CATV(analog)	1-135ch (STD, HRC, IRC)
		Digital Terrestrial Broadcast (8VSB)	2-69ch
		Digital Cable ^{*1} (64/256 QAM)	1-135ch
Audio multiplex	BTSC System		
Backlight		50,000 hours (at Backlight Standard position)	
Audio out		2W × 2	
Terminals	INPUT 1	COMPONENT in	
	INPUT 2	AV in, S-VIDEO in	
	INPUT 3	HDMI in with HDCP(480P, 720P/60Hz, 1080I/60Hz, VGA), HDMI Analog Audio in	
	INPUT 4	15 pin mini D-sub female connector, PC Audio in (Ø 3.5 mm jack)	
	Headphone	Ø 3.5 mm jack (Audio Output)	
	ANTENNA	75 Ω Unbalance, F Type × 1 for Analog (VHF/UHF/CATV) and Digital (AIR/CABLE)	
	DIGITAL AUDIO OUTPUT	Optical Digital audio output × 1 (Dolby Digital)	
OSD language		English/French/Spanish	
Power Requirement		AC 120 V, 60 Hz	
Power Consumption		44 W (0.5 W Standby with AC 120V)	
Weight	TV + stand	11.4 lbs./5.2 kg	
	TV only	10.3 lbs./4.7 kg	
Dimension ^{*2} (W × H × D)	TV + stand	18 ³ / ₁₆ × 14 ¹¹ / ₆₄ × 7 ⁶³ / ₆₄ inch	
	TV only	18 ³ / ₁₆ × 12 ¹⁹ / ₃₂ × 2 ⁶¹ / ₆₄ inch	
Operating temperature		+32°F to +104°F (0°C to +40°C)	

^{*1} Emergency alert messages via Cable are unreceivable.

^{*2} The dimensional drawings are shown on the inside back cover.

- As part of policy of continuous improvement, SHARP reserves the right to make design and specification changes for product improvement without prior notice. The performance specification figures indicated are nominal values of production units. There may be some deviations from these values in individual units.

CLEARING THE SECRET NUMBER

If you forget the secret number, clear the secret number using the following procedure.

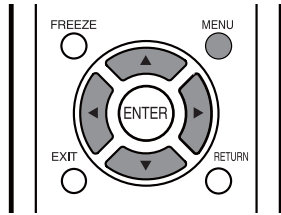

1 Press **MENU** to display the MENU screen, and then press ◀▶ to select "Setup".

2 Press ▲/▼ to select "EZ Setup", "CH Setup", "Parental CTRL" or "Reset", and the Secret number input screen displays.

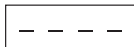

3 Press and hold both **CH▲** and **VOL+** on the TV simultaneously until the "The secret number cleared." appears on the screen.

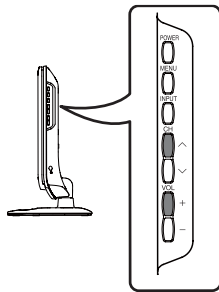

The secret number is

--	--	--	--

NOTE

- As a precautionary measure, make a note of your secret number above, cut it from this manual, and keep it in a safe place.

Cautions regarding use in high and low temperature environments

- When the unit is used in a low temperature space (e.g. room, office), the picture may leave trails or appear slightly delayed. This is not a malfunction, and the unit will recover when the temperature returns to normal.
 - Do not leave the unit in a hot or cold location. Also, do not leave the unit in a location exposed to direct sunlight or near a heater, as this may cause the cabinet to deform and the Liquid Crystal panel to malfunction.
- Storage temperature: -4°F to +140°F (-20°C to +60°C)

Information on the software license for this product

Software composition

The software included in this product is comprised of various software components whose individual copyrights are held by SHARP or by third parties.

Software developed by SHARP and open source software

The copyrights for the software components and various relevant documents included with this product that were developed or written by SHARP are owned by SHARP and are protected by the Copyright Act, international treaties, and other relevant laws. This product also makes use of freely distributed software and software components whose copyrights are held by third parties. These include software components covered by a GNU General Public License (hereafter GPL), a GNU Lesser General Public License (hereafter LGPL) or other license agreement.

Obtaining source code

Some of the open source software licensors require the distributor to provide the source code with the executable software components. GPL and LGPL include similar requirements. For information on obtaining the source code for the open source software and for obtaining the GPL, LGPL, and other license agreement information, visit the following website:

<http://www.sharpusa.com/gpl>

We are unable to answer any questions about the source code for the open source software. The source code for the software components whose copyrights are held by SHARP is not distributed.

Acknowledgements

The following open source software components are included in this product:

- linux kernel
- busybox
- uClibc
- zlib
- libpng
- libjpeg

Calling for Service

For location of the nearest Sharp Authorized Service, or to obtain product literature, accessories, supplies, or customer assistance, please call 1-800-BE-SHARP.

LIMITED WARRANTY

CONSUMER LIMITED WARRANTY

SHARP ELECTRONICS CORPORATION warrants to the first consumer purchaser that this Sharp brand Liquid Crystal Display product (the "Product"), when shipped in its original container, will be free from defective workmanship and materials, and agrees that it will, at its option, either repair the defect or replace the defective Product or part thereof with a new or remanufactured equivalent at no charge to the purchaser for parts or labor for the period(s) set forth below.

This warranty does not apply to any appearance items of the Product or if the serial number or model number affixed to the Product has been removed, defaced, changed, altered or tampered with. This warranty does not cover installation or signal reception problems. This limited warranty will not apply if the Product has been or is being used in a commercial setting or application; this warranty is meant solely for the non-commercial, household use of the Product by consumers in their home or residence. If you intend to or already use this Product for commercial purposes or in a commercial setting, there are warranties available to cover your use of this Product, the terms of which may vary. Please contact **1-888-GO-SHARP** for further information.

In order to enforce your rights under this limited warranty, you should follow the steps set forth below. You must be able to provide proof of purchase to the servicer, which proof must include the date of purchase.

To the extent permitted by applicable state law, the warranties set forth are in lieu of, and exclusive of, all other warranties, express or implied. Specifically ALL OTHER WARRANTIES OTHER THAN THOSE SET FORTH ABOVE ARE EXCLUDED, ALL EXPRESS AND IMPLIED WARRANTIES INCLUDING THE WARRANTIES OF MERCHANTABILITY, FITNESS FOR USE, AND FITNESS FOR A PARTICULAR PURPOSE ARE SPECIFICALLY EXCLUDED. IF, UNDER APPLICABLE STATE LAW, IMPLIED WARRANTIES MAY NOT VALIDLY BE DISCLAIMED OR EXCLUDED, THE DURATION OF SUCH IMPLIED WARRANTIES IS LIMITED TO THE PERIOD(S) FROM THE DATE OF PURCHASE SET FORTH BELOW. THIS WARRANTY GIVES YOU SPECIFIC LEGAL RIGHTS. YOU MAY ALSO HAVE OTHER RIGHTS WHICH VARY FROM STATE TO STATE.

The warranties given herein shall be the sole and exclusive warranties granted by Sharp and shall be the sole and exclusive remedy available to the purchaser and only for the time periods set forth herein. No other representations or promises made by anyone are permitted. Correction of defects, in the manner and for the period of time described herein, shall constitute complete fulfillment of all liabilities and responsibilities of Sharp to the purchaser with respect to the Product, and shall constitute full satisfaction of all claims, whether based on contract, negligence, strict liability or otherwise. Sharp does not warrant nor shall Sharp be liable, or in any way responsible, for Products which have been subject to abuse (including, but not limited to, improper voltage), accident, misuse, negligence, lack of reasonable care, alteration, modification, tampering, misuse, improper operation or maintenance or any damages or defects in the Product which were caused by repairs or attempted repairs performed by anyone other than a Sharp authorized servicer. Nor shall Sharp be liable or in any way responsible for any incidental or consequential economic or property damage. Some states do not allow limits on warranties or on remedies for breach in certain transactions; in such states, the limits herein may not apply.

THIS LIMITED WARRANTY IS VALID ONLY IN THE FIFTY (50) UNITED STATES, THE DISTRICT OF COLUMBIA AND PUERTO RICO.

Model Specific Section

Your Product Model Number & Description:

LC-19SK25U/LC-19SK25U-W LCD Color Television
(Be sure to have this information available when you need service for your Product.)

Warranty Period for this Product:

One (1) year parts, 90 days labor from the date of purchase.

Additional Exclusions from Warranty Coverage (if any):

Image Retention resulting from a fixed image being displayed for long periods of time is not covered by this Limited Warranty (see Operation Manual on how to prevent this).

Where to Obtain Service:

From a Sharp Authorized Servicer located in the United States. To find the location of the nearest Sharp Authorized Servicer, please call Sharp toll free at 1-800-BE-SHARP.

What to do to Obtain Service:

Ship prepaid or carry in your Product to a Sharp Authorized Servicer. Be sure to have proof of purchase available. If you ship the Product, be sure it is insured and packaged securely. Please use two persons to carry the Product, transport it in its original packaging, and ensure that the Product is covered to avoid scratches and damage. Sharp shall not be responsible for lost, stolen or misdirected mail or for damage to the product incurred during shipping.

TO OBTAIN PRODUCT INFORMATION OR PURCHASE ACCESSORIES AND EXTENDED WARRANTIES, CALL **1-800-BE-SHARP** OR VISIT www.sharpsusa.com

Free Manuals Download Website

<http://myh66.com>

<http://usermanuals.us>

<http://www.somanuals.com>

<http://www.4manuals.cc>

<http://www.manual-lib.com>

<http://www.404manual.com>

<http://www.luxmanual.com>

<http://aubethermostatmanual.com>

Golf course search by state

<http://golfingnear.com>

Email search by domain

<http://emailbydomain.com>

Auto manuals search

<http://auto.somanuals.com>

TV manuals search

<http://tv.somanuals.com>