

# SHARP®

# LC-19SB27UT LC-22SB27UT

LIQUID CRYSTAL TELEVISION  
TÉLÉVISEUR ACL  
TELEVISOR CON PANTALLA DE CRISTAL LÍQUIDO

OPERATION MANUAL  
MODE D'EMPLOI  
MANUAL DE OPERACIÓN

ENGLISH

FRANÇAIS

ESPAÑOL



IMPORTANT : Please read this operation manual before starting operating the equipment.  
IMPORTANT : Veuillez lire ce mode d'emploi avant de commencer à utiliser l'appareil.  
IMPORTANTE : Lea este manual de operación antes de comenzar a operar el equipo.



# LC-19SB27UT LC-22SB27UT

## LIQUID CRYSTAL TELEVISION

### ENGLISH

## OPERATION MANUAL

#### IMPORTANT:

- To aid reporting in case of loss or theft, please record the TV's model and serial numbers in the space provided. The numbers are located at the rear of the TV.

Model No.:

Serial No.:

- Manufactured under license from Dolby Laboratories. "Dolby" and the double-D symbol are trademarks of Dolby Laboratories.
- "HDMI, the HDMI logo and High-Definition Multimedia Interface are trademarks or registered trademarks of HDMI Licensing LLC."
- Products that have earned the ENERGY STAR® are designed to protect the environment through superior energy efficiency.

## IMPORTANT INFORMATION

**WARNING:** TO REDUCE THE RISK OF FIRE OR ELECTRIC SHOCK, DO NOT EXPOSE THIS PRODUCT TO RAIN OR MOISTURE.



#### CAUTION

RISK OF ELECTRIC SHOCK  
DO NOT OPEN



CAUTION: TO REDUCE THE RISK OF ELECTRIC SHOCK,  
DO NOT REMOVE COVER (OR BACK).  
NO USER-SERVICEABLE PARTS INSIDE.  
REFER SERVICING TO QUALIFIED SERVICE  
PERSONNEL.



The lightning flash with arrow-head symbol, within an equilateral triangle, is intended to alert the user to the presence of uninsulated "dangerous voltage" within the product's enclosure that may be of sufficient magnitude to constitute a risk of electric shock to persons.



The exclamation point within a triangle is intended to alert the user to the presence of important operating and maintenance (servicing) instructions in the literature accompanying the product.

# IMPORTANT INFORMATION

**CAUTION:** TO PREVENT ELECTRIC SHOCK, MATCH WIDE BLADE OF PLUG TO WIDE SLOT, FULLY INSERT.

**WARNING:** FCC Regulations state that any unauthorized changes or modifications to this equipment not expressly approved by the manufacturer could void the user's authority to operate this equipment.

**CAUTION:**

This product satisfies FCC regulations when shielded cables and connectors are used to connect the unit to other equipment. To prevent electromagnetic interference with electric appliances such as radios and televisions, use shielded cables and connectors for connections.

"Note to CATV system installer: This reminder is provided to call the CATV system installer's attention to Article 820-40 of the National Electrical Code that provides guidelines for proper grounding and, in particular, specifies that the cable ground shall be connected to the grounding system of the building, as close to the point of cable entry as practical."

This product utilizes tin-lead solder, and fluorescent lamp containing a small amount of mercury. Disposal of these materials may be regulated due to environmental considerations. For disposal or recycling information, please contact your local authorities, the Electronic Industries Alliance: [www.eiae.org](http://www.eiae.org), the lamp recycling organization: [www.lamprecycle.org](http://www.lamprecycle.org) or Sharp at 1-800-BE-SHARP (For U.S.A. Only)

**DECLARATION OF CONFORMITY**

SHARP LIQUID CRYSTAL TELEVISION, MODEL LC-19SB27UT/LC-22SB27UT.

This device complies with Part 15 of the FCC Rules. Operation is subject to the following two conditions:

(1) This device may not cause harmful interference, and (2) this device must accept any interference received, including interference that may cause undesired operation.

**RESPONSIBLE PARTY:**

SHARP ELECTRONICS CORPORATION  
Sharp Plaza, Mahwah, New Jersey 07495-1163  
TEL: 1-800-BE-SHARP

For Business Customers: URL <http://www.sharpusa.com>

**INFORMATION:**

This equipment has been tested and found to comply with the limits for a Class B digital device, pursuant to Part 15 of the FCC Rules. These limits are designed to provide reasonable protection against harmful interference in a residential installation. This equipment generates, uses and can radiate radio frequency energy and, if not installed and used in accordance with the instructions, may cause harmful interference to radio communications. However, there is no guarantee that interference will not occur in a particular installation. If this equipment does cause harmful interference to radio or television reception, which can be determined by turning the equipment off and on, the user is encouraged to try to correct the interference by one or more of the following measures:

- Reorient or relocate the receiving antenna.
- Increase the separation between the equipment and receiver.
- Connect the equipment into an outlet on a circuit different from that to which the receiver is connected.
- Consult the dealer or an experienced radio/TV technician for help.

# DEAR SHARP CUSTOMER

Thank you for your purchase of the Sharp Liquid Crystal Television. To ensure safety and many years of trouble-free operation of your product, please read the Important Safety Instructions carefully before using this product.

## IMPORTANT SAFETY INSTRUCTIONS

Electricity is used to perform many useful functions, but it can also cause personal injuries and property damage if improperly handled. This product has been engineered and manufactured with the highest priority on safety. However, improper use can result in electric shock and/or fire. In order to prevent potential danger, please observe the following instructions when installing, operating and cleaning the product. To ensure your safety and prolong the service life of your Liquid Crystal Television, please read the following precautions carefully before using the product.

- 1) Read these instructions.
- 2) Keep these instructions.
- 3) Heed all warnings.
- 4) Follow all instructions.
- 5) Do not use this apparatus near water.
- 6) Clean only with dry cloth.
- 7) Do not block any ventilation openings. Install in accordance with the manufacturer's instructions.
- 8) Do not install near any heat sources such as radiators, heat registers, stoves, or other apparatus (including amplifiers) that produce heat.
- 9) Do not defeat the safety purpose of the polarized or grounding-type plug. A polarized plug has two blades with one wider than the other. A grounding type plug has two blades and a third grounding prong. The wide blade or the third prong are provided for your safety. If the provided plug does not fit into your outlet, consult an electrician for replacement of the obsolete outlet.
- 10) Protect the power cord from being walked on or pinched particularly at plugs, convenience receptacles, and the point where they exit from the apparatus.
- 11) Only use attachments/accessories specified by the manufacturer.
- 12) Use only with the cart, stand, tripod, bracket, or table specified by the manufacturer, or sold with the apparatus. When a cart is used, use caution when moving the cart/apparatus combination to avoid injury from tip-over.
- 13) Unplug this apparatus during lightning storms or when unused for long periods of time.
- 14) Refer all servicing to qualified service personnel. Servicing is required when the apparatus has been damaged in any way, such as power-supply cord or plug is damaged, liquid has been spilled or objects have fallen into the apparatus, the apparatus has been exposed to rain or moisture, does not operate normally, or has been dropped.



### Additional Safety Information

- 15) Power Sources—This product should be operated only from the type of power source indicated on the marking label. If you are not sure of the type of power supply to your home, consult your product dealer or local power company. For products intended to operate from battery power, or other sources, refer to the operating instructions.
- 16) Overloading—Do not overload wall outlets, extension cords, or integral convenience receptacles as this can result in a risk of fire or electric shock.
- 17) Object and Liquid Entry—Never push objects of any kind into this product through openings as they may touch dangerous voltage points or short-out parts that could result in a fire or electric shock. Never spill liquid of any kind on the product.
- 18) Damage Requiring Service—Unplug this product from the wall outlet and refer servicing to qualified service personnel under the following conditions:
  - a) When the AC cord or plug is damaged,
  - b) If liquid has been spilled, or objects have fallen into the product,
  - c) If the product has been exposed to rain or water,
  - d) If the product does not operate normally by following the operating instructions.  
Adjust only those controls that are covered by the operating instructions as an improper adjustment of other controls may result in damage and will often require extensive work by a qualified technician to restore the product to its normal operation,
  - e) If the product has been dropped or damaged in any way, and
  - f) When the product exhibits a distinct change in performance - this indicates a need for service.
- 19) Replacement Parts—When replacement parts are required, be sure the service technician has used replacement parts specified by the manufacturer or have the same characteristics as the original part. Unauthorized substitutions may result in fire, electric shock, or other hazards.
- 20) Safety Check—Upon completion of any service or repairs to this product, ask the service technician to perform safety checks to determine that the product is in proper operating condition.
- 21) Wall or ceiling mounting—When mounting the product on a wall or ceiling, be sure to install the product according to the method recommended by the manufacturer.

# IMPORTANT SAFETY INSTRUCTIONS

- Water and Moisture — Do not use this product near water - for example, near a bath tub, wash bowl, kitchen sink, or laundry tub; in a wet basement; or near a swimming pool; and the like.
- Stand — Do not place the product on an unstable cart, stand, tripod or table. Placing the product on an unstable base can cause the product to fall, resulting in serious personal injuries as well as damage to the product. Use only a cart, stand, tripod, bracket or table recommended by the manufacturer or sold with the product. When mounting the product on a wall, be sure to follow the manufacturer's instructions. Use only the mounting hardware recommended by the manufacturer.
- Selecting the location — Select a place with no direct sunlight and good ventilation.
- Ventilation — The vents and other openings in the cabinet are designed for ventilation. Do not cover or block these vents and openings since insufficient ventilation can cause overheating and/or shorten the life of the product. Do not place the product on a bed, sofa, rug or other similar surface, since they can block ventilation openings. This product is not designed for built-in installation; do not place the product in an enclosed place such as a bookcase or rack, unless proper ventilation is provided or the manufacturer's instructions are followed.
- The Liquid Crystal panel used in this product is made of glass. Therefore, it can break when the product is dropped or applied with impact. Be careful not to be injured by broken glass pieces in case the panel breaks.
- Heat — The product should be situated away from heat sources such as radiators, heat registers, stoves, or other products (including amplifiers) that produce heat.
- The Liquid Crystal panel is a very high technology product with 1,049,088 pixels, giving you fine picture details. Occasionally, a few non-active pixels may appear on the screen as a fixed point of blue, green or red. Please note that this does not affect the performance of your product.
- Lightning — For added protection for this television equipment during a lightning storm, or when it is left unattended and unused for long periods of time, unplug it from the wall outlet and disconnect the antenna. This will prevent damage to the equipment due to lightning and power-line surges.
- Power Lines — An outside antenna system should not be located in the vicinity of overhead power lines or other electric light or power circuits, or where it can fall into such power lines or circuits. When installing an outside antenna system, extreme care should be taken to keep from touching such power lines or circuits as contact with them might be fatal.
- Outdoor Antenna Grounding — If an outside antenna is connected to the television equipment, be sure the antenna system is grounded so as to provide some protection against voltage surges and built-up static charges. Article 810 of the National Electrical Code, ANSI/NFPA 70, provides information with regard to proper grounding of the mast and supporting structure, grounding of the lead-in wire to an antenna discharge unit, size of grounding conductors, location of antenna-discharge unit, connection to grounding electrodes, and requirements for the grounding electrode.

EXAMPLE OF ANTENNA GROUNDING AS PER  
NATIONAL ELECTRICAL CODE, ANSI/NFPA 70

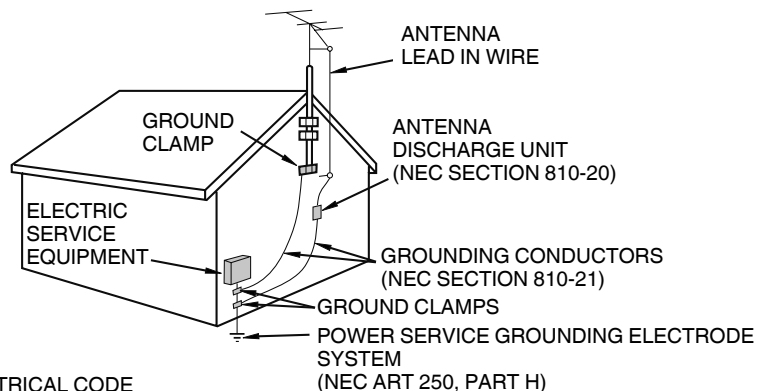

NEC — NATIONAL ELECTRICAL CODE

- To prevent fire, never place any type of candle or flames on the top or near the TV set.
- To prevent fire or shock hazard, do not expose this product to dripping or splashing. No objects filled with liquids, such as vases, should be placed on the product.
- To prevent fire or shock hazard, do not place the AC cord under the TV set or other heavy items.
- Turn off the main power and unplug the AC cord from the wall outlet before handling.
- Use a soft cloth and gently wipe the surface of the display panel. Using a hard cloth may scratch the panel surface.
- Use a soft damp cloth to gently wipe the panel when it is really dirty. (It may scratch the panel surface when wiped strongly.)
- If the panel is dusty, use an anti-static brush, which is commercially available, to clean it.
- To protect the panel, do not use a dirty cloth, liquid cleaners or chemical cloth to clean it, such materials may damage the panel surface.
- Do not display a still picture for a long time, as this could cause an afterimage to remain.
- Install the product on the place where the AC cord can be unplugged easily from the AC outlet, or from the AC INPUT terminal on the rear of the product.
- When transporting the TV, never carry it by holding or otherwise putting pressure onto the display.
- Do not insert foreign objects into the product. Inserting objects in the air vents or other openings may result in fire or electric shock. Exercise special caution when using the product around children.

# IMPORTANT SAFETY INSTRUCTIONS

## CHILD SAFETY

It Makes A Difference How and Where You Use Your Flat Panel Display

Congratulations on your purchase! As you enjoy your new product, please keep these safety tips in mind:



### THE ISSUE

- The home theater entertainment experience is a growing trend and larger flat panel displays are popular purchases. However, flat panel displays are not always supported on the proper stands or installed according to the manufacturer's recommendations.
- Flat panel displays that are inappropriately situated on dressers, bookcases, shelves, desks, speakers, chests or carts may fall over and cause injury.

### THIS MANUFACTURER CARES!

- The consumer electronics industry is committed to making home entertainment enjoyable and safe.

### TUNE INTO SAFETY

- One size does NOT fit all. Follow the manufacturer's recommendations for the safe installation and use of your flat panel display.
- Carefully read and understand all enclosed instructions for proper use of this product.
- Don't allow children to climb on or play with furniture and television sets.
- Don't place flat panel displays on furniture that can easily be used as steps, such as a chest of drawers.
- Remember that children can become excited while watching a program, especially on a "larger than life" flat panel display. Care should be taken to place or install the display where it cannot be pushed, pulled over, or knocked down.
- Care should be taken to route all cords and cables connected to the flat panel display so that they cannot be pulled or grabbed by curious children.

### WALL MOUNTING: IF YOU DECIDE TO WALL MOUNT YOUR FLAT PANEL DISPLAY, ALWAYS:

- Use a mount that has been recommended by the display manufacturer and/or listed by an independent laboratory (such as UL, CSA, ETL).
- Follow all instructions supplied by the display and wall mount manufacturers.
- If you have any doubts about your ability to safely install your flat panel display, contact your retailer about professional installation.
- Make sure that the wall where you are mounting the display is appropriate. Some wall mounts are not designed to be mounted to walls with steel studs or old cinder block construction. If you are unsure, contact a professional installer.
- A minimum of two people are required for installation. Flat panel displays can be heavy.



**Note:** CEA is the preeminent trade association promoting growth in the \$161 billion U.S. consumer electronics industry. More than 2,200 companies enjoy the benefits of CEA membership, including legislative advocacy, market research, technical training and education, industry promotion and the fostering of business and strategic relationships.

# Supplied accessories

Make sure the following accessories are provided with the product.



Remote control unit  
(X1)  
Page 8



"AA" size battery  
(X2)  
Page 8



AC cord (X1)  
Page 7

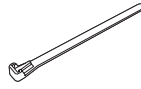

Cable Tie (X1)  
Page 7



Screw (X3)  
Page 6



Operation manual  
(X1)

## NOTE

- Always use the AC cord supplied with the TV.

To avoid scratching the frame or screen, please use a soft, lint free cloth for cleaning. Approved cleaning cloths are available directly from Sharp in single (00Z-LCD-CLOTH) or triple (00Z-LCD-CLOTH- 3) packs. Call 1-800-BE-SHARP for ordering, or VISIT [www.sharpusa.com/SharpDirect](http://www.sharpusa.com/SharpDirect).

# QUICK REFERENCE

## Attaching the stand

- Before attaching (or detaching) the stand, unplug the AC cord from the AC input terminal.
- Before performing work spread cushioning over the base area to lay the TV on. This will prevent it from being damaged.

## CAUTION

- **Attach the stand in the correct direction.**
- **Be sure to follow the instructions. Incorrect installation of the stand may result in the TV falling over.**

- 1 Confirm the 3 screws supplied with the TV.

### Screws (X3)

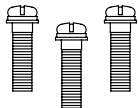

- 3 For protection, sheets are covering the product. Please remove these sheets before use.

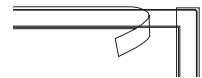

## NOTE

- To detach the stand, perform the step in reverse order.

- 2 Remove the covering sheet of the stand.

- ① Insert the stand to the bottom of the TV.
- ② Insert and tighten the 3 screws into the 3 holes on the bottom of the stand.

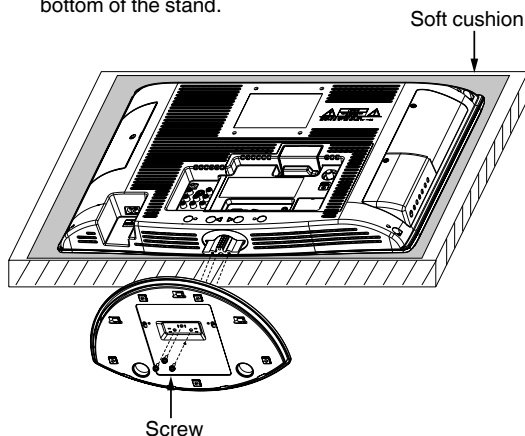

## Ventilation & Cleaning Tips

Keep your TV in a well ventilated area and make sure not to place it by a heat source or use near water. The TV is designed for AC use only and should be used with supplied AC cord.

Clean the screen by spraying a soft lint free cloth with water to lightly moisten. Gently wipe and avoid pressing on the screen. To clean the outer cabinet, use the same method. Do not use liquid or aerosol cleaners.

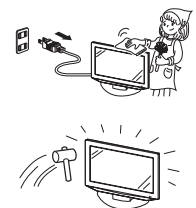



## QUICK REFERENCE

### QUICK INSTALLATION TIPS

1 Attach your antenna to the back of the TV.  
(See page 12.)

2 Connect the AC plug for the TV into the wall outlet.

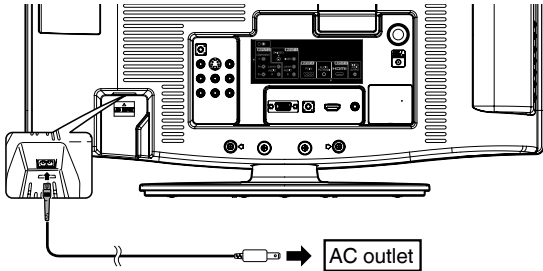

- Place the TV close to the AC outlet, and keep the power plug within reach.

#### NOTE

- TO PREVENT RISK OF ELECTRIC SHOCK, DO NOT TOUCH UN-INSULATED PARTS OF ANY CABLES WITH THE AC CORD CONNECTED.**

3 Secure cables and cords with the supplied cable tie so that they do not get caught when mounting the cover.

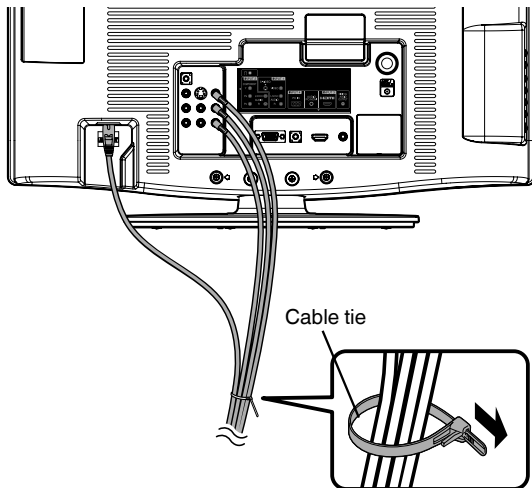

4 How to turn on the TV for the first time.

A) Press **POWER** on TV.

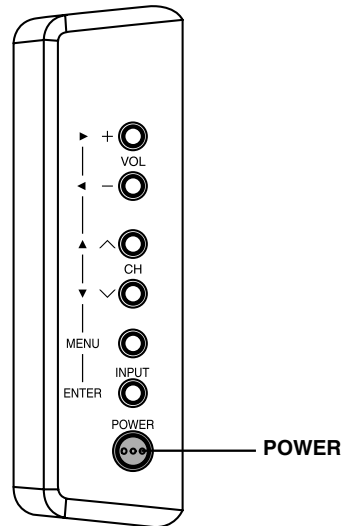

B) POWER indicator on the front of the TV lights GREEN.

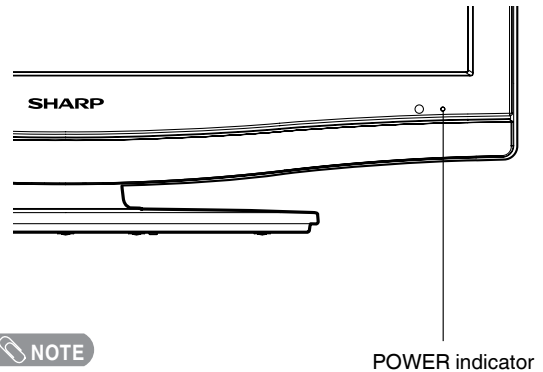

#### NOTE

- Speaker cannot be detached from the TV.
- TV angle cannot be adjusted.

## QUICK REFERENCE

If the remote control fails to operate TV functions, replace the batteries in the remote control unit.

1 Open the battery cover.

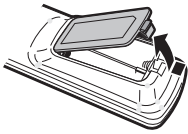

2 Insert two "AA" size batteries (supplied with the product).

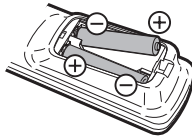

3 Close the battery cover.

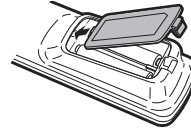

- Place the batteries with their terminals corresponding to the (+) and (-) indications in the battery compartment.

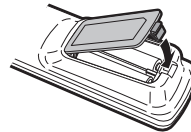

### NOTE

Improper use of batteries can result in chemical leakage or explosion. Be sure to follow the instructions below.

- Do not mix batteries of different types. Different types of batteries have different characteristics.
- Do not mix old and new batteries. Mixing old and new batteries can shorten the life of new batteries or cause chemical leakage in old batteries.
- Remove batteries as soon as they are worn out. Chemicals that leak from batteries that come in contact with skin can cause a rash. If you find any chemical leakage, wipe thoroughly with a cloth.
- The batteries supplied with this product may have a shorter life expectancy due to storage conditions.
- If you will not be using the remote control unit for an extended period of time, remove batteries from it.

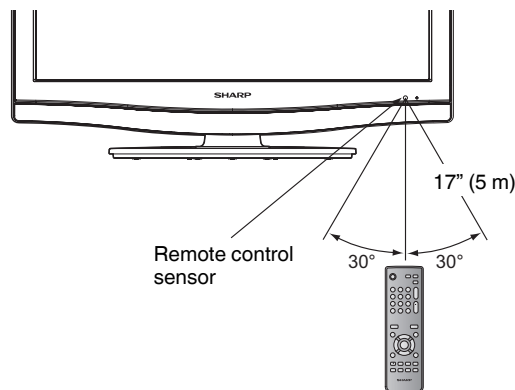

### IMPORTANT:

The **POWER** indicator on the television should light **GREEN** indicating you have power to the TV.

If the **POWER** indicator on the television still does not light up, press **POWER** on the remote control to turn the power on.

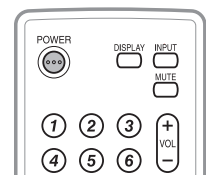

### IMPORTANT:

IF THE UNIT DOES NOT POWER ON - UNPLUG THE TELEVISION FROM THE OUTLET AND REPEAT THE INSTALLATION STEPS.

IF YOU STILL ENCOUNTER NO POWER, PLEASE CONTACT US AT 1-800-BE-SHARP.

# Contents

<b>IMPORTANT INFORMATION</b> .....	1	<b>Other convenience functions</b> .....	22
<b>DEAR SHARP CUSTOMER</b> .....	3	Menu operation buttons.....	22
<b>IMPORTANT SAFETY INSTRUCTIONS</b> .....	3	Quick guide for MENU operation .....	22
<b>Supplied accessories</b> .....	6	<b>Connecting a PC (Personal computer)</b> .....	24
<b>QUICK REFERENCE</b> .....	6	Viewing an image from a PC.....	24
Attaching the stand.....	6	Displaying an image from a PC.....	24
<b>Contents</b> .....	9	PC compatibility chart.....	24
<b>Part names</b> .....	10	<b>Appendix</b> .....	25
TV (Front) .....	10	Troubleshooting.....	25
TV (Rear).....	10	Troubleshooting-Digital broadcasting.....	25
TV (Left).....	10	Troubleshooting-PC mode.....	25
Remote control unit.....	11	Specifications .....	26
<b>Preparation</b> .....	12	<b>Calling for Service</b> .....	27
Using the remote control unit.....	12	<b>LIMITED WARRANTY</b> .....	27
Cautions regarding remote control unit.....	12		
Antennas .....	12		
<b>Using external equipment</b> .....	13	<b>Dimensional Drawings</b>	
Displaying an external equipment image .....	13	• The dimensional drawings for the TV set are shown	
Connecting to External Equipment .....	13	on the inside back cover.	
<b>Watching TV</b> .....	14		
Preparation.....	14		
Turning on the power.....	14		
Auto Setup.....	14		
Turning off the power.....	14		
Changing channels.....	14		
Auto Ch Memory.....	15		
Skipping stored channel .....	15		
Clear All.....	15		
Display the channel information.....	15		
Setting MTS/SAP stereo mode.....	15		
Selecting the digital audio language .....	16		
View mode for 4:3 programs.....	16		
View mode for HD programs.....	16		
Labeling channels.....	16		
Favorite channel setting.....	17		
Closed captions and digital closed captions .....	18		
Caption setup .....	19		
Password setting for parental control.....	19		
How to enter the Lock menu .....	19		
To clear the all V-Chip settings .....	19		
Parental control (V-CHIP) .....	20		
TV Parental Guidelines (TV Guidelines) .....	20		
Voluntary movie rating system (MPAA) .....	20		
Canadian rating systems .....	21		
Canadian English ratings.....	21		
Canadian French ratings .....	21		
How to temporarily release the V-Chip block .....	21		

# Part names

## TV (Front)

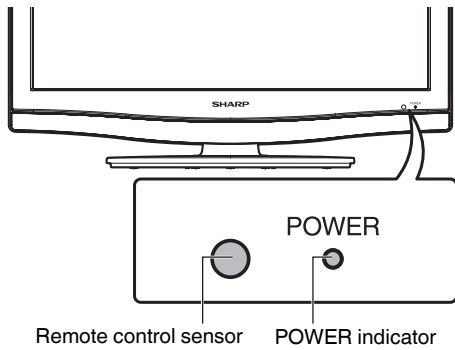

## TV (Left)

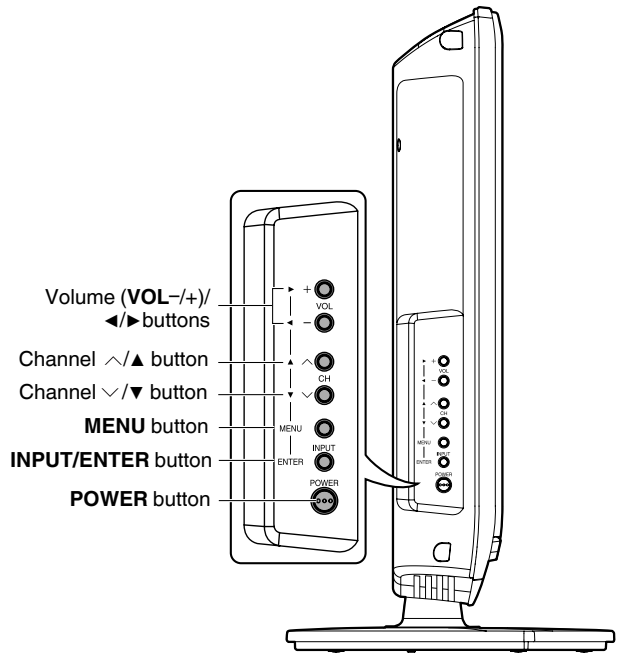

## TV (Rear)

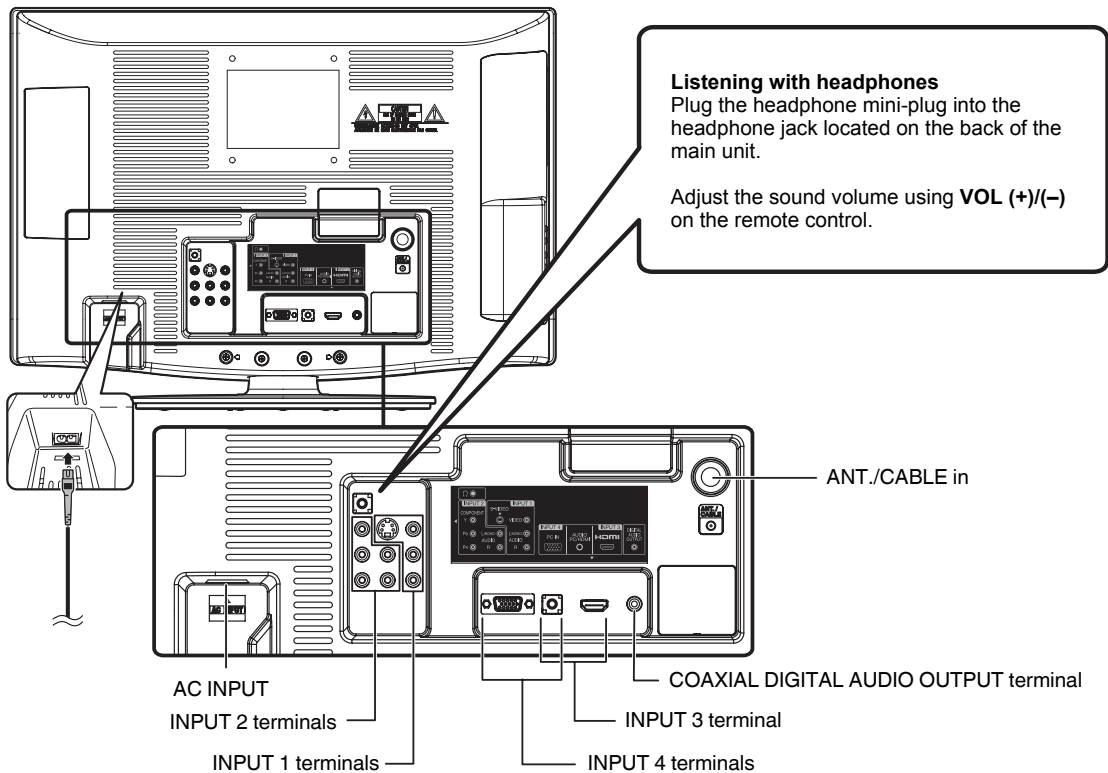

### NOTE

- The illustrations in this operation manual are for explanation purposes and may vary slightly from the actual operations.
- The examples used throughout this manual are based on the LC-22SB27UT model.

Remote control unit

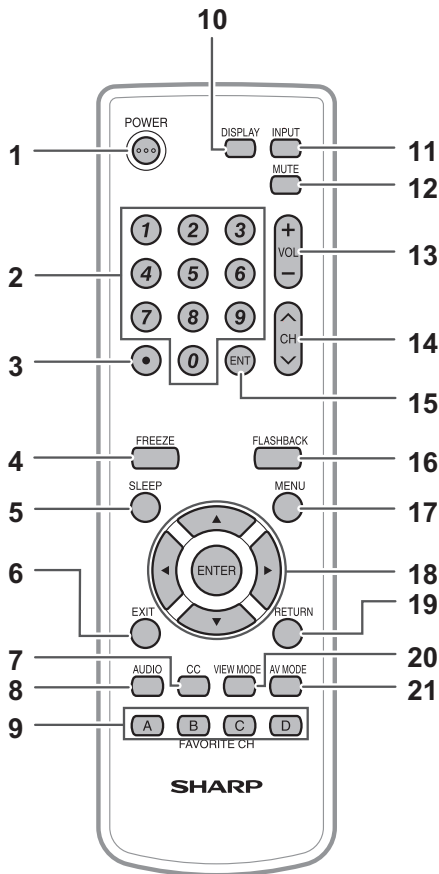

**NOTE**

- When using the remote control unit, point it at the TV. (See page 8.)

There is a protective film covering the face of the remote control. Please remove this film before use.

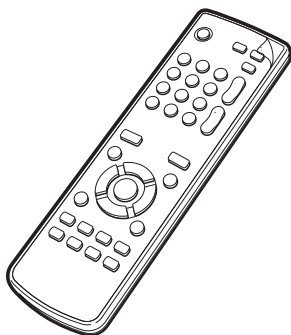

- 1 **POWER:** Switch the power on or enters standby mode. (See page 14.)
- 2 **0–9:** Set the channel. (See page 14.)
- 3 **• (DOT):** (See page 14.)
- 4 **FREEZE:** Set the still image. Press again to return to normal screen.
  - The still image automatically goes out after 30 minutes.
- 5 **SLEEP:** Allows you to set a time when the TV automatically switches to standby. Each time you press this button, the remaining time setting switches by 10 minutes up to 2 hours. This display will disappear after a few seconds, and the sleep timer automatically starts counting down.
  - If you want to adjust the sleep timer again, you can press this button repeatedly then change the time setting.
  - Select “Off” by pressing **SLEEP** repeatedly to cancel the sleep timer.
  - The TV will enter the standby mode when the remaining time reaches zero.
- 6 **EXIT:** Turn off the menu screen.
- 7 **CC:** Display captions during closed-caption source. (See page 18.)
- 8 **AUDIO:** Display the MTS setting menu. (See page 15.)
- 9 **FAVORITE CH**
  - A, B, C, D:** Select 4 preset favorite channels in 4 different categories. (See page 17 for details.)
  - While watching, you can toggle the selected channels by pressing A, B, C and D.
- 10 **DISPLAY:** Display the current channel (or input source) information on the screen. (See page 15.)
- 11 **INPUT:** Select a TV input source. (See page 13.)
- 12 **MUTE:** Mute the sound. “Mute” will be displayed on the screen, and the sound is silenced. The muting feature can be released by pressing this button again or one of the VOL +/- buttons.
  - Sound via the COAXIAL DIGITAL AUDIO OUTPUT terminal is not muted.
- 13 **VOL +/-:** Set the volume.
  - To increase the volume, press **VOL+**.
  - To decrease the volume, press **VOL-**.
  - **VOL+/-** on the TV operates the same as **VOL+/-** on the remote control unit.
- 14 **CH ^/∨:** Select the channel. (See page 14.)
- 15 **ENT:** Jumps to a channel after selecting with the **0–9** buttons.
- 16 **FLASHBACK:** Press to switch to the previously tuned channel. Press again to switch back to the currently tuned channel.
  - This function will not work if no channel has been changed after the TV is turned on.
- 17 **MENU:** Display the menu screen.
- 18 **▲/▼/◀/▶/ENTER:** Select a desired item on the screen.
- 19 **RETURN:** Return to the previous menu screen.
- 20 **VIEW MODE:** Select the screen size. (See page 16.)
- 21 **AV MODE:** Select an adjusted picture setting. (Sports, Standard, Movie, Memory.) (See page 23.)

# Preparation

## Using the remote control unit

Use the remote control unit by pointing it towards the remote control sensor on the TV. Objects between the remote control unit and the remote control sensor may prevent proper operation.

## Cautions regarding remote control unit

- Do not expose the remote control unit to shock. In addition, do not expose the remote control unit to liquids, and do not place in an area with high humidity.
- Do not install or place the remote control unit under direct sunlight. The heat may cause deformation of the remote control unit.
- The remote control unit may not work properly if the remote control sensor on the TV is under direct sunlight or strong lighting. In such cases, change the angle of the lighting or the TV, or operate the remote control unit closer to the remote control sensor.

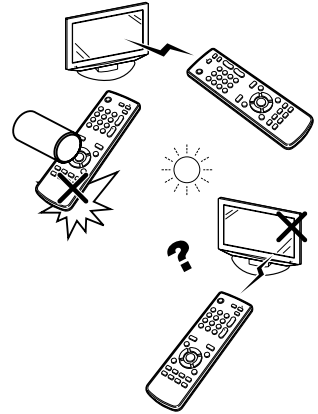

## Antennas

To enjoy a clearer picture, use an outdoor antenna. The following is a brief explanation of the types of connections that are used for a coaxial cable. If your outdoor antenna uses a 75-ohm coaxial cable with an F-type connector, plug it into the antenna terminal at the rear of the TV set.

- A 75-ohm system is generally a round cable with F-type connector that can easily be attached to a terminal without tools (Commercially available).

F-type connector

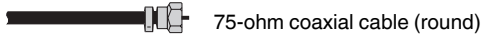

- A 300-ohm system is a flat "twin-lead" cable that can be attached to a 75-ohm terminal through a 300/75-ohm adapter (Commercially available).

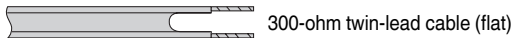

### NOTICE F-type connector should be fingertightened only.

When connecting the RF cable to the TV set, do not tighten F-type connector with tools.

If tools are used, it may cause damage to your TV set. (The breaking of internal circuit, etc.)



F-type connector

75-ohm coaxial cable

## Connecting Antenna Cable

- Cable without a CATV converter**

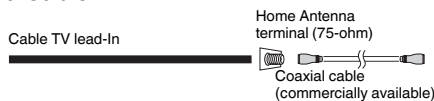

- VHF/UHF antenna**

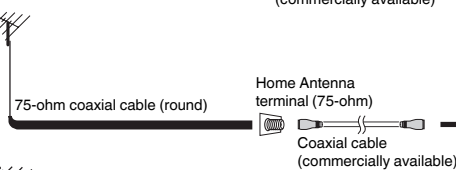

- Combination VHF/UHF antenna**

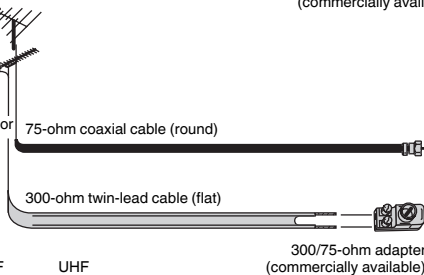

- Separate VHF/UHF antenna**

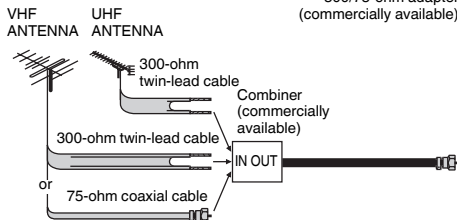

- Connect the antenna cable to the TV using one of the methods in the illustration as shown (①, ②, ③ or ④).

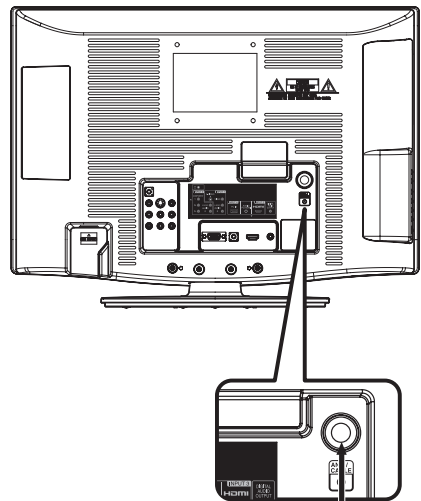

# Using external equipment

You can connect many types of external equipment to your TV like a DVD player, VCR, Digital TV tuner, HDMI equipment, game console or camcorder.

## Displaying an external equipment image

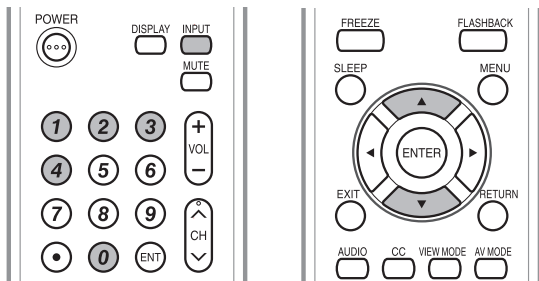

To view external source images, select the input source from "Source Selection" menu using **0-4** on the remote control.

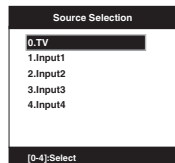

- Each time **INPUT** is pressed, "Source Selection" item toggles.
- You can also select "Source Selection" item by pressing **▲/▼**.

### CAUTION

- To protect equipment, always turn off the TV before connecting a DVD player, VCR, Digital TV tuner, HDMI equipment, game console, camcorder or other external equipment.

### NOTE

- Please read the relevant operation manual (DVD player, etc.) carefully before making connections.
- Refer to your external equipment operation manual for the signal type.

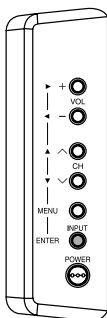

## Connecting to External Equipment

Connecting a DVD player, VCR, Digital TV tuner, HDMI equipment game console or camcorder.

Terminal on the TV	Cable	Terminal on external equipment
<b>INPUT 1</b> 		
<b>INPUT 2</b> 		
<b>INPUT 1</b> 		
<b>INPUT 3</b> 		
<b>DIGITAL AUDIO OUTPUT</b> 		

### NOTE

- The S-VIDEO terminal takes priority over the video terminals.
- When connecting an HDMI-DVI conversion adapter/cable to the HDMI terminal, the image may not come in clearly.
- When using an HDMI-DVI conversion adapter/cable, use INPUT 3 and AUDIO terminal.

# Watching TV

## Preparation

Perform the following steps before you press **POWER** on the remote control unit.

- 1 Insert the batteries into the remote control unit. (See page 8.)
- 2 Connect the antenna cable to the TV. (See page 12.)
- 3 Plug in the AC cord to the AC outlet. (See page 7.)

## Turning on the power

Press **POWER** on the TV, or **POWER** on the remote control.

### TV status indicator (POWER)

ON	Lighting (Green)
OFF/Standby	Lighting (Red)

- **POWER** indicator (Green): The TV is on. ("Please wait" will appear for a few seconds on the screen.)

## Auto Setup

The Auto Setup menu appears the first time you turn on the TV, and assists you to select the menu language, specify the Air/Cable setting, and program your channels automatically.

**IMPORTANT:** Make sure that the antenna or cable TV system connection is made!

- 1 The turn on the TV, press **POWER** (POWER indicator on the front of the unit changes green. It may take approx. 10 seconds for a picture to appear on screen.)
- 2 The "Auto Setup" function begins. Press **◀/▶** to select your desired language.
- 3 Press **▲/▼** to select "Signal Type", then press **◀/▶** to select "Cable" or "Air".

<b>Air</b>	VHF/UHF channels
<b>Cable</b>	CABLE TV channels

- 4 Press **▲/▼** to select "Automatic Search", then press **ENTER**.
- 5 The TV will begin memorizing all the channels available in your area.
  - It may take from 15 minutes to 30 minutes to complete memorizing digital cable channels. Depending on the reception condition, a BAR display may not advance for several minutes, please be patient.

### NOTE

- If you press **EXIT** in the process of "Auto Setup", the Auto Setup stops and changes to the normal screen.
- When you make a menu selection, your changes occur immediately. You do not have to press **EXIT** to see your changes.
- When you are finished programming the menus, press **EXIT**.

## Turning off the power

Press **POWER** on the TV, or **POWER** on the remote control.

- The TV enters standby mode and the image on the screen disappears.
- The **POWER** indicator on the TV changes to Red.

### NOTE

- If you are not going to use this TV for a long period of time, be sure to remove the AC cord from the power outlet.
- Weak electric power is still consumed even when **POWER** is turned off.

## Changing channels

You can change channels in several ways.

### Method 1

Using **CH** **^/∨** on the remote control unit or on the TV.

### NOTE

- If your cable-TV system includes analog and digital channels using the same channel number, your channel up function will scroll through the analog channel first, then the digital channel. Although it may appear as though the channel does not change, it actually moves from the analog to the digital channel in sequence. If you use channel-down, it will move in reverse, from the digital channel to the analog channel.

### Method 2

Using remote control buttons **0-9**, **• (DOT)** to select channels for VHF/UHF/CATV/DIGITAL.

**To select a 1 or 2-digit channel number (e. g., Channel 5):**  
Press **5**

### NOTE

- When selecting a 1-digit channel number, it is not necessary to press **0** before the number.
- When you enter **0-9** only, channel selection will be made if there is no operation within a few seconds.

**To select a 3-digit channel number (e. g., Channel 115):**  
Press **1→1→5**

**To select a 4-digit channel number (e. g., Channel 22.1):**  
Press **2→2→• (DOT)→1**

### NOTE

- When you enter **0-9** only, channel selection will be made if there is no operation within a few seconds.
- If you press **0** by itself in "Air" reception, nothing will happen.
- Complete the above steps within a few seconds.
- When you enter **0-9** and **• (DOT)**, channel selection will be made if there is no operation within a few seconds.



## Watching TV

### Auto Ch Memory

Auto Ch Memory makes the TV look for all channels viewable in the set area.

- 1 Press **MENU** and the MENU screen displays.
- 2 Press **▲/▼** to select "Channel", then press **▶** or **ENTER**. Press **▲/▼** to select "Auto Ch Memory", then press **▶** or **ENTER**.
- 3 Press **▲/▼** to select "Signal Type", then press **◀/▶** to select "Cable" or "Air".
- 4 Press **▲/▼** to select "Automatic Search", then press **ENTER**.
- 5 The TV will begin memorizing all the channels available in your area.
  - It may take from 15 minutes to 30 minutes to complete memorizing digital cable channels. Depending on the reception condition, a BAR display may not advance for several minutes, please be patient.

#### NOTE

- Memorizing channels is best accomplished during evening "PRIMETIME" hours, as more stations are broadcasting digital signals. Memorizing channels can only be accomplished while a station is broadcasting a digital signal to set that channel into memory.
- New digital channels may be added to your area periodically, it is recommended to perform the "Automatic Search" procedure regularly.

### Skipping stored channel

You can set channel selection disabled using **CH ^/∨**.

- 1 Press **MENU** and the MENU screen displays.
- 2 Press **▲/▼** to select "Channel", then press **▶** or **ENTER**.
- 3 Press **▲/▼** to select "Add/Delete", then press **▶** or **ENTER**.
- 4 Press **▲/▼** to select "Add/Delete", then press **▶** or **ENTER**.
- 5 Press **▲/▼** to select the channel that you want to skip.
- 6 Press **◀/▶** to select "Delete" for selected channel.
- 7 Press **EXIT** to return to the normal screen.

#### NOTE

- **To add a digital channel you are watching:** Select a channel you want to add. Then select "Adding Channel" in step 4, press **▶** or **ENTER**.
- **To release the skipping channel:** Select "Add" in step 6.

### Clear All

All channels are deleted from the channel memory.

- 1 Press **MENU** and the MENU screen displays.
- 2 Press **▲/▼** to select "Channel", then press **▶** or **ENTER**.
- 3 Press **▲/▼** to select "Add/Delete", then press **▶** or **ENTER**.
- 4 Press **▲/▼** to select "Clear All", then press **▶** or **ENTER**.
- 5 Press **EXIT** to return to the normal screen.

### Display the channel information

Press **DISPLAY** to display the current channel (or input source) information on the screen.

When the TV receives a digital signal, the digital information will appear for a few seconds.

- Channel number
- Channel label (if preset)
- V-Chip rating
- Sleep timer
- Program guide
- Resolution
- Station name
- Broadcast program name
- Signal type
- Audio language
- Picture size

When the TV receives an analog signal, the analog information will appear.

- Channel number
- V-Chip rating
- Sleep timer
- Picture size
- Channel label (if preset)
- Signal type
- Audio information (Stereo, SAP or Mono)
- Resolution

### Setting MTS/SAP stereo mode

The TV has a feature that allows reception of sound other than the main audio for the program. This feature is called Multi-channel Television Sound (MTS). The TV with MTS can receive mono sound, stereo sound and Secondary Audio Programs (SAP). The SAP feature allows a TV station to broadcast other information, which could be audio in another language or something completely different like weather information.

**You can enjoy Hi-Fi stereo sound or SAP broadcasts where available.**

#### • Stereo broadcasts

View programs like live sporting events, shows and concerts in dynamic stereo sound.

#### • SAP broadcasts

Receive TV broadcasts in either MAIN or SAP sound.

MAIN sound: The normal program soundtrack (either in mono or stereo).

SAP sound: Listen to a second language, supplementary commentary or other information. (SAP is mono sound.)

**If stereo sound is difficult to hear.**

- Obtain a clearer sound by manually switching to fixed mono-sound mode.

#### NOTE

- MTS only operates while in TV mode.
- MTS is available only when receiving analog broadcasting, not when receiving digital broadcasting.
- When the TV receives a stereo or SAP broadcast, the word "Stereo" or "SAP" displays on-screen if you press **DISPLAY**.

### Changing MTS

You can change MTS as shown below to match the television broadcast signal.

- 1 In analog TV mode, press **AUDIO** and the "Audio" menu screen displays. "MTS" will be highlighted.
- 2 Press **AUDIO** again or **◀/▶** to select "Stereo", "SAP" or "Mono".
- 3 Press **EXIT** to return to the normal screen.

## Selecting the digital audio language

When two or more audio languages are included in a digital signal, you can select one of the audio languages.

- 1 In digital TV mode, press **AUDIO** and the "Audio Language" menu screen displays.
- 2 Press **▲/▼** or **0-6** to select your desired language.
- 3 Press **EXIT** to return to the normal screen.

### NOTE

- Digital audio is active only when receiving digital broadcasting, not when receiving analog broadcasting.

## View mode for 4:3 programs

- 1 Press **VIEW MODE**.
  - The View mode menu displays.
  - The menu lists the view mode options selectable for the type of video signal currently being received.
- 2 Press **0-3** to select each view mode directly while the View mode menu is still on the screen.
  - Each time **VIEW MODE** is pressed, View Mode item toggles.
  - You can also select View Mode item by pressing **▲/▼**.
  - You can sequentially select a view mode that has its own aspect ratio.
  - You can select "Dot by Dot" in PC input mode.

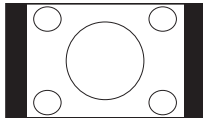

**Side Bar:**  
Suitable for viewing conventional 4:3 programs in their normal format.

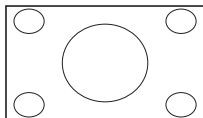

**S.Stretch (Smart stretch):**  
Suitable for stretching 4:3 programs to fill the screen.

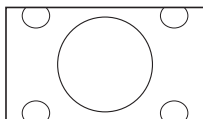

**Zoom:**  
Suitable for viewing wide-screen 2.35:1 anamorphic DVDs in full screen.

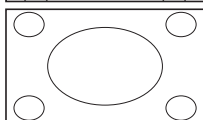

**Stretch:**  
This mode is useful for 1.78:1 DVDs. When viewing 1.85:1 DVDs, stretch mode will still show very thin black bands at the top and bottom of the screen.

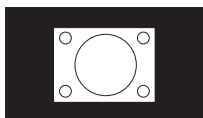

**Dot by Dot (for PC/HDMI mode only):**  
Detects the resolution of the signal of the image and it will be shown on the screen with same amount of pixels.

### NOTE

- You can enter to the same menu screen from "Picture" menu.
- You cannot select "Side Bar" and "S.Stretch" when a 720p, 1080i or 1080p signal is being input.
- Some High Definition and/or Digital broadcasts may not allow you to change the picture size.
- In PC Mode, only the "Side Bar", "Stretch" and "Dot by Dot" picture size features are available. In PC Mode (WXGA), only the "Stretch" and "Dot by Dot" picture size features are available.

## View mode for HD programs

Stretch mode is available for HD programs. Suitable for viewing wide-screen 1.78:1 aspect-ratio programs. When viewing 1.85:1 programs, the stretch mode will still show very thin black bands at the top and bottom of the screen.

## Labeling channels

### To create channel labels

- 1 Select a channel you want to label.
- 2 Press **MENU**, then press **▲/▼** to select "Channel", then press **▶** or **ENTER**. Press **▲/▼** to select "Ch Label", then press **▶** or **ENTER**. The Ch Label menu will appear.
- 3 Press **◀/▶** to select a channel you want to label, then press **▼**.

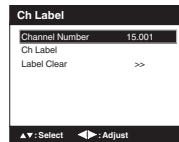

- 4 Press **◀/▶** repeatedly until the character you want appears in the first space.

The characters rotation as follows:

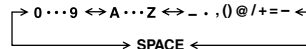

If the character which you desire appears, press **ENTER**. Repeat this step to enter the rest of the characters. When you finish inputting the label name, press **ENTER**.

- 5 Press **EXIT** to return to the normal screen.
- 6 Repeat steps 1-5 for other channels. You can assign a label to each channel.

### To erase channel labels

- 1 Select a channel with a label which you want to remove.
- 2 Press **MENU**, then press **▲/▼** to select "Channel", then press **▶** or **ENTER**. Press **▲/▼** to select "Ch Label", then press **▶** or **ENTER** to display the Ch Label menu.
- 3 Press **▲/▼** to select "Label Clear". Press **▶** or **ENTER**.
- 4 Press **EXIT** to return to the normal screen.
- 5 Repeat steps 1-4 to erase other channel labels.

### Favorite channel setting

This function allows you to program 4 favorite channels in 4 different categories. By setting the favorite channels in advance, you can select your favorite channels easily.

#### Programming favorite channel

- 1 Select the channel you want to register as a favorite channel.
- 2 Press **MENU**, then press **▲/▼** to select "Channel", then press **▶** or **ENTER**. Press **▲/▼** to select "Favorite Ch", then press **▶** or **ENTER**. The Favorite Ch menu will appear.
- 3 Press **▲/▼** to select "Set", and then press **▶** or **ENTER**.
- 4 Press **◀/▶** to select the position, and then press **ENTER** to register.
- 5 Press **EXIT** to return to the normal screen.
- 6 You can jump to the registered favorite channels directly using four **FAVORITE CH**.

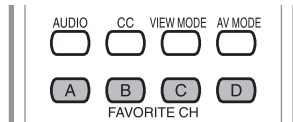

#### Deleting a favorite channel

- 1 Repeat steps 1 to 2 in above procedure.
- 2 Press **▲/▼** to select "Clear", and then press **▶** or **ENTER**.
- 3 Press **◀/▶** to select the registered favorite channel you want to release, and then press **ENTER**.
- 4 Press **EXIT** to return to the normal screen.

### Closed captions and digital closed captions

#### NOTE

- Closed Caption might not appear according to the condition of the signal from the broadcasting station.

Your TV is equipped with an internal Closed Caption decoder. It allows you to view conversations, narration and sound effects as subtitles on your TV. Closed Captions are available on some TV programs and on some VHS home video tapes at the discretion of the program provider.

Digital Closed Caption service is a new caption service available only on digital TV programs (also at the discretion of the service provider). It is a more flexible system than the original Closed Caption system, because it allows a variety of caption sizes and font styles. When the Digital Closed Caption service is in use, it will be indicated by the appearance of a 3-letter abbreviation that also indicates the language of the Digital Closed Captions: ENG (English), SPA (Spanish), FRA (French) or other language codes.

Not all programs and VHS videotapes offer closed captions. Please look for the “**CC**” symbol to ensure that captions will be shown.

In the Closed Caption system, there can be more than one caption service provided. Each is identified by its own number. The “C1” and “C2” services display subtitles of TV programs superimposed over the program’s picture. Generally, Closed Captions in English are transmitted on C1 and Closed Captions in other languages are transmitted on C2.

In the Closed Caption system, the “Text1” or “Text2” services display text that is unrelated to the program being viewed (e.g., weather or news). These services are also superimposed over the program currently being viewed.

#### NOTE

- If the program or video you selected is not closed-captioned, no captions will display on-screen.
- If text is not available in your viewing area, a black rectangle may appear on-screen. If this happens, setting the “CC Setting” to “Off”.
- When selecting Closed Captions, the captioning will be delayed approx. 10 seconds.
- If no caption signal is received, no captions will appear, but the television will remain in the Caption Mode.
- Misspellings or unusual characters may occasionally appear during Closed Captioning. This is normal with Closed Captioning, especially with live programs. This is because during live programs, captions are also entered live. These transmissions do not allow time for editing.
- When Captions are being displayed, on-screen displays, such as volume and mute may be seen but may interfere with Closed Captions.
- Some Cable TV systems and copy protection systems may interfere with the Closed Captioned signal.
- If using an indoor antenna or if TV reception is very poor, the Closed Caption Decoder may not appear or may appear with strange characters or misspelled words. In this case, adjust the antenna for better reception or use an outdoor antenna.

- 1 Tune the TV to the desired program.
- 2 Press **CC** and the Closed Caption screen displays.
- 3 Press **◀** or **▶** to setting the “CC Setting” to “On”.
- 4 Press **▲/▼** to select “Analog Caption” or “Digital Caption”.

When you select “Analog Caption”, you can choose C1, C2, C3, C4, T1, T2, T3 and T4.

When you select “Digital Caption”, you can choose from CS1, CS2, CS3, CS4, CS5 and CS6.

- 5 Press **◀/▶** to select the desired Closed Caption mode for both Digital and Analog Caption.
- 6 Press **▲/▼** to select “CC Priority”, then press **◀/▶** to select “Digital CC” or “Analog CC”.
  - Depending on the broadcast signal, some Analog Captions will function with a Digital broadcast signal. This step prevent that two kind of captions are overlapping.
- 7 Press **EXIT** to return to the normal screen.

#### NOTE

- To turn the Closed Caption feature off, setting the “CC Setting” to “Off”.
- You can enter the Closed Caption menu from setup menu.

### Caption setup

This function allows you to adjust the closed caption screen appearance to suit your preference.

- 1 Press **MENU** and the MENU screen displays.
- 2 Press **▲/▼** to select "Setup", then press **▶** or **ENTER**.
- 3 Press **▲/▼** to select "Closed Caption", then press **▶** or **ENTER**.  
The Closed Caption menu displays.
- 4 Press **▲/▼** to select "Digital CC Preset", then press **◀/▶** to select "Custom".
- 5 Press **▲/▼** to select "CC Advanced", then press **▶** or **ENTER**.
- 6 Press **▲/▼** to select the desired item, then press **◀/▶** to change the setting.
- 7 Press **EXIT** to return to the normal screen.

Selectable parameters available in each adjustment item.

Item	Selectable parameter
<b>Text Size:</b>	Auto, Small, Standard, Large
<b>Text Type:</b>	Auto, Style1, Style2, Style3, Style4, Style5, Style6, Style7
<b>Text Edge:</b>	Auto, None, Raised, Depressed, Uniform, Left Shadow, Right Shadow
<b>Text Color:</b>	Auto, Black, White, Red, Green, Blue, Yellow, Magenta, Cyan
<b>Text Opacity:</b>	Auto, Solid, Transparent, Translucent, Flashing
<b>Background Color:</b>	Auto, Black, White, Red, Green, Blue, Yellow, Magenta, Cyan
<b>Background Opacity:</b>	Auto, Solid, Transparent, Translucent, Flashing

 **NOTE**

- This feature is designed to customize Digital Captions only.
- The "Auto" value depends on the broadcasting station.

### Password setting for parental control

Allows you to use a password to protect certain settings from being accidentally changed.

**IMPORTANT:**

Three conditions must be met to enable the V-Chip

- ① Password is registered.
- ② V-Chip settings have been made.
- ③ "V-Chip" is set to "On".

**Setting a password**

- 1 Press **MENU** and the MENU screen displays.
- 2 Press **▲/▼** to select "Lock", then press **▶** or **ENTER**.
- 3 Select and enter a password (4 digits) using the **number buttons (0-9)**, then press **ENTER**.  
• "\*" appears instead of the number.
- 4 Enter the same password again to confirm, then press **ENTER**, the password is now registered and the Lock menu will appear on the screen.

**Changing the password**

Allows you to change your current password.

- 1 Repeat steps 1 to 3 in **Setting a password**.
- 2 Press **▲/▼** to select "Change Password", then press **▶** or **ENTER**.
- 3 Enter a new password using **0-9**, then press **ENTER**.
- 4 Enter the same password again to confirm, then press **ENTER**.
- 5 The screen returns to Lock menu. Your new password has been set.

 **NOTE**

- As a precautionary measure, make a note of your password and keep it in a familiar place.
- The "V-Chip Set (DTV)" will only be selectable when a new rating system can be downloaded via digital broadcasting in the U.S.

### How to enter the Lock menu

- 1 Press **MENU** and the MENU screen displays.
- 2 Press **▲/▼** to select "Lock", then press **▶** or **ENTER**.
- 3 Input the 4-digit password by using **0-9**, then press **ENTER**.  
The Lock menu displays.

### To clear the all V-Chip settings

- 1 In the Lock menu, press **▲/▼** to select "V-Chip Clear", then press **▶** or **ENTER**.
- 2 Input the 4-digit password by using **0-9**, then press **ENTER**. All your settings return to the factory settings.

## Watching TV

### Parental control (V-CHIP)

V-CHIP might not function according to the condition of the signal from the broadcasting station.

V-CHIP is an electronic filtering device built into your TV. This tool gives parents a great degree of control over broadcasts accessed by their children. It allows parents to select programs judged suitable for child viewing while blocking ones judged not suitable. It does so automatically once you activate the V-CHIP feature in your TV.

**V-CHIP menu will not be selectable from the menu if you do not first configure your password.**  
(See page 19 for password setting for parental control.)

- The U.S. has two rating systems for viewing content: movie ratings and TV Parental Guidelines.
- The TV Parental Guidelines work in conjunction with the V-CHIP to help parents screen out inappropriate television shows from their children.
- Movie ratings are used for original movies rated by the Motion Picture Association of America (MPAA) as watched on cable TV and not edited for television. The V-CHIP can also be set to block MPAA-rated movies.

### TV Parental Guidelines

TV RATING		Content				
		FANTASY VIOLENCE	VIOLENCE	SEXUAL SITUATIONS	ADULT LANGUAGE	SEXUAL DIALOG
Suggested age	TV-Y (All children)	☒	☒	☒	☒	☒
	TV-Y7 (Directed to older children)	X	☒	☒	☒	☒
	TV-G (General audience)		☒	☒	☒	☒
	TV-PG (Parental Guidance suggested)		X	X	X	X
	TV-14 (Parents strongly cautioned)		X	X	X	X
	TV-MA (Mature audience only)		X	X	X	X

☒: The content rating can be set, but this rating is not normally broadcast by TV stations.

X: Content rating can be set.

#### EXAMPLE

- If you select "TV-G", this will automatically block the higher ratings "TV-PG", "TV-14" and "TV-MA".

### Voluntary movie rating system (MPAA)

MOVIE RATING	Description
G	General audiences. All ages admitted.
PG	Parental guidance suggested. Some material may not be suitable for children.
PG-13	Parents strongly cautioned. Some material may be inappropriate for children under 13.
R	Restricted. Under 17 requires accompanying parent or adult guardian (age varies in some jurisdictions).
NC-17	No one 17 and under admitted.
X	X is an older rating that is unified with NC-17 but may be encoded in the data of older movies.

#### EXAMPLE

- If you select "PG-13", this will automatically block the higher ratings "R", "NC-17" and "X".

#### NOTE

- Voluntary movie rating system only uses an age-based rating.

### TV Parental Guidelines (TV Guidelines)

- 1 In Lock menu, press ▲/▼ to select "V-Chip", then press ◀/▶ to select "On".
- 2 Press ▲/▼ to select "V-Chip Set", then press ▶ or ENTER.
- 3 Press ▲/▼ to select "TV Rating", then press ▶ or ENTER.
- 4 Press ▲/▼/◀/▶ to select the desired rating, then press ENTER.
- 5 Press EXIT to return to the normal screen.

### Voluntary movie rating system (MPAA)

- 1 Repeat steps 1 and 2 in **TV parental Guidelines (TV Guidelines)**.
- 2 Press ▲/▼ to select "Movie Rating", then press ▶ or ENTER.
- 3 Press ▲/▼ to select the desired rating, then press ENTER.
- 4 Press EXIT to return to the normal screen.

## Watching TV

### Canadian rating systems

- The TV rating systems in Canada are based on the Canadian Radio-Television and Telecommunications Commission (CRTC) policy on violence in television programming.
- While violence is the most important content element to be rated, the structure developed takes into consideration other program content like language, nudity, sexuality and mature themes.
- When setting the V-CHIP on the Canadian system you can choose either the Canadian English ratings or the Canadian French ratings.

### Canadian English ratings

Rating	Description	
Age	E	Exempt: Includes news, sports, documentaries and other information programming; talk shows, music videos, and variety programming.
	C	Children: Intended for younger children under the age of 8 years. Pays careful attention to themes that could threaten their sense of security and well-being.
	C8+	Children over 8 years old: Contains no portrayal of violence as the preferred, acceptable, or only way to resolve conflict; nor encourage children to imitate dangerous acts which they may see on the screen.
	G	General: Considered acceptable for all age groups. Appropriate viewing for the entire family, contains very little violence, physical, verbal or emotional.
	PG	Parental Guidance: Intended for a general audience, but may not be suitable for younger children (under the age of 8) because it could contain controversial themes or issues.
	14+	Over 14 Years: Could contain themes where violence is one of the dominant elements of the storyline, but it must be integral to the development of plot or character. Language usage could be profane and nudity present within the context of the theme.
	18+	Adults: Intended for viewers 18 years and older and might contain depictions of violence, which while related to the development of plot, character or themes, are intended for adult viewing. Could contain graphic language and portrayals of sex and nudity.

**Example:** If you select “G”, this will automatically block the higher ratings “PG”, “14+” and “18+”.

### Canadian French ratings

Rating	Description	
Age	E	Exempt programming.
	G	General: All ages and children, contains minimal direct violence, but may be integrated into the plot in a humorous or unrealistic manner.
	8 ans+	General but inadvisable for young children: May be viewed by a wide public audience, but could contain scenes disturbing to children under 8 who cannot distinguish between imaginary and real situations. Recommended for viewing with parent.
	13 ans+	Over 13 years: Could contain scenes of frequent violent scenes and therefore recommended for viewing with parent.
	16 ans+	Over 16 years: Could contain frequent violent scenes and intense violence.
	18 ans+	Over 18 years: Only for adult viewing. Could contain frequent violent scenes and extreme violence.

**Example:** If you select “8 ans+”, this will automatically block the higher ratings “13 ans+”, “16 ans+” and “18 ans+”.

### Canadian English ratings

- 1 Repeat steps 1 and 2 in **TV parental Guidelines (TV Guidelines)**.
- 2 Select “CAN ENG Rating”, then press ► or **ENTER**. Press ▲/▼ to select E, C, C8+, G, PG, 14+ or 18+, then press **ENTER**.
- 3 Press **EXIT** to return to the normal screen.

### Canadian French ratings

- 1 Repeat steps 1 and 2 in **TV parental Guidelines (TV Guidelines)**.
- 2 Select “CAN FRE Rating”, then press ► or **ENTER**. Press ▲/▼ to select E, G, 8 ans+, 13 ans+, 16 ans+ or 18 ans+, then press **ENTER**.
- 3 Press **EXIT** to return to the normal screen.

### How to temporarily release the V-Chip block

The V-Chip block is working and censors a broadcast, “This program has been blocked!” displays.

- 1 Press **MUTE** while the V-Chip is working and then the password entering menu displays.
- 2 Enter your 4-digit password with **0–9**, then press **ENTER**.  
At this time V-Chip block temporarily releases.

**Reactivating the temporarily released V-Chip block**  
**Method 1:** Change to the other channel.

**Method 2:** Switch off the TV power.

#### NOTE

- Performing any of the two above will activate the V-Chip block.



# Other convenience functions

## Menu operation buttons

Use the following buttons on the remote control to operate the menu.

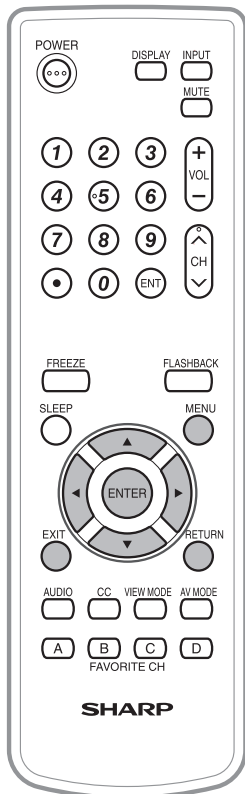

## Quick guide for MENU operation

### example : Select Language

1 Press **MENU** and the MENU screen displays.

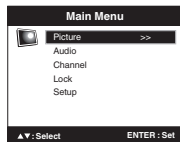

2 Press **▲/▼** to select "Setup", then press **▶** or **ENTER**.  
Press **▲/▼** to select "Language".



3 Press **◀/▶** to select the desired language.  
...on the following pages the MENU can be called in the same way as here.

4 Press **EXIT** to return to the normal screen.

### NOTE

- Some menu items may not displayed depending on the selected input source.
- If no buttons are pressed for more than approx. 60 seconds, the menu screen will return to normal Monitor screen automatically.

**MENU:** Press to open the menu screen.

**▲/▼/◀/▶:** Press to select a desired item on the screen or adjust a selected item.

**ENTER:** Press to go to the next step or complete the setting.

**RETURN:** Press to return to the previous step.





**EXIT:** Press to exit from the menu screen.  
All changed settings will be saved.

▲▼: Select   ◀▶: Adjust   ENTER: Set

The lower part of the menu screen is an operational guide for the remote control. It will change in accordance with each menu setting screen.



## Other convenience functions

Icon	Selected item		Description	
	Picture Setting	Brightness / Contrast / Sharpness / Color / Tint	You can adjust the picture quality to your preference.	
		Color Temperature	Bluish (Cool) / Neutral (Standard) / Reddish (Warm)	
		Backlight	Backlight adjusts the screen brightness for improved picture clarity.	
	AV Mode	Sports	For a clear-cut image emphasizing high contrast, useful for sports viewing.	
		Standard	For a highly defined image in a normal lighting.	
		Movie	For a movie.	
		Memory	Allows the user to customize settings as desired. You can set the mode for each input source.	
	View Mode		See page 16.	
	Film Mode	On / Off	A smoother motion may be obtained by setting the Film Mode to "On" when you view a DVD from the DVD player.	
	PC Setting* (see page 24)	Hor Position / Ver Position		To adjust the horizontal / vertical position of the image on the PC Monitor screen. Each video standard will require a different value for this setting.
Clock		To minimize any vertical bars or stripes visible on the screen background.		
Phase		This must be adjusted after the frequency has been set optimize picture quality.		
Auto Adjust		To adjust the all PC settings automatically.		
DNR	On / Off	DNR (Digital Noise Reduction) can reduce the roughness of the picture.		
	Bass / Treble / Balance		You can adjust the sound quality to your preference.	
	MTS	Stereo / SAP / Mono	See page 15.	
	Surround	On/Off	The dynamic presence and sound created offers a thoroughly enjoyable listening experience.	
	Audio Language		When two or more audio languages are included in a digital signal, you can select one of the audio languages.	
	HDMI Audio	HDMI		When you connect the HDMI device to the TV, select this setting.
		DVI		When you connect the DVI device to the TV with analog audio cords, select this setting.
	Add/Delete	Adding Channel / Add/ Delete / Clear All	See page 15.	
	DTV Signal		Select "DTV Signal", then press ► or ENTER. The Digital-Signal strength screen will appear. If necessary, adjust the direction of the antenna to obtain the maximum signal strength.	
	Auto Ch Memory	Signal Type / Automatic Search	See page 15.	
	Ch Label	Channel Number / Ch Label / Label Clear	See page 16.	
	Favorite Ch		See page 17.	
	Lock		See pages 19~21.	
	Closed Caption		See page 18.	
	Language	English / Français / Español	You can choose from three different languages (English, French and Spanish) for the on-screen displays.	
	Video Label		Let you set the input terminal displayed when using the "Source Selection" menu or channel display. Press ▲/▼ to select the specific input source which you want to change. Press ◀/▶ to select the new label for the selected input source.	
	Auto Shut Off	On / Off	In case of "Auto Shut Off" feature is "On", if a station being viewed stops broadcasting, the TV will automatically shut itself off after 15 minutes. <ul style="list-style-type: none"> <li>If Auto Shut Off is "On" and the broadcast signal is weak, the TV may automatically shut itself off. If this happens, turn Auto Shut Off to "Off".</li> </ul>	
	Reset		The Reset function returns your settings to the factory settings.	

### NOTE

- \* "PC Setting" is available only for PC INPUT (INPUT4).
- \* When you connect the PC via HDMI input, you can setting "Hor Position" and "Ver Position" only.
- \* Whenever you change the PC display resolution settings and find that the characters of the PC input has rough edges or has some flickerings, please go to PC Setting and do an "Auto Adjust" to improve the display of the PC input.

# Connecting a PC (Personal computer)

## Viewing an image from a PC

Use the INPUT4 (PC) terminals to connect a PC. (When you use HDMI cable, use the INPUT3 (HDMI) terminals.)

### NOTE

- The PC input terminals are DDC1/2B-compatible.
- Refer to "PC compatibility chart" for a list of PC signals compatible with the System.
- Make sure to select the same signal values for the output signal of a PC and the input signal of the TV set before connecting with the PC. (See page 23.)
- Depending on the PC being used, images may not be shown without converting the output signals into external output. Please refer to your PC's manuals regarding converting to external output.
- You can also connect the PC with HDMI cable. If you use HDMI cable, you don't have to connect the audio cord. If you use HDMI-to-DVI cable, please connect audio cord as same way as VGA cable.

### Connecting the RGB cable

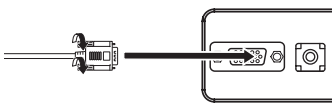

- Connect the RGB cable making sure that it fits correctly into the terminal. Then, firmly secure the connectors by tightening the screws on both sides of the plug.

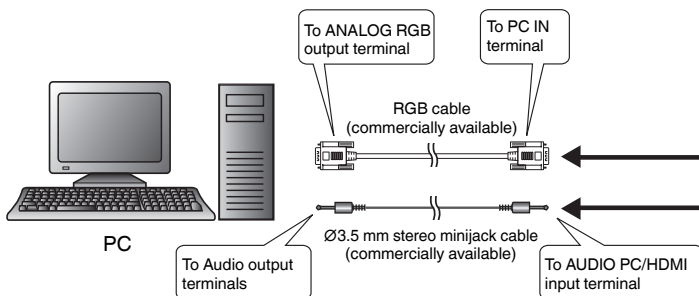
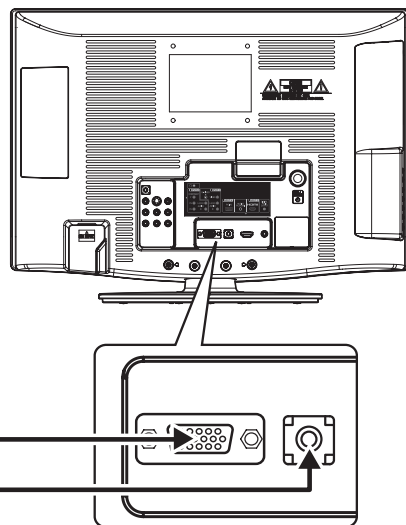

Signal names for 15-pin mini D-sub connector

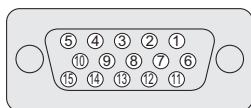

Pin No.	Signal name	Pin No.	Signal name
①	R	⑨	D-SUB_5
②	G	⑩	GND (Ground)
③	B	⑪	Not connected
④	Not connected	⑫	DDCD
⑤	DGND (Ground)	⑬	VGAHS
⑥	AGND (Ground)	⑭	VGAVS
⑦	AGND (Ground)	⑮	DDCC
⑧	AGND (Ground)		

## Displaying an image from a PC

To view an image from a PC, perform the following procedure.

- ① Select the Input4 (PC) mode using **INPUT** on the remote control or the TV set. (See page 13.)
- ② Select the PC input signal.
- ③ Adjust the "Picture" items if the PC image does not come in clearly. (See page 23.)

## PC compatibility chart

PC	Resolution	Horizontal Frequency	Vertical Frequency	VESA Standard		
PC	VGA	720 x 400	31.5 kHz	70 Hz	-	
			31.5 kHz	60 Hz	○	
		640 x 480	37.9 kHz	72 Hz	○	
			37.5 kHz	75 Hz	○	
	SVGA	800 x 600	35.1 kHz	56 Hz	○	
			37.9 kHz	60 Hz	○	
			48.1 kHz	72 Hz	○	
			46.9 kHz	75 Hz	○	
			48.4 kHz	60 Hz	○	
			60.0 kHz	75 Hz	○	
	XGA	1,024 x 768	56.5 kHz	70 Hz	○	
			60.0 kHz	75 Hz	○	
WXGA			1,280 x 720	44.8 kHz	60 Hz	○
				47.8 kHz	60 Hz	-
WXGA	1,360 x 768	47.7 kHz	60 Hz	○		

## Appendix

### Troubleshooting

Problem	Possible Solution
• No power	<ul style="list-style-type: none"> <li>• Check if you pressed <b>POWER</b> on the TV, or on the remote control unit. (See page 14.)</li> <li>• Is the AC cord disconnected? (See page 7.)</li> <li>• Has the power been turned on? (See page 14.)</li> </ul>
• Unit cannot be operated.	<ul style="list-style-type: none"> <li>• External influences such as lightning, static electricity, may cause improper operation. In this case, operate the unit after first turning off the power of the TV or unplugging the AC cord and replugging it in after 1 or 2 minutes.</li> </ul>
• Remote control unit does not operate.	<ul style="list-style-type: none"> <li>• Are batteries inserted with polarity (+, -) aligned? (See page 8.)</li> <li>• Are batteries worn out? (Replace with new batteries.)</li> <li>• Are you using it under strong or fluorescent lighting?</li> <li>• Is a fluorescent light illuminated near the remote control sensor?</li> </ul>
• Picture is cut off/with sidebar screen.	<ul style="list-style-type: none"> <li>• Are screen mode adjustments such as view mode choose made correctly? (See page 16.)</li> </ul>
• Strange color, light color, or color misalignment	<ul style="list-style-type: none"> <li>• Adjust the picture tone. (See page 23.)</li> <li>• Is the room too bright? The picture may look dark in a room that is too bright.</li> </ul>
• Power is suddenly turned off.	<ul style="list-style-type: none"> <li>• Is the sleep timer set? (See page 11.)</li> <li>• Check the Auto Shut Off settings. (See page 23.)</li> <li>• The unit's internal temperature has increased. Remove any objects blocking vent or clean.</li> </ul>
• No picture	<ul style="list-style-type: none"> <li>• Is connection to other components correct? (See page 13.)</li> <li>• Is correct input signal source selected after connection? (See page 13.)</li> <li>• Is the correct input selected? (See page 13.)</li> <li>• Is picture adjustment correct? (See page 23.)</li> </ul>
• No sound	<ul style="list-style-type: none"> <li>• Is the volume too low? (See page 11.)</li> <li>• Have you pressed <b>MUTE</b> on the remote control unit? (See page 11.)</li> </ul>
• The TV sometimes makes a cracking sound.	<ul style="list-style-type: none"> <li>• This is not a malfunction. This happens when the cabinet slightly expands and contracts according to change in temperature. This does not affect the TV's performance.</li> </ul>

### Troubleshooting-Digital broadcasting

The example of an error message displayed on a screen	Possible Solution
• Digital channel signal strength is low	<ul style="list-style-type: none"> <li>• Check the antenna cable. Check that the antenna is correctly setup.</li> </ul>
• Digital channel is scrambled	<ul style="list-style-type: none"> <li>• It is subscription channel. Contact the service provider.</li> </ul>
• Audio only	<ul style="list-style-type: none"> <li>• The channel has audio contents only.</li> </ul>

### Troubleshooting-PC mode

Problem	Possible Solution
• There is no image.	<ul style="list-style-type: none"> <li>• Make sure the RGB cable is properly connected. (See page 24.)</li> <li>• Make sure the output signal of the PC and the input signal setting of the LCD TV set are matched. (See page 24.)</li> <li>• Some software prohibit video playback on an external display when playing back a video with a notebook PC. This is not attributable to a problem with the LCD TV set.</li> </ul>
• There is no sound.	<ul style="list-style-type: none"> <li>• Make sure the PC audio cable is properly connected. (See page 24.)</li> <li>• Check if the mute function activates, or if the volume is set to minimum. (See page 11.)</li> </ul>
• The text is blurred.	<ul style="list-style-type: none"> <li>• Adjust "Clock" and "Phase" using the PC Setting menu. (See page 23.)</li> </ul>
• The image is not displayed in the center of the screen.	<ul style="list-style-type: none"> <li>• Adjust "Hor Position" and "Ver Position" using the PC Setting menu. (See page 23.)</li> </ul>

### Cautions regarding use in high and low temperature environments

- When the unit is used in a low temperature space (e.g. room, office), the picture may leave trails or appear slightly delayed. This is not a malfunction, and the unit will recover when the temperature returns to normal.
  - Do not leave the unit in a hot or cold location. Also, do not leave the unit in a location exposed to direct sunlight or near a heater, as this may cause the cabinet to deform and the Liquid Crystal panel to malfunction.
- Storage temperature: -4°F to +140°F (-20°C to +60°C)

## Specifications

Item		Model: LC-19SB27UT	Model: LC-22SB27UT
LCD panel		19" Class (18 <sup>1</sup> / <sub>2</sub> Diagonal) Active Matrix (a-Si TFT LCD)	22" Class (21 <sup>1</sup> / <sub>2</sub> Diagonal) Active Matrix (a-Si TFT LCD)
Resolution		1,049,088 pixels (1366 x 768)	
TV Function	TV-standard (CCIR)	American TV Standard ATSC/NTSC System	
	Receiving Channel	VHF/UHF	VHF 2-13ch, UHF 14-69ch
		CATV	1-135ch (non-scrambled channel only.)
		Digital Terrestrial Broadcast (8VSB)	2-69ch
		Digital Cable <sup>*1</sup> (64/256 QAM)	1-135ch (non-scrambled channel only.)
Audio multiplex		BTSC System	
Audio out		1.5W x 2	
Terminals	Rear	INPUT 1	AV in, S-VIDEO in
		INPUT 2	COMPONENT in, Audio in
		INPUT 3	HDMI in with HDCP, Audio in
		INPUT 4	15-pin mini D-sub female connector, Audio in (φ 3.5 mm jack)
		DIGITAL AUDIO OUTPUT	Coaxial Digital audio output x 1 (PCM/Dolby Digital)
		ANT/CABLE	75 Ω Unbalance, F Type x 1 for Analog (VHF/UHF/CATV) and Digital (AIR/CABLE)
		HEADPHONE	Mini-jack for stereo (φ 3.5 mm)
OSD language		English/French/Spanish	
Power Requirement		AC 120 V, 60 Hz	
Power Consumption		29 W (0.8 W Standby with AC 120V)	42 W (0.8 W Standby with AC 120V)
Weight	TV + stand	9.7 lbs./4.4 kg	10.8 lbs./4.9 kg
	TV only	8.4 lbs./3.8 kg	9.5 lbs./4.3 kg
Dimension <sup>*2</sup> (W x H x D)	TV + stand	18 <sup>19</sup> / <sub>32</sub> x 14 <sup>7</sup> / <sub>32</sub> x 7 <sup>59</sup> / <sub>64</sub> inch	21 <sup>1</sup> / <sub>8</sub> x 15 <sup>19</sup> / <sub>32</sub> x 7 <sup>59</sup> / <sub>64</sub> inch
	TV only	18 <sup>19</sup> / <sub>32</sub> x 13 <sup>5</sup> / <sub>64</sub> x 2 <sup>41</sup> / <sub>64</sub> inch	21 <sup>1</sup> / <sub>8</sub> x 14 <sup>15</sup> / <sub>32</sub> x 2 <sup>41</sup> / <sub>64</sub> inch
Operating temperature		+32°F to +104°F (0°C to +40°C)	+32°F to +104°F (0°C to +40°C)

<sup>\*1</sup> Emergency alert messages via Cable are unreceivable.

<sup>\*2</sup> The dimensional drawings are shown on the inside back cover.

- Typical time for power output decrease of about one-half assuming continuous use in a room with normal lighting, normal brightness and temperature at 77°F/25°C
- As part of policy of continuous improvement, SHARP reserves the right to make design and specification changes for product improvement without prior notice. The performance specification figures indicated are nominal values of production units. There may be some deviations from these values in individual units.

### CLEARING THE PASSWORD

If you forget the password, clear the password using the following procedure.

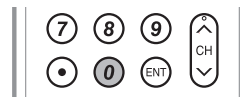
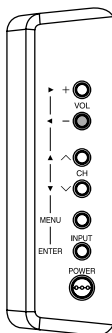

- 1 Press and hold both **VOL -** on the TV and press **0** on the remote control simultaneously for a few seconds until "Lock" menu appears on the screen.
- 2 Now the old password was cleared. You can set the new password.

The password is

--	--	--	--

#### NOTE

- As a precautionary measure, make a note of your password above, cut it from this manual, and keep it in a safe place.

# Calling for Service

For location of the nearest Sharp Authorized Service, or to obtain product literature, accessories, supplies, or customer assistance, please call 1-800-BE-SHARP.

## LIMITED WARRANTY

### CONSUMER LIMITED WARRANTY

SHARP ELECTRONICS CORPORATION warrants to the first consumer purchaser that this Sharp brand Liquid Crystal Display product (the "Product"), when shipped in its original container, will be free from defective workmanship and materials, and agrees that it will, at its option, either repair the defect or replace the defective Product or part thereof with a new or remanufactured equivalent at no charge to the purchaser for parts or labor for the period(s) set forth below.

This warranty does not apply to any appearance items of the Product or if the serial number or model number affixed to the Product has been removed, defaced, changed, altered or tampered with. This warranty does not cover installation or signal reception problems. This limited warranty will not apply if the Product has been or is being used in a commercial setting or application; this warranty is meant solely for the non-commercial, household use of the Product by consumers in their home or residence. If you intend to or already use this Product for commercial purposes or in a commercial setting, there are warranties available to cover your use of this Product, the terms of which may vary. Please contact 1-888-GO-SHARP for further information.

In order to enforce your rights under this limited warranty, you should follow the steps set forth below. You must be able to provide proof of purchase to the servicer, which proof must include the date of purchase.

To the extent permitted by applicable state law, the warranties set forth are in lieu of, and exclusive of, all other warranties, express or implied. Specifically ALL OTHER WARRANTIES OTHER THAN THOSE SET FORTH ABOVE ARE EXCLUDED, ALL EXPRESS AND IMPLIED WARRANTIES INCLUDING THE WARRANTIES OF MERCHANTABILITY, FITNESS FOR USE, AND FITNESS FOR A PARTICULAR PURPOSE ARE SPECIFICALLY EXCLUDED. IF, UNDER APPLICABLE STATE LAW, IMPLIED WARRANTIES MAY NOT VALIDLY BE DISCLAIMED OR EXCLUDED, THE DURATION OF SUCH IMPLIED WARRANTIES IS LIMITED TO THE PERIOD(S) FROM THE DATE OF PURCHASE SET FORTH BELOW. THIS WARRANTY GIVES YOU SPECIFIC LEGAL RIGHTS. YOU MAY ALSO HAVE OTHER RIGHTS WHICH VARY FROM STATE TO STATE.

The warranties given herein shall be the sole and exclusive warranties granted by Sharp and shall be the sole and exclusive remedy available to the purchaser and only for the time periods set forth herein. No other representations or promises made by anyone are permitted. Correction of defects, in the manner and for the period of time described herein, shall constitute complete fulfillment of all liabilities and responsibilities of Sharp to the purchaser with respect to the Product, and shall constitute full satisfaction of all claims, whether based on contract, negligence, strict liability or otherwise. Sharp does not warrant nor shall Sharp be liable, or in any way responsible, for Products which have been subject to abuse (including, but not limited to, improper voltage), accident, misuse, negligence, lack of reasonable care, alteration, modification, tampering, misuse, improper operation or maintenance or any damages or defects in the Product which were caused by repairs or attempted repairs performed by anyone other than a Sharp authorized servicer. Nor shall Sharp be liable or in any way responsible for any incidental or consequential economic or property damage. Some states do not allow limits on warranties or on remedies for breach in certain transactions; in such states, the limits herein may not apply.

**THIS LIMITED WARRANTY IS VALID ONLY IN THE FIFTY (50) UNITED STATES, THE DISTRICT OF COLUMBIA AND PUERTO RICO.**

### Model Specific Section

#### Your Product Model Number & Description:

LC-19SB27UT/LC-22SB27UT Liquid Crystal Television  
(Be sure to have this information available when you need service for your Product.)

#### Warranty Period for this Product:

One (1) year parts and labor from the date of purchase.

#### Additional Exclusions from Warranty Coverage (if any):

Image Retention resulting from a fixed image being displayed for long periods of time is not covered by this Limited Warranty (see Operation Manual on how to prevent this).

#### Where to Obtain Service:

From a Sharp Authorized Servicer located in the United States. To find the location of the nearest Sharp Authorized Servicer, please call Sharp toll free at 1-800-BE-SHARP.

#### What to do to Obtain Service:

Ship prepaid or carry in your Product to a Sharp Authorized Servicer. Be sure to have proof of purchase available. If you ship the Product, be sure it is insured and packaged securely. Please use two persons to carry the Product, transport it in its original packaging, and ensure that the Product is covered to avoid scratches and damage. Sharp shall not be responsible for lost, stolen or misdirected mail or for damage to the product incurred during shipping.

TO OBTAIN PRODUCT INFORMATION OR PURCHASE ACCESSORIES AND EXTENDED WARRANTIES, CALL 1-800-BE-SHARP OR VISIT [www.sharpsusa.com](http://www.sharpsusa.com)

## Free Manuals Download Website

<http://myh66.com>

<http://usermanuals.us>

<http://www.somanuals.com>

<http://www.4manuals.cc>

<http://www.manual-lib.com>

<http://www.404manual.com>

<http://www.luxmanual.com>

<http://aubethermostatmanual.com>

Golf course search by state

<http://golfingnear.com>

Email search by domain

<http://emailbydomain.com>

Auto manuals search

<http://auto.somanuals.com>

TV manuals search

<http://tv.somanuals.com>