

SHARP®

MODEL **FO-B1600**

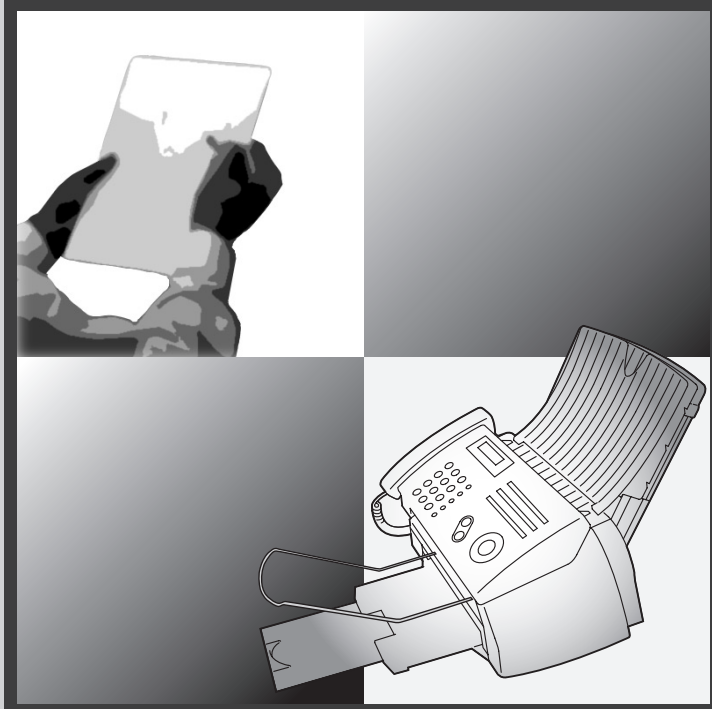

FACSIMILE OPERATION MANUAL

1. Installation
2. Sending Faxes
3. Receiving Faxes
4. Making Copies
5. Answering Machine Connection
6. Special Functions
7. Printing Lists
8. Maintenance
9. Troubleshooting

WARNING - FCC Regulations state that any unauthorized changes or modifications to this equipment not expressly approved by the manufacturer could void the user's authority to operate this equipment.

Note: This equipment has been tested and found to comply with the limits for a Class B digital device, pursuant to Part 15 of the FCC Rules. These limits are designed to provide reasonable protection against harmful interference in a residential installation. This equipment generates, uses and can radiate radio frequency energy and, if not installed and used in accordance with the instructions, may cause harmful interference to radio communications. However, there is no guarantee that interference will not occur in a particular installation. If this equipment does cause harmful interference to radio or television reception, which can be determined by turning the equipment off and on, the user is encouraged to try to correct the interference by one or more of the following measures:

- Reorient or relocate the receiving antenna.
- Increase the separation between the equipment and the receiver.
- Connect the equipment into an outlet on a circuit different from that to which the receiver is connected.
- Consult the dealer or an experienced radio/TV technician for help.

ABOUT THE TELEPHONE CONSUMER PROTECTION ACT OF 1991

"The Telephone Consumer Protection Act of 1991 makes it unlawful for any person to use a computer or other electronic device to send any message via a telephone facsimile machine unless such message clearly contains in a margin at the top or bottom of each transmitted page or on the first page of the transmission the following information:

- (1) The date and time of transmission.
- (2) Identification of either the business, business entity or individual sending the message.
- (3) Telephone number of either the sending machine, business, business entity or individual.

In order to program this information into your facsimile machine, please refer to the appropriate instructions in the operation manual."



As an ENERGY STAR® partner, SHARP has determined that this product meets the ENERGY STAR® guidelines for energy efficiency.

Introduction



Welcome, and thank you for choosing a SHARP inkjet fax machine! The features and specifications of your inkjet fax are shown below..

Automatic dialing	Rapid Key Dialing: 18 numbers Speed Dialing: 81 numbers
Print cartridge	Initial cartridge Approx. yield 300 letter pages at 4% coverage* Replacement cartridge: SHARP FO-C60B Approx. yield 600 letter pages at 4% coverage*
Memory size**	1.8 MB (approx. 100 average pages)
Modem speed	14,400 bps with auto fallback to lower speeds.
Transmission time**	Approx. 6 seconds (only when ECM is on)
Scanning Resolution	Horizontal: 203 lines/inch (8 lines/mm) Vertical: Standard: 98 lines/inch (3.85 lines/mm) Fine /Halftone: 196 lines/inch (7.7 lines/mm) Super fine: 391 lines/inch (15.4 lines/mm)
Print resolution	600 × 600 dpi
Automatic document feeder	Letter/A4: 20 pages max. (20-lb. paper) Legal: 5 pages max.
Recording system	Thermal inkjet
Halftone (grayscale)	64 levels
Compression scheme	MR, MH, MMR

*When Ink Save mode is enabled.

**Based on Sharp Standard No. 1 Chart at standard resolution, excluding time for protocol signals (i.e., ITU-T phase C time only).

Paper tray capacity	Letter: Approx. 200 sheets (20-lb. copier paper at room temperature; maximum stack height should not be higher than the line on the tray) Legal: 100 sheets Recommended paper weight: 20-lb. Copy Bond
Compatibility	ITU-T (CCITT) G3 mode
Input document size	Automatic feeding: Width: 5.8 to 8.5" (148 to 216 mm) Length (20 pages): 5.5 to 11" (140 to 279 mm) Length (5 pages): 5.5 to 14" (140 to 356 mm) Manual feeding: Width: 5.8 to 8.5" (148 to 216 mm) Length: 5.5 to 23.6" (140 to 600 mm)
Effective scanning width	8.3" (210 mm) max.
Effective printing width	8.0" (203 mm) max.
Contrast control	Automatic/Dark selectable
Reception modes	TEL/FAX/AM
Copy function	Single/Multi/Sort (99 copies/page)
Telephone function	Yes (cannot be used if power fails)
Applicable telephone line	Public switched telephone network
Display	16-digit LCD display
Power requirements	120 V AC, 60 Hz
Operating temperature	60 - 90°F (15 - 32°C)
Humidity	25 - 80% RH
Power consumption	Standby: 5.0 W Maximum: 30 W
Dimensions (without attachments)	Width: 14.6" (372 mm) Depth: 10.2" (259 mm) Height: 8.0" (203 mm)
Weight (without attachments)	Approx. 11 lbs. (5.0 kg)

As a part of our policy of continuous improvement, SHARP reserves the right to make design and specification changes for product improvement without prior notice. The performance specification figures indicated are nominal values of production units. There may be some deviations from these values in individual units.

Important:

This fax machine is not designed for use on a line which has call waiting, call forwarding, or certain other special services offered by your telephone company. If you attempt to use the fax machine in conjunction with any of these services, you may experience errors during transmission and reception of facsimile messages.

The fax machine is not compatible with digital telephone systems.

Important safety information

Do not disassemble this machine or attempt any procedures not described in this manual. Refer all servicing to qualified service personnel.

Do not install or use the machine near water, or when you are wet. For example, do not use the machine near a bath tub, wash bowl, kitchen sink or laundry tub, in a wet basement, or near a swimming pool. Take care not to spill any liquids on the machine.

Unplug the machine from the power outlet and telephone jack and consult a qualified service representative if any of the following situations occur:

- Liquid has been spilled into the machine or the machine has been exposed to rain or water.
- The machine produces odors, smoke, or unusual noises.
- The power cord is frayed or damaged.
- The machine has been dropped or the housing damaged.

Do not allow anything to rest on the power cord, and do not install the machine where people may walk on the power cord.

This machine must only be connected to a 120 V, 60 Hz, grounded (3-prong) outlet. Connecting it to any other kind of outlet will damage the machine and invalidate the warranty.

Never insert objects of any kind into slots or openings on the machine. This could create a risk of fire or electric shock. If an object falls into the machine that you cannot remove, unplug the machine and consult a qualified service representative.

Do not place this machine on an unstable cart, stand or table. The machine could be seriously damaged if it falls.

Never install telephone wiring during a lightning storm.

Never install telephone jacks in wet locations unless the jack is specifically designed for wet locations.

Never touch bare telephone wires or terminals unless the telephone line has been disconnected at the network interface.

Use caution when installing or modifying telephone lines.

Avoid using a telephone (other than a cordless type) during an electrical storm. There may be a remote risk of electric shock from lightning.

Do not use a telephone to report a gas leak in the vicinity of the leak.

The power outlet must be installed near the equipment and must be easily accessible.

Table of Contents

A Look at the Operation Panel	7
<hr/>	
1. Installation	9
<hr/>	
Unpacking Checklist	9
Attachments	10
Loading Printing Paper	14
Connecting the Power Cord	16
Installing the Print Cartridge	17
Connecting the Telephone Line Cord	24
Entering Your Name and Fax Number	26
Setting the Date and Time	28
Setting the Reception Mode	30
Volume Adjustment	31
2. Sending Faxes	33
<hr/>	
Transmittable Documents	33
Loading the Document	34
Adjusting the Resolution and Contrast	36
Sending a Fax by Normal Dialing	39
Sending a Fax by Automatic Dialing	40
Batch Page Numbering	51
Sending a Fax From Memory	52
3. Receiving Faxes	57
<hr/>	
Using FAX Mode	57
Using TEL Mode	58
Optional Reception Settings	60
Substitute Reception to Memory	63
4. Making Copies	64
<hr/>	

5. Answering Machine Connection	66
Connecting an Answering Machine	66
Using the Answering Machine Connection	67
Optional A.M. Mode Settings	68
6. Special Functions	72
Caller ID (Requires Subscription to Service)	72
Distinctive Ring (Requires Subscription to Service)	77
Blocking Reception of Unwanted Faxes	79
Polling (Requesting a Fax Transmission)	80
7. Printing Lists	85
8. Maintenance	90
Cleaning the Machine	90
Improving Print Quality	93
9. Troubleshooting	98
Problems and Solutions	98
Messages and Signals	103
Clearing Paper Jams	106
FCC Regulatory Information	109
Quick Reference Guide	113
Guía de referencia rápida	114
Index	115

A Look at the Operation Panel

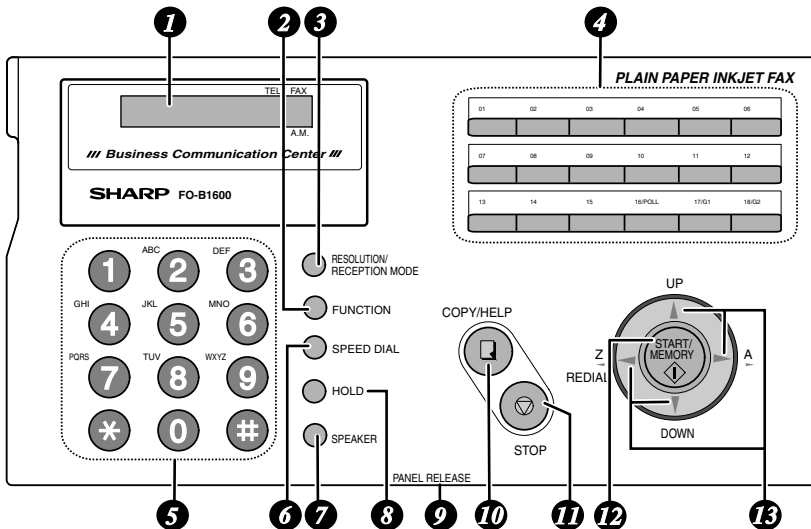

- 1 Display**
This displays messages and prompts to help you operate the machine.
- 2 FUNCTION key**
Press this key followed by the arrow keys to select special functions and settings.
- 3 RESOLUTION / RECEPTION MODE key**
When a document is in the feeder, press this key to adjust the resolution for faxing or copying. At any other time, press this key to select the reception mode (an arrow in the display will point to the currently selected reception mode).
- 4 Rapid Dial Keys**
Press one of these keys to dial a fax number automatically.
- 5 Number keys**
Use these keys to dial numbers, and enter numbers and letters when storing auto-dial numbers.
- 6 SPEED DIAL key**
Press this key to dial a fax or voice number using an abbreviated 2-digit Speed Dial number.

7

SPEAKER key

Press this key to listen to the line and fax tones through the speaker when faxing a document.

Note: **This is not a speakerphone.** You must pick up the handset to talk with the other party.

8

HOLD key

Press this key to put the other party on hold during a phone conversation. When this is done, they cannot hear you. You can put the handset back in the cradle without breaking the connection. When you are ready to speak with the other party again, pick up the handset. If you did not put the handset back in the cradle, press the **HOLD** key again to resume conversation.

9

PANEL RELEASE

Grasp here and pull up to open the operation panel.

10

COPY/HELP key

When a document is in the feeder, press this key to make a copy of a document. At any other time, press this key to print out the Help List, a quick reference guide to the operation of your fax machine.

11

STOP key

Press this key to cancel an operation before it is completed.

12

START/MEMORY key

Press this key after dialing to begin fax transmission. Press this key before dialing to send a fax through memory. The key can also be pressed in the date and time display to show the percentage of memory currently used.

13

Arrow keys

Use these keys to scroll through and select settings, and to search for auto-dial numbers.

1. Installation

Unpacking Checklist

Before setting up, make sure you have all of the following items.



If any are missing, contact your dealer or retailer.



Paper tray cover

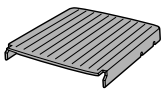

Paper tray

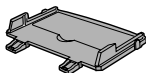

Document tray

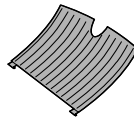

Document exit support



Print cartridge



Handset



Handset cord

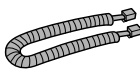

Telephone line cord

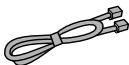

Operation manual

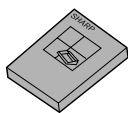

Rapid Key labels



Attachments

Points to keep in mind when setting up

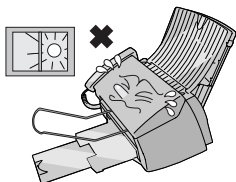

Do not place the machine in direct sunlight.

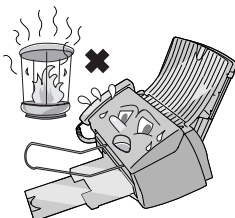

Do not place the machine near heaters or air conditioners.

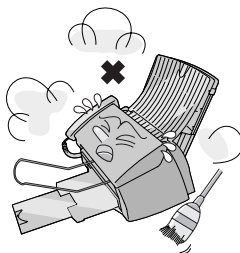

Keep dust away from the machine.

About condensation

If the machine is moved from a cold to a warm place, it is possible that condensation may form on the scanning glass, preventing proper scanning of documents for transmission. To remove the condensation, turn on the power and wait approximately two hours before using the machine.

Removing the packing tape

1 Open the print compartment cover.

- Press as shown and pull the cover toward you.

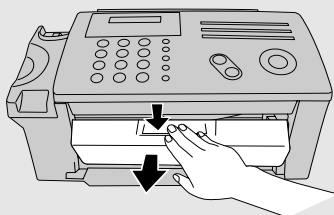

2 Remove the tape.

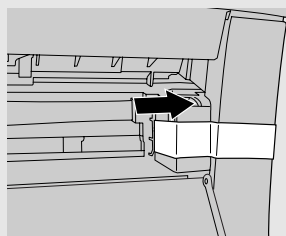

3 Close the printer cover.

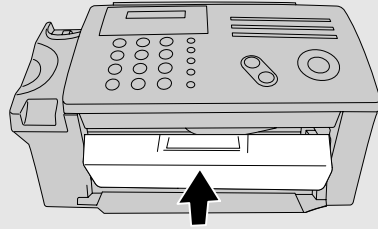

Connecting the handset

Connect the handset as shown and place it on the handset rest.

- ◆ The ends of the handset cord are identical, so they will go into either jack.

Make sure the handset cord goes into the jack marked with a handset symbol on the side of the machine!

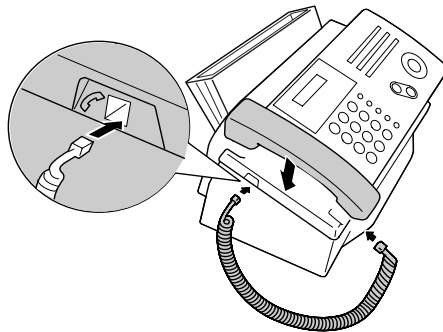

Use the handset to make ordinary phone calls, or to transmit and receive faxes manually.

Attaching the paper trays

Attach the paper tray.

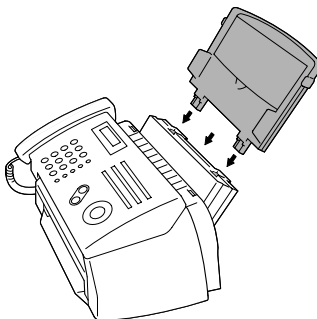

Pull the paper plate toward you and attach the paper tray cover.

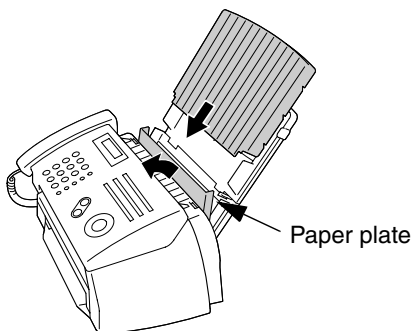

Attach the document tray.

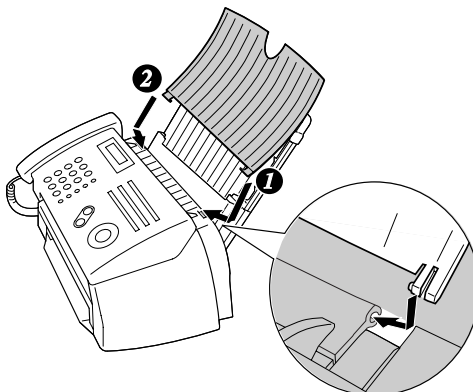

Pull out the received document tray.

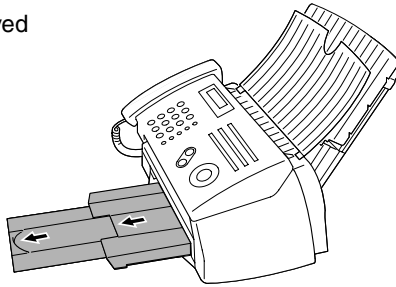

Attach the document exit support.

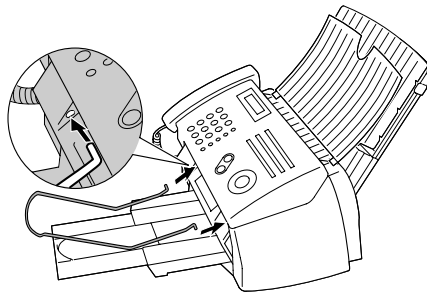

Loading Printing Paper

You can load letter or legal size paper in the paper tray. Recommended paper weight is 20-lb. Copy Bond. The maximum number of sheets is as follows:

Letter size: Approx. 200 sheets (20-lb. copier paper at room temperature; maximum stack height should not exceed line on tray)

Legal size: Approx. 100 sheets (20-lb. copier paper at room temperature)

- 1** Pull the paper plate toward you, and remove the paper tray cover from the paper tray.

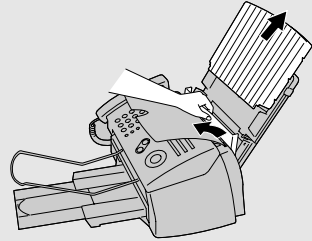

- 2** If you are going to load legal paper, flip up the paper tray extension.

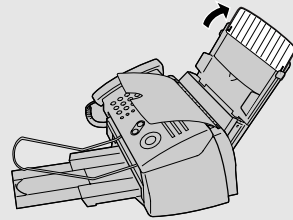

- 3** Pull the paper plate toward you and insert the stack of paper into the tray, **PRINT SIDE UP**.

- If paper remains in the tray, take it out and combine it into a single stack with the new paper.

The stack should not be higher than this line

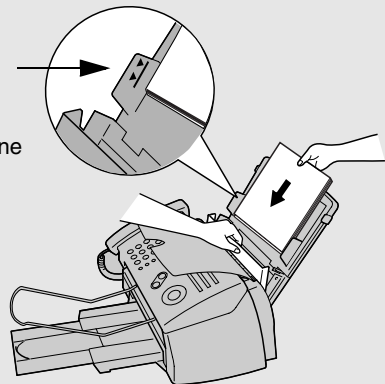

Be sure to load the paper so that printing takes place on the **print** side of the paper. Printing on the reverse side may result in poor print quality.

- 4** Pull the paper plate toward you and replace the paper tray cover.

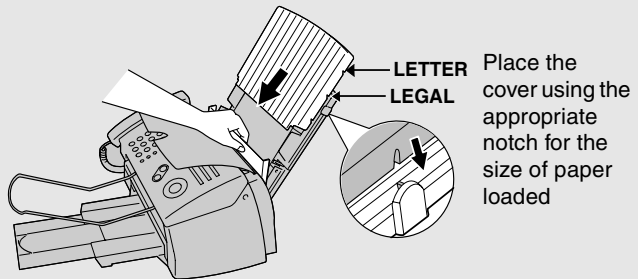

Connecting the Power Cord

Plug the power cord into a 120 V, 60 Hz, grounded AC (3-prong) outlet.

Caution!

- ◆ Do not plug the power cord into any other kind of outlet. This will damage the machine and is not covered under the warranty.
- ◆ **Make sure you have removed all of the packing tape before plugging in the power cord (see page 10).** Plugging in the power cord without doing so may damage the machine.

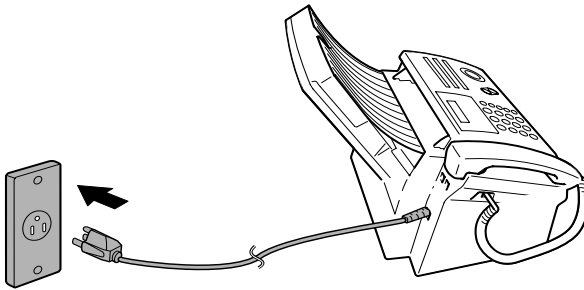

The machine does not have a power on/off switch, so the power is turned on and off by simply plugging in or unplugging the power cord.



“CHECK CARTRIDGE” normally appears in the display the first time you plug in the machine. This message appears until you install the print cartridge.

Note: If your area experiences a high incidence of lightning or power surges, we recommend that you install surge protectors for the power and telephone lines. Surge protectors can be purchased at most telephone specialty stores.

Installing the Print Cartridge

The initial starter print cartridge included with your fax can print about 300 letter-size pages.



When replacing the print cartridge, use a SHARP **FO-C60B** cartridge. One cartridge can print about 600 letter-size pages.



The above yields are at 4% coverage in INK SAVE mode.

Caution!

Do not open the print compartment cover of the machine while it is printing. If opened while printing, printing will stop.

Note: Keep ink cartridges sealed in their packages until you are ready to install them. It is recommended that you do not use a cartridge that has been left unused for a long time after opening, as the print quality may be considerably degraded.

- ◆ Make sure the power cord of the machine is plugged in and paper is loaded before installing or replacing the print cartridge.

1 Open the operation panel.

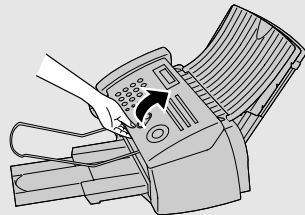

If **PRINTER ERROR** or **PRINTER ERROR/CHECK PAPER** appears...

In the event that the display shows either of the above messages, you must clear the error before installing the print cartridge. The error can usually be cleared by opening and closing the print compartment cover (see Step 2), or if a paper jam has occurred, by removing the paper jam (see page 107).

2 Open the print compartment cover.

- Press as shown and pull the cover toward you.

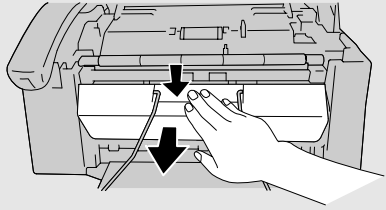

3 Remove *only* the tape from the the new cartridge.

- **Important:** Make sure you remove all of the tape.
- **CAUTION! DO NOT** touch the gold contact area of the cartridge.

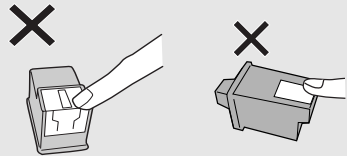
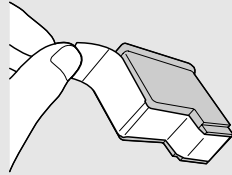

4 Make sure the cartridge holder is between the “CARTRIDGE EXCHANGE AREA” arrows on the label, and then pull the green lever and open the cartridge holder cover.

- If you are replacing the cartridge, remove the old cartridge. If you are going to use the old cartridge again, place it in an air-tight container.
- **CAUTION! DO NOT** touch the contact area inside the carriage carrier.

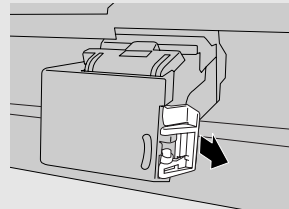
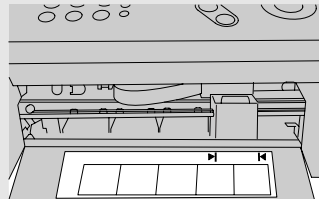

Note: If the print compartment cover is left open for approximately 30 minutes with a cartridge installed, the cartridge will automatically return to its home position. To make the cartridge return to the CARTRIDGE EXCHANGE AREA when this has happened, close the cover and then open it again.

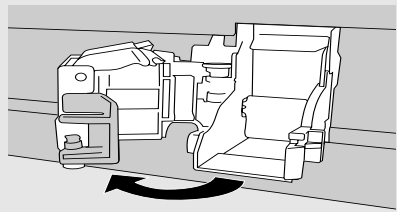

- 5** Insert the new print cartridge into the cartridge holder.

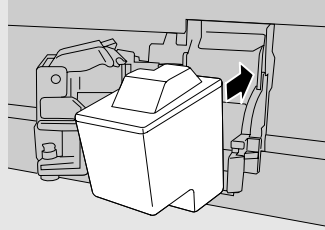

- 6** Place your index finger on the tab as shown and close the cartridge holder cover with your thumb. Make sure the cover clicks into place.

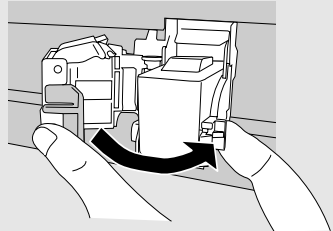

- 7** Close the print compartment cover.

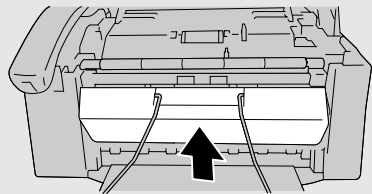

- 8** Close the operation panel, pressing down firmly on both front corners to make sure it clicks into place.

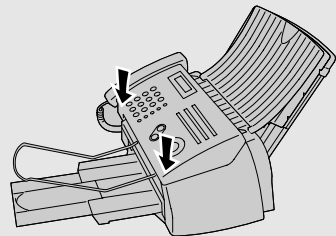

Display:

CHANGE CARTRIDGE

1=NEW, 2=OLD

9 Press **1** (NEW) if the cartridge you installed is new.

Press **2** (OLD) if the cartridge you installed is old.

If you select the wrong number by mistake,

press  and repeat the selection.

Display when "1" is selected:

NEW CART.: OK?



OK: PRESS START

10 Press .

If you selected "OLD" in the previous step, this completes the installation procedure. (Note: If you find that print quality is not satisfactory after reinstalling the old cartridge, align the cartridge as explained on page 93.)

If you selected "NEW", the display will show the alternating messages at right. Continue with the following steps to align the print cartridge.

Display when "NEW" is selected:

ALIGN CARTRIDGE



1=PRINT,2=SET

11 Press **1** to print an alignment page. (To enter an alignment value without printing an alignment page, press **2**.)

- 12** In the alignment page that the machine prints, locate the line that comes closest to forming a completely straight line.

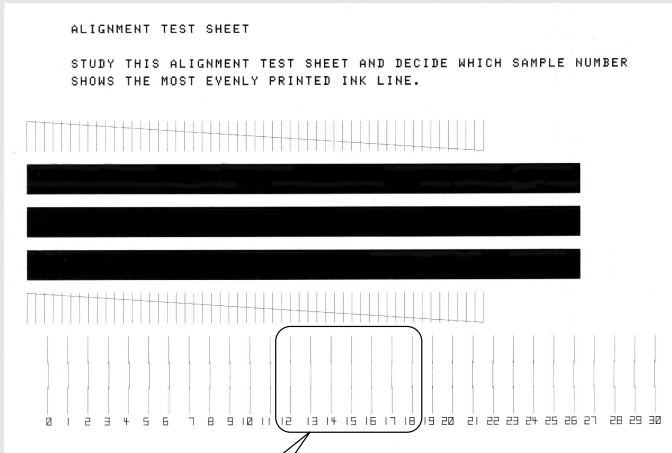

In this example, "15" comes closest to forming a straight line.

After the alignment page is printed, the display shows:

ENTER (0-30) 15

- 13** Press the number keys to enter the number of the straightest line.

Example: (1) (5)

- If you make a mistake, press  and then repeat the entry.

- 14** Press .

Installing the Print Cartridge

Note: If at any time the display shows the alternating messages at right, check the printing paper. If the tray is empty, add paper. If there is paper in the tray, take it out and then reinsert it.

When you are finished, press .

ADD PAPER &







PRESS START KEY



Setting the paper size

The fax has been set at the factory to scale received faxes to letter size paper. If you loaded legal paper, you must change the paper size setting to LEGAL.

1 Press  **FUNCTION** once and  twice. Display: 

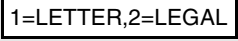
2 Press  once and  once. 

3 Press  once. 









4 Select the paper size:
LETTER:  LEGAL:  The display briefly shows your selection, then: 

5 Press  **STOP** to return to the date and time display.

Ink save mode

If you wish to use less ink or speed up ink drying time when printing faxes and copies, turn on ink save mode. If you prefer a higher quality image, turn off ink save mode.

◆ Ink save mode is initially turned off.

- 1** Press  **once** and  **twice.** Display: PRINT SET-UP 
- 2** Press  **once** and  **3 times.** INK SAVE MODE 
- 3** Press  **once.** 1=YES, 2=NO
- 4** Press 1 **to turn on ink save mode, or**
2 **to turn it off.** The display briefly shows your selection, then: ALIGN CART. 
- 5** Press  **to return to the date and time display.**

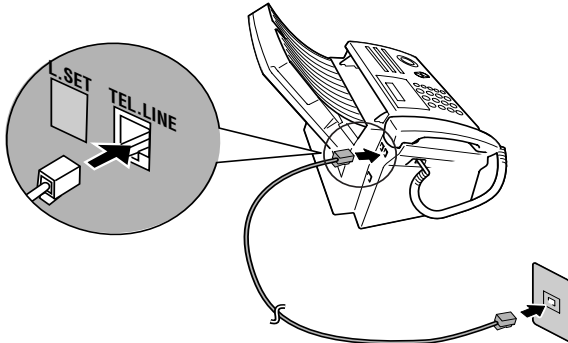

Connecting the Telephone Line Cord

Insert one end of the line cord into the jack on the back of the machine marked **TEL. LINE**. Insert the other end into a standard (RJ11C) single-line wall telephone jack.





Setting the dial mode

The fax machine is set for tone dialing. If you are on a pulse dial line, you must set the fax machine for pulse dialing. Press the panel keys as follows:

1 Press  **FUNCTION** once and  **3** times.

Display:

OPTION SETTING 



2 Press  once and  4 times.

DIAL MODE 

3 Press  once.

1=TONE, 2=PULSE

4 Select the dial mode:

TONE:  PULSE: 

The display briefly shows your selection, then:

QUIET TIME 

5 Press  **STOP** to exit.

Extension phone (optional)

If desired, you can connect an extension phone to the **TEL. SET** jack on the fax machine.

- ◆ To connect an answering machine to the fax machine, see page 66.

- 1** Remove the seal covering the **TEL. SET** jack.

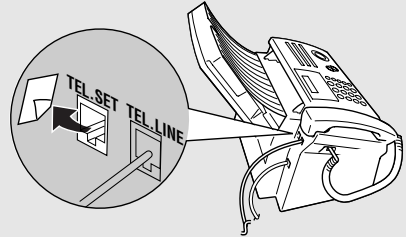

- 2** Connect the extension phone line to the **TEL. SET** jack.

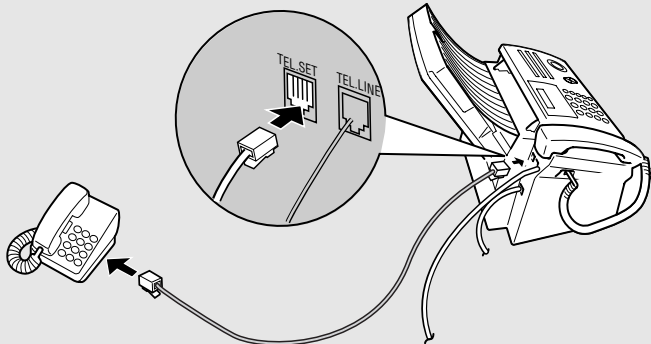

Entering Your Name and Fax Number

Before you can begin sending faxes, you must enter your name and fax (telephone) number. You also need to set the date and time.





Once you enter this information, it will automatically appear at the top of each fax page you send.

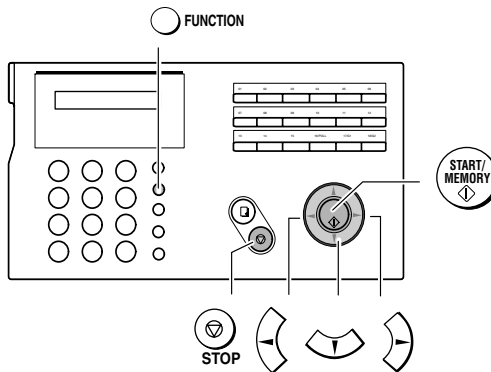

Important!

FCC regulations require that your name, telephone/fax number, and the date and time appear on each fax message you send. Enter your name and fax number here and set the date and time as explained in the following section to have the fax machine include this information automatically at the top of your fax messages.



1 Press  **FUNCTION** once and  twice.

Display:

ENTRY MODE 

2 Press  once.

OWN NUMBER SET 

3 Press  once.

ENTER FAX #

4 Enter your fax number by pressing the number keys (max. 20 digits).

- To insert a space between digits, press **#**.
- To clear a mistake, press **SPEAKER**.

5 Press .

6 Enter your name by pressing number keys for each letter as shown in the chart below. Up to 24 characters can be entered.

Example: SHARP = 7777 44 2 777  7

SPACE = 1	G = 4	N = 6 6	U = 8 8
A = 2	H = 4 4	O = 6 6 6	V = 8 8 8
B = 2 2	I = 4 4 4	P = 7	W = 9
C = 2 2 2	J = 5	Q = 7 7	X = 9 9
D = 3	K = 5 5	R = 7 7 7	Y = 9 9 9
E = 3 3	L = 5 5 5	S = 7 7 7 7	Z = 9 9 9 9
F = 3 3 3	M = 6	T = 8	

- ◆ To enter two letters in succession that require the same key, press  after entering the first letter.
- ◆ To clear a mistake, press **SPEAKER**.
- ◆ To enter a lower case letter, continue pressing the key for the letter until the lower case letter appears. To enter one of the following symbols, press **#** or ***** repeatedly: . / ! " # \$ % & ' () * + , - ; < = > ? @ [¥] ^ _ ' { | } → ←

7 Press .

Display:

SECURITY 

8 Press  to return to the date and time display.

Setting the Date and Time

The date and time appear in the display and are printed at the top of every page you fax. Set the date and time as shown below.

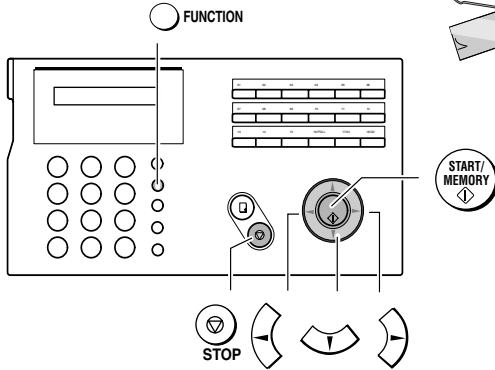
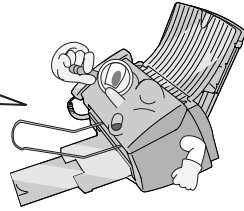

1 Press **once** and **twice**. Display: ENTRY MODE

2 Press **once** and **3 times**. DATE&TIME SET

3 Press . The currently set date appears (example): DATE 08-15-2003

4 Enter a two-digit number for the month (“01” for January, “02” for February, “12” for December, etc.).
Example: January 0 1 → DATE 01-15-2003

- To correct a mistake, press to move the cursor back to the mistake and then enter the correct number.

5 Enter a two-digit number for the day (“01” to “31”).
Example: the 5th 0 5 → DATE 01-05-2003

6 Enter the year (four digits).

Example: 2003    



The currently set time appears (example):

TIME 12:19 PM

7 Enter a two-digit number for the hour (“01” to “12”) and a two-digit number for the minute (“00” to “59”).

Example: 9:25    



TIME 09:25 PM

8 Press  to select A.M. or  to select P.M.

9 Press  to start the clock.





ANTI JUNK # 

10 Press  to return to the date and time display.



Daylight Saving Time

If desired, you can set the clock to move forward and backward automatically at the beginning and end of Daylight Saving Time. Follow these steps:

1 Press  **once** and  **3 times**.

Display:



OPTION SETTING 

2 Press  **once** and  **twice**.

DAY LIGHT SAVE 

3 Press  **once**.

1=YES, 2=NO

4 Press  to select YES, or  to select NO.

CLEAN ROLLER 

5 Press  to return to the date and time display.

Setting the Reception Mode

Your fax has three modes for receiving incoming faxes:

FAX mode:

Select this mode when you only want to receive faxes on your line. The fax machine will automatically answer all calls on four rings and receive incoming faxes.

TEL mode:

Select this mode when you want to receive both phone calls and faxes on the line connected to the fax machine. **All calls, including faxes, must be answered by picking up the fax machine's handset** or an extension phone connected to the same line.

A.M. mode:

Use this mode only if you have connected an answering machine to the fax (see Chapter 5). Select this mode when you go out to receive voice messages in your answering machine and faxes on your fax machine.

Setting the reception mode

Make sure a document *is not loaded in the document feeder*, and then

press  until the arrow in the display points to the desired mode.

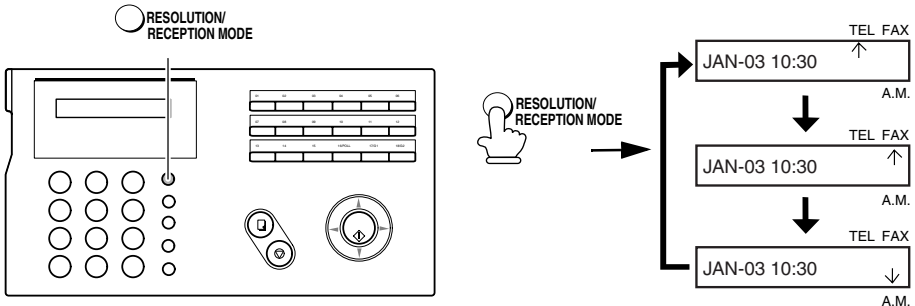

For more information on receiving faxes in FAX and TEL modes, see Chapter 3, *Receiving Faxes*. For more information on using A.M. mode, see Chapter 5.

Volume Adjustment

You can adjust the volume of the speaker, handset, and ringer using the up and down arrow keys.

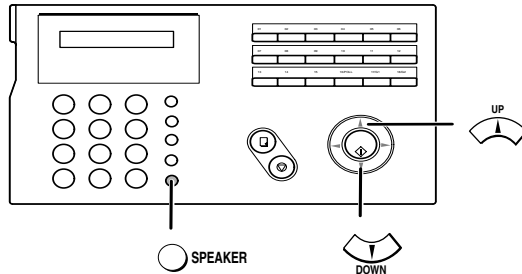

Speaker

1 Press  SPEAKER .

2 Press  or  to select the desired volume level.

- Press  SPEAKER again to turn off the speaker.

Display:

SPEAKER: HIGH





SPEAKER: MIDDLE



SPEAKER: LOW

Handset



1 When talking through the handset, press  or  to select the desired volume level.

- **Note:** The volume reverts to MIDDLE each time you replace the handset.

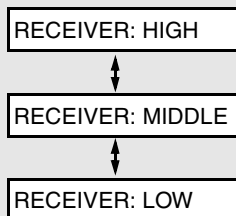
Display:





Ringer

1 Press  or  to select the desired volume level. (Make sure  has not been pressed, the handset is not lifted, and a document is not loaded in the feeder.)

- The ringer will ring once at the selected level.

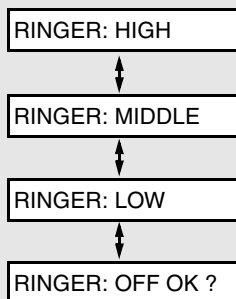
Display:



2 If you selected RINGER: OFF OK ? to turn off the ringer, press .

2. Sending Faxes

Transmittable Documents

Size and weight

Minimum document size:

Minimum size

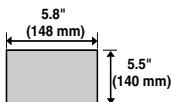

Minimum weight

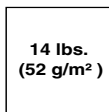

Maximum document size:

The maximum size and weight of documents that you can load in the document feeder depend on how many pages you load.

20 pages at once:

Size: Letter

(8.5" x 11", 216 x 279 mm)

Weight: 21.5 lbs. (80 g/m²)

1 page at a time (manual feeding):

Size: 8.5" x 23.6" (216 x 600 mm)

Weight: 42 lbs. (157 g/m²)

5 pages at once:

Size: Legal

(8.5" x 14", 216 x 356 mm)

Weight: 21.5 lbs. (80 g/m²)

Letters or graphics on the edges of a document will not be scanned. (The maximum scanning width is 8.3" (210 mm), and the top and bottom 0.16" (4 mm) of the document cannot be scanned.)

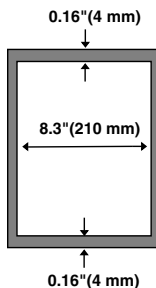

Letters in the shaded area will not be scanned.

Other restrictions

- ◆ The scanner cannot recognize yellow, greenish yellow, or light blue ink.
- ◆ Ink, glue, and correcting fluid on documents must be dry before they pass through the document feeder.
- ◆ All clips, staples, and pins must be removed from documents before loading in the feeder. If these are not removed, they may damage the machine.
- ◆ Documents which are patched, taped, torn, smaller than the minimum size, carbon backed, easily smudged, or have a slick coated surface should be photocopied, and the copy loaded in the feeder.

Loading the Document

Up to 20 letter-size pages, or 5 legal-size pages, can be placed in the feeder at once. The pages will automatically feed into the machine starting from the bottom page.

- ◆ If you need to send or copy more than the maximum number of pages, place the additional pages gently and carefully in the feeder just before the last page is scanned. Do not try to force them in, as this may cause double-feeding or jamming.
- ◆ If your document consists of several large or thick pages which must be loaded one at a time, insert each page into the feeder as the previous page is being scanned. Insert gently to prevent double-feeding.

-
- 1** Adjust the document guides to the width of your document.

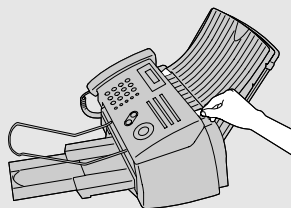

-
- 2** Insert the document face down in the document feeder. The top edge of the document should enter the feeder first.

- READY TO SEND will appear in the display.

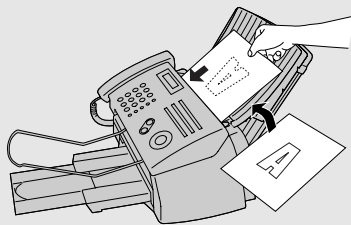

- Adjust the resolution and/or contrast settings as explained on page 36, then dial the receiving machine as explained on page 39.

Removing a document from the feeder

If you need to remove a document from the feeder, open the operation panel.



Important!

Do not try to remove a document without opening the operation panel. This may damage the feeder mechanism.

- Open the operation panel.

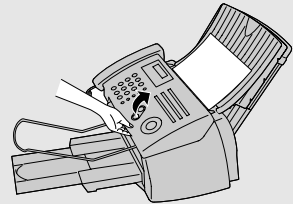

- Remove the document.

- If the document does not come out easily, follow the procedure on page 106.

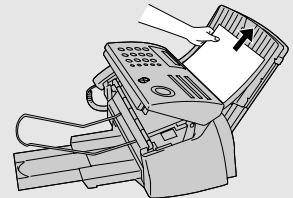

- Close the operation panel, pressing down firmly on both front corners to make sure it clicks into place.

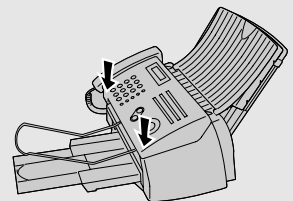

Adjusting the Resolution and Contrast

If desired, you can adjust the resolution and contrast before sending a document.

The default resolution setting is STANDARD and the default contrast setting is AUTO.



You must adjust the settings each time you don't want to use the default settings.



Note: The resolution and contrast settings are only effective for sending a document. They are not effective for receiving a document.

Resolution settings

STANDARD	Use STANDARD for ordinary documents. This setting gives you the fastest and most economical transmission.
FINE	Use FINE for documents containing small letters or fine drawings.
SUPER FINE	Use SUPER FINE for documents containing very small letters or very fine drawings.
HALF TONE	Use HALF TONE for photographs and illustrations. The original will be reproduced in 64 shades of gray.

Contrast settings

AUTO	Use AUTO for normal documents.
DARK	Use DARK for faint documents.

1 Load the document(s).

- The document must be loaded before the resolution and contrast can be adjusted.

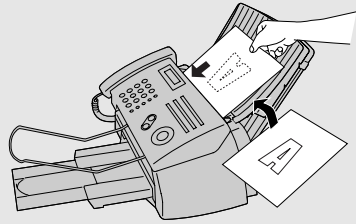

2 Press  one or more times until the desired resolution and contrast settings appear in the display.

- The first time you move through the list of resolution settings, the contrast setting AUTO will appear next to each resolution setting. The second time you move through the list, the contrast setting DARK will appear.

Display:

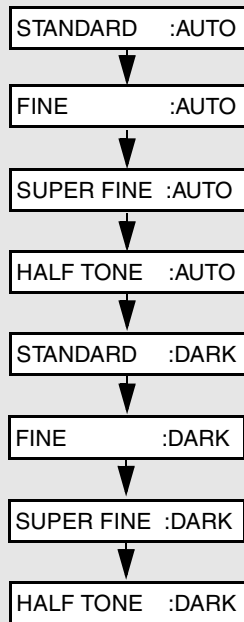



Note: In order to transmit in SUPER FINE resolution, the receiving fax machine must also have that resolution. If it doesn't, your machine will automatically step down to the next best available setting.

Changing the default resolution

If desired, you can change the default resolution for faxing documents to FINE. Follow the steps below.

1 Press  **FUNCTION** once and  **3 times.** Display: OPTION SETTING 

2 Press  once. FINE PRIORITY 

3 Press  once. 1=YES, 2=NO

4 Press 1 to set the default resolution to FINE, or 2 to set it to STANDARD. The display briefly shows your selection, then: NUMBER OF RING 

5 Press  to return to the date and time display.

Sending a Fax by Normal Dialing

With Normal Dialing, you pick up the handset (or press SPEAKER) and dial by pressing the number keys.

- ◆ If a person answers, you can talk with them through the handset before sending the fax. (If you pressed SPEAKER , you must pick up the handset to talk.)
- ◆ Normal Dialing allows you to listen to the line and make sure the other fax machine is responding.

1 Load the document(s).

- If desired, press RESOLUTION/RECEPTION MODE to set the resolution and/or contrast.

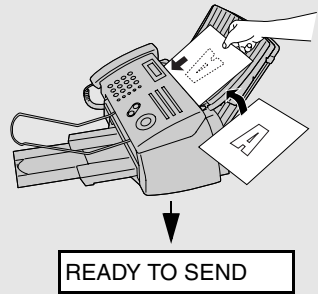

2 Pick up the handset or press SPEAKER . Listen for the dial tone.

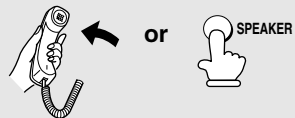

3 Dial the number of the receiving machine by pressing the number keys.



4 Wait for the connection. Depending on the setting of the receiving machine, you will either hear a fax tone or the other person will answer.

- If the other party answers, ask them to press their Start key (if you pressed SPEAKER , pick up the handset to speak with them). This causes the receiving machine to issue a fax tone.

5 When you hear the fax tone, press . Replace the handset.

- If the transmission is completed successfully, the machine will beep once.
- If an error occurs, the machine will beep three times and print a Transaction Report to inform you of the problem (see page 87).

Sending a Fax by Automatic Dialing

You can dial a fax or phone number by simply pressing a Rapid Key, or by pressing  and entering a two-digit number.

- ◆ To use Automatic Dialing, you must first store the full fax or phone number in your fax machine.
- ◆ When you store a fax or phone number, you select a two-digit Speed Dial number for it. Ninety-nine Speed Dial numbers are available.

Speed Dial numbers 01 through 18 are for Rapid Key (one-touch) Dialing.

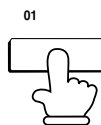

Speed Dial numbers 19 through 99 are for dialing with .

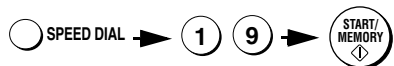

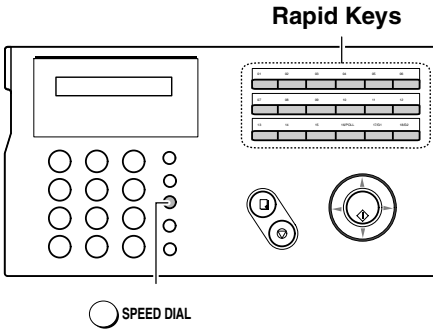

Attach the Rapid Key labels above the Rapid Keys.



When you store a number in a Rapid Key, write the name of the party on the label.

Storing fax and phone numbers for automatic dialing

1 Press **FUNCTION** once and once.

Display:

<NEW NUMBER>

2 If you know the Speed Dial number that you want to use, enter that number (for example, press

for Speed Dial 01).

Otherwise, press once (the machine will suggest an available Speed Dial number at the end of the storing procedure).

ENTER FAX #

Speed Dial numbers 01 to 18 can be used for Rapid Key Dialing. Speed Dial numbers 19 to 99 are only for Speed Dialing.

























































3 Enter the fax or phone number by pressing the number keys. (Note: A space cannot be entered.)



- To clear a mistake, press **SPEAKER**.
- If a pause is required between any of the digits to access a special service or an outside line, press **FUNCTION**. The pause appears as a hyphen (two seconds per pause). Several pauses can be entered in a row.

4 Press .

5 Enter a name by pressing number keys for each letter as shown in the chart below. Up to 20 characters can be entered. (If you do not wish to enter a name, go directly to Step 6.)

Example: SHARP = 7777 44 2 777  7

SPACE = 	G = 	N =  	U =  
A = 	H =  	O =   	V =   
B =  	I =   	P = 	W = 
C =   	J = 	Q =  	X =  
D = 	K =  	R =   	Y =   
E =  	L =   	S =    	Z =    
F =   	M = 	T = 	

- ◆ To enter two letters in succession that require the same key, press  after entering the first letter.
- ◆ To enter a lower case letter, continue pressing the key for the letter until the lower case letter appears.
- ◆ To enter one of the following symbols, press  or  repeatedly:
 . / ! " # \$ % & ' () * + , - . : ; < = > ? @ [¥] ^ _ ' { | } → ←

6 Press .

If you selected a Speed Dial number in Step 2, the display will briefly show **STORED**, and then **<NEW NUMBER>**. Go to Step 7.

If you did not select a Speed Dial number in Step 2, the display will show the next available Speed Dial number. If that number is acceptable,

press  and go to Step 7. If not, enter the desired two digit number,

press , and go to Step 7.

- 7** Return to Step 2 to store another number, or press  to return to the date and time display.





Editing and clearing auto-dial numbers

If you need to make changes to a previously stored auto-dial number, or clear a number, follow these steps:

- 1** Press  once and  once.

Display:

<NEW NUMBER> 

- 2** Enter the 2-digit Speed Dial number that you wish to edit or clear (for example, press  ) , or press  or  until the number appears in the display.



- 3** Press .

1=EDIT, 2=CLEAR

- 4** Press  for EDIT or  for CLEAR.



- If you selected CLEAR, go to Step 8.

- 5** If you selected EDIT, make the desired changes to the number.

- Press  or  to move the cursor to the digit or digits you wish to change, and then enter the new digit. The new digit will replace the old digit.
- If you do not wish to change the number, go directly to Step 6.

6 Press  .

7 Make the desired changes to the name.

- Press  or  to move the cursor to the letter or letters you wish to change, and then press the appropriate number key repeatedly until the desired letter appears (see Step 5 on page 42). The new letter will replace the old letter.
- If you do not wish to change the name, go directly to Step 8.

8 Press  .

9 Return to Step 2 to edit or clear another number, or press  to return to the date and time display.

Rapid Key Dialing

If the number you want to dial has been stored as a Speed Dial number from 01 to 18, you can dial it by pressing the corresponding Rapid Key.

1 Load the document(s).

- If desired, press  RESOLUTION/RECEPTION MODE to set the resolution and/or contrast.

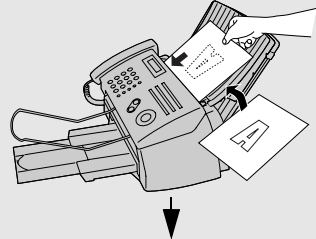

READY TO SEND

2 Press the Rapid Key corresponding to the desired Speed Dial number.

- The name of the receiving party will appear in the display. If no name was stored, the fax number will appear. (If the name or number is incorrect, press

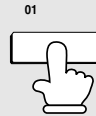

Example: To dial Speed Dial number 01, press Rapid Key 01.

- The document will be automatically transmitted once the connection is established.
- If the transmission is completed successfully, the machine will beep once.
- If an error occurs, the machine will beep three times and print a Transaction Report to inform you of the problem (see page 87).

Using a Rapid Key for a voice call

To use a Rapid Key for a voice call, simply lift the handset and then press the Rapid Key.

Speed Dialing

Speed Dialing can be used to dial any number that has been stored as a Speed Dial number.

1 Load the document(s).

- If desired, press RESOLUTION/RECEPTION MODE to set the resolution and/or contrast.

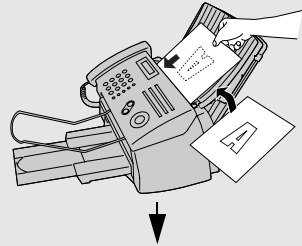

READY TO SEND

2 Press SPEED DIAL and then enter the 2-digit Speed Dial number.

- For example, to enter Speed Dial number 19, press 1 9 .

3 Check the display. If the name or number shown is correct, press



. (If not, press STOP and repeat Step 2.)



- If the transmission is completed successfully, the machine will beep once.
- If an error occurs, the machine will beep three times and print a Transaction Report to inform you of the problem (see page 87).

Using a Speed Dial number for a voice call

To use a Speed Dial number for a voice call, lift the handset, press SPEED DIAL , and enter the Speed Dial number.

Searching for an auto-dial number

If you don't remember the Rapid Key or Speed Dial number in which you have stored a full fax or phone number, follow these steps to search for the number.

1 If you are sending a fax, load the document(s).

- If desired, press  RESOLUTION/RECEPTION MODE to set the resolution and/or contrast.

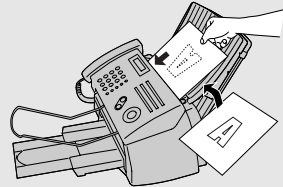

READY TO SEND

2 Press (or) until the name of the other party appears in the display (if no name was stored, the number will appear).

3 If you are sending a fax, press . Dialing and transmission begins.

- If the transmission is completed successfully, the machine will beep once.
- If an error occurs, the machine will beep three times and print a Transaction Report to inform you of the problem (see page 87).

If you are making a phone call, lift the handset. Dialing begins. (If you

lifted the handset before searching for the number, press  to begin dialing.)

Sending a fax by Direct Keypad Dialing

You can also enter a full number with the number keys and then press the



key to begin dialing. You can use this method to dial a full number when you don't need to speak to the other party before faxing.

1 Load the document(s).

- If desired, press  RESOLUTION/RECEPTION MODE to set the resolution and/or contrast.

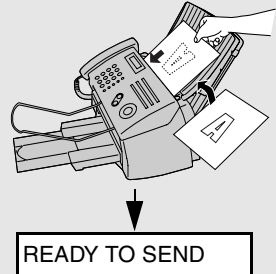

2 Enter the number of the receiving machine by pressing the number keys.

- If a pause is required between any of the digits to access a special service or an outside line, press  FUNCTION. The pause will appear as a hyphen (two seconds per pause). Several pauses can be entered in a row.

3 Check the display. If the number of the receiving machine shown is

correct, press .

- If the number is not correct, press  to backspace and clear one digit at a time, and then re-enter the correct digit(s).

Redial

You can automatically redial the last number dialed on the fax machine. This procedure can be used to send a fax or make a phone call.

1 If you are sending a fax, load the document(s).

- If desired, press  RESOLUTION/RECEPTION MODE to set the resolution and/or contrast.

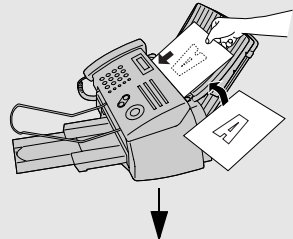

2 Press once. <REDIAL> appears in the display, followed by the last number dialed. Make sure the number that appears is the number you wish to dial.

3 If you are sending a fax, press . Dialing begins.

If you are making a phone call, lift the handset. Dialing begins.

Automatic redialing



If you use automatic dialing (including Direct Keypad Dialing) to send a fax and the line is busy, the fax machine will automatically redial the number. The fax machine will make three redial attempts at intervals of five minutes. During this time, RECALLING will appear in the display, followed by a two-digit number assigned to the fax job. You will not be able to dial any other locations while the message appears.

- ◆ You can press  to clear the message and stop automatic redialing.
- ◆ Under certain conditions (for example if a person answers the call on a telephone), automatic redialing may stop before three redialing attempts are made.

Error Correction Mode

The fax machine is set to automatically correct any distortions in a transmission due to noise on the telephone line before printing at the receiving end. This function is called Error Correction Mode (ECM). ECM is effective for both transmissions and receptions, and is only effective when the other fax machine has ECM as well.

When there is considerable noise on the line, you may find that transmission with ECM turned on takes longer than normal. If you prefer a faster transmission time, you can try turning ECM off.

1 Press  **FUNCTION** once and  **3 times.** Display: OPTION SETTING 

2 Press  once and  **3 times.** ECM MODE 

3 Press  once. 1=YES, 2=NO

4 Press 1 to select YES, or 2 to select NO. The display briefly shows your selection, then: DAY LIGHT SAVE 

5 Press  **STOP** to return to the date and time display.

Batch Page Numbering

You can change the page numbering of the transmitted document from simple numbering ("P.01", "P.02", etc.) to batch numbering, which means that a slash and the total number of pages being sent are added after each page number (for example, "P. 01/05", "P.02/05", etc.). This allows the recipient to check for missing pages.

1 Load the document(s).

- If desired, press  RESOLUTION/RECEPTION MODE to set the resolution and/or contrast.

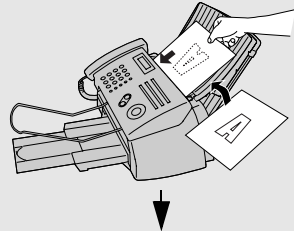

READY TO SEND

2 Press FUNCTION once and once.

Display:

PAGE COUNTER 

3 Press once.

ENTER # (01 - 99)

4 Enter the total number of pages ("01" to "99") by pressing the numeric keys.

Example: 5 pages  

5 Dial the receiving machine and send the fax.

- ◆ If you need to cancel a batch number entry, remove the document from the feeder or press  STOP.
- ◆ If the number of pages actually transmitted does not coincide with the batch number entered, the alarm will sound and PAGE COUNT ERROR will appear in the display. PAGE E. will also appear in the NOTE column of the Transaction Report if printed.

Sending a Fax From Memory

You can scan a document into the fax's memory and send the document from memory. This increases transmission speed and allows you to send a fax to multiple destinations in a single operation. After transmission, the document is automatically cleared from memory.

Note: If a power failure occurs while sending a fax from memory, you will need to repeat the operation.

Broadcasting (sending a fax to multiple destinations)

This function allows you to send the same fax to as many as 20 different destinations in just one operation.

- ◆ When sending to multiple destinations, only auto-dial numbers can be used to dial the numbers of the receiving machines.

1 Load the document(s).

- If desired, press RESOLUTION/RECEPTION MODE to set the resolution and/or contrast.

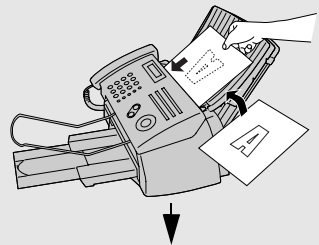



READY TO SEND

2 Press .

3 Select a destination using one of the following methods:

Press a Rapid Key.

Press SPEED DIAL and enter a 2-digit Speed Dial number.

Press  or  until the name of the destination appears in the display (if no name was stored, the number will appear).

4 Press  to store the destination.

5 Repeat Steps 3 and 4 for each of the other destinations to which you wish to send the fax (maximum of 20).

6 When you are ready to begin transmission, press .

- A Transaction Report is automatically printed out after Broadcasting is completed. Check the "Note" column of the report to see if any of the destinations are marked "Busy" or have a communication error code. If so, send the document to those destinations again.

Broadcasting using a Group Key

If the fax machines to which you want to broadcast have all been programmed into one Group Key (see *Storing numbers in Group Keys* which follows), you can perform the broadcasting operation using the following simplified procedure:

1 Load the document(s).

- If desired, press  to set the resolution and/or contrast.

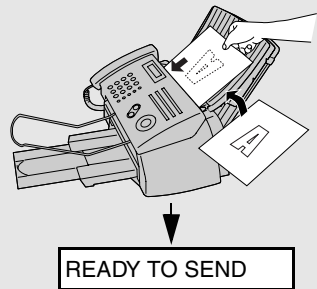

2 Press the appropriate Group Key.
Transmission will begin.

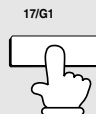

Storing numbers in Group Keys

Group Keys allow you to send a fax to a group of fax machines by simply pressing the appropriate Group Key once. To store a group of numbers in a Group Key, follow the steps below.



- ◆ Rapid Keys 17/G1 and 18/G2 can be used as Group Keys. A key cannot be simultaneously programmed as both a Group Key and a Rapid Key.
- ◆ Up to 20 numbers can be stored in one Group Key.

Only Rapid Key and Speed Dial numbers can be stored in a Group Key. Full numbers cannot be stored.

1 Press  **FUNCTION** once and  twice.

Display:

ENTRY MODE 

2 Press  once and  once.

GROUP ENTRY 

3 Press .

1=SET, 2=CLEAR

4 Press  to program a Group Key.

GROUP SET

(Press  to clear a Group Key.)

PRESS GROUP KEY

5 Press the Group Key that you wish to program (Rapid Key 17/G1 or 18/G2).

(Example)

17/G1





(If you are clearing a Group Key, press the Group Key that you wish to clear and go to Step 9.)

6 Select a destination using one of the following methods:

Press a Rapid Key.

Press  SPEED DIAL and enter a 2-digit Speed Dial number.

Press  (or ) until the name of the destination appears in the display (if no name was stored, the number will appear).

7 Press  to store the destination.

8 Repeat Steps 6 and 7 for each of the other destinations that you want to store in the Group Key (maximum of 20).









9 When you have finished storing the destinations, press .

10 Press  to return to the date and time display.

Memory transmission



You can also send a fax through memory when sending to a single destination. This is convenient when sending to destinations where the line is often busy, as it saves you from waiting to pick up the original document and frees the feeder for other operations.

To send a fax through memory, load the document, press , and then dial using one of the following methods:

- ◆ Press the number keys to enter the fax number and then press .
- ◆ Press a Rapid Key and then press .
- ◆ Press , enter a 2-digit Speed Dial number, and press .
- ◆ Press  repeatedly to select an auto-dial number and then press .
- ◆ Press  once to select the last number dialed and then press .

If the memory becomes full...

If the memory becomes full while the document is being scanned, MEMORY IS FULL will appear in the display.

- ◆ Press  if you want to transmit the pages which have been stored up to that point in memory. The remaining pages will be ejected from the feeder. After transmission, the memory will be cleared and you can transmit the remaining pages. You will also need to transmit the page which was being scanned when the memory filled up.
- ◆ Press  if you want to cancel the entire transmission.

3. Receiving Faxes

Using FAX Mode

To select FAX mode, press  (with no document in the feeder) until the arrow in the display points to FAX.

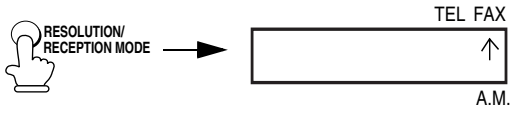

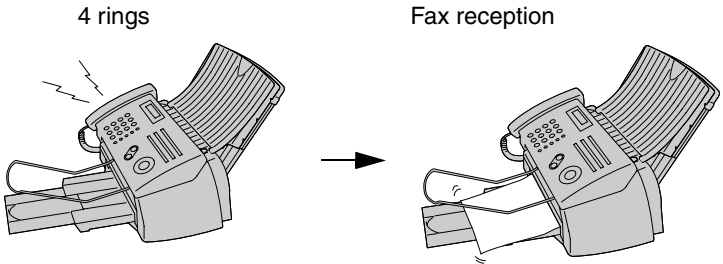

When the reception mode is set to FAX, the fax machine will automatically answer all calls on four rings and receive incoming faxes.

- ◆ If you pick up the handset before the machine answers, you can talk to the other party and/or receive a fax as explained in *Using TEL Mode* on page 58.





Changing the number of rings

If desired, you can change the number of rings on which the fax machine answers incoming calls in FAX mode. Any number from 2 to 5 can be selected.

1 Press  **once** and  **3 times.**

Display:

OPTION SETTING 

2 Press  once and  once.

NUMBER OF RING  

3 Press  once.

ENTER (2-5) (4)

4 Enter the desired number of rings (any number from 2 to 5).

The display briefly shows your selection, then:

Example: 3 rings 

FAX REMOTE #  

5 Press  to return to the date and time display.

Note: If you are using Distinctive Ring, the fax machine will answer calls after two rings regardless of the above setting.

Using TEL Mode



To select TEL mode, press  (with no document in the feeder) until the arrow in the display points to TEL.

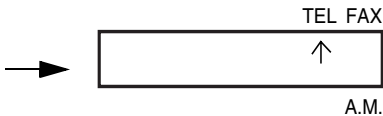

When the reception mode is set to TEL, you must answer all calls (even fax calls) by picking up the fax machine's handset or an extension phone connected to the same line.

Answering with the fax's handset

- 1** When the fax machine rings, pick up the handset.



- 2** If you hear a fax tone, wait until the display shows **RECEIVING** and then replace the handset.



RECEIVING

Note: If you have set the Fax Signal Receive setting to NO, press  to begin reception.

- 3** If the other party first speaks with you and then wants to send a fax, press



after speaking. (Press before the sender presses their Start key.)

- When RECEIVING appears in the display, hang up.



RECEIVING



Answering on an extension phone connected to the same line

- 1** Answer the extension phone when it rings.

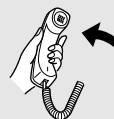

2 If you hear a soft fax tone, wait until your fax responds (you will hear pronounced, high-pitched tones), then hang up.

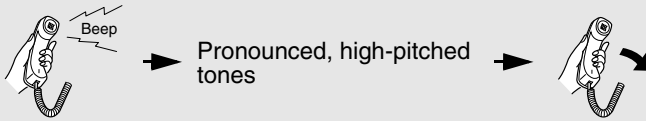

3 If the fax doesn't respond, or if the other party first talks to you and then wants to send a fax, press **5** once and ***** twice on the extension phone (only on a tone dial phone). This signals the fax to begin reception. Hang up.

- The above step is necessary if you have set the Fax Signal Receive setting to NO.
- Your fax will not accept the signal to begin reception (**5** ***** *****) if a document is loaded in its feeder.

Optional Reception Settings



Fax Signal Receive

Your fax will automatically begin reception if you hear a soft fax tone after answering a call on your fax or an extension phone. If you use a computer fax modem to send documents on the same line, you must turn this function off in order to prevent your fax from mistakenly attempting to receive documents from the computer fax modem. Follow the steps below to change the setting.

1 Press **FUNCTION** once and **∩** 3 times. Display: **OPTION SETTING** **↕**

2 Press **∩** once and **∩** 7 times. **FAX SIGNAL RX** **↕**

3 Press **∩** once. **1=YES, 2=NO**

- 4** Press  to turn on the function, or  to turn it off.



The display briefly shows your selection, then:

POLLING 



- 5** Press  to return to the date and time display.

Changing the number for remote fax activation

If desired, you can use a number other than **5** to activate fax reception from an extension telephone. You can select any number from **0** to **9**.

- 1** Press  **FUNCTION** once and  **3** times.

Display: OPTION SETTING 

- 2** Press  once and  twice.

FAX REMOTE # 

- 3** Press  once.

ENTER (0-9) (5)

- 4** Enter the desired number (any number from 0 to 9).

The display briefly shows your selection, then:

Example: 



TRANSACTION 

- 5** Press  to return to the date and time display.

Reception Ratio

The fax has been set at the factory to automatically reduce the size of received documents to fit the size of the printing paper. This ensures that data on the edges of the document are not cut off. If desired, you can turn this function off and have received documents printed at full size.

- ◆ If a document is too long to fit on the printing paper, the remainder will be printed on a second page. In this case, the cut-off point may occur in the middle of a line.
- ◆ Automatic reduction may not be possible if the received document is too large, contains too many fine graphics or images, or is sent at high resolution. In this case, the remainder of the document will be printed on a second page.

1 Press  **FUNCTION** once and  twice.

Display:



PRINT SET-UP 

2 Press  once.

RECEIVE RATIO 

3 Press  once.

1=AUTO, 2=100%

4 Press  to select **AUTO**, or  to select **100%**.

The display briefly shows your selection, then:

PAPER SIZE SET 

5 Press  to return to the date and time display.

Substitute Reception to Memory

In situations where printing is not possible, such as when your fax runs out of paper, the print cartridge needs replacement, or the paper jams, incoming faxes will be received to memory.

When you have received a document in memory, FAX RX IN MEMORY will appear in the display, alternating with ADD PAPER & PRESS START KEY, COVER OPEN, PAPER JAMMED, OUT OF INK, or PRINTER ERROR /

CHECK PAPER. When you add paper (and press ) , or clear the jam, or replace the print cartridge, the stored documents will automatically print out.

- ◆ If you received documents in memory because the fax ran out of paper, be sure to add paper which is the same size as the paper previously used. If not, the document print-out size may not match the size of the printing paper.

Caution!

- ◆ When documents are stored in memory, do not turn the power off. This will erase all of the contents.
- ◆ If documents received in memory are lost due to a power failure or other interruption in the power supply, a CLEAR REPORT will be printed out when the power is restored. This gives information about the receptions lost, including the fax numbers of the transmitting machines if they are available.

4. Making Copies

Your fax machine can also be used to make copies. Single and multiple copies (up to 99 per original) can be made, enabling your fax to double as a convenience office copier.

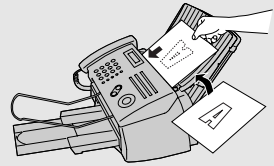

1 Load the document(s) face down. (Maximum of 20 letter pages or 5 legal pages.)

- If desired, press  RESOLUTION/RECEPTION MODE to set the resolution and/or contrast. (The default resolution setting for copying is FINE.)



READY TO SEND

2 Select any of the following copy settings as needed:

- **Enlarge/reduce:** Press  or  until the desired setting appears in the display. Settings are 100%, 125%, 135%, 200%, 70%, 88%, 94%, and AUTO (automatic adjustment to match the size of the paper). The default setting is 100%.

Example: Press  twice → COPY RATIO: 125%

- **Number of copies per original:** Press the number keys to enter a number from 1 to 99. The default setting is 1.

Example: Press 2 for two copies → 2

- **Sorted copies:** To sort the copies as shown below under “Sorted”, first set the number of copies per original (at least “2” copies must be set), and then

press  SPEED DIAL . → 2 [SORT]

Example of two copies each of three originals

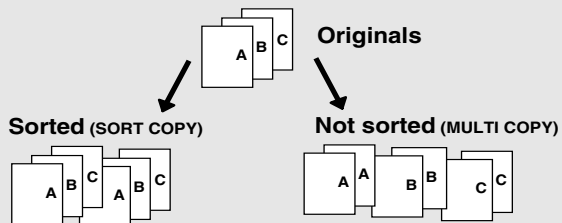

3 When you are ready to begin copying, press .



If MEMORY IS FULL appears...

If you place a large number of originals in the feeder, the memory may become full before all pages can be scanned (the display will show MEMORY

IS FULL). If this happens, press  to copy the pages that have been scanned, and then repeat the copy procedure for the remaining pages, including the page that was being scanned when the memory became full.



Copy Cut-off

When making a copy of a document that is longer than the printing paper, use the copy cut-off setting to select whether the remaining part of the document will be cut off or printed on a second page. The initial setting is YES (cut off the remainder). To change the setting, follow the steps below.

1 Press  **once** and  **twice**.

Display:



PRINT SET-UP 

2 Press  **once** and  **twice**.

COPY CUT-OFF 

3 Press  **once**.

1=YES, 2=NO

4 Press  **to set copy cut-off to YES** (the remaining part of the document will not be printed), or  **to set copy cut-off to NO** (the remaining part will be printed on a second page).

The display briefly shows your selection, then:

INK SAVE MODE 

5 Press  **to return to the date and time display.**

5. Answering Machine Connection

Connecting an Answering Machine

If desired, you can connect an answering machine to your fax machine's **TEL. SET** jack. This will allow you to receive both voice messages and faxes when you are out.

- ◆ **Important:** If the answering machine is not connected to the **TEL. SET** jack on the fax as shown, the setup will not operate properly.

- 1** Remove the seal covering the **TEL. SET** jack.

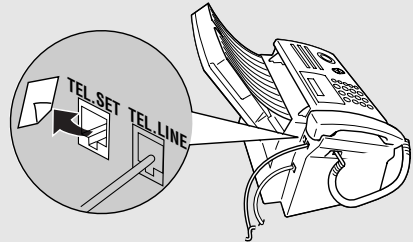

- 2** Connect the answering machine's telephone line jack to the **TEL. SET** jack.

- If desired, you can connect an extension phone to your answering machine's extension phone jack.

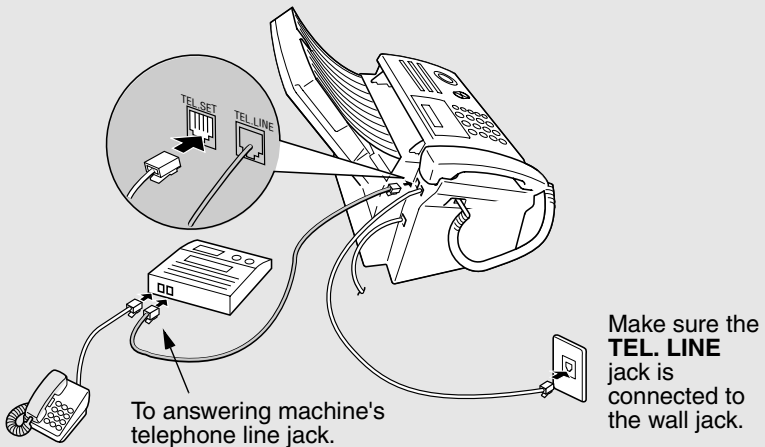

Changing the outgoing message

The outgoing message (OGM) of your answering machine should be changed to inform callers who want to send a fax to press their Start key. For example, your message might go as follows:

"Hello. You've reached the ABC company. No one is available to take your call right now. Please leave a message after the beep or press your facsimile Start key to send a fax. Thank you for calling."

- ◆ It is advisable to keep the length of the message under 10 seconds. If it is too long, you may have difficulty receiving faxes sent by automatic dialing.
- ◆ If your outgoing message must be longer than 10 seconds, leave a pause of about four seconds at the beginning of the message. This will give your fax a chance to detect fax tones sent when automatic dialing is used.

Using the Answering Machine Connection

When you go out, activate the answering machine connection as follows:

1 Set the reception mode to A.M.

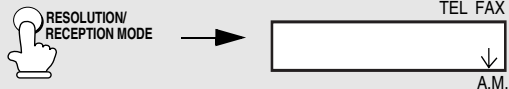

2 Set your answering machine to auto answer.

- ◆ Your answering machine must be set to answer on a maximum of two rings. If not, you may not be able to receive faxes sent by automatic dialling.
- ◆ If your answering machine has a toll saver function, make sure that it will answer by the fourth ring.

Note: If your answering machine has a remote retrieval function, make sure the code used to activate remote retrieval is different from the code used to activate fax reception with an extension telephone (see page 61). If they are the same, entering the code from an outside telephone to retrieve messages will cause the fax machine to be activated.

How answering machine mode operates

While you are out, all of your incoming calls will be answered by your answering machine and its outgoing message will play. Voice callers can leave a message. During this time, your fax will quietly monitor the line. If your fax detects a fax tone or a duration of silence greater than four seconds, it will take over the line and begin reception.

- ◆ If the connection is not good or there is noise on the line, the answering machine and/or fax machine may not respond properly.
- ◆ The call counter on your answering machine may indicate that voice messages were received, when only fax messages were received.
- ◆ To prevent the fax from taking over the line and beginning reception if you call in from an external phone or answer on an extension phone, press any three keys (other than the code to activate fax reception, "5", "* ", and "* ") on the dial pad of the phone. This can only be performed from a phone capable of tone dialling.

When you return and turn off your answering machine, be sure to change the reception mode back to FAX or TEL!



Optional A.M. Mode Settings

If necessary, you can use the following settings to improve the response of the answering machine connection to incoming calls.

Quiet Detect Time

This function causes the fax machine to take over the line and begin reception if a certain duration of silence is detected after the answering machine answers.



Time selections for the period of silence are 1 to 10 seconds. Quiet Detect Time has been set to 4 seconds at the factory. This gives the best performance with most answering machines; however, you may need to adjust this setting depending on the disconnect time of your answering machine.

Some answering machines may have unusually fast disconnect times (equal to or very slightly less than 4 seconds), which means that the answering machine may disconnect the line before fax reception can begin. In this case, try a Quiet Detect Time setting of about 3 seconds.

If the fax machine is interrupting callers before they can leave a message, try a longer Quiet Detect Time setting. If your outgoing message includes a period of silence, make sure that the setting is longer than that period of silence, or re-record your outgoing message to shorten the silence.



Note: Quiet Detect Time can be turned off by entering "00" for the time. Note, however, that the fax machine will not be able to receive faxes sent manually by Normal Dialing.

To change the setting, follow the steps below.

1 Press  **once and**  **3 times.**

Display:

OPTION SETTING 

2 Press  **once and**  **5 times.**

QUIET TIME 

3 Press  **once.**

ENTER (00-10) 04

4 Enter a number from 01 to 10, or enter 00 to turn off the function.

The display briefly shows your selection, then:

QUIET START 



Example: 3 seconds  

5 Press  **to return to the date and time display.**

Quiet Detect Start Time



This setting can be used to delay the start of the Quiet Detect Time function. For example, if you want to insert a pause at the beginning of your answering machine's outgoing message to ensure clear detection of fax signals, you can use this setting to delay the start of silence detection so that the pause will not cause the fax to take over the line.

Quiet Detect Start Timing has been set to five seconds at the factory. You can change this setting by entering a 2-digit number equal to the desired number of seconds of the delay, or turn the function off by entering **00**. As general guide, the delay time should be slightly longer than the pause before the outgoing message.

1 Press  **FUNCTION** once and  **3 times.**

Display:

OPTION SETTING 

2 Press  once and  **6 times.**

QUIET START 

3 Press  once.

ENTER (00-15) 05

4 Enter a 2-digit number (from 01 to 15) for the number of seconds of the delay, or enter **00** to turn off the function.

The display briefly shows your selection, then:

ON TAD FAILURE 

Example: 3 seconds  

5 Press  **STOP** to return to the date and time display.



On TAD Failure

When this function is turned on, your fax will answer the call after 5 rings if the answering machine for some reason fails to answer before that time. This ensures that you will receive fax messages even if the answering machine's tape fills up or the answering machine is not turned on.

This function has been turned off at the factory. If you want to turn it on, follow the steps below:



Note:

When this function is turned on, make sure that the answering machine is set to answer on 4 rings or less. If it isn't, the fax will always answer first, preventing callers from leaving voice messages.

1 Press  **once and**  **3 times.**

Display:



OPTION SETTING 

2 Press  **once and**  **7 times.**

ON TAD FAILURE 

3 Press  **once.**

1=YES, 2=NO

4 Press  **to turn on the function, or**
 **to turn it off.**

The display briefly shows your selection, then:

DISTINCTIVE 

5 Press  **to return to the date and time display.**

6. Special Functions



Caller ID (Requires Subscription to Service)

If you subscribe to a caller identification service from your telephone company, you can have the fax machine display the name and number of the caller when you receive a call.

Important:



To use this function, you must subscribe to a caller identification service from your telephone company. Note that your fax may not be compatible with some caller identification services.

- ◆ **Area Code mode:** This step is needed if your telephone exchange cannot dial a local phone number (within your calling area code) when the area code is dialed with the phone number (see Step 5).

1 Press  **FUNCTION** once and  **3** times.

Display:



OPTION SETTING 

2 Press  once and  **5** times.

CALLER-ID 

3 Press  once.



1=YES, 2=NO

4 Press  **(YES)** to turn on Caller ID.
(To turn off Caller ID, press  and go to Step 8.)

AREA CODE # MODE



1=SET, 2=CLEAR

5 Press  to select SET.
(To clear a previously set area code, press  and go to Step 8.)

ENTER AREA CODE

Note: Entering your area code in this step causes it to be automatically removed from local numbers in the Caller ID list (page 74). This is only required if you need to eliminate dialing of the area code when dialing a local number from the list. Example (using the area code "123"): If Step 5 is skipped, the Caller ID display will show 123-444-1234, and the number that will dial from the Caller ID list is 123-444-1234. If the area code 123 is entered in Step 5, the Caller ID display will show 444-1234, and the number that will dial from the Caller ID list is 444-1234.

6 Enter the three digits of your area code.

7 Press  to store your area code.

AUTO PRINT OUT 

8 Press  to return to the date and time display.

How Caller ID operates

When you receive a call, the name and phone number of the caller will appear in the display, beginning just before the second ring. The information will continue to be displayed until the line is disconnected.

Display example

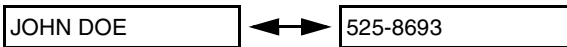

Caller's name

Caller's number

Note: Some caller ID services may not provide the name of the caller. In this case, only the phone number will appear.

Display messages

One of the following messages will appear while the fax rings if caller information is not available.

NO SERVICE	No caller information was received from your telephone company. Make sure that the telephone company has activated your service.
CALLER-ID ERROR	Noise on the telephone line prevented reception of caller information.
OUT OF AREA	The call was made from an area which does not have a caller identification service, or the caller's service is not compatible with that of your local phone company.
PRIVATE CALL	Caller information was not provided by the telephone company at the caller's request.

Viewing the Caller ID list

If you subscribe to a Caller ID service and have turned on the Caller ID function, your fax machine will keep information on the most recent 30 calls and faxes you have received. You can view this information, which consists of the name and number of each caller, in the Caller ID List.

- ◆ After you have received 30 calls, each new call will delete the oldest call.

Follow the steps below to view the Caller ID List in the display. If desired, you can immediately dial a number when it appears.

1 Press  twice.



<REVIEW CALLS> 

2 Press  or  to scroll through the list.

3 If you wish to dial one of the numbers in the list, scroll through the list until the number appears in the display.

- **Fax:** If you wish to send a fax, load the document and then press . Dialing and transmission begin.



- **Voice call:** If you wish to make a voice call, pick up the handset (or press ). Dialing begins automatically. (If you pressed , pick up the handset when the other party answers.)



4 Press  when you have finished viewing the list.

To delete calls from the Caller ID list



If you want to delete a single call from the caller list, press **0** while the call appears in the display. If you want to delete all calls from the list, hold **0** down for at least 3 seconds while you are viewing any number in the list.

Priority Call

If you have turned on Caller ID, you can set the machine to make a special ringing sound when you receive a call from a designated phone number. This lets you know immediately who is calling without having to look at the display.

To use this function, enter the desired phone number by following the steps below (only one phone number can be entered).



1 Press  **once** and  **twice.** Display: ENTRY MODE 

2 Press  **once** and  **twice.** PRIORITY # 

3 Press  **once.** 1=SET, 2=CLEAR

4 Press **1** to store a number.
(To clear a previously stored number, press **2** and go to Step 6.)

5 Enter the number by pressing the number keys (max. 20 digits).

6 Press  to store (or clear) the number. GROUP ENTRY 

7 Press  to return to the date and time display.

Blocking voice calls

If you have turned on Caller ID, you can use the Anti Junk Fax function described in *Blocking Reception of Unwanted Faxes* in this chapter to block voice calls as well as faxes from your specified Anti Junk Number.

In this case, when a voice call or a fax transmission comes in from the number you have specified as a "Junk Number", your fax will break the connection as soon as it receives the calling phone number from the caller ID service (before the second ring).

To use this function, enter the number that you wish to block as explained in *Blocking Reception of Unwanted Faxes* (see page 79). Only one number can be blocked.

Note: This function cannot be used if you are using the Distinctive Ring function.



Distinctive Ring (Requires Subscription to Service)

Important:

- ◆ **To use distinctive ring, you must subscribe to a distinctive ring service from your local phone company.**
- ◆ Note that your fax machine may not be compatible with some distinctive ring services.



Distinctive ring is a service offered by some local telephone companies whereby they assign an additional second number to your regular single line. The second number rings differently from your normal number.

If you subscribe to a distinctive ring service, you can set the fax machine to automatically answer when your second number is called. This allows you to use the second number as an exclusive fax number. To have your fax automatically answer when your second number is called, follow the steps below:

1 Press  **FUNCTION** once and  **3 times.**

Display:

OPTION SETTING 

2 Press  once and  **8 times.**

DISTINCTIVE 

3 Press  once.

4 Press a number from 1 to 3 to select the ring pattern below that matches your second number's ring pattern. Press 4 to have your fax automatically answer your normal telephone number. Press 5 to turn off the distinctive ring function.

- | | | |
|---|----------------|---|
| ① | RING PATTERN 1 | Two short rings |
| ② | RING PATTERN 2 | One short, one long, and one short ring |
| ③ | RING PATTERN 3 | Two short rings and one long ring |
| ④ | STANDARD RING | Your standard (normal) ring pattern |
| ⑤ | OFF SETTING | Turn distinctive ring off |

The display briefly shows your selection, then:

FAX SIGNAL RX 

5 Press  to return to the date and time display.



6 Set the reception mode to FAX.



- ◆ When using distinctive ring, you must set the reception mode of your fax machine to FAX. When your designated fax number is dialed, your fax will automatically answer and begin reception after two rings. Note that other devices on the same line will also ring until your fax answers. If one of your other numbers is dialed, the fax will ring; however, it will not answer.



Blocking Reception of Unwanted Faxes

The Anti Junk Fax function allows you to block reception of faxes from a party that you specify. This saves paper by not printing out unwanted "junk" faxes. To use this function, follow the steps below to enter the fax number from which you do not wish to receive faxes. One fax number can be entered.

1 Press  **FUNCTION** once and  twice.

Display:



ENTRY MODE 

2 Press  once and  3 times.

ANTI JUNK # 

3 Press  once.

1=SET, 2=CLEAR

4 Press  to store an Anti Junk number, or  to clear a previously stored number (if you are clearing a number, go to Step 6).

5 Enter the fax number by pressing the number keys (max. 20 digits).



6 Press  and then press  to return to the date and time display.

Polling (Requesting a Fax Transmission)

Polling allows you to call another fax machine and have it send a document (previously loaded in its feeder) to your machine without operator assistance. In other words, the receiving fax machine, not the transmitting fax machine, initiates the transmission.



To use the polling function, you must first set Rapid Key 16/POLL for use as a polling key.

- ◆ When Rapid Key 16/POLL is set as a polling key, it cannot be used for Rapid Key dialing.

1 Press  **once and**  **3 times.**

Display:



OPTION SETTING 

2 Press  **once and**  **6 times.**

POLLING 

3 Press  **once.**

1=YES, 2=NO

4 Press  **to use Rapid Key 16/POLL as a polling key.**
(To turn off the polling function, press
 **.)**

The display briefly shows your selection, then:

CALLER-ID 

5 Press  **to return to the date and time display.**

Requesting transmission

1 Dial the fax machine you want to poll using one of the following methods:

- Pick up the handset (or press the **SPEAKER** key) and dial the full number. Wait for the fax answerback tone.
- Pick up the handset (or press the **SPEAKER** key) and press a Rapid Key. Wait for the fax answerback tone.
- Press the **SPEED DIAL** key and enter a 2-digit Speed Dial number.
- Enter the full number using the numeric keys.

2 Press .

- If you used the handset, replace it when POLLING appears in the display. Reception will begin.

Being polled (polling standby)

To let another fax machine poll your fax, press  RESOLUTION/RECEPTION MODE to set the reception mode to FAX and load the document(s).

Transmission will take place when the other fax machine calls your machine and activates polling. Automatic reception is possible while your fax is on polling standby.



Polling (Requesting a Fax Transmission)

Polling security



Polling Security allows you to prevent unauthorized polling of your machine. When this function is turned on, polling will only take place when the fax number of the polling fax machine has been entered in your machine's list of permitted fax numbers (called "passcode numbers"). The number of the polling fax must also be correctly programmed into itself for identification.



To use Polling Security, follow the steps below to turn the function on, and then enter permitted numbers as explained on the following page.

1 Press  **FUNCTION** once and  twice. Display: ENTRY MODE 

2 Press  once and  once. SECURITY 

3 Press . 1=ON, 2=OFF

4 Press  to turn on polling security.
(Press  to turn off polling security.)



5 Press . The display briefly shows your selection, then:
PASSCODE MODE 



6 Press  to return to the date and time display.

Storing fax numbers for polling permission

You can store up to 10 fax numbers in your machine's list of permitted numbers.



1 Press  **FUNCTION** once and  **twice.** Display: ENTRY MODE 

2 Press  once and  twice. PASSCODE MODE 

3 Press . <NEW CODE> 

4 Press . ENTER FAX #

5 Enter the fax number (maximum of 20 digits).



6 Press . <NEW CODE> 



7 Return to Step 4 to store another number, or press  to return to the date and time display.



Editing and clearing polling permission numbers

If you need to make changes to a previously stored polling permission number, or clear a number, follow these steps:

1 Press  **FUNCTION** once and  twice. Display: ENTRY MODE 

2 Press  once and  twice. PASSCODE MODE 

3 Press . <NEW CODE> 



4 Press  or  until the number you want to edit or clear appears in the display.



5 Press . 1=EDIT, 2=CLEAR

6 Press **1** for EDIT or **2** for CLEAR.

- If you selected CLEAR, go to Step 8.

7 If you selected EDIT, make the desired changes to the number.



- Press  or  to move the cursor to the digit or digits you wish to change, and then enter the new digit. The new digit will replace the old digit.

8 Press . <NEW CODE> 

9 Return to Step 4 to edit or clear another number, or press  to return to the date and time display.

7. Printing Lists

You can print lists showing settings and information entered in the fax machine, and a report showing recent fax transactions. The lists and report are described below. To print a list or report, follow these steps.

1 Press  **once and**  **once.**

Display:

LISTING MODE 

2 Press  **once.**

ACTIVITY LIST 

3 Press  or  **until the desired list appears in the display.**

4 Press  **once.**

PRESS START KEY

5 Press  **to print the list.**

Activity Report

This report shows information on your most recent 30 fax transactions. The report is divided into two parts: the TRANSMISSIONS ACTIVITY REPORT, which shows information on fax transmissions, and the RECEPTIONS ACTIVITY REPORT, which shows information on fax receptions.

- ◆ All information is erased after a report is printed out. If information on 30 fax transactions accumulates, the information on the oldest transaction will be deleted each time a new transaction takes place.
- ◆ You can have the Activity Report printed out automatically each time information on 30 fax transactions accumulates. See page 89.
- ◆ The Activity Report contains the same headings as the Transaction Report. See page 87 for an explanation of the headings.

Telephone Number List

This list shows the fax and phone numbers that have been stored for automatic dialing.

Group List

This list shows the fax numbers that have been stored in each Group Key.

Setup List

This list shows your current selections for the **FUNCTION** key settings. The list also shows your name and fax/telephone number as entered in the machine, and a sample of the header printed at the top of every page you transmit (**HEADER PRINT**).

SETUP LIST		OCT-19-2002 08:39 PM
FOR:		

ENTRY MODE		
POLLING MODE		SECURITY OFF
PASSCODE #		
ANTI JUNK #		
PRIORITY CALL #		
SENDER'S NAME		
SENDER'S TELEPHONE #		
HEADER PRINT		
OCT-19-2002 08:39 PM		P.01

OPTION SETTING		
FINE PRIORITY		NO
NUMBER OF RINGS IN AUTO ANSWER MODE		4 RINGS
TEL/FAX REMOTE #		(5)***
TRANSACTION PRINT SELECT		ERROR ONLY
DIAL MODE		TO NE
QUIET DETECT TIME		04S
QUIET DETECT START TIMING		0SS
FAX ANSWER WHEN TAD FAILS		NO
DISTINCTIVE RINGING		OFF
FAX SIGNAL RECEIVE		YES
POLLING		NO
CALLER-ID		NO
AUTO PRINT OUT		NO
ECH MODE		YES
DAY LIGHT SAVING TIME		NO

PRINT SET-UP		
RECEPTION RATIO		AUTO
PAPER SIZE SET		LETTER
COPY CUT OFF		YES
INK SAVE MODE		NO
ALIGN CARTRIDGE		15

Caller-ID List

This list shows information on your 30 most recently received calls and faxes. (This list is only available if you are using the Caller ID function.)

Transaction Report

This report is printed out automatically after an operation is completed to allow you to check the result. Your fax machine is set at the factory to print out the report only when an error occurs.

- ◆ The Transaction report cannot be printed on demand.

Headings in the Transaction Report

SENDER/RECEIVER The name or fax number of the other machine involved in the transaction. If that machine does not have an ID function, the communication mode will appear (for example, "G3").

START The time at which transmission/reception started.

TX/RX TIME Total time taken for transmission/reception.

PAGES Number of pages transmitted/received.

NOTE (One of the following notes will appear under **NOTE** in the report to indicate whether the transaction was successful, and if not, the reason for the failure.)

OK - Transmission/reception was successful.

P.FAIL - A power failure prevented the transaction.

JAM - The printing paper or document jammed, preventing the transaction.



BUSY - The fax was not sent because the line was busy.

COM.E-X - (Where "X" is a number.) A telephone line error prevented the transaction. See *Line error* on page 98.

CANCEL - The transaction was cancelled because the **STOP** key was pressed, no document was in the feeder, or the other machine requested transmission using a function which your fax machine does not have. If you were attempting to fax, make sure a document is in the feeder. If you were receiving, contact the faxing party to see how they are trying to send to you.



Transaction Report print condition

You can change the condition under which a Transaction Report is printed out. Follow the steps below.

1 Press  **FUNCTION** once and  **3 times.**

Display:

OPTION SETTING 

2 Press  once and  **3 times.**





TRANSACTION 

3 Press  once.

1:ALWAYS PRINT

(Selections appear alternately)

4 Press a number from  **1** to  **5** to select the condition for printing.

- | | |
|--|--|
|  1 ALWAYS PRINT | A report will be printed after each transmission, reception, or error. |
|  2 ERROR/MEMORY | A report will be printed after an error or a memory operation. |
|  3 SEND ONLY | A report will be printed after each transmission. |
|  4 ERROR ONLY | A report will be printed only when an error occurs. |
|  5 NEVER PRINT | A report will never be printed. |



The display briefly shows your selection, then:

DIAL MODE 

5 Press  **STOP** to return to the date and time display.

Auto print-out of Activity Report

You can set the Activity Report to print automatically whenever information on 30 fax transactions has accumulated. (A report can still be printed on demand at any time.) Follow these steps:

1 Press  **FUNCTION** once and  **3 times.**

Display:



OPTION SETTING 

2 Press  once and  **4 times.**

AUTO PRINT OUT 

3 Press  once.

1=YES, 2=NO

4 Press  **1** to turn on auto print out, or
 **2** to turn it off.

The display briefly shows your selection, then:

ECM MODE 

5 Press  **STOP** to return to the date and time display.

8. Maintenance

Cleaning the Machine

Cleaning the scanning glass and rollers

Clean the scanning glass and rollers frequently to ensure the quality of transmitted images and copies.

1 Open the operation panel.

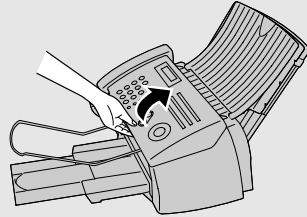

2 Flip up the green levers on each side of the white roller.

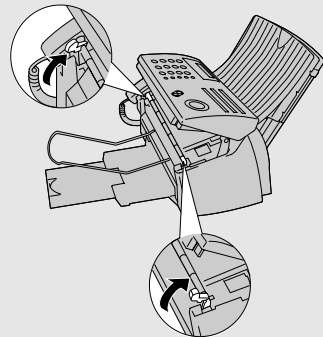

3 Wipe the scanning glass (under the white roller) and rollers with a cotton swab.

- Make sure that all dirt and stains (such as correcting fluid) are removed. Dirt and stains will cause vertical lines on transmitted images and copies.

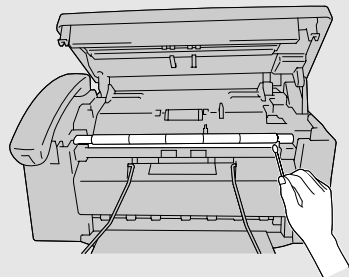

If the scanning glass is difficult to clean

If you find it difficult to remove dirt from the scanning glass, you can try moistening the swab with isopropyl alcohol or denatured alcohol. Take care that no alcohol gets on the rollers.

- 4** Flip down the green levers on each side of the white roller.

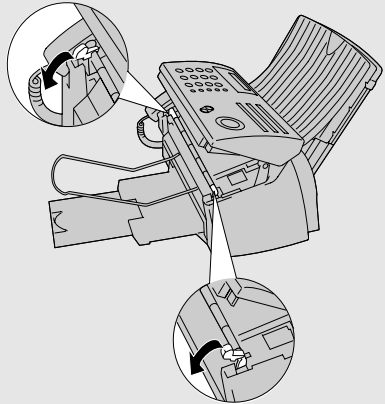

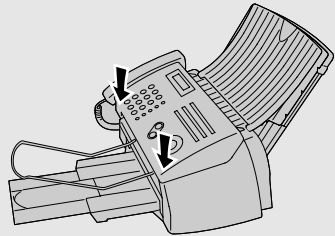

- 5** Close the operation panel, pressing down firmly on both front corners to make sure it clicks into place.



Rotating the white roller



After cleaning the scanning glass and rollers as explained in the preceding procedure, follow the steps below to make the machine rotate the white roller by half a turn, and then repeat the cleaning procedure. This will enable you to clean the side of the roller that was initially facing down.

- ◆ Do not perform this procedure when a document is loaded in the feeder. This may cause the top part of the document to be cut off when the document is faxed or copied.

1 Press  **FUNCTION** once and  **3 times.**

Display:

OPTION SETTING 

2 Press  once and  once.

CLEAN ROLLER 

3 Press  once.

4 Press .

- The white roller rotates half a turn. When rotation is finished, the machine will beep.

Cleaning the housing

Wipe the external parts and surface of the machine with a dry cloth.

Caution!

Do not use benzene or thinner. These solvents may damage or discolor the machine.

About the lithium battery:

The fax machine uses a lithium battery to retain settings and information programmed in the machine when the power is turned off. Battery power is consumed primarily when the power is off. With the power kept continuously off, the life of the battery is about 5 years. If the battery dies, have your dealer or retailer replace it. Do not try to replace it yourself.

Improving Print Quality

Aligning the print cartridge



If print quality is not satisfactory, first try aligning the print cartridge.

Note: Make sure that paper is loaded before beginning this procedure.

1 Press  **FUNCTION** once and  twice.

Display:

PRINT SET-UP 

2 Press  once and  twice.

ALIGN CART. 

3 Press  once.

1=PRINT,2=SET

4 Press  to print an alignment page.

(To enter an alignment value without printing an alignment page, press

.)

5 In the alignment page that the machine prints, locate the line that comes closest to forming a completely straight line.

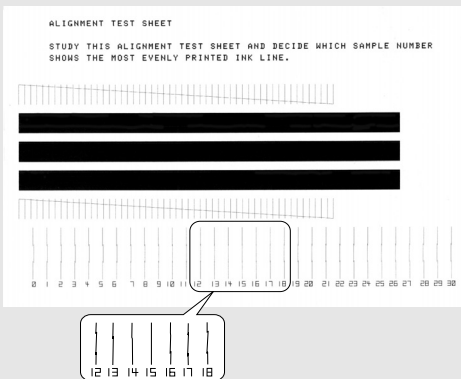

In this example, "15" comes closest to forming a straight line.

After printing the alignment page the display shows:

ENTER (0-30) 15

6 Press the number keys to enter the number of the straightest line.

Example:  

- If you make a mistake, press  and then repeat the entry.

7 Press .

CLEAN NOZZLES  

8 Press  to return to the date and time display.



Cleaning the print cartridge nozzles

If print quality is still not satisfactory after aligning the print cartridge, follow these steps to clean the print cartridge nozzles.

1 Press  **once** and  **twice**.

Display:

PRINT SET-UP  

2 Press  **once** and  **once**.

CLEAN NOZZLES  

3 Press  **once**.

PRESS START KEY

4 Press .

- The machine prints a test pattern similar to the one shown in the following step.

5 Compare the diagonal line above the printed bars to the diagonal line below the printed bars.

- Look for a break in the diagonal line above the bars. A break indicates clogged nozzles.

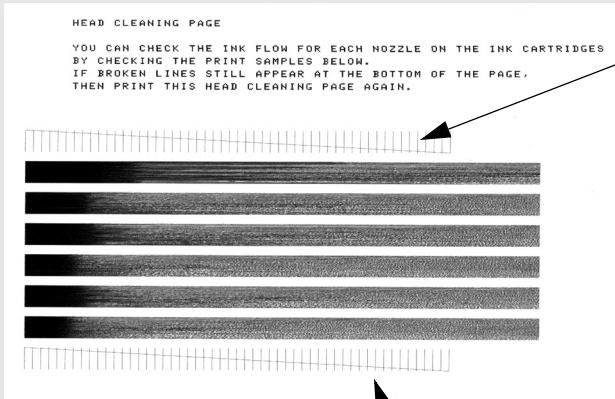

Breaks in the diagonal line at the top of the page indicate clogged nozzles.

Unbroken lines at the bottom of the page indicate the nozzles were cleaned.

6 If the bottom diagonal line still has breaks, repeat Steps 1 and 2 to run the nozzle test again. Run the test a third time if necessary.

- If the print quality is satisfactory after running the nozzle test three times, the nozzles are clean.
- If the print quality is still not satisfactory after running the test a third time, continue with Step 7.

7 Open the operation panel and then the print compartment cover, and remove and reinstall the print cartridge (see page 17).

8 Repeat the nozzle test. If the lines are still broken, wipe the nozzles as explained in the following section.

Wiping the print nozzles and contacts

If you have cleaned the print nozzles as explained in the previous section at least three times and print quality is still not satisfactory, try wiping the print nozzles and contacts.

1 Open the operation panel and then the print compartment cover, and remove the print cartridge (see page 17).

- **CAUTION! DO NOT** touch the gold contact area of the cartridge or the contact area of the cartridge carriage with your fingers.

2 Dampen a clean cloth with water, and gently wipe the nozzles and the gold-colored area around the nozzles. Wipe in one direction only.

- To dissolve dried ink, hold the damp cloth against the nozzles for about three seconds. Gently blot and wipe dry.
- When finished, allow the gold-colored area to dry.

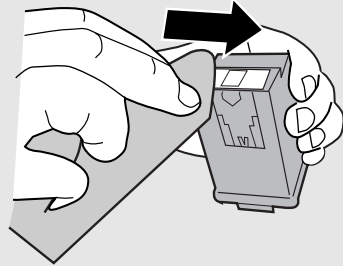

3 Dampen another section of clean cloth with water, and gently wipe the contacts and the gold-colored area around the contacts.

- To dissolve dried ink, hold the damp cloth against the contacts for about three seconds. Gently blot and wipe dry.
- When finished, allow the gold-colored area to dry.

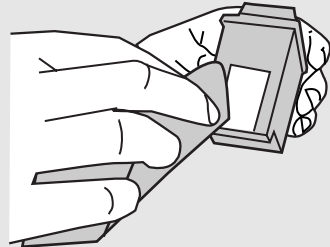

4 Reinstall the print cartridge and repeat the nozzle test as explained in the previous section.

Cleaning the cartridge holder

A dirty print cartridge holder may cause smudges on your printed pages. To clean the print cartridge holder, open the operation panel and then the print compartment cover, and remove the print cartridge (see page 17). Wipe **1** on the holder with a damp cloth.

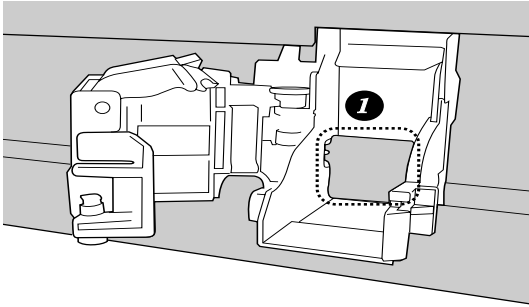

9. Troubleshooting

Problems and Solutions

If you have any problems with your fax, first refer to the following troubleshooting guide.

Line error

Problem	Solution
LINE ERROR appears in the display.	<p>A line error occurs when your fax machine cannot communicate correctly with the other fax machine. The error is usually due to a problem on the phone line.</p> <p>Try the transaction again. If the error persists, check the following:</p> <ul style="list-style-type: none">• Check the connection. The cord from the TEL. LINE jack to the wall jack should be no longer than six feet.• Make sure there are no modem devices sharing the same telephone line.• Check with the other party to make sure their fax machine is functioning properly.• Have your telephone line checked for line noise.• Try connecting the fax machine to a different telephone line.• If the problem still occurs, your fax machine may need service.

Dialing and transmission problems

Problem	Solution
No dial tone when you pick up the handset or press the SPEAKER key.	<ul style="list-style-type: none"> • Make sure the handset cord is connected to the correct jack. See <i>Connecting the handset</i> on page 11. • Make sure that the telephone line is properly connected to both the TEL. LINE jack and the wall jack (see page 11). • Make sure that the telephone line is good.
Dialing is not possible.	<ul style="list-style-type: none"> • Make sure the power cord is properly plugged into a power outlet. • Make sure that the telephone line is properly connected to both the TEL. LINE jack and the wall jack (see page 24). • Make sure that the fax machine is set to the correct dialing mode for your telephone line. See <i>Dial mode</i> on page 24.
The power is on, but no transmission takes place.	<ul style="list-style-type: none"> • Make sure that the receiving machine has paper. • Make sure that the telephone line cord is plugged into the TEL. LINE jack, and not the TEL. SET jack. • If the receiving machine is in manual mode with no attendant, reception will not be possible. • Check the display for error messages. • Pick up the handset and check for a dial tone. Dial the receiving machine manually and make sure that it is responding (you should hear a fax tone).
Nothing is printed at the receiving end.	<ul style="list-style-type: none"> • Make sure that the document for transmission is placed face down in the feeder.

<p>A distorted image is received at the other end.</p>	<ul style="list-style-type: none"> • Noise on the telephone line may cause distortion. Try sending the document again. • ECM mode (see page 50) will help prevent distortions due to line noise. Note that ECM mode must be turned on in the other machine as well. • Make a copy of the document on your fax machine. If the copy is also distorted, your fax machine may need service.
--	---

Reception and copying problems

Problem	Solution
<p>The fax machine doesn't receive documents automatically.</p>	<ul style="list-style-type: none"> • Make sure that the reception mode is set to FAX. If you subscribe to a distinctive ring service, make sure that the Distinctive Ring function is set to the correct ring pattern. If you do not subscribe to a distinctive ring service, make sure that Distinctive Ring is set to OFF SETTING. (See <i>Distinctive Ring</i> on page 77.)
<p>The printing paper comes out blank when you try to receive a document.</p>	<ul style="list-style-type: none"> • Make sure that the document is loaded properly in the feeder of the transmitting machine. Make a copy or print a report to confirm the printing ability of your machine.
<p>Print quality is poor.</p>	<ul style="list-style-type: none"> • The print cartridge may need alignment or cleaning. See page 93.
<p>The received document is faint.</p>	<ul style="list-style-type: none"> • Ask the other party to send higher contrast documents. If the contrast is still too low, your fax machine may need service. Make a copy or print a report to check your machine's printing ability. • The print cartridge may need replacement.

Received images are distorted.	<ul style="list-style-type: none"> Noise on the telephone line may cause distortion. Have the other party try sending the document again. ECM mode (see page 50) will help prevent distortions due to line noise. Note that ECM mode must be turned on in the other machine as well. Make a copy or print a report on your fax machine. If the copy or report is also distorted, your fax machine may need service.
The quality of copies is poor and/or dark vertical lines appear.	<ul style="list-style-type: none"> Any dirt or material on the scanning glass will cause spots to appear on copies and transmitted faxes. Clean the scanning glass as explained on page 90.
The power is on, but no reception takes place.	<ul style="list-style-type: none"> Make sure that the telephone line cord is plugged into the TEL. LINE jack, and not the TEL. SET jack.

General problems

Problem	Solution
Nothing appears in the display.	<ul style="list-style-type: none"> Make sure the power cord is properly plugged into a power outlet. Connect another electrical appliance to the outlet to see if it has power.
The machine does not respond when you press any of its keys.	<ul style="list-style-type: none"> If a beep sound is not made when you press the keys, unplug the power cord and then plug it in again several seconds later.
Automatic document feeding does not work for transmission or copying.	<ul style="list-style-type: none"> Check the size and weight of the document (see <i>Transmittable Documents</i> on page 33).

Answering machine connection

Problem	Solution
The answering machine connection does not operate properly.	<ul style="list-style-type: none">• Make sure your machine's reception mode is set to A.M..• Make sure your machine's TEL. LINE jack is connected to the wall jack. Make sure your machine's TEL. SET jack is connected to your answering machine's telephone line jack (not the answering machine's extension phone jack).• Make sure your answering machine's outgoing message is under 10 seconds.• Make sure that the Quiet Detect Time setting is set to three or four seconds (see page 68).• Make sure that the Distinctive Ring function is set to OFF SETTING (see page 77).

Messages and Signals

Display messages

Note: If you have turned on the Caller ID function, see page 73 for display messages related to Caller ID.

ADD PAPER & / PRESS START KEY (alternating messages)	Check the printing paper. If the tray is empty, add paper and then press the START/MEMORY key. If there is paper in the tray, make sure it is inserted correctly (take out the stack, align the edges evenly, and then reinsert it in the tray) and then press the START/MEMORY key.
CHANGE CARTRIDGE	This message appears after you install or replace the print cartridge (see page 19).
CHECK CARTRIDGE	The print cartridge is missing and must be installed, or is not installed correctly.
COVER OPEN	The print compartment cover is open. Close it.
DOCUMENT JAMMED	The original document is jammed. See the following section, <i>Clearing Paper Jams</i> . Document jams will occur if you load more than 20 pages at once or load documents that are too thick (see page 33). The document may also jam if the receiving machine doesn't respond properly when you attempt to send a fax.
FAX RX IN MEMORY	A fax has been received in memory because the print cartridge needs replacement, you have run out of printing paper, or the paper is jammed. The fax will print out automatically when the problem is fixed.
FUNCTION MODE	The FUNCTION key has been pressed.
INK NEAR EMPTY	The cartridge is nearly empty (approximately one eighth of the ink remains).
LINE ERROR	Transmission or reception was not successful. Press the STOP key to clear the message and then try again. If the error persists, see <i>Line error</i> on page 98.

Messages and Signals

LOW INK	The cartridge is low on ink (approximately one quarter of the ink remains).
MEMORY IS FULL	If faxes have been received to memory because printing is not possible (an additional message will indicate the problem), resolve the problem so that printing can continue (see <i>Substitute Reception to Memory</i> on page 63). If you are attempting to transmit from memory, see <i>If the memory becomes full</i> on page 56. If you are copying, see <i>If MEMORY IS FULL appears</i> on page 65.
MEMORY PRINTING	The fax is preparing to or printing out a document from memory.
NO # STORED	This appears if you attempt to search for an auto-dial number when none have been stored.
OFF HOOK	This appears if you forgot to replace the handset after using it to dial and send a fax. Replace the handset or press the STOP key to clear the message.
ON HOOK DIAL	The SPEAKER key has been pressed and the fax machine is waiting for you to dial.
OUT OF INK	The cartridge is out of ink and must be replaced. Faxes will be received to memory.
PAPER JAMMED	The printing paper is jammed. See page 107.
PRINTER ERROR	A printer error has occurred. Open the printer compartment cover, make sure the print cartridge is installed correctly, and then close the cover.
PRINTER ERROR/ CHECK PAPER	A paper jam may have occurred. Follow the procedure on page 107 to clear the jam.
READY TO SEND	A document has been loaded and the fax machine is waiting for you to begin faxing or copying.

RECALLING	This appears if you attempt to send a fax by automatic dialing and the line is busy or the receiving fax machine does not answer. Your fax machine will automatically reattempt the call. (See <i>Automatic redialing</i> on page 49.)
TOTAL PAGE(S) 01	Number of pages transmitted, received, or copied.

Audible signals

Continuous tone	3 seconds	Indicates the end of transmission, reception, or copying.
Intermittent tone (3 beeps)	5 seconds (1 second on, 1 second off)	Indicates incomplete transmission, reception, or copying.
Rapid intermittent tone	35 seconds (0.7 seconds on, 0.3 seconds off)	Indicates that the handset is off hook.

Clearing Paper Jams

Clearing a jammed document

If the original document doesn't feed properly during transmission or copying, or DOCUMENT JAMMED appears in the display, first try pressing . If the document doesn't feed out, remove it as explained below.

Important:

Do not try to remove a jammed document without releasing it as explained below. This may damage the feeder mechanism.

- 1 Slowly open the operation panel until it is half open.**

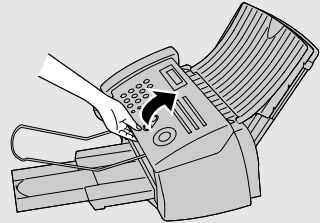

- 2 Flip up the green levers on each side of the white roller.**

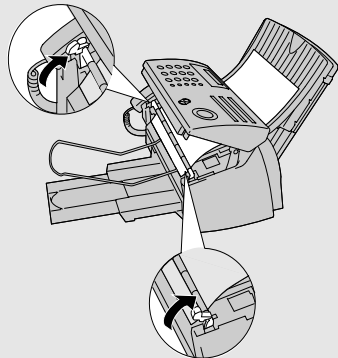

- 3 Gently remove the document.**

- Be careful not to tear the document.

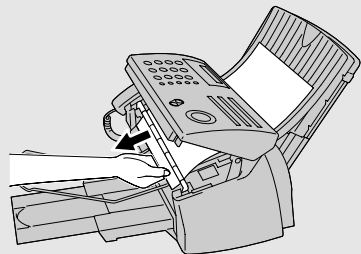

- 4** Flip down the green levers on each side of the white roller.

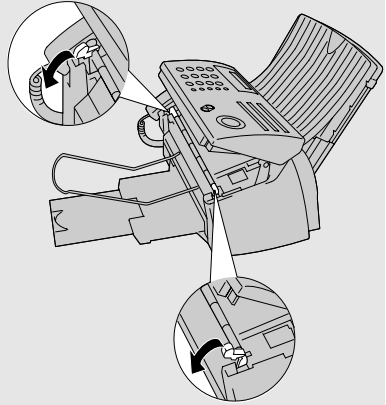

- 5** Close the operation panel, pressing down on both sides to make sure it clicks into place.

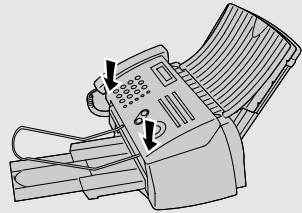

Clearing jammed printing paper

- 1** Open the operation panel.

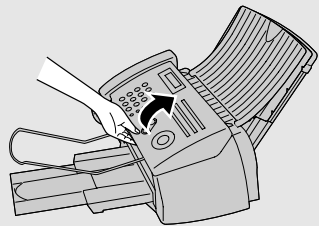

2 Open the print compartment cover.

- Press as shown and pull the cover toward you.

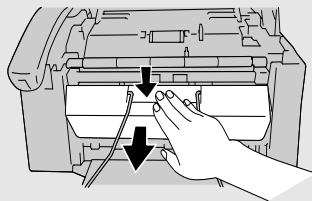

3 Gently pull the jammed paper out of the machine, making sure no torn pieces of paper remain in the print compartment or rollers.

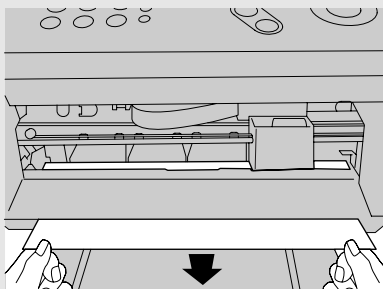

4 Close the print compartment cover.

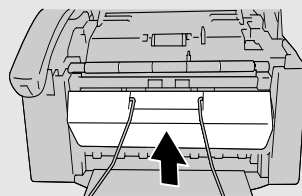

5 Close the operation panel, pressing down firmly on both front corners to make sure it clicks into place.

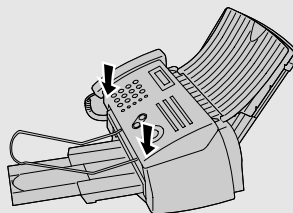

FCC Regulatory Information

This equipment complies with Part 68 of the FCC rules and the requirements adopted by the ACTA. On the rear of this equipment is a label that contains, among other information, a product identifier in the format US:AAAEQ##TXXXX. If requested, this number must be provided to the telephone company.

A plug and jack used to connect this equipment to the premises wiring and telephone network must comply with the applicable FCC Part 68 rules and requirements adopted by the ACTA. A compliant telephone cord and modular plug is provided with this product. It is designed to be connected to a compatible modular jack that is also compliant. See installation instructions for details. This equipment connects to the telephone network through a standard USOC RJ-11C network interface jack.

The REN is used to determine the number of devices that may be connected to a telephone line. Excessive RENs on a telephone line may result in the devices not ringing in response to an incoming call. In most but not all areas, the sum of RENs should not exceed five (5.0). To be certain of the number of devices that may be connected to a line, as determined by the total RENs, contact the local telephone company. For products approved after July 23, 2001, the REN for this product is part of the product identifier that has the format US:AAAEQ##TXXXX. The digits represented by ## are the REN without a decimal point (e.g., 03 is a REN of 0.3). For earlier products, the REN is separately shown on the label.

If this equipment causes harm to the telephone network, the telephone company will notify you in advance that temporary discontinuance of service may be required. But if advance notice isn't practical, the telephone company will notify the customer as soon as possible. Also, you will be advised of your right to file a complaint with the FCC if you believe it is necessary.

The telephone company may make changes in its facilities, equipment, operations or procedures that could affect the operation of the equipment. If this happens the telephone company will provide advance notice in order for you to make necessary modifications to maintain uninterrupted service.

If trouble is experienced with this equipment, or for repair or warranty information, please contact your authorized Sharp dealer. If the equipment is causing harm to the telephone network, the telephone company may request that you disconnect the equipment until the problem is resolved.

This equipment may not be used on coin service provided by the telephone company. Connection to party line service is subject to state tariffs. Contact the state public utility commission, public service commission or corporation commission for information.

If your home has specially wired alarm equipment connected to the telephone line, ensure the installation of this equipment does not disable your alarm equipment. If you have questions about what will disable alarm equipment, consult your telephone company or a qualified installer.

This equipment is hearing-aid compatible.

When programming and/or making test calls to emergency numbers:

- ◆ Remain on the line and briefly explain to the dispatcher the reason for the call.
- ◆ Perform such activities in the off-peak hours, such as early morning or late evening.

S H A R P

Revised date: _____

Issued date :Sep.19.2002

MATERIAL SAFETY DATA SHEET (1/3)

MSDS No. B-1028

Section 1. Product Identification

Product Code : Ink-Cartridge (Mono) FO-C60B

Section 2. Supplier's Name and Address

Sharp Corporation

22-22 Nagaike-cho, Abeno-ku, Osaka, Japan

Local suppliers are listed below. Please contact the nearest supplier for additional information.

(Country)	(Name and Telephone Number)
U.S.A.	Sharp Electronics Corporation Telephone number for information: 1-800-237-4277 Emergency telephone number : 1-800-255-3924
Canada	Sharp Electronics of Canada Ltd. Telephone number for information : 905-890-2100 Emergency telephone number : 1-800-424-9300

Section 3. Composition / Information for Ingredients

Ingredients	Cas No.	Proportion (% by Weight)	OSHA PEL	ACGIH TLV
Carbon Black	1333-86-4	1-6	3.5 mg/m ³ (1)	3.5 mg/m ³ (1)
Acrylic Terpolymer	(2)	0.1-2	(3)	(3)
Water Soluble Organic Solvents	(2)	10-20	(3)	(3)
Hydroxylated Alkane	(2)(4)	1-10	(3)	(3)
Acrylic Resin	(2)	0.1-5	(3)	(3)
Water	7732-18-5	>55	(3)	(3)

- Notes:**
- (1) Total dust (measured carbon black)
 - (2) Trade secret of patented molecule.
 - (3) Specific workplace exposure limits have not been established.
 - (4) New Jersey Trade Secret Registration Number (NJTSRN) 80100451-5004

Section 4. Hazardous Identification

The following information is based on testing of the ink and on the characteristics of component chemicals:

Primary Routes of Entry: Ink stains on skin or mucus membranes (mouth, eyes & nose) may cause discomfort.

Medical Conditions

Aggravated by Exposure: None known at intended levels of use.

POTENTIAL HEALTH EFFECTS:

- Inhalation:** Short Term Exposure -- If ink mist is inhaled, respiratory tract irritation may occur.
Long Term Exposure -- No adverse chronic effects expected.
- Skin Contact:** Short Term Exposure -- Ink may be slightly irritating to the skin.
Long Term Exposure -- No adverse chronic effects expected. Not a dermal sensitizer.
- Eye Contact:** Short Term Exposure -- Not an eye irritant.
Long Term Exposure -- No adverse chronic effects expected.
- Ingestion:** Short Term Exposure -- Low oral toxicity.
Long Term Exposure -- No adverse chronic effects known or expected, but based on component characteristics, gastrointestinal effects, liver and kidney toxicity, and CNS effects are possible if large quantities of ink are repeatedly ingested.

S H A R P

Revised date: _____

Issued date :Sep.19.2002

MATERIAL SAFETY DATA SHEET (2/3)

MSDS No. B-1028

Section 5. First Aid Measures

Inhalation:	Remove to fresh air. Seek medical attention if breathing becomes difficult.
Ingestion:	Immediately rinse mouth out with plenty of water. If within 30 minutes after ingestion, give victim a small glass of water or milk (NEVER give anything by mouth to an unconscious person). Contact physician or poison center. Do not induce vomiting unless instructed to do so by a physician or poison center.
Skin Contact:	Remove contaminated clothing. Flush affected area with water. Seek medical attention if irritation develops and persists.
Eye Contact:	Flush immediately with plenty of water. Remove contact lenses and continue flushing for at least 15 minutes. Seek medical attention if irritation develops and persists.

Section 6. Fire Fighting Measures

Flash Point:	Not applicable
Flammability Limits(%):	Not applicable
Extinguishing Media:	Water, foam, carbon, dioxide or dry chemical.
Fire fighting:	Fire may produce small amounts of hazardous decomposition products such as carbon dioxide, carbon monoxide, and unidentified organics. NIOSH approved self-contained breathing apparatus may be required if a large volume of ink is involved.

Fire and Explosion Hazard: No unusual fire or explosion hazards are known for this product.

Hazardous Combustion Products: Oxides of carbon, organic acids, low molecular weight organics.

Section 7. Accidental Release Measures

Occupational Spill:	Absorb small ink spills with cloth or paper towels or other suitable material. Place in a container for disposal. For large spills, dike around spill with absorbent material. Transfer contaminated diking material to separate, suitable containers for recovery or disposal. Ventilate area and wash spill site after material pickup is complete. Unless specifically permitted, keep waste out of sewers, watershed and waterways.
----------------------------	---

Section 8. Handling and Storage

STORE IN COOL, DRY PLACE

Section 9. Exposure Control/Personal Protection

Ventilation:	Mechanical room ventilation
Eye Protection:	None needed for intended use in printer.
Protective Clothing:	None needed for intended use in printer.
Gloves:	None needed for intended use in printer.

Section 10. Physical Chemical Characteristics

Description:	Black liquid with faint odor.	Freezing Point:	Approx. -12 to -150 °C
Pressurized:	No	pH:	7.0-8.5
Water Solubility:	Fully Miscible	Percent Volatile:	Approx. 18.7
Evaporation Rate (Butylacetate=1):	Approx. 3.5	Specific Gravity:	Approx. 1.0 mg/l
		Vapor Density (Air=1):	Approx. 1.6

Section 11. Stability and Reactivity

Stability:	None known.
Incompatibilities:	None known.
Thermal decomposition products:	Oxides of carbon, acid gases, low molecular weight organics.
Hazardous polymerization:	This product will not polymerize.

S H A R P

Revised date: _____

Issued date :Sep.19.2002

MATERIAL SAFETY DATA SHEET (3/3)

MSDS No. B-1028

Section 12. Toxicological Information

Acute Toxicity:	Not expected to be acutely toxic; LD50 (oral, rat) expected to be >2000 mg/kg.
Chronic Toxicity:	Not expected to be chronically toxic based on component information, volume, concentration, and intended use. Pure carbon black, a minor component of this ink, has been listed by LARC as group 2B (possible carcinogen). This classification is based on rat "lung particulate overload" studies performed with airborne particulate carbon black. Ink is not listed by LARC , NTP , or OSHA .
Carcinogenicity:	OSHA Regulated(USA): Not listed In 1996 the LARC reevaluated carbon black as a Group 2B carcinogen (possible human carcinogen). This evaluation is given to Carbon Black for which there is inadequate human evidence, but sufficient animal evidence. The latter is based upon the development of lung tumors in rats receiving chronic inhalation exposures to free carbon black at levels that induce particle overload of the lung. Studies performed in animal models other than rats have not demonstrated an association between carbon black and lung tumors.

Section 13. Ecological Information

No data available.

Section 14. Disposal Consideration

This product is not a listed or hazardous waste in accordance with Federal Regulation 40 CFR Part 261. If discarded, this product would not be a hazardous waste either by listing or by characteristic. However, it is the responsibility of the product user to determine at the time of disposal whether a material has been contaminated and should be classified as a hazardous waste.
In accordance with RCRA 40 CFR Section 264.314 and 265.314, the placement of any liquid in landfills is prohibited.
Disposal is subject to local, state and federal regulations.

Section 15. Transport Information

DOT PROPER SHIPPING NAME: Not regulated as hazardous material.

Section 16. Regulatory Information

All ingredients are registered under the **Toxic Substances Control Act (TSCA)** or under polymer exemption. All ingredients are exempt, registered or considered registered (polymers) under the **European Inventory of Existing Commercial Chemical Substances(EINECS/ELINCS)**.
Preparation not classified as dangerous (**EU Directive 67/548/EEC;1999/45/EC**).
All ingredients are listed on or are considered polymers under the **Canadian Domestic Substances List (DSL) or Non Domestic Substances List (NDSL)**.
Note of the product ingredients are listed as **Emergency Planning and Community Right-to-Know Act (EPCRA)-Section 302: Extremely Hazardous Substances (EHS)**.
None of the product components are present above the minimum quantities of listed chemicals in **EPCRA Section 313 Supplier Notification**.
This product contains no known materials at levels which the State California has found to cause cancer, birth defects or other reproductive harm - **California Proposition 65**.

Section 17. Other Information

Restrictions: This information relates only to the specific material designated as supplied by the manufacturer. This information is supplied to us by the manufacturer and Sharp offers no warranties as to its accuracy and accepts no responsibilities for any typographical errors which may appear on these sheets. It is the responsibility of the user to determine the suitability of this product for each particular use.

Literature Reference:

LARC(1996): LARC monographs on the Evaluation of the Carcinogenic Risk of Chemicals to Humans, Vol.65, Printing Process and Printing Inks, Carbon Black and Some Nitro Compounds, Lyon, pp.149-261 H.Muhle, B.Bellmann, O.Creutzenberg, C.Dasenbrock, H.Ernst, R.Kilpper, J.C.MacKenzie, P.Morrow, U.Mohr, S.Takenaka, and R.Mermelstein(1991) Pulmonary Response to Toner upon Chronic Inhalation Exposure in Rats.
Fundamental and Applied Toxicology 17, pp.280-299

Quick Reference Guide

Sending Faxes

Place your document (up to 20 pages) face down in the document feeder.



Normal Dialing

1. Lift the handset or press .
2. Dial the fax number.
3. Wait for the reception tone (if a person answers, ask them to press their Start key).

4. Press .

Rapid Key Dialing

Press the appropriate Rapid Key. Transmission will begin automatically.

Speed Dialing

1. Press .
2. Enter the 2-digit Speed Dial number.
3. Press .

Search Dialing

1. Press or until the desired destination appears in the display.
2. Press .

Direct Keypad Dialing

1. Dial the fax number.
2. Press .

Receiving Faxes

Press until the arrow in the display points to the desired reception mode.



FAX mode: The fax machine automatically answers and receives faxes.

TEL mode: Answer all calls (even faxes) by picking up the handset. To begin fax

reception, press .

A.M. mode: Select this mode when you want to use an answering machine that is connected to the fax.

Storing Auto Dial Numbers

1. Press once and once.
2. Enter a 2-digit Speed Dial number (01 to 99; 01 to 18 for Rapid Key Dialing).
3. Enter the fax number and press .
4. Enter a name by pressing number keys. (To enter two letters in succession that require the same key, press after entering the first letter.)

SPACE = 1	G = 4	N = 6 6	U = 8 9
A = 2	H = 4 4	O = 6 6 6	V = 8 8 8
B = 2 2	I = 4 3 4	P = 7	W = 9
C = 2 2 2	J = 5	Q = 7 7	X = 9 9
D = 3	K = 5 5	R = 7 7 7	Y = 9 9 9
E = 3 3	L = 5 5 5	S = 7 7 7 7	Z = 9 9 9 9
F = 3 3 3	M = 6	T = 8	

5. Press and then .

Guía de referencia rápida

Transmisión de documentos

Coloque el documento (hasta 20 páginas) mirando hacia abajo en el alimentador.



Marcación normal

1. Levante el auricular o pulse .
2. Marque el número de telefax.
3. Espere a escuchar el tono de recepción (si alguien contesta el teléfono, pídale que pulse su tecla Inicio).

4. Pulse .

Marcación por tecla rápida

Pulse la Tecla rápida apropiada. La transmisión comenzará automáticamente.

Marcación abreviada

1. Pulse .
2. Introduzca el número de 2 dígitos de marcación abreviada.
3. Pulse .

Marcación por búsqueda

1. Pulse o hasta que aparezca el número deseado en el display.

2. Pulse .

Marcación directa por teclado

1. Marque el número de telefax.

2. Pulse .

Recepción de documentos

Pulse hasta que la flecha del display señale el modo de recepción deseado.



Modo FAX: El aparato de telefax contestará y recibirá documentos automáticamente.

Modo TEL: Contesta todas las llamadas (incluso las de telefax) levantando el auricular. Para que comience la recepción del documento, pulse .

Modo A.M.: Seleccione este modo si desea utilizar un contestador automático conectado al aparato de telefax.

Programación de números de marcación automática

1. Pulse una vez y una vez.
2. Introduzca un número de 2 dígitos de Marcación abreviada (01 a 99; 01 a 18 para una Marcación por tecla rápida).

3. Introduzca el número de telefax y pulse .

4. Introduzca un nombre pulsando las teclas numéricas. (Para introducir dos letras sucesivas que requieran la

misma tecla, pulse después de introducir la primera letra).

SPACE = 1	G = 4	N = 6 6	U = 8 8
A = 2	H = 4 4	O = 6 6 6	V = 8 8 8
B = 2 2	I = 4 4 4	P = 7	W = 9
C = 2 2 2	J = 5	Q = 7 7	X = 9 9
D = 3	K = 5 5	R = 7 7 7	Y = 9 9 9
E = 3 3	L = 5 5 5	S = 7 7 7 7	Z = 9 9 9 9
F = 3 3 3	M = 6	T = 8	

5. Pulse y, a continuación, .

Index

A

- Activity Report, 85
- Activity Report, Auto Print Out, 89
- AM reception mode, 30, 67
- Answering machine connection
 - Activating, 67
 - Connecting, 66
 - On TAD Failure, 71
 - Quiet Detect Start Time, 70
 - Quiet Detect Time, 68
 - Troubleshooting, 102
- Anti Junk Fax, 79
- Audible signals, 105
- Auto-dial numbers
 - Searching for, 47
 - Storing, 41

B

- Batch page numbering, 51
- Broadcasting, 52-53

C

- Caller ID, 72-76
- Caller ID List, 86
- Contrast, 36
- Copies, 64
- Copy cut-off setting, 65

D

- Date, setting, 28-29
- Daylight Saving Time, 29
- Dial mode, 24
- Dialing
 - Direct Keypad, 48
 - Normal, 39
 - Rapid Key, 45
 - Searching, 47
 - Speed, 46
- Direct Keypad Dialing, 48
- Display messages, 73, 103

- Distinctive ring, 77
- Document feeder, 34
- Document guides, 34
- Document restrictions, 34
- Document sizes, 33
- Document, maximum scanning size, 33

E

- ECM (Error Correction Mode), 50
- Extension telephone
 - Connecting, 25
 - Using, 59

F

- FAX reception mode, 30, 57
- Fax Signal Receive, 60
- Fine resolution priority, 38

G

- Group Keys, 54
- Group List, 86

H

- Halftone setting, 36
- Handset, 11
- Handset receiver volume, 32
- Housing, cleaning, 92

I

- Ink save mode, 23

J

- Jams, clearing, 106-108

L

- Letters, entering, 27, 42
- Line error, 98
- Loading paper, 14
- Loading the document, 34

Index

M

Memory transmission, 56
Memory, substitute reception to, 63

N

Normal dialing, 39
Number of rings in FAX reception mode,
57

P

Page numbering, batch, 51
Paper jams, clearing, 106-108
Paper size setting, 22
Paper trays, 12
Paper, loading, 14
Polling, 80-83
Power cord, 16
Print cartridge
 Aligning, 93-94
 Cleaning nozzles, 94
 Installing, 17-21
 Wiping nozzles, 96
Print cartridge holder, wiping, 97
Priority Call, 75

R

Rapid Key Dialing, 45
Reception mode
 AM mode, 30, 67
 FAX mode, 30, 57
 TEL mode, 30, 58
Reception Ratio setting, 62
Redialing, 49
Removing original document, 35
Resolution, 36
Ringer volume, 32
Roller, rotating for cleaning, 92

S

Scanning glass, cleaning, 90
Sender's name and number, entering,
26-27
Setup List, 86
Speaker volume, 31
Speed Dialing, 46

T

TEL reception mode, 30, 58
TEL. LINE jack, 24
TEL. SET jack, 25, 66
Tel/Fax Remote Number, 61
Telephone line cord, 24
Telephone Number List, 86
Time, setting, 28-29
Transaction Report, 87
 Setting print condition, 88

NOTICE

BE SURE TO ASK YOUR AUTHORIZED SHARP DEALER ABOUT THE WARRANTY THAT YOUR SELLING DEALER EXTENDS TO YOU. In order to assure you, the end-user, of warranty protection, Sharp extends a limited warranty to each of its authorized dealers and, in turn, requires each of its authorized dealers to extend its own warranty to you on terms that are no less favorable than those given to the dealer by Sharp. You should be aware, however, that Sharp does not itself extend any warranties, either express or implied, directly to you, the end-user, and no one is authorized to make any representations or warranties on behalf of Sharp. Specifically, SHARP DOES NOT EXTEND TO YOU, THE END-USER, ANY EXPRESS WARRANTY OR ANY IMPLIED WARRANTY OF MERCHANTABILITY, FITNESS FOR USE OR FITNESS FOR ANY PARTICULAR PURPOSE IN CONNECTION WITH THE HARDWARE, SOFTWARE OR FIRMWARE EMBODIED IN, OR USED IN CONJUNCTION WITH THIS PRODUCT. Sharp is not responsible for any damages or loss, either direct, incidental or consequential, which you, the end-user, may experience as a result of your purchase or use of the hardware, software or firmware embodied in or used in conjunction with this Product. Your sole remedy, in the event that you encounter any difficulties with the Product, is against the authorized dealer from which you purchased the Product. In the event that this authorized dealer does not honor its warranty commitments, please contact the Vice President, Sharp Electronics Corporation, Sharp Plaza, Mahwah, NJ 07430-1163, so that Sharp can try to help assure complete satisfaction of all the warranty rights to which you are entitled from the authorized dealer.

SHARP®

SHARP ELECTRONICS CORPORATION

Sharp Plaza, Mahwah, New Jersey 07430-1163

1-800-BE-SHARP

SHARP CORPORATION

FOR YOUR RECORDS

Please record the model number and serial number below, for easy reference, in case of loss or theft. These numbers are located on the rear side of the unit. Space is also provided for other relevant information.

Model Number FO-B1600

Serial Number _____

Date of Purchase _____

Place of Purchase _____

PRINTED IN THAILAND
(TINSE4304XHTA)

Free Manuals Download Website

<http://myh66.com>

<http://usermanuals.us>

<http://www.somanuals.com>

<http://www.4manuals.cc>

<http://www.manual-lib.com>

<http://www.404manual.com>

<http://www.luxmanual.com>

<http://aubethermostatmanual.com>

Golf course search by state

<http://golfingnear.com>

Email search by domain

<http://emailbydomain.com>

Auto manuals search

<http://auto.somanuals.com>

TV manuals search

<http://tv.somanuals.com>