

SHARP®

MODEL

UX-21/UX-41/UX-61 FO-11/FO-51/FO-71/GQ-56



FACSIMILE OPERATION MANUAL

1. Installation
2. Sending Faxes
3. Receiving Faxes
4. Making Copies
5. Making Telephone Calls
6. Answering Machine Connection
7. Special Functions
8. Printing Lists
9. Maintenance
10. Troubleshooting

Introduction

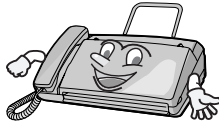

Welcome, and thank you for choosing a Sharp facsimile! The features and specifications of your new Sharp fax are shown below.

Automatic dialling	Rapid Key Dialling: 5 numbers Speed Dialling: 35 numbers
Fax paper	Initial starter roll (included with machine): 10 m Replacement roll (not included): FO-20PR 30 m (12.7 mm core)
Paper cutting method	UX-21/UX-41/FO-11/FO-51: Tear off by hand UX-61/FO-71/GQ-56: Automatic cutter
Memory size* (UX-41/61 FO-51/71 GQ-56 Only)	448 KB (approx. 17 average pages)
Modem speed	9,600 bps with automatic fallback to lower speeds.
Transmission time*	Approx. 15 seconds
Resolution	Horizontal: 8 pels/mm Vertical: Standard: 3.85 lines/mm Fine /Halftone: 7.7 lines/mm Super fine: 15.4 lines/mm
Automatic document feeder	5 pages max. (A4, 80 g/m ² paper)
Recording system	Thermal recording
Halftone (grayscale)	64 levels
Compression scheme	MR, MH, H2

*Based on Sharp Standard No.1 Chart at standard resolution is Sharp special mode, excluding time for protocol signals (i.e., ITU-T phase C time only).

Display	16-digit LCD display
Applicable telephone line	Public switched telephone network
Compatibility	ITU-T (CCITT) G3 mode
Input document size	Automatic feeding: Width: 148 to 210 mm Length: 140 to 297 mm Manual feeding: Width: 148 to 210 mm Length: 140 to 600 mm
Effective scanning width	210 mm max.
Effective printing width	210 mm max.
Contrast control	Automatic/Dark selectable
Reception modes	TEL/FAX, TEL, FAX, A.M. (Note: A.M. mode is for connecting an answering machine)
Copy function	Yes
Telephone function	Yes (cannot be used if power fails)
Power requirements	220 - 240 V AC, 50/60 Hz
Operating temperature	5 - 35°C
Humidity	30 - 85% RH
Power consumption	Standby: 4.0 W Maximum: 115 W
Dimensions	Width: 304 mm Depth: 236mm Height: 122 mm
Weight	Approx. 2.6 kg

As a part of our policy of continuous improvement, SHARP reserves the right to make design and specification changes for product improvement without prior notice. The performance specification figures indicated are nominal values of production units. There may be some deviations from these values in individual units.

Important safety information

Do not disassemble this machine or attempt any procedures not described in this manual. Refer all servicing to qualified service personnel.

Do not install or use the machine near water, or when you are wet. For example, do not use the machine near a bath tub, wash bowl, kitchen sink or laundry tub, in a wet basement, or near a swimming pool. Take care not to spill any liquids on the machine.

Unplug the machine from the telephone socket and then the power outlet and consult a qualified service representative if any of the following situations occur:

- Liquid has been spilled into the machine or the machine has been exposed to rain or water.
- The machine produces odors, smoke, or unusual noises.
- The power cord is frayed or damaged.
- The machine has been dropped or the housing damaged.

Do not allow anything to rest on the power cord, and do not install the machine where people may walk on the power cord.

This machine must only be connected to a 220 - 240 V, 50/60 Hz, earthed (3-prong) outlet. Connecting it to any other kind of outlet will damage the machine and invalidate the warranty.

Never insert objects of any kind into slots or openings on the machine. This could create a risk of fire or electric shock. If an object falls into the machine that you cannot remove, unplug the machine and consult a qualified service representative.

Do not place this machine on an unstable cart, stand or table. The machine could be seriously damaged if it falls.

Never install telephone wiring during a lightning storm.

Never install telephone sockets in wet locations unless the socket is specifically designed for wet locations.

Never touch uninsulated telephone wires or terminals unless the telephone line has been disconnected at the network interface.

Use caution when installing or modifying telephone lines.

Avoid using a telephone (other than a cordless type) during an electrical storm. There may be a remote risk of electric shock from lightning.

Do not use a telephone to report a gas leak in the vicinity of the leak.

The power outlet must be installed near the equipment and must be easily accessible.

Table of Contents

A Look at the Operation Panel	6
<hr/>	
1. Installation	8
<hr/>	
Unpacking Checklist	8
Connections	9
Loading the Thermal Paper	13
Entering Your Name and Fax Number	16
Setting the Date and Time	18
Setting the Reception Mode	20
Volume Adjustment	21
2. Sending Faxes	23
<hr/>	
Transmittable Documents	23
Loading the Document	24
Adjusting the Resolution and Contrast	26
Sending a Fax by Normal Dialling	28
Sending a Fax by Automatic Dialling	29
3. Receiving Faxes	38
<hr/>	
Using TEL/FAX Mode	38
Using A.M. Mode	39
Using FAX Mode	39
Using TEL Mode	41
Optional Reception Settings	43
Substitute Reception to Memory	44
4. Making Copies	45
<hr/>	
5. Making Telephone Calls	46
<hr/>	

6. Answering Machine Connection	48
Connecting an Answering Machine	48
Using the Answering Machine Connection	49
Optional A.M. Mode Settings	51
7. Special Functions	54
Caller ID (Requires Subscription to Service)	54
Blocking Reception of Unwanted Faxes	59
Polling (Requesting a Fax Transmission)	60
8. Printing Lists	62
9. Maintenance	65
10. Troubleshooting	67
Problems and Solutions	67
Messages and Signals	72
Clearing Paper Jams	74
Quick Reference Guide	77
Index	78

A Look at the Operation Panel

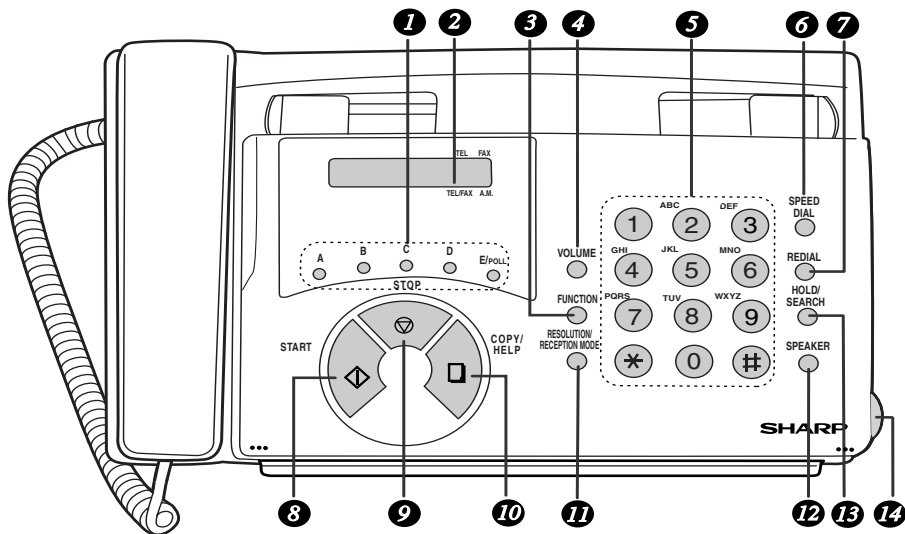

- 1 Rapid Dial keys**
Press one of these keys to dial a fax number automatically.
- 2 Display**
Displays messages to help you operate the machine.
- 3 FUNCTION key**
Press this key to select various special functions.
- 4 VOLUME key**
Press this key to adjust the volume of the speaker when  has been pressed, or the volume of the ringer at all other times.
- 5 Number keys**
Use these keys to dial numbers, and enter numbers and letters when storing auto-dial numbers.
- 6 SPEED DIAL key**
Press this key to dial a fax or voice number using an abbreviated 2-digit Speed Dial number.
- 7 REDIAL key**
Press this key to automatically redial the last number dialed.

- 8 START key**
Press this key to begin transmission when using Speed Dialling, Direct Keypad Dialling, or Normal Dialling.
- 9 STOP key**
Press this key to cancel an operation before it is completed.
- 10 COPY/HELP key**
When a document is in the feeder, press this key to make a copy. At any other time, press this key to print out the Help List, a quick reference guide to the operation of your fax machine.
- 11 RESOLUTION / RECEPTION MODE key**
When a document is in the feeder, press this key to adjust the resolution for faxing or copying. At any other time, press this key to select the reception mode (an arrow in the display will point to the currently selected reception mode).
- 12 SPEAKER key**
Press this key to listen to the line and fax tones through the speaker when faxing a document.
Note: **This is not a speakerphone.** You must pick up the handset to talk with the other party.
- 13 HOLD/SEARCH key**
Press this key to search for an auto-dial number, or, during a phone conversation, press this key to put the other party on hold.
- 14 Panel release**
Grasp this finger hold and pull toward you to open the operation panel.

1. Installation

Unpacking Checklist

Before setting up, make sure you have all of the following items.



If any are missing, contact your dealer or retailer.

Handset



Original document support



Handset cord



Operation manual

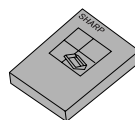

Fax paper (Sample roll)

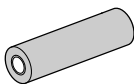

Paper shaft



Paper roll shims



Telephone line cord

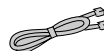

Points to keep in mind when setting up



Do not place the machine in direct sunlight.



Do not place the machine near heaters or air conditioners.



Keep dust away from the machine.



Keep the area around the machine clear.

About condensation

If the machine is moved from a cold to a warm place, it is possible that condensation may form on the scanning glass, preventing proper scanning of documents for transmission. To remove the condensation, turn on the power and wait approximately two hours before using the machine.

Connections

Connecting the handset

Connect the handset as shown and place it on the handset rest.

- ◆ The ends of the handset cord are identical, so they will go into either socket.

Make sure the handset cord goes into the socket marked with a handset symbol on the side of the machine!

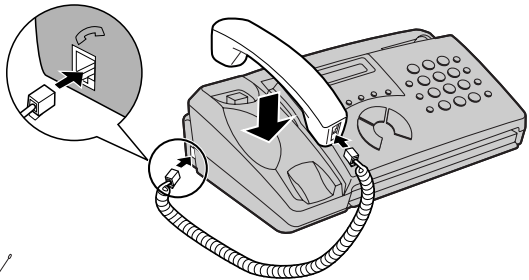

Use the handset to make ordinary phone calls, or to transmit and receive faxes manually.

Removing the packing paper

- 1 Grasp the finger hold and open the operation panel.

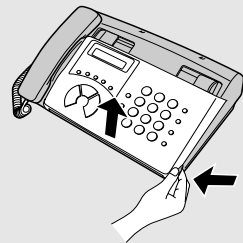

- 2 Flip up the front paper guide .

Note: Do not peel off or bend this strip of film.

UX-21
UX-41
FO-11
FO-51

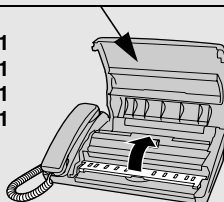

UX-61
FO-71
GQ-56

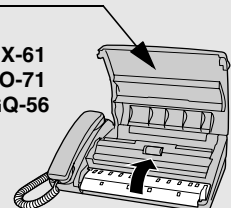

3 Remove the packing paper.

UX-21
UX-41
FO-11
FO-51

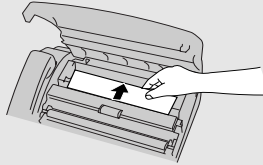

UX-61
FO-71
GQ-56

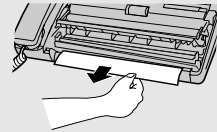

4 Flip down the front paper guide and then close the operation panel.

UX-21
UX-41
FO-11
FO-51

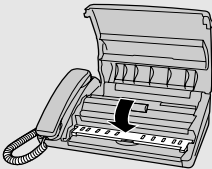

UX-61
FO-71
GQ-56

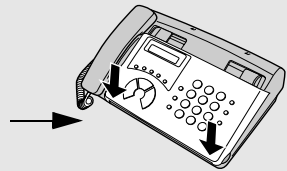
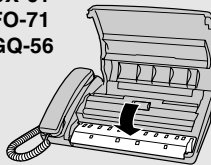

Connecting the power cord

Plug the power cord into a 220 - 240 V, 50/60 Hz, earthed AC (3-prong) outlet.

- ◆ When disconnecting the fax, unplug the telephone line cord before unplugging the power cord.

◆ Caution:

Do not plug the power cord into any other kind of outlet. This will damage the machine and is not covered under the warranty.

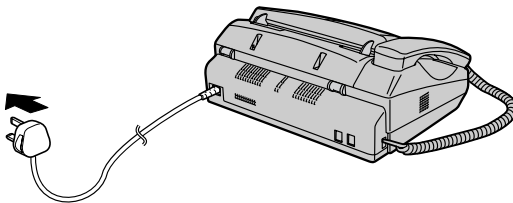

The machine does not have a power on/off switch, so the power is turned on and off by simply plugging in or unplugging the power cord.



Connecting the telephone line cord

Insert one end of the line cord into the socket on the back of the machine marked **TEL. LINE**. Insert the other end into a wall telephone socket.

Dial mode:

The fax machine is set for tone dialling. If you are on a pulse dial line, you must set the fax machine for pulse dialling. Press the keys on the operation panel as follows:

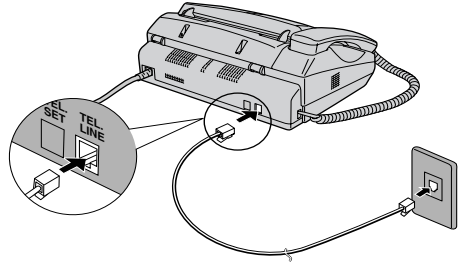

1 Press **FUNCTION** once and **4** once.

Display:

OPTION SETTING

2 Press **#** 4 times.

DIAL MODE

3 Select the dial mode:

1 TONE: **1** **2** PULSE: **2**

4 Press **STOP** to exit.

Comments:

- ◆ The fax machine is not designed for use on a line which has call waiting, call forwarding, or certain other special services offered by your telephone company. If you attempt to use the fax machine in conjunction with any of these services, you may experience errors during transmission and reception of facsimile messages.
- ◆ The fax machine is not compatible with digital telephone systems.
- ◆ If your area experiences a high incidence of lightning or power surges, we recommend that you install surge protectors for the power and telephone lines. Surge protectors can be purchased from your dealer or at most telephone specialty stores.

Moving your fax and reconnecting

If it is necessary to move your fax to a new location, first disconnect the telephone line cord before disconnecting the power cord. When reconnecting, it is necessary to connect the power cord before connecting the telephone line cord.

Attaching the original document support

Attach the original document support as shown below.

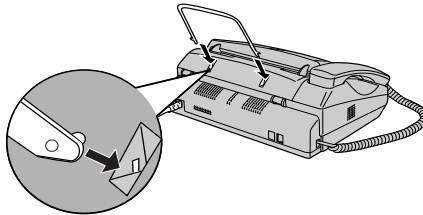

Extension phone (optional)

If desired, you can connect an extension phone to the **TEL. SET** socket on the fax.

◆ To connect an answering machine to your fax, see page 48.

- 1** Remove the seal covering the **TEL. SET** socket.

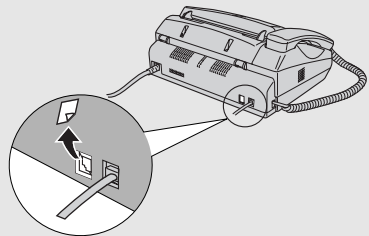

- 2** Connect the extension phone line to the **TEL. SET** socket.

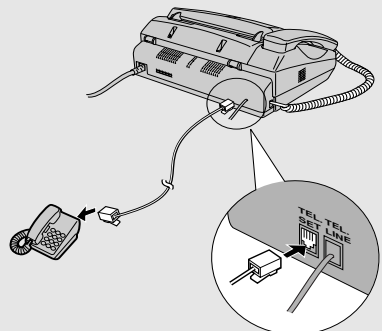

Loading the Thermal Paper

Your fax machine prints incoming faxes on a special kind of paper called thermal paper.



The fax machine's print head creates text and images by applying heat to the thermal paper.



- 1** Grasp the finger hold as shown and pull up to open the operation panel.

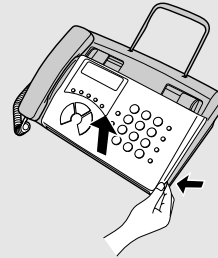

- 2** Flip up the front paper guide.

UX-21
UX-41
FO-11
FO-51

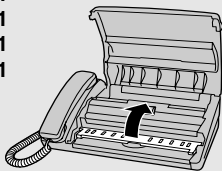

UX-61
FO-71
GQ-56

Press the knob to make sure the front side of the metal guide is down.

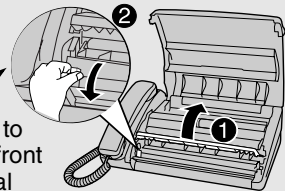

- 3** If you are loading paper that is 210 mm in width, place the paper roll shims on each side of the paper compartment. (Note that Sharp recommended paper, including the initial roll, is 216 mm in width.)

- The ribbed side of the shims should face in (toward each other).

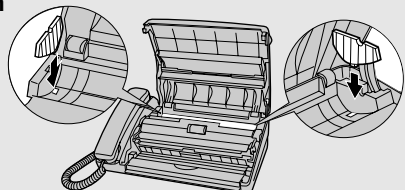

- 4** Unwrap the roll of thermal paper and insert the paper shaft.

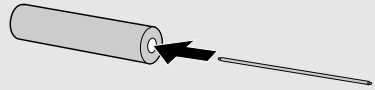

- 5** Place the roll of thermal paper in the compartment, making sure the ends of the paper shaft fit into the notches on each side of the compartment.

- **Important:** The roll must be placed so that the leading edge of the paper unrolls as shown. (The paper is only coated on one side for printing. If the roll is placed backwards, the paper will come out blank after printing.)

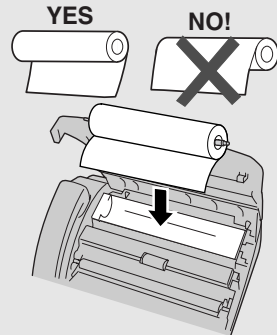

- 6** Insert the leading edge of the paper into the slot as shown. Continue to push the paper through the slot until it comes out the opening in the front of the machine.

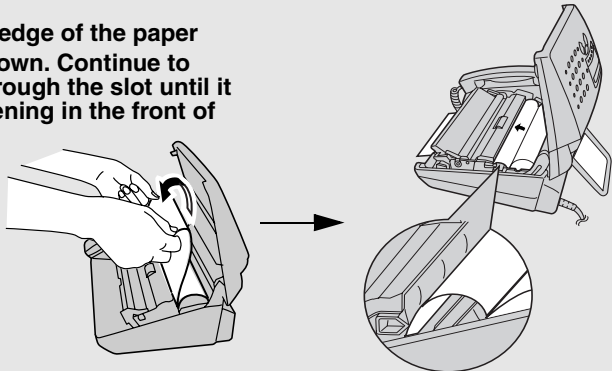

- 7** Make sure the paper comes out straight, and then flip down the paper guide.

UX-21
UX-41
FO-11
FO-51

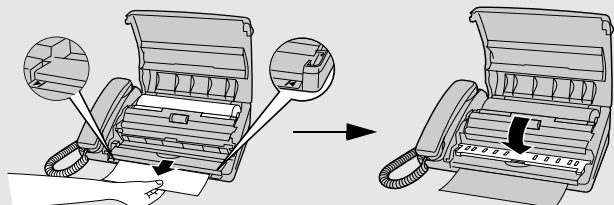

**UX-61
FO-71
GQ-56**

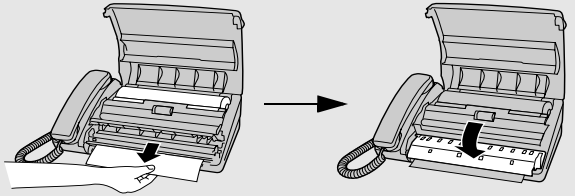

8 Close the operation panel, making sure it clicks into place.

- **UX-21/UX-41/FO-11/FO-51:** A short length of the paper will feed out. Grasp the paper by the edge and pull upward to tear it off.
- **UX-61/FO-71/GQ-56:** A short length of the paper will be cut off.

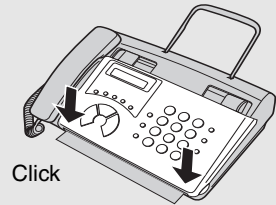

Replacing the thermal paper

When the paper runs out, OUT OF PAPER will appear in the display. Reception and copying will no longer be possible. To replace the paper, first take out the old roll, then load the new roll as described above.

To assure a long life for your fax and obtain the best reproduction quality, we recommend that you use the following Sharp thermal paper, which is available from your dealer or retailer:

FO-20PR THERMAL PAPER (30 m roll)

The use of any other paper may result in poor copy quality and excessive build-up of residue on the head.

Handling thermal paper

Do not unpack the paper until you are ready to use it. It may become discoloured if:

- ◆ It is stored at high humidity or high temperature.
- ◆ It is exposed to direct sunlight.
- ◆ It comes in contact with glue, thinner, or a freshly copied blueprint.
- ◆ A rubber eraser or adhesive tape is used on it, or it is scratched.

Entering Your Name and Fax Number

Before you can begin sending faxes, you must enter your name and fax (telephone) number. You also need to set the date and time.

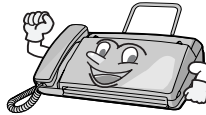

Once you enter this information, it will automatically appear at the top of each fax page you send.

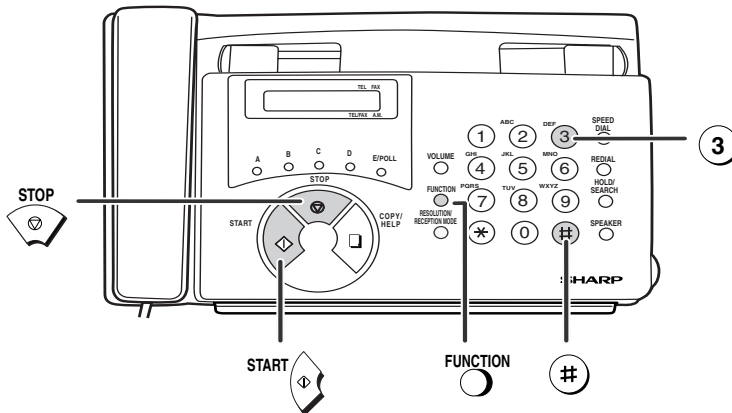

1 Press **FUNCTION** once and **3** once.

Display:

ENTRY MODE

2 Press **#** twice.

OWN NUMBER SET

3 Press **START** once.

ENTER FAX #

4 Enter your fax number by pressing the number keys (max. 20 digits).



- To insert a space between digits, press **#**. To enter a "+", press *****.
- To clear a mistake, press **SPEED DIAL**.

5 Press  to enter the fax number in memory.



6 Enter your name by pressing number keys for each letter as shown in the chart below. Up to 24 characters can be entered.

Example: SHARP = 77777 444 22 7777  77

SPACE = (1) (1)	J = (5) (5)	T = (8) (8)
A = (2) (2)	K = (5) (5) (5)	U = (8) (8) (8)
B = (2) (2) (2)	L = (5) (5) (5) (5)	V = (8) (8) (8) (8)
C = (2) (2) (2) (2)	M = (6) (6)	W = (9) (9)
D = (3) (3)	N = (6) (6) (6)	X = (9) (9) (9)
E = (3) (3) (3)	O = (6) (6) (6) (6)	Y = (9) (9) (9) (9)
F = (3) (3) (3) (3)	P = (7) (7)	Z = (9) (9) (9) (9) (9)
G = (4) (4)	Q = (7) (7) (7)	
H = (4) (4) (4)	R = (7) (7) (7) (7)	
I = (4) (4) (4) (4)	S = (7) (7) (7) (7) (7)	

◆ To enter two letters in succession that require the same key, press  after entering the first letter. ( moves the cursor forward, and  moves the cursor backward.)

◆ To clear a mistake, press .

◆ To change case, press . To enter one of the following symbols, press  or  repeatedly: . / ! " # \$ % & ' () * + , - : ; < = > ? @ [¥] ^ _ ' { | } → ←

7 Press  DATE & TIME SET

8 Press  to return to the date and time display.

Setting the Date and Time

The date and time appear in the display and are printed at the top of every page you fax. Set the date and time as shown below.

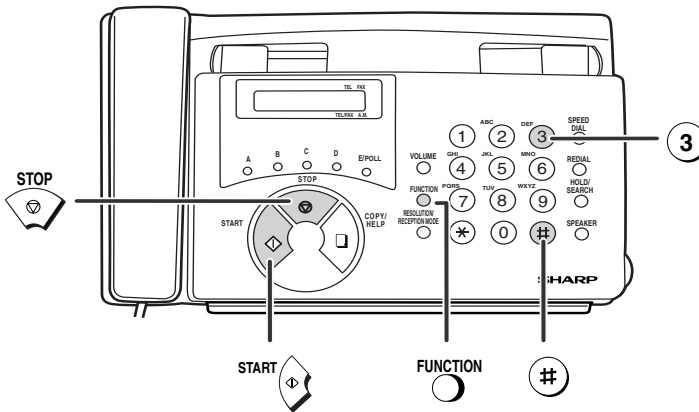
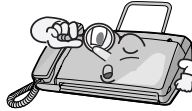

1 Press **FUNCTION** once and **3** once.

Display:

ENTRY MODE

2 Press **#** 3 times.



DATE & TIME SET

3 Press **START** once.

The currently set date appears (example):



DATE 15-08-2002

4 Enter a two-digit number for the day (“01” to “31”).

Example: the 5th   → DATE 05-08-2002

- To correct a mistake, press  to move the cursor back to the mistake and then enter the correct number.

5 Enter a two-digit number for the month (“01” for January, “02” for February, “12” for December, etc.).

Example: January   → DATE 05-01-2002

6 Enter the year (four digits).

The currently set time appears (example):

Example: 2002     → TIME 12:19

7 Enter a two-digit number for the hour (“00” to “23”) and a two-digit number for the minute (“00” to “59”).

Example: 9:25     → 05-JAN 09:25

8 Press  to start the clock.

STORE JUNK #

9 Press  to return to the date and time display.

Setting the Reception Mode

Your fax has four modes for receiving incoming faxes:

TEL mode:

This mode is the most convenient for receiving phone calls. Faxes can also be received; however, all calls must first be answered by picking up the fax's handset or an extension phone connected to the same line.

FAX mode:

Select this mode when you only want to receive faxes on your line. The fax machine will automatically answer all calls and receive incoming faxes.

TEL/FAX mode:

This mode is convenient for receiving both faxes and voice calls. When a call comes in, the fax will detect whether it is a voice call (including manually dialed faxes), or an automatically dialed fax. If it is a voice call, the fax will make a special ringing sound to alert you to answer. If it is an automatically dialed fax, reception will begin automatically.

A.M. mode:

Use this mode only if you have connected an answering machine to the fax (see Chapter 6). Select this mode when you go out to receive voice messages in your answering machine and faxes on your fax machine.

Setting the reception mode

Make sure a document *is not loaded in the document feeder*, and then

press  until the arrow in the display points to the desired mode.

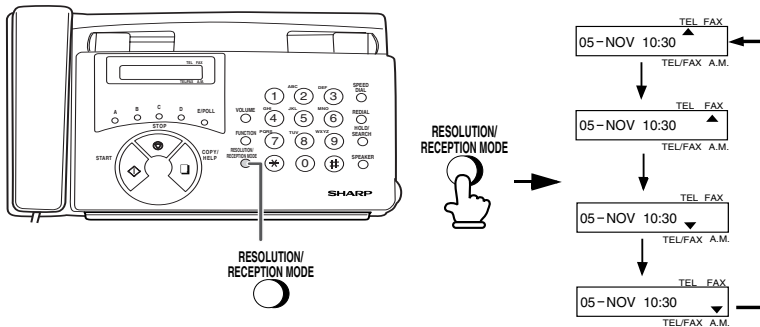

For more information on receiving faxes in FAX, TEL, and TEL/FAX modes, see Chapter 3, *Receiving Faxes* (page 38). For more information on using A.M. mode, see Chapter 6.

Volume Adjustment

You can adjust the volume of the speaker and ringer using  .

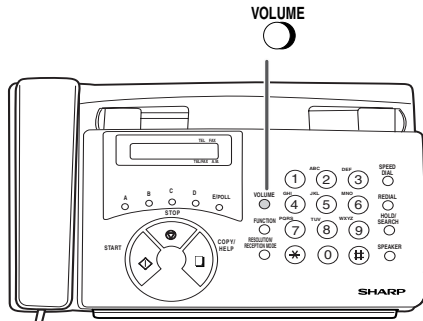

Speaker

1 Press  .

2 Press  one or more times to select the desired level.

- Press  again to turn off the speaker.

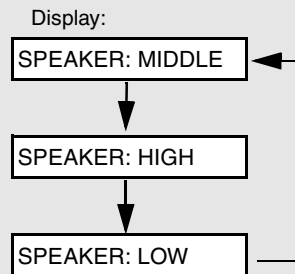

Ringer

1 Press  to select the desired volume.

(Make sure  has not been pressed and the handset is not lifted.)

- The ringer will ring once at the selected level, then the date and time will reappear in the display.

Display:

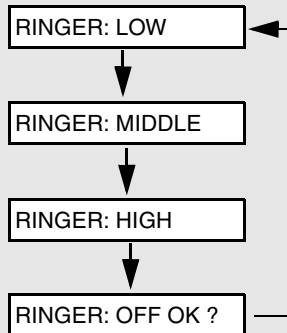

2 If you selected RINGER: OFF OK ?,

press .

2. Sending Faxes

Transmittable Documents

Size and weight

The size and weight of documents that you can load in the document feeder depend on whether you load one page at a time or several pages at once.

Loading one page at a time:

Minimum size

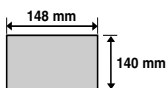

Maximum size

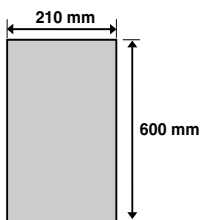

Loading up to 5 pages at once:

Minimum size

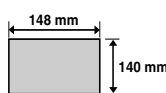

Maximum size

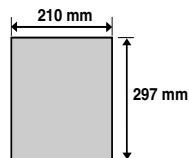

Minimum weight

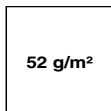

Maximum weight

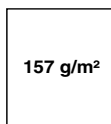

Minimum weight

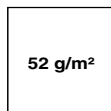

Maximum weight

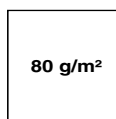

Note: Letters or graphics on the edges of a document will not be scanned.

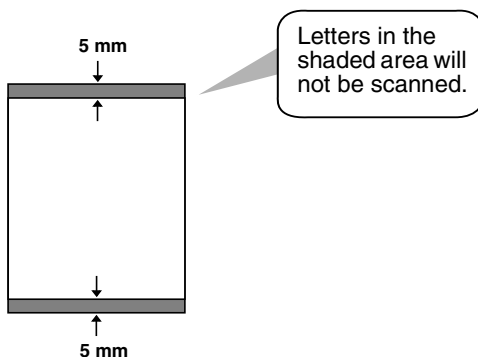

Other restrictions

- ◆ The scanner cannot recognise yellow, greenish yellow, or light blue ink.
- ◆ Ink, glue, and correcting fluid on documents must be dry before they pass through the document feeder.
- ◆ All clips, staples, and pins must be removed from documents before loading in the feeder. If these are not removed, they may damage the machine.
- ◆ Documents which are patched, taped, torn, smaller than the minimum size, carbon backed, easily smudged, or have a slippery coated surface should be photocopied, and the copy loaded in the feeder.

Loading the Document

Up to 5 pages can be placed in the feeder at one time. The pages will automatically feed into the machine starting from the bottom page.

- ◆ If you need to send or copy more than 5 pages, place the additional pages gently and carefully in the feeder just before the last page is scanned. Do not try to force them in, as this may cause double-feeding or jamming.
- ◆ If your document consists of several large or thick pages which must be loaded one at a time, insert each page into the feeder as the previous page is being scanned. Insert gently to prevent double-feeding.

- 1 Adjust the document guides to the width of your document.**



- 2 Insert the document face down in the document feeder. The top edge of the document should enter the feeder first.**

- READY TO SEND will appear in the display.

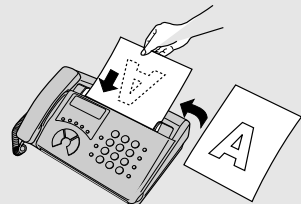

- Adjust the resolution and/or contrast settings as explained in *Resolution and Contrast* below, then dial the receiving machine as explained on page 28.

Removing a document from the feeder

If you need to remove a document from the feeder, open the operation panel.

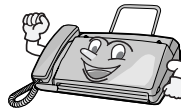

Important!

Do not try to remove a document without first releasing it as explained below. This may damage the feeder mechanism.

- Grasp the finger hold and pull up to open the operation panel.



- Remove the document.

- If you can not remove the document, see *Clearing a jammed document* on page 74.

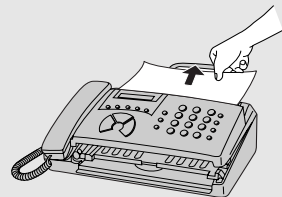

- Close the operation panel.

- Press down on both front corners of the panel to make sure it clicks into place.



Adjusting the Resolution and Contrast

If desired, you can adjust the resolution and contrast before sending a document.

The default resolution setting is **STANDARD** and the default contrast setting is **AUTO**.



You must adjust the settings each time you don't want to use the default settings.



Note: The resolution and contrast settings are only effective for sending a document. They are not effective for receiving a document.

Resolution settings

STANDARD	Use STANDARD for ordinary documents. This setting gives you the fastest and most economical transmission.
FINE	Use FINE for documents containing small letters or fine drawings.
SUPER FINE	Use SUPER FINE for documents containing very small letters or very fine drawings.
HALF TONE	Use HALF TONE for photographs and illustrations. The original will be reproduced in 64 shades of gray.

Contrast settings

AUTO	Use AUTO for normal documents.
DARK	Use DARK for faint documents.

1 Load the document(s).

- The document must be loaded before the resolution and contrast can be adjusted.

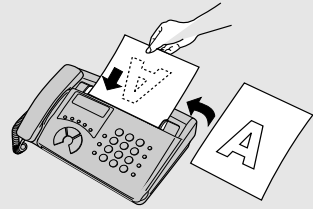

2 Press  one or more times until the desired resolution and contrast settings appear in the display.

- The first time you move through the list of resolution settings, the contrast setting AUTO will appear next to each resolution setting. The second time you move through the list, the contrast setting DARK will appear.

Display:

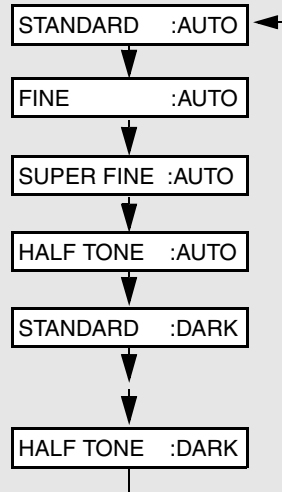

Note: In order to transmit in SUPER FINE resolution, the receiving fax machine must also have that resolution. If it doesn't, your machine will automatically step down to the next best available setting.

Sending a Fax by Normal Dialling

With Normal Dialling, you pick up the handset (or press ) and dial by pressing the number keys.

- ◆ If a person answers, you can talk with them through the handset before sending the fax. (If you pressed , you must pick up the handset to talk.)
- ◆ Normal Dialling allows you to listen to the line and make sure the other fax machine is responding.

1 Load the document(s).

- If desired, press  to set the resolution and/or contrast.

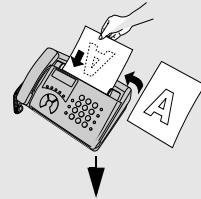

READY TO SEND

2 Pick up the handset or press . Listen for the dial tone.

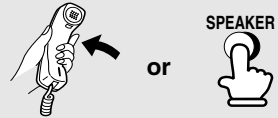

3 Dial the number of the receiving machine by pressing the number keys.



4 Wait for the connection. Depending on the setting of the receiving machine, you will either hear a fax tone or the other person will answer.

- If the other party answers, ask them to press their Start key (if you pressed , pick up the handset to speak with them). This causes the receiving machine to issue a fax tone.

5 When you hear the fax tone, press . Replace the handset if you used it.

- When transmission is completed, the fax will beep once.

Sending a Fax by Automatic Dialling

You can dial a fax or telephone number by simply pressing a Rapid Key, or by pressing the  and entering a two-digit number.

- ◆ To use Automatic Dialling, you must first store the full fax or telephone number in your fax machine
- ◆ When you store a fax or telephone number, you select a two-digit Speed Dial number for it. 40 Speed Dial numbers are available.

Speed Dial numbers 01 through 05 are for Rapid Key (one-touch) Dialling.



Speed Dial numbers 06 through 40 are for dialling with the **SPEED DIAL** key.

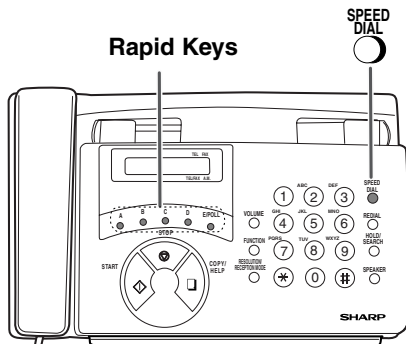
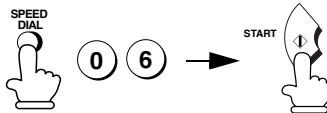

Storing fax and phone numbers for automatic dialling

1 Press  once and  once.

Display:

ENTRY MODE

2 Press  once.



FAX/TEL # MODE

3 Press  to select SET.

4 Enter a two-digit Speed Dial number by pressing the number keys (01 to 05 for Rapid Key Dialling, 06 to 40 for Speed Dialling).

  (Example)



















































































5 Enter the fax or voice number by pressing the number keys. Up to 32 digits can be entered. (Note: A space cannot be entered.)

- To clear a mistake, press .
- If a pause is required between any of the digits to access a special service or an outside line, press . The pause appears as a hyphen (two seconds per pause (**South Africa**: 4 seconds per pause)). Several pauses can be entered in a row.

6 Press 



7 Enter a name by pressing number keys for each letter as shown in the chart below. Up to 10 characters can be entered. (If you do not wish to enter a name, go directly to Step 8.)

◆ Example: SHARP = 77777 444 22 7777  77

SPACE =  	J =  	T =  
A =  	K =   	U =   
B =   	L =    	V =    
C =    	M =  	W =  
D =  	N =   	X =   
E =   	O =    	Y =    
F =    	P =  	Z =    
G =  	Q =   	
H =   	R =    	
I =    	S =     	

◆ To enter two letters in succession that require the same key, press  after entering the first letter.

◆ To change case, press . To enter one of the following symbols, press

 or  repeatedly: . / ! " # \$ % & ' () * + , - : ; < = > ? @ [¥] ^ _ ' { | }
→ ←

8 Press 

9 Return to Step 4 to store another number, or press  to return to the date and time display.

Making changes

To make changes in a number previously stored, repeat the programming procedure. Select the Rapid Key or Speed Dial number for which you want to make changes in Step 4, and then change the number and/or name when they appear in the display in Steps 5 and 7.

Note: The fax machine uses a lithium battery to keep automatic dialling numbers and other programmed information in memory when the power is turned off. Battery power is consumed primarily when the power is off. With the power kept continuously off, the life of the battery is about 5 years. If the battery dies, have your dealer or retailer replace it. Do not try to replace it yourself.

Clearing auto-dial numbers

If you need to clear a number, follow these steps:

1 Press  once and  once.

Display:

ENTRY MODE

2 Press  once.

3 Press  to select CLEAR.

4 Enter the Speed Dial number that you want to clear by pressing the number keys.

5 Press 

6 Return to Step 4 to clear another number, or press  to return to the date and time display.

Chain Dialling for area and access codes

You can also store an area code or access code in a Rapid Key or Speed Dial number. To use this number to dial, see *Chain Dialling* in Chapter 5, *Making Telephone Calls*.

Note: An area code or access code stored in a Rapid Key or Speed Dial number can only be used if the handset is lifted or the  key is pressed before dialling.

Sending a fax by Rapid Key Dialling

If the number you want to dial has been stored for Automatic Dialling as a Speed Dial number from 01 to 05, you can dial it by pressing the corresponding Rapid Key.

1 If you are sending a fax, load the document(s).

- If desired, press  to set the resolution and/or contrast.

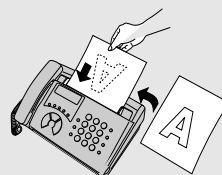

READY TO SEND

2 Press the Rapid Key for the desired Speed Dial number as follows:

Speed Dial 01: Rapid Key A
 Speed Dial 02: Rapid Key B
 Speed Dial 03: Rapid Key C
 Speed Dial 04: Rapid Key D
 Speed Dial 05: Rapid Key E



Example:
 To dial Speed Dial number 01, press Rapid Key A.

- The name of the receiving party will appear in the display. If no name was stored, the fax number will appear. (If the name or number is incorrect, press  .)
- The document will be automatically transmitted once the connection is established.

Sending a fax by Speed Dialling

Speed Dialling can be used to dial any number that has been stored for Automatic Dialling.

1 Load the document(s).

- If desired, press  to set the resolution and/or contrast.

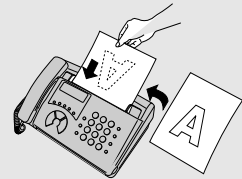

READY TO SEND

2 Press and then enter the Speed Dial number by pressing the numeric keys.

- To enter numbers 1 through 9, first enter 0 and then the number.

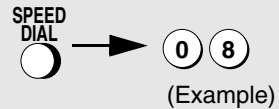

3 Check the display. If the name or number shown is correct, press .

(If not, press  and then repeat Step 2.)

Sending a fax by Direct Keypad Dialling

You can also enter a full number with the number keys and then press  to begin dialling. You can use this method to dial a full number when you don't need to speak to the other party before faxing.

1 Load the document(s).

- If desired, press  to set the resolution and/or contrast.

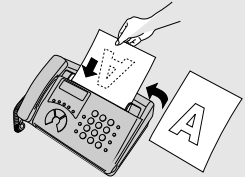

READY TO SEND

2 Enter the number of the receiving machine by pressing the number keys.

- If a pause is required between any of the digits to access a special service or an outside line, press . The pause will appear as a hyphen (two seconds per pause (**South Africa:** 4 seconds per pause)). Several pauses can be entered in a row.

3 Check the display. If the number of the receiving machine shown is correct, press .

- If the number is not correct, press  to backspace and clear one digit at a time, and then re-enter the correct digit(s).

Searching for an auto-dial number

If you don't remember the Rapid Key or Speed Dial number in which you have programmed a particular fax number, you can search for the number by following the steps below. Once you have found the number, you can dial and transmit the loaded document by simply pressing **START**  .

1 Load the document(s).

- If desired, press **RESOLUTION/RECEPTION MODE**  to set the resolution and/or contrast.

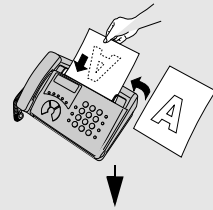

READY TO SEND

2 Press **HOLD/SEARCH** and then **1** .



3 Enter the first letter of the stored name by pressing the appropriate number key (the key below the marked letter) one or more times until the letter appears in the display. If the name begins with a special character or number, press **1** .

- If you don't remember the first letter, go to Step 4 (you will scroll through the list from the beginning).
- If a name wasn't stored for the number, press **0** . This will cause numbers, not names, to appear when you scroll.

4 Press *** (X)** or **# (#)** to scroll through the names (numbers if you pressed 0). Stop when the desired name appears in the display.

5 Press **START** . The document will be automatically transmitted once the connection is established.

Using the REDIAL key

You can press  to redial the last number dialed. To send a document, press  when you hear the fax tone after the connection is made. Note that the speaker is automatically activated when you press .

Automatic redialling

If you use automatic dialling (including Direct Keypad Dialling) to send a fax and the line is busy, the fax machine will automatically redial the number. The fax machine will make 2 redial attempts at an interval of 5 minutes. To stop automatic redialling, press .

3. Receiving Faxes

Using TEL/FAX Mode

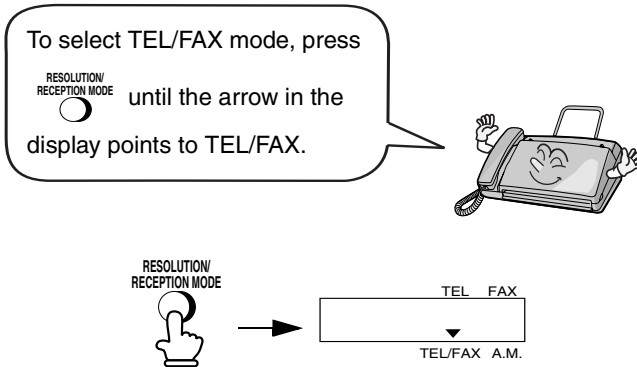

When the reception mode is set to TEL/FAX, your fax machine automatically answers all calls on two rings. After answering, your fax monitors the line for about five seconds to see if a fax tone is being sent.

- ◆ If your fax machine detects a fax tone (this means that the call is an automatically dialed fax), it will automatically begin reception of the incoming document.
- ◆ If your fax machine doesn't detect a fax tone (this means that the call is a voice call or manually dialed fax), it will make a ringing sound (called pseudo ringing) for 30 seconds to alert you to answer. If you don't answer within this time, your fax will send a fax tone to the other machine to allow the calling party to send a fax manually if they desire.

Note: Only the fax will alert you to voice calls or manually dialed faxes by pseudo ringing. An extension phone connected to the same line will not ring after the connection has been established.

Using A.M. Mode

To select A.M. mode, press  until the arrow in the display points to A.M.

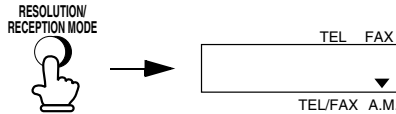

In A.M. mode, your fax will automatically receive voice and fax messages if you have connected an answering machine to the fax machine. See Chapter 6 for more details.

Using FAX Mode

To select FAX mode, press  until the arrow in the display points to FAX.

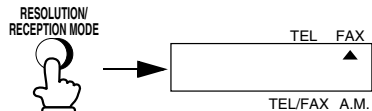

When the reception mode is set to FAX, the fax machine will automatically answer all calls on two rings and receive incoming faxes.

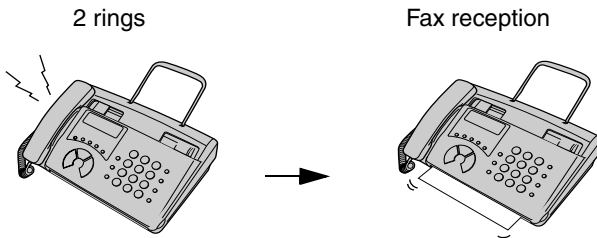

- ◆ If you pick up the handset before the machine answers, you can talk to the other party and/or receive a fax as explained in *Using TEL Mode* on page 41.

Changing the number of rings

If desired, you can change the number of rings on which the fax machine answers incoming calls in FAX and TEL/FAX mode. Any number from 2 to 5 can be selected.

◆ **Note for Singapore:** "2" or "3" can be selected for the number of rings.

1 Press  once and  once.

Display:

OPTION SETTING

2 Press  once.

NUMBER OF RINGS

3 Enter the desired number of rings (any number from 2 to 5).

Example: 3 rings 

4 Press  to return to the date and time display.

Using TEL Mode

When the reception mode is set to TEL, you must answer all calls by picking up the fax machine's handset or an extension phone connected to the same line.

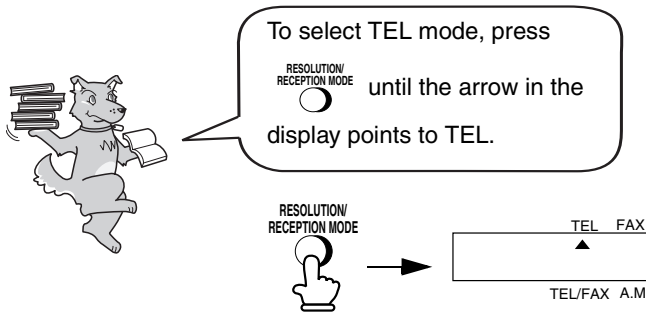

Answering with the fax's handset

- 1** When the fax machine rings, pick up the handset.



- 2** If you hear a fax tone, wait until the display shows RECEIVING and then replace the handset.

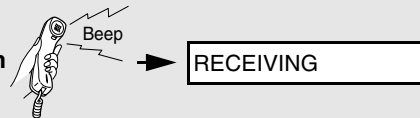

Note: If you have set the Fax Signal Receive setting (page 43) to NO, press **START**  to begin reception.

- 3** If the other party first speaks with you and then wants to send a fax, press **START**  after speaking. (Press before the sender presses their Start key.)

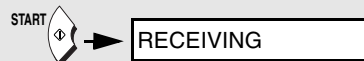

- When RECEIVING appears in the display, hang up.



Answering on an extension phone

- 1** Answer the extension phone when it rings.



- 2** If you hear a soft fax tone, wait until your fax responds (the extension phone will go dead), then hang up.

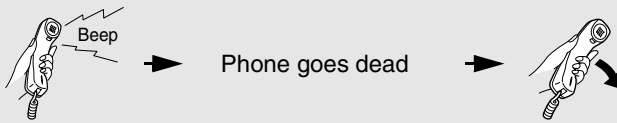



- 3** If the fax doesn't respond, or if the other party first talks to you and then wants to send a fax, press **5** once and ***** twice on the extension phone (only on a tone dial phone). This signals the fax to begin reception. Hang up.

- The above step is necessary if you have set the Fax Signal Receive setting (page 43) to NO.
- Your fax will not accept the signal to begin reception (5***) if a document is loaded in its feeder.

Optional Reception Settings

Fax Signal Receive

Your fax will automatically begin reception if you hear a soft fax tone after answering a call on your fax or an extension phone. If you use a computer fax modem to send documents on the same line, you must turn this function off in order to prevent your fax from mistakenly attempting to receive documents from the computer fax modem. Follow the steps below to change the setting.

1 Press  once and  once.



Display:

OPTION SETTING

2 Press  3 times.

FAX SIGNAL RX

(South Africa: Press  twice.)

3 Press  to turn on the function, or
 to turn it off.

4 Press  to return to the date and time display.

Changing the number for remote fax activation

If desired, you can use a number other than **5** to activate fax reception from an extension telephone. You can select any number from **0** to **9**.

1 Press  once and  once.

Display:

OPTION SETTING

2 Press  twice.

TEL/FAX REMOTE #

3 Enter the desired number (any number from 0 to 9).

Example: 3 

4 Press  to return to the date and time display.

Substitute Reception to Memory

◆ **Note for UX-21/FO-11:** This function is not available.

In situations where printing is not possible, such as when your fax runs out of paper or the paper jams, incoming faxes will be received to memory.

When you have received a document in memory, FAX RX IN MEMORY will appear in the display, alternating with OUT OF PAPER or PAPER JAMMED. When you add paper or clear the jam, the stored documents will automatically print out.

Caution!

When documents are stored in memory, do not turn the power off. This will erase all of the contents.

4. Making Copies

Your fax machine can also be used to make copies.

1 Load the document(s) face down. (Maximum of 5 pages.)

- If desired, press  to set the resolution and/or contrast. (The default resolution setting for copying is FINE.)

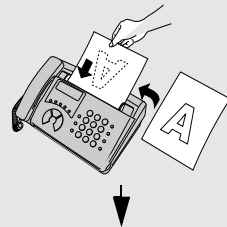

2 When you are ready to begin copying, press COPY/HELP .

5. Making Telephone Calls

Your fax machine can be used like a regular telephone to make and receive voice calls.

- ◆ To make or receive a voice call, the power must be on.

- 1** Pick up the handset or press  .
Listen for the dial tone.

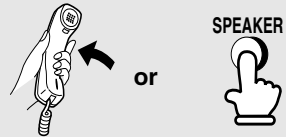

- 2** Dial the number using one of the following methods:

- **Normal Dialling:** Enter the full telephone number with the numeric keys.
- **Rapid Key Dialling:** Press the appropriate Rapid Key.
- **Speed Dialling:** Press  , and enter the 2-digit Speed Dial number with the numeric keys.

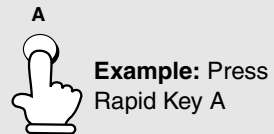



- 3** Speak with the other party when they answer.

- If you pressed  , pick up the handset to talk.



Chain Dialling

After lifting the handset, you can dial any combination of Normal Dialling, Rapid Key Dialling and Speed Dialling numbers. For example, if you have stored an area code or an access code for a special service in a Rapid Key, you can press the Rapid Key for that area code or access code, then dial the remainder of the number by pressing a Rapid Key, pressing number keys, or pressing  and entering a two-digit Speed Dial number.



Searching for an auto-dial number

You can use  to search for a Rapid Key or Speed Dial number. First search for the number as described in *Searching for an auto-dial number* in *Sending a Fax by Automatic Dialling* in Chapter 2, then pick up the handset or press . The number will be dialed automatically (do not press ).

Redial

The last number dialed can be redialed by pressing  (it is not necessary to pick up the handset or press ). When the other party answers, pick up the handset to talk.

Hold

You can put the other party on hold during a conversation by pressing . When this is done, they cannot hear you. You can put the handset back in the cradle without breaking the connection. When you are ready to speak with them again, pick up the handset. If you did not put the handset back in the cradle, press  again to resume conversation.

6. Answering Machine Connection

Connecting an Answering Machine

If desired, you can connect an answering machine to your fax machine's **TEL. SET** socket. This will allow you to receive both voice messages and faxes when you are out.

- ◆ **Important:** If the answering machine is not connected to the **TEL. SET** socket on the fax as shown, the setup will not operate properly.

-
- 1** Remove the seal covering the **TEL. SET** socket.

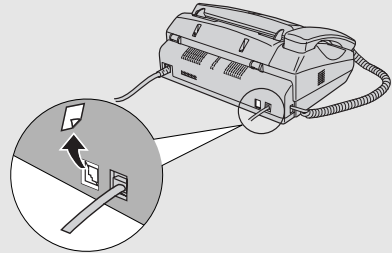

- 2** Connect the answering machine's telephone line plug to the **TEL. SET** socket.

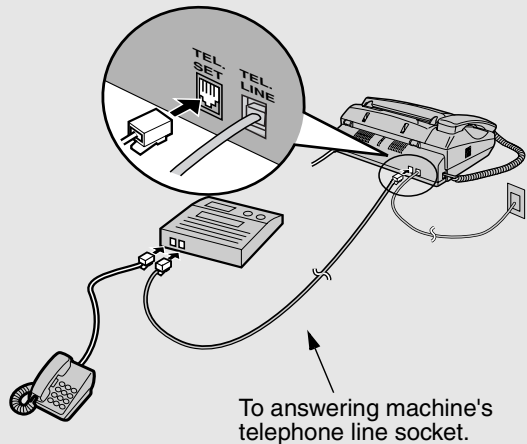

Changing the outgoing message

The outgoing message (OGM) of your answering machine should be changed to inform callers who want to send a fax to press their Start key. For example, your message might go as follows:

"Hello. You've reached the ABC company. No one is available to take your call right now. Please leave a message after the beep or press your facsimile Start key to send a fax. Thank you for calling."

- ◆ It is advisable to keep the length of the message under 10 seconds. If it is too long, you may have difficulty receiving faxes sent by automatic dialling.
- ◆ If your outgoing message must be longer than 10 seconds, leave a pause of about four seconds at the beginning of the message. This will give your fax a chance to detect fax tones sent when automatic dialling is used.

Using the Answering Machine Connection

1 Set the reception mode to A.M.

RESOLUTION/
RECEPTION MODE

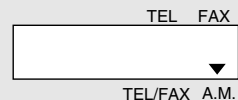

2 Set your answering machine to auto answer.

- ◆ Your answering machine must be set to answer on a maximum of two rings. If not, you may not be able to receive faxes sent by automatic dialling.
- ◆ If your answering machine has a toll saver function, make sure that it will answer by the fourth ring.

Note: If your answering machine has a remote retrieval function, make sure the code used to activate remote retrieval is different from the code used to activate fax reception with an extension telephone (see Chapter 3, *Receiving Faxes*). If they are the same, entering the code from an outside telephone to retrieve messages will cause the fax machine to be activated.

How answering machine mode operates

While you are out, all of your incoming calls will be answered by your answering machine and its outgoing message will play. Voice callers can leave a message. During this time, your fax will quietly monitor the line. If your fax detects a fax tone or a duration of silence greater than four seconds, it will take over the line and begin reception.

- ◆ If the connection is not good or there is noise on the line, the answering machine and/or fax machine may not respond properly.
- ◆ The call counter on your answering machine may indicate that voice messages were received, when only fax messages were received.
- ◆ To prevent the fax from taking over the line and beginning reception if you call in from an external phone or answer on an extension phone, press any three keys (other than the code to activate fax reception, "5", "✳", and "✳") on the dial pad of the phone. This can only be performed from a phone capable of tone dialling.

When you return and turn off your answering machine, be sure to change the reception mode back to TEL/FAX, FAX, or TEL!

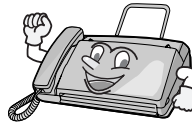

Optional A.M. Mode Settings

If necessary, you can use the following settings to improve the response of the answering machine connection to incoming calls.

Quiet Detect Time

This function causes the fax machine to take over the line and begin reception if a certain duration of silence is detected after the answering machine answers.

Time selections for the period of silence are 1 to 10 seconds. Quiet Detect Time has been set to 4 seconds at the factory. This gives the best performance with most answering machines; however, you may need to adjust this setting depending on the disconnect time of your answering machine.

Some answering machines may have unusually fast disconnect times (equal to or very slightly less than 4 seconds), which means that the answering machine may disconnect the line before fax reception can begin. In this case, try a Quiet Detect Time setting of about 3 seconds.

If the fax machine is interrupting callers before they can leave a message, try a longer Quiet Detect Time setting. If your outgoing message includes a period of silence, make sure that the setting is longer than that period of silence, or re-record your outgoing message to shorten the silence.

Note: Quiet Detect Time can be turned off by entering "00" for the time. Note, however, that the fax machine will not be able to receive faxes sent manually by Normal Dialling.

To change the setting, follow the steps below.

1 Press **FUNCTION** once and **4** once.

Display:

OPTION SETTING

2 Press **#** 5 times.

QUIET DETECT TM.

-
- 3** Enter a number from 01 to 10, or enter 00 to turn off the function.

Example: 3 seconds  

- 4** Press  to return to the date and time display.

Quiet Detect Start Time

This setting can be used to delay the start of the Quiet Detect Time function. For example, if you want to insert a pause at the beginning of your answering machine's outgoing message to ensure clear detection of fax signals, you can use this setting to delay the start of silence detection so that the pause will not cause the fax to take over the line.

Quiet Detect Start Timing has been set to five seconds at the factory. You can change this setting by entering a 2-digit number equal to the desired number of seconds of the delay, or turn the function off by entering **00**. As general guide, the delay time should be slightly longer than the pause before the outgoing message.

-
- 1** Press  once and  once.

Display:

OPTION SETTING

- 2** Press  6 times.

QUIET START TIME

- 3** Enter a 2-digit number (from 01 to 15) for the number of seconds of the delay, or enter 00 to turn off the function.

Example: 5 seconds  

- 4** Press  to return to the date and time display.

On A.M. Failure

When this function is turned on, your fax will answer the call after 5 rings if the answering machine for some reason fails to answer before that time. This ensures that you will receive fax messages even if the answering machine's tape fills up or the answering machine is not turned on.

This function has been turned off at the factory. If you want to turn it on, follow the steps below:

Note: When this function is turned on, make sure that the answering machine is set to answer on 4 rings or less. If it isn't, the fax will always answer first, preventing callers from leaving voice messages.

1 Press  once and **4** once.

Display:

OPTION SETTING

2 Press  4 times.

(South Africa: Press  3 times.)

FAX RX A.M. FAILS

3 Press **1** to turn on the function, or
2 to turn it off.

4 Press  to return to the date and time display.

7. Special Functions

Caller ID (Requires Subscription to Service)

This function is only available in Singapore and Malaysia.

If you subscribe to a caller identification service from your telephone company, you can set your fax machine to display the name and number of the caller while the fax rings.

Important:

- ◆ To use this function, you must subscribe to a caller identification service from your telephone company.
- ◆ Your fax may not be compatible with some caller identification services.



1 Press  **once and**  **once.**

Display:

OPTION SETTING

2 Press  **once.**

CALLER-ID

3 Press  **(YES) to turn on Caller ID.**
(To turn off Caller ID, press )

1=YES, 2=NO

4 Press  **to return to the date and time display.**

How Caller ID operates

When you receive a call, the name and phone number of the caller will alternately appear in the display, beginning just before the second ring. The information will continue to be displayed until the line is disconnected.

Note: Some caller ID services may not provide the name of the caller. In this case, only the phone number will appear.

Display example

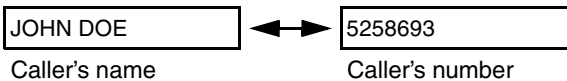

Display messages

One of the following messages will appear while the fax rings if caller information is not available.

NO SERVICE	No caller information was received from your telephone company. Make sure that the telephone company has activated your service.
CALLER-ID ERROR	Noise on the telephone line prevented reception of caller information.
OUT OF AREA	The call was made from an area which does not have a caller identification service, or the caller's service is not compatible with that of your local phone company.
PRIVATE CALL	Caller information was not provided by the telephone company at the caller's request.

Viewing the Caller ID list



If you subscribe to a Caller ID service and have turned on the Caller ID function, your fax machine will keep information on the most recent 20 calls and faxes you have received. You can view this information, which consists of the name and number of each caller, in the Caller ID List.

◆ After you have received 20 calls, each new call will delete the oldest call.

Follow the steps below to view the Caller ID List in the display. If desired, you can immediately dial a number when it appears.

1 Press  once and  once.



REVIEWING CALLS

2 Press  or  to scroll through the list.

3 If you want to dial one of the numbers in the list, scroll through the list until the number appears in the display.

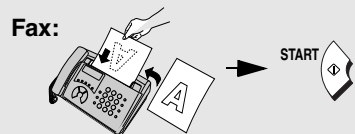
- **Fax:** If you want to send a fax, load the document and then press . Dialling and transmission begin.



- **Voice call:** If you want to make a voice call, pick up the handset or press . Dialling begins automatically.
(If you pressed , pick up the handset when the other party answers.)



4 Press  when you have finished viewing the list.

To delete calls from the Caller ID list

If you want to delete a single call from the caller list, press **0** while the call appears in the display. If you want to delete all calls from the list, hold **0** down for at least 3 seconds while you are viewing any number in the list.

Priority Call

With Caller ID turned on, you can set your fax to make a special ringing sound when you receive a call from a designated phone number. This lets you know immediately who is calling without having to look at the display.

To use this function, enter the desired phone number by following the steps below (only one phone number can be entered).

1 Press **FUNCTION** once and **3** once.

Display:

ENTRY MODE

2 Press ***** once.

PRIORITY CALL #

3 Press **1** to store a number.

(To clear a previously stored number, press **2** and go to Step 5.)

4 Enter the number by pressing the number keys (max. 20 digits).

5 Press **START** to store (or clear) the number.

6 Press **STOP** to return to the date and time display.

Blocking voice calls

With Caller ID turned on, you can use the Anti Junk Fax function described in *Blocking Reception of Unwanted Faxes* in this chapter to block voice calls as well as faxes from your specified Anti Junk Number.

In this case, when a voice call or a fax transmission comes in from a number you have specified as a "Junk Number", your fax will break the connection as soon as it receives the calling phone number from the caller ID service (before the second ring).

To use this function, enter the number that you wish to block as explained in *Blocking Reception of Unwanted Faxes* (see page 59).

Blocking Reception of Unwanted Faxes

The Anti Junk Fax function allows you to block reception of faxes from parties that you specify. This saves paper by not printing out unwanted "junk" faxes. To use this function, enter the fax numbers from which you do not want to receive faxes as shown below.

- ◆ Up to five numbers can be entered in the Anti Junk Number List. To clear a number from the Anti Junk Number List, you need to know the 1-digit number which identifies it. If you have forgotten this number, print out the Anti Junk Number List as explained in Chapter 8.

1 Press  once and **3** once.

Display:

ENTRY MODE

2 Press  twice.

(South Africa: Press  once.)

STORE JUNK #

3 Press **1** to store an Anti Junk number, or **2** to clear a previously stored number.

4 **Entering:** Enter a 1-digit number from "1" to "5" with the numeric keys. This number identifies the fax number that you will enter in the next step.

(Example) **1**

Clearing: Enter the 1-digit number that identifies the fax number you want to clear, and go to step 6.

5 Enter the fax number by pressing the number keys (max. 20 digits).

6 Press .

7 Return to Step 4 to enter (or clear) another fax number, or press to return to the date and time display.



Polling (Requesting a Fax Transmission)

Polling allows you to call another fax machine and have it send a document (previously loaded in its feeder) to your machine without operator assistance. In other words, the receiving fax machine, not the transmitting fax machine, initiates the transmission.

To use the polling function, you must first set Rapid Key E/POLL for use as a polling key.

- ◆ When Rapid Key E/POLL is set as a polling key, it cannot be used for Rapid Key dialling.

1 Press  once and **4** once.

Display:

OPTION SETTING

2 Press  twice.

(South Africa: Press  once.)

POLLING

3 Press **1** (YES) to turn on the function.

(To turn off the function, press **2**)

4 Press  to return to the date and time display.

Requesting transmission**1 Dial the fax machine you want to poll using one of the following methods:**

- Pick up the handset (or press ) and press a Rapid Key. Wait for the fax answerback tone.



- Press  and enter a 2-digit Speed Dial number.
- Enter the full number using the numeric keys.

2 Press  .

- If you used the handset, replace it when POLLING appears in the display. Reception will begin.

E/POLL



8. Printing Lists

You can print lists showing settings and information entered in the fax machine. The lists are described below. To print a list, follow these steps.

1 Press  once and  once.

Display:

LISTING MODE

2 Press  to select the Anti Junk Number List, or  to select the Telephone Number List.

3 Press  to print the list.

Telephone Number List

This list shows the fax and phone numbers that have been stored for automatic dialling.

Anti Junk Number List

This list shows the numbers from which reception is not allowed.

Transaction Report

This report is printed out automatically after an operation is completed to allow you to check the result. Your fax machine is set at the factory to print out the report only when an error occurs.

- ◆ The Transaction report cannot be printed on demand.

Headings in Transaction Report

SENDER/RECEIVER The name or fax number of the other machine involved in the transaction. If that machine does not have an ID function, the communication mode will appear (for example, "G3").

START The time at which transmission/reception started.

TX/RX TIME Total time taken for transmission/reception.

PAGES Number of pages transmitted/received.

NOTE (One of the following notes will appear under **NOTE** in the report to indicate whether the transaction was successful, and if not, the reason for the failure.)

OK - Transmission/reception was successful.

P.FAIL - A power failure prevented the transaction.

JAM - The printing paper or document jammed, preventing the transaction.

BUSY - The fax was not sent because the line was busy.

COM.E-0 to COM.E-7 - A telephone line error prevented the transaction. See *Line error* on page 67.

CANCEL - The transaction was cancelled because the **STOP** key was pressed, no document was in the feeder, or the other machine requested transmission using a function which your fax machine does not have. If you were attempting to fax, make sure a document is in the feeder. If you were receiving, contact the faxing party to see how they are trying to send to you.

Transaction Report print condition

You can change the condition under which a Transaction Report is printed out. Follow the steps below.

1 Press **FUNCTION**  once and **4** once.

Display:

OPTION SETTING

2 Press **#**  3 times.

TRANSACTION LIST

3 Press a number from **1** to **4** to select the condition for printing.

- | | |
|-----------------------|------------------------------------------------------------------------|
| 1 ALWAYS PRINT | A report will be printed after each transmission, reception, or error. |
| 2 ERROR PRINT | A report will be printed only when an error occurs. |
| 3 SEND ONLY | A report will be printed after each transmission. |
| 4 NEVER PRINT | A report will never be printed. |

4 Press  to return to the date and time display.

9. Maintenance

Cleaning the scanning glass and rollers

Clean the scanning glass and rollers frequently to ensure the quality of your transmitted images and copies.

- 1** Grasp the finger hold and pull up to open the operation panel.

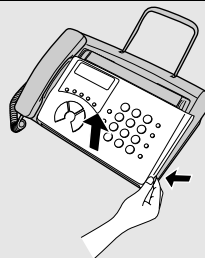

- 2** Flip up the green levers on each side of the white roller.

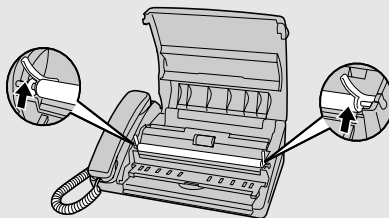

- 3** Wipe the scanning glass and rollers with a cotton pad.

- Make sure that all dirt and stains (such as correcting fluid) are removed, as dirt will cause vertical lines on transmitted images and copies. (If necessary, wipe with denatured alcohol.)
- Adhesive cellophane tape is useful for removal of debris from the rollers.

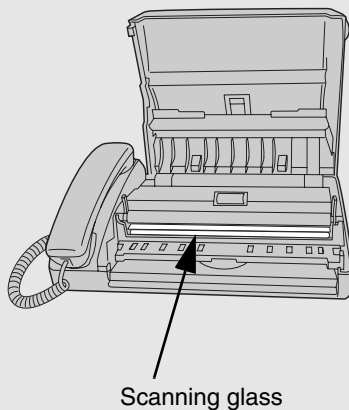

- 4** Flip down the green levers on each side of the white roller.

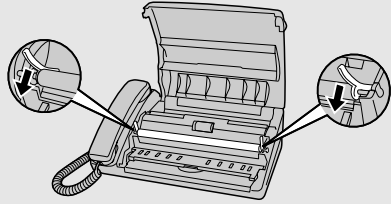

- 5** Flip up the front paper guide and wipe the roller under it.

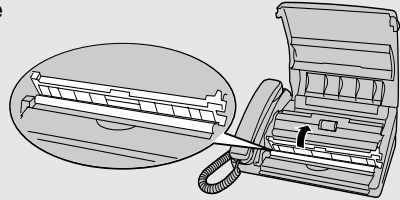

- 6** Flip down the front paper guide.

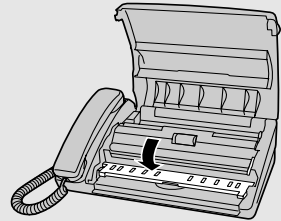

- 7** Close the operation pane.

- Press down on both front corners of the panel to make sure it clicks into place.

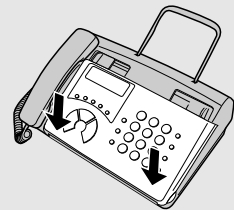

Cleaning the housing

Wipe the external parts and surface of the machine with a dry cloth.

Caution!

- Do not use benzene or thinner. These solvents may damage or discolor the machine.

10. Troubleshooting

Problems and Solutions

Line error

Problem	Solution
LINE ERROR appears in the display.	<p data-bbox="423 435 983 490">Try the transaction again. If the error persists, check the following:</p> <ul data-bbox="423 522 983 992" style="list-style-type: none"><li data-bbox="423 522 983 600">• Check the connection. The cord from the TEL. LINE socket to the wall socket should be no longer than two meters.<li data-bbox="423 631 983 686">• Make sure there are no modem devices sharing the same telephone line.<li data-bbox="423 718 983 773">• Check with the other party to make sure their fax machine is functioning properly.<li data-bbox="423 804 983 827">• Have your telephone line checked for line noise.<li data-bbox="423 859 983 914">• Try connecting the fax machine to a different telephone line.<li data-bbox="423 945 983 992">• If the problem still occurs, your fax machine may need service.

Dialling and transmission problems

Problem	Solution
No dial tone when you pick up the handset or press the SPEAKER key.	<ul style="list-style-type: none"> • Make sure the handset cord is connected to the correct socket. See <i>Connecting the handset</i> on page 9.
Dialling is not possible.	<ul style="list-style-type: none"> • Make sure the power cord is properly plugged into a power outlet. • Make sure that the telephone line is properly connected to both the TEL. LINE socket and the wall socket. • Make sure that the fax machine is set to the correct dialling mode for your telephone line. See <i>Dial mode</i> on page 11.
The power is on, but no transmission takes place.	<ul style="list-style-type: none"> • Make sure that the receiving machine has paper. • Make sure that the telephone line cord is plugged into the TEL. LINE socket, and not the TEL. SET socket. • If the receiving machine is in manual mode with no attendant, reception will not be possible. • Check the display for error messages. • Pick up the handset and check for a dial tone.
Nothing is printed at the receiving end.	<ul style="list-style-type: none"> • Make sure that the document for transmission is placed face down in the feeder.
A distorted image is received at the other end.	<ul style="list-style-type: none"> • Noise on the telephone line may cause distortion. Try sending the document again. • Make a copy of the document on your fax machine. If the copy is also distorted, your fax machine may need service.

Reception and copying problems

Problem	Solution
The power is on, but no reception takes place.	<ul style="list-style-type: none"> • Make sure that the telephone line cord is plugged into the TEL. LINE socket, and not the TEL. SET socket.
The printing paper comes out blank when you try to receive a document.	<ul style="list-style-type: none"> • Make sure that the document is loaded properly in the feeder of the transmitting machine. Make a copy or print a report to confirm the printing ability of your machine. • Make sure that the thermal paper is properly loaded in your fax machine. (If the roll has been loaded backwards, nothing will be printed.)
The received document is faint.	<ul style="list-style-type: none"> • Ask the other party to send higher contrast documents. If the contrast is still too low, your fax machine may need service. Make a copy or print a report to check your machine's printing ability. • Make sure you are using the recommended thermal paper. See <i>Loading the Thermal Paper</i> in Chapter 1.
Received images are distorted.	<ul style="list-style-type: none"> • Noise on the telephone line may cause distortion. Have the other party try sending the document again. • Make a copy or print a report on your fax machine. If the copy or report is also distorted, your fax machine may need service.
A received document or copy prints out in strips.	<ul style="list-style-type: none"> • Make sure the operation panel is completely closed (press down on both sides of the panel).
The quality of copies is poor and/or dark vertical lines appear.	<ul style="list-style-type: none"> • Any dirt or material on the scanning glass will cause spots to appear on copies and transmitted faxes. Clean the scanning glass as explained on page 65.
Reception/copying is interrupted.	<ul style="list-style-type: none"> • If reception or copying takes place continuously for a long time, the print head may overheat. Turn off the power and let it cool down.

Answering machine connection

Problem	Solution
<p>The answering machine connection does not operate properly.</p>	<ul style="list-style-type: none"> • Make sure your fax machine's reception mode is set to A.M. • Make sure your fax machine's TEL. LINE socket is connected to the wall socket. Make sure your fax machine's TEL. SET socket is connected to your answering machine's telephone line socket (not the answering machine's extension phone socket). • Make sure your answering machine's outgoing message is under 10 seconds. • Make sure that the Quiet Detect Time setting is set to three or four seconds (see page 51).

General problems

Problem	Solution
<p>Voice calls taken on an extension phone are interrupted by the fax.</p>	<ul style="list-style-type: none"> • The fax may interrupt during a voice call if the reception mode is set to A.M.. To prevent interruption on a tone dial extension phone, press any three keys on the extension phone after answering. (Note: Do not enter the code to activate fax reception.)
<p>No reception occurs when polling is attempted.</p>	<ul style="list-style-type: none"> • Make sure you have not run out of paper. • Make sure the transmitting machine is in automatic reception mode. • If the transmitting machine has polling security, make sure that your fax number has been entered both in your machine and in the transmitting machine.

Nothing appears in the display.	<ul style="list-style-type: none">• Make sure the power cord is properly plugged into a power outlet.• Connect another electrical appliance to the outlet to see if it has power.
The machine does not respond when you press any of its keys.	<ul style="list-style-type: none">• If a beep sound is not made when you press the keys, unplug the power cord and then plug it in again several seconds later.
Automatic document feeding does not work for transmission or copying.	<ul style="list-style-type: none">• Check the size and weight of the document (see <i>Transmittable Documents</i> on page 23).

Messages and Signals

Display messages

Note: If you have turned on the Caller ID function, see Caller ID in Chapter 7 for display messages related to Caller ID.

CHECK PAPER	The thermal paper is jammed or isn't loaded properly. Remove and reload the paper. (See the following section, <i>Clearing Paper Jams</i> .)
COVER OPEN	The operation panel is open. Close it.
DOCUMENT JAMMED	The original document is jammed. See the following section, <i>Clearing Paper Jams</i> .
FUNCTION MODE	The FUNCTION key has been pressed.
HOLD	The HOLD/SEARCH key has been pressed to put the other party on hold during a phone conversation. Press the HOLD/SEARCH key again to take the other party off hold.
LINE BUSY	This appears if you attempt to send a fax by automatic dialling and the line is busy or the receiving fax machine doesn't answer. Press the STOP key to clear the message.
LINE ERROR	Transmission or reception was not successful. Press the STOP key to clear the message and then try again. If the error persists, see <i>Line Error</i> on page 67.
MEMORY IS FULL (UX-41/61 and FO-51/71 GQ-56 only)	The memory is full. This may occur during fax reception if too much data is received before the pages can be printed out. If faxes have been received to memory because printing is not possible, resolve the problem so that printing can continue, see <i>Substitute Reception to Memory</i> on page 44.
NO DATA	This appears if you attempt to search for an auto-dial number when none have been stored.
NO # STORED	You have tried to dial or clear a Rapid Key or Speed Dial number that hasn't been programmed (a full number hasn't been assigned to it).

OFF HOOK	This appears if you forgot to replace the handset after using it to dial and send a fax. Replace the handset or press the STOP key to clear the message.
ON HOOK DIAL	The SPEAKER key has been pressed and the fax machine is waiting for you to dial.
OUT OF PAPER	You have run out of thermal paper. Load a new roll of thermal paper as explained in <i>Loading the Thermal Paper</i> in Chapter 1.
OVER HEAT	The print head has overheated. Operation can be continued after it cools.
PAPER JAMMED	The printing paper is jammed. See the following section, <i>Clearing Paper Jams</i> .
PRINT HEAD FAIL/ YOU NEED SERVICE (alternating messages)	The print head has failed and requires service.
READY TO SEND	A document has been loaded and the fax machine is waiting for you to begin faxing or copying.
RECALLING	This appears if you attempt to send a fax by automatic dialling and the line is busy or the receiving fax machine does not answer. Your fax machine will automatically reattempt the call. (See <i>Automatic redialling</i> on page 37.)

Audible signals

Continuous tone	3 seconds	Indicates the end of transmission, reception, or copying.
Intermittent tone (3 beeps)	5 seconds (1 second on, 1 second off)	Indicates incomplete transmission, reception, or copying.
Rapid intermittent tone	Continuous (0.7 seconds on, 0.3 seconds off)	Indicates that the handset is off hook.

Clearing Paper Jams

Clearing a jammed document

If the original document doesn't feed properly during transmission or copying,

or DOCUMENT JAMMED appears in the display, first try pressing



If the document doesn't feed out, remove it as explained below.

Important:

Do not try to remove a jammed document without releasing it as explained below. This may damage the feeder mechanism.

- 1 Grasp the finger hold and pull up to open the operation panel.**



- 2 Flip up the green levers on each side of the white roller.**

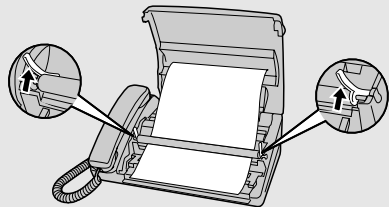

- 3 Remove the document.**

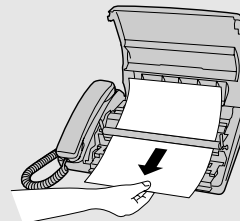

- 4** Flip down the green levers on each side of the white roller.

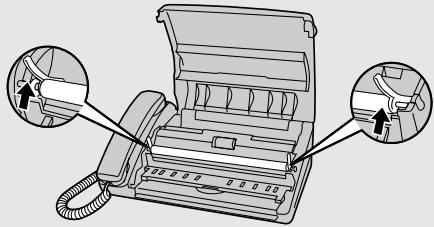

- 5** Close the operation panel, making sure it clicks into place.

- Press down on both front corners of the panel to make sure it clicks into place.

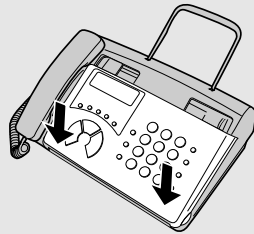

Clearing jammed printing paper

- 1** Grasp the finger hold and pull up to open the operation panel.



- 2** Flip up the front paper guide

UX-21
UX-41
FO-11
FO-51

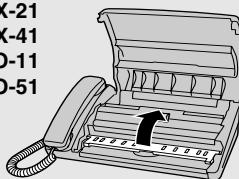

UX-61
FO-71
GQ-56

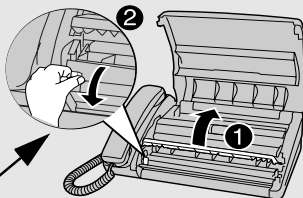

Press the knob to make sure the front side of the metal guide is down.

3 Remove the paper roll.

- **For UX-61/FO-71/GQ-56 only:**
Remove any cut pieces of paper from the paper compartment.

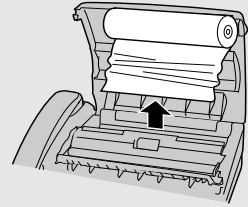

4 Cut off the wrinkled part of the paper.

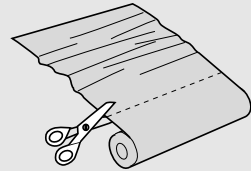

5 Reload the paper.

- Jammed paper is often caused by improper loading. Be sure to carefully follow the instructions for paper loading given in *Loading the Thermal Paper* in Chapter 1.

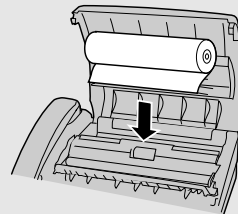

Quick Reference Guide

Sending Faxes

Place your document (up to 5 pages) face down in the document feeder.

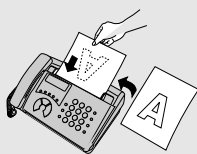

Normal Dialling

1. Lift the handset or press  .
2. Dial the fax number.
3. Wait for the reception tone (if a person answers, ask them to press their Start key).

4. Press  .

Rapid Key Dialling

Press the appropriate Rapid Key. Transmission will begin automatically.

Speed Dialling

1. Press  .
2. Enter 2-digit Speed Dial number.

2. Press  .

Direct Keypad Dialling

1. Dial the fax number.
2. Press  .

Receiving Faxes

Press the  until the arrow in the display points to the desired reception mode (make sure the document feeder is empty).

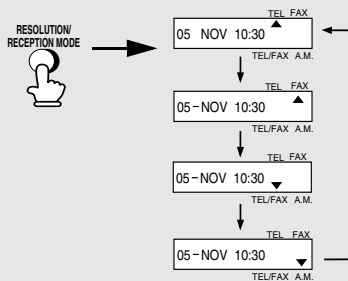

TEL mode: Answer all calls (even faxes) by picking up the handset. To begin fax reception, press  .

FAX mode: The fax machine automatically answers and receives faxes.

TEL/FAX mode: The fax machine automatically answers and receives faxes. Voice calls (including manually dialled fax transmissions) are signalled by a special ringing sound.

A.M. mode: Select this mode when an answering machine is connected to the fax and the answering machine is turned on.

Index

A

- A.M. reception mode, 20, 39, 49
- Answering machine connection
 - Activating, 49
 - Connecting, 48
 - On A.M. Failure, 53
 - Quiet Detect Start Time, 52
 - Quiet Detect Time, 51
 - Troubleshooting, 70
- Anti Junk Number List, 62
- Audible signals, 73
- Auto-dial numbers storing, 30

C

- Caller ID, 54-58
- Chain Dialling, 32, 47
- Contrast, 26
- Copies, 45

D

- Date, setting, 18
- Dial mode, 11
- Dialling
 - Chain, 32, 47
 - Direct Keypad, 35
 - Normal, 28, 46
 - Rapid Key, 33, 46
 - Speed, 34, 46
- Direct Keypad Dialling, 35
- Display messages, 72
- Document feeder, 24
- Document guides, 24
- Document restrictions, 24
- Document sizes, 23
- Document, maximum scanning size, 23

E

- Extension telephone
 - Connecting, 12
 - Using, 42

F

- FAX reception mode, 20, 39
- Fax Signal Receive, 43

H

- Half-tone setting, 26
- Handset, 9
- Hold, 47
- Housing, cleaning, 66

J

- Jams, clearing, 74-76

L

- Letters, entering, 17, 31
- Line error, 67
- Loading paper, 13-15
- Loading the document, 24

M

- Memory, substitute reception to, 44

N

- Normal Dialling, 28, 46
- Number of rings in FAX reception mode, 40

P

- Paper jams, clearing, 74-76
- Paper, thermal, 13-15
- Power cord, 10
- Priority Call, 57

R

- Rapid Key Dialling, 33, 46
- Reception mode
 - A.M. mode, 20, 39, 49
 - FAX mode, 20, 39

- TEL mode, 20, 41
- TEL/FAX mode, 20, 38
- Redialling, 47
- Removing original document, 25
- Resolution, 26
- Ringer volume, 22

S

- Scanning glass, cleaning, 65
- Search Dial, 36, 47
- Sender's name and number, entering, 16-17
- Speaker volume, 21
- Speed Dialling, 34, 46

T

- TEL reception mode, 20, 41
- TEL. LINE socket, 11
- TEL. SET socket, 12, 48
- TEL/FAX reception mode, 20, 38
- Tel/Fax Remote Number, 44
- Telephone line cord, 11
- Telephone Number List, 62
- Thermal paper, 13-15
- Time, setting, 18
- Transaction Report, 63-64

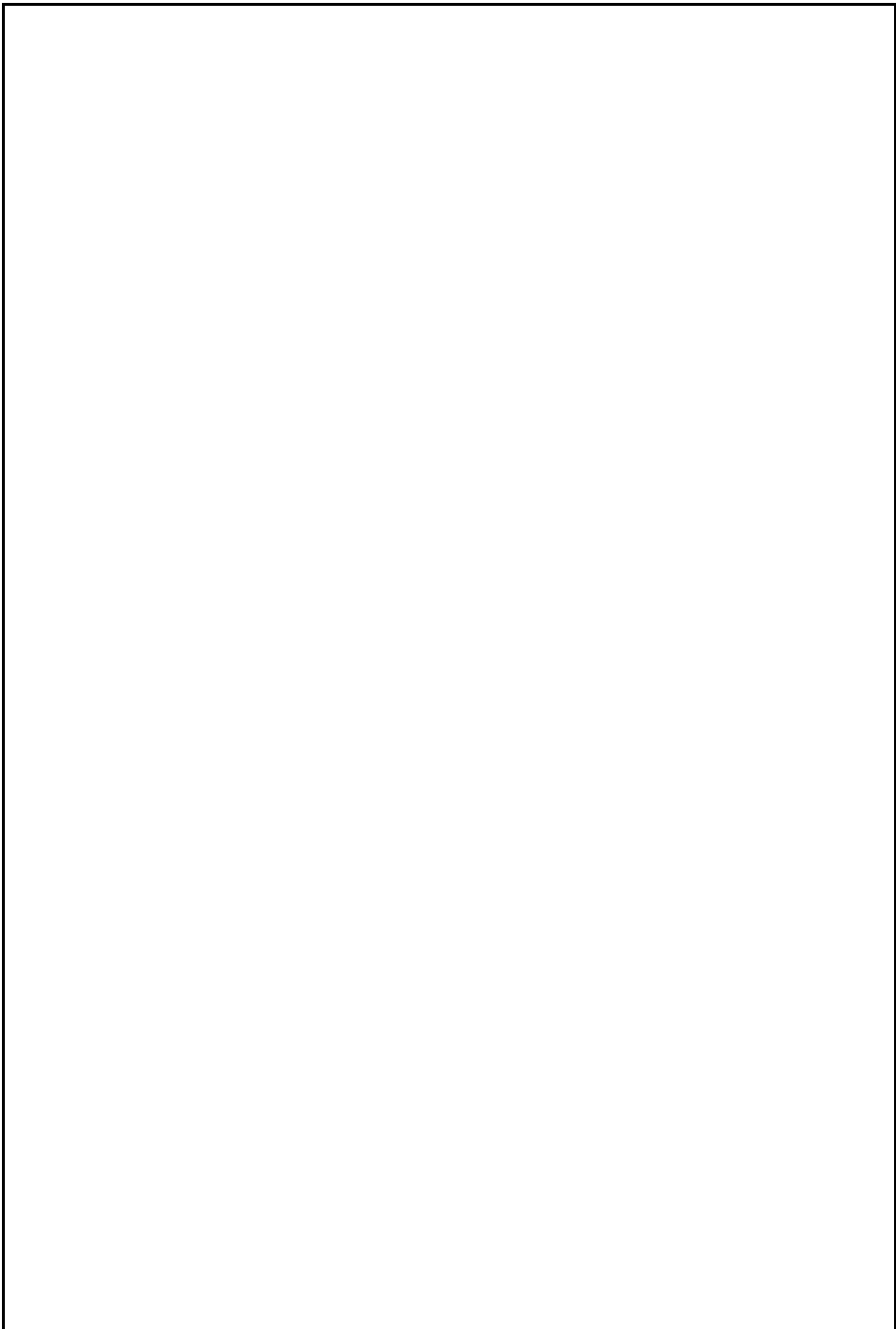

SHARP CORPORATION

PRINTED IN THAILAND
(TINSE4374XHTA)

Free Manuals Download Website

<http://myh66.com>

<http://usermanuals.us>

<http://www.somanuals.com>

<http://www.4manuals.cc>

<http://www.manual-lib.com>

<http://www.404manual.com>

<http://www.luxmanual.com>

<http://aubethermostatmanual.com>

Golf course search by state

<http://golfingnear.com>

Email search by domain

<http://emailbydomain.com>

Auto manuals search

<http://auto.somanuals.com>

TV manuals search

<http://tv.somanuals.com>