

# SHARP®

## LC-22GA3M LC-22GA3X

LCD COLOUR TELEVISION

液晶顯示彩色電視機  
液晶显示彩色电视机

# AQUOS

OPERATION MANUAL

使用說明書  
使用说明书



MICRONAS  
VOICE

VIRTUAL  
DOLBY  
SURROUND  
PRO LOGIC II



Printed on 100% post-consumer recycled paper.  
本說明用紙使用的是100%的再生紙。  
本說明用紙使用的是100%的再生紙。

Printed in Japan  
日本印刷  
日本印刷  
TINS-B558WJZZ®  
04P10-JKM

ENGLISH

中文 (繁體)

中文 (簡體)

# LC-22GA3M LC-22GA3X

## LCD COLOUR TELEVISION ENGLISH

### OPERATION MANUAL

## Contents

<b>Dear SHARP Customer .....</b>	<b>2</b>	<b>Useful Features .....</b>	<b>19</b>
<b>Important Safety Precautions .....</b>	<b>2</b>	Sound Adjustments .....	19
<b>Trademarks .....</b>	<b>3</b>	SPEECH EMPHASIS .....	19
<b>Supplied Accessories .....</b>	<b>4</b>	DOLBY VIRTUAL .....	19
<b>Preparation .....</b>	<b>5</b>	WSS (Wide Screen Signalling) .....	20
Installing Batteries in the Remote Control .....	5	4:3 MODE .....	20
Using Remote Control .....	5	DISPLAY MODE .....	20
Power Connection .....	6	AV3 IN/OUT .....	21
Antenna Connection .....	6	On-Screen Display Language Setting .....	21
Listening with Headphones .....	6	BACKLIGHT .....	21
<b>Part Names of Main Unit .....</b>	<b>7</b>	WIDE MODE .....	22
How to fix the cables .....	8	V-POSITION (Vertical Position) .....	22
<b>Part Names of Remote Control .....</b>	<b>9</b>	TIMER FUNCTIONS .....	23
<b>Basic Operation .....</b>	<b>10</b>	AUTO POWER OFF .....	23
Turning On and Off the Main Power .....	10	NO OPERATION OFF .....	23
Standby .....	10	BLUE BACK .....	23
Switching the TV/VIDEO Modes (AV1/AV2/AV3/ COMPONENT/TV) .....	10	<b>NICAM Broadcast Selection .....</b>	<b>24</b>
Sound Volume .....	11	<b>A2 Stereo Broadcast Selection .....</b>	<b>25</b>
Changing Channels .....	11	<b>Teletext .....</b>	<b>26</b>
<b>Preset .....</b>	<b>12</b>	<b>Connecting with External Devices .....</b>	<b>28</b>
On-Screen Display Language Selection .....	12	Example of External Devices that can be Connected .....	28
Presetting the Channels (AUTO) .....	12	Connecting a VCR, DVD Player or a Camcorder (COMPONENT/AV-IN1/2/3) .....	29
Presetting the Channels (MANUAL) .....	13	Outputting Video and Audio (Video Output) .....	29
Channel Setting (AUTO) .....	14	<b>Troubleshooting .....</b>	<b>30</b>
Channel Setting (MANUAL) .....	14	<b>Specifications .....</b>	<b>31</b>
CLOCK SETUP .....	14	<b>Dimensional Drawings .....</b>	<b>32</b>
<b>Selecting Menu Items .....</b>	<b>15</b>		
<b>Basic Adjustment Settings .....</b>	<b>16</b>		
BOOSTER .....	16		
AV MODE .....	16		
Picture Adjustments .....	16		
COLOUR SYSTEM (AV1, AV2 or AV3 Mode) .....	17		
Colour Temperature .....	17		
I/P SETUP .....	18		
DNR (Digital Noise Reduction) .....	18		
FILM MODE .....	18		
QUICK SHOOT .....	18		

# Dear SHARP Customer

---

Thank you for your purchase of the SHARP LCD colour TV product. To ensure safety and many years of trouble-free operation of your product, please read the Important Safety Precautions carefully before using this product.

## Important Safety Precautions

---

Electricity is used to perform many useful functions, but it can also cause personal injuries and property damage if improperly handled. This product has been engineered and manufactured with the highest priority on safety. However, improper use can result in electric shock and/or fire. In order to prevent potential danger, please observe the following instructions when installing, operating and cleaning the product. To ensure your safety and prolong the service life of your LCD colour TV product, please read the following precautions carefully before using the product.

1. Read instructions—All operating instructions must be read and understood before the product is operated.
2. Keep this manual in a safe place—These safety and operating instructions must be kept in a safe place for future reference.
3. Observe warnings—All warnings on the product and in the instructions must be observed closely.
4. Follow instructions—All operating instructions must be followed.
5. Attachments—Do not use attachments not recommended by the manufacturer. Use of inadequate attachments can result in accidents.
6. Power source—This product must operate on a power source specified on the specification label. If you are not sure of the type of power supply used in your home, consult your dealer or local power company.
7. AC cord protection—The AC cords must be routed properly to prevent people from stepping on them or objects from resting on them. Check the cords at the plugs and product.
8. Overloading—Do not overload AC outlets or extension cords. Overloading can cause fire or electric shock.
9. Entering of objects and liquids—Never insert an object into the product through vents or openings. High voltage flows in the product, and inserting an object can cause electric shock and/or short internal parts. For the same reason, do not spill water or liquid on the product.
10. Servicing—Do not attempt to service the product yourself. Removing covers can expose you to high voltage and other dangerous conditions. Request a qualified service person to perform servicing.
11. Repair—If any of the following conditions occurs, unplug the AC cord from the AC outlet, and request a qualified service person to perform repairs.
  - a. When the AC cord or plug is damaged.
  - b. When a liquid was spilled on the product or when objects have fallen into the product.
  - c. When the product has been exposed to rain or water.
  - d. When the product does not operate properly as described in the operating instructions.  
Do not touch the controls other than those described in the operating instructions. Improper adjustment of controls not described in the instructions can cause damage, which often requires extensive adjustment work by a qualified technician.
  - e. When the product has been dropped or damaged.
  - f. When the product displays an abnormal condition. Any noticeable abnormality in the product indicates that the product needs servicing.
12. Replacement parts—In case the product needs replacement parts, make sure that the service person uses replacement parts specified by the manufacturer, or those with the same characteristics and performance as the original parts. Use of unauthorized parts can result in fire, electric shock and/or other danger.
13. Safety checks—Upon completion of service or repair work, request the service technician to perform safety checks to ensure that the product is in proper operating condition.
14. Wall or ceiling mounting—When mounting the product on a wall or ceiling, be sure to install the product according to the method recommended by the manufacturer.

## Important Safety Precautions (Continued)

- **Cleaning**—Unplug the AC cord from the AC outlet before cleaning the product. Use a damp cloth to clean the product. Do not use liquid cleaners or aerosol cleaners.

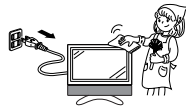

- The LCD panel used in this product is made of glass. Therefore, it can break when the product is dropped or applied with impact. Be careful not to be injured by broken glass pieces in case the LCD panel breaks.

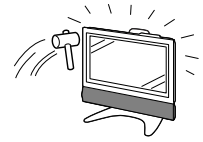

- **Water and moisture**—Do not use the product near water, such as bathtub, washbasin, kitchen sink, laundry tub, swimming pool and in a wet basement.



- **Heat sources**—Keep the product away from heat sources such as radiators, heaters, stoves and other heat-generating products (including amplifiers).



- **Stand**—Do not place the product on an unstable cart, stand, tripod or table. Doing so can cause the product to fall, resulting in serious personal injuries as well as damage to the product. Use only a cart, stand, tripod, bracket or table recommended by the manufacturer or sold with the product. When mounting the product on a wall, be sure to follow the manufacturer's instructions. Use only the mounting hardware recommended by the manufacturer.

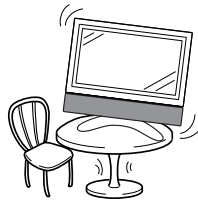

- Do not place vases or any other water-filled containers on this product. The water may spill onto the product causing fire or electric shock.

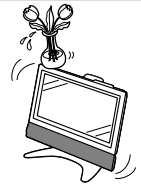

- To prevent fire, never place any type of candle or naked flames on the top or near the TV set.

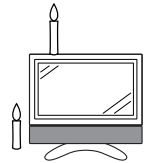

- When relocating the product placed on a cart, it must be moved with utmost care. Sudden stops, excessive force and uneven floor surface can cause the product to fall from the cart.



- To prevent fire or shock hazard, do not place the AC power cord under the TV set or other heavy items.

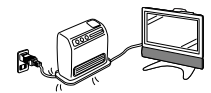

- **Ventilation**—The vents and other openings in the cabinet are designed for ventilation. Do not cover or block these vents and openings since insufficient ventilation can cause overheating and/or shorten the life of the product. Do not place the product on a bed, sofa, rug or other similar surface, since they can block ventilation openings. This product is not designed for built-in installation; do not place the product in an enclosed place such as a bookcase or rack, unless proper ventilation is provided or the manufacturer's instructions are followed.

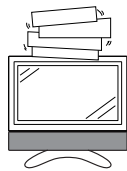

The LCD panel is a very high technology product with 1,229,760 thin film transistors, giving you fine picture details.

Due to the very large number of pixels, a few non-active pixels may occasionally appear on the screen as a fixed point of blue, green or red. This is within product specifications and does not constitute a fault.

Do not display a still picture for a long time, as this could cause an afterimage to remain.

## Trademarks

- Micronas® VOICE is a Speech Enhancement and Intelligibility Processing technology by Micronas GmbH.
- Micronas is a trademark of Micronas GmbH.

- Manufactured under license from Dolby Laboratories.
- "Dolby", "Pro Logic" and the double-D symbol are trademarks of Dolby Laboratories.

# Supplied Accessories

Make sure the following accessories are provided with the LCD TV set.

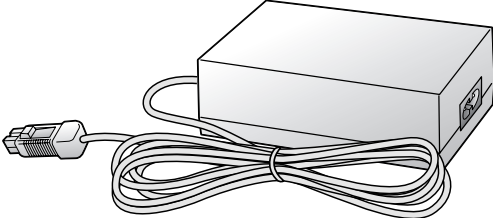
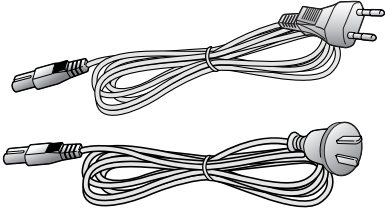
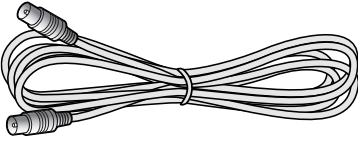
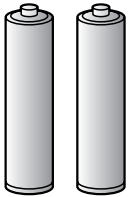
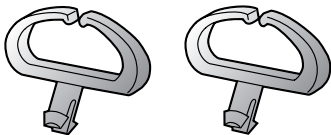
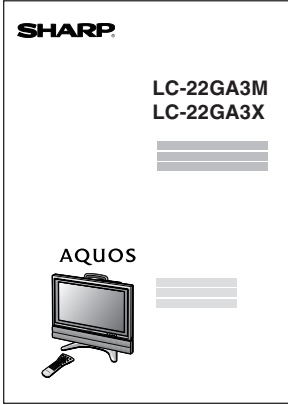
Remote control		AC adapter	
			
pages 5 and 9		page 6	
AC cord		Antenna cable	
			
*Product shape varies in some countries. page 6		page 6	
"AAA" size batteries (×2)	Cable clamps (×2)	Operation manual	
			
page 5	page 8		

# Preparation

## Installing Batteries in the Remote Control

Before using the LCD TV set for the first time, install the two "AAA" size batteries supplied in the remote control. When the batteries become depleted and the remote control fails to operate, replace the batteries with new "AAA" size batteries.

**1** Open the battery cover.

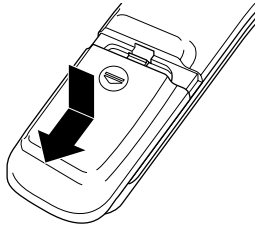

■ Slide the cover while pressing the (▼) part.

**2** Insert two "AAA" size batteries.

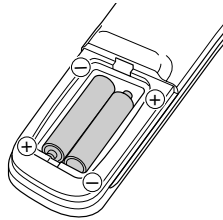

■ Place batteries with their terminals corresponding to the (+) and (-) indications in the battery compartment.

**3** Close the battery cover.

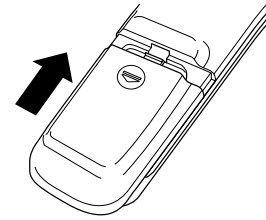

■ Engaging the lower claw with the remote control, close the cover.

### ⚠ Caution!

#### Precautions regarding batteries

- Improper use of batteries can result in a leakage of chemicals and/or explosion. Be sure to follow the instructions below.
  - Place batteries with their terminals corresponding to the (+) and (-) indications.
  - Different types of batteries have different characteristics. Do not mix batteries of different types.
  - Do not mix old and new batteries. Mixing old and new batteries can shorten the life of new batteries and/or cause old batteries to leak chemicals.
  - Remove batteries as soon as they are depleted. Chemicals that leak from batteries can cause a rash. If chemical leakage is found, wipe it off with a cloth.
  - The batteries supplied with the LCD TV set may have a shorter operating time due to storage conditions.
  - If the remote control is not to be used for an extended period of time, remove the batteries from the remote control.

## Using Remote Control

- Use the remote control by pointing it towards the remote sensor window of the main unit. Objects between the remote control and sensor window may prevent proper operation.

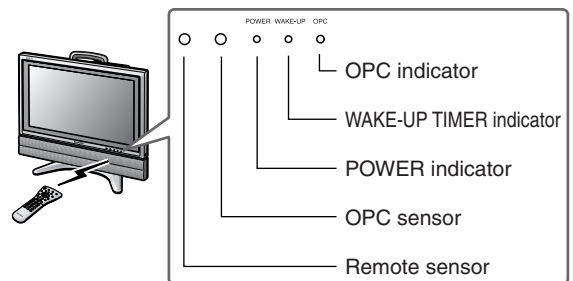

#### Cautions regarding use of remote control

- Do not apply shock to the remote control. In addition, do not expose the remote control to liquids, and do not place it in an area with high humidity.
- Do not install or place the remote control under direct sunlight. The heat may cause deformation of the unit.
- The remote control may not work properly if the remote sensor window is under direct sunlight or strong lighting. In such a case, change the angle of the lighting or main unit, or operate the remote control closer to the remote sensor window.

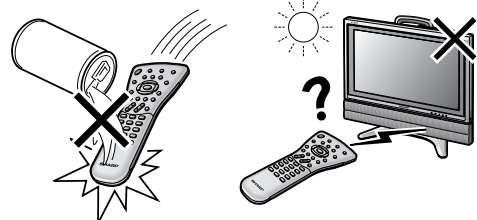

## Preparation (Continued)

### Power Connection

Connect to the DC input terminal of the LCD TV set.

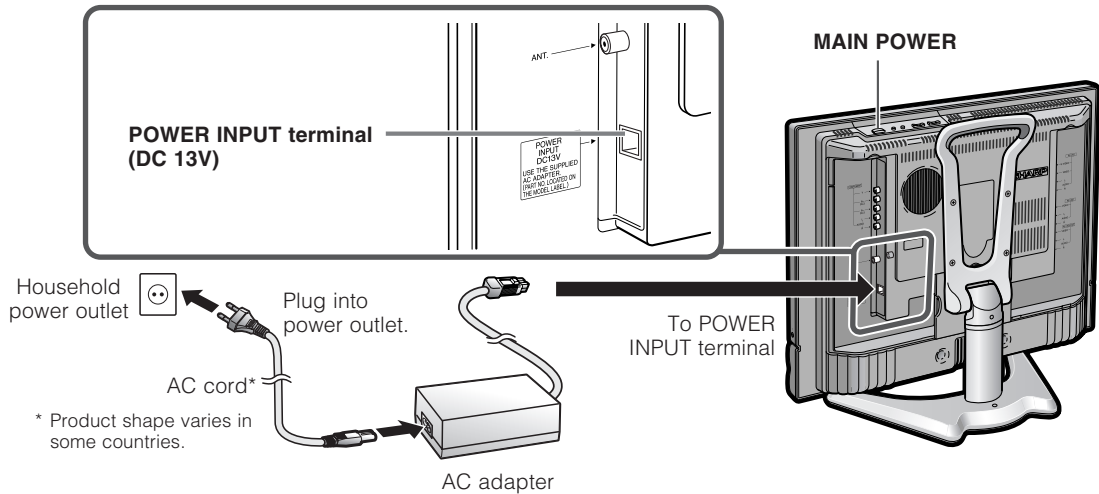

#### ■ Using the AC adapter

- Although the AC adapter may become warm during use, this is not a malfunction.
- Do not wrap or cover the AC adapter with a blanket or similar covering. This can cause a malfunction or accident.
- Do not attempt to disassemble or modify the AC adapter. The insides of the AC adapter contain high-voltage components that can result in the risk of electrical shock.

#### NOTE

- Use a commercially available AC plug adapter, if necessary, depending on the design of the wall outlet.
- Always turn the **MAIN POWER** switch of the LCD TV set to OFF when connecting the AC adapter.
- Unplug the AC adapter from the LCD TV set and power outlet when the LCD TV set is not to be used for a long period of time.

### Antenna Connection

- Using the supplied antenna cable, connect the room antenna terminal to the antenna terminal on the LCD TV set. (Refer to the figure below.)

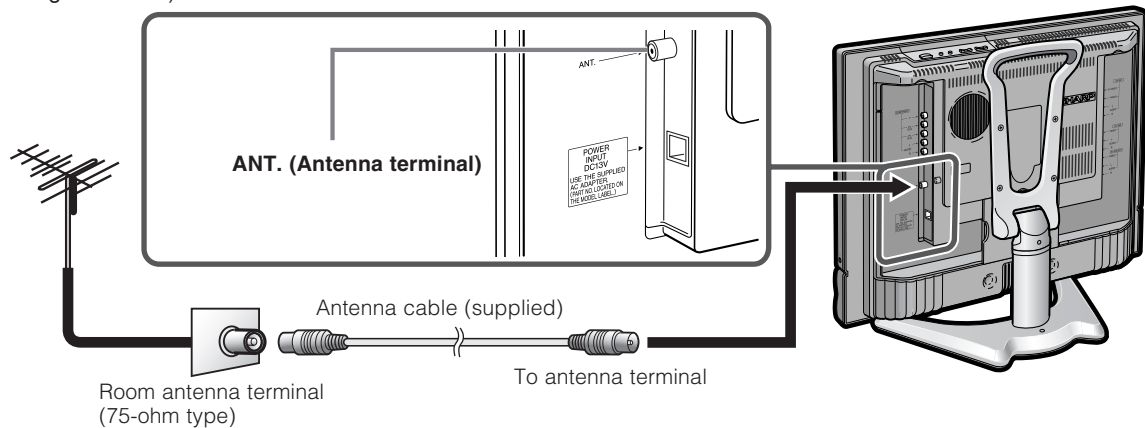

### Listening with Headphones

- Plug the headphone mini-plug into the headphone jack located on the side of the LCD TV set.

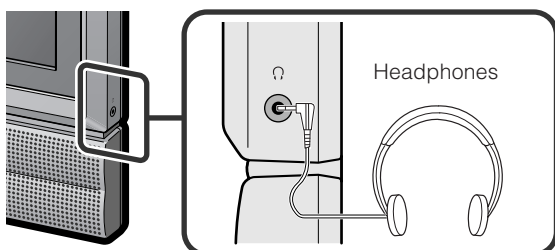

#### NOTE

- Headphones are not included in the supplied accessories.
- No sound is heard from the main unit speakers when a headphone mini-plug is connected into the headphone jack.

#### ▼ On-screen display

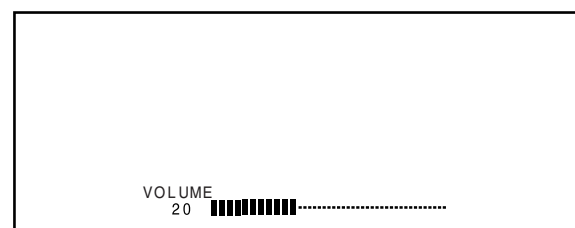

# Part Names of Main Unit

## Controls

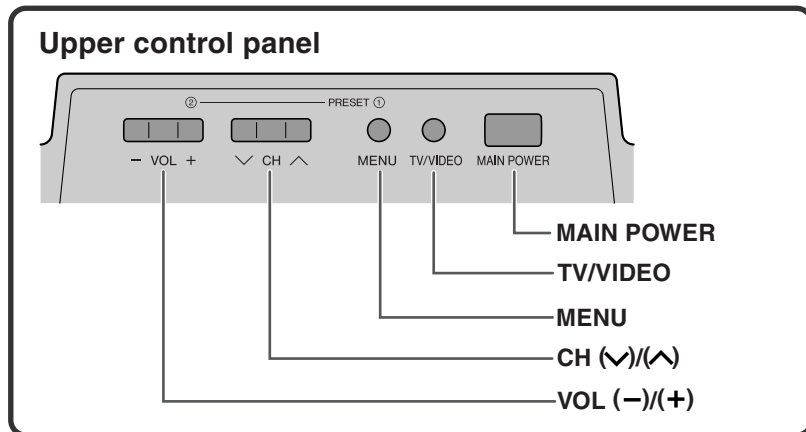

## How to adjust the angle

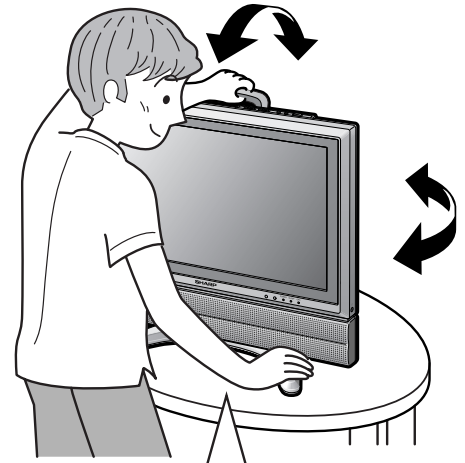

Tilt the display by grabbing onto the carrying handle while securely holding down the stand with your other hand.

To change the vertical angle of the LCD TV set, tilt the screen up to 5 degrees forward or 10 degrees backward. The LCD TV set can also be rotated up to 25 degrees to right and left. Please adjust the angle so that the LCD TV set can be watched most comfortably.

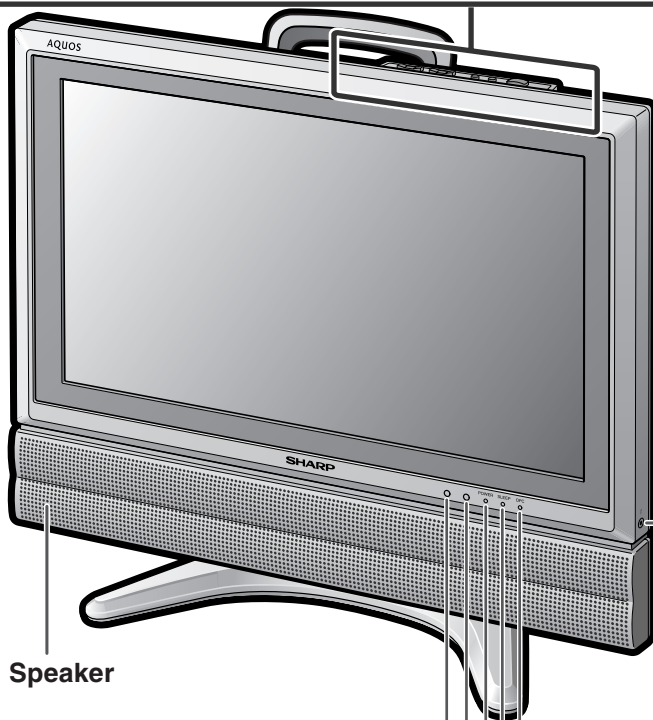

### Ⓜ (Headphone jack)

Plug the headphone mini-plug into the headphone jack located on the side of the LCD TV set. (See page 6.)

### Remote sensor

### OPC sensor

### OPC indicator (Optical Picture Control)

The Optical Picture Control indicator lights up green when the "BACKLIGHT" is set to "AUTO (OPC)". (See page 21.)

### WAKE-UP TIMER indicator

The WAKE-UP TIMER indicator lights up red when the wake-up timer is set.

### POWER indicator

The POWER indicator lights up green when the power is on, and red when in the standby mode (the indicator will not light when the main power is off).

## NOTE

- **TV/VIDEO**, **CH (V)/(^)**, **VOL (-)/(+)** and **MENU** on the main unit have the same functions as the same buttons on the remote control. Fundamentally, this operation manual provides a description based on operation using the remote control.



# Part Names of Main Unit (Continued)

## Terminals

Rear View

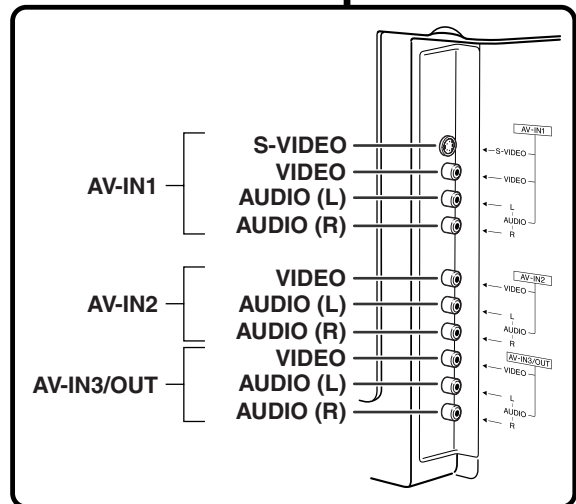
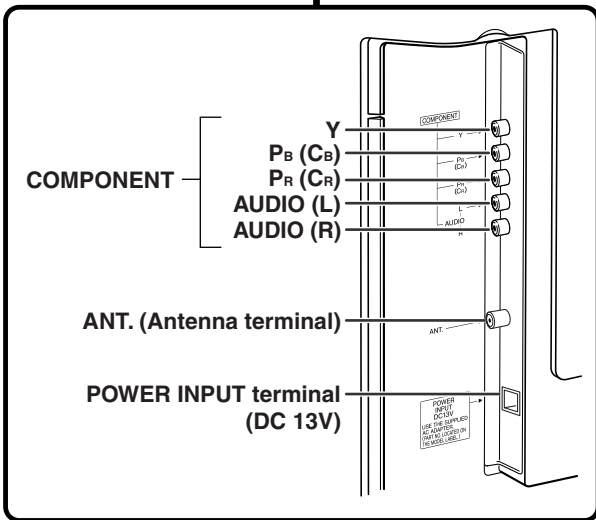
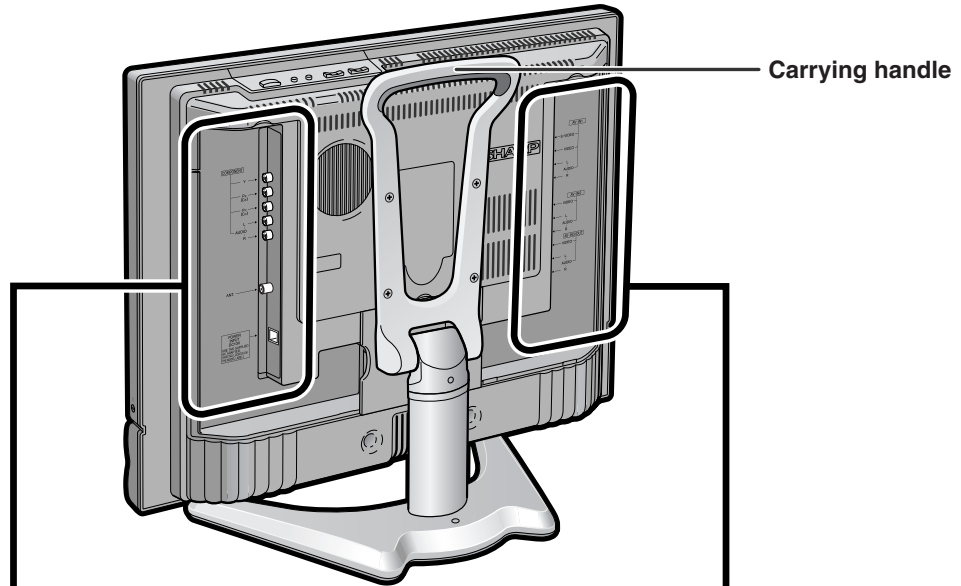

### How to fix the cables

- Secure cables and cords with the supplied cable clamps so that they do not get caught when mounting the cover.

Pull down the hook to open the cover.

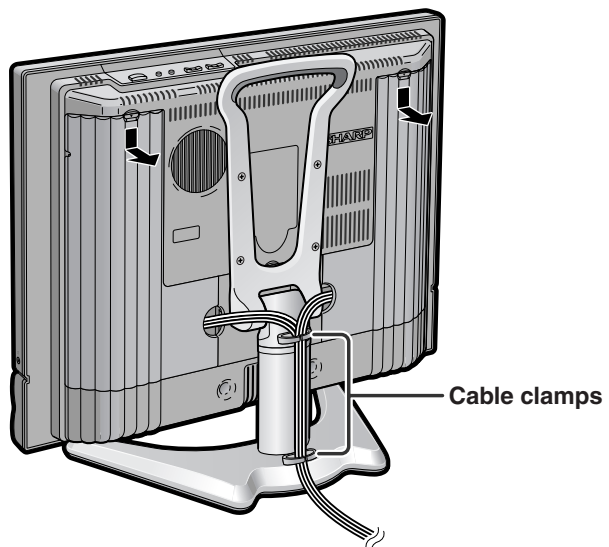

# Part Names of Remote Control

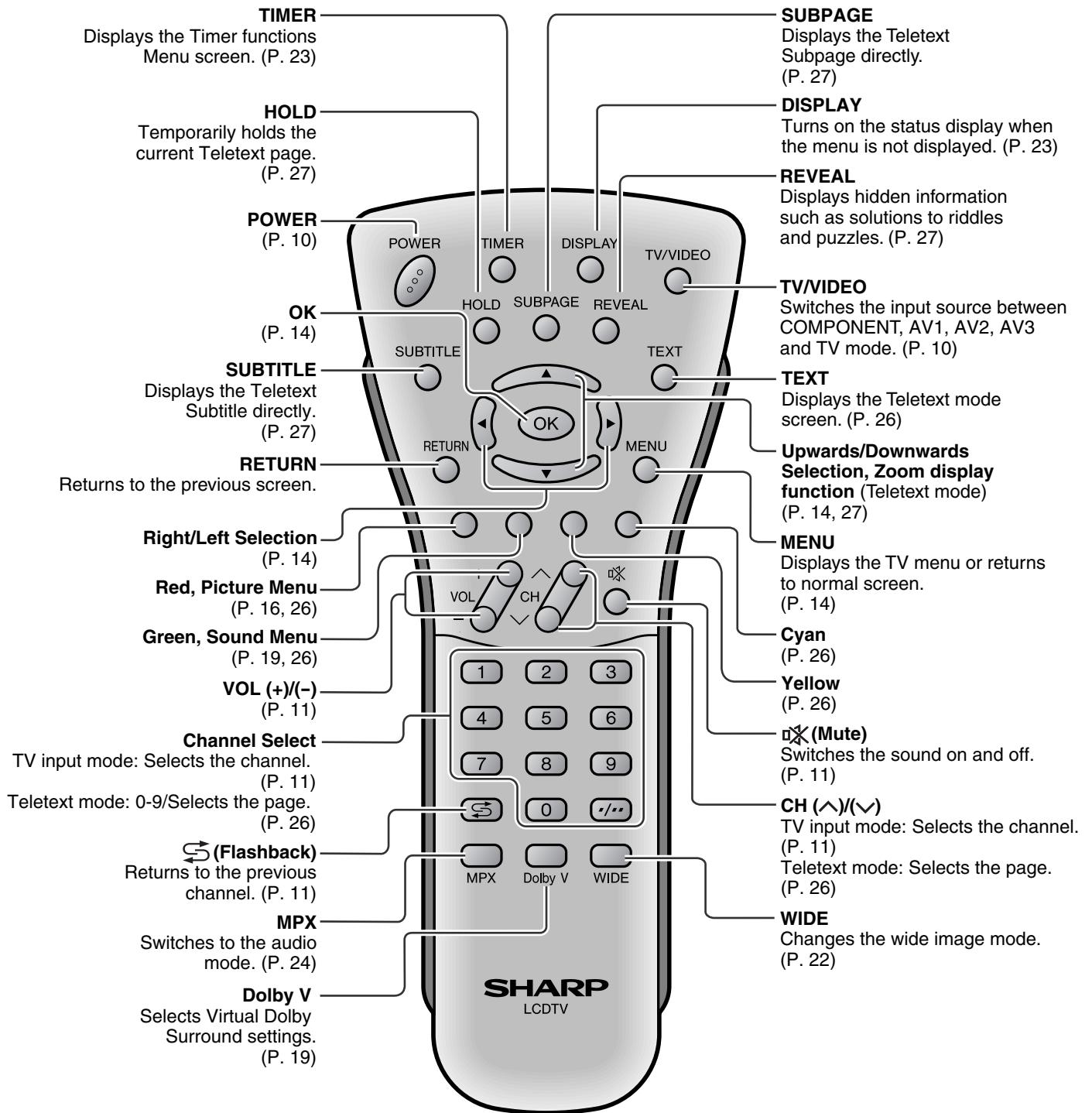

# Basic Operation

## Turning On and Off the Main Power

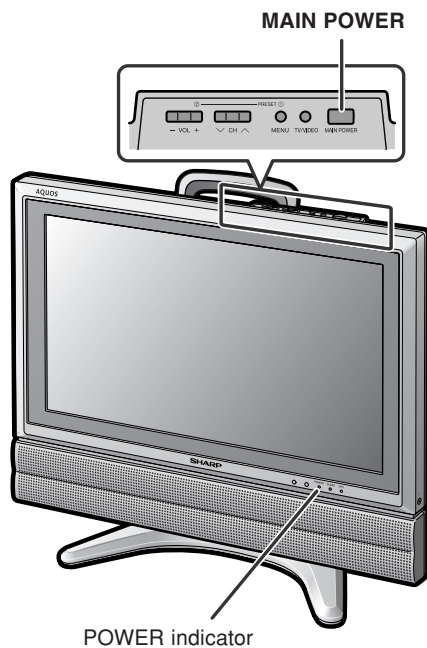

- Press **MAIN POWER**. The POWER indicator instantly changes from red to green and the LCD TV set is turned on.

### On-screen display



### NOTE

- The on-screen display disappears after a few seconds.

- To turn off the main power, press **MAIN POWER** again.

## Standby

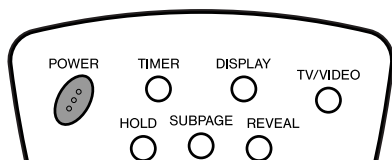

### To turn off the LCD TV

Press **POWER**. The POWER indicator will turn red.

### To turn the LCD TV back on

Press **POWER** again. The POWER indicator will turn green.

## Switching the TV/VIDEO Modes (AV1/AV2/AV3/COMPONENT/TV)

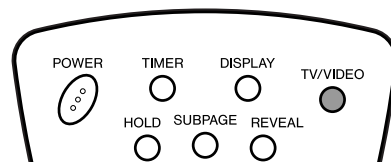

- 1 Turn on the power of the connected video equipment.
- 2 Press **TV/VIDEO** to select the applicable input source. The screen changes in order of COMPONENT, AV1, AV2, AV3 and TV mode each time **TV/VIDEO** is pressed.

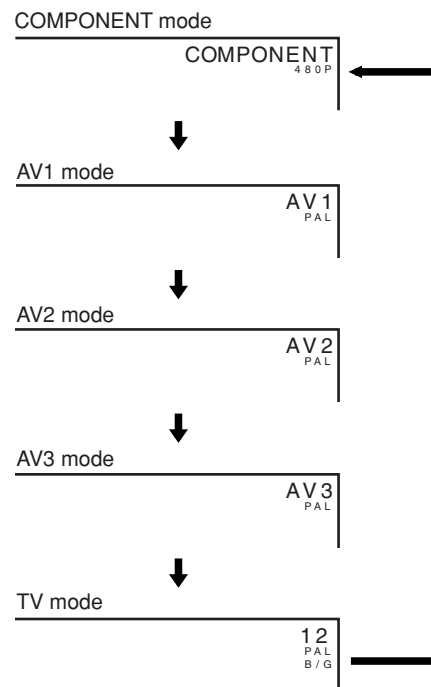

### NOTE

- **COMPONENT:** Select this mode when viewing the signals from the video equipment connected to the COMPONENT terminal.
- **AV1:** Select this mode when viewing the signals from the video equipment connected to the AV-IN1 terminal. The S-VIDEO terminal is additionally provided for the AV-IN1 terminal. If both S-VIDEO terminal and VIDEO terminal are connected with cables, the S-VIDEO terminal takes priority.
- **AV2:** Select this mode when viewing the signals from the video equipment connected to the AV-IN2 terminal.
- **AV3:** Select this mode when viewing the signals from the video equipment connected to the AV-IN3/OUT terminal. AV3 mode is used to adjust the preset settings and In or Out can be selected. AV3 indication is not displayed when Out is selected. (For details on setting "AV3 IN/OUT", see page 21.)

## Sound Volume

### ■ To adjust the volume

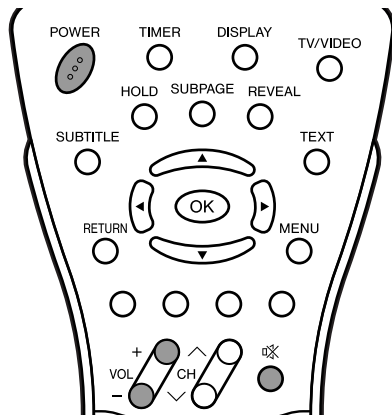

- Press **VOL (+)** to increase the sound volume. The numerical value increases.

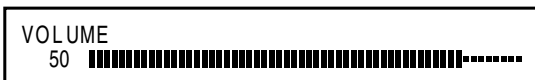

- Press **VOL (-)** to decrease the sound volume. The numerical value decreases.



### ■ To mute the sound

- Press **Mute** to temporarily turn off the sound. The MUTE mark is displayed on the screen.



- Press **Mute** or **VOL (+)/(-)** to turn the sound back to the previous level. MUTE is automatically cleared when one of the following buttons is pressed: **POWER**, **VOL (+)/(-)** or **Mute**.



## Changing Channels

You can select channels using **Channel Select** or **CH (^)/(v)**.

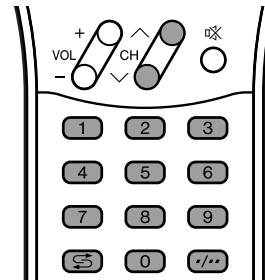

- To handle the increasing number of channels available, this LCD TV set allows you to select up to 100 positions (Channels 0 to 99). One-digit and two-digit methods of selection can be used. Follow the procedure shown below to select channels.

### ■ Using Channel Select

To select a one-digit channel (e.g., Channel 5):

- 1 Press **5** of **Channel Select**.
- 2 If "5-" is indicated and the picture does not change, press **-/-** to switch over to the 1-digit select mode and press **5** of **Channel Select**.



To select a two-digit channel (e.g., Channel 15):

- 1 Press **-/-** to set the 2-digit select mode.
- 2 Press **1** of **Channel Select**.
- 3 Press **5** of **Channel Select**.



#### NOTE

- Complete this procedure within 4 seconds, otherwise the selection will not be made.

### Changing channels with CH (^)/(v) on the remote control.

Press **CH (^)** and the channels change in the order shown below:  
 1 → 2 → 3 → ... → 98 → 99 → 0 → 1 → 2 → 3 → ...  
 Press **CH (v)** and the channels change in the order shown below:  
 3 → 2 → 1 → 0 → 99 → 98 → ... → 3 → 2 → 1 → ...

### ■ Using **Flashback**

- Press **Flashback** to switch the currently tuned channel to the previously tuned channel.
- Press **Flashback** again to switch back to the currently tuned channel.

# Preset

## On-Screen Display Language Selection

**MENU** on the LCD TV set can also be used to select the language.

### Upper control panel

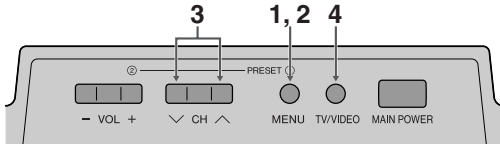

- 1 Press **MENU** (PRESET-①) on the upper part of the LCD TV set for more than 2 seconds to display the PRESET mode screen.



- 2 Press **MENU** (PRESET-①) twice to display the LANGUAGE select mode screen.
  - Press **MENU** (PRESET-①) again to change the PRESET mode as shown below.**AUTO → MANUAL → LANGUAGE → NORMAL SCREEN**

### NOTE

- Instead of pressing **MENU** for more than 2 seconds, you can set the language by selecting "LANGUAGE" in "SETUP" in the Menu screen. (See page 21.)



- 3 Press **CH** (∨)/(∧) to select the language you wish to display.
- 4 Press **TV/VIDEO** to return to the normal screen.

## Presetting the Channels (AUTO)

Automatically tunes in and presets receivable TV stations. Make sure the antenna cable is properly connected.

### Upper control panel

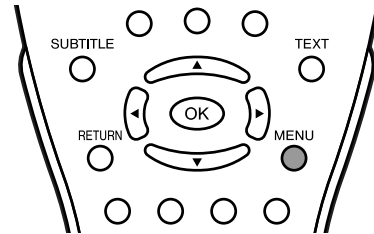
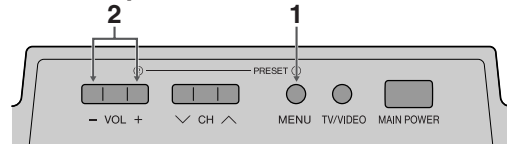

- 1 Press **MENU** (PRESET-①) on the upper part of the LCD TV set for more than 2 seconds to display the AUTO mode screen.

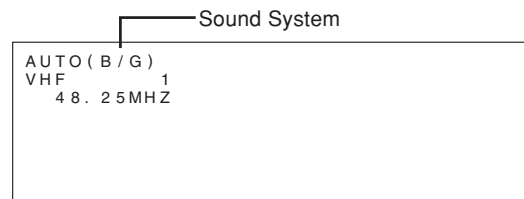

- 2 Press **VOL (-)/(+)** (PRESET-②) on the upper part of the LCD TV set. All the TV stations in your area that can be received by the LCD TV set are automatically preset.

- 3 The screen shows whatever is on channel 1 when full auto channel preset is finished.



### NOTE

- When starting PRESET after setting "SOUND SYSTEM" with **MENU** on the remote control, "SOUND SYSTEM" for all channels are stored into memory.
- Unused channels are automatically skipped.
- The Preset mode is only available in the TV mode.
- Instead of pressing **MENU** for more than 2 seconds, you can set the channel by selecting "CH SETUP" in "SETUP" in the Menu screen. (See page 14.)

## Presetting the Channels (MANUAL)

### ■ Setting a channel to a desired TV station

#### Upper control panel

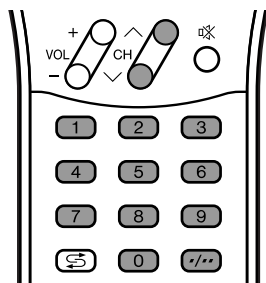
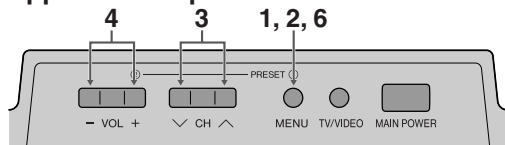

- 1 Press **MENU** (PRESET-①) on the upper part of the LCD TV set for more than 2 seconds to display the AUTO mode screen.

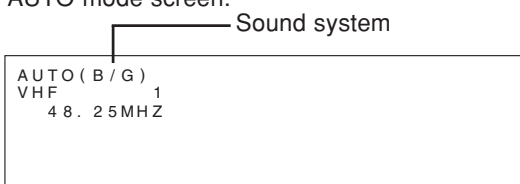

- 2 Press **MENU** (PRESET-①) to display the MANUAL mode screen.
  - Press **MENU** (PRESET-①) again to change the MANUAL mode as shown below.**AUTO → MANUAL → LANGUAGE → NORMAL SCREEN**

- 3 Select the channel position using **Channel Select** or **CH (▲)/(▼)**.

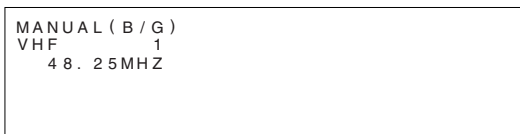

- 4 Press **VOL (-)/(+)** to locate the channel you want to preset to the position. Search is initiated and when a TV signal is received during the search, the search stops.

- 5 Repeat steps 3 and 4 above, to preset the channel positions for other broadcasts, etc.



- 6 Press **MENU** (PRESET-①) twice to return to the normal screen.

#### NOTE

- System may not have been set correctly, if noise can be heard or if there is no sound. In such a case, adjust "SOUND SYSTEM". (See page 14.)

### ■ In a weak reception area or under bad reception conditions

#### Upper control panel

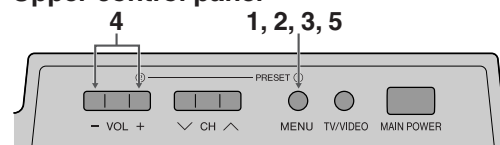

- 1 Press **MENU** (PRESET-①) on the upper part of the LCD TV set for more than 2 seconds to display the AUTO mode screen.
- 2 Press **MENU** (PRESET-①) to display the MANUAL mode screen.
- 3 While the MANUAL mode screen is displayed, press **MENU** (PRESET-①) for more than 2 seconds. The channel position number remains in green.
- 4 Adjust for good reception using **VOL (-)/(+)**.
- 5 After finishing the adjustment, press **MENU** (PRESET-①) to continue channel presetting.

#### NOTE

- While the MANUAL mode screen is displayed, press **MENU** (PRESET-①). (The LANGUAGE mode screen will appear.)

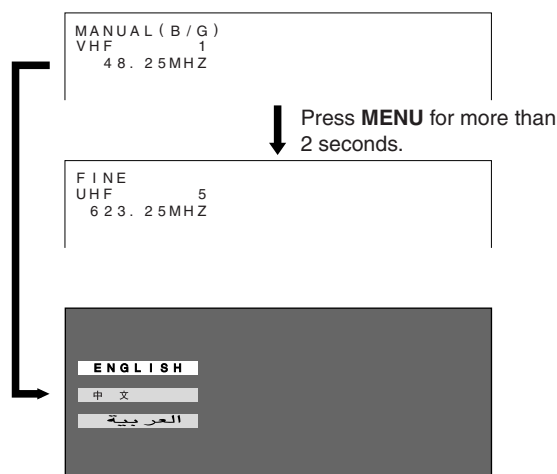

## Preset (Continued)

### Channel Setting (AUTO)

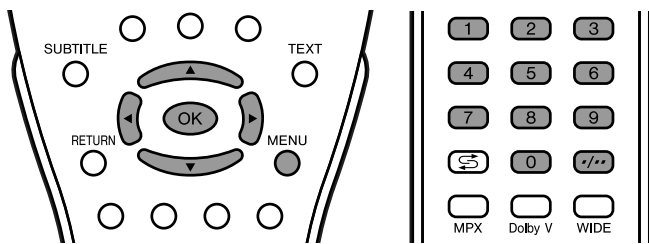

- 1 Press **MENU** to display the Menu screen.
- 2 Press **◀▶** to select "SETUP".
- 3 Press **▲▼** to select "CH SETUP", and press **OK**.
- 4 Press **▲▼** to select "AUTO", and press **OK**.
- 5 Press **▲▼** to select "SOUND SYSTEM". Each time you press **◀▶**, the setting for individual items changes as shown in the table on the right.

SOUND SYSTEM ◀ B / G ▶  
START SEARCH

- 6 Press **▲▼** to select "START SEARCH", and press **OK** to begin the automatic programme search.
- 7 When the automatic programme search is completed, the channel first received will be displayed.

### Channel Setting (MANUAL)

- 1 Perform steps 1 and 2 in **Channel Setting (AUTO)** to display the Setup Menu screen.
- 2 Press **▲▼** to select "CH SETUP", and press **OK**.
- 3 Press **▲▼** to select "MANUAL", and press **OK**.
- 4 Press **▲▼** to select the desired adjustment item.

POSITION ◀ CH 1 ▶  
COLOUR SYSTEM AUTO  
SOUND SYSTEM B / G  
SKIP OFF  
FINE 871.10 MHz  
NICAM OFF  
A2 OFF

- 5 Each time you press **◀▶**, the setting for individual items changes as shown in the table on the right.
- 6 Press **MENU** to exit.

Selected item	Description
POSITION	The channel position changes to the upper or lower number.
COLOUR SYSTEM	The mode changes in the following order: AUTO ↔ PAL ↔ SECAM PAL60 ↔ N443 ↔ N358
SOUND SYSTEM	The mode changes in the following order: B/G ↔ D/K ↔ M
SKIP	The mode changes in the following order: ON ↔ OFF Channel numbers with a "● (RED)" mark on the left are set to Skip. To turn off Skip, press <b>Channel Select</b> to select the desired channel, and then set the Skip mode on the CH setup menu to "OFF".
FINE	The frequency changes to allow fine tuning.
NICAM	The broadcast sound system changes in the following order: ON (NICAM sound) ↔ OFF (Monaural TV sound)
A2	Stereo system changes in the following order: ON (A2 sound) ↔ OFF (Monaural TV sound)

#### NOTE

- Switching Colour system:  
Set the system to Auto for normal TV reception. The Auto mode automatically detects the receiving signal system and changes the reception system of the LCD TV set. When the picture or sound is not stable, switching to an appropriate system may improve the picture or sound quality.
- When using Fine tuning, the channel number changes from green to yellow.
- To return the channel to its original frequency setting, follow the manual channel preset procedure. (For details "Presetting the Channels (MANUAL)", see page 13.)

### CLOCK SETUP

The Timer functions that turn power on at the specified time do not work unless the clock has been adjusted. Be sure to adjust the clock first.

- 1 Perform steps 1 and 2 in **Channel Setting (AUTO)** to display the Setup Menu screen.
- 2 Press **▲▼** to select "CLOCK SETUP", and press **OK**.
- 3 Press **▲▼** to set the time, and press **OK**.  
• Holding down **▲▼** changes the setting at a high speed.
- 4 Press **MENU** to exit.

00:00:00

# Selecting Menu Items

## ■ Menu setting screens

For details on setting each menu item, refer to the page number indicated below.

### NOTE

- The illustrations and on-screen displays in this manual are for explanation purposes and may vary slightly from the actual appearance.
- Depending on the setting condition, such as an input mode, it may not be possible to adjust or set some items. In such cases, the alert message is displayed on the menu setting screen.

### PICTURE

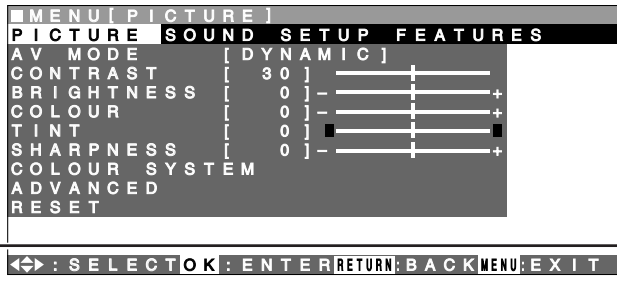

The bar above is an operational guide for the remote control. The bar will change in accordance with each menu setting screen.

	Page
AV MODE .....	16
CONTRAST .....	16
BRIGHTNESS .....	16
COLOUR .....	16
TINT .....	16
SHARPNESS .....	16
COLOUR SYSTEM .....	17
ADVANCED .....	17, 18
RESET .....	16

### SOUND

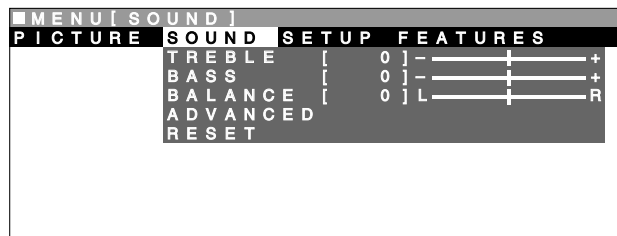

	Page
TREBLE .....	19
BASS .....	19
BALANCE .....	19
ADVANCED .....	19
RESET .....	19

### SETUP

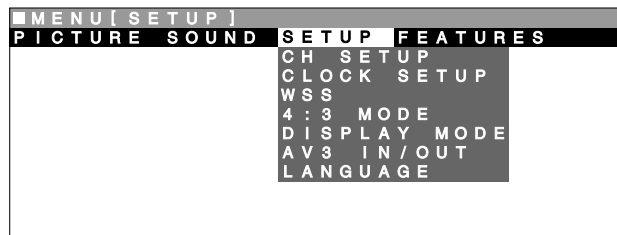

	Page
CH SETUP .....	14, 24, 25
CLOCK SETUP .....	14
WSS .....	20
4:3 MODE .....	20
DISPLAY MODE .....	20
AV3 IN/OUT .....	21
LANGUAGE .....	21

### FEATURES

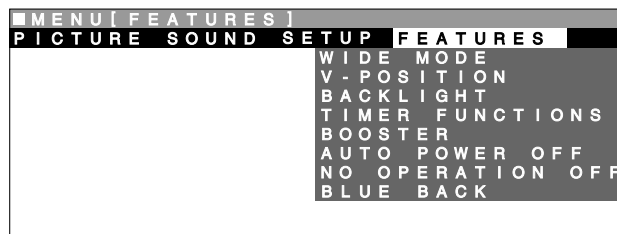

	Page
WIDE MODE .....	22
V-POSITION .....	22
BACKLIGHT .....	21
TIMER FUNCTIONS .....	23
BOOSTER .....	16
AUTO POWER OFF .....	23
NO OPERATION OFF .....	23
BLUE BACK .....	23





## COLOUR SYSTEM (AV1, AV2 or AV3 Mode)

Set the system to "AUTO" for normal reception. The "AUTO" mode automatically detects the receiving signal system and changes the reception system of the set. When the picture or sound is not stable, switching to an appropriate system may improve the picture or sound quality.

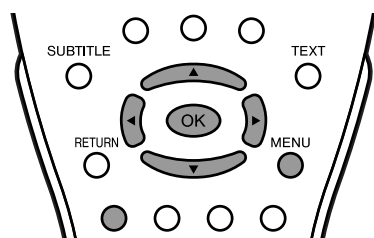

- 1 Press **MENU** to display the Menu screen.
  - The Picture Menu screen can be displayed directly by pressing **Red**.
- 2 Press **◀▶** to select "PICTURE".
- 3 Press **▲▼** to select "COLOUR SYSTEM", and press **OK**.
- 4 Press **▲▼/◀▶** to select "AUTO", "PAL", "SECAM", "N358", "N443" or "PAL60" and press **OK**.

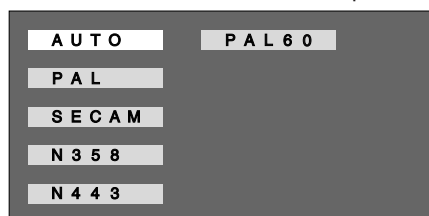

- 5 Press **MENU** to exit.

### NOTE

- "COLOUR SYSTEM" is available only in the AV mode.

## Colour Temperature

Adjust the colour temperature to give a better white balance.

- 1 Press **MENU** to display the Menu screen.
  - The Picture Menu screen can be displayed directly by pressing **Red**.
- 2 Press **◀▶** to select "PICTURE".
- 3 Press **▲▼** to select "ADVANCED", and press **OK**.
- 4 Press **▲▼** to select "COLOUR TEMP.", and press **OK**.

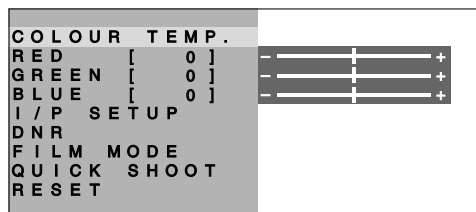

- 5 Press **▲▼** to select the desired item, and press **OK**.

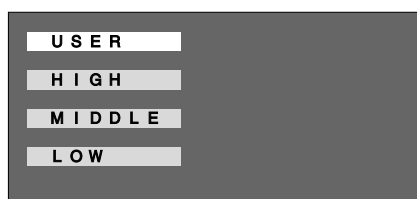

- 6 Press **MENU** to exit.

Selected item	Description
USER	Can set your desired colour*
HIGH	White with Bluish tone
MIDDLE	↓
LOW	White with Reddish tone

\* When you select "USER", the following items are adjustable.

Selected item	Press ◀	Press ▶
RED	Weaker red ← →+	Stronger red
GREEN	Weaker green ← →+	Stronger green
BLUE	Weaker blue ← →+	Stronger blue

### NOTE

- When resetting "RED", "GREEN" and "BLUE" to factory preset values, perform the following procedure.
  - ① Press **▲▼** to select "RESET" in the "ADVANCED" menu, and press **OK**.
  - ② Press **▲▼** to select "YES", and press **OK**.

## Basic Adjustment Settings (Continued)

### I/P SETUP

Adjusting the image and input signal can give you a more beautiful picture.

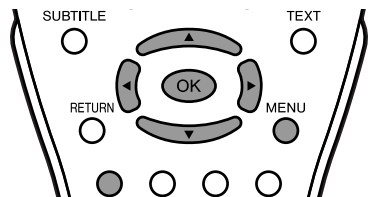

- 1 Press **MENU** to display the Menu screen.
  - The Picture Menu screen can be displayed directly by pressing **Red**.
- 2 Press **◀▶** to select "PICTURE".
- 3 Press **▲▼** to select "ADVANCED", and press **OK**.
- 4 Press **▲▼** to select "I/P SETUP", and press **OK**.

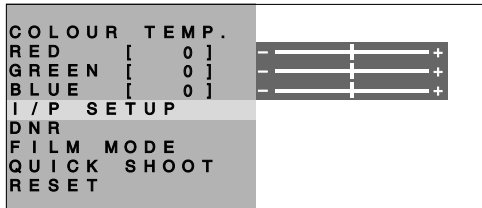

- 5 Press **▲▼** to select "INTERLACE" or "PROGRESSIVE", and press **OK**.



- 6 Press **MENU** to exit.

Selected item	Description
INTERLACE	Use this setting when you cannot get a clear picture with Progressive. (Especially suitable for media with special effects like game software.)
PROGRESSIVE	Normally, you should select this setting.

#### NOTE

- "I/P SETUP" cannot be set when 480P, 576P, 720P or 1080I signal is received from the COMPONENT terminals.

### DNR (Digital Noise Reduction)

DNR (Digital Noise Reduction) provides high quality images with minimal dot crawl and cross colour noise.

- 1 Perform steps 1 to 3 in **I/P SETUP** to display the "ADVANCED" screen.
- 2 Press **▲▼** to select "DNR", and press **OK**.
- 3 Press **▲▼** to select "ON", and press **OK**.



- 4 Press **MENU** to exit.

#### NOTE

- "DNR" cannot be set to "ON" when 720P or 1080I signal is received from the COMPONENT terminals.

### FILM MODE

Automatically detects a film-based source (originally encoded at 24 frames/second), analyses it, and then recreates each still film frame for high-definition picture quality.

- 1 Perform steps 1 to 3 in **I/P SETUP** to display the "ADVANCED" screen.
- 2 Press **▲▼** to select "FILM MODE", and press **OK**.
- 3 Press **▲▼** to select "ON", and press **OK**.



- 4 Press **MENU** to exit.

#### NOTE

- Set "FILM MODE" to "ON" manually to detect a film-based source (originally encoded at 24 frames/second) when the input source has vertical frequency of 60 Hz (e.g. NTSC, PAL60).
- "FILM MODE" cannot be set to "ON" when 480P, 576I, 576P, 720P or 1080I signal is received from the COMPONENT terminals.
- Film mode does not work when the input source has vertical frequency of 50 Hz (e.g. PAL, SECAM).

### QUICK SHOOT

Provides sharp pictures suitable for fast moving images such as a sports programme.

- 1 Perform steps 1 to 3 in **I/P SETUP** to display the "ADVANCED" screen.
- 2 Press **▲▼** to select "QUICK SHOOT", and press **OK**.
- 3 Press **▲▼** to select "ON", and press **OK**.



- 4 Press **MENU** to exit.

#### NOTE

- "QUICK SHOOT" may cause image noise. If this occurs, set the function to "OFF".

# Useful Features

## Sound Adjustments

You can adjust the sound quality to your preference with the following settings.

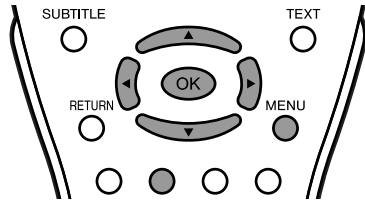

**1** Press **MENU** to display the Menu screen.  
• The Sound Menu screen can be displayed directly by pressing **Green**.

**2** Press **◀▶** to select "SOUND".

**3** Press **▲▼** to select a specific adjustment item.

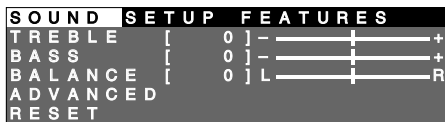

**4** Press **◀▶** to adjust the item to your desired position.

**5** Press **MENU** to exit.

Selected item	◀ button	▶ button
TREBLE	For weaker treble	For stronger treble
BASS	For weaker bass	For stronger bass
BALANCE	Increase the volume of the left speaker	Increase the volume of the right speaker

### NOTE

- Select "ADVANCED" and press **OK** to set "SPEECH EMPHASIS" or "DOLBY VIRTUAL". See this page.
- When "OUT ❷" is selected in "AV3 IN/OUT", you cannot adjust sound settings.
- When resetting all adjustment items (except for the items on the "ADVANCED" menu) to factory preset values, perform the following procedure.
  - ① Press **▲▼** to select "RESET", and press **OK**.
  - ② Press **▲▼** to select "YES", and press **OK**.

## SPEECH EMPHASIS

Micronas® VOICE, Speech Enhancement and Intelligibility Processing technology by Micronas GmbH, has the following features:

- Increases the speech signal over background noise to increase intelligibility.
- Separates voice from the background and moves it to the foreground: Voices are moved closer to the listener, while other sounds are moved to the back.
- Improves voices that are hard to understand, but leaves clear voices undisturbed.

**1** Perform steps 1 and 2 in **Sound Adjustments** to display the Sound Menu screen.

**2** Press **▲▼** to select "ADVANCED", and press **OK**.

**3** Press **▲▼** to select "SPEECH EMPHASIS", and press **OK**.



**4** Press **▲▼** to select "ON", and press **OK**.



**5** Press **MENU** to exit.

### NOTE

- "SPEECH EMPHASIS" cannot be set when "AV3 IN/OUT" is set to "OUT ❷".
- "SPEECH EMPHASIS" cannot be set when the headphone mini-plug is plugged into headphone jack.
- Speech emphasis does not work when sound is output from the headphones.

## DOLBY VIRTUAL

You can enjoy the Surround 2ch stereo with Dolby Pro Logic II technology.

Virtual Dolby Surround is a technology certified by Dolby Laboratories that creates a virtualised surround sound experience from two speakers using Dolby Pro Logic or Dolby Pro Logic II.

Virtual Dolby Surround retains all the original multichannel audio information and provides the listener with the sensation of being surrounded by additional speakers.

**1** Perform steps 1 and 2 in **Sound Adjustments** to display the Sound Menu screen.

**2** Press **▲▼** to select "ADVANCED", and press **OK**.

**3** Press **▲▼** to select "DOLBY VIRTUAL", and press **OK**.



**4** Press **▲▼** to select "ON", and press **OK**.



**5** Press **MENU** to exit.

### NOTE

- "DOLBY VIRTUAL" cannot be set when "AV3 IN/OUT" is set to "OUT ❷".
- "DOLBY VIRTUAL" cannot be set when the headphone mini-plug is plugged into headphone jack.
- Virtual Dolby Surround does not work when sound is output from the headphones.
- When "ON" is selected in "DOLBY VIRTUAL", you cannot adjust "BALANCE".
- For some discs, setup may be required on your DVD. In this case, please refer to the operation manual of your DVD player.

### ■ Directly setting the Virtual Dolby Surround

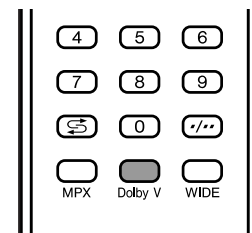

Press **Dolby V** to display the Dolby Virtual screen.

- Each time you press **Dolby V**, the mode changes as follows. You can select the desired mode.



## Useful Features (Continued)

### WSS (Wide Screen Signalling)

WSS allows a television to switch automatically among the different screen formats.

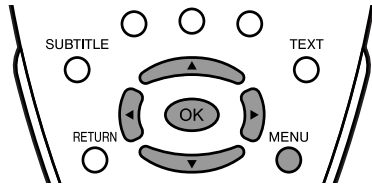

- 1 Press **MENU** to display the Menu screen.
- 2 Press **◀▶** to select "SETUP".
- 3 Press **▲▼** to select "WSS", and press **OK**.
- 4 Press **▲▼** to select "ON" or "OFF", and press **OK**.



- 5 Press **MENU** to exit.

#### NOTE

- If an image does not switch to the correct screen format, try to set "WIDE MODE" in "FEATURES". When the broadcast signal contains no WSS information, the function will not work even if enabled.
- WSS information refers to the original wide mode information sent from the broadcasting station.

### 4:3 MODE

The WSS signal has 4:3 auto-switching that allows you to select between Normal and Panorama.

- 1 Press **MENU** to display the Menu screen.
- 2 Press **◀▶** to select "SETUP".
- 3 Press **▲▼** to select "4:3 MODE", and press **OK**.
- 4 Press **▲▼** to select "NORMAL" or "PANORAMA", and press **OK**.



- 5 Press **MENU** to exit.

Selected item	Description
NORMAL	Normal range keeping 4:3 or 16:9 aspect ratio.
PANORAMA	Wide image without side bars.

#### WSS signal 4:3 screen

4:3 mode "NORMAL"



4:3 mode "PANORAMA"



### DISPLAY MODE

You can set the orientation of the picture.

- 1 Press **MENU** to display the Menu screen.
- 2 Press **◀▶** to select "SETUP".
- 3 Press **▲▼** to select "DISPLAY MODE", and press **OK**.
- 4 Press **▲▼** to select the desired mode, and press **OK**.

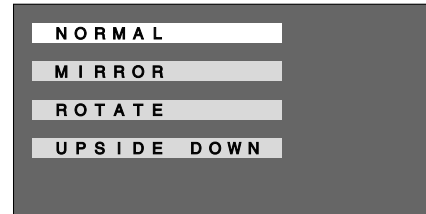

- 5 Press **MENU** to exit.

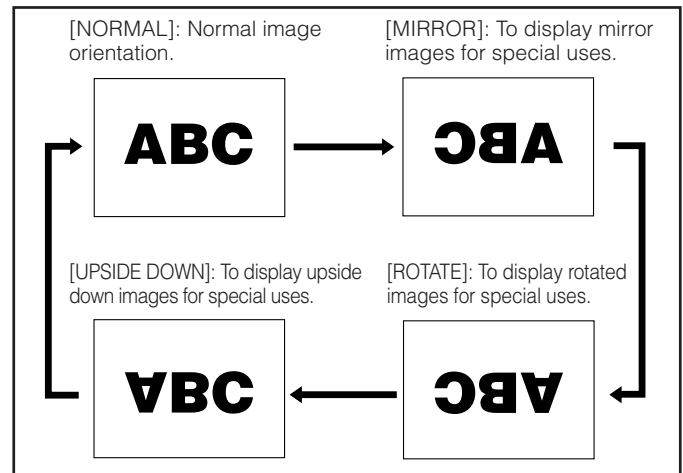

## AV3 IN/OUT

You can select the AV-IN3/OUT terminal as input terminals or output terminals.

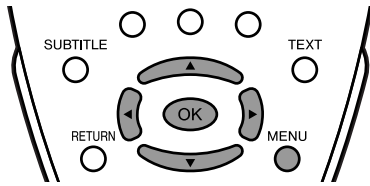

- 1 Press **MENU** to display the Menu screen.
- 2 Press **◀▶** to select "SETUP".
- 3 Press **▲▼** to select "AV3 IN/OUT", and press **OK**.
- 4 Press **▲▼** to select the desired mode, and press **OK**.

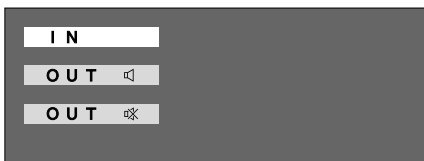

- 5 Press **MENU** to exit.

AV3 IN/OUT	[IN] AV-IN3/OUT terminals selected as input terminals.	[OUT ] Line output is selected, output volume is fixed and speaker output is available.
		[OUT ] Line output is selected, output volume is variable and speaker output is set to mute.

### NOTE

- "AV3 IN/OUT" cannot be set when "AV3" is selected as an input mode or "AV3" is selected in "CHANNEL" of "WAKE-UP TIMER" in "TIMER FUNCTIONS".

## On-Screen Display Language Setting

You can select English, Chinese or Arabic as the on-screen display language.

- 1 Press **MENU** to display the Menu screen.
- 2 Press **◀▶** to select "SETUP".
- 3 Press **▲▼** to select "LANGUAGE", and press **OK**.
- 4 Press **▲▼** to select the desired language, and press **OK**.



- 5 Press **MENU** to exit.

## BACKLIGHT

You can set the brightness of the screen on the LCD TV set.

- 1 Press **MENU** to display the Menu screen.
- 2 Press **◀▶** to select "FEATURES".
- 3 Press **▲▼** to select "BACKLIGHT", and press **OK**.
- 4 Press **▲▼** to select the desired mode, and press **OK**.

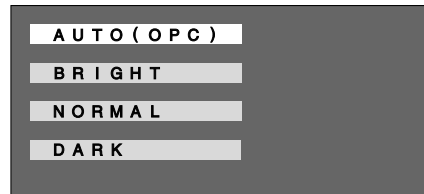

- 5 Press **MENU** to exit.

Selected item	Description
AUTO (OPC)	Screen brightness is adjusted according to the ambient light of the room.
BRIGHT	Maximum brightness.
NORMAL	Brightness 60%. Suitable for viewing in well-lit areas. Saves energy.
DARK	Brightness 20%. Sufficiently bright when viewing in dim areas.

# Useful Features (Continued)

## WIDE MODE

You can select the picture display size for the playback image of the DVD player.

### NOTE

- "WIDE MODE" cannot be set when 720P or 1080I signal is received from the COMPONENT terminals.

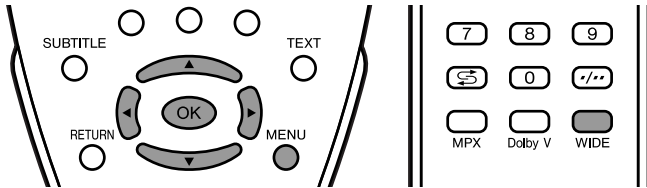

- 1 Press **MENU** to display the Menu screen.
- 2 Press **◀▶** to select "FEATURES".
- 3 Press **▲▼** to select "WIDE MODE", and press **OK**.
- 4 Press **▲▼/◀▶** to select the desired mode, and press **OK**.

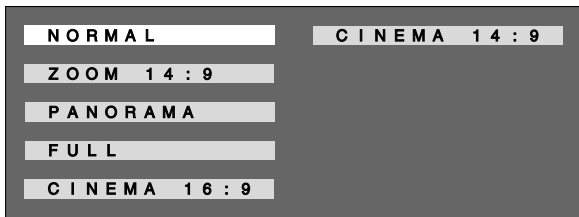

- 5 Press **MENU** to exit.

Selected item	Description
NORMAL	For 4:3 "standard" pictures. A side bar appears on each side.
ZOOM 14:9	For 14:9 letterbox pictures. A thin side bar appears on each side, and you may also see bars on the top and bottom with some programmes.
PANORAMA	In this mode the picture is progressively stretched toward each side of the screen.
FULL	For 16:9 squeeze pictures.
CINEMA 16:9	For 16:9 letterbox pictures. Bars may appear on the top and bottom with some programmes.
CINEMA 14:9	For 14:9 letterbox pictures. Bars may appear on the top and bottom with some programmes.

### Auto Selection

If you set "WSS" and "4:3 MODE", the optimum Wide mode is automatically chosen for every broadcast containing the WSS information.

### "WSS" menu

To enable Auto Selection, set "WSS" in the Setup Menu to "ON". (See page 20.)

### "4:3 MODE" menu

To set the type of the wide screen, select "NORMAL" or "PANORAMA" in the 4:3 Mode menu. (See page 20.)

4:3 mode set to "NORMAL"

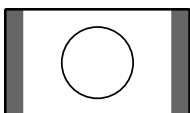

4:3 mode set to "PANORAMA"

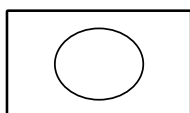

### NOTE

- If the broadcast signal contains no WSS information, Auto Selection will not function even when the WSS option is enabled.

### Directly setting the Wide mode

Press **WIDE** to display the Wide mode screen.

- Each time you press **WIDE**, the mode changes as follows.

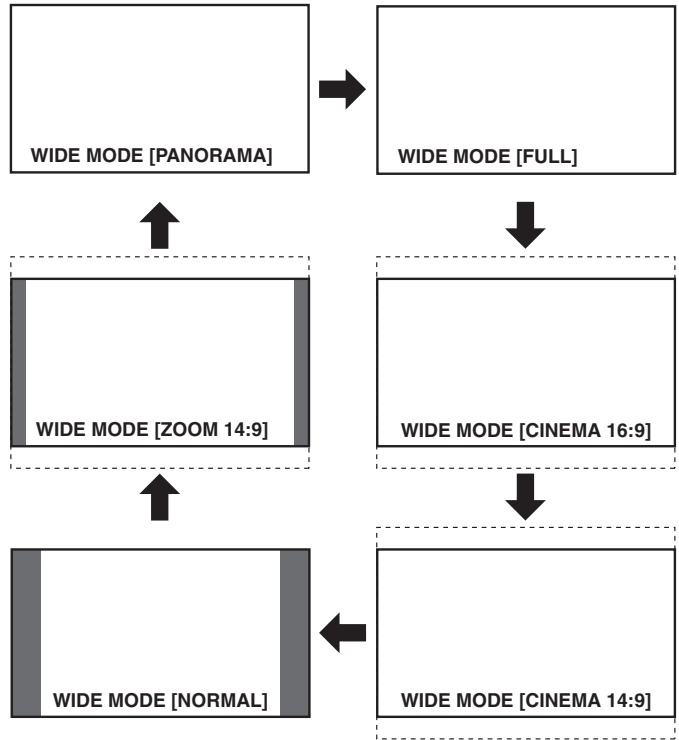

## V-POSITION (Vertical Position)

Adjusting a picture's vertical position.

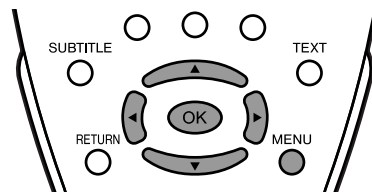

- 1 Press **MENU** to display the Menu screen.
- 2 Press **◀▶** to select "FEATURES".
- 3 Press **▲▼** to select "V-POSITION", and press **OK**.
- 4 Press **◀▶** to adjust the item to your desired position.
  - Centres the image by moving it up or down.
- 5 Press **MENU** to exit.



### NOTE

- You can adjust a different vertical position for each input mode (COMPONENT, AV1, AV2, AV3, and TV).

## TIMER FUNCTIONS

You can set "SLEEP TIMER" and "WAKE-UP TIMER" to automatically turn off and on the LCD TV set.

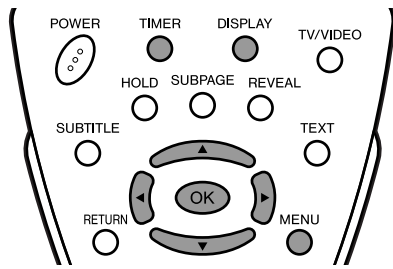

- 1 Press **MENU** to display the Menu screen.
- 2 Press **◀▶** to select "FEATURES".
- 3 Press **▲▼** to select "TIMER FUNCTIONS", and press **OK**.  
• The Timer functions Menu screen can be displayed directly by pressing **TIMER**.
- 4 Press **▲▼** to select "SLEEP TIMER", and press **OK**.
- 5 Press **▲▼/◀▶** to select "30MIN", "60MIN", "90MIN", "120MIN", "150MIN" or "OFF", and press **OK**.
- 6 Press **▲▼** to select "WAKE-UP TIMER", and press **OK**.
- 7 Press **▲▼** to select the desired adjustment item, and press **◀▶** to adjust them.
- 8 Press **MENU** to exit.

Selected item	Description
SET	To activate the Wake-up timer, set this item to "ON".
WAKE-UP TIME	Set the time at which you want to turn on the TV.
CHANNEL	Set the TV channel or input mode when the TV is turned on.
VOLUME	Set the volume when the TV is turned on.

### NOTE

- When you set "WAKE-UP TIMER", the WAKE-UP TIMER indicator lights up red.
- Be sure to adjust the clock with "CLOCK SETUP" in "SETUP" before setting "WAKE-UP TIMER".
- You can output the picture and sound of the external device with the "WAKE-UP TIMER" function. Make sure that the external device turns on at the time you specified.
- The "CHANNEL" setting for "WAKE-UP TIMER" changes in the following order: COMPONENT → AV1 → AV2 → AV3 → TV (0-99)\*. \* The skipped channels cannot be selected.
- When not using the LCD TV set for a long period of time, either turn off the main power or "WAKE-UP TIMER" set to "OFF".
- When "WAKE-UP TIMER" has been set to "ON", the LCD TV set is turned on at the set time every day until it is set to "OFF".
- Always make sure to turn off the power with the remote control. "WAKE-UP TIMER" will not be activated if the main power is turned off with **MAIN POWER** on the LCD TV set.
- After the TV has been turned on by "WAKE-UP TIMER", "SLEEP TIMER" is automatically set to "120MIN" for safety reason.

- You can check the time set in "WAKE-UP TIMER" by pressing **DISPLAY**.
- When the time set for the "WAKE-UP TIMER" is reached when the power is on, the LCD TV set changes to the set channel. The sound volume does not change at this time.
- "AV3" in "CHANNEL" is not displayed when "OUT ⓧ" is selected in "AV3 IN/OUT".

## AUTO POWER OFF

You can set the power to automatically turn off if there is no signal for 5 minutes.

- 1 Perform steps 1 and 2 in **TIMER FUNCTIONS** to display the Features Menu screen.
- 2 Press **▲▼** to select "AUTO POWER OFF", and press **OK**.
- 3 Press **▲▼** to select "ON", and press **OK**.
- 4 Press **MENU** to exit.

## NO OPERATION OFF

You can set the power to automatically shut down if there is no operation for 3 hours.

- 1 Perform steps 1 and 2 in **TIMER FUNCTIONS** to display the Features Menu screen.
- 2 Press **▲▼** to select "NO OPERATION OFF", and press **OK**.
- 3 Press **▲▼** to select "ON", and press **OK**.
- 4 Press **MENU** to exit.

## BLUE BACK

Automatically turns the screen blue if no broadcast signal is received.

- 1 Perform steps 1 and 2 in **TIMER FUNCTIONS** to display the Features Menu screen.
- 2 Press **▲▼** to select "BLUE BACK", and press **OK**.
- 3 Press **▲▼** to select "ON", and press **OK**.
- 4 Press **MENU** to exit.

### NOTE

- When received signals are weak or interfered with by some other signals, "BLUE BACK" may be activated. To watch the TV under such conditions, set "BLUE BACK" to "OFF".
- "BLUE BACK" is activated when AV1, AV2, AV3 or COMPONENT input mode is selected with no signal being input.



# NICAM Broadcast Selection

To let you enjoy NICAM broadcasting, this LCD TV set receives NICAM stereo system, bilingual, and monaural broadcasts.

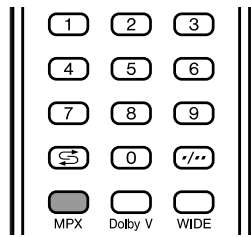

## Stereo

The LCD TV set is receiving a stereo broadcast.

- Each time you press **MPX**, the mode changes between "NICAM STEREO" and "MONO".
- When "MONO" is selected, the TV sound is output monaurally.

(When stereo sound is received)

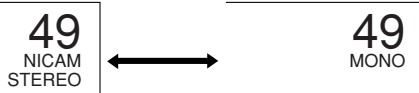

## Bilingual

The LCD TV set is receiving a bilingual broadcast.

- Pressing **MPX** changes the audio mode in the order shown below.
- M1=main sound, M2=sub sound, or MONO=monaural sound, can be selected.

(When main sound is selected)

(When sub sound is selected)

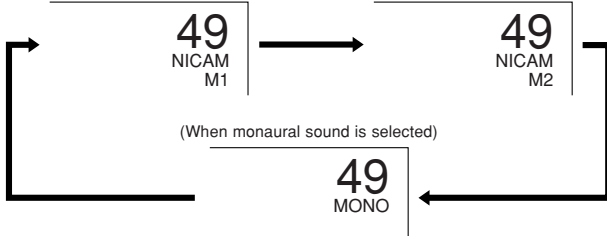

## Monaural

The LCD TV set is receiving a monaural broadcast.

- Each time you press **MPX**, the mode changes between "NICAM MONO" and "MONO".

(When monaural sound is received)

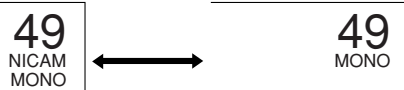

## NOTE

- If approximately 3 seconds pass without a button being pressed, the mode setting is automatically terminated and the LCD TV set returns to the normal mode.
- The setting can be selected individually for each channel number.

If the sound quality is poor due to a weak signal or other problems during NICAM broadcast reception, set the "OFF" position of the NICAM to change the TV sound to monaural.

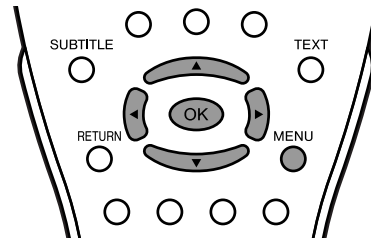

- 1 Press **MENU** to display the Menu screen.
- 2 Press **◀▶** to select "SETUP".
- 3 Press **▲▼** to select "CH SETUP", and press **OK**.
- 4 Press **▲▼** to select "MANUAL", and press **OK**.
- 5 Press **▲▼** to select "NICAM", and press **◀▶** to select "OFF".

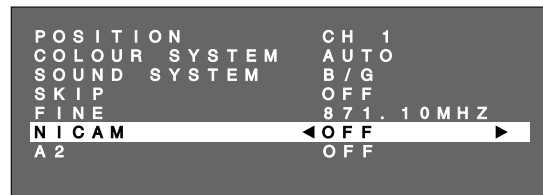

- When the NICAM sound is set to the "OFF" position, the TV sound is output in monaural.

- 6 Press **MENU** to exit.

(When the "OFF" position is selected)



## NOTE

- When the NICAM sound is set to the "OFF" position, **MPX** cannot be used to change the audio mode (stereo and bilingual settings).

# A2 Stereo Broadcast Selection

To let you enjoy A2 stereo broadcasting, this LCD TV set receives A2 stereo system and bilingual broadcasts.

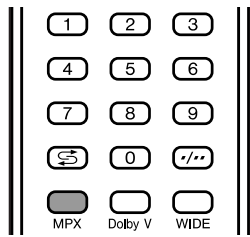

## Stereo

The LCD TV set is receiving a stereo broadcast.

- Each time you press **MPX**, the mode changes between "STEREO" and "MONO".
- When "MONO" is selected, the TV sound is output monaurally.

(When stereo sound is received)

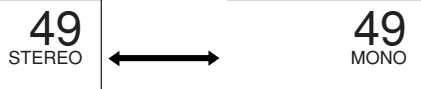

## Bilingual

The LCD TV set is receiving a bilingual broadcast.

- Pressing **MPX** changes the audio mode in the order shown below.
- MAIN=main sound or SUB=sub sound, can be selected.

(When main sound is received)

(When sub sound is received)

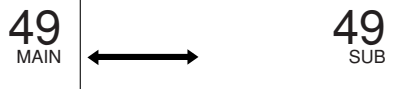

## NOTE

- If approximately 3 seconds pass without a button being pressed, the mode setting is automatically terminated and the LCD TV set returns to normal mode setting.
- The setting can be selected individually for each channel number.

If the sound quality is poor due to a weak signal or other problems during A2 stereo broadcast reception, set the "OFF" position of the A2 to change the TV sound to monaural.

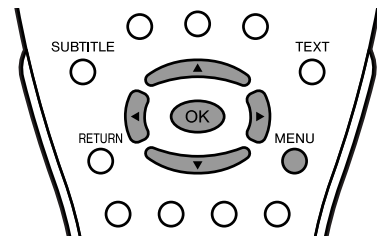

- 1 Press **MENU** to display the Menu screen.
- 2 Press **◀▶** to select "SETUP".
- 3 Press **▲▼** to select "CH SETUP", and press **OK**.
- 4 Press **▲▼** to select "MANUAL", and press **OK**.
- 5 Press **▲▼** to select "A2", and press **◀▶** to select "OFF".

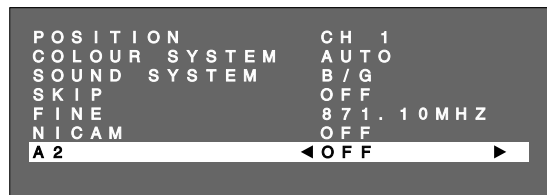

- When the A2 sound is set to the "OFF" position, the TV sound is output in monaural.

(When the "OFF" position is selected)

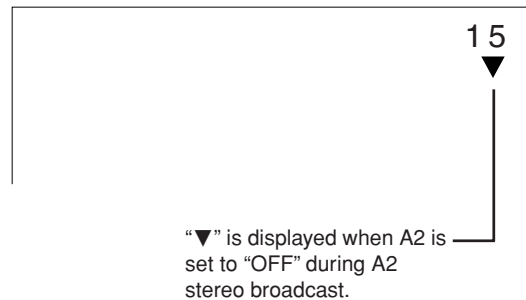

- 6 Press **MENU** to exit.

## NOTE

- When the A2 sound is set to the "OFF" position, **MPX** cannot be used to change the audio mode (stereo and bilingual settings).

# Teletext

## ■ What is Teletext?

Teletext is an information service organised like a magazine, which is provided by some TV stations in addition to regular television broadcasting. Your LCD TV set receives special Teletext signals broadcast by a TV station, processes the information and displays it graphically on the screen. News, weather and sports information, stock exchange prices, programme reviews and closed captioning for people hard of hearing are among the many services available through Teletext.

## ■ Teletext mode

Teletext is activated with **TEXT** on the remote control and is also closed with it. The LCD TV set can be controlled in Teletext mode directly by inputting commands with the remote control and indirectly through the on-screen display (menu system).

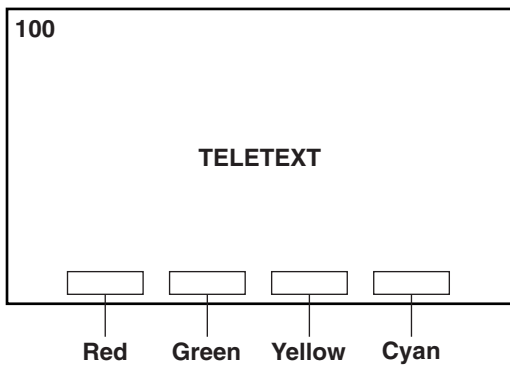

## ■ When viewing the Teletext information

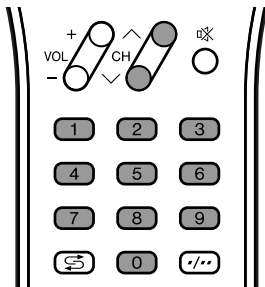

- Press **CH** (▲) to increase the page number.
- Press **CH** (▼) to decrease the page number.
- Directly select any page from 100 to 899 by using **0-9**.

## ■ Operating instructions in Teletext mode

- The FLOF system for teletext is transmitted in Singapore currently.
- The TOP system for teletext is transmitted in Australia currently.
- If TOP Teletext is broadcast, a control line and TOP line can be displayed on the screen. The TOP line involves the operating instructions associated with all of the **Coloured buttons** if TOP text is transmitted, or the operating instructions for only **Red** and **Green** if TOP text is not being transmitted.
- If there are subpages, a control line holding the operating instructions for subpages can be displayed on line 24.

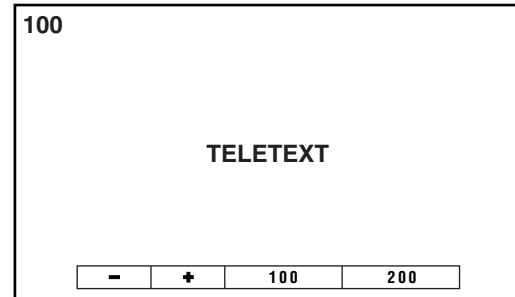

### [1] Turning on and off Teletext mode

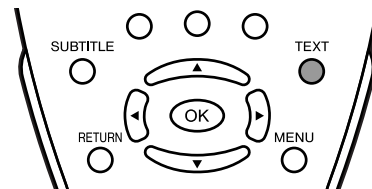

- 1 Select a TV channel that is broadcasting the Teletext programme.
- 2 Press **TEXT** to display the Teletext screen.
  - To turn off the Teletext mode, press **TEXT** again.

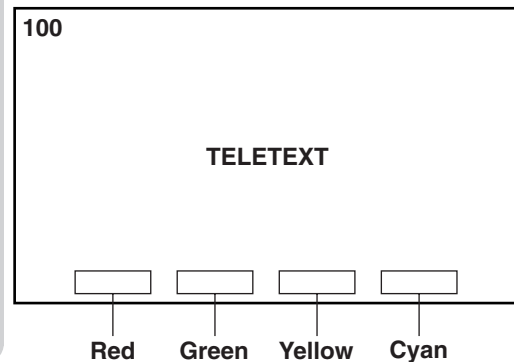

### [2] Using the TOP line

When TOP Teletext is being broadcast, you can display the TOP line, which contains the operating instructions on the screen.

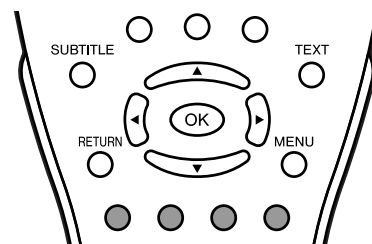

- Press the **Coloured buttons** to operate the Teletext screen.
- Press **Red** to display the previous page and **Green** to display the next page. **Yellow** and **Cyan** are as indicated on the TOP line.

## [3] Changing subpages

If a page has been selected from among several subpages, you can display a control line which contains the subpage numbers.

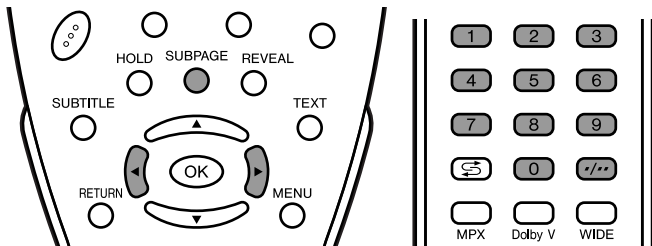

- 1 Press **SUBPAGE**.
  - The control line with the subpage numbers is displayed on line 24, and the number of the currently selected subpage is displayed in blue.

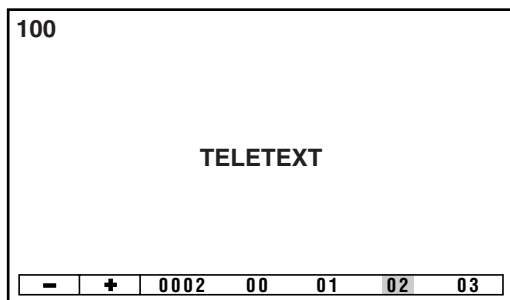

- 2 Press **◀▶** to select the desired subpage number.
  - The selected subpage is displayed.
  - You can also use **Channel Select** to select the desired subpage.
- 3 Press **SUBPAGE** to turn off the control line.

## [4] Using the TOP table

When TOP Teletext is being broadcast, you can display the TOP table with the current programme data if one exists.

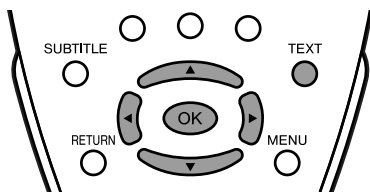

- 1 Press **OK** to display the TOP table.
  - The Teletext page is temporarily turned off.

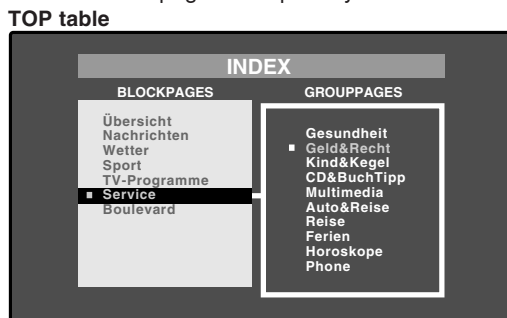

- 2 Press **▲/▼** to select the desired item.
  - Press **◀▶** to select topics (column 1) or subtopics (column 2) if they exist.
- 3 Press **OK**.
  - A page associated with the selected item is displayed.
- 4 Press **TEXT** to exit.

## [5] Using Teletext menu

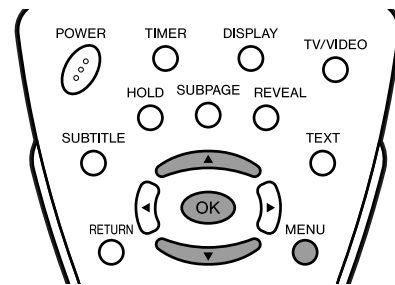

### To select the character set

- 1 During Teletext broadcast, press **MENU** to display the "CHARACTER SET" screen.



- 2 Press **▲/▼** to select the desired character set.
  - The colour of the letters will turn to yellow. When selecting the character set, pressing **OK** will change the letters to grey for an instant and then return them back to yellow.
- 3 Press **MENU** to exit.

## [6] Useful Features for Teletext

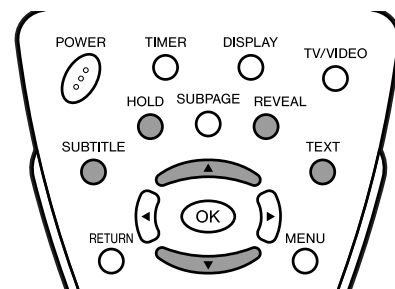

- **HOLD** on the remote control can be used to hold the current teletext page. Press the button again to cancel the hold mode.
- **▲/▼** can be used to zoom the current teletext page as shown below.

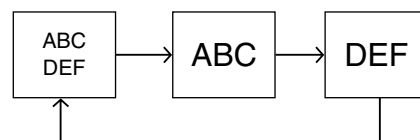

- The screen is displayed in each mode each time **▲/▼** is pressed.
- **SUBTITLE** can be used to quickly activate subtitles.
  - Press **TEXT** to deactivate subtitles.
- **REVEAL** can be used to display hidden information such as solutions to riddles and puzzles. Press the button again to hide the information.

# Connecting with External Devices

You can enjoy picture and sound by connecting a VCR or a home video game system to the terminals located on the rear of the LCD TV set.

When connecting an external device, turn off the power of the LCD TV set first to prevent any possible damage.

## Example of External Devices that can be Connected

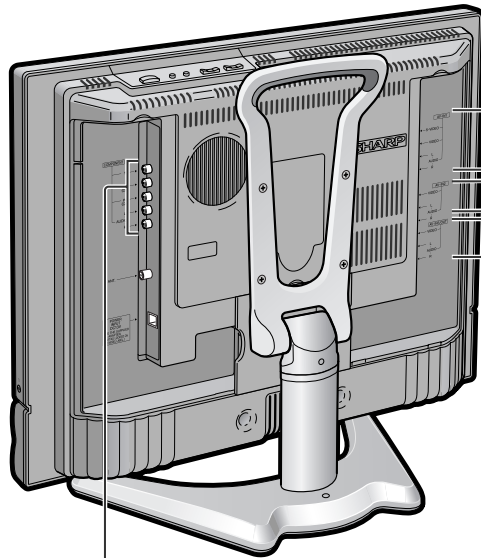

To COMPONENT terminal

<Example>  
• DVD Player, etc.

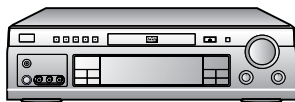

\*If your external device has a COMPONENT terminal, COMPONENT connection is recommended (you can view high-quality pictures).

To AV-IN1 terminal

<Example>  
• Camcorder  
• Home video game system

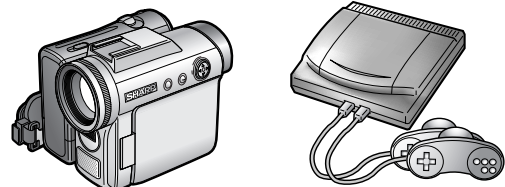

\*If your external device has an S-VIDEO terminal, S-VIDEO connection is recommended.

To AV-IN2/3 terminal

<Example>  
• VCR



### NOTE

- For the cable, use a commercially available audio/video cord.
- Only connect audio/video signals to AV-IN1, AV-IN2 and AV-IN3/OUT terminals. Connecting other signals may result in a malfunction.
- AV-IN1 has 2 video input terminals: VIDEO and S-VIDEO. When you connect external devices to both terminals (and if you select AV-IN1), you can only view pictures from the S-VIDEO terminal. To view the picture from the VIDEO terminal, do not connect any external devices to the S-VIDEO terminal.
- For more information about external device connections, see the manuals of your external devices.

# Connecting with External Devices (Continued)

## Connecting a VCR, DVD Player or a Camcorder (COMPONENT/AV-IN1/2/3)

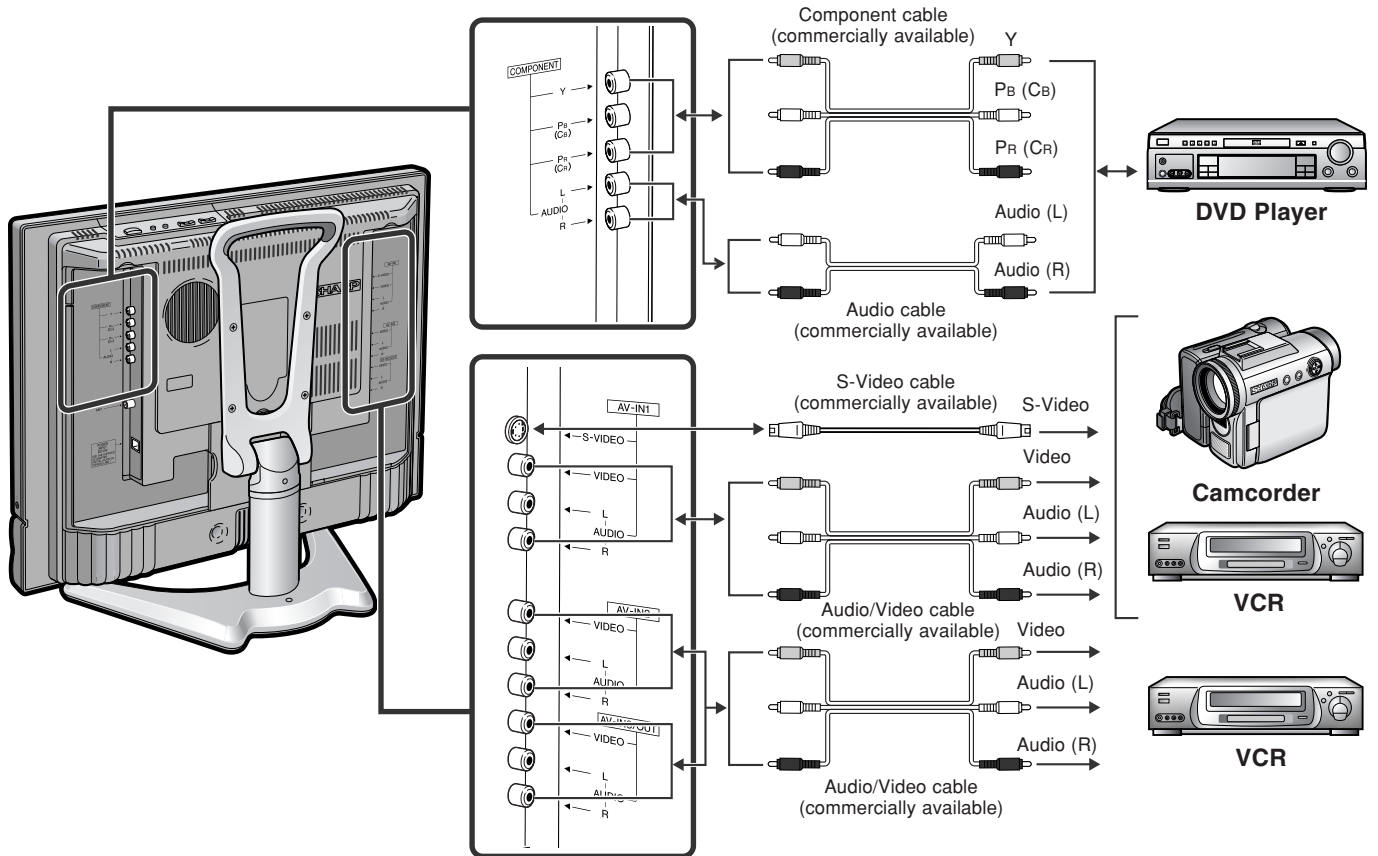

### NOTE

- If your VCR (or other external devices) has an S-Video terminal, S-Video connection is recommended. (Use an S-Video cable.)
- When you connect external devices to both S-VIDEO and VIDEO terminals, you can only view pictures from the S-VIDEO terminal.
- You cannot view multiple or synthesised pictures by connecting two or more external devices. When connecting an external device, use care to connect the video and audio cables to the corresponding terminals.
- When a monaural audio source is connected to only one of the AUDIO input terminals, sound will be heard not from both speakers but from only one speaker.

## Outputting Video and Audio (Video Output)

You can output video and audio data from the LCD TV set through the AV output terminals (AV-IN3/OUT).

- When using AV-IN3/OUT as an OUTPUT terminal, select "SETUP" in the Menu and set "AV3 IN/OUT" to "OUT". (See page 21.)
- The factory setting for "AV3 IN/OUT" is "IN".

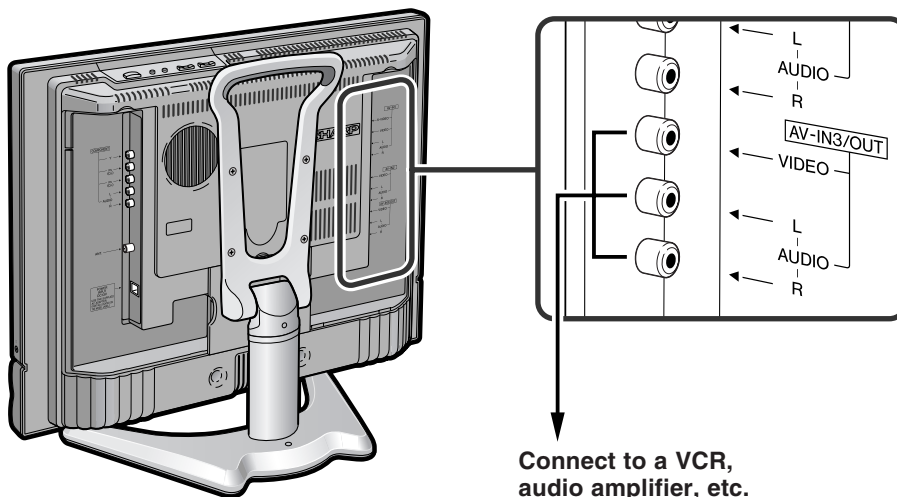







### NOTE

- The AV-IN3/OUT terminal has 2 output modes (see page 21).
- When using the S-VIDEO input for AV-IN1, no video output will be made to the AV output terminal, but audio output will be made for connection to external audio systems.
- When using the S-VIDEO input for AV-IN1 or Y, Pb (Cb) and Pr (Cr) input for COMPONENT, no video output will be made to the AV output terminal, but audio output will be made for connection to external audio systems.

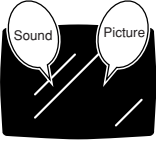
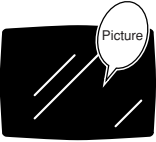
# Troubleshooting

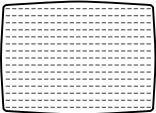
Before calling for repair services, check the following items for possible remedies to the encountered symptoms.





## LCD TV set

Problem	Check item	Reference page
 <p>There is no picture or sound.</p>	<ul style="list-style-type: none"> <li>• Make sure the AC adapter is properly inserted in the power outlet.</li> <li>• Reception other than those of broadcasting stations can be considered.</li> <li>• Make sure the input mode is set to the LCD TV set.</li> <li>• Make sure the MAIN POWER switch of the LCD TV set is on.</li> </ul>	<p>6</p> <p>–</p> <p>10</p> <p>10</p>
 <p>There is no picture. There is no picture from AV-IN1/2/3.</p>	<ul style="list-style-type: none"> <li>• Make sure Picture adjustment is properly adjusted.</li> <li>• The fluorescent lamp may have reached the end of its service life.</li> <li>• Make sure the S-VIDEO terminal has nothing connected.</li> </ul>	<p>16</p> <p>–</p> <p>8, 29</p>
 <p>There is no sound.</p>	<ul style="list-style-type: none"> <li>• Make sure the volume is not set to minimum.</li> <li>• Make sure the sound is not set to mute.</li> </ul>	<p>11</p> <p>11</p>
 <p>There is no picture or sound, just noise.</p>	<ul style="list-style-type: none"> <li>• Make sure the antenna cable is properly connected.</li> <li>• Bad reception can be considered.</li> </ul>	<p>6</p> <p>–</p>
 <p>The Picture is not clear.</p>	<ul style="list-style-type: none"> <li>• Make sure the antenna cable is properly connected.</li> <li>• Bad reception could be the problem.</li> </ul>	<p>6</p> <p>–</p>
 <p>The Picture is too light or improperly tinted.</p>	<ul style="list-style-type: none"> <li>• Check colour adjustment. (NTSC mode)</li> </ul>	<p>16</p>
 <p>The picture is too dark.</p>	<ul style="list-style-type: none"> <li>• Check if "BACKLIGHT" is set to "DARK".</li> <li>• Check "CONTRAST".</li> <li>• The fluorescent lamp may have reached the end of its service life.</li> </ul>	<p>21</p> <p>16</p> <p>–</p>
Remote control does not work.	<ul style="list-style-type: none"> <li>• Check if batteries in the remote control have sufficient power.</li> <li>• Make sure the remote sensor window is not under strong lighting.</li> </ul>	<p>5</p> <p>5</p>
Unit cannot be operated.	<ul style="list-style-type: none"> <li>• External influences such as lightning, static electricity, etc., may cause improper operation. In this case, operate the unit after first turning the power off, or unplugging the AC cord and re-plugging it in after 1 or 2 minutes.</li> </ul>	<p>–</p>

### ■ Cautions regarding use in high and low temperature environments

- When the unit is used in a low temperature space (e.g. room, office), the picture may leave trails or appear slightly delayed. This is not a malfunction, and the unit will recover when the temperature returns to normal.
- Do not leave the unit in a hot or cold location. Also, do not leave the unit in a location exposed to direct sunlight or near a heater, as this may cause the cabinet to deform and the LCD panel to malfunction.  
(Storage temperature: –20°C to +60°C)

## Antenna

Problem	Check item
 <p>The picture is not sharp.</p>	<ul style="list-style-type: none"> <li>The reception may be weak.</li> <li>The state of the broadcast may also be bad.</li> <li>Make sure the antenna is facing the correct direction.</li> <li>Make sure the outside antenna has not been disconnected.</li> </ul>
 <p>The picture moves.</p>	
 <p>The picture is doubled or tripled.</p>	<ul style="list-style-type: none"> <li>Make sure the antenna is facing the correct direction.</li> <li>Broadcast waves may be reflected from adjacent mountains or buildings.</li> </ul>
 <p>The picture is spotted.</p>	<ul style="list-style-type: none"> <li>There may be interference from automobiles, trains, high-voltage lines, neon lights, etc.</li> <li>There may be interference between the antenna cable and power cable. Try positioning them further apart.</li> </ul>
 <p>There are stripes on the screen or colours fade.</p>	<ul style="list-style-type: none"> <li>Is the unit receiving interference from other devices? Transmission antennas of radio broadcasting stations and transmission antennas of amateur radios and cellular phones may also cause interference.</li> <li>Use the unit as far apart as possible from devices that may cause possible interference.</li> </ul>

## Specifications

ITEMS	MODEL	LC-22GA3M / LC-22GA3X
LCD panel		22" (55 cm) Advanced Super View & BLACK TFT LCD
Number of pixels		1,229,760 dots WVGA
Video colour systems		World multi system
TV function	TV Standard (CCIR)	PAL: B/G, I, D/K NTSC:M SECAM: B/G, D/K
	TV Tuning System	Auto preset tuning
	STEREO/BILINGUAL	NICAM-B/G, I, D/K A2 stereo-B/G
	AUTO PRESET	Yes
	CATV	S1~S41 ch. Hyper Band
4-LINE DIGITAL COMB FILTER		Yes
Brightness		450 cd/m <sup>2</sup>
Lamp life		60,000 hours*
Viewing angles		H: 170° V: 170°
Audio output		5 W × 2
Speakers		6 × 12 cm, 2 pcs.
Terminals	COMPONENT	Y, P <sub>B</sub> (C <sub>B</sub> ), P <sub>R</sub> (C <sub>R</sub> )/Audio (L/R)
	AV-IN1	Composite Video, S-Video, Audio
	AV-IN2	Composite Video, Audio
	AV-IN3/OUT	Composite Video, Audio IN/Composite Video, Audio Out
	Headphone jack	3.5 mm ø jack (Side)
OSD LANGUAGE		English/Chinese/Arabic
Power requirement		DC 13 V, AC 110–240 V, 50/60 Hz
Power Consumption		65 W (1.1 W at Standby): AC 230 V 50 Hz (With AC adapter)
		53 W : DC 13 V
Weight		8.9 kg w/o accessories

\* The typical period of time after which the lamp's power output will have decreased by about half, given that the AQUOS is used continuously in a 25°C room under standard lighting and brightness conditions.

■ As a part of policy of continuous improvement, SHARP reserves the right to make design and specification changes for the LCD TV set improvement without prior notice. The performance specification figures indicated are nominal values of production units. There may be some deviations from these values in individual units.



# Dimensional Drawings

Unit: mm

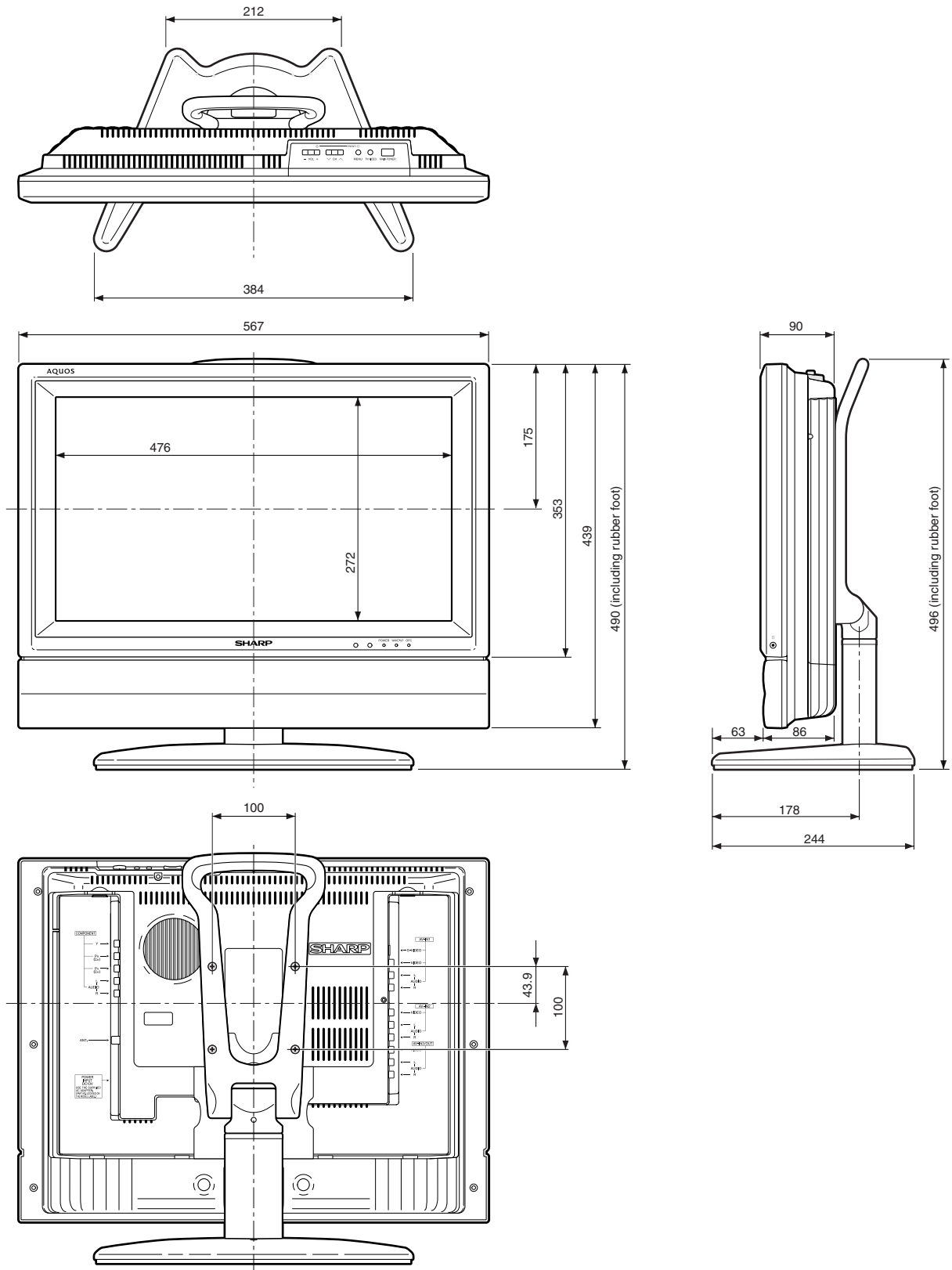

## Free Manuals Download Website

<http://myh66.com>

<http://usermanuals.us>

<http://www.somanuals.com>

<http://www.4manuals.cc>

<http://www.manual-lib.com>

<http://www.404manual.com>

<http://www.luxmanual.com>

<http://aubethermostatmanual.com>

Golf course search by state

<http://golfingnear.com>

Email search by domain

<http://emailbydomain.com>

Auto manuals search

<http://auto.somanuals.com>

TV manuals search

<http://tv.somanuals.com>