

FO-4700/FO-5700

SHARP[®]

MODEL

**FO-4700
FO-5700**

FACSIMILE

OPERATION MANUAL

FACSIMILE













1. Installation
2. Sending Documents
3. Receiving Documents
4. Making Copies
5. Special Functions
6. Option Settings
7. Printing Reports and Lists
8. Maintenance
9. Troubleshooting

SHARP[®]

QUICK REFERENCE GUIDE

Note: Steps which are optional are enclosed in a dotted frame: 

Transmitting documents

Normal Dialling	Load document →  → press SPEAKER → Dial (press numeric keys) → Wait for reception tone →  → Hang up
Direct Keypad Dialling	Load document →  → Dial (press numeric keys) → 
Rapid Key Dialling	Load document →  → Press Rapid Key
Speed Dialling	Load document →  →  → Enter Speed Dial number (press numeric keys, - if less than 3 digits, press START to complete entry) → 
Redialling	Load document →  →  → Wait for reception tone → 

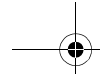

Introduction

Welcome, and thank you for choosing a Sharp facsimile machine! The features and specifications of your new Sharp fax machine are shown below.

Automatic dialling	Rapid Key Dialling: 48 numbers Speed Dialling: FO-4700: 75 numbers FO-5700: 100 numbers
Memory size*	1 MB (approx. 56 pages with ECM off)
Modem speed	FO-4700: 14,400 bps (max.) FO-5700: 33,600 bps (max.) Automatic fallback to lower speeds.
Transmission time*	FO-4700: Approx. 6 seconds FO-5700: Approx. 2 seconds
Toner cartridge yield (4% page coverage, A4 paper)	Initial starter cartridge (included with fax machine): Approx. 3000 pages Replacement cartridge (FO-47DC): Approx. 6000 pages
Drum cartridge yield	Initial starter cartridge (included with fax machine): 20,000 pages (ave.) Replacement cartridge (FO-47DR): 20,000 pages (ave.)
Resolution	Horizontal: 8 pels/mm Vertical: Standard: 3.85 lines/mm Fine /Halftone: 7.7 lines/mm Super fine: 15.4 lines mm

Note: This facsimile machine is Year 2000 compliant.

*Based on ITU-T Test Chart #1 at standard resolution in Sharp special mode, excluding time for protocol signals (i.e., ITU-T phase C time only).

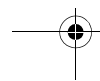
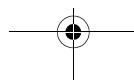

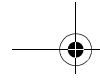

Automatic document feeder	50 pages max. (A4 paper)
Paper capacity	250 sheets (500-sheet cassette available as option)
Compression scheme	MMR, MR, MH, Sharp (H2) (FO-5700: Also supports JBIG)
Halftone (greyscale)	64 levels
Applicable telephone line	Public switched telephone network
Compatibility	ITU-T (CCITT) G3 mode
Printing resolution	Horizontal: 16 lines/mm Vertical: 15.4 lines/mm PC Printing: 600 dpi
Input document size	Automatic feeding: Width: 148 to 256 mm Length: 128 to 364 mm Manual feeding: Width: 148 to 279 mm Length: 128 to 432 mm
Effective Scanning width	210 mm max.
Effective Printing width	203 mm max.
Reception modes	Auto/Manual
Instascan speed	30 ppm (A4 paper)
Full Dual Access	Yes
Copy function	Single/Multi/Sort (99 copies/page)
Power requirements	230 - 240 V AC, 50 Hz
Operating temperature	10 - 30°C
Humidity	20 to 85% RH

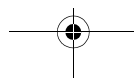
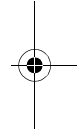
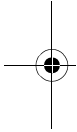

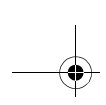

Power consumption	Standby: 10 W Maximum: 740 W
Dimensions	Width: 460 mm Depth: 385 mm Height: 270 mm
Weight	Approx. 12.6 kg

As a part of our policy of continuous improvement, SHARP reserves the right to make design and specification changes for product improvement without prior notice. The performance specification figures indicated are nominal values of production units. There may be some deviations from these values in individual units.

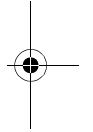
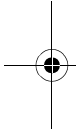

Important safety information

Be sure to save these instructions!

- For your safety, if any of your equipment is not operating properly or should any physical damage occur to the equipment where internal parts may become exposed, the equipment should be immediately disconnected from the phone line and then the power line and returned to a SHARP authorised Service Centre for inspection, repair, or disposal.
- In Australia, installing or modifying telephone lines should only be done by an ACA licensed serviceman. In New Zealand, installing or modifying telephone lines should be done in accordance with Telecom wiring practices.

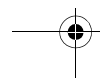
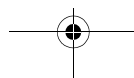

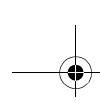

When using your facsimile equipment, basic safety precautions should always be followed to reduce the risk of fire, electric shock and injury to persons, including the following:

- Do not disassemble this machine or attempt any procedures not described in this manual. Refer all servicing to qualified service personnel.
- This machine must only be connected to a 230-240 V, 50 Hz, earthed (3-prong) outlet. Connecting it to any other kind of outlet will damage the machine.
- Do not install or use the machine near water, or when you are wet. For example, do not use the machine near a bath tub, wash bowl, kitchen sink or laundry tub, in a wet basement, or near a swimming pool. Take care not to spill any liquids on the machine.
- Use only the power cord provided with the facsimile machine. Do not use an AC extension cord.
- Unplug the machine from the telephone socket and then the power outlet and consult a qualified service representative if any of the following situations occur:
 - Liquid has been spilled into the machine or the machine has been exposed to rain or water.
 - The machine produces odors, smoke, or unusual noises.
 - The power cord is frayed or damaged.
 - The machine has been dropped or the housing damaged.
- Do not allow anything to rest on the power cord, and do not install the machine where people may walk on the power cord.
- Never insert objects of any kind into slots or openings on the machine. This could create a risk of fire or electric shock. If an object falls into the machine that you cannot safely remove, unplug the machine and consult a qualified service representative.
- Do not place this machine on an unstable cart, stand or table. The machine could be seriously damaged if it falls.

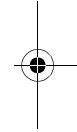
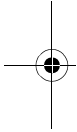

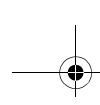

- Avoid using a telephone (other than a cordless type) during an electrical storm. There may be a remote risk of electric shock from lightning.
- Do not use a telephone to report a gas leak in the vicinity of the leak.
- The socket-outlet must be installed near the equipment and must be easily accessible.

Important:

- This facsimile machine is designed to operate in Australia and New Zealand only.
- This facsimile machine is not designed for use on a line which has call waiting, call forwarding, or certain other special services offered by your telephone company. If you attempt to use the fax machine on a telephone line using any of these services, you may experience errors during transmission and reception of facsimile messages.
- This facsimile machine is not compatible with digital telephone systems.

Caution!!

- This is a Class A product. In a domestic environment this product may cause radio interference in which case the user may be required to take adequate measures.

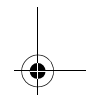
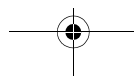
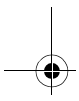
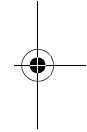
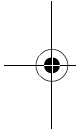

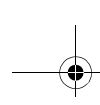

WARNING NOTICE: NO calls can be made to or from this fax during a mains power failure.

WARNING: Australian Communications Authority (ACA) regulations state that no unauthorised changes or modifications to this equipment are permitted.

Note: Complies with ACA and NZ TELECOM standard AS/NZS3548 regarding emission of electromagnetic interference.

These limits are designed to provide reasonable protection against interference in an installation. This equipment generates, uses and can radiate radio frequency energy and, if not installed and used in accordance with the instructions, may cause interference. However, there is no guarantee that interference will not occur in a particular installation.

If this equipment does cause interference to radio or television reception, which can be determined by turning the equipment off and on, the user is encouraged to try to correct the interference by one or more of the following measures:

- Reorient or relocate the receiving antenna.
- Increase the separation between the equipment and the receiver.
- Connect the equipment to an outlet on a different circuit to that which the receiver is connected.
- Consult the dealer or an experienced radio/TV technician for help.

For Australia: The Ringer Equivalence Number (REN) for this equipment is written on the back of the machine. The sum of all the Ringer Equivalence Numbers (REN's) on your telephone line should not exceed 3 to assure correct service from your telephone company.

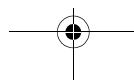
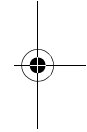
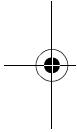

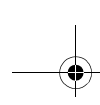

Important Notice For New Zealand Users

Please note:

The grant of a Telepermit for any item of terminal equipment indicates only that Telecom has accepted that the item complies with the minimum conditions for connection to its network.

It indicates no endorsement of the product by Telecom, nor does it provide any sort of warranty. Above all, it provides no assurance that any item will work correctly in all respects with another item of Telepermitted equipment of a different make or model, nor does it imply that any product is compatible with all of Telecom's network services.

This equipment is not capable, under all operating conditions, of correct operation at the higher speeds for which it is designed. Telecom will accept no responsibility should difficulties arise in such circumstances.

This equipment shall not be set up to make automatic calls to the Telecom '111' Emergency Service.

To avoid telephone charges for local calls, be sure to store numbers "without" area code in your rapid or speed dial locations.

This equipment may not provide for the effective hand-over of a call to another device connected to the same line.

Not all standard telephones and answering machines will respond to incoming ringing when connected to the extension socket of the equipment.

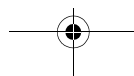
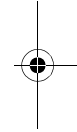
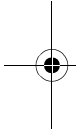

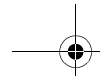

Table of Contents

QUICK REFERENCE GUIDE 1

Introduction 2
 Important safety information 4
 Important Notice For New Zealand Users 8

Table of Contents 9

1. Installation 11
 Unpacking Checklist 11
 A Look at the Operation Panel 12
 Connections 18
 Installing the Print Cartridges 23
 Loading Printing Paper 28
 Entering Your Name and Fax Number 31
 Setting the Date and Time 34
 Volume Adjustment 36

2. Sending Documents 38
 Transmittable Documents 38
 Loading the Document 40
 Adjusting the Resolution and Contrast 41
 Sending a Fax by Normal Dialling 43
 Programming Auto-Dial Numbers 45
 Sending a Fax by Automatic Dialling 51
 Cover Sheet 62
 Batch Page Numbering 64

3. Receiving Documents 66
 Using AUTO Reception Mode 67
 Using MANUAL Reception Mode 67
 Substitute Reception to Memory 68





Table of Contents

4. Making Copies 69

5. Special Functions 72

Broadcasting 72

Confidential Operations 77

Relay Request 83

Polling 91

Power Save Mode 99

Timer Operations 105

Batch Transmission 116

Entering and Using Programs 119

Duplex Scanning for Two-sided Documents 134

Print Hold 136

Department Control 138

Blocking Reception of Unwanted Faxes 141

6. Optional Settings 143

7. Printing Lists and Reports 153

8. Maintenance 161

Cleaning the Scanning Glass and Rollers 161

The Housing 162

Replacing the Verification Stamp 162

9. Troubleshooting 164

Problems and Solutions 164

Messages and Signals 168

Clearing Paper Jams 171

Index 175



1. Installation

Unpacking Checklist

Before setting up, make sure you have all of the following items. If any are missing, contact your dealer.

Power lead

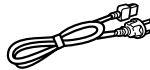

Telephone line cord



Toner cartridge

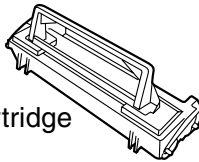

Drum cartridge

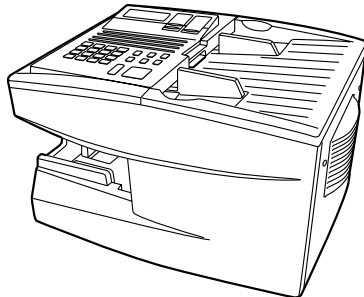
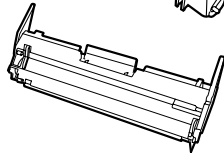

Rapid Key labels



Paper size labels



Document OUT tray

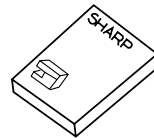

Operation manual

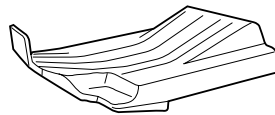

Received document tray



Business products dealer installation report



Adapter (for Australia)

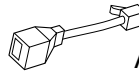

Adapter (for New Zealand)

A Look at the Operation Panel

A Look at the Operation Panel

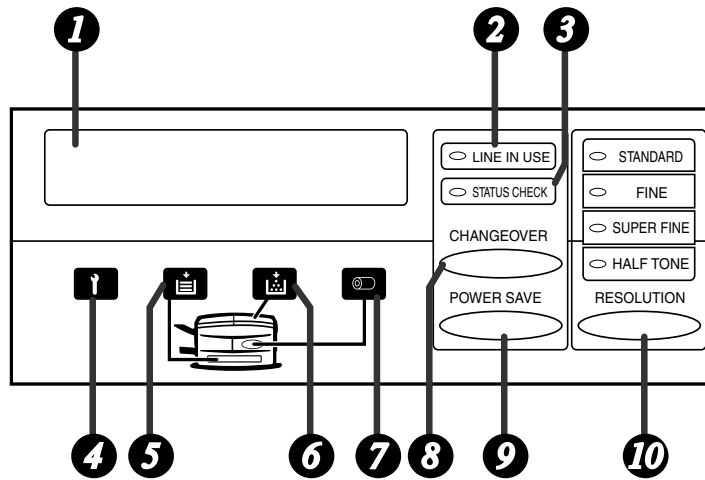

- 1 Display**
This displays messages and prompts during operation and programming.
- 2 LINE IN USE light**
This lights when the fax machine is using the telephone line.
- 3 STATUS CHECK light**
This lights when a paper size error or paper jam occurs, or when the print compartment cover is open. A message will appear in the display to indicate the problem.
- 4 Service indicator**
This lights when a problem occurs which must be fixed by a service technician.

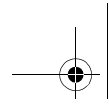

A Look at the Operation Panel

1. Installation

- 5 Paper out indicator**

This lights when the fax machine is out of paper, or when the received document tray is not properly installed. If the machine has a paper cassette, the indicator blinks when one of the paper sources (tray or cassette) is out of paper, and lights steadily when all sources are out of paper.
- 6 Toner cartridge indicator**

This blinks when the toner cartridge nears empty, and lights steadily when the toner cartridge needs replacement.
- 7 Drum cartridge indicator**

This blinks when the drum cartridge nears the end of its life, and lights steadily when the drum cartridge needs replacement.
- 8 CHANGEOVER key**

Two types of information appear in the display: prompts related to operations you are performing, and information about how the fax is using the telephone line (transmitting, receiving, etc.). Press this key to switch between the two types of information.
- 9 POWER SAVE key**

Press this key to turn on Power Save Mode, or set the Power Save Mode timer if TIMER has been selected with Option Setting 34 (Power Save Mode).
- 10 RESOLUTION key**

Press this key to adjust the resolution before sending or copying a document.

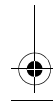
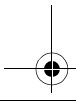
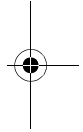
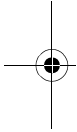

A Look at the Operation Panel

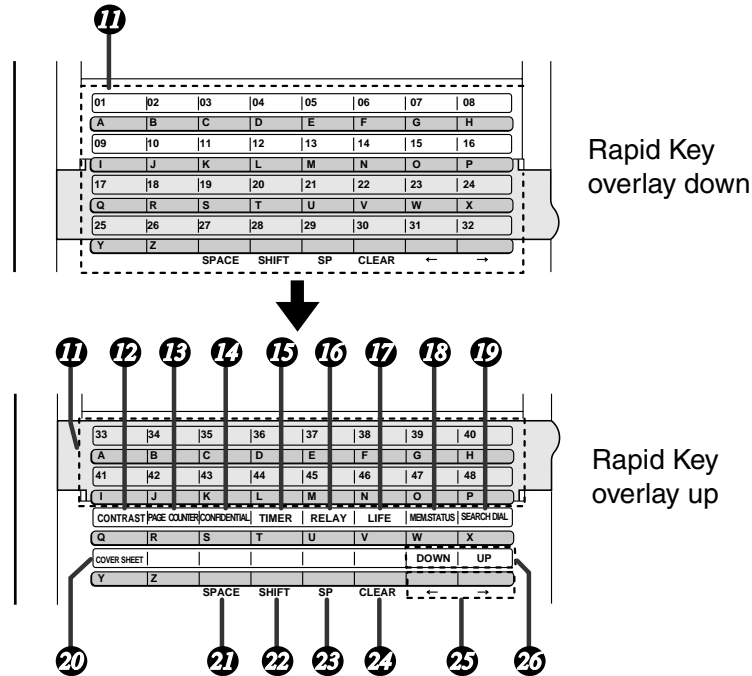

- 11** **Rapid Dial Keys**
Press one of these keys to dial a fax number automatically. (Note that you must attach the Rapid Key labels.)
- 12** **CONTRAST key**
Press this key to adjust the contrast before sending or copying a document.
- 13** **PAGE COUNTER key**
Press this key to include a slash and the total number of pages after each page number on the pages of a transmitted document.
- 14** **CONFIDENTIAL key**
Press this key to send or print out a confidential document.
- 15** **TIMER key**
Press this key to set an operation to be performed automatically at a later time.

A Look at the Operation Panel

1. Installation

- 16 RELAY key**
Press this key to send a document to another Sharp fax machine and have that machine in turn relay the document to one or more end receiving machines.
- 17 LIFE key**
Press this key, followed by **1**, to check the total number of pages printed by the fax machine.
- 18 MEM. STATUS key**
Press this key to check the status of documents waiting in memory for transmission.
- 19 SEARCH DIAL key**
Press this key to search through your auto dial fax numbers by name.
- 20 COVER SHEET key**
Press this key to include a cover sheet when sending a fax.
- 21 SPACE key**
Press this key to enter a space when programming a name.
- 22 SHIFT key**
Press this key to switch between upper and lower case letters when programming a name.
- 23 SP key**
Press this key to enter a symbol when programming a name.
- 24 CLEAR key**
Press this key to clear a mistake when programming a name or fax number.
- 25 Arrow keys**
Press these keys to move the cursor forward or backward when programming a name or fax number.
- 26 UP and DOWN keys**
Press these keys to adjust the volume of the speaker when the **SPEAKER** key has been pressed, or the volume of the ringer at all other times.

A Look at the Operation Panel

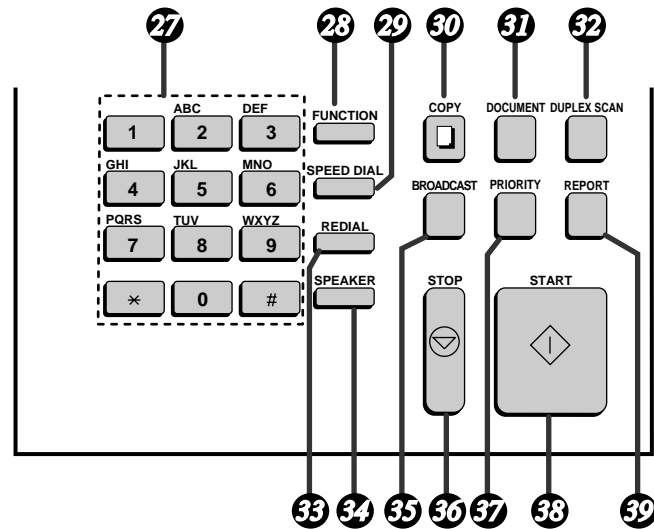

- 27 Dial keypad (numeric keys)**
Use these keys to dial and program fax numbers.
- 28 FUNCTION key**
Press this key to select various special functions.
- 29 SPEED DIAL key**
Press this key to dial a Speed Dial number.
- 30 COPY key**
Press this key to make a copy of a document.
- 31 DOCUMENT key**
Press this key to transmit a document without reading it first into memory.

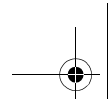

A Look at the Operation Panel

1. Installation

- 32 DUPLEX SCAN key**
Press this key to transmit or copy a two-sided document.
- 33 REDIAL key**
Press this key to automatically redial the last number dialed.
- 34 SPEAKER key**
Press this key when transmitting a document by Normal Dialing to listen to the line and verify the response of the receiving fax machine.
- 35 BROADCAST key**
Press this key to send a document to a group of receiving fax machines.
- 36 STOP key**
Press this key to cancel an operation before it is completed.
- 37 PRIORITY key**
Press this key when you need to transmit a document ahead of other documents waiting in memory for transmission.
- 38 START key**
Press this key to begin transmission when using Speed Dialing, Direct Keypad Dialing, or Normal Dialing.
- 39 REPORT key**
Press this key to print out a report on the most recently completed transmission or reception.

Connections

Connections

Points to keep in mind when setting up

- ◆ Do not place the machine in direct sunlight.
- ◆ Do not place the machine near heaters or air conditioners.
- ◆ Keep dust away from the machine.
- ◆ Install the machine on a level surface.

Connecting the power cord

Connect the female end of the power lead to the fax machine as shown. Insert the male end into a 230-240 V, 50 Hz, earthed (3-prong) AC outlet.

- ◆ **Caution:** When disconnecting the fax, unplug the telephone line cord before unplugging the power lead.

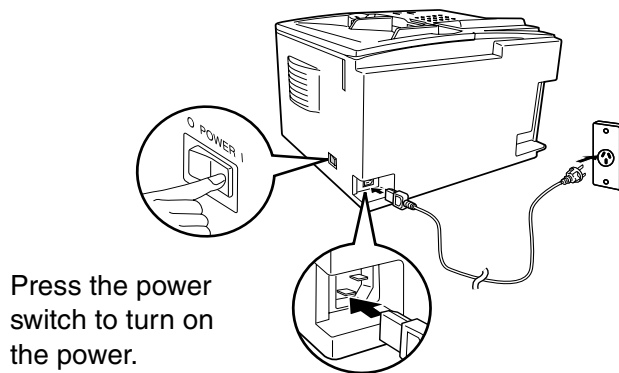

Note: If your area experiences a high incidence of lightning or power surges, we recommend that you install surge protectors for the power and telephone lines. Surge protectors can be purchased at most telephone specialty stores.

Connecting the telephone line cord

Insert one end of the telephone line cord into the adapter. Insert the other end of the line cord into the socket on the back of the fax marked TEL. LINE. Plug the adapter into the telephone socket on the wall.

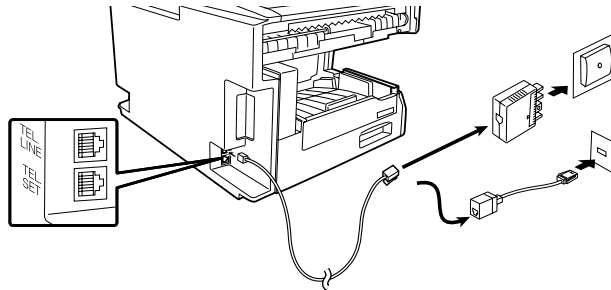

Note: The fax machine is set for tone dialling. If you are on a pulse dial line, you must set the fax machine for pulse dialling by changing Option Setting 22. This procedure is described in Chapter 6, *Optional Settings*.

Moving the fax machine and reconnecting

Should it be necessary to move your fax to a new location, first disconnect the telephone line cord before disconnecting the power cord. When reconnecting, it is necessary to connect the power cord before connecting the telephone line cord.

Connecting a telephone (optional)

If desired, you can connect a telephone to the TEL. SET socket on the back of the machine.

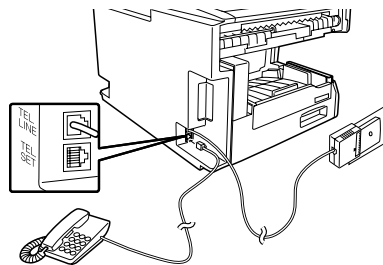

Important: In New Zealand, not all standard telephones will respond to incoming ringing when connected to the extension socket of the equipment.

Connections

Attaching the document OUT tray

Insert the protrusion on the right side of the machine into the hole in the right side of the document OUT tray as shown, then bend the tray slightly and insert so that the protrusion on the left side of the machine goes into the hole on the left side of the document OUT tray.

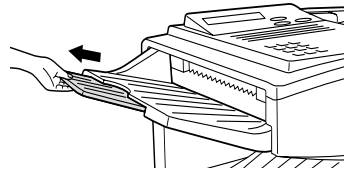
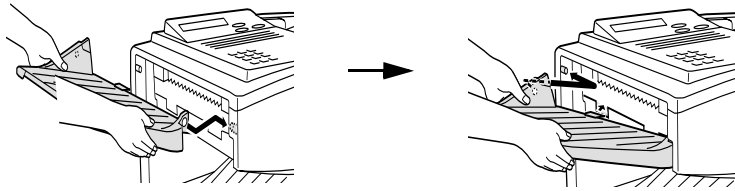

Pull out the tray extension.

Attaching the received document tray

Slide the received document tray into the machine as shown. When it stops, lift the end slightly and push in so that the tray locks into place.

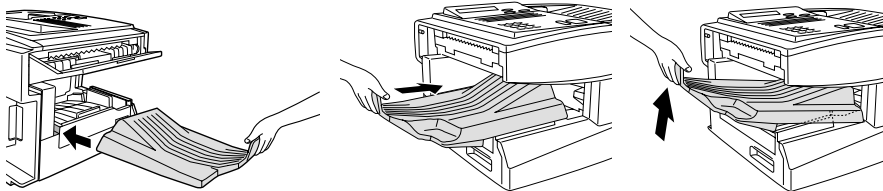

Make sure the left edge of the tray fits into the slot.

Important!

The received document tray must be attached for the fax machine to operate properly.

Connection to a computer (option)

Note: This function is available as an option. If you wish to use it, consult your dealer to have the PC interface board installed.

If desired, you can connect the fax machine to the parallel port of any compatible computer. Once you have installed the provided printer software in your computer, you will be able to use the fax machine as a laser printer for your computer.

Important: Use only an IEEE P1284 parallel cable to connect the fax machine to your computer. We recommend a shielded cable no longer than 2 m.

- 1 Make sure your computer and the fax machine are both turned off.

Turn off

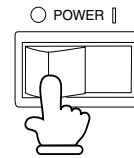

- 2 Connect one end of the cable to the port on the fax machine. Snap the clips on each side of the port onto the cable connector to secure it.

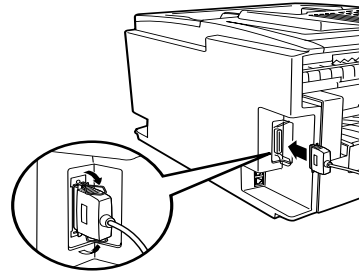

- 3 Connect the other end of the cable to the parallel port on the back of your computer.

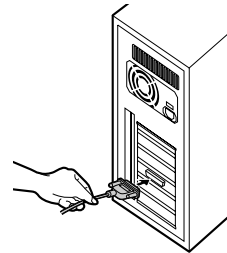

Connections

- 4** Press the panel keys as shown to set Option Setting 31 (PC Interface Mode) to ON. (The option settings are explained in more detail in Chapter 6, *Optional Settings*.)

- Before you can use the fax machine as a printer, you must also install the printer software. To install the software, see the documentation that accompanies it.

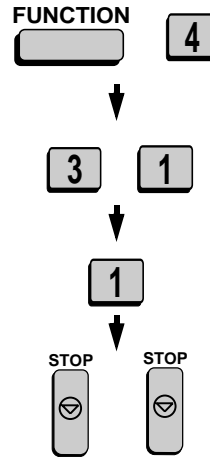

Note: The message PC PRINTING will appear in the display when the fax machine prints a print job from your computer. While this message appears, you will not be able to use the operation panel of the fax machine.

Verification Stamp (option)

Note: This function is available as an option. Consult your dealer if you wish to use it.

When transmitting a document, you can have your fax stamp each document page as it is scanned. After scanning, you can check to see if all documents have been stamped to verify that no double feeds occurred. (A double feed is when two pages are fed through the scanner at once, which means that one of the pages is not scanned.)

To use this function, have your dealer install the Verification Stamp option, and then set Option Setting 29 to ON as explained in Chapter 6, *Optional Settings*.

Installing the Print Cartridges

Follow the steps below to install or replace the toner and drum cartridges.

- ◆ The initial starter toner cartridge included with the fax machine can print a minimum of 3000 A4-size pages (4% coverage of each page).
- ◆ The replacement toner cartridge (FO-47DC) can print approximately 6000 A4-size pages.
- ◆ The drum cartridge (FO-47DR) can print approximately 20,000 A4-size pages.

- 1** Press the green release and open the print compartment cover.

- **Caution!**
The fusing unit inside the print compartment becomes very hot during operation. Be careful not to touch the inside of the compartment.

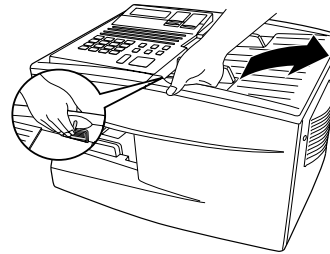

- 2** If you are replacing the toner cartridge, remove the old cartridge and dispose of it according to local regulations. Go directly to Step 6 if you are only replacing the toner cartridge and not the drum cartridge.

- If you are replacing the drum cartridge but not the toner cartridge, remove the toner cartridge and place it on a sheet of paper.

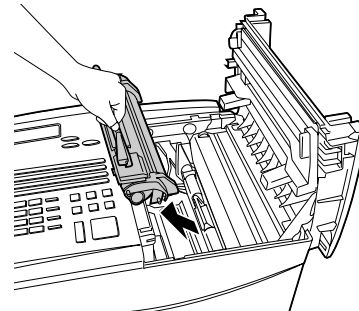

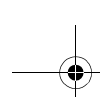

Installing the Print Cartridges

- 3** If you are replacing the drum cartridge, remove the old cartridge and dispose of it according to local regulations.

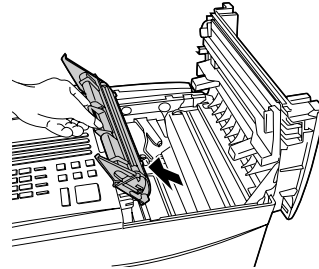

- 4** Remove the new drum cartridge from its packaging.

- **Caution!** Excessive exposure to light will damage the drum cartridge. Install the cartridge promptly after removing it from its packaging.

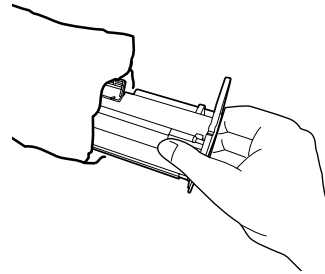

- 5** Insert the drum cartridge into the print compartment, aligning the guides on the cartridge with the grooves on the sides of the compartment.

- Insert the cartridge by aligning the colored "1" labels on the cartridge and the sides of the compartment.
- Make sure the drum cartridge is inserted in as far as it will go.

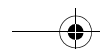
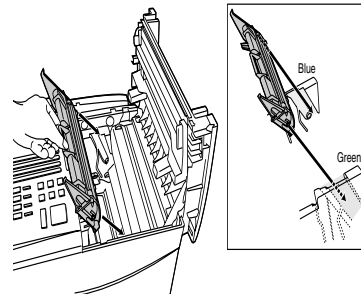

Installing the Print Cartridges

1. Installation

6 If you are installing a new toner cartridge, remove the new toner cartridge from its packaging. Shake as indicated by the arrows to distribute the toner evenly within the cartridge.

- If the toner is still lumpy after shaking, the gears in the cartridge may make a noticeable sound when the print compartment cover is closed after installing the cartridge. This is normal and does not indicate a problem in the machine.

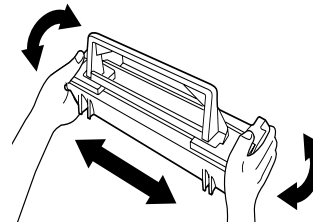
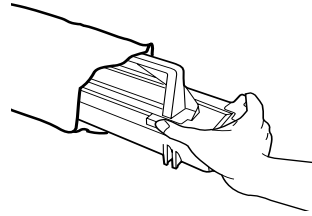

7 Hold the toner cartridge by the handle and lower it into the print compartment. Make sure that the four pins (two on each side) fit into the grooves on the sides of the compartment.

- Insert the cartridge by aligning the colored “2” labels on the cartridge and the side of the compartment
- Make sure the toner cartridge clicks into place.

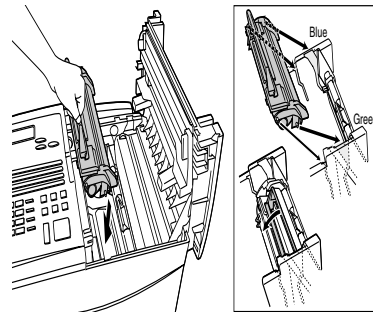

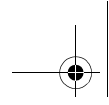

Installing the Print Cartridges



8 Close the print compartment cover.

- Press down on the dot markings at the left edge to make sure the cover is completely closed.

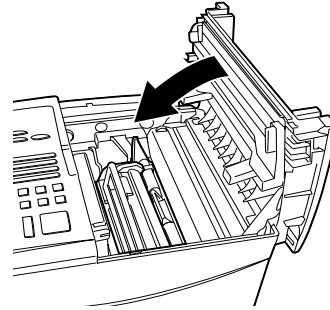

9 Reset the toner counter by pressing the **LIFE** key (flip up the Rapid Key overlay), **2**, and the **START** key.

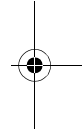
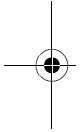
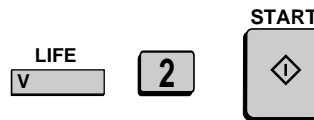

10 Reset the drum counter by pressing the **LIFE** key (flip up the Rapid Key overlay), **3**, and the **START** key.

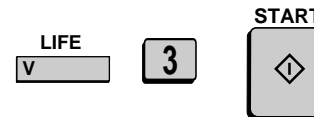

Note: The print compartment cover may become noticeably warm if a large number of pages are successively printed. This is normal and does not indicate a problem in the machine.



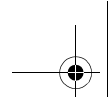

Installing the Print Cartridges

1. Installation

When to replace the toner cartridge

When the toner cartridge nears empty (about 100 pages can still be printed), the toner cartridge indicator on the operation panel will blink. When the toner cartridge is empty, the toner cartridge indicator will light steadily and REPLACE TONER will appear in the display. Printing will no longer be possible. Use the following replacement toner cartridge:

Sharp FO-47ND toner cartridge

When to replace the drum cartridge

When the drum cartridge nears the end of its life, the drum cartridge indicator on the operation panel will blink. When the drum cartridge life is over, the drum cartridge indicator will light steadily and DRUM LIFE OVER will appear in the display. Use the following replacement drum cartridge:

Sharp FO-47DC drum cartridge

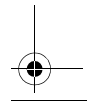
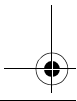
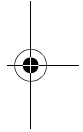
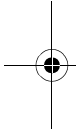

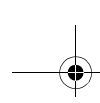

Loading Printing Paper

Loading Printing Paper

You can load up to 250 sheets of A4-size paper (60-80 g/m²) in the paper tray. You can load up to 500 sheets of paper in the paper cassette.

The paper cassette is available as an option. To have the cassette installed, consult your dealer.

Loading paper in the paper tray

- 1** Remove the received document tray.

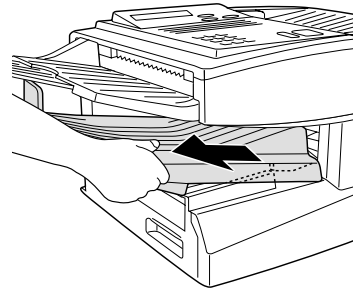

- 2** Insert a stack of paper into the tray, print side up.

- Make sure the end of the tray is pushed in. Otherwise a size error will result.

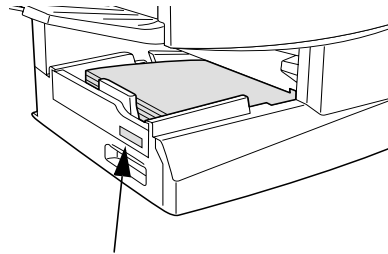

Attach a A4 label here to indicate the paper size.



Loading Printing Paper

1. Installation

3 Replace the received document tray.

- The received document tray must be attached for the fax machine to operate properly.

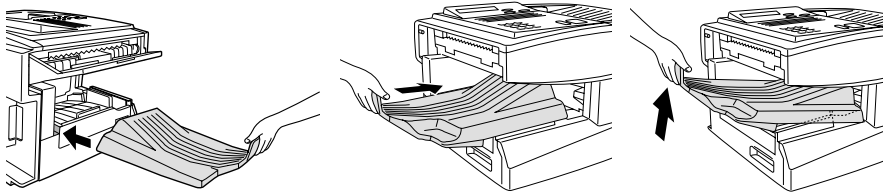

Loading paper in the paper cassette (if installed)

- 1 Grasp the hand-hold on the cassette and pull out the cassette until it stops.

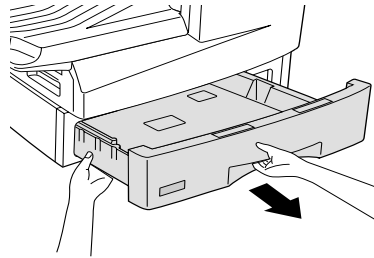

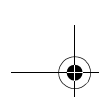

Loading Printing Paper



- 2 Push the pressure plate down until it locks into position.

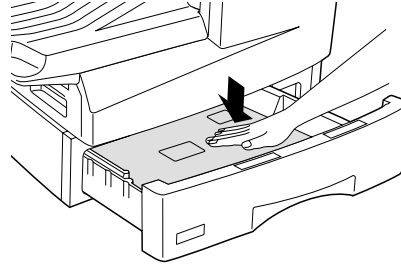

- 3 Place a stack of paper in the cassette, print side up.

- Make sure the stack of paper is not higher than the two tabs on the paper guide and the two metal tabs. If it is, remove some of the paper.

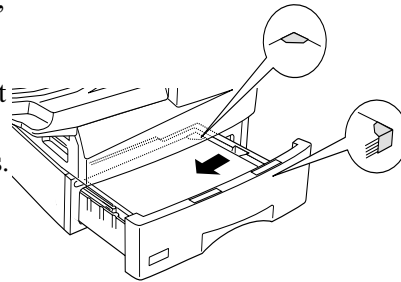

- 4 Push the cassette back into the machine, making sure it clicks into place.

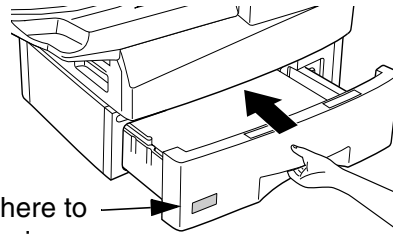

Attach a A4 label here to indicate the paper size.

Note: We recommend that you do not add paper to the tray or cassette while paper still remains. This may result in double feeds.

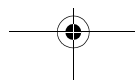

Entering Your Name and Fax Number

Before you can begin using the fax machine, you must program your name and fax number. Once you program this information, it will appear automatically at the top of each fax page you send.

Note: Make sure the display shows the date and time before beginning a programming operation. If the display shows the telephone line status, press the **CHANGEOVER** key to switch to the date and time.

1 Press these keys:



The display will show:

3:ENTRY MODE
ENTER #(1-9,*,#)

2 Press the 3 key.



The display will show:

3:OWN PASSCODE SET
ENTER FAX #

3 Enter your fax number (max. of 20 digits) by pressing the numeric keys  (Example)

- To insert a space between digits, press the # key.
- To clear a mistake, press the **STOP** key.

Entering Your Name and Fax Number

- 4** Press the **START** key.

The display will show:

ENTER SENDER'S NAME



- 5** Flip the Rapid Key overlay down (if it is up), and enter your name by pressing the appropriate letter keys as shown below. (Max. of 24 characters.)

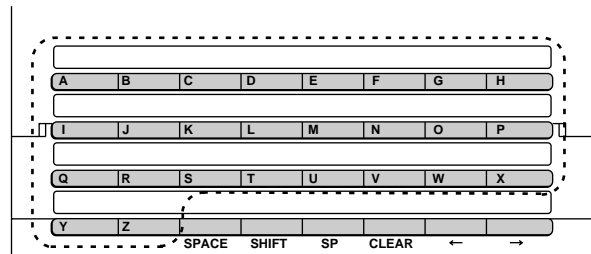

Example: SHARP =

- ◆ Press the **SPACE** key to enter a space. To change case, press the **SHIFT** key.
- ◆ To clear a mistake, press the **CLEAR** key.
- ◆ To enter a number as part of a name, press the appropriate numeric key. To select one of the following special symbols, press the **SP** key one or more times: !"#%&'()*+,-/;<=>?[¥]^_`{|}~→←@. At the end of the symbol list, characters particular to the language used in the display will appear.

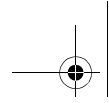

Entering Your Name and Fax Number

1. Installation

- 6** Press the **START** key.

The display will show:

4:DATE & TIME SET MODE
PRESS START KEY



- 7** Press the **STOP** key twice to return to the date and time display.

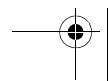
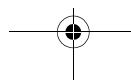
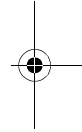
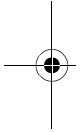

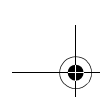

Setting the Date and Time

Setting the Date and Time

The date and time appear in the display, in reports, and at the top of each page you transmit. Set the date and time by pressing the keys on the operation panel as shown below.

Note: Make sure the display shows the date and time before beginning a programming operation. If the display shows the telephone line status, press the **CHANGEOVER** key to switch to the date and time.

1 Press these keys:

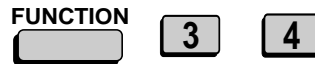

The display will show:

4:DATE&TIME SET MODE
DATE 06-08-1999

(Note: the currently set date will appear to the right of "DATE")

2 Enter a two-digit number for the day ("01" to "31").



- To correct a mistake, press the **STOP** key to move the cursor back to the mistake and then enter the correct number.

Example: the 5th

3 Enter a two-digit number for the month ("01" for January, "02" for February, "12" for December, etc.).



Example: January

4 Enter the year (four digits).



Example: 1999

Setting the Date and Time

1. Installation

- 5** Enter a two-digit number for the hour (“00” to “23”) and a two-digit number for the minute (“00” to “59”).



Example: 9:25

- 6** Press the **START** key to start the clock.



- 7** Press the **STOP** key twice to return to the date and time display.

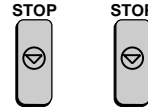

Note: This fax machine is Year 2000 compliant.

Volume Adjustment

Volume Adjustment

You can adjust the volume of the speaker and ringer using the **UP** and **DOWN** keys.

Speaker

-
- 1** Press the **SPEAKER** key.

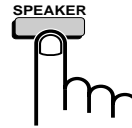

-
- 2** Press the **UP** or **DOWN** key.

Display:

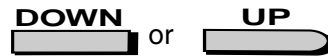

SPEAKER VOLUME
HIGH



SPEAKER VOLUME
MIDDLE



SPEAKER VOLUME
LOW

-
- 3** When the display shows the desired volume level, press the **SPEAKER** key to turn off the speaker.

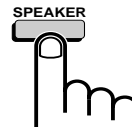

Ringer

1 Press the **UP** or **DOWN** key. (Make sure the **SPEAKER** key has not been pressed.)

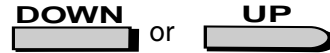

- The ringer will ring once at the selected level, then the date and time will reappear in the display.

Display:

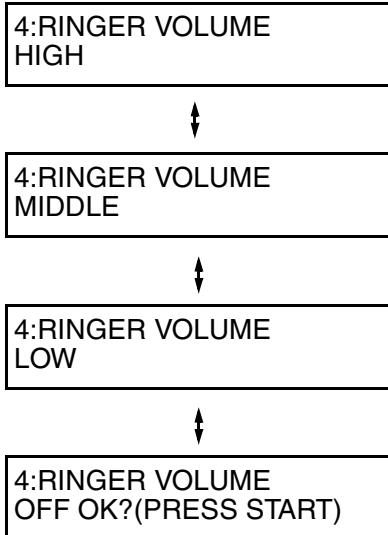

2 If you selected RINGER OFF: OK?, press the **START** key.



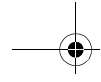

2. Sending Documents

Transmittable Documents

Size and weight

The size and weight of documents that you can load in the document feeder depend on whether you load one page at a time or several pages at once.

Loading one page at a time:

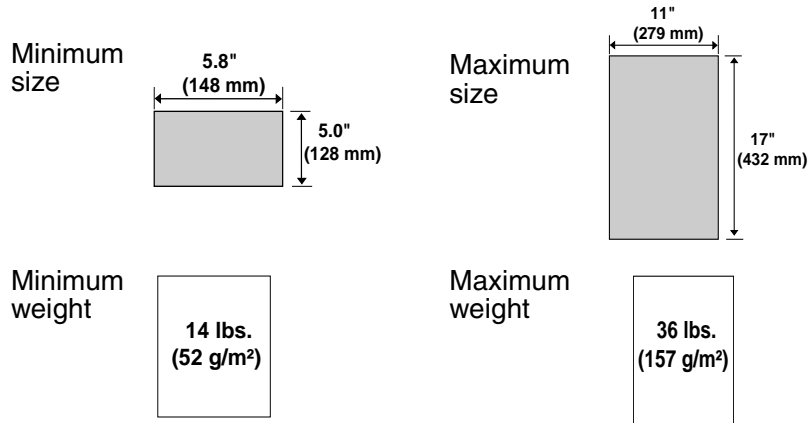

Loading several pages at once:

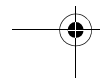
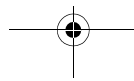
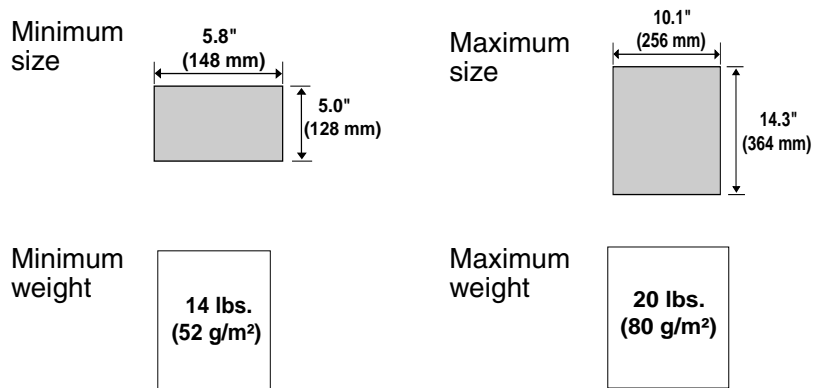

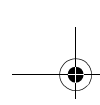

Transmittable Documents

Maximum scanning area

The area of the document that the fax machine can scan is slightly smaller than the actual document size. Any letters or graphics outside this area will not be scanned.

Maximum scanning width: 210 mm

Maximum scanning length: The length of the document minus 4 mm from the top and bottom of the document.



Other restrictions

- ◆ The scanner cannot recognise yellow, greenish yellow, or light blue ink.
- ◆ Ink, glue, and correcting fluid on documents must be dry before they pass through the document feeder.
- ◆ All clips, staples, and pins must be removed from documents before loading in the feeder. If these are not removed, they may damage the machine.
- ◆ Documents which are patched, taped, torn, smaller than the minimum size, carbon backed, easily smudged, or have a slippery coated surface should be photocopied, and the copy loaded in the feeder.

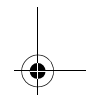
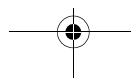
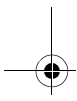
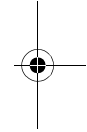
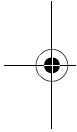

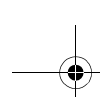

Loading the Document



Loading the Document

Up to 50 A4-sized pages (20 B4-sized pages) can be placed in the feeder at one time. The pages will automatically feed into the machine starting from the bottom page.

- ◆ If you need to send or copy more than 50 pages, place the additional pages gently and carefully in the feeder just before the last page is scanned. Do not try to force them in, as this may cause double-feeding or jamming.
- ◆ If your document consists of several large or thick pages which must be loaded one at a time, insert each page into the feeder as the previous page is being scanned. Insert gently to prevent double-feeding.

-
- 1** Adjust the document guides to the width of your document.

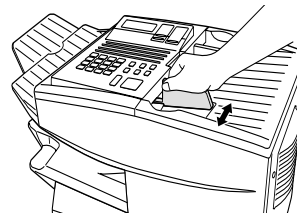

-
- 2** Place the document face down and push it gently into the document feeder. The top edge of the document should enter the machine first.

- The feeder will draw the leading edge of the document into the machine. SEND READY will appear in the display.

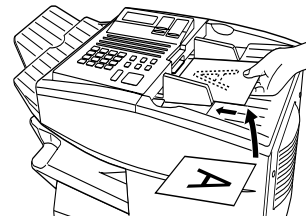

Note: When inserting a large number of pages in the feeder, slant the front end of the stack so that the bottom pages enter first.

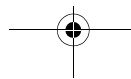
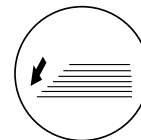

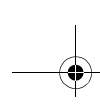

- Adjust the resolution and/or contrast settings (if desired) and then dial the receiving machine as explained in the following sections.



Adjusting the Resolution and Contrast

If desired, you can adjust the resolution and contrast before sending a document.

Resolution

The fax machine has four resolution settings:

STANDARD	Use STANDARD for ordinary documents. This setting gives you the fastest and most economical transmission.
FINE	Use FINE for documents containing small letters or fine drawings.
SUPER FINE	Use SUPER FINE for documents containing very small letters or very fine drawings.
HALF TONE	Use HALF TONE for photographs and illustrations. The original will be reproduced in 64 shades of grey.

The default resolution setting is STANDARD. If you don't adjust the resolution before sending a document, the fax machine will automatically use STANDARD resolution.

- ◆ In order to transmit in FINE or SUPER FINE resolution, the receiving fax machine must also have that resolution. If it doesn't, the next best available setting will be used.
- ◆ The resolution settings are only effective for transmitting and copying a document. They are not effective for receiving a document.

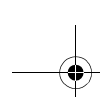

Adjusting the Resolution and Contrast

To adjust the resolution setting, press the **RESOLUTION** key one or more times until the indicator light next to the desired setting comes on.

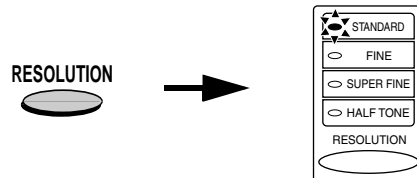

Contrast

The fax machine has three contrast settings:

- | | |
|-------|---|
| AUTO | Use AUTO for normal documents. |
| DARK | Use DARK for faint documents. |
| LIGHT | Use LIGHT for documents with a dark background. |

The default setting is AUTO.

To adjust the contrast, flip up the Rapid Key overlay (if necessary) and press the **CONTRAST** key until the desired setting appears in the display.

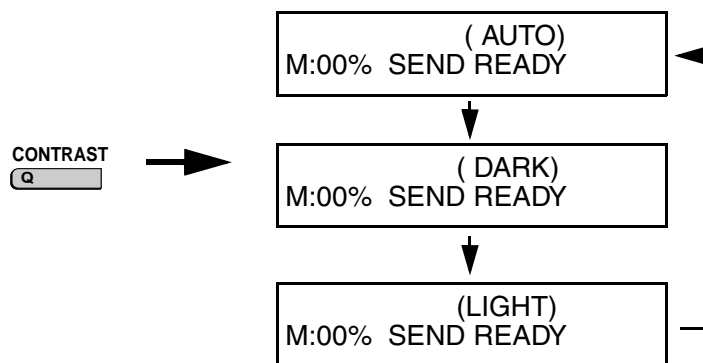

Sending a Fax by Normal Dialling

Sending a Fax by Normal Dialling

With Normal Dialling, you press the **SPEAKER** key and then dial by pressing the numeric keys.

- ◆ Normal Dialling allows you to listen to the line through the speaker to make sure the other fax machine is responding. (Note that the speaker is not a speakerphone; it cannot be used for talking.)
- ◆ If you have connected an extension telephone to the fax machine, you can also pick up the extension phone and dial using the extension phone (do not press the **SPEAKER** key on the fax machine). If a person answers, you will be able to speak to them through the phone before sending a fax.

Note: If you press the **SPEAKER** key to dial, you will not be able to speak using an extension phone connect to the fax machine in the event that a person answers.

-
- 1** Load the document(s). (Note: If desired, you can load the document after dialling in Step 3, below.)
- SEND READY will appear in the display.
 - Set the resolution and/or contrast if desired.

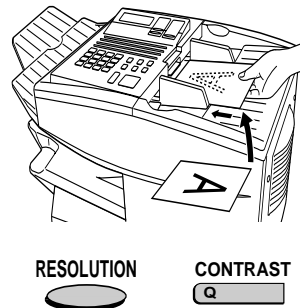





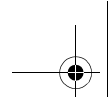

-
- 2** Press the **SPEAKER** key or pick up an extension phone connected to the fax machine. Listen for the dial tone.





Sending a Fax by Normal Dialling



- 3** If you pressed the **SPEAKER** key, dial the number of the receiving machine by pressing the numeric keys on the fax machine.        (Example)

If you are using an extension phone, dial using the keypad on the extension phone.

- 4** Wait for the connection. When you hear a fax tone, press the **START** key on the fax machine.

- If a person answers and you are using an extension phone, ask them to press their Start key. When you hear the fax tone, press the **START** key on your fax machine.

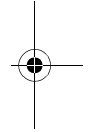
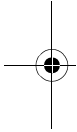

Using the **REDIAL** key

You can press the **REDIAL** key to redial the last number dialled. To send a document, press the **START** key when you hear the fax tone after the connection is made. Note that the speaker is automatically activated when you press the **REDIAL** key.

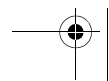
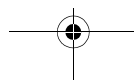

Programming Auto-Dial Numbers

You can dial a fax number by simply pressing a Rapid Key, or by pressing the **SPEED DIAL** key and entering an abbreviated Speed Dial number.

To use a Rapid Key or Speed Dial number, you must first program the full fax number in the Rapid Key or Speed Dial number. It is usually convenient to program your most frequently dialled numbers in Rapid Keys.

- ◆ Forty-eight Rapid Keys are available. Rapid Dial Keys also allow you to program a backup fax number, which is automatically dialled if the first fax number is busy.
- ◆ Seventy-five Speed Dial numbers are available on the FO-4700, and one hundred Speed Dial numbers are available on the FO-5700.

- 1** Press these keys:



The display will show:

3:ENTRY MODE
ENTER #(1-9,*,#)

- 2** Press the **1** key.



The display will show:

1:FAX/TEL. # MODE
1=SET, 2=CLEAR

- 3** Press the **1** key to select SET.



Programming Auto-Dial Numbers

- 4** To program a Rapid Key number, press a Rapid Key (to select Rapid Keys 33 through 48, flip up the Rapid Key overlay).

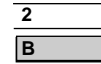

Example: Rapid Key 2

To program a Speed Dial number, press the **SPEED DIAL** key and then enter a number from “1” to “75” on the FO-4700, or “1” to “100” on the FO-5700. (If you enter less than two digits on the FO-4700, or three digits on the FO-5700, press the **START** key to complete the entry.)

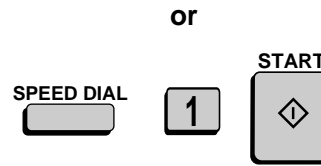

Speed Dial 1

- 5** Enter the fax number by pressing the numeric keys (max. of 34 digits including pauses).



(Example)

- To clear a mistake, press the **CLEAR** key.
- If a pause is required between any of the digits to access a special service or an outside line, press the **REDIAL** key (two seconds per pause). The pause will appear as a hyphen. Several pauses can be entered in a row.

- 6** Press the **START** key.



Programming Auto-Dial Numbers

7 Enter the name of the party by pressing the letter entry keys (max. of 20 characters). (Make sure the Rapid Key overlay is flipped down.)



Example: SHARP

- If you don't want to enter a name, go directly to Step 8.

2. Sending Documents

8 Press the **START** key.



9 Press **1** if the number programmed is an area code or access code to be used for Chain Dialling (see *Chain Dialling* at the end of this procedure). Press **2** (or **START**) if the number is a regular fax number.

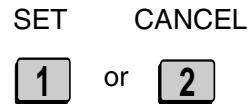

- If you pressed **1** or are programming a Speed Dial number, go to Step 14. (Note: A backup fax number cannot be entered in a Rapid Key used for Chain Dialling.)

10 Enter a backup fax number to be dialled if the first number is busy. (If you don't want to enter a backup number, go directly to Step 13.)



(Example)

11 Press the **START** key.



Programming Auto-Dial Numbers

- 12** Enter a name for the backup fax number. (If you don't want to enter a name, go directly to Step 13.)



Example: SHARP2

- 13** Press the **START** key.



- 14** Return to Step 4 to program another number, or press the **STOP** key repeatedly to return to the date and time display.

Step 4 or



- If you programmed a Rapid Key number, you can write the name of the party on the label above the Rapid Key.

Chain Dialing for area and access codes

You can also program an area code or access code in a Rapid Key or Speed Dial number using the above programming procedure. In Step 9, press **1** to set the number as a Chain Dialling number.

After you dial an area code or access code using a Rapid Key or Speed Dial number set for Chain Dialling, the fax machine will wait for you to dial the remainder of the number (you can dial the remainder of the number by pressing a Rapid Key, by pressing the Speed Dial key and entering a Speed Dial number, or by pressing numeric keys). Note that the remainder of the number should **not be set** as a Chain Dial number if programmed in a Rapid Key or Speed Dial number.

- ◆ The maximum number of digits that can be dialled at one time by Chain Dialling is 50.

Programming Auto-Dial Numbers

Clearing auto-dial numbers

Note: You cannot clear a number if it is used in a program or timer operation, if it is used to specify the relay fax machine in a relay group, or if it is included in a Group Key. First clear the number from the operation or group, then perform the following clearing procedure. To check where the number is used, print out the Program/Group List, the Timer List, and/or the Relay Group List as explained in Chapter 7.



1 Press these keys:

The display will show:

1:FAX/TEL. # MODE
1=SET, 2=CLEAR

FUNCTION

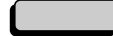

2 Press **2** to select CLEAR.



3 To clear a Rapid Key, press the Rapid Key.

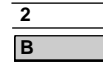

To clear a Speed Dial number, press the **SPEED DIAL** key and then enter the number with the numeric keys. (If you enter less than 2 digits on the FO-4700, or 3 digits on the FO-5700, press the **START** key to complete the entry.)

Example: Rapid Key 2

4 Press the **START** key.



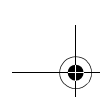

Programming Auto-Dial Numbers



- 5** Return to Step 3 to clear another number, or press the **STOP** key repeatedly to return to the date and time display.

Step 4 or



Making changes

To make changes in a number previously stored, repeat the programming procedure. Select the Rapid Key or Speed Dial number for which you want to make changes in Step 4, and then change the number(s) and/or name(s) when they appear in the display (Steps 5, 7, 10 and 12).

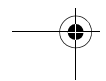
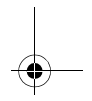
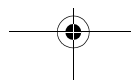
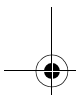
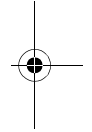
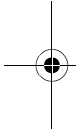

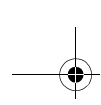

Sending a Fax by Automatic Dialling

Dual Access

The fax machine features full dual access, which means that you can load a document and dial by automatic dialling even when the fax machine is occupied with another operation. After you dial, your document will be immediately scanned into memory and then transmitted once all previously set operations have been completed.

If more than one document has been scanned into memory for transmission, the documents will be transmitted in the order in which they were scanned. If you have an urgent transmission and do not want to wait until previously scanned documents are transmitted, you can press the **PRIORITY** key after loading your document. Your document will be transmitted immediately after the current document has completed transmission.

If you don't want the document to be transmitted from memory, you can press the **DOCUMENT** key after loading the document. In this case, the document will not be scanned until all previously set operations are completed and the connection to the receiving party is established. (To transmit the document ahead of any documents waiting in memory for transmission, press the **PRIORITY** key.)

- ◆ The fax machine can hold approximately 56 pages of average content in memory when Option Setting 9, Error Correction Mode, is turned off. Less pages can be held if any were scanned using fine or halftone resolution, or when Option Setting 9 is turned on.
- ◆ The amount of memory currently occupied appears as a percentage ("M:00%") in the display.

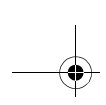

Sending a Fax by Automatic Dialling



If the memory becomes full...

If the memory becomes full while a document is being scanned, MEMORY FULL will appear in the display. If Option Setting 23 (Quick On-line) is set to YES, scanning will automatically resume when memory becomes free again as pages are transmitted. (Note: Quick On-Line is initially set to YES at the factory. To change the setting, see Chapter 6, *Optional Settings*.)

If Quick On-Line is set to NO, MEMORY FULL ERROR will appear in the display. Press the **START** key or the **STOP** key as follows:

- ◆ Press the **START** key if you want to transmit the pages which have been stored up to that point in memory. The remaining pages will be ejected from the feeder. After transmission, the memory will be cleared and you can transmit the remaining pages. You will also need to transmit the page which was being scanned when the memory filled up.
- ◆ Press the **STOP** key if you want to cancel the entire transmission.

If you do not press the **START** key or the **STOP** key within one minute, the transmission will be cancelled and the pages already scanned cleared from memory. You will need to retransmit all pages of the document.

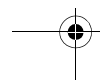
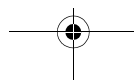
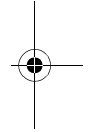
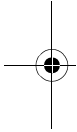

Sending a Fax by Automatic Dialling

Rapid Key Dialling

If the number you want to dial has been programmed in a Rapid Key, you can dial it by pressing the Rapid Key.

2. Sending Documents

1 Load the document(s).

SEND READY will appear in the display.

- Set the resolution and/or contrast if desired.
- To send the document ahead of other documents waiting for transmission, press the **PRIORITY** key.
- To send the document directly from the feeder (not through memory), press the **DOCUMENT** key.

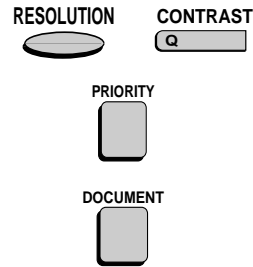
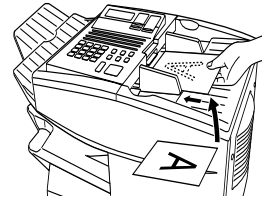

2 Press the appropriate Rapid Key.

- The name of the receiving party will appear in the display. If no name was stored, the fax number will appear. (If the name or number is incorrect, press the **STOP** key.)
- The document will be automatically transmitted once the connection is established.



Example: Rapid Key 2

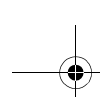

Sending a Fax by Automatic Dialling

Speed Dialling

If the number you want to dial has been programmed in a Speed Dial number, you can dial it by pressing the **SPEED DIAL** key and then entering the Speed Dial number.

1 Load the document(s).

SEND READY will appear in the display.

- Set the resolution and/or contrast if desired.
- To send the document ahead of other documents waiting for transmission, press the **PRIORITY** key.
- To send the document directly from the feeder (not through memory), press the **DOCUMENT** key.

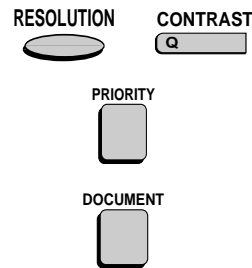
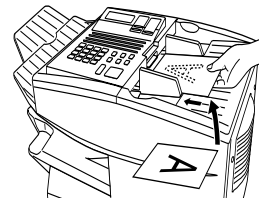

2 Press the **SPEED DIAL** key and then enter the Speed Dial number by pressing the numeric keys.

- If you enter less than 2 digits for the Speed Dial number on the FO-4700, or 3 digits on the FO-5700, press the **START** key to complete the entry.



Example: Speed Dial 1

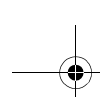

Sending a Fax by Automatic Dialling

- 3** Check the display. If the name or number shown is correct, press the **START** key. (If not, press the **STOP** key and then repeat Step 2.)



Direct Keypad Dialling

You can also enter a full number with the number keys and then press the **START** key to begin dialling.

- 1** Load the document(s). (Note: If desired, you can load the document after dialling in Step 2, below.)

SEND READY will appear in the display.

- Set the resolution and/or contrast if desired.
- To send the document ahead of other documents waiting for transmission, press the **PRIORITY** key.
- To send the document directly from the feeder (not through memory), press the **DOCUMENT** key.

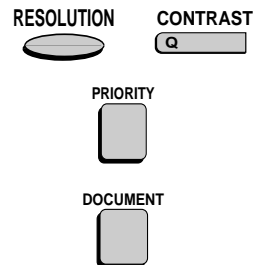

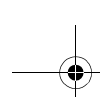

Sending a Fax by Automatic Dialling



- 2** Enter the number of the receiving machine by pressing the numeric keys.



(Example)

- If a pause is required between any of the digits to access a special service or an outside line, press the **REDIAL** key. The pause will appear as a hyphen. Several pauses can be entered in a row.

- 3** Check the display. If the number of the receiving machine shown is correct, press the **START** key.



- If it is not correct, press the **STOP** key to backspace and clear one digit at a time, and then re-enter the correct digit(s).

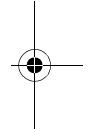
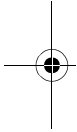

Searching for an auto-dial number

If you don't remember the Rapid Key or Speed Dial number in which you have programmed a particular fax number, you can search for the number by following the steps below. Once you have found the number, you can dial it and transmit the loaded document by simply pressing the **START** key.

Note: Only names programmed for auto-dial numbers will appear when you search; the full numbers themselves will not appear. You cannot search for a number if a name has not been associated with it.

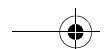

Sending a Fax by Automatic Dialling

1 Load the document(s).

SEND READY will appear in the display.

- Set the resolution and/or contrast if desired.

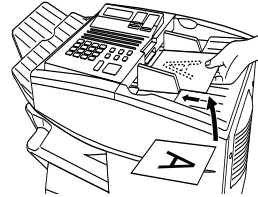

RESOLUTION



CONTRAST



2 Press the **SEARCH DIAL** key (flip up the Rapid Key overlay).



3 Enter the first letter of the stored name by pressing the appropriate letter entry key.



- If you don't remember the first letter, go to Step 4 (you will scroll through the list from the beginning).

Example: A

4 Press either arrow key to scroll through the names. Stop when the desired name appears in the display.

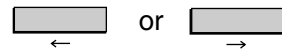

- If no numbers have been stored under the entered letter or you have reached the end of the list, NOT FOUND will appear.

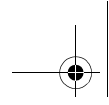

Sending a Fax by Automatic Dialling



- 5** Press the **START** key. The document will be automatically transmitted once the connection is established.



Chain Dialling

An auto-dial number set for Chain Dialling can be combined with another auto-dial number or digits entered manually with the numeric keys to dial one phone number up to 50 digits long. The following are some examples of how this can be done:

- ◆ Press appropriate Rapid Keys in the proper order. For example, press Rapid Key 01 (set for Chain Dialling), then Rapid Key 02 (not set for Chain Dialling).
- ◆ Press a Rapid Key (set for Chain Dialling) and then manually enter a number by pressing appropriate numeric keys. Press the **START** key after the final numeric key to begin transmission.

Checking the telephone line status

The display normally shows the date and time and prompts related to operations you are performing. To check and see what number the fax machine is currently calling or transmitting to, or what number the fax machine is currently receiving a document from (if this information is available), press the **CHANGEOVER** key. Information on the current call will appear in the display. To switch back to the date and time display, press the **CHANGEOVER** key again.

To cancel a fax transmission or reception

To cancel a fax transmission or reception which is currently in progress, press the **CHANGEOVER** key so that the status of the transmission or reception appears in the display, and then press the **STOP** key.

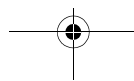

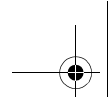

Sending a Fax by Automatic Dialling

Automatic redialling

If you use automatic dialling (including Direct Keypad Dialling) and the line is busy, the fax machine will automatically redial the number. The fax machine is set at the factory to make 2 redialling attempts at intervals of 5 minutes.

To stop automatic redialling, press the **CHANGEOVER** key to show the telephone line status in the display (make sure that **RECALL MODE** appears on the top line of the display and the number of the receiving party appears on the bottom line to the right), and then press the **STOP** key.

2. Sending Documents

Memory Retransmission

If a line error or power failure occurs during any type of memory transmission, your fax will automatically redial the number and attempt to complete the transmission. Retransmission will begin from the page which was being transmitted when the error occurred.

The fax machine will make 2 attempts at retransmission at an interval of 5 minutes.

- ◆ To stop retransmission, press the **CHANGEOVER** key to show the telephone line status in the display (make sure that **RETRY MODE** appears on the top line of the display and the number of the receiving party appears on the bottom line to the right), and then press the **STOP** key.
- ◆ The numbering of pages retransmitted will begin from "1" again.
- ◆ If an error or power failure occurs during transmission of a cover sheet, retransmission will not take place.

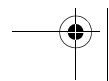
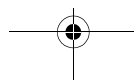
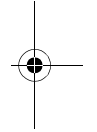
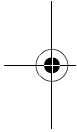

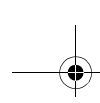

Sending a Fax by Automatic Dialling

Checking documents in memory

To display information on documents that are waiting in memory for transmission, follow the steps below. You can also cancel a transmission with this procedure.

- 1 Press the **MEM. STATUS** key (flip up the Rapid Key overlay) and then **2**.



TX STATUS will appear in the display.

- 2 Press the **#** key or the ***** key to scroll through the list of transmissions. The name (or number) of each receiving party will appear in the display, together with the 3-digit memory number assigned to the transmission. To cancel a transmission, press the **CLEAR** key and then the **START** key while the transmission appears in the display.



or



- 3 When you have finished checking the list, press the **STOP** key twice to return to the date and time display.



Note: To print out a list of the documents waiting in memory for transmission, press the **MEM. STATUS** key and then the **5** key.

Sending a Fax by Automatic Dialling

To cancel a memory transmission

If you know the memory number assigned to a memory transmission, you can cancel it with the following procedure. (If you don't know the memory number, use the preceding procedure.)

2. Sending Documents

- 1 Press the **MEM. STATUS** key (flip up the Rapid Key overlay) and then **4**.



The display will show:

4:MESSAGE CLEAR
ENTER MESSAGE #

- 2 Enter the 3-digit memory number assigned to the transmission you want to cancel.



(Example)

- 3 Press the **START** key to cancel the transmission.



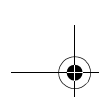

Cover Sheet



Cover Sheet

You can have the fax machine generate a cover sheet and send it as the last page of your fax transmission. The cover sheet includes the date and time, the receiver's name and number if a Rapid Key or Speed Dial number is used, the sender's name and number, and the total number of pages.

- ◆ Your name and number must be programmed in order for them to appear on the cover sheet. (See *Entering Your Name and Fax Number* in Chapter 1.)
- ◆ To have the recipient's name appear, you must use a Rapid Key or Speed Dial number with the name programmed.
- ◆ Cover Sheet cannot be selected when you use the Relay Request function.

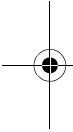

AUTOMATIC COVER SHEET	
DATE:	08-AUG-99 THU 11:48
TO:	N. T. BANK
FAX NO.:	4525558865
FROM:	John Doe Corp.
FAX NO.:	2015551254
02 PAGES WERE SENT (INCLUDING THIS COVER PAGE)	

(Example)

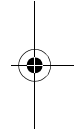

1 Load the document(s).

SEND READY will appear in the display.

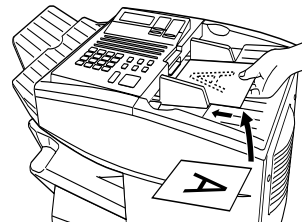

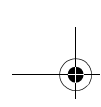

Cover Sheet

2 Press the **COVER SHEET** key.

- The display will briefly show **COVER SHEET MODE ENTERED** and then revert to **SEND READY**.
- To cancel the cover sheet selection, press the **STOP** key.

COVER SHEET
Y



3 Dial the receiving party and transmit the fax.

If desired, you can set your fax to automatically send a cover sheet with every transmission (you do not have to press the **COVER SHEET** key each time). This is accomplished by setting Option Setting 10 (Auto Cover Sheet) to YES as explained in Chapter 6, *Optional Settings*.

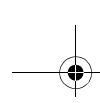

Batch Page Numbering

Batch Page Numbering

You can change the page numbering of the transmitted document from simple numbering ("P.01", "P.02", etc.) to batch numbering, which means that a slash and the total number of pages being sent are added after each page number (for example, "P. 01/05", "P.02/05", etc.). This allows the receiver to check for missing pages.

1 Load the document(s).

SEND READY will appear in the display.

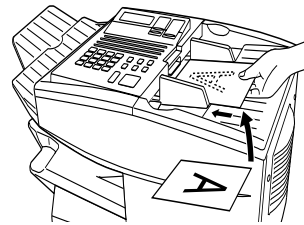

2 Press the **PAGE COUNTER** key.

The display will show:

PAGE COUNTER
R

ENTER # OF PAGE(S)
ENTER # (01-99)

3 Enter the total number of pages ("01" to "99") by pressing the numeric keys.

- If you are sending a cover sheet, do not include it in the total number of pages (the number will be adjusted automatically).

0 8

Example: 8 pages

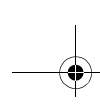

Batch Page Numbering

-
- 4** Dial the receiving machine and transmit the document.

Comments:

- ◆ If you need to cancel a batch number entry, remove the document from the feeder or press the **STOP** key.
- ◆ If the number of pages actually transmitted does not coincide with the batch number entered, the alarm will sound and PAGE COUNT ERROR will appear in the display. PAGE E. will also appear in the NOTE column of the Transaction Report if printed.

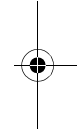
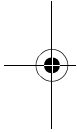

3. Receiving Documents

The fax machine has two modes for receiving calls:

AUTO mode:

Select this mode when you only want to receive faxes on the line connected to the fax machine. The fax machine will answer all calls automatically and receive incoming faxes.

MANUAL mode:

Select this mode when you have an extension phone connected to the same line as the fax machine and you want to receive both faxes and voice calls. **All calls, including faxes, must be answered by picking up the extension phone.**

Setting the reception mode

1 Press these keys:



The display will show:

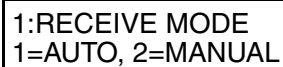

1:RECEIVE MODE
1=AUTO, 2=MANUAL

2 Press the **1** key to select AUTO, or the **2** key to select MANUAL.

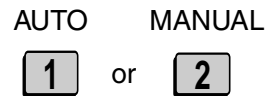

Using AUTO Reception Mode

In AUTO reception mode, the fax machine automatically answers all calls on two rings and receives incoming faxes.

- ◆ You can change the number of rings on which the machine answers calls by changing Option Setting 2. (See Chapter 6, *Optional Settings*.)
- ◆ If you pick up an extension phone before the fax machine answers, you can talk to the other party and/or receive a fax as explained below in *Using MANUAL Reception Mode*.

Using MANUAL Reception Mode

- 1** When the fax machine rings, answer the call on an extension phone connected to the same line.

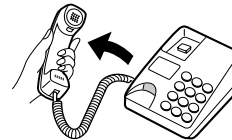

- 2** If you hear a fax tone, press **5**, *****, and ***** on the telephone keypad, or press the **START** key on the fax machine.



or

- If the other party first speaks with you, press the **START** key after speaking. (Press your **START** key before the sender presses their Start key.)



- 3** When RECEIVING appears in the display, hang up.

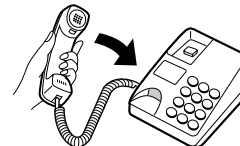

Note: In New Zealand, not all standard telephones will respond to incoming ringing when connected to the extension socket of the equipment.

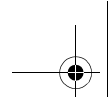

Substitute Reception to Memory



Substitute Reception to Memory

If the fax machine runs out of paper, toner, or the paper jams, incoming documents will be automatically stored in memory.

When you have received a document in memory, FAX RCVD IN MEMORY will appear in the display, alternating with NO PAPER, REPLACE TONER, or PAPER JAM. When you add paper, replace the toner cartridge, or clear the jam, the stored documents will automatically print out.

You can display information on the documents received to memory by following these steps:

-
- 1** Press the **MEM. STATUS** key (flip up the Rapid Key overlay) and the **3** key.



RX STATUS will appear in the display.

-
- 2** Press the **#** key or the *** (star)** key to scroll through the list of received documents. The name (or number) of the sender of each document will successively appear in the display.



or



-
- 3** When you have finished checking the list, press the **STOP** key twice to return to the date and time display.

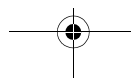

4. Making Copies

Your fax machine can also be used to make copies. Single and multiple copies (up to 99 per original) can be made, enabling the fax machine to double as an office copier.

- ◆ You can perform all steps of a copy operation even when the fax machine is busy printing other copy jobs, or when it is printing a received document after the line has been disconnected. Your copy job will be automatically stored in memory and then printed when all previous printing jobs are completed.
- ◆ The default resolution for copying is FINE. If desired, you can change the default resolution to SUPER FINE by changing Option Setting 32 (see Chapter 6, *Optional Settings*).

1 Load the document.

- SEND READY will appear in the display.
- If desired, adjust the resolution and/or contrast.



RESOLUTION



CONTRAST



2 Press the COPY key.

The display will show:

COPY MODE	
ENTER #(01-99)	01



- If you are only making a single copy of the original (or of each original), press the **START** key. Copying will begin.

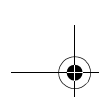

Making Copies



3 Enter the desired number of copies per original with the numeric keys.



- If the desired number of copies is from 1 to 9, enter “0” first.
- The display will show:

Example: Three copies per original

MULTI/SORT COPY MODE
1=MULTI, 2=SORT

4 Press **1** (MULTI) if you do not want the copies sorted, or **2** (SORT) if you want the copies sorted.

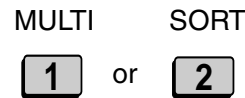

- Copying will begin.

Example of three copies each of three originals

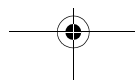
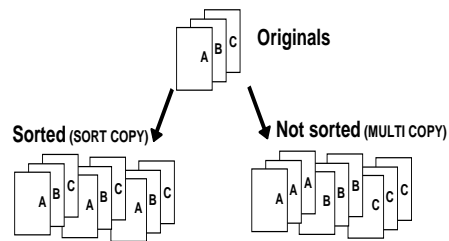

Checking copy jobs in memory

You can display the status of copy jobs in memory by following the steps below. You can also cancel copy jobs with this procedure.

- 1** Press the **MEM. STATUS** key (flip up the Rapid Key overlay) and then the **1** key.



COPY STATUS will appear in the display.

- 2** Press the **#** key or the ***** key to scroll through the list of copy jobs. The time the original was scanned into memory will appear in the display, together with the 3-digit memory number assigned to the job. To cancel a copy job, press the **CLEAR** key and then the **START** key while the copy job appears in the display.

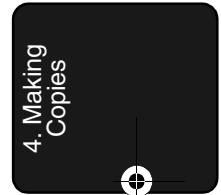
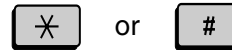

- 3** When you have finished checking the list, press the **STOP** key twice to return to the date and time display.



5. Special Functions

Broadcasting

The Broadcasting function allows you to send the same document to multiple locations with just one operation. First load the document, then enter the numbers of the receiving machines. The document will be automatically transmitted to each location.

1 Load the document (s).

- SEND READY will appear in the display.

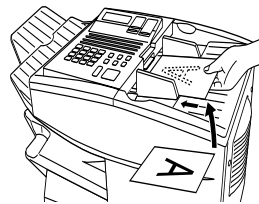

2 Press the **BROADCAST** key.

The display will show:

BROADCAST MODE
ENTER STATION #

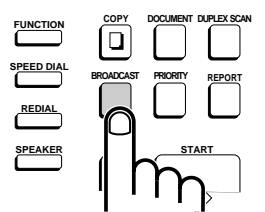

3 Dial the receiving machines using one or more of the following methods:

- Press one or more Rapid Keys.
- Enter one or more Speed Dial numbers, pressing the **SPEED DIAL** key before each number. (If you enter less than 2 digits for a number on the FO-4700, or 3 digits on the FO-5700, press the **START** key to complete the entry.)

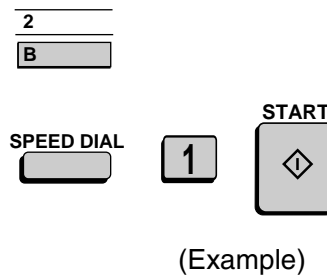

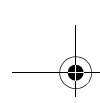

Broadcasting

- Enter one or more full fax numbers (max. of 20) with the numeric keys, pressing the **START** key after each full number.
- Press one or more Group Keys. (See *Storing numbers in Group Keys* at the end of this section.)

4 Press the **START** key.

The display will show:

BROADCAST MODE
SELECT THE MODE



- If desired, adjust the resolution and/or contrast.

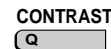

5 Press the **START** key twice. Transmission will begin.

- A Transaction Report is automatically printed out after Broadcasting is completed. Check the "Note" column of the report to see if any of the locations are marked "Busy" or have a communication error code. If so, send the document to those locations again.



Broadcasting

Broadcasting using a Group Key

If the fax machines to which you want to broadcast have all been programmed into one Group Key (see *Storing numbers in Group Keys* which follows), you can perform the broadcasting operation using the following simplified procedure:

1 Load the document(s).

- SEND READY will appear in the display.
- If desired, adjust the resolution and/or contrast.

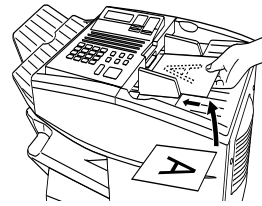

RESOLUTION



CONTRAST



2 Press the appropriate Group Key.
Transmission will begin.

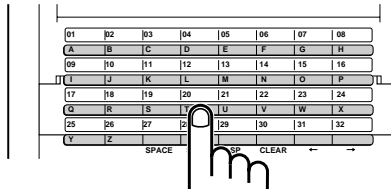

(Example)

Storing numbers in Group Keys

Group Keys allow you to dial a group of fax numbers by simply pressing the appropriate Group Key once. To store a group of numbers in a Group Key, follow the steps below.

- ◆ Any Rapid Key that is not already programmed as a Rapid Key or a Program Key can be used as a Group Key.
- ◆ Up to 122 numbers can be stored in one Group Key on the FO-4700, or 147 numbers on the FO-5700.
- ◆ Only Rapid Key and Speed Dial numbers (excluding numbers set for Chain Dialling) can be stored in a Group Key. Full numbers cannot be stored.

1 Press these keys.

The display will show:

2:GROUP ENTRY MODE
1=SET, 2=CLEAR



5. Special Functions

2 Press **1** (SET) to program a Group Key, or **2** (CLEAR) to clear a Group Key.

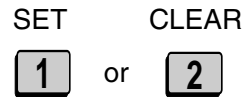

3 Press any Rapid Key not already programmed to select it as a Group Key.

If you are clearing a Group Key, press it and go to Step 5.

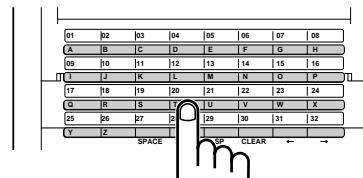

(Example)

Broadcasting

- 4** Enter fax numbers using one or both of the following methods:

- Press one or more Rapid Keys.



- Enter one or more Speed Dial numbers with the numeric keys, pressing **SPEED DIAL** before each number (if you enter less than 2 digits for a number on the FO-4700, or 3 digits on the FO-5700, press **START** to complete the entry).



(Example)

- 5** Press the **START** key.



- 6** Return to Step 3 to program another Group Key, or press the **STOP** key repeatedly until you return to the date and time display.

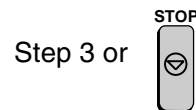

Editing a group

If necessary, you can add numbers to or delete numbers from group by repeating the programming procedure for the Group Key. Press **1** for SET in Step 2 and select the Group Key in Step 3. Add or delete numbers in Step 4. To add a number, press a Rapid Key or enter a Speed Dial number. To delete a number, move the cursor to the number with the **UP** or **DOWN** key and then press the **CLEAR** key.

Confidential Operations

The Confidential function can be used to transmit and receive confidential documents.

Confidential transmission

When you send a document using the Confidential function, the receiving machine holds it in memory instead of immediately printing it out. When the receiving party enters the correct passcode, the document is printed out.

- ◆ Confidential transmission is only possible when the receiving machine is a Sharp model with confidential reception capability.
- ◆ To use this function, your name and fax number (OWN PASS-CODE) must be entered in your fax machine as explained in Chapter 1.
- ◆ Some fax machines have multiple mailboxes for receiving confidential faxes. If you are sending to a machine with multiple confidential mailboxes, contact the receiving party in advance for the appropriate mailbox number.

1 Load the document (s).

- SEND READY will appear in the display.
- Set the resolution and/or contrast if desired.

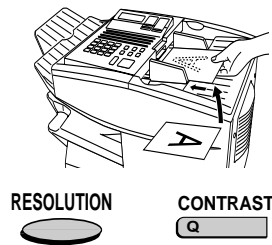

2 Press the **CONFIDENTIAL** key and then **1**. The display will show:



1:CONF. TX
ENTER BOX # OR START

Confidential Operations

- 3** If the receiving machine has multiple confidential mailboxes, enter the appropriate mailbox number with the numeric keys (this step is required for machines with multiple mailboxes).



(Example)

If the receiving machine doesn't have multiple mailboxes, go directly to Step 4.

- 4** Press the **START** key.



- 5** Dial the receiving machine using one of the following methods:

- Press a Rapid Key.
- Press the **SPEED DIAL** key and enter a Speed Dial number (if you enter less than 2 digits on the FO-4700, or 3 digits on the FO-5700, press the **START** key to complete the entry). Check the name or number that appears, and then press the **START** key.
- Enter a full telephone number with the numeric keys, and press the **START** key.

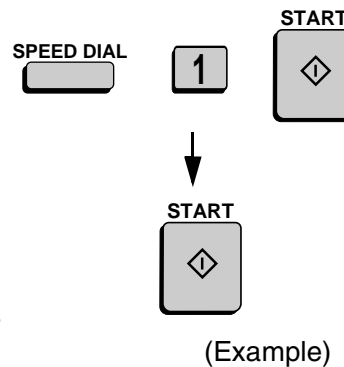

(Example)

Transmission will take place once the connection is established.

Confidential reception

When another fax machine sends you a document by confidential transmission, your fax machine holds it in memory instead of immediately printing it out. The document cannot be printed out until you enter the correct passcode.

Your fax has 10 "mailboxes" in which confidential documents can be received. Each mailbox has its own passcode, allowing up to 10 different people or groups to each receive their own confidential documents. The mailboxes are identified by 2-digit numbers.

Programming the confidential passcode

To receive a confidential document, you must first program a 2-digit mailbox number and a 4-digit passcode.

Note: Be sure to inform the transmitting party of your 2-digit mailbox number in advance. The transmitting party will need this number to send you confidential faxes.

-
- 1** Press the **CONFIDENTIAL** Key and then **3**.



The display will show:

3:CONF. CODE SET
ENTER BOX # (00-99)

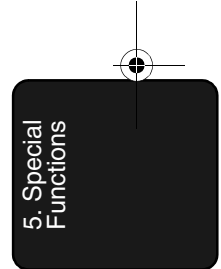

-
- 2** Enter a 2-digit number (from "00" to "99") by pressing the numeric keys. This number identifies the mailbox.



(Example)

Confidential Operations

- 3** Enter the 4-digit passcode with the numeric keys.



(Example)

- 4** Press the **START** key.



- 5** Enter a name for the mailbox by pressing the letter entry keys (make sure the Rapid Key overlay is down).

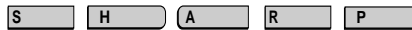

Example: SHARP

- 6** Press the **START** key.



Note: After entering the passcode, your fax will print it out for your records. If you forget the passcode and have kept no record, contact your Sharp dealer.

Clearing the passcode

- 1** Press the **CONFIDENTIAL** Key and then **4**.



The display will show:

4:CONF. CODE CLEAR
ENTER BOX # (00-99)

Confidential Operations

- 2** Enter the 2-digit number that identifies the mailbox you want to clear.

0 **1**

(Example)

- 3** Enter the 4-digit passcode of the mailbox with the numeric keys.

1 **0** **2** **3**

(Example)

- 4** Press the **START** key.



Printing out received documents

When you have received a confidential document, RCVD CONF. FAX will appear in the display. Print out the Confidential Reception List as explained in Chapter 6 to see which mailbox has received the document, and then follow the steps below to print out the document.

- 1** Press these keys:

CONFIDENTIAL
S

2

The display will show:

2:CONF. DATA PRINT
ENTER BOX # (00-99)

- 2** Enter your mailbox number.

0 **1**

(Example)

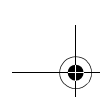

Confidential Operations



3 Enter your confidential passcode.



(Example)

4 Press the **START** key.

- Printing will begin. After printing, the document will be erased from memory.

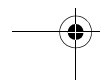
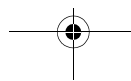
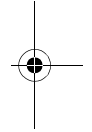
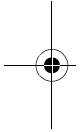

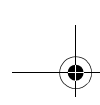

Relay Request

Relay Request allows you to send a document to another fax machine and have that fax machine in turn broadcast the document to a group of other fax machines. This function is useful when the relay fax machine is closer to the end fax machines than your fax machine, as it reduces telephone line costs.

Important:

Relay Request can only be used if the intermediate relay machine is a Sharp machine having the Relay Broadcast function.

Storing a relay group

To make a relay request, you must first store a relay group. This consists of the fax number of the intermediate relay machine and the fax numbers of the end receiving machines. Up to 10 different relay groups can be stored.

- ◆ Fax numbers of the end receiving machines can be entered as Rapid Key numbers, Speed Dial numbers, and/or Group Key numbers if they have been programmed as such **in the relay machine** (not in your fax machine). Check with the operator of the relay machine for these numbers.
- ◆ The total number of end receiving machines which can be entered varies with the model used as the intermediate relay machine. Check with the operator of the relay machine to find out how many receiving machines can be entered.
- ◆ A maximum of 400 digit spaces are available in your fax machine's memory for storing the numbers of end receiving machines. The number of spaces occupied by each number depends on what kind of number it is:

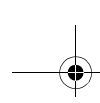

Relay Request

Rapid Key number	4 spaces
Speed Dial number	2 spaces
Group Key number	4 spaces (for one group)
Full number	Number of digits in number (max. of 30 per number)

- ◆ Only 2-digit Speed Dial numbers for end receiving machines can be entered in the relay group. If the receiving machine has 3-digit Speed Dial numbers that you want to enter, ask the operator of the relay machine to store them in a Group Key, and then enter the Group Key in the relay group.

-
- 1** Press the **RELAY** key and then **2**.



The display will show:

2:RELAY GROUP SET
ENTER #(01-10)

-
- 2** Enter a 2-digit number from “01” to “10”. This number identifies the relay group.



(Example)

-
- 3** Press the **START** key.



Relay Request

4 Enter the fax number of the relay machine using one of the following methods:

- Press a Rapid Key.
- Press the **SPEED DIAL** key and enter a Speed Dial number (if you enter less than 2 digits on the FO-4700, or 3 digits on the FO-5700, press the **START** key to complete the entry).
- Enter the full fax number with the numeric keys, and press the **START** key.

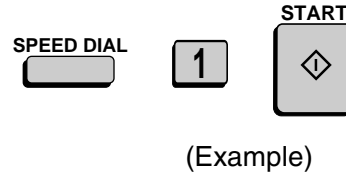

5 Press the **START** key.



6 Press numeric keys (not Rapid Keys) to enter Rapid Key numbers for the end receiving machines that are programmed in the relay machine.



If you don't want to enter Rapid Key numbers, go directly to Step 7.

Example: Rapid Keys 01 and 33

7 Press the **START** key.



5. Special Functions

Relay Request

- 8** Press numeric keys to enter Speed Dial numbers (2-digit numbers only) for the end receiving machines that are programmed in the relay machine.



Example: Speed Dial numbers 10 and 23

If you don't want to enter Speed Dial numbers, go directly to Step 9.

- 9** Press the **START** key.



- 10** Press numeric keys (not Group Keys) to enter Group Key numbers for end receiving machines that are programmed in the relay machine.



Example: Group Key 30

If you don't want to enter Group Key numbers, go directly to Step 11.

- 11** Press the **START** key.



- 12** Enter full fax numbers of the end receiving machines, pressing the **START** key after each fax number. Include the area code if the number is outside the local dialling area of the relay machine.



(Example)

- 13** When finished, press the **START** key.



-
- 13** Return to Step 2 to enter another relay group, or press **STOP** repeatedly to return to the date and time display.

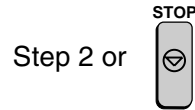

Clearing a relay group

To clear a relay group, you need to know the 2-digit number that identifies it. You can check the number by printing out the Relay Group List as explained in Chapter 7.

-
- 1** Press the **RELAY** key and then **3**.

The display will show:

3:RELAY GROUP CLEAR
ENTER # (01-10)



-
- 2** Enter the 2-digit number that identifies the group you want to clear.

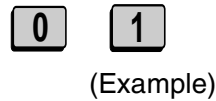

-
- 3** Press the **START** key.



-
- 4** Return to Step 2 to clear another relay group, or press **STOP** repeatedly to return to the date and time display.

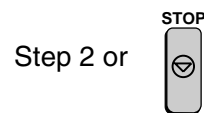

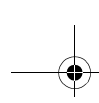

Relay Request



Requesting a relay transmission

Important:

To request a relay transmission, your fax number must be entered into the Relay Passcode List of the relay fax machine by the operator of that fax machine. (Your number must also be entered in your fax machine as explained in *Entering Your Name and Fax Number* in Chapter 1.)

- 1** Load the document(s).

SEND READY will appear in the display.

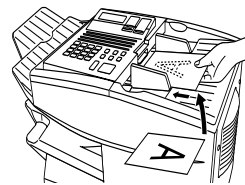

- 2** Press the **RELAY** key and then the **1** key.



1:RELAY TX
ENTER # (01-10)

- 3** Enter the 2-digit number of the relay group by pressing the numeric keys.



(Example)

- 4** Press the **START** key.

- Adjust the resolution and contrast if desired.

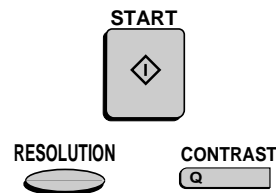

- 5** Press the **START** key.

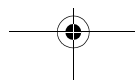

Relay Request

- 6** Press the **START** key to send the document through memory, or the **DOCUMENT** key to send the document directly from the feeder.

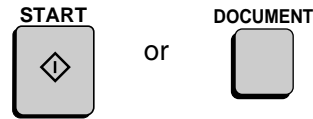

Relay Broadcast

The fax machine can also act as a relay station. It will receive a document from a fax machine requesting a relay transmission, and automatically broadcast it to the stations that the requesting machine specifies.

To enable a fax machine to request a relay transmission, you must first enter its fax number in the Relay Passcode List. Follow the steps below to enter or clear a fax number.

- ◆ When your fax receives a relay request from another fax machine, RCVD RELAY REQUEST will appear in the display.
- ◆ To clear a fax number from the Relay Passcode List, you need to know the 2-digit number which identifies it. You can check this number by printing out the Passcode List (see Chapter 7).

5. Special Functions

- 1** Press these keys:



The display will show:

4:RELAY PASSCODE
1=SET, 2=CLEAR

Relay Request

- 2** Press **1** to enter a number, or **2** to clear a number.

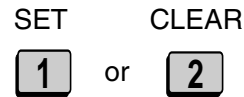

- 3** **Entering:** Enter a 2-digit number ("01" to "10"). This identifies the fax number you will enter in the next step.



(Example)

Clearing: Enter the 2-digit number that identifies the fax number you want to clear, and go to Step 5.

- 4** Enter the fax number of the machine to be added to the list (max. 20 digits).



(Example)

- 5** Press the **START** key.



- 6** Return to Step 3 to enter or clear another number, or press the **STOP** key repeatedly to return to the date and time display.

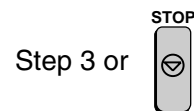

Polling

Polling allows you to call another fax machine and have it send a document to your machine without operator assistance. In other words, the receiving fax machine, not the transmitting fax machine, initiates the transmission. You can use your fax machine to both poll and be polled by others.

Polling others

To poll another fax machine, follow the steps below.

- ◆ If desired, you can dial more than one fax number to receive documents consecutively from a group of fax machines (this is called "Serial Polling").

- 1 Press the **FUNCTION** key and **8**.

The display will show:

8:SERIAL POLL. MODE
ENTER STATION #

FUNCTION

8

5. Special Functions

- 2 Dial the number(s) of the fax machine(s) you want to poll using one (or more) of the following methods:

- Press one or more Rapid Keys.
- Enter one or more Speed Dial numbers, pressing the **SPEED DIAL** key before each number. (If you enter less than 2 digits on the FO-4700, or 3 digits on the FO-5700, press the **START** key to complete the entry.)

SPEED DIAL

1

START

(Example)

- Press one or more Group Keys.

Polling

- Enter one or more full fax numbers with the numeric keys, pressing the **START** key after each full number.

- 3** Press the **START** key. Reception will begin.



Serial Polling using a Group Key

If the fax machines you want to poll have all been programmed into one Group Key, you can poll them by simply pressing that Group Key. (The procedure for programming Group Keys is explained in *Broadcasting* in this chapter.)

- ◆ Make sure no documents are in the feeder before you press the Group Key.

Being polled (Memory polling)

To let another fax machine poll your fax machine, you must first store the document(s) in memory using the following procedure.

Transmission will take place when the other fax machine calls your fax machine and activates polling. You can choose whether to allow polling only once, or an unlimited number of times. In the latter case, your fax machine can be used as an electronic "bulletin board".

- ◆ Multiple documents can be stored for memory polling. To add a document to others already stored, simply repeating the storing procedure (note that if Department Control is activated, documents cannot be added by a department other than that which stored the first document). When polling is initiated, the polling machine will receive all documents stored.
- ◆ If you allow polling only once, the document(s) will be automatically cleared from memory after polling. If you allow polling an unlimited number of times, the document will remain in memory until you clear it as explained in the following section, *Clearing a document*.

Polling

1 Load the document.

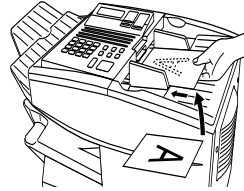

2 Set the reception mode to AUTO
(press the **FUNCTION** key, **1** and **1**).



3 Press these keys:



The display will show:

9:MEMORY POLL MODE
ENTER #(1-2,*,#)

4 Press **1** to select SET.



- If another document has already been stored, press **1** to select APPEND, and go to Step 6.

5 Press **1** to allow polling only once, or
2 to allow polling an unlimited
number of times.

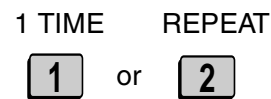

6 Press the **START** key twice.

- The document will be scanned into memory, and your fax will go on polling standby.

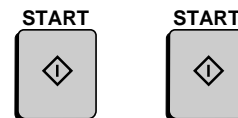

Polling

Clearing a document

To clear a memory poll document (or documents) from memory, follow the steps below:

- 1** Press these keys:



The display will show:

9:MEMORY POLL MODE
ENTER #(1-2,*,#)

- 2** Press **2** to select CLEAR.



- 3** Press **START** to clear the documents.



Polling Security

Polling Security allows you to prevent unauthorized polling of your fax. When this function is activated, polling will only take place when one of the following conditions is met:

- ◆ The fax number of the polling fax machine has been stored in your fax's list of permitted fax numbers (called "passcode numbers"). The polling fax must also have its fax number programmed in itself, as described in *Entering Your Name and Fax Number* in Chapter 1.
- ◆ A System number has been programmed in the polling fax machine which matches your fax's System number or one of your ID numbers.
- ◆ An ID number has been programmed in the polling fax machine which matches your fax's System number.

Polling

System and ID numbers are 4-digit numbers which provide you with an alternate means of giving and receiving polling permission when you don't want to use fax numbers. The steps for programming these numbers are described in the following pages.

Note: System and ID numbers can only be used if the other fax machine is also a Sharp machine.

Turning Polling Security on and off

Polling Security is turned on or off with Option Setting 8. This procedure is explained in Chapter 6, *Optional Settings*.

Storing and clearing fax numbers for polling permission

You can store up to 10 fax numbers in your fax's list of permitted numbers.

1 Press these keys:



The display will show:

2:PASSCODE # MODE
1=SET, 2=CLEAR

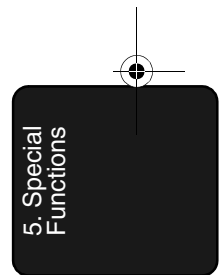

2 Press **1** to set a number, or **2** to clear a number..

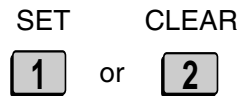

3 Storing: Enter a 2-digit number (from 01 to 10). This number identifies the fax number you will enter in the next step.



(Example)

Clearing: Enter the 2-digit number which identifies the fax number you want to clear, and go to Step 5.

Polling

- 4** Enter the fax number (max. 20 digits) by pressing the numeric keys.



(Example)

- 5** Press the **START** key.



- 6** Return to Step 3 to enter (or clear) another number, or press **STOP** repeatedly to return to the date and time display.

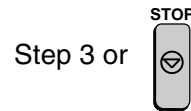

Programming and clearing a System number

One 4-digit System number can be programmed in your fax machine for giving and receiving polling permission. Polling will take place if your System number matches the other fax machine's System number or one of its ID numbers.

- 1** Press these keys:



The display will show:

7:SYSTEM # MODE
1=SET, 2=CLEAR

- 2** Press **1** to program the System number, or **2** to clear it.

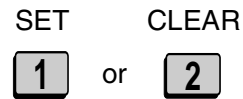

- If you pressed **2**, go to Step 4.

Polling

3 Enter the number (4 digits) with the numeric keys.



(Example)

4 Press the **START** key.



5 Press the **STOP** key repeatedly to return to the date and time display.



Storing and clearing ID numbers for polling permission

Up to five 4-digit ID numbers can be programmed in your fax machine for giving and receiving polling permission. Polling will take place if one of your ID numbers matches the other fax machine's System number.



1 Press these keys:



The display will show:



2 Press **1** to program an ID number, or **2** to clear an ID number.

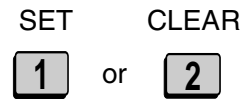

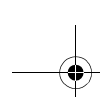

Polling

-
- 3 Storing:** Enter a number from 1 to 5.
This number identifies the ID number
you will enter in the next step.

1

(Example)

Clearing: Enter the number which
identifies the ID number you want to
clear, and go to Step 5.

-
- 4** Enter the ID number (4 digits) by
pressing the numeric keys.

1 0 4 3

(Example)

-
- 5** Press the **START** key.

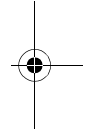
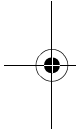

-
- 6** Return to Step 3 to enter (or clear)
another number, or press **STOP**
repeatedly to return to the date and
time display.

Step 3 or

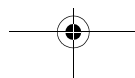

Power Save Mode

Power Save Mode allows you to conserve power by turning off the laser printer heater in the fax machine. While Power Save Mode is on, the laser printer heater remains off and incoming faxes are received to memory. When Power Save Mode is turned off, the printer heater turns on and the faxes received to memory are printed out.

- ◆ Power Save Mode can be turned on and off manually by pressing the **POWER SAVE** key.
- ◆ If desired, you can also set Power Save Mode to turn on and off automatically at specified times of the day, on specified days of the week, and on specified dates during the year.

Note: If the memory becomes full while Power Save Mode is on, the fax machine will automatically turn on the laser printer, print the faxes received to memory, and then return to Power Save Mode.

Note: Power Save Mode cannot be turned on when the Print Hold function is on.

Selecting the Power Save Type

Before turning on Power Save Mode, you will need to select the method by which it is turned on and off. There are two selections: REAL TIME, which means that you turn Power Save Mode on and off by simply pressing the **POWER SAVE** key, and TIMER, which means that Power Save Mode turns on and off automatically at preset times.

- ◆ The initial setting is REAL TIME.

1 Press these keys:

FUNCTION

4

The display will show:

4:OPTIONAL SETTING
ENTER #(01-34,*,#)

Power Save Mode

- 2** Enter **34** by pressing the numeric keys.



The display will show:

34:POWER SAVE TYPE
1=REAL TIME, 2=TIMER

Note: Power Save Type cannot be selected if Power Save Mode is on. To turn off Power Save Mode, simply press the Power Save key once.

- 3** Press **1** to select REAL TIME, or **2** to select TIMER.

REAL TIME TIMER

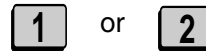

- 4** Press the **STOP** key twice to return to the date and time display.

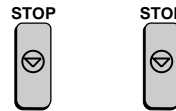

Turning on Power Save Mode when REAL TIME is selected

To turn on Power Save Mode when REAL TIME is selected, simply press the **POWER SAVE** key. POWER SAVE MODE will appear in the display.

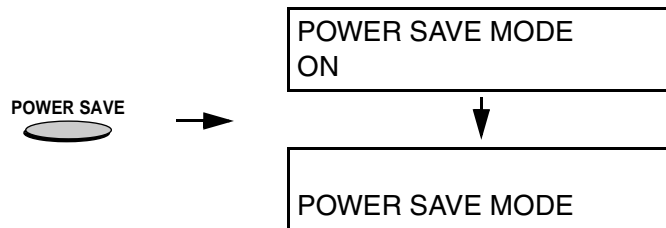

To turn off Power Save Mode, press the **POWER SAVE** key once again. POWER SAVE MODE OFF will appear briefly, followed by the normal date and time display.

Power Save Mode

Turning on Power Save Mode when TIMER is selected

When TIMER is selected, Power Save Mode turns on and off automatically at the times you specify. Follow the steps below to set the on and off times.

-
- 1** Press the **POWER SAVE** key.



The display will show:

POWER SAVE MODE
1=TIMER ON, 2=SET

-
- 2** Press **2** to select SET.



- **Note:** If you have already entered the timer settings and simply wish to turn on the timer, press **1** (TIMER ON).

5. Special Functions

-
- 3** Enter the time you want Power Save Mode to turn on every day (START TIME). Enter two digits for the hour (00 to 23) and two digits for the minute (00 to 59).



Example: 17:00

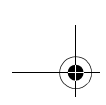

Power Save Mode

- 4** Enter the time you want Power Save Mode to turn off every day (END TIME). Enter two digits for the hour (00 to 23) and two digits for the minute (00 to 59).



Example: 8:00

- 5** Press the **START** key.

Note: The above daily time settings will be in effect every day and are required. The following WEEKEND and PERIOD settings are optional, and are used to set additional weekly and yearly time periods that Power Save Mode will turn on.



The display will show:

WEEKEND SETTING
1=YES, 2=NO

- 6** Press **1** if you want to set a day or days of the week (such as the weekend) that you want Power Save Mode to turn on. If not, press **2** and go to Step 7.

YES NO
1 or **2**

Power Save Mode

7 Enter a 1-digit number for the day each week you want Power Save Mode to turn on, and a 1-digit number for the day after which you want it to turn off:

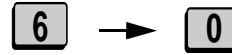

Example: Power Save Mode will turn on from Saturday

- 0:** Sunday
- 1:** Monday
- 2:** Tuesday
- 3:** Wednesday
- 4:** Thursday
- 5:** Friday
- 6:** Saturday

8 Press the **START** key.

The display will show:

PERIOD SETTING
1=YES, 2=NO



5. Special Functions

9 Press **1** if you want to set a period during the year (such as an extended holiday) that Power Save Mode will turn on. If not, press **2** and then the **STOP** key to return to the date and time display.

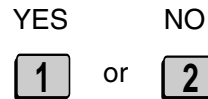

10 Enter the starting day of the period you want Power Save Mode to be on. Enter a 2-digit number for the month (01 to 12), and a 2-digit number for the day (01 to 31).



Example:
December 24th

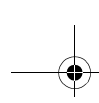

Power Save Mode



11 Enter the ending day of the period you want Power Save Mode to be on. Enter a 2-digit number for the month (01 to 12), and a 2-digit number for the day (01 to 31).



Example:
January 1st

12 Press the **START** key.

The display will show:

TIMER ON?
1=YES, 2=NO



13 Press **1** if you want to activate the timer immediately, or **2** if you want to activate the timer at a later time.

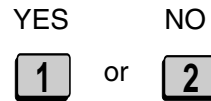

- The timer settings will not take effect until you activate the timer. If you select **2** (NO), you can activate the timer at a later time by pressing the **POWER SAVE** key and then **1** to select **TIMER ON**.

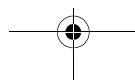
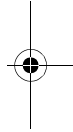
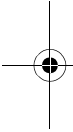

Timer Operations

The Timer function allows you to set up an operation to be performed automatically at a specified time. Up to 48 operations can be set at any one time, and the time of each can be set up to a week in advance.

You can use this function to take advantage of lower off-peak rates without having to be there when the operation is performed.

Note: The **DOCUMENT** key cannot be used for a timer transmission.

Initial procedure

To set a timer operation, first perform the following procedure. After you have completed this procedure, go to the procedure for the specific operation you want to set (see the following pages).

- 1** Press the **TIMER** key.



The display will show:

TIMER MODE
1=SET, 2=CLEAR

- 2** Press **1** to select SET.



- 3** Press the ***** key or the **#** key until the desired operation appears in the display.

Transmission (SEND MODE)
Confidential transmission
Polling
Serial Polling
Broadcasting
Relay Request

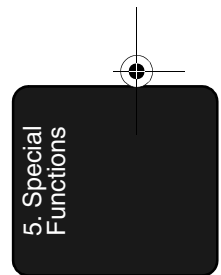

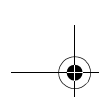

Timer Operations



-
- 4** Press the **START** key.



-
- 5** Enter a two-digit number for the hour (“00” to “23”) and a two-digit number for the minute (“00” to “59”).



Example: 9:25

-
- 6** Enter a 1-digit number for the day of the operation (skip this step if the operation will be performed within the next 24 hours):

- 0: Sunday
- 1: Monday
- 2: Tuesday
- 3: Wednesday
- 4: Thursday
- 5: Friday
- 6: Saturday



Example: Monday

-
- 7** Press the **START** key and go to the specific procedure for your operation (see the following pages).

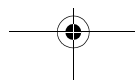

Transmission

(Continued from *Initial procedure.*)

8 Dial the receiving machine using one of the following methods:

- Press a Rapid Key.
- Press the **SPEED DIAL** key and enter a Speed Dial number (if you enter less than 2 digits on the FO-4700, or 3 digits on the FO-5700, press the **START** key to complete the entry).
- Enter a full fax number with the numeric keys.



(Example)

9 Press the **START** key.



10 Adjust the resolution and or contrast if desired, and then press the **START** key.

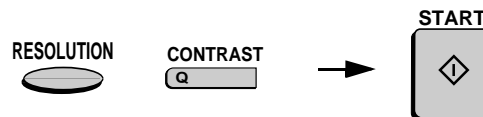

Timer Operations

11 Load the document and then press the **START** key.

- The document will be scanned into memory.

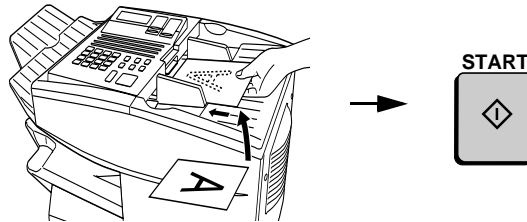

Confidential transmission

(Continued from *Initial procedure*.)

8 Enter the mailbox number (2 digits).
(Go directly to Step 10 if the receiving machine does not have mailboxes.)

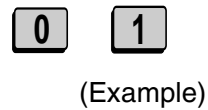

9 Press the **START** key.



10 Dial the receiving machine using one of the following methods:

- Press a Rapid Key.
- Press the **SPEED DIAL** key and enter a Speed Dial number (if you enter less than 2 digits on the FO-4700, or 3 digits on the FO-5700, press the **START** key to complete the entry).
- Enter a full fax number with the numeric keys.

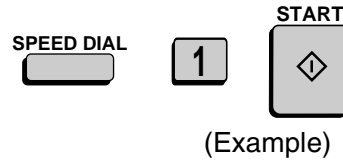

11 Press the **START** key.



12 Adjust the resolution and or contrast if desired, and then press the **START** key.

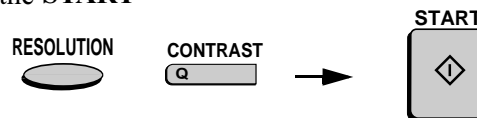

13 Load the document and then press the **START** key.

- The document will be scanned into memory.

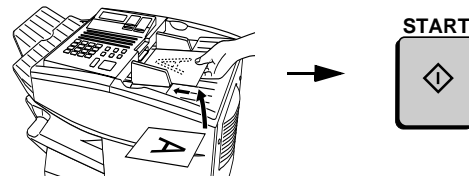

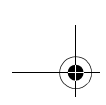

Timer Operations



Polling

(Continued from *Initial procedure.*)

8 Dial the machine to be polled using one of the following methods:

- Press a Rapid Key.
- Press the **SPEED DIAL** key and enter a Speed Dial number (if you enter less than 2 digits on the FO-4700, or 3 digits on the FO-5700, press the **START** key to complete the entry).
- Enter a full fax number with the numeric keys.

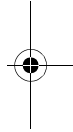
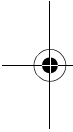
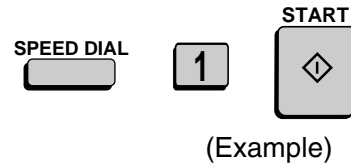

9 Press the **START** key.

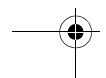
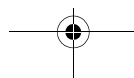

Serial Polling

(Continued from *Initial procedure*.)

8 Dial the machines to be polled using one or more of the following methods:

- Press one or more Rapid Keys.
- Enter one or more Speed Dial numbers, pressing the **SPEED DIAL** key before each number. (If you enter less than 2 digits on the FO-4700, or 3 digits on the FO-5700, press the **START** key to complete the entry.)
- Enter one or more full fax numbers with the numeric keys, pressing the **START** key after each full number.
- Press one or more Group Keys.

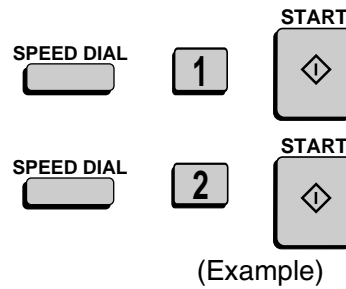

9 Press the **START** key.



Timer Operations

Broadcasting

(Continued from *Initial procedure.*)

8 Dial the receiving machines using one or more of the following methods:

- Press one or more Rapid Keys.
- Enter one or more Speed Dial numbers, pressing the **SPEED DIAL** key before each number. (If you enter less than 2 digits on the FO-4700, or 3 digits on the FO-5700, press the **START** key to complete the entry.)

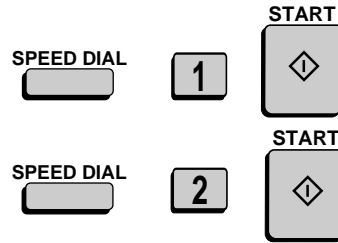

(Example)

- Enter one or more full fax numbers with the numeric keys, pressing the **START** key after each full number.
- Press one or more Group Keys.

9 Press the **START** key.



10 Adjust the resolution and or contrast if desired, and then press the **START** key.



11 Load the document and then press the **START** key.

- The document will be scanned into memory.

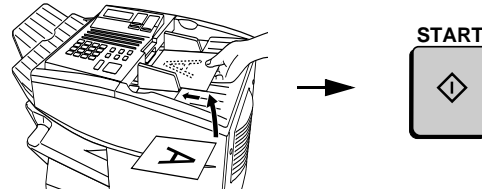

Relay Request

(Continued from *Initial procedure.*)

8 Enter the 2-digit relay group number by pressing the numeric keys.

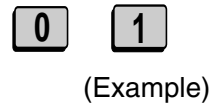

9 Press the **START** key.



10 Adjust the resolution and or contrast if desired, and then press the **START** key.

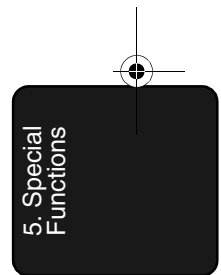

Timer Operations

- 11** Load the document and then press the **START** key.

- The document will be scanned into memory.

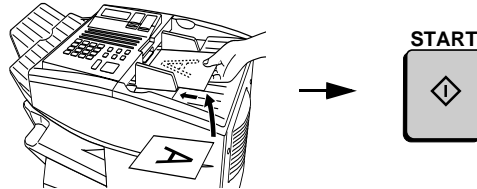

Canceling a timer operation

If you need to cancel a timer operation before it is performed, follow the steps below.

- ◆ You will need to know the number assigned to the operation in order to cancel it. If you don't remember the number (it appears in the display when you set the operation), print out the Timer List. (See Chapter 7, *Printing Out Reports and Lists*.)

- 1** Press the **TIMER** key and then **2**.

The display will show:

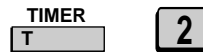

2:TIMER COMM. CLEAR
ENTER #(01-48)

- 2** Enter the 2-digit number assigned to the operation.



(Example)

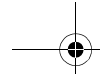

Timer Operations

3 Press the **START** key.



4 Press the **STOP** key repeatedly until you return to the date and time display.

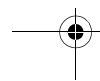
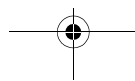
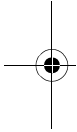

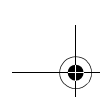

Batch Transmission



Batch Transmission

Batch transmission allows you to store a number of documents in memory for automatic transmission to one location at a set time. If you often send documents to a particular location, this function helps reduce telephone line costs by allowing you to conveniently send multiple documents on one connection.

Programming a Batch Key

To perform a batch transmission, you must first program the number of the receiving machine and the time of transmission into a Batch Key. Any Rapid Key which has not already been programmed can be used as a Batch Key.

If you specify a day-of-the-week in your program, the transmission will be performed every week on that day. If you do not specify a day-of-the-week, the transmission will be performed every day.

To program a Batch Key, follow the procedure for entering programs explained in *Entering and Using Programs* in this chapter. In Step 10 of the initial procedure, select "Batch transmission".

Clearing a Batch Key

To clear a Batch Key, follow the procedure explained in *Clearing a Program Key* in *Entering and Using Programs* in this chapter.

Storing documents for transmission

Up to 56 jobs (a job can consist of multiple pages) can be held in memory for batch transmissions at any one time, regardless of the number of Batch Keys used. When you store a document, it is given a message number to distinguish it from other documents sent in the same batch.

- ◆ If no documents have been stored under a Batch Key when the time for transmission arrives, transmission will not take place.

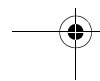
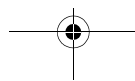

Batch Transmission

1 Load the document (s).

- SEND READY will appear in the display.

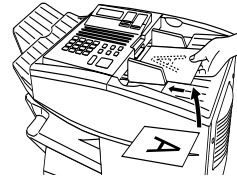

2 Press the appropriate Batch Key.

- After scanning, the message number assigned to your document will appear in the display.

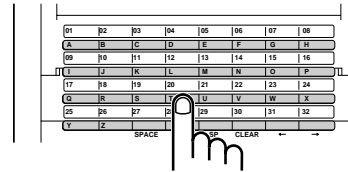

(Example)

3 Press the STOP key.

- The document will be transmitted at the designated time along with any other jobs stored under the same key. After transmission, all jobs in the batch will be cleared from memory.



5. Special Functions

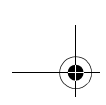

Batch Transmission



Canceling a document stored for batch transmission

If necessary, you can cancel a document stored for a batch transmission before transmission takes place. To do so, you will need to know the message number assigned to the document.

- ◆ If you don't remember the message number, print out the Batch Transmission List (see *Batch Transmission List* in Chapter 7).

- 1** Press the Batch Key in which the document you want to clear has been stored.

- Make sure no documents are in the feeder.

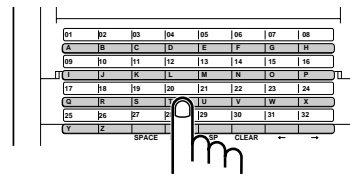

(Example)

- 2** Enter the 3-digit message number assigned to the document.



(Example)

- 3** Press the **START** key.



Entering and Using Programs

If you frequently perform the same operation involving the same party, you can program all the steps of the operation into one Program Key. This allows you to perform the operation by simply pressing that key.

- ◆ Any Rapid Key which is not already programmed as a Rapid Key or a Group Key can be used as a Program Key.
- ◆ You can also include a timer setting in the program to have the operation performed automatically at a selected time.
- ◆ To clear a mistake, press the **STOP** key.

Initial procedure

To program a Program Key, first perform the following procedure. After you have completed this procedure, go to the procedure for the specific operation you want to program (see the following pages).

- 1** Press these keys:



The display will show:

1:PROGRAM ENTRY MODE
1=SET, 2=CLEAR

- 2** Press **1** to select SET.



- 3** Select a Program Key by pressing any Rapid Key that has not yet been programmed.

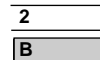

(Example)

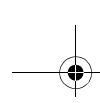

Entering and Using Programs

- 4** Enter a name for the program by pressing the letter entry keys. (If you don't want to enter a name, go directly to Step 5.)



Example: SHARP

- 5** Press the **START** key.



- 6** If you want to include a timer setting, enter a two-digit number for the hour ("00" to "23") and a two-digit number for the minute ("00" to "59"). (If not, go directly to Step 9.)



Example: 9:25

- 7** Enter a 1-digit number for the day of the operation (skip this step if the operation will be performed within the next 24 hours):



- 0: Sunday
- 1: Monday
- 2: Tuesday
- 3: Wednesday
- 4: Thursday
- 5: Friday
- 6: Saturday

Example: Monday

Entering and Using Programs

8 Press the **START** key.



9 Press the ***** key or the **#** key until the desired operation appears in the display.

Transmission (SEND MODE)
Confidential transmission
Polling
Serial Polling
Broadcasting
Relay Request
Batch transmission (this will only appear if a timer setting was made)
Memory Polling (this will not appear if a timer setting was made)



10 Press the **START** key and go to the specific procedure for your operation (see the following pages).



5. Special Functions

Entering and Using Programs

Transmission

(Continued from *Initial procedure.*)

11 Dial the receiving machine using one of the following methods:

- Press a Rapid Key.
- Press the **SPEED DIAL** key and enter a Speed Dial number (if you enter less than 2 digits on the FO-4700, or 3 digits on the FO-5700, press the **START** key to complete the entry).
- Enter a full fax number with the numeric keys.

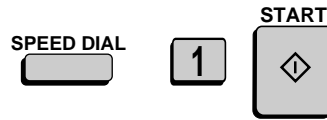

(Example)

12 Press the **START** key.



13 Adjust the resolution and or contrast if desired, and then press the **START** key.



Entering and Using Programs

- 14** If you want the document to be sent through memory, press the **START** key.

If you want the document to be sent directly from the feeder, press the **DOCUMENT** key. (This is not possible if you included a timer setting.)

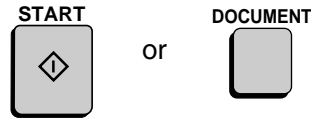

- 15** Press the **STOP** key repeatedly until you return to the date and time display.



Confidential transmission

(Continued from *Initial procedure*.)

- 11** Enter the mailbox number (2 digits). (Go directly to Step 2 if the receiving machine does not have mailboxes.)

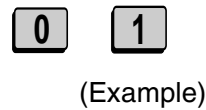

5. Special Functions

- 12** Press the **START** key.



Entering and Using Programs

13 Dial the receiving machine using one of the following methods:

- Press a Rapid Key.
- Press the **SPEED DIAL** key and enter a Speed Dial number (if you enter less than 2 digits on the FO-4700, or 3 digits on the FO-5700, press the **START** key to complete the entry).
- Enter a full fax number with the numeric keys.

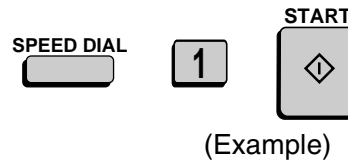

14 Press the **START** key.



15 Adjust the resolution and or contrast if desired, and then press the **START** key.



16 If you want the document to be sent through memory, press the **START** key.

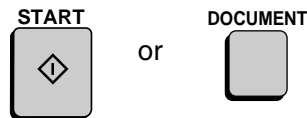

If you want the document to be sent directly from the feeder, press the **DOCUMENT** key. (This is not possible if you included a timer setting.)

-
- 17** Press the **STOP** key repeatedly until you return to the date and time display.



Polling

(Continued from *Initial procedure.*)

-
- 11** Dial the machine to be polled using one of the following methods:

- Press a Rapid Key.
- Press the **SPEED DIAL** key and enter a Speed Dial number (if you enter less than 2 digits on the FO-4700, or 3 digits on the FO-5700, press the **START** key to complete the entry).
- Enter a full fax number with the numeric keys.

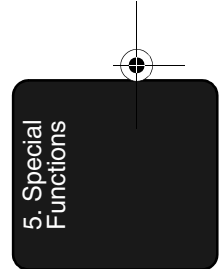
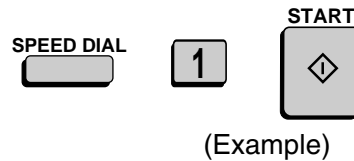

-
- 12** Press the **START** key.



-
- 13** Press the **STOP** key repeatedly until you return to the date and time display.



Entering and Using Programs

Serial Polling

(Continued from *Initial procedure.*)

11 Dial the machines to be polled using one or more of the following methods:

- Press one or more Rapid Keys.
- Enter one or more Speed Dial numbers, pressing the **SPEED DIAL** key before each number. (If you enter less than 2 digits on the FO-4700, or 3 digits on the FO-5700, press the **START** key to complete the entry.)
- Enter one or more full fax numbers with the numeric keys, pressing the **START** key after each full number.
- Press one or more Group Keys.

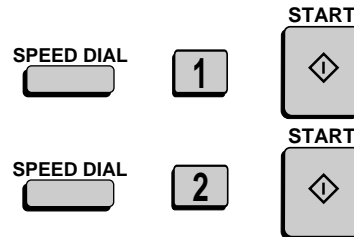

(Example)

12 Press the **START** key.



13 Press the **STOP** key repeatedly until you return to the date and time display.



Broadcasting

(Continued from *Initial procedure*.)

11 Dial the receiving machines using one or more of the following methods:

- Press one or more Rapid Keys.
- Enter one or more Speed Dial numbers, pressing the **SPEED DIAL** key before each number. (If you enter less than 2 digits on the FO-4700, or 3 digits on the FO-5700, press the **START** key to complete the entry.)
- Enter one or more full fax numbers with the numeric keys, pressing the **START** key after each full number.
- Press one or more Group Keys.

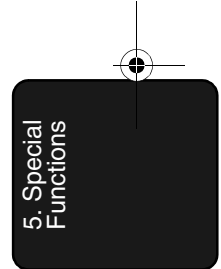
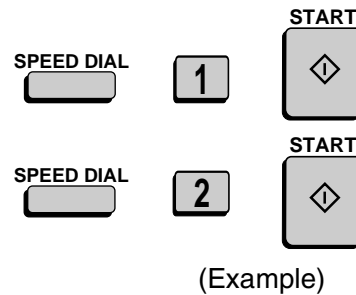

12 Press the **START** key.



13 Adjust the resolution and or contrast if desired, and then press the **START** key.

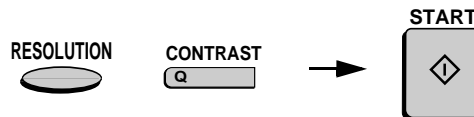

Entering and Using Programs

- 14** Press the **START** key



- 15** Press the **STOP** key repeatedly until you return to the date and time display.



Relay Request

(Continued from *Initial procedure*.)

- 11** Enter the 2-digit relay group number by pressing the numeric keys.



(Example)

- 12** Press the **START** key.



- 13** Adjust the resolution and or contrast if desired, and then press the **START** key.



Entering and Using Programs

- 14** If you want the document to be sent through memory, press the **START** key.

If you want the document to be sent directly from the feeder, press the **DOCUMENT** key. (This is not possible if you included a timer setting.)

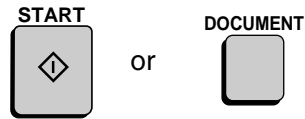

- 15** Press the **STOP** key repeatedly until you return to the date and time display.



Batch transmission

(Continued from *Initial procedure.*)

- 11** Dial the receiving machine using one of the following methods:

- Press a Rapid Key.
- Press the **SPEED DIAL** key and enter a Speed Dial number (if you enter less than 2 digits on the FO-4700, or 3 digits on the FO-5700, press the **START** key to complete the entry).
- Enter a full fax number with the numeric keys.



(Example)

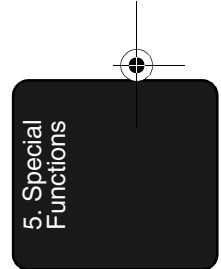

Entering and Using Programs

12 Press the **START** key.



13 Adjust the resolution and or contrast if desired, and then press the **START** key.



14 Press the **START** key



15 Press the **STOP** key repeatedly to return to the date and time display.



Being Polled (Memory polling)

(Continued from *Initial procedure*.)

11 Press **1** to allow polling only once, or **2** to allow polling an unlimited number of times.

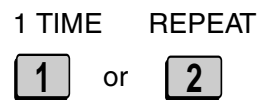

12 Press the **START** key.



Entering and Using Programs

- 13** Adjust the resolution and or contrast if desired, and then press the **START** key.



- 14** Press the **START** key



- 15** Press the **STOP** key repeatedly until you return to the date and time display.

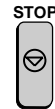

Clearing a Program Key

To clear a Program Key, follow these steps:

- 1** Press these keys:



The display will show:

1:PROGRAM ENTRY MODE
1=SET, 2=CLEAR

- 2** Press **2** to select CLEAR.



- 3** Press the Program Key you want to clear.



(Example)

5. Special Functions

Entering and Using Programs

- 4** Press the **START** key.



- 5** Press the **STOP** key repeatedly until you return to the date and time display.



Using a Program Key

Follow the steps below to perform a programmed operation.

- 1** If this is a transmission or memory polling operation, load the document.



- 2** Press the appropriate Program Key.



(Example)

Canceling a programmed timer operation

If a Program Key has been pressed for a timer operation and you need to cancel the operation before it is performed, follow the steps below.

Note: This procedure will not work for a document stored for a batch transmission. To cancel a batch transmission operation, see *Canceling a document stored for batch transmission* in *Batch Transmission* in this chapter.

-
- 1** Press the Program Key.

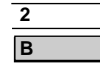

(Example)

-
- 2** Press the **START** key.

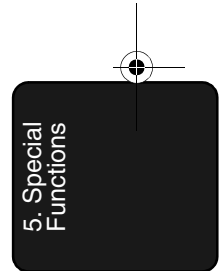

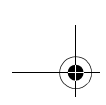

Duplex Scanning for Two-sided Documents



Duplex Scanning for Two-sided Documents

To transmit or copy documents which have printing or graphics on both sides of the page or pages, use Duplex Scanning. With this function, you simply feed the document (all pages) through the machine once, turn the stack of pages over, and feed it through again.

- ◆ The machine will automatically sort the pages into the correct order (front of 1st page, back of 1st page, front of 2nd page, back of 2nd page, etc.).
- ◆ Duplex Scanning can be used for copying (single copies and sorted multiple copies only) and any type of transmission from memory.
- ◆ Note that any blank sides must be included when scanning the pages (if the number of pages is not equal each time the machine scans the stack, an error will result). The blank sides will not, however, be printed out.

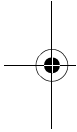

1 Load the document (s).

- Make sure the page(s) are front face down, with the first page on the bottom.
- SEND READY will appear in the display.

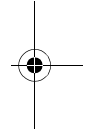
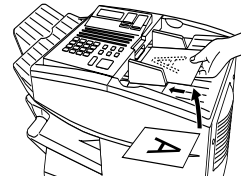

2 Press the **DUPLEX SCAN** key and then the **START** key.

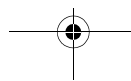
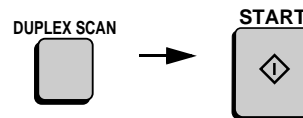

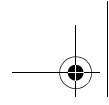

Duplex Scanning for Two-sided Documents

3 Perform all steps of the desired copy or memory transmission.

4 When all pages of the document have been scanned, turn the stack over (do not change the page order) and load it again.

5 Press the **START** key.

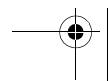
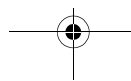
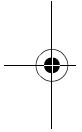
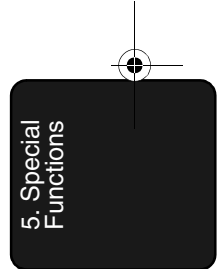

Print Hold

Print Hold

If desired, you can have the fax hold all received documents in memory instead of immediately printing them out. When you enter the correct Print Hold code, the documents will print out.

Programming the Print Hold code

To use Print Hold, you must first program a 4-digit Print Hold code. Follow the steps below to program or clear the code.

- 1** Press these keys:



The display will show:

6:PRINT HOLD
ENTER #(1-3,*,#)

- 2** Press **2** key to program the Print Hold code, or **3** to clear the Print Hold code. (Note: To clear the code, Option Setting 30 must be set to NO.)

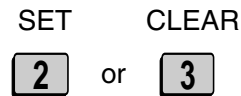

- 3** Enter the 4-digit Print Hold code by pressing the numeric keys.



(Example)

- 4** Press the **START** key.



Note: After entering the passcode, your fax will print it out for your records. If you forget the passcode and have kept no record, contact your Sharp dealer.

Turning on Print Hold

To turn on the Print Hold function, set Option Setting 30 to YES. This procedure is explained in Chapter 6, *Optional Settings*.

Note: The Print Hold function cannot be turned on when Power Save Mode is on.

Printing out received documents

When the Print Hold function is turned on and you have received documents in memory, RCVD PRINT HOLD FAX will appear in the display. Follow the steps below to print out the documents:

- 1** Press these keys:



The display will show:

A rectangular box representing the display screen with the text "1:HOLD DATA PRINT" on the top line and "ENTER PASSCODE #" on the bottom line.

- 2** Enter the 4-digit Print Hold code by pressing the numeric keys.



(Example)

- 3** Press the **START** key.



Department Control

Department Control

Department Control is used to limit use of the fax machine to authorised users. When it is activated, a department code must be entered before an operation can be performed.

- ◆ Department Control can only be activated by your Sharp dealer. If you want to use this function, contact your dealer.
- ◆ Department Control allows you to track the number of pages transmitted as well as the transmission time for each authorised department or person. See *Department Usage List* in Chapter 7.

Entering Department Codes

Up to 30 different Department Codes can be entered to allow access to the fax machine. Transmitted pages and transmission time will be kept track of separately for each code. After you enter a code, inform the appropriate group or individual.

- ◆ A name must be entered for each code. Only the name, not the code, will appear on the Department Usage List.
- ◆ Be sure to keep a record of each code and name. If you misplace the record, contact your dealer.

1 Press these keys:



The display will show:

9:DEPT. CODE MODE
1=SET, 2=CLEAR

2 Press **1** to program a Department Code, or **2** to clear a Department Code.

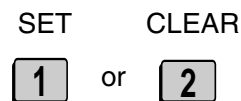

Department Control

3 Entering: Enter a 2-digit number from “01” to “30” with the numeric keys. This number identifies the Department Code that you will enter in the next step.

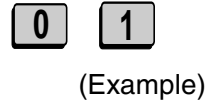

Clearing: Enter the 2-digit number that identifies the Department Code you want to clear.

4 Entering: Enter a Department Code (4 digits or the number of digits set by Option Setting 27).

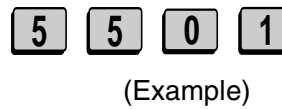

Clearing: Enter the Department Code you want to clear, and go to Step 7.

5 Press the **START** key.



5. Special Functions

6 Enter a name for the Department Code.

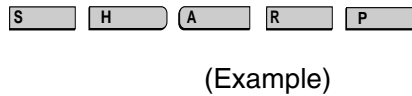

7 Press the **START** key.



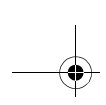

Department Control



- 8** Return to Step 3 to enter (or clear) another Department Code, or press the **STOP** key one or more times until you return to the date and time display.

Step 3 or



Accessing the machine

When Department Control is activated, you must enter your Department Code before performing an operation.

Note: You do not have to enter a Department Code to receive faxes manually (by picking up an extension phone connected to the same line and pressing the **START** key on the fax machine).

Enter your Department Code by pressing the numeric keys, and then perform the desired operation.



(Example)

- If you do not begin the operation within one minute after entering the code, the fax will return to controlled access mode.

Blocking Reception of Unwanted Faxes

Blocking Reception of Unwanted Faxes

The Anti Junk Fax function allows you to block reception of faxes from parties which you specify. This saves paper by not printing out unwanted "junk" faxes.

To use this function, first turn it on by setting Option Setting 20 (Anti-Junk Fax) to YES as explained in Chapter 6, and then enter the fax numbers from which you do not want to receive faxes as shown below.

- ◆ Up to 50 numbers can be entered in the Anti Junk Number List.
- ◆ To clear a number from the Anti Junk Number List, you need to know the 2-digit number which identifies it. If you have forgotten this number, print out the Anti Junk Number List as explained in Chapter 7.

1 Press these keys:



FUNCTION   

The display will show:

8:STORE JUNK FAX #
1=SET, 2=CLEAR

5. Special Functions

2 Press **1** to enter a number in the Anti Junk Number List, or **2** to clear a number from the list.

SET CLEAR
 or 

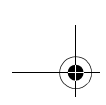

Blocking Reception of Unwanted Faxes

- 3 Entering:** Enter a 2-digit number from “01” to “50” with the numeric keys. This number identifies the fax number that you will enter in the next step.



(Example)

Clearing: Enter the 2-digit number that identifies the fax number you want to clear, and go to Step 5.

- 4** Enter the fax number.



(Example)

- 5** Press the **START** key.



- 6** Return to Step 3 to enter (or clear) another fax number, or press the **STOP** key repeatedly to return to the date and time display.

Step 3 or

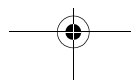

6. Optional Settings

The option settings let you customise the fax machine to better suit your needs.

An initial setting has been made for each option at the factory. To change a setting, follow the steps below to access the option, and then change the setting as explained in the option setting list that follows.

- 1 Press the **FUNCTION** key and **4**.

The display will show:

4:OPTIONAL SETTING
ENTER #(01-34,*,#)

FUNCTION

4

- 2 Press the numeric keys to enter the 2-digit number ("01" to "34") of the option setting you want to set.

0

1

Or

Example:
Option Setting 1

Press ***** or **#** to scroll through the option settings. When the desired option setting appears, press the **START** key.

- 3 Enter a selection for the option setting by pressing the numeric keys. See the list that follows for an explanation of each of the option settings.

6. Optional
Settings

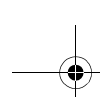

Optional Settings



- 4** After entering a selection, the subsequent option setting will appear in the display. To return to the date and time display, press the **STOP** key twice.



Option Settings

Setting 01: FINE RESOLUTION PRIORITY

This option sets the default resolution (the resolution used if a setting is not made with the **RESOLUTION** key) for transmitting documents. Press **1** (YES) to set the default resolution to FINE, or **2** (NO) to set it to STANDARD.

- ◆ Initial setting: 2

Setting 02: NUMBER OF RINGS AUTO RECEPTION

This sets the number of rings the fax machine waits before answering an incoming call in AUTO receive mode. Enter any number from **2** to **4**, or enter **0** to have the fax machine answer without ringing.

- ◆ Initial setting: 2

Setting 03: NUMBER OF RINGS MANUAL RECEPTION

You can also have the fax machine automatically answer a call after a certain number of rings in MANUAL reception mode. To turn on this function, enter the desired number of rings (any number from **2** to **4**). To turn off the function, enter **0**.

- ◆ Initial setting: 0 (off)

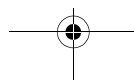

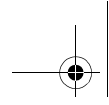

Optional Settings

Setting 04: AUTO LISTING

Press **1** (YES) to have the fax machine automatically print an Activity Report once every 30 send/receive operations. (The report can still be printed on demand at any time.) Press **2** (NO) to turn the function off.

◆ Initial setting: 2

Setting 05: TRANSACTION REPORT PRINT SELECTION

This sets the condition for printing out a Transaction Report. Enter a number from **1** to **5** as follows:

- | | |
|--------------------------------|---|
| 1 (ERROR/TIMER MEMORY): | A report will be printed after an error, timer operation, or memory operation |
| 2 (SEND ONLY) | A report will be printed only after a transmission |
| 3 (ALWAYS PRINTS) | A report will be printed after each transmission, reception, or error |
| 4 (NEVER PRINTS) | A report will never be printed. |
| 5 (ERROR ONLY) | A report will be printed only after an error occurs |

◆ Initial setting: 5

Setting 06: Not used

Setting 07: Not used

Setting 08: SECURITY SELECTION

Press **1** (ON) to turn polling security on, or **2** (OFF) to turn it off.

◆ Initial setting: 1

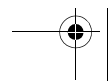
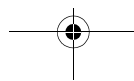

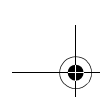

Optional Settings



Setting 09: ERROR CORRECTION MODE (ECM)

Press **1** (YES) to have any distortions in a transmission due to noise on the telephone line corrected before print-out at the receiving end. This is only effective when the other machine has ECM as well. Press **2** (NO) to turn the function off.

Note for FO-5700: If the transmission or reception is taking place in Super G3 mode, ECM will operate regardless of the ECM setting.

◆ Initial setting: 1

Setting 10: AUTO COVER SHEET

Press **1** (YES) to have the fax automatically generate a cover sheet and send it as the last page of each transmission. Press **2** (NO) to turn the function off.

◆ Initial setting: 2

Setting 11: Not used.

Setting 12: COPY SCANNING

This setting is used to reduce copies slightly before printing to ensure that data on the edges are not cut off. Press **1** (AUTO) for automatic reduction, or **2** (100%) for no reduction.

◆ Initial setting: 2

Setting 13: COPY CUT-OFF

This setting determines how the fax machine will copy documents that are longer than the printing paper. Press **1** (CONTINUE) to have the remainder of the document printed on a second page, or **2** (CUT-OFF) to cut off (not print) the remainder.

◆ Initial setting: 2

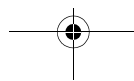
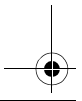
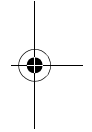
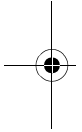

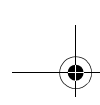

Setting 14: RECEIVE REDUCE

This setting is used to reduce received documents slightly before printing to ensure that data on the edges are not cut off. Press **1** (AUTO) for automatic reduction, or **2** (100%) for no reduction.

◆ Initial setting: 1

Setting 15: IMAGE MEMORY PRINT

Press **1** (YES) to include a copy of part of the first page of the transmitted document on the Transaction Report. Press **2** (NO) to turn the function off. This setting is only effective when transmitting from memory.

◆ Initial setting: 1

Setting 16: CASSETTE SELECTION

Press **1** if you want the fax machine to automatically select the printing paper source (tray or cassette) according to the size of the first page of the document received or copied. (If the document consists of multiple pages of different sizes, all pages will be printed on the same size of paper based on the size of the first page.)

Press **2** if you want the fax machine to automatically select the printing paper source (tray or cassette) according to the size of each page received or copied. (If a document consists of multiple pages of different sizes, each page will be printed on the paper that best matches its size.)

Press **3** if you want to set a fixed order of priority for the paper sources. When the 1ST PRIORITY setting appears, press **1** to have paper always drawn from the tray regardless of the size of the received or copied document, or **2** to have paper always drawn from the cassette. When the 2ND PRIORITY setting appears, press **1** to have paper drawn from the other source in the event that the "1st priority" source runs out of paper, or **2** (NONE) to have the incoming fax received to memory.

This setting will only appear if your dealer has installed the paper cassette option and Option Setting 33 (Seperate Mode) is turned off.

◆ Initial setting: 1

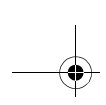

Optional Settings



Setting 17: Not used.

Setting 18: Not used.

Setting 19: HEATER MODE

To conserve power, you can turn off the laser printer heater in your fax machine. When this is done, the heater will turn on automatically when you receive a document (there will be a slight delay before printing while the heater warms up) and turn off when printing is completed. Press **2** to turn off the heater, or **1** to keep it on.

◆ Initial setting: 2

Setting 20: ANTI-JUNK FAX

Press **1** to block reception from fax numbers entered in the Anti Junk Fax List. Press **2** to allow reception from all numbers.

◆ Initial setting: 2

Setting 21: ALARM VOLUME

This sets the volume of the beep sound that alerts you to error conditions and informs you that operations have been completed. Press **1** for HIGH, **2** for LOW, or **3** for OFF.

◆ Initial setting: 2

Setting 22: DIAL MODE

This sets the dial mode. Press **1** if you are on a tone dial line, or **2** if you are on a pulse dial line.

Note: For all units installed in New Zealand, Select **1** for tone dialling. The pulse setting **2** will not operate correctly and must not be used.

◆ Initial setting: 1

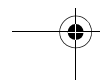
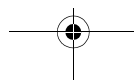
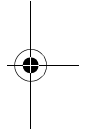
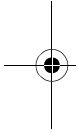

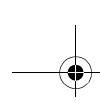

Optional Settings

Setting 23: QUICK ON-LINE

When you transmit a multi-page document, this setting determines whether the fax machine will dial the receiving party and begin transmitting while scanning is still in progress, or wait until all pages have been scanned before dialling. Press **1** to have the fax machine dial and begin transmission while scanning is still in progress, or **2** to have the fax machine wait until all pages have been scanned.

◆ Initial setting: 1

Setting 24: MULTI TTI

If you are using Department Control, you can press **1** to have the department name (the name associated with the department code entered by an operator to access the fax) appear at the top of each transmitted document. This will appear in place of the name entered in *Entering Your Name and Fax Number* in Chapter 1. Press **2** to turn Multi TTI off (the sender's name entered in Chapter 1 will appear).

◆ Initial setting: 2

Setting 25: BEEP LENGTH

This sets the duration of the beep that signals the end of transmission, reception, or copying. Press **1** for 3 seconds, **2** for 1 second, or **3** for no beep.

◆ Initial setting: 1

Setting 27: DEPARTMENT CODE DIGITS

This setting allows you to change the number of digits used for Department Codes. Enter any number from **3** to **9**.

◆ Initial setting: 4

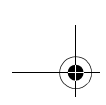

Optional Settings



Setting 28: DISTINCTIVE RING

If you subscribe to a distinctive ring service from your telephone company (Fax Duet in Australia or FaxAbility in New Zealand), press **1** to turn on the Distinctive Ring function. When your fax number is dialled, your fax machine will signal the call with a special ringing sound, then answer automatically and begin reception after the number of rings set with Option Setting 2 (the factory setting is 2 rings). When your voice number is dialled, the fax machine will signal the call with the normal ringing sound to let you know that you must answer personally on an extension phone connected to the same line. Note that the distinctive ring function must be used with the reception mode set to AUTO. If you do not wish to use this function, press **2** to turn it off.

◆ Initial setting: 2

Setting 29: VERIFICATION STAMP

Press **1** if you want the fax machine to stamp each original document page as it is scanned. After scanning, you can check to see if all pages have been stamped to verify that no double feeds occurred. Press **2** to turn the function off.

Note: To use this function, your dealer must install the Verification Stamp option.

◆ Initial setting: 2

Setting 30: PRINT HOLD

Press **1** if you want the fax machine to hold received documents in memory instead of immediately printing them out (note that you must first enter a Print Hold passcode as explained in *Print Hold* in Chapter 5). To turn off the Print Hold function, press **2**, enter the 4-digit Print Hold passcode, and then press **START**.

◆ Initial setting: 2

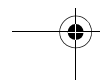
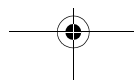
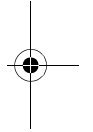
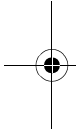

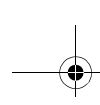

Optional Settings

Setting 31: PC INTERFACE MODE

If you have connected the fax machine to a computer, press **1** to turn on PC Interface mode. Press **2** to turn off PC Interface mode.

Note: This setting will only appear if your dealer has installed the PC interface option.

◆ Initial setting: 1

Setting 32: COPY RESOLUTION

Use this setting to select the default copying resolution (the resolution used for copying if a setting is not made with the **RESOLUTION** key). Press **1** (S-FINE) to set the default resolution to SUPER FINE, or **2** to set it to FINE.

◆ Initial setting: 2

Setting 33: SEPARATE MODE

If desired, you can have the fax draw a sheet of paper from the paper tray after each fax reception. By loading colored (or large) paper in the paper tray, each colored sheet drawn will act as a separator that makes it easy to distinguish where one multi-page document ends and another begins. A Transaction Report printed after a reception will also be printed from the paper tray to act as a separator sheet. Press **1** to turn on this function (be sure to load appropriate paper in the paper tray), or **2** to turn it off. (Note that this function will not operate for copy jobs and print jobs from a computer. Also, the function will turn off automatically if the paper tray runs out of paper.)

This setting will only appear if your dealer has installed the paper cassette option.

◆ Initial setting: 2

Note: If you turn off the Separate Mode setting, Option Setting 16 will subsequently appear in the display to allow you make an appropriate setting for cassette selection. If you don't make a selection, 1:AUTO SELECTION will be automatically selected.

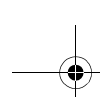

Optional Settings

Setting 34: POWER SAVE TYPE

This option sets the method for turning on Power Save Mode. Press **1** to select REAL TIME (turn Power Save Mode on and off by pressing the **POWER SAVE** key), or **2** to select TIMER (automatic on and off at preset times). For more detailed information, see *Power Save Mode* in Chapter 5.

◆ Initial setting: 1

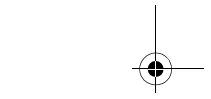
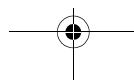
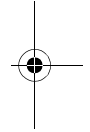
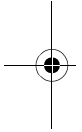

7. Printing Lists and Reports

You can print lists showing settings and information entered in the fax machine. You can also print out reports on recent activity and individual operations after they are completed. The lists and reports are described on the following pages.

To print a list, follow the steps below.

- 1 Press the **FUNCTION** key and **2**.

The display will show:

```
2:LISTING MODE
ENTER #(01-11,*,#)
```



- 2 Press the numeric keys to enter the 2-digit number ("01" to "11") of the list you want to print.



Or

Example:
Activity Report

Press ***** or **#** to scroll through the lists. When the desired list appears, press the **START** key.

Activity Report (List 01)

This report shows information on your most recently performed send and receive operations (a combined maximum of 30 operations can appear). The report is divided into two parts: the **SEND REPORT**, which shows information on transmissions, and the **RECEIVE REPORT**, which shows information on receptions.

7. Printing Lists

Printing Lists and Reports

- ◆ If Option Setting 4 (Auto Listing) is set to YES, a report will be automatically printed out whenever information on 30 operations has accumulated. (A report can still be printed on demand at any time.)
- ◆ All information is erased after a report is printed out. If automatic print-out is turned off and the report is not printed manually for 30 operations, the information on the oldest operation will be overwritten each time a new operation is performed.

```

*****
*                               SEND REPORT                               *
*                               P. 01                                    *
*                               25-MAY-1999 TUE 05:16                 *
* FOR: John Doe Corp.          201 555 1234                           *
*-----*-----*-----*-----*-----*-----*-----*-----*
* NO. DATE  START  RECEIVER  TX TIME  PAGES TYPE  NOTE  MNO. DP *
*-----*-----*-----*-----*-----*-----*-----*-----*
* 01 21-MAY 06:23  AL          ** **"   0 SEND  P. FAIL  001   *
*-----*-----*-----*-----*-----*-----*-----*-----*
*                               TOTAL:    0"    0                       *
*                               GRAND TOTAL TIME:    OS PAGES:    0   *
*****
    
```

Explanation of headings

- SENDER/RECEIVER** The name or fax number of the other machine involved in the transaction. If that machine does not have an ID function, the communication mode will appear (for example, "G3").
- START** The time at which transmission/reception started.
- TX/RX TIME** Total time taken for transmission/reception.
- PAGES** Number of pages transmitted/received.
- TYPE** **CONF. TX** - A confidential operation was performed.
RELAY TX - A relay operation was performed.
(T) - A timer operation was performed.
(D) - The document was sent directly from the feeder, not from memory.

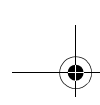

Printing Lists and Reports



NOTE

(One of the following notes will appear under **NOTE** in the report to indicate whether the transaction was successful, and if not, the reason for the failure.)

OK - Transmission/reception was successful.

P.FAIL - A power failure prevented the transaction.

JAM - The printing paper or document jammed, preventing the transaction.

BUSY - The fax was not sent because the line was busy.

COM.E-0 to COM.E-31 - A telephone line error prevented the transaction. See *Line Error* in *Problems and Solutions* in Chapter 9.

CANCEL - The transaction was cancelled because the **STOP** key was pressed, no document was in the feeder, or the other machine requested transmission using a function which your fax machine does not have.

CANCEL 3 - (Used for confidential transmission only)
A confidential transmission was cancelled because the receiving machine does not have a confidential function, a confidential passcode is not programmed in the receiving machine, its memory is full, or it is not a Sharp model.

CANCEL 4 - (Used for confidential transmission only)
A confidential transmission was cancelled because an incorrect mailbox number was entered for a fax machine with confidential mailboxes, or the other machine's memory is full.

CANCEL 5 - (Used for relay request only)
A relay request was not successful because the machine to which the request was made has no relay function, it is not a Sharp model, or its memory was full.

CANCEL 6 - (Used for relay request only)
A relay request was not successful because your machine's fax number has not been entered into the relay machine's list of permitted numbers, an automatic dialling number not stored in the relay machine was specified, or your fax number has not been entered in your machine as explained in Chapter 1.

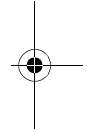
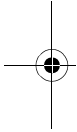

Printing Lists and Reports

Timer List (List 02)

This list shows the timer operations that are currently set.

```

*****
x                                     P.01 x
x                                     x
x          TIMER LIST                 x
x                                     x
x          25-MAY-1999 TUE 05:20     x
x          FOR: John Doe Corp.       201 555 1234 x
x          ----- x
x          TIMER                      x
x          NO.RESERVED TIME TYPE      RESOLUTION BOX REMOTE STATION ID NO. DP x
x          01 11:00 TUE SEND         STANDARD FAX NO.: R01 x
x          ----- x
*****

```

Telephone Number List (List 03)

This list shows the fax numbers that have been programmed for automatic dialling.

```

*****
x                                     P.01 x
x                                     x
x          TELEPHONE NUMBER LIST     x
x                                     x
x          25-MAY-1999 TUE 05:21     x
x          FOR: John Doe Corp.       201 555 1234 x
x          ----- x
x          RAPID/ NAME                 TELEPHONE NO. CHAIN DIAL x
x          SPEED NO. *-SECONDARY NO. x
x          R01 N. Y. FAX 123-785-8304 x
x          *N. Y. (2) 123-785-8885 x
x          R02 JACK SMITH FAX 123-563-8482 x
x          R03 ABC CORP. FAX 230-347-8385 x
x          R04 M. SOFT FAX 852-983-9986 x
x          R05 W. MART FAX 898-983-8521 x
x          ----- x
*****

```

Relay Group List (List 04)

This list shows the relay groups that have been programmed.

```

*****
x                                     P.01 x
x                                     x
x          RELAY GROUP LIST          x
x                                     x
x          25-MAY-1999 WED 05:50     x
x          FOR: John Doe Corp.       201 555 1234 x
x          ----- x
x          NO. RELAY STATION NO.      RECEIVE STATION(S) x
x          01 R01                     RAPID NO. : 01,02,03 x
x          SPEED NO. : 01,02,03 x
x          ----- x
*****

```

Printing Lists and Reports

Program and Group List (List 07)

The top part of this list shows the programs that have been entered. The bottom part shows the fax numbers that have been programmed into Group Keys.

```

XXXXXXXXXXXXXXXXXXXXXXXXXXXXXXXXXXXXXXXXXXXXXXXXXXXXXXXXXXXXXXXXXXXXXXXXXXXX
X                                                                 P.01 X
X          PROGRAM / GROUP LIST          25-MAY-1999 WED 06:57 X
X FOR: John Doe Corp.          201 555 1234 X
X-----X
X          PROGRAM X
X NO. RESERVED TIME NAME/TYPERESOLUTION BOX NO. REMOTE STATION ID NO. X
X P08 11:00 P-POLLING (T.) R01 X
X-----X
X          GROUP X
X NO. REMOTE STATION ID NO. X
X G08 R01 ,R02 ,R03 ,R04 ,R05 X
XXXXXXXXXXXXXXXXXXXXXXXXXXXXXXXXXXXXXXXXXXXXXXXXXXXXXXXXXXXXXXXXXXXXXXXXXXXX
    
```

Batch Transmission List (List 08)

The Batch Transmission List shows the documents that are currently stored for batch transmission.

```

XXXXXXXXXXXXXXXXXXXXXXXXXXXXXXXXXXXXXXXXXXXXXXXXXXXXXXXXXXXXXXXXXXXXXXXXXXXX
X                                                                 P.01 X
X          BATCH TX LIST          25-MAY-1999 WED 06:01 X
X FOR: John Doe Corp.          201 555 1234 X
X-----X
X NO. RESERVED TIME NAME PAGES REMOTE STATION ID NO. MNO. DP X
X P10 11:00 WED BATCH-1 1 FAX NO. : R01 MSG001 X
XXXXXXXXXXXXXXXXXXXXXXXXXXXXXXXXXXXXXXXXXXXXXXXXXXXXXXXXXXXXXXXXXXXXXXXXXXXX
    
```

Department Usage List (List 09)

This list shows total transmission time and pages transmitted (including polling time and pages polled) for each department during the period indicated on the list. The information is only available if Department Control has been activated. The bottom part of the list shows information about relay broadcast operations performed on the request of other fax machines.

- ◆ Each time you print out the report, the data is cleared and a new period begins.

```

*****
*                               DEPARTMENT USAGE LIST                               *
*                               25-MAY-1999 WED 08:03                               *
* FOR: John Doe Corp.           201 555 1234                                       *
*                               17-MAY-1999 TO 26-MAY-1999                          *
*-----*-----*-----*-----*-----*-----*-----*-----*-----*-----*
* NO.  DEPARTMENT NAME          TOTAL TIME   TOTAL PAGES  *
*-----*-----*-----*-----*-----*-----*-----*-----*-----*-----*
* 01                                         *
* 02                                         *
* 03                                         *
* 04                                         *
* 05                                         *
* 06                                         *
* 07                                         *
* 08                                         *
* 09                                         *
* 10                                         *
* 11                                         *
* 12                                         *
* 13                                         *
* 14                                         *
* 15                                         *
* 16                                         *
* 17                                         *
* 18                                         *
* 19                                         *
* 20                                         *
* 21                                         *
* 22                                         *
* 23                                         *
* 24                                         *
* 25                                         *
* 26                                         *
* 27                                         *
* 28                                         *
* 29                                         *
* 30                                         *
*-----*-----*-----*-----*-----*-----*-----*-----*-----*-----*
* GRAND TOTAL          CG          PAGES:  0  *
*-----*-----*-----*-----*-----*-----*-----*-----*-----*-----*
* RELAY BROADCAST                                                 *
* NO.  RELAY PASSCODE NO.      TOTAL TIME   TOTAL PAGES  *
*-----*-----*-----*-----*-----*-----*-----*-----*-----*-----*
* 01                                         *
* 02                                         *
* 03                                         *
* 04                                         *
* 05                                         *
* 06                                         *
* 07                                         *
* 08                                         *
* 09                                         *
* 10                                         *
*-----*-----*-----*-----*-----*-----*-----*-----*-----*-----*
* GRAND TOTAL          CG          PAGES:  0  *
*****
    
```

Confidential Reception List (List 10)

This list shows which mailboxes have received confidential documents and the total number of pages received. Print this list out whenever RCVD CONFIDENTIAL RX appears in the display.

```

*****
*                               CONFIDENTIAL RECEPTION LIST                       *
*                               P. 01                                             *
*                               25-MAY-1999 TUE 05:21                           *
*-----*-----*-----*-----*-----*-----*-----*-----*-----*-----*
* BOX NO.  BOX NAME  ,          TOTAL PAGES  *
*-----*-----*-----*-----*-----*-----*-----*-----*-----*-----*
* 00       ABCD      ,          1             *
*-----*-----*-----*-----*-----*-----*-----*-----*-----*-----*
* TOTAL                                         1             *
*-----*-----*-----*-----*-----*-----*-----*-----*-----*-----*
*****
    
```



Printing Lists and Reports

Anti Junk Number List (List 11)

This list shows the fax numbers from which reception is not allowed.

ANTI-JUNK FAX NUMBER LIST	
FORM: John Doe Corp.	201 999 1234
NO.	ANTI-JUNK FAX NUMBER
1	020383821
2	020383822
3	020383823
4	020383824
5	020383825
6	020383826
7	020383827
8	020383828
9	020383829
10	020383830
11	020383831
12	020383832
13	020383833
14	020383834
15	020383835
16	020383836
17	020383837
18	020383838
19	020383839
20	020383840
21	020383841
22	020383842
23	020383843
24	020383844
25	020383845
26	020383846
27	020383847
28	020383848
29	020383849
30	020383850
31	020383851
32	020383852
33	020383853
34	020383854
35	020383855
36	020383856
37	020383857
38	020383858
39	020383859
40	020383860
41	020383861
42	020383862
43	020383863
44	020383864
45	020383865
46	020383866
47	020383867
48	020383868
49	020383869
50	020383870
51	020383871
52	020383872
53	020383873
54	020383874
55	020383875
56	020383876
57	020383877
58	020383878
59	020383879
60	020383880
61	020383881
62	020383882
63	020383883
64	020383884
65	020383885
66	020383886
67	020383887
68	020383888
69	020383889
70	020383890
71	020383891
72	020383892
73	020383893
74	020383894
75	020383895
76	020383896
77	020383897
78	020383898
79	020383899
80	020383900
81	020383901
82	020383902
83	020383903
84	020383904
85	020383905
86	020383906
87	020383907
88	020383908
89	020383909
90	020383910
91	020383911
92	020383912
93	020383913
94	020383914
95	020383915
96	020383916
97	020383917
98	020383918
99	020383919
100	020383920

Transaction Report

This report is printed out automatically after an operation is completed to allow you to check the result. The fax machine is set at the factory to print out the report only when an error occurs. If desired, you can change the setting to have it printed out under a variety of other conditions. See Option Setting 5 (Print Selection) in Chapter 6.

- ◆ You can also print out the Transaction Report on demand by pressing the **REPORT** key after the operation is completed.
- ◆ The same headings appear in the Transaction Report as in the Activity Report. See *Activity Report* in this chapter for an explanation of the headings.
- ◆ The top part of the first page of the document will also appear below the report if the document was sent from memory. If confidentiality is required, you can prevent printing of the top part of the document by setting Option Setting 15 (Image Memory Print) to NO.

8. Maintenance

Cleaning the Scanning Glass and Rollers

Clean the reading glass and rollers frequently to ensure the quality of your transmitted images and copies.

1 Open the operation panel.

- Squeeze the release marked **PANEL RELEASE** and pull up.



2 Wipe the scanning glass, white backplate, and rollers with a soft cloth.

- Make sure that all dirt and stains (such as correcting fluid) are removed, as dirt will cause vertical lines on transmitted images and copies. (If necessary, wipe with denatured alcohol.)

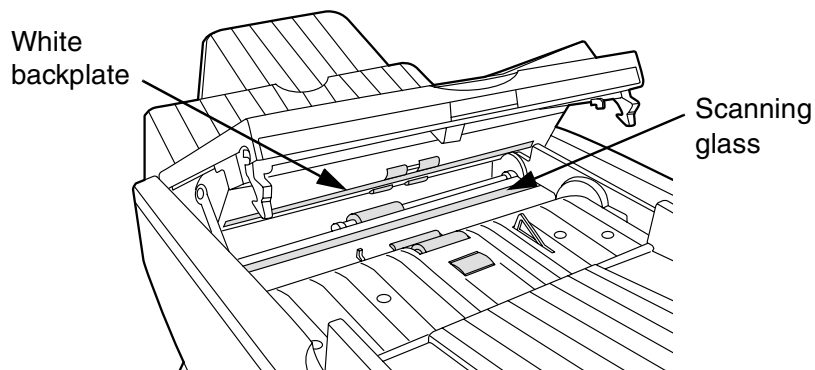

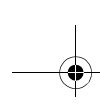

The Housing

The Housing

Wipe the external parts and surface of the machine with a dry cloth.

Caution!

Do not use benzene or thinner. These solvents may damage or discolour the machine.

Replacing the Verification Stamp

If you are using the Verification Stamp function, you will need to replace the ink cartridge in the stamp unit when it runs out of ink (when the stamped mark on original documents becomes faint). A new ink cartridge can be obtained from your dealer.

-
- 1** Remove the original document OUT tray.

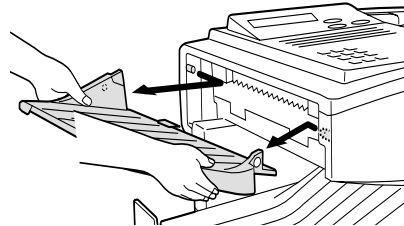

-
- 2** Press down on the protruding tab of the green ink cartridge and pull the cartridge out with your fingers.

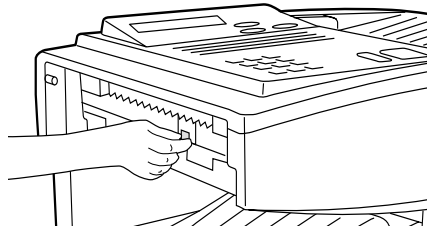

Replacing the Verification Stamp

- 3** Insert the new ink cartridge into the machine (make sure that the tab is facing out).

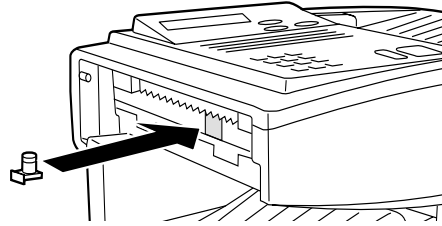

- 4** Replace the original document OUT tray.

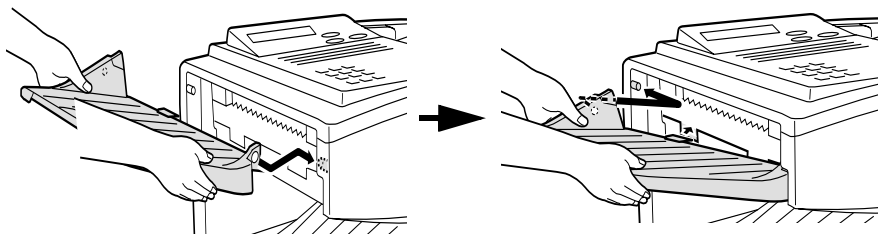

9. Troubleshooting

Problems and Solutions

Line error

Problem	Solution
LINE ERROR appears in the display, and/or a transaction report is printed out with COM. E- and a number from 0 to 31 in the NOTE column.	<p>Try the transaction again. If the error persists, check the following:</p> <ul style="list-style-type: none">• Check the connection. The cord from the TEL. LINE socket to the wall socket should be no longer than two meters.• Make sure there are no modem devices sharing the same telephone line.• Check with the other party to make sure their fax machine is functioning properly.• Have your telephone line checked for line noise.• Try connecting the fax machine to a different telephone line.• If the problem still occurs, your fax machine may need service.

Dialling and transmission problems



Problem	Solution
Dialling is not possible.	<ul style="list-style-type: none"> • Make sure the power lead is properly plugged into a power outlet. • Make sure that the telephone line is properly connected to both the TEL. LINE socket and the wall socket. • Make sure that the fax machine is set to the correct dialling mode for your telephone line. See Option Setting 22 in Chapter 6.
The power is on, but no transmission takes place.	<ul style="list-style-type: none"> • Make sure that the receiving machine has paper. • Make sure that the telephone line cord is plugged into the TEL. LINE socket, and not the TEL. SET socket. • If the receiving machine is in manual mode with no attendant, reception will not be possible. • If the receiving machine is not a Sharp model, make sure it is G3 compatible. • Check the display for error messages. • Press the SPEAKER key and check for a dial tone.
Nothing is printed at the receiving end.	<ul style="list-style-type: none"> • Make sure that the document for transmission is placed face down in the feeder.
A distorted image is received at the other end.	<ul style="list-style-type: none"> • If ECM mode (Option Setting 9) is turned off, noise on the telephone line may cause distortion. Try sending the document again. • Make a copy of the document on your fax machine. If the copy is also distorted, your fax machine may need service.

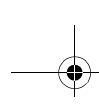

Problems and Solutions



Reception and copying problems

Problem	Solution
The fax machine doesn't receive documents automatically.	<ul style="list-style-type: none"> • Make sure that the reception mode is set to AUTO.
The power is on, but no reception takes place.	<ul style="list-style-type: none"> • Make sure that the wall socket is connected to the TEL. LINE socket, and not the TEL. SET socket.
The printing paper comes out blank when you try to receive a document.	<ul style="list-style-type: none"> • Make sure that the document is loaded properly in the feeder of the transmitting machine. Make a copy or print a report to confirm the printing ability of your machine.
The received document is faint.	<ul style="list-style-type: none"> • Ask the other party to send higher contrast documents. If the contrast is still too low, your fax machine may need service. Make a copy or print a report to check your machine's printing ability. • The toner cartridge may need replacement.
Received images are distorted.	<ul style="list-style-type: none"> • If ECM mode (Option Setting 9) is turned off, noise on the telephone line may cause distortion. Have the other party try sending the document again. • If the other machine has ECM mode, make sure this feature is turned on in both fax machines (see Option Setting 9). • Make a copy or print a report on your fax machine. If the copy or report is also distorted, your fax machine may need service. • The drum cartridge may be damaged. Try a new drum cartridge.
The quality of copies is poor and/or black spots appear.	<ul style="list-style-type: none"> • Any dirt or material on the scanning glass will cause spots to appear on copies and transmitted faxes. Clean the scanning glass as explained in Chapter 8.

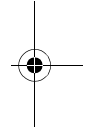
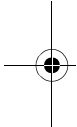

Problems and Solutions

Dots appear at regular intervals on received documents and copies.	<ul style="list-style-type: none"> The drum cartridge may be damaged. Replace the drum cartridge.
--	--



General problems

Problem	Solution
Nothing appears in the display.	<ul style="list-style-type: none"> Make sure the power cord is properly plugged into a power outlet and the power switch is turned on. Connect another electrical appliance to the outlet to see if it has power.
The machine does not respond when you press any of its keys.	<ul style="list-style-type: none"> If a beep sound is not made when you press the keys, turn off the power switch and then turn it on again several seconds later.
Automatic document feeding does not work for transmission or copying.	<ul style="list-style-type: none"> Check the size and weight of the document (see <i>Transmittable Documents</i> in Chapter 2).
No reception occurs when polling is attempted.	<ul style="list-style-type: none"> Make sure you have not run out of paper. Make sure the transmitting machine is in automatic reception mode. If the transmitting machine has polling security, make sure that your fax number has been entered both in your machine and in the transmitting machine.
Bell Tinkle (New Zealand)	<ul style="list-style-type: none"> The operation of this equipment on the same line as the telephone or other equipment with audible warning devices or automatic ring detectors will give rise to bell tinkle or noise and may cause false tripping of the ring detector. Should such a problem occur, contact your authorised Sharp Service Centre for information.

Messages and Signals

Messages and Signals

Display messages

CHECK TRAY/CASSETTE	This indicates that a paper jam has occurred in the tray or cassette, or that the cassette is not installed properly.
CONF REFUSED	A confidential transmission has been denied because you entered an incorrect mailbox number for a machine with mailboxes.
CONF. RX ERROR	Confidential reception was cancelled because the mailbox number specified by the transmitting machine is not programmed in your fax machine.
CHECK COVER OR DRUM	The operation panel is open or the drum cartridge has not been installed. Close the cover or install the drum cartridge.
DRUM LIFE OVER	The drum cartridge must be replaced.
FAX RCVD IN MEMORY	A fax has been received in memory because the toner cartridge needs replacement, you have run out of printing paper, or the paper is jammed. The fax will automatically print out when the problem is fixed.
FUNCTION MODE	The FUNCTION key has been pressed.
LINE ERROR	Transmission or reception was not successful. Press STOP to clear the message and then try again. If the error persists, see <i>Line Error in Problems and Solutions</i> in this chapter.
MEMORY FULL ERROR	An internal memory error occurred. You may need to resend one or more pages of the document being transmitted when the error occurred.
MEMORY FULL ERROR START=OK,STOP=CANCEL	The memory is full (this message appears when Option Setting 23, Quick On-line, is set to NO). Press the START key to send only the pages already scanned, or the STOP key to cancel the entire transmission.

Messages and Signals

NO CONF. FUNC	Confidential transmission was cancelled because the receiving machine does not have a confidential function, a confidential passcode is not programmed in it, its memory is full, or it is not a Sharp model.
NO PAPER	This message will be followed by one of the paper sources in parentheses, and informs you that the paper source is out of paper. If no paper source is indicated, both paper sources are out of paper.
NO RELAY FUNC	A relay request has been denied because the other machine does not have a relay broadcast function, its memory is full, or it is not a Sharp machine.
ONHOOK DIAL MODE	The SPEAKER key has been pressed and the fax machine is waiting for you to dial.
PAPER JAM	The printing paper is jammed. See the following section, <i>Clearing Paper Jams</i> .
POWER SAVE MODE	Power Save Mode is on. See <i>Power Save Mode</i> in Chapter 5.
RCVD CONF. FAX	A confidential fax has been received in memory. Print the fax as explained in <i>Confidential Operations</i> in Chapter 5.
RCVD PRINT HOLD FAX	The Print Hold function has been turned on and you have received one or more faxes in memory. Print out the faxes as explained in <i>Print Hold</i> in Chapter 5.
RCVD RELAY REQUEST	Your fax machine has received a Relay Broadcast request and is transmitting the requested document to the end receiving machines. See <i>Relay Broadcast</i> in <i>Relay Request</i> in Chapter 5.

9. Troubleshooting

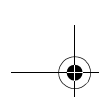

Messages and Signals



RELAY REFUSED	A relay request has been denied because your fax number has not been entered in the relay machine's list of permitted numbers, an auto dial number not programmed in the relay machine was specified, or your fax number has not been programmed in your machine.
REMOVE ORIGINAL(S)	The original document is jammed. See the following section, <i>Clearing Paper Jams</i> .
SIZE ERROR	This message will be followed by one of the paper sources in parentheses, and informs you that the paper loaded in that source is not all the same size.
REPLACE TONER	The toner cartridge must be replaced.
RX DOCUMENT TRAY OFF	The received document tray is not attached. Attach it as explained in <i>Connections</i> in Chapter 1 (the tray must be attached for the fax machine to operate properly.)
WAITING<MEMORY FULL>	The memory has become full and scanning has stopped during scanning of a multi-page document. Scanning will automatically resume when sufficient memory becomes free (for example, after several pages are transmitted).



Audible signals

Continuous tone	3 seconds	Indicates the end of transmission, reception, or copying.
Intermittent tone (3 beeps)	5 seconds (1 second on, 1 second off)	Indicates incomplete transmission, reception, or copying.
Rapid intermittent tone	35 seconds (0.7 seconds on, 0.3 seconds off)	Indicates that an extension phone connected to the fax is off hook.



Clearing Paper Jams

Clearing a jammed document

If the original document doesn't feed properly during transmission or copying, or REMOVE ORIGINAL(S) appears in the display, first try pressing the **START** key. If the document doesn't feed out, open the operation panel and remove it.

Important:

Do not try to remove a document without opening the operation panel. This may damage the feeder mechanism.

1 Open the operation panel.

- Squeeze the release marked **PANEL RELEASE** and pull up.



2 Remove the document.

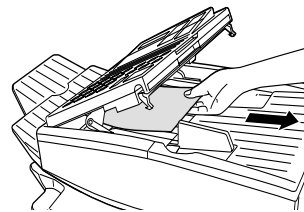

3 Close the operation panel, making sure it clicks into place.

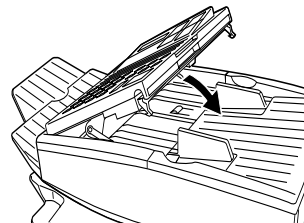

Clearing Paper Jams

Clearing jammed printing paper

If the printing paper jams, PAPER JAM will appear in the display. Follow the steps below to clear the jam.

- 1** Press the green release and open the print compartment cover.

- **Caution!**
The fusing unit inside the print compartment becomes very hot during operation. Be careful not to touch the inside of the compartment.



- 2** If the jammed paper is visible in the print compartment, pull it out.

- Make sure no torn pieces of paper remain in the print compartment and rollers.

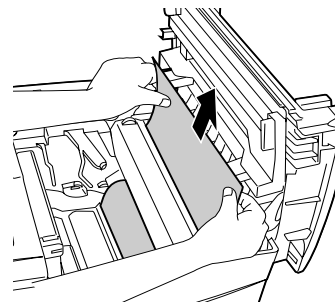

or

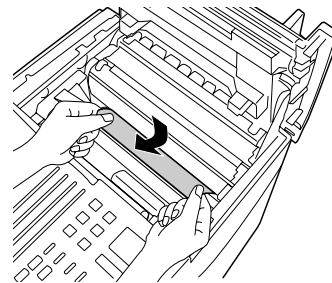

Clearing Paper Jams

- 3** If the jammed paper isn't visible, remove the toner cartridge and then the drum cartridge.

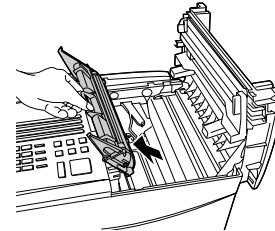
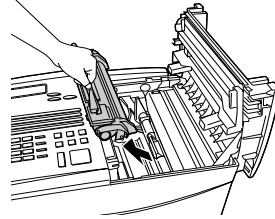

9. Troubleshooting

- 4** Open the black cover (hinged on the left) at the bottom of the compartment. If jammed paper is visible, remove it.

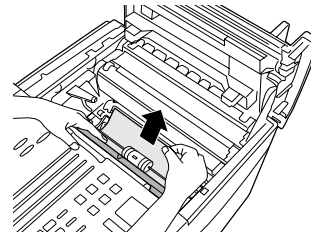

- 5** Close the black cover. Reinsert the drum cartridge and then the toner cartridge.

- Insert the drum cartridge and toner cartridge by aligning the colored numbers on the cartridges with their corresponding colored numbers on the sides of the print compartment.
- When finished, close the print compartment cover.

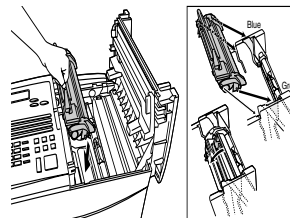
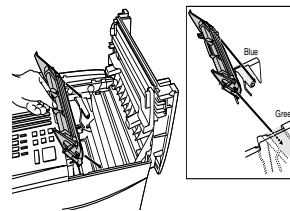

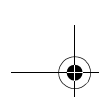

Clearing Paper Jams



-
- 6** If you have a paper cassette and the display still indicates that paper is jammed, open the cassette and remove the jammed paper.

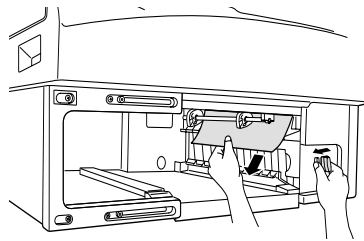
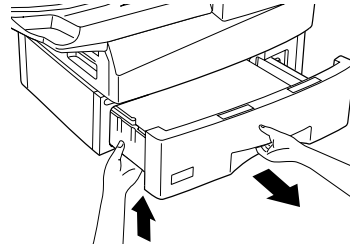

-
- 7** Replace the paper cassette.

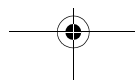
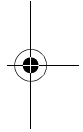
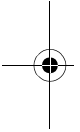
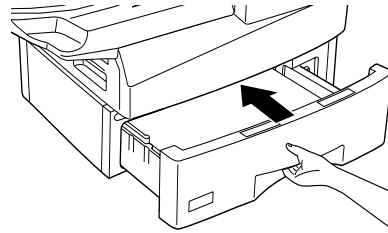

Index

A

Activity Report, 153
 Auto Listing, 145
Alarm volume, 149
Anti Junk Fax, 141, 148
Anti Junk Number List, 160
Audible signals, 170
Auto Cover Sheet, 146
Auto reception mode, 66, 67
Auto-dial numbers, programming, 45

B

Batch page numbering, 64
Batch transmission, 116 - 118
Batch Transmission List, 158
Beep length, 150
Broadcasting, 72 - 74

C

Cancelling a fax, 58, 61
Cassette Selection, 147
Chain Dialling, 48, 58
Changeover key, 58
Computer, connecting to, 21
Confidential operations, 77 - 82
Confidential Reception List, 159
Contrast, 42
Contrast key, 42
Copies, making, 69
Copy Cut-off, 146
Copy resolution, 151
Copying Scanning, 146
Cover Sheet, 62
 Auto Cover Sheet, 146

D

Date, setting, 34

Department Code Digits, 150
Department Control, 138 - 140
Department Usage List, 159
Dial mode, 149
Dialling
 Chain, 48, 58
 Direct Keypad, 55
 Normal, 43
 Rapid Key, 53
 Speed, 54
Direct Keypad Dialling, 55
Distinctive Ring, 150
Document feeder, 40
Document guides, 40
Document key, 51
Document restrictions, 39
Document sizes, 38, 164
Document, maximum scanning area, 39
Drum cartridge
 Installing and replacing, 23 - 27
Drum cartridge indicator, 27
Duplex Scanning, 134

E

Error Correction Mode (ECM), 146

F

Fax Ability (Distinctive Ring), 150
Fax Duet(Distinctive Ring), 150
Fine Resolution Priority, 144

G

Group Keys, 75 - 76

H

Halftone setting, 41
Heater mode, 148
Housing, cleaning, 162

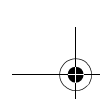

Index

I

Image Memory Print, 147

J

Jams, clearing, 171 - 174

L

Letters, entering, 32

Line error, 164

LINE IN USE light, 12

Loading the document, 40

M

Manual reception mode, 66, 67

Memory

 Checking documents in, 60, 68

 Sending faxes from, 51

 Substitute reception to, 68

Memory retransmission, 59

Multi TTI, 149

N

Normal Dialling, 43

Number of rings in AUTO reception, 144

Number of rings in manual reception,
144

O

Optional Setting List, 157

P

Page Counter key, 64

Page numbering, batch, 64

Paper jams, clearing, 171 - 174

Paper, loading, 28

Passcode List, 157

Pauses in automatic dialling, 46

PC Interface Mode, 151

Polling, 91 - 98

 Security Selection, 145

 Power Save Mode, 99 - 104

 Print Hold, 136 - 137, 151

 Priority key, 51

 Program and Group List, 158

 Programs, 119 - 133

Q

Quick On-line, 149

R

Rapid Key Dialling, 53

Recall Interval, 145

Receive Reduce, 147

Reception mode

 Auto, 66, 67

 Manual, 66, 67

 Setting, 66

Redial key, 44

Redialling, 44, 59

Relay Broadcast, 89

Relay Group List, 156

Relay Request, 83 - 88

Resolution, 41

Resolution key, 42

Retransmission interval, 148

Retransmission times, 148

Ringer volume, 37

S

Scanning glass, cleaning, 161

Search Dial, 56

Seperate Mode, 151

Speaker volume, 36

Speed Dialling, 54

STATUS CHECK light, 12

T

TEL. SET socket, 19

Telephone

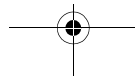

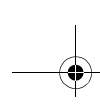

Index

Connecting, 19
 Telephone line cord, 19
 Telephone line status, checking, 58
 Telephone Number List, 156
 Time, setting, 34
 Timer, 105
 Timer List, 156
 Toner cartridge
 Installing and replacing, 23 - 27

Toner cartridge indicator, 27
 Transaction Report, 160
 Print Selection, 145

V

Verification Stamp, 22, 150
 Replacing, 162

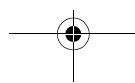
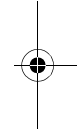
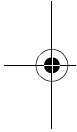

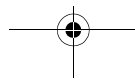
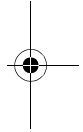
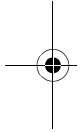
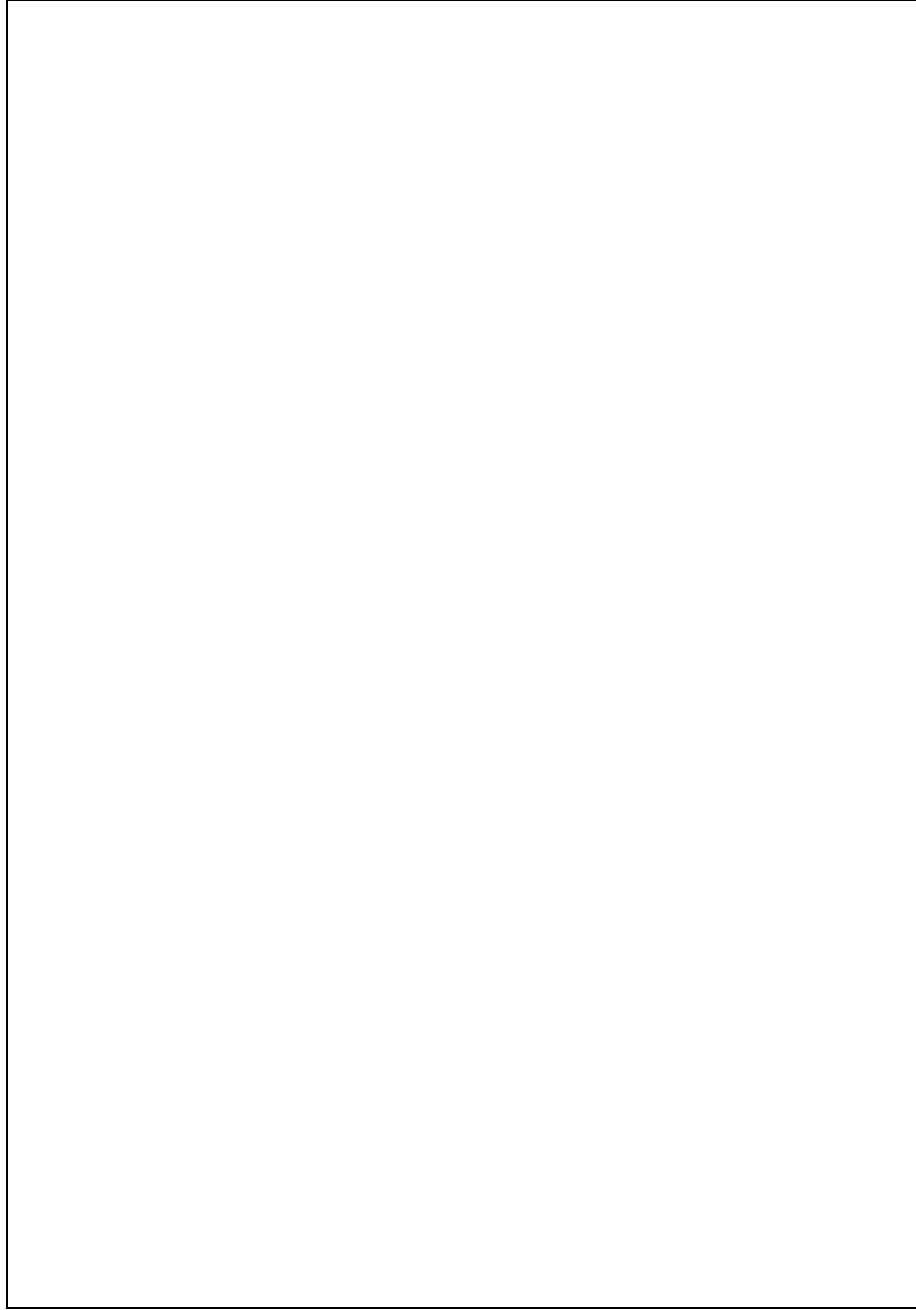

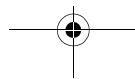
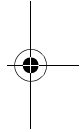
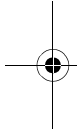
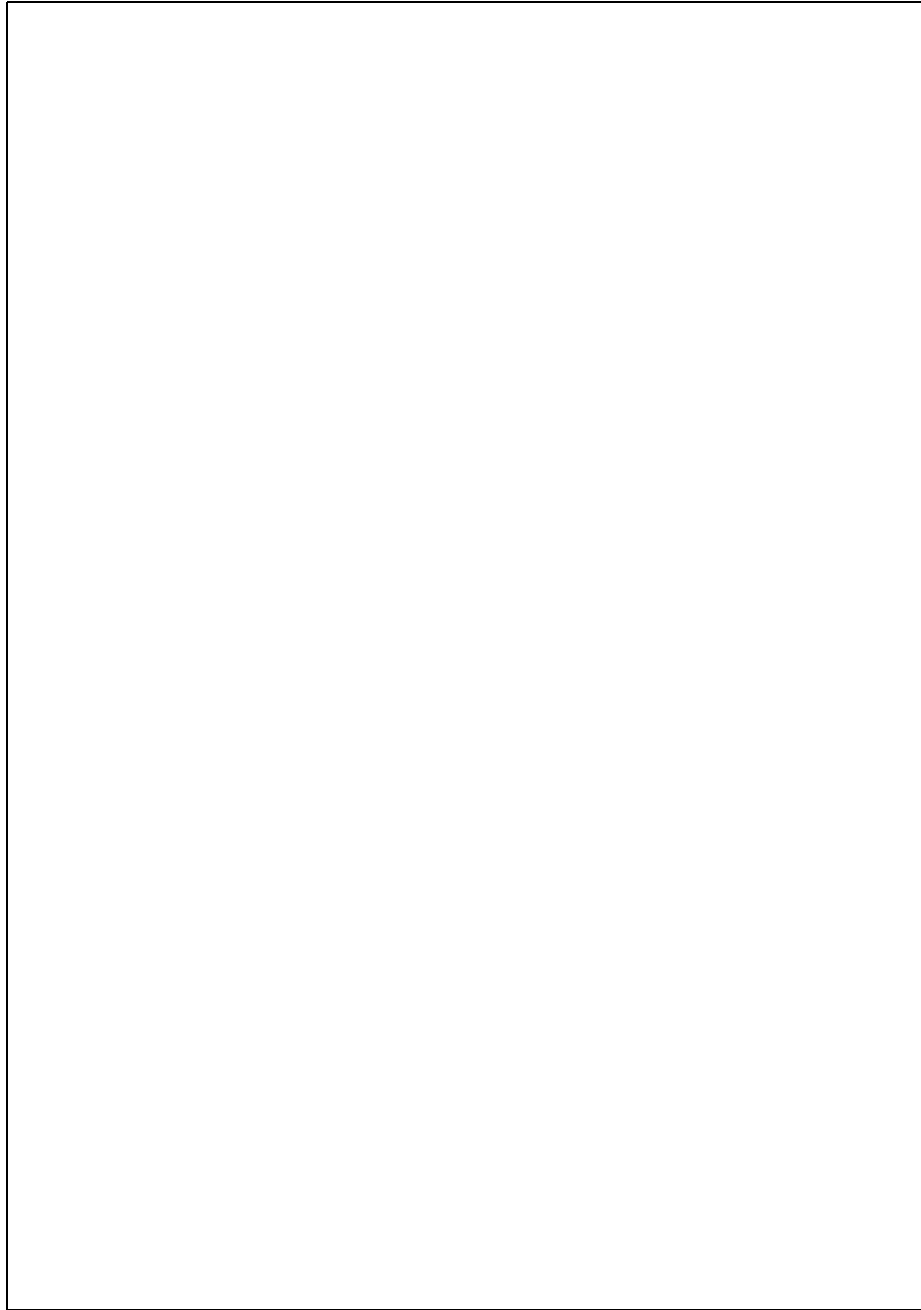

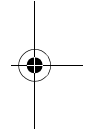
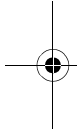
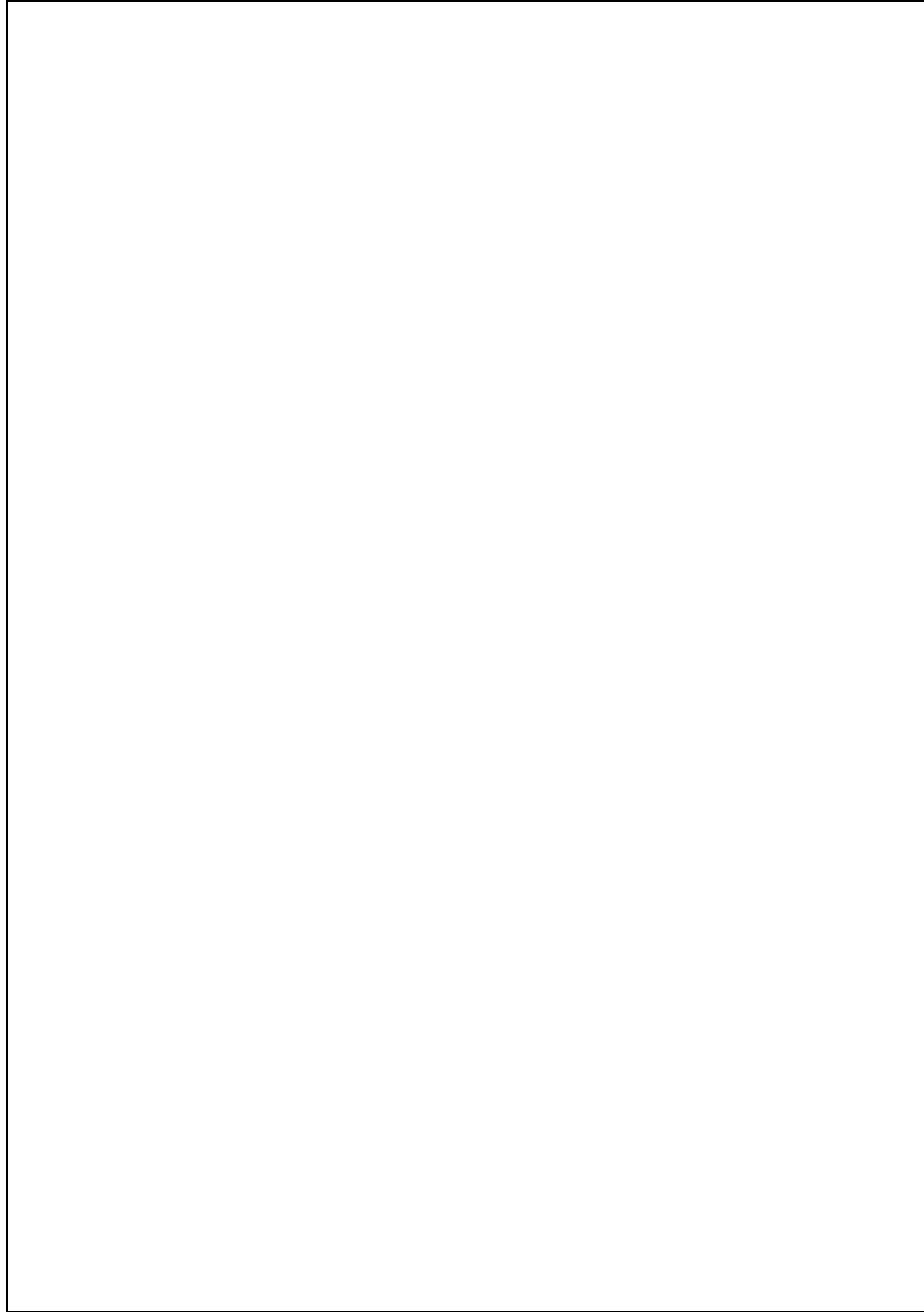

180

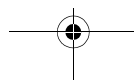
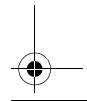
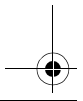

SHARP

WARRANTY

Facsimile Products

Congratulations on Your Purchase!

This Sharp product is warranted against manufacturing defects for a period of twelve (12) months from the date of original purchase.

In the event of any defect arising in the equipment during the warranty period, such repairs should only be carried out by the Dealer from which the unit was originally purchased or a Service Centre approved by Sharp to service this type of equipment. These repairs would be carried out at no charge to the owner, subject to the conditions specified herein.

The owner is responsible for any transportation and insurance costs if the product has to be returned for repair.

This warranty does not extend to accessories or defects or injuries caused by or resulting from causes not attributable to faulty parts or the manufacture of the product, including but not limited to, defect or injury caused by or resulting from misuse, abuse, neglect, accidental damage, improper voltage, liquid spillage, vermin infestation, software, use of consumables other than those approved by Sharp, or any alterations made to the product which are not authorised by Sharp.

Please retain your sales documentation, as this should be produced to validate a warranty claim.

This warranty is in addition to and in no way limits, varies or excludes any express and implied rights and remedies under any relevant legislation in the country of sale. However, to the extent permitted by such legislation, Sharp excludes any liability for any indirect or consequential damages arising from the purchase or use of the product.

To the extent permitted by law, Sharp excludes all implied warranties and conditions and where the product is one that is not normally required for personal, domestic or household use, Sharp limits its liability to the repair or replacement (at Sharp's option) of materials or workmanship which are found by Sharp to be defective.

For your reference, please enter the particulars of your purchase below and retain, with your purchase documentation.

Model No. _____

Serial No. _____

Date of Purchase _____

Place of Purchase _____

SPform046 (2Sept97)

FOR LOCATION ENQUIRIES WITHIN
AUSTRALIA
REGARDING YOUR LOCAL
SHARP APPROVED SERVICE CENTRE

CALL THE
SHARP SERVICE REFERRAL CENTRE
FREECALL: **1 800 807 820**
FACSIMILE: (02) 9672 1210
DURING NORMAL BUSINESS HOURS

SHARP CORPORATION OF AUSTRALIA PTY. LIMITED
A.C.N. 003 039 405
1 Huntingwood Drive, Huntingwood NSW 2148

FOR THE SERVICING OF PRODUCTS
PURCHASED IN
NEW ZEALAND
CONTACT YOUR SELLING DEALER/RETAILER
OR FOR REFERRAL TO A
SERVICE CENTRE,
CALL SHARP CUSTOMER SERVICES
TELEPHONE: **09 634 2059**
FACSIMILE: 09 636 6972

SHARP CORPORATION OF NEW ZEALAND LIMITED
Cnr Mahunga Drive & Hastie Avenue,
Mangere, AUCKLAND

Important Notice: This warranty applies only to products sold in Australia & New Zealand

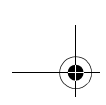

SHARP®

SHARP CORPORATION OF AUSTRALIA PTY.LTD.

A.C.N. 003 039 4051

Huntingwood Drive, Huntingwood, Blacktown, N.S.W., 2148

SHARP CORPORATION OF NEW ZEALAND LIMITED.

**Cnr Mahunga Drive & Hastie Ave. Mangere Bridge, Auckland
New Zealand**

SHARP CORPORATION

PRINTED IN THAILAND
(TINSE4067XHZZ)

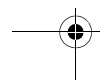
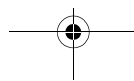

Free Manuals Download Website

<http://myh66.com>

<http://usermanuals.us>

<http://www.somanuals.com>

<http://www.4manuals.cc>

<http://www.manual-lib.com>

<http://www.404manual.com>

<http://www.luxmanual.com>

<http://aubethermostatmanual.com>

Golf course search by state

<http://golfingnear.com>

Email search by domain

<http://emailbydomain.com>

Auto manuals search

<http://auto.somanuals.com>

TV manuals search

<http://tv.somanuals.com>