

SHARP®

MODEL: MX-M623N
MX-M753N
MX-M623U
MX-M753U

DIGITAL MULTIFUNCTIONAL SYSTEM

START GUIDE

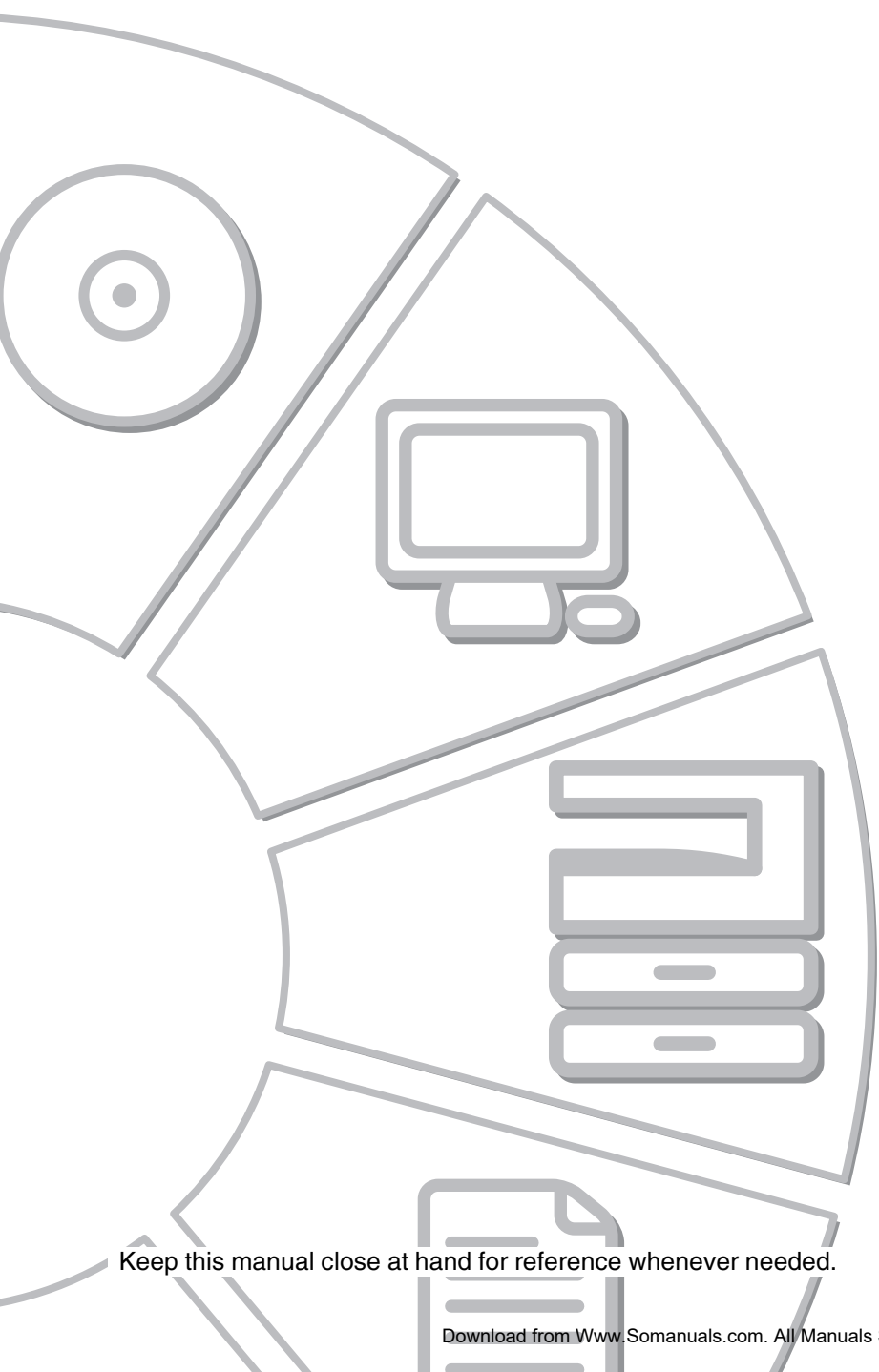

Keep this manual close at hand for reference whenever needed.

Each instruction also covers the optional units used with these products.

Caution!

For complete electrical disconnection, pull out the main plug.
The socket-outlet shall be installed near the equipment and shall be easily accessible.
To reduce the risk of fire, use only UL-Listed No.26 AWG or larger telecommunication line cord.

FAX interface cable and Line cable:

These special accessories must be used with the device.

FOR YOUR RECORDS ...

To protect against loss or theft, record and retain for reference the machine's serial number located at the lower left corner of the left side of the machine.

Model Number _____

Serial Number _____

Date of Purchase _____

Place of Purchase _____

Authorized Sharp Printer _____

Service Department Number _____

Notice for Users in U.S.A.

EMC (this machine and peripheral devices)

WARNING:

FCC Regulations state that any unauthorized changes or modifications to this equipment not expressly approved by the manufacturer could void the user's authority to operate this equipment.

Shielded interface cables must be used with this equipment to maintain compliance with EMC regulations.

NOTE:

This equipment has been tested and found to comply with the limits for a Class A digital device, pursuant to Part 15 of the FCC Rules. These limits are designed to provide reasonable protection against harmful interference when the equipment is operated in a commercial environment. This equipment generates, uses, and can radiate radio frequency energy and, if not installed and used in accordance with the instruction manual, may cause harmful interference to radio communications. Operation of this equipment in a residential area is likely to cause harmful interference in which case the user will be required to correct the interference at his own expense.

This machine contains the software having modules developed by Independent JPEG Group.

This product includes Adobe® Flash® technology of Adobe Systems Incorporated.
Copyright© 1995-2007 Adobe Macromedia Software LLC. All rights reserved.

SOFTWARE LICENSE

The SOFTWARE LICENSE will appear when you install the software from the CD-ROM. By using all or any portion of the software on the CD-ROM or in the machine, you are agreeing to be bound by the terms of the SOFTWARE LICENSE.

The explanations in this manual are based on American English and the North American version of the software.
Software for other countries and regions may vary slightly from the North American version.

Contents

CAUTIONS	2	BEFORE INSTALLING THE SOFTWARE	26
Symbols in this manual	2	CD-ROMS AND SOFTWARE	26
Power notes	2	VERIFYING SYSTEM REQUIREMENTS	28
Installation notes	3	CONNECTING THE MACHINE	30
About consumables	4	SETUP IN A WINDOWS ENVIRONMENT	31
Handling precautions	5	OPENING THE SOFTWARE SELECTION	
Laser information	6	SCREEN (FOR ALL SOFTWARE)	31
OPERATION MANUALS AND HOW TO USE THEM . 7		INSTALLING THE PRINTER DRIVER / PC-FAX	
DIGITAL MULTIFUNCTIONAL SYSTEM FUNCTIONS 8		DRIVER	32
ACCESSING THE WEB SERVER IN THE MACHINE . 9		MAINTENANCE	35
Opening the Web pages	9	REGULAR MAINTENANCE	35
Downloading the Operation Guide	9	REPLACING THE TONER CARTRIDGES	38
CHECKING THE IP ADDRESS	10	REMOVING MISFEEDS	41
PART NAMES AND FUNCTIONS	11	SUPPLIES	42
EXTERIOR	11	SPECIFICATIONS	43
AUTOMATIC DOCUMENT FEEDER AND		Machine specifications / copier specifications	43
DOCUMENT GLASS	12	Continuous copying speeds	45
SIDE AND BACK	13	Ambient environment	45
OPERATION PANEL	14	Acoustic noise emission	
TURNING THE POWER ON AND OFF	16	(measurement according to ISO7779)	46
PLACING ORIGINALS	17	Automatic document feeder specifications	46
Using the automatic document feeder	17	TO THE ADMINISTRATOR OF THE MACHINE . . 48	
Using the document glass	17	Factory default passwords	48
USEABLE PAPER	18	Forwarding all transmitted and received data to the	
LOADING PAPER IN A TRAY	20	administrator (document administration function)	48
Names of the trays	20	For the users of the fax function	49
Loading paper in paper tray 1 - tray 2	21	Trademark acknowledgments	53
Changing the tray settings	22		
Loading paper in other trays	23		

Note:

- The explanations in this manual assume that you have a working knowledge of your Windows or Macintosh computer.
- For information on your operating system, please refer to your operating system manual or the online Help function.
- The explanations of screens and procedures in this manual are primarily for Windows Vista® in Windows® environments. The screens may vary depending on the version of the operating system.
- Considerable care has been taken in preparing this manual. If you have any comments or concerns about the manual, please contact your dealer or nearest SHARP Service Department.
- This product has undergone strict quality control and inspection procedures. In the unlikely event that a defect or other problem is discovered, please contact your dealer or nearest SHARP Service Department.
- Aside from instances provided for by law, SHARP is not responsible for failures occurring during the use of the product or its options, or failures due to incorrect operation of the product and its options, or other failures, or for any damage that occurs due to use of the product.



Products that have earned the ENERGY STAR® are designed to protect the environment through superior energy efficiency.

Warranty



While every effort has been made to make this document as accurate and helpful as possible, SHARP Corporation makes no warranty of any kind with regard to its content. All information included herein is subject to change without notice. SHARP is not responsible for any loss or damages, direct or indirect, arising from or related to the use of this operation manual.

© Copyright SHARP Corporation 2010. All rights reserved. Reproduction, adaptation or translation without prior written permission is prohibited, except as allowed under copyright laws.





CAUTIONS

Symbols in this manual

To ensure safe use of the machine, this manual uses various safety symbols. The safety symbols are classified as explained below. Be sure you understand the meaning of the symbols when reading the manual.

Symbol	Meaning
 WARNING	Indicates a risk of death or serious injury.
 CAUTION	Indicates a risk of human injury or property damage.

Meaning of the symbols

Symbol	Meaning	Symbol	Meaning	Symbol	Meaning
	CAUTION! HOT		PROHIBITED ACTIONS		MANDATORY ACTIONS
	PINCH POINT KEEP CLEAR		DO NOT DISASSEMBLE		

Power notes

WARNING

 Be sure to connect the power cord only to a power outlet that meets the specified voltage and current requirements. Also make certain the outlet is properly grounded. Do not use an extension cord or adapter to connect other devices to the power outlet used by the machine. Using an improper power supply may cause fire or electrical shock.

*For the power supply requirements, see the name plate in the lower left corner of the left side of the machine.

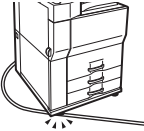
 Do not damage or modify the power cord.  Placing heavy objects on the power cord, pulling it, or forcibly bending it will damage the cord, resulting in fire or electrical shock.

 Do not insert or remove the power plug with wet hands. This may cause electrical shock.

CAUTION

 When removing the power plug from the outlet, do not pull on the cord. Pulling on the cord may cause damage such as wire exposure and breakage, and may result in fire or electrical shock.

 When moving the machine, switch off the main power and remove the power plug from the outlet before moving. The cord may be damaged, creating a risk of fire or electrical shock.

 If you will not use the machine for a long time, be sure to remove the power plug from the outlet for safety.

Installation notes

CAUTION



Do not install the machine on an unstable or slanted surface. Install the machine on a surface that can withstand the weight of the machine.

Risk of injury due to the machine falling or toppling. If peripheral devices are to be installed, do not install on an uneven floor, slanted surface, or otherwise unstable surface. Danger of slippage, falling, and toppling. Install the product on a flat, stable surface that can withstand the weight of the product. (Weight when various peripheral devices are installed: approx. 718 lbs. (326 kg))



When the machine is installed, the adjusters (4) must be lowered to the floor to secure the machine (prevent it from moving).

Rotate the adjusters in the locking direction until they are in firm contact with the floor.

If you find it necessary to reposition the machine due to rearrangement of your office layout or other reason, retract the adjusters

from the floor, turn off the power, and then move the machine.

(After moving the machine, lower the adjusters again to secure the machine.)

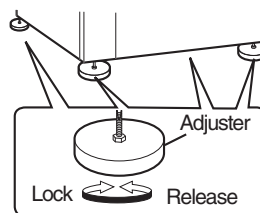

Do not install in a location with moisture or dust.



Risk of fire and electrical shock. If dust enters the machine, dirty output and machine failure may result.



Locations exposed to direct sunlight

Plastic parts may become deformed and dirty output may result.

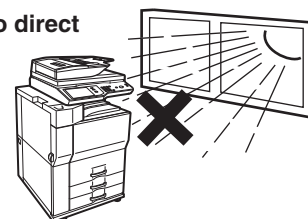

Locations that are excessively hot, cold, humid, or dry (near heaters, humidifiers, air conditioners, etc.)



The paper will become damp and condensation may form inside the machine, causing misfeeds and dirty output.

 Ambient environment (page 45)

If the location has an ultrasonic humidifier, use pure water for humidifiers in the humidifier. If tap water is used, minerals and other impurities will be emitted, causing impurities to collect on the inside of the machine and create dirty output.



Locations with ammonia gas



Installing the machine next to a diazo copy machine may cause dirty output.

Installation notes (continued)

! CAUTION



Do not install the machine in a location with poor ventilation. Install so that exhaust from the machine does not directly contact people.

A small amount of ozone is produced within the printer during operation. The emission level is insufficient to cause any health hazard. The present recommended long term exposure limit for ozone is 0.1 ppm (0.2 mg/m³) calculated as an 8 hr. time-weighted average concentration. However, since the small amount that is emitted may have an objectionable odor, it is advisable to place the copier in a ventilated area.

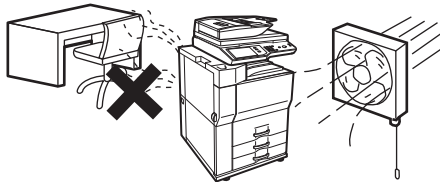

A small amount of ozone is created inside the machine during printing. The amount of ozone created is not sufficient to be harmful; however, an unpleasant odor may be noticed during large copy runs, and thus the machine should be installed in a room with a ventilation fan or windows that provide sufficient air circulation. (The odor may occasionally cause headaches.)

* Install the machine so that people are not directly exposed to exhaust from the machine. If installed near a window, ensure that the machine is not exposed to direct sunlight.



Near a wall

Be sure to allow the required space around the machine for servicing and proper ventilation. (The machine should be no closer than the distances indicated below from walls. The indicated distances are for the case when a saddle finisher and large capacity paper tray are not installed.)

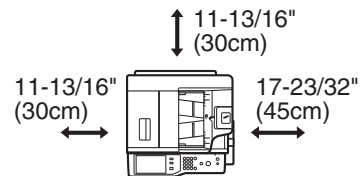

Locations subject to vibration.

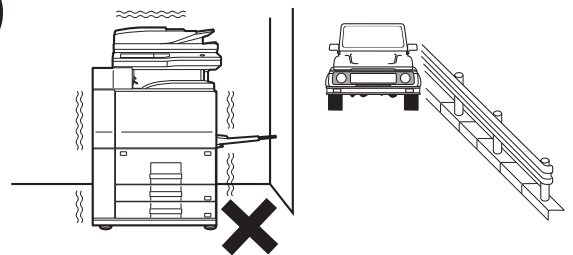

Vibration may cause failure.

! The machine includes a built-in hard drive. Do not subject the machine to shock or vibration. In particular, never move the machine while the power is on.

- The machine should be installed near an accessible power outlet for easy connection.
- Connect the machine to a power outlet which is not used for other electric appliances. If a lighting fixture is connected to the same outlet, the light may flicker.

About consumables

! CAUTION



Do not throw a toner cartridge into a fire.
Toner may fly and cause burns.



Store a toner cartridge out of the reach of children.

Handling precautions

WARNING



Do not place a container of water or other liquid, or a metal object that might fall inside, on the machine.



If the liquid spills or the object falls into the machine, fire or electrical shock may result.



If you notice smoke, a strange odor, or other abnormality, do not use the machine.



If used in this condition, fire or electrical shock may result. Immediately switch off the main power and remove the power plug from the power outlet. Contact your dealer or nearest SHARP Service Department.



Do not remove the machine casing.

High-voltage parts inside the machine may cause electrical shock.



Do not make any modifications to this machine.

Doing so may result in personal injury or damage to the machine.



Do not use a flammable spray to clean the machine.

If gas from the spray comes in contact with hot electrical components or the fusing unit inside the machine, fire or electrical shock may result.



If a thunder storm begins, switch off the main power and remove the power plug from the outlet to prevent electrical shock and fire due to lightning.



If a piece of metal or water enters the machine, switch off the main power and remove the power plug from the power outlet.

Contact your dealer or nearest SHARP Service Department. Using the machine in this condition may result in electrical shock or fire.

CAUTION



Do not look directly at the light source.

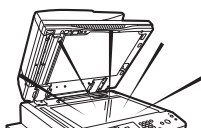

Doing so may damage your eyes.



The fusing unit and paper exit area are hot. When removing a misfeed, do not touch the fusing unit and paper exit area. Take care not to burn yourself.

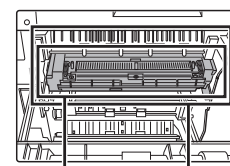

Fusing unit Paper exit area



Do not block the ventilation ports on the machine. Do not install the machine in a location that will block the ventilation ports.

Blocking the ventilation ports will cause heat to build up in the machine, creating a risk of fire.



When loading paper, removing a misfeed, performing maintenance, closing the front and side covers, and inserting and removing trays, take care that your fingers are not pinched.



The machine includes the document filing function, which stores document image data on the machine's hard drive. Stored documents can be called up and printed or transmitted as needed. If a hard drive failure occurs, it will no longer be possible to call up the stored document data. To prevent the loss of important documents in the unlikely event of a hard drive failure, keep the originals of important documents or store the original data elsewhere.

With the exception of instances provided for by law, Sharp Corporation bears no responsibility for any damages or loss due to the loss of stored document data.

CAUTIONS

Laser information

Wave length	790 nm \pm 10 nm
Pulse times (North America and Europe)	MX-M623N/MX-M623U: 3.3 μ s \pm 6.4 ns /7 mm MX-M753N/MX-M753U (Heavy paper mode): 3.3 μ s \pm 6.4 ns /7 mm MX-M753N/MX-M753U (Standard mode): 2.8 μ s \pm 5.4 ns /7 mm
Output power	Max 0.5 mW (LD1+ LD2)

Caution

Use of controls or adjustments or performance of procedures other than those specified herein may result in hazardous radiation exposure.

This Digital Equipment is CLASS 1 LASER PRODUCT (IEC 60825-1 Edition 1.2-2001)

SAFETY PRECAUTIONS

This Digital Equipment is rated Class 1 and complies with 21 CFR 1040.10 and 1040.11 of the CDRH standards. This means that the equipment does not produce hazardous laser radiation. For your safety, observe the precautions below.

- Do not remove the cabinet, operation panel or any other covers.
- The equipment's exterior covers contain several safety interlock switches. Do not bypass any safety interlock by inserting wedges or other items into switch slots.

"BATTERY DISPOSAL"

THIS PRODUCT CONTAINS A LITHIUM PRIMARY MEMORY BACK-UP BATTERY THAT MUST BE DISPOSED OF PROPERLY. PLEASE CONTACT YOUR LOCAL SHARP DEALER OR AUTHORIZED SERVICE REPRESENTATIVE FOR ASSISTANCE IN DISPOSING OF THIS BATTERY.

This product utilizes a CR coin Lithium battery which contains a Perchlorate material. Special handling for this material may apply, California residents, See www.dtsc.ca.gov/hazardouswaste/perchlorate/
Others, consult local environmental officers.

This product utilizes tin-lead solder, and fluorescent lamp containing a small amount of mercury. Disposal of these materials may be regulated due to environmental consideration. For disposal or recycling information, please contact your local authorities, the Electronics Industries Alliance: www.eiae.org, the lamp recycling organization: www.lamprecycle.org or Sharp at 1-800-BE-SHARP. (For U.S.A. Only)

OPERATION MANUALS AND HOW TO USE THEM

Printed manuals and a manual in PDF format are provided with the machine.

Printed manuals

This section explains precautions to ensure safe usage, part names and functions, basic software installation, how to resolve paper jams, and daily maintenance procedures. Refer to the PDF instruction manual for instructions on how to use the machine.

Start Guide

(this manual)

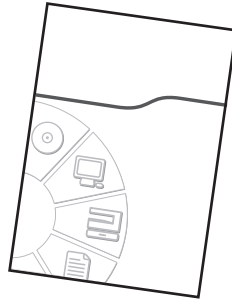

Manuals in PDF format

The explanation of the functions that can be used on the machine are provided in the Operation Guide in PDF format. The Operation Guide can be downloaded from the Web pages in the machine.

Operation Guide

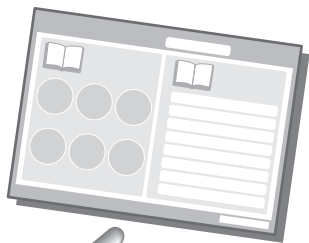

Download the Operation Guide from the Web pages in the machine.

Name	Desc
<input checked="" type="radio"/> Operation Guide	Oper

Download(O)



For the downloading procedure, see "Downloading the Operation Guide" (page 7).

Convenient methods for using the Operation Guide

The first page contains a regular table of contents as well as an "I want to..." table of contents.

"I want to..." lets you jump to an explanation based on what you want to do. For example, "I use the copier function often, so I'd like to save paper".

Use either table of contents as appropriate based on what you want to know.

The contents of the Operation Guide are as follows:

- BEFORE USING THE MACHINE
- FACSIMILE
- SYSTEM SETTINGS
- COPIER
- SCANNER / INTERNET FAX
- TROUBLESHOOTING
- PRINTER
- DOCUMENT FILING

* To view the Operation Guide in PDF format, Adobe® Reader® or Acrobat® Reader® of Adobe Systems Incorporated is required. Adobe® Reader® can be downloaded from the following URL:

<http://www.adobe.com/>

DIGITAL MULTIFUNCTIONAL SYSTEM FUNCTIONS

This machine provides four major areas of functionality.

Refer to the Operation Guide for details on using the various functions within each area.

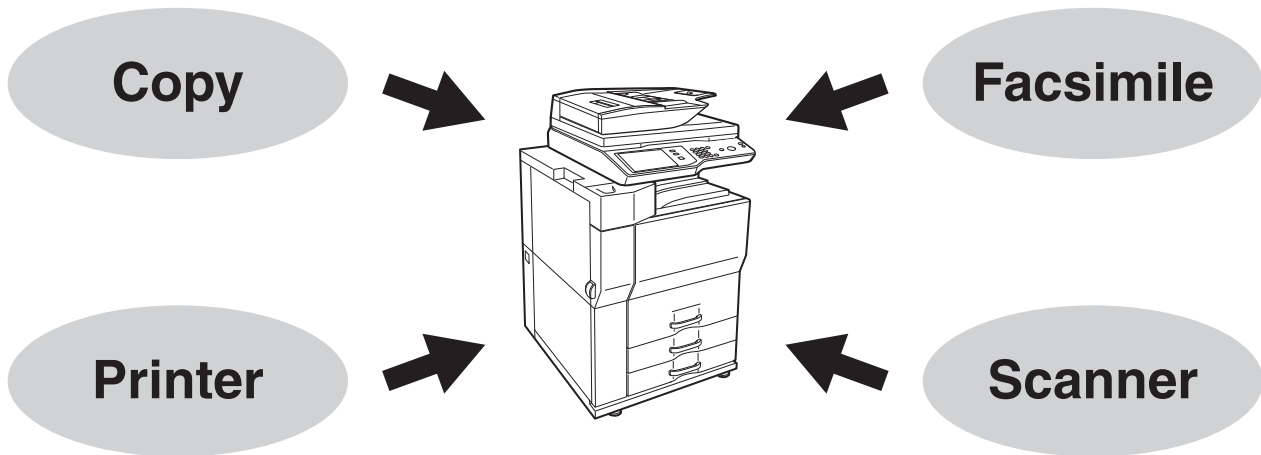

Model name	Function
MX-M623U/MX-M753U	Copy, Printer*1, Facsimile*2, Scanner*3
MX-M623N/MX-N753N	Copy, Printer, Facsimile*2, Scanner

*1 The printer expansion kit is required.

*2 The facsimile expansion kit is required.

*3 The network scanner expansion kit is required.

ACCESSING THE WEB SERVER IN THE MACHINE

When the machine is connected to a network, the machine's built-in Web server can be accessed from a Web browser on your computer.

Opening the Web pages

1

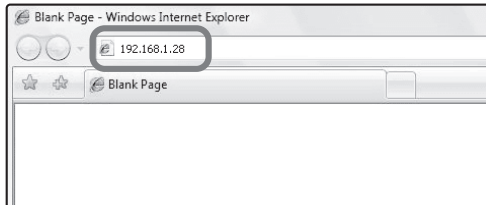

Access the Web server in the machine to open the Web pages.

Start a Web browser on a computer that is connected to the same network as the machine and enter the IP address of the machine.

Recommended Web browsers
Internet Explorer: 6.0 or higher (Windows®)
Netscape Navigator: 9 (Windows®)
Firefox: 2.0 or higher (Windows®)
Safari: 1.5 or higher (Macintosh)
The Web page will appear.

The machine settings may require that user authentication be performed in order to open the Web page. Please ask the administrator of the machine for the password that is required for user authentication.

Downloading the Operation Guide

The Operation Guide, which is a more detailed manual, can be downloaded from the machine's Web pages.

1

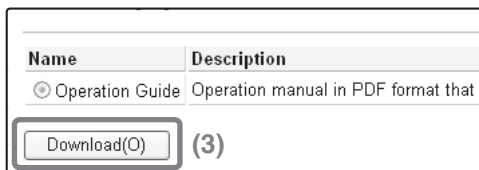
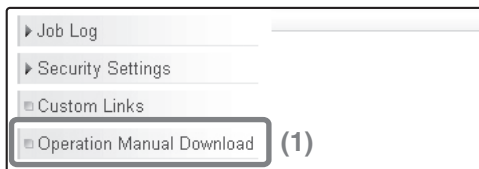

Downloading the Operation Guide.

(1) Click [Operation Manual Download] in the menu of the Web page.

(2) Select the desired language.

(3) Click the [Download] button.
The Operation Guide is downloaded.

CHECKING THE IP ADDRESS

To check the IP address of the machine, print out the all custom setting list in the system settings.

1 Press the [SYSTEM SETTINGS] key.



2 Select the all custom setting list in the touch panel.

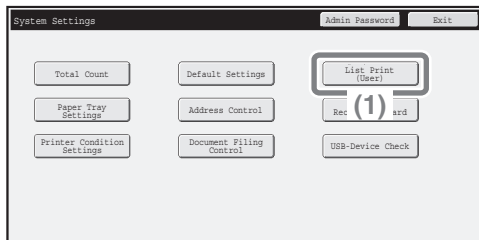

(1) Touch the [List Print (User)] key.

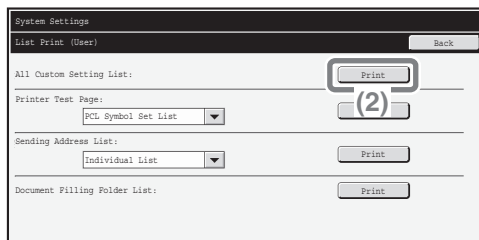

(2) Touch the [Print] key to the right of "All Custom Setting List".

The IP address is shown in the list that is printed.

PART NAMES AND FUNCTIONS

EXTERIOR

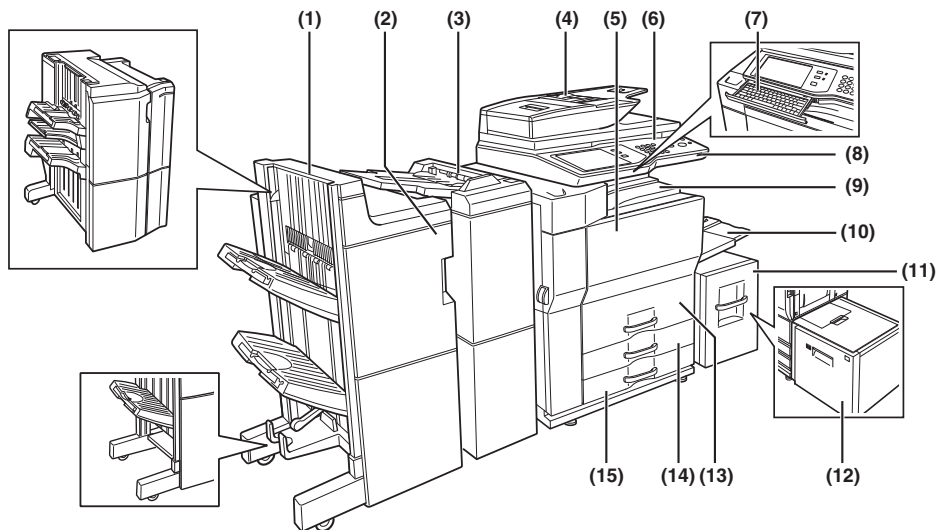

(1) Saddle stitch finisher (MX-FN16)*

Output device that enables the use of the staple function and offset function.

Finisher (MX-FN15)*

Output device that enables use of the staple function, offset function and pamphlet copy function.

Finisher (3 trays)*

Output device that enables use of the staple function for up to 100 sheets (8-1/2" x 11" size paper).

(2) Punch module (AR-PN4B)*

Punches holes in copies and other output. Requires finisher (MX-FN15) or saddle stitch finisher (MX-FN16).

(3) Inserter (MX-CF10)*

Paper set in an inserter can be inserted into output as covers or inserts. The inserter can be used to staple output and punch holes manually.

(4) Automatic document feeder

This automatically feeds and scans multiple sheet originals. Both sides of two-sided originals can be scanned at once.

(5) Front cover

Open to replace toner cartridge.

(6) Operation panel

This is used to select functions and enter the number of copies.

(7) Keyboard*

This is a keyboard that is incorporated into the machine. When not used, it can be stored under the operation panel.

(8) USB connector (A type)

Supports USB 2.0 (Hi-Speed). This is used to connect a USB device such as USB memory to the machine. For the USB cable, use a shielded cable.

(9) Center tray

Finished sheets are deposited here.

(10) Bypass tray

Special papers (including transparency film) and copy paper can be fed from the bypass tray.

(11) Tray 5 (when A4 large capacity tray is installed) (MX-LC10)*

This holds paper.

(12) Tray 5 (when A3 large capacity tray is installed) (MX-LCX3N)*

This holds paper.

(13) Tray 1-Tray 2

The trays hold paper. Approximately 800 sheets of standard 8-1/2" x 11" or A4 size paper (20 lbs. (80 g/m²)) can be loaded in tray 1, and approximately 1200 sheets of standard 8-1/2" x 11" or A4 size paper (20 lbs. (80 g/m²)) can be loaded in tray 2.

(14) Tray 3

Tray 3 holds paper. Approximately 500 sheets of standard (20 lbs. (80 g/m²)) paper can be loaded in this tray. Tabbed paper and transparencies can also be loaded.

(15) Tray 4

Tray 4 holds paper. Approximately 500 sheets of standard (20 lbs. (80 g/m²)) paper can be loaded in this tray.

* Peripheral device. For more information, see "PERIPHERAL DEVICES" in "1. BEFORE USING THE MACHINE" in the Operation Guide.

AUTOMATIC DOCUMENT FEEDER AND DOCUMENT GLASS

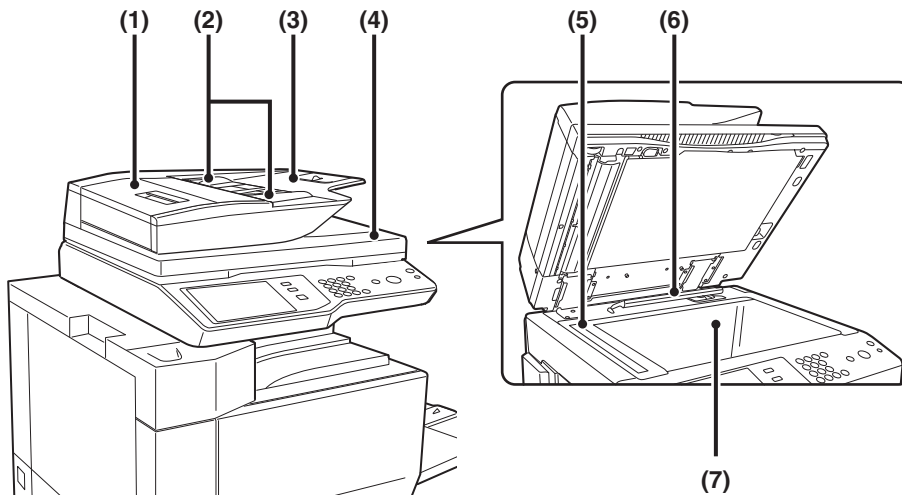

(1) Document feeding area cover

Open this cover to remove an original misfeed or clean the paper feed roller.

(2) Original guides

These help ensure that the original is scanned correctly. Adjust the guides to the width of the original.

(3) Document feeder tray

Place originals in this tray. 1-sided originals must be placed face up.

(4) Original exit tray

Originals are delivered to this tray after scanning.

(5) Scanning area

Originals placed in the document feeder tray are scanned here.

(6) Original size detector

This detects the size of an original placed on the document glass.

(7) Document glass

Use this to scan a book or other thick original that cannot be fed through the automatic document feeder.

SIDE AND BACK

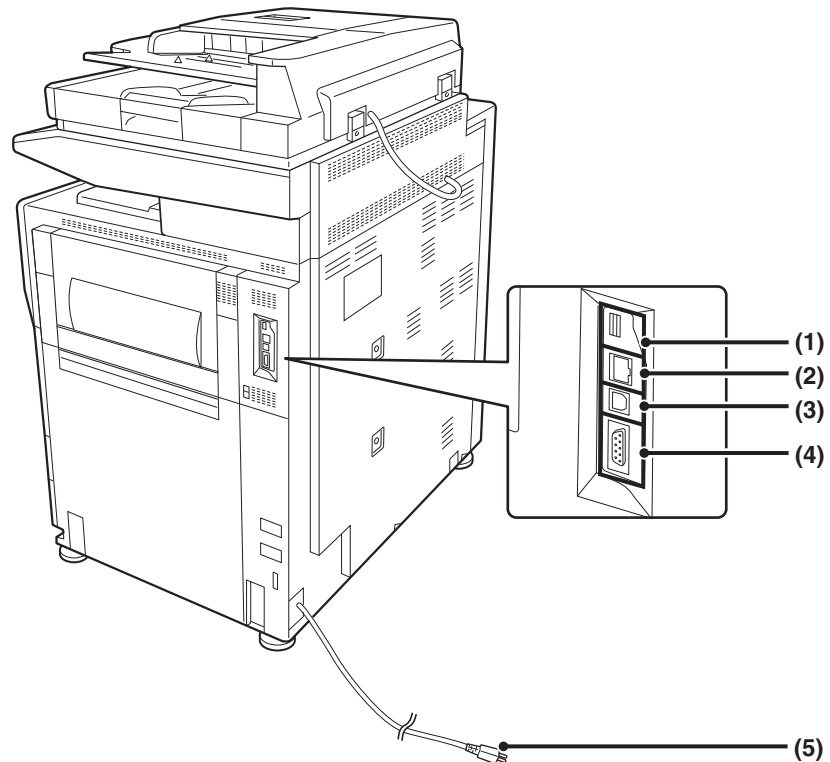

(1) USB connector (A type)

Supports USB 2.0 (Hi-Speed).
This is used to connect a USB device such as USB memory to the machine.

(2) LAN connector

Connect the LAN cable to this connector when the machine is used on a network.
For the LAN cable, use a shielded type cable.

(3) USB connector (B type)

Supports USB 2.0 (Hi-Speed).
A computer can be connected to this connector to use the machine as a printer.
For the USB cable, use a shielded cable.

(4) Service-only connector

(5) Power plug

OPERATION PANEL

Image send indicators

LINE indicator

This lights up during transmission or reception in fax mode. The indicator also lights up during transmission in scan mode.

DATA indicator

When a received fax cannot be printed because of a problem such as out of paper, the indicator blinks. The indicator lights steadily when there is data that is waiting to be transmitted.

Touch panel

Messages and keys appear in the LCD display. Operations are performed by touching the keys with your fingers.

[JOB STATUS] key

Press this key to view the job status screen. You can check the status of jobs and cancel jobs in the job status screen.

Print mode indicators

READY indicator

Print data can be received when this indicator is lit.

DATA indicator

This blinks while print data is being received and lights steadily while printing is taking place.

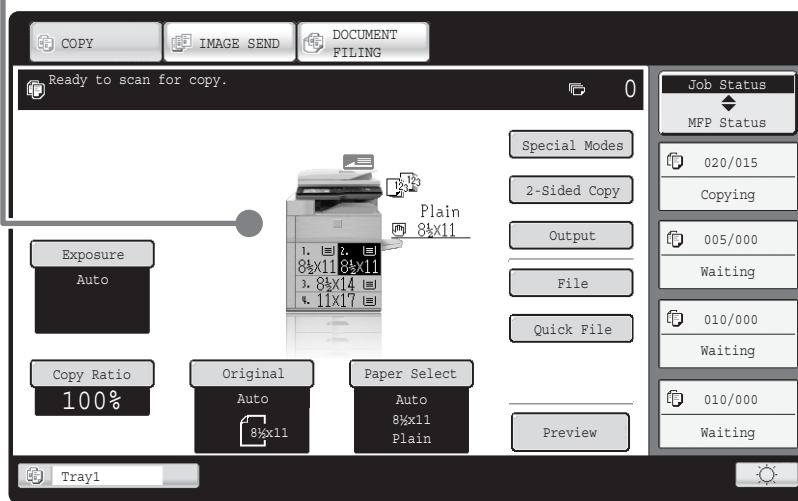

JOB STATUS

PRINT
 READY
 DATA

SYSTEM SETTINGS

IMAGE SEND
 LINE
 DATA

HOME

[SYSTEM SETTINGS] key

Press this key to display the system settings screen. The system settings can be adjusted to make the machine easier to use, such as configuring paper tray settings and storing addresses.

[HOME] key

Touch this key to display the home screen. Keys of frequently used functions can be registered in this screen for quick access, making the machine easier to use.

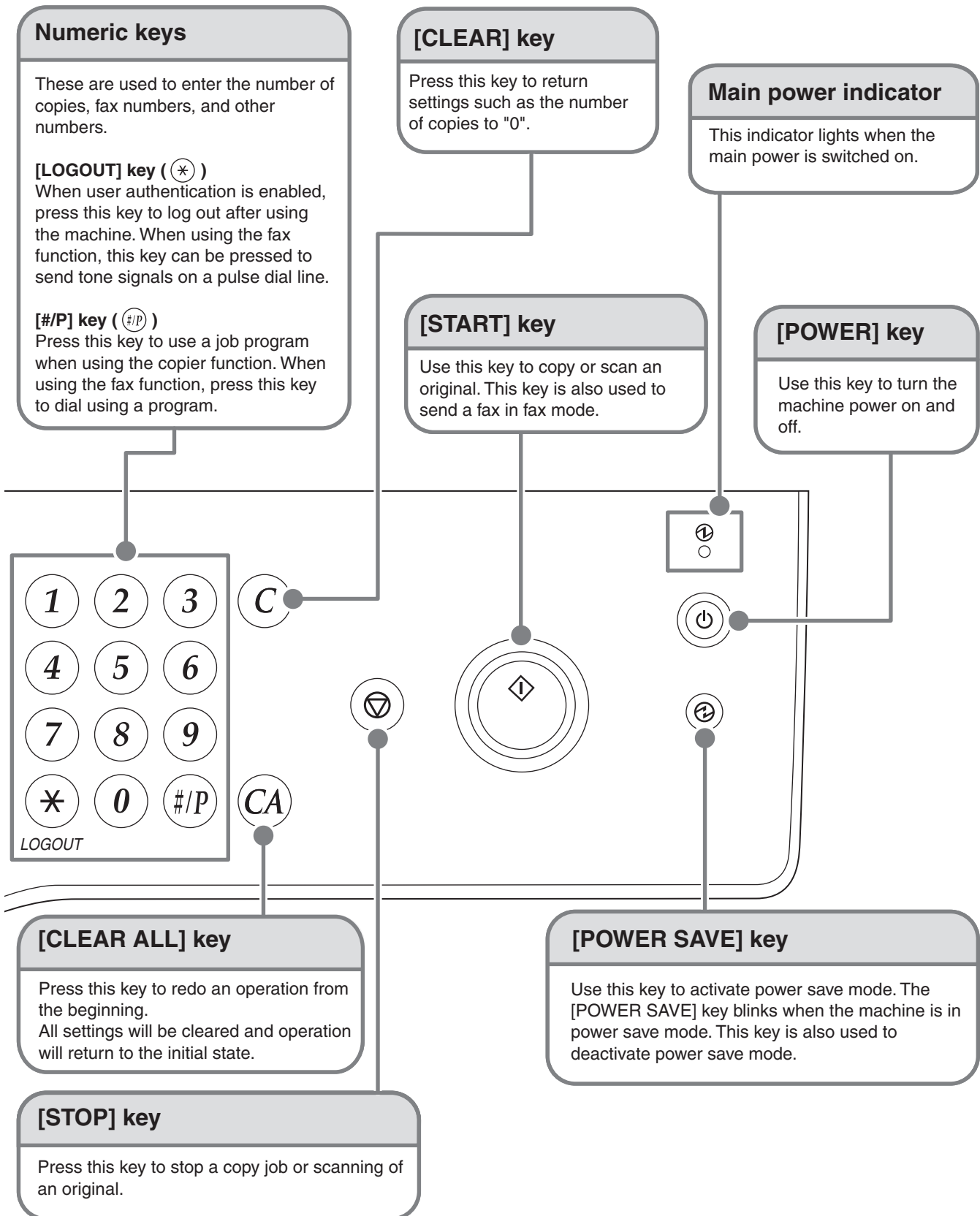

TURNING THE POWER ON AND OFF

The machine has two power switches. The main power switch is at the top right after the front cover is opened. The other power switch is the [POWER] key (⏻) on the operation panel at the top right.

Main power switch

When the main power switch is switched on, the main power indicator on the operation panel lights up.

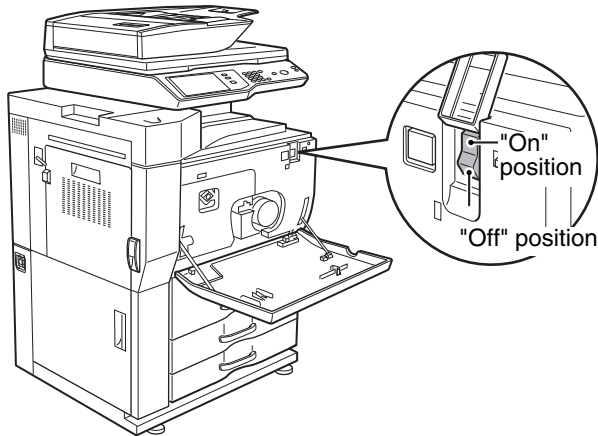

[POWER] key

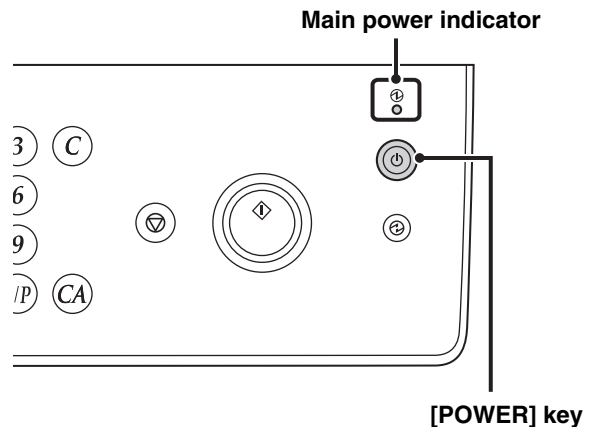

Turning on the power

- (1) Switch the main power switch to the "on" position.
- (2) Press the [POWER] key (⏻) to turn on the power.

Turning off the power

- (1) Press the [POWER] key (⏻) to turn off the power.
- (2) Switch the main power switch to the "off" position.

- ⚠ Before switching off the main power switch, make sure that the DATA indicator for printing and the DATA and LINE indicators for image send are not lit or blinking on the operation panel. Switching off the main power switch or removing the power cord from the outlet while any of the indicators are lit or blinking may damage the hard drive and cause data to be lost.
- Switch off both the [POWER] key (⏻) and the main power switch and unplug the power cord if you suspect a machine failure, if there is a bad thunderstorm nearby, or when you are moving the machine.

- ✎ When using the fax or Internet fax function, always keep the main power switch in the "on" position.

Restarting the machine

In order for some settings to take effect, the machine must be restarted.

If a message in the touch panel prompts you to restart the machine, press the [POWER] key (⏻) to turn off the power and then press the key again to turn the power back on.

- ✎ In some states of the machine, pressing the [POWER] key (⏻) to restart will not make the settings take effect. In this case, use the main power switch to switch the power off and then on.

PLACING ORIGINALS

The automatic document feeder can be used to automatically scan many originals at once. This saves you the trouble of manually feeding each original.

For originals that cannot be scanned using the automatic document feeder, such as a book or a document with notes attached, use the document glass.

Using the automatic document feeder

When using the automatic document feeder, place the originals in the document feeder tray. Make sure an original has not been placed on the document glass.

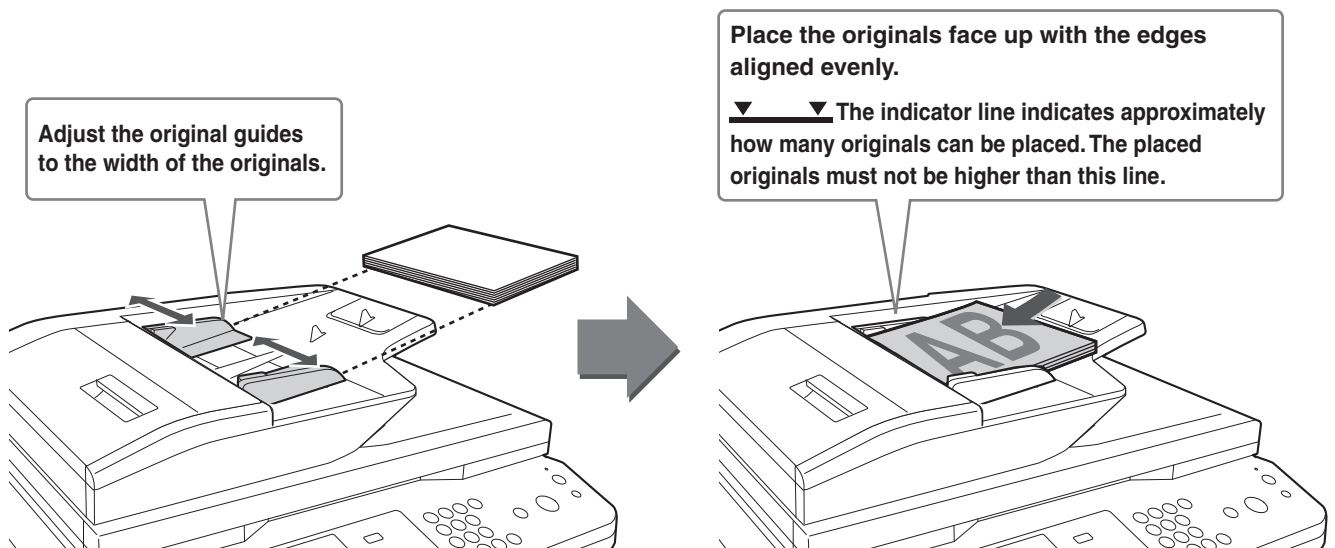

Using the document glass

Take care that your fingers are not pinched when closing the automatic document feeder.

After placing the original, be sure to close the automatic document feeder. If left open, parts outside of the original will be copied black, causing excessive use of toner.

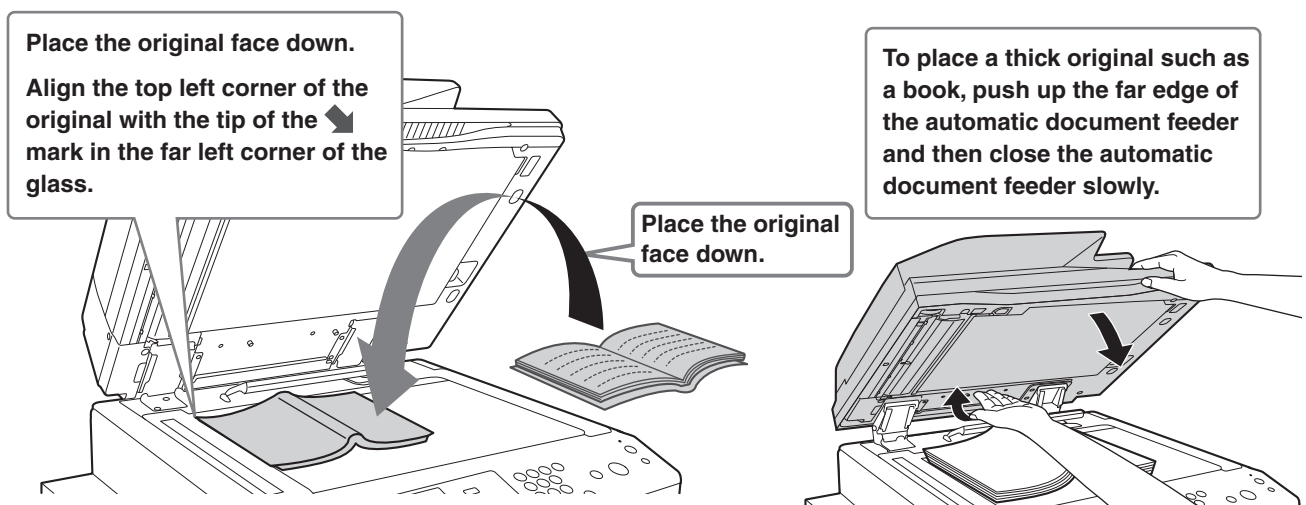

USEABLE PAPER

Various types of paper are sold. This section explains what plain paper and what special media can be used with the machine. For detailed information on the sizes and types of paper that can be loaded in each tray of the machine, see the specifications in this manual and "Paper Tray Settings" (page 7-13) in "7. SYSTEM SETTINGS" of the Operation Guide.

Plain paper, special media

Plain paper that can be used

- SHARP standard plain paper (21 lbs. (80 g/m²)). For paper specifications, see the specifications in this manual.
- Plain paper other than SHARP standard paper (16 lbs. to 28 lbs. (60 g/m² to 105 g/m²))
- Recycled paper, colored paper and pre-punched paper must meet the same specifications as plain paper. Contact your dealer or nearest SHARP Service Department for advice on using these types of paper.

Types of paper that can be used in each tray

The following types of paper can be loaded in each tray.

	Tray 1/ Tray 2	Tray 3	Tray 4	Bypass tray	Tray 5 (A4 large capacity tray)	Tray 5 (A3 large capacity tray)	Inserter
Plain paper	Permitted	Permitted	Permitted	Permitted	Permitted	Permitted	Permitted
Pre-printed	Permitted	Permitted	Permitted	Permitted	Permitted	Permitted	Permitted
Recycle Paper	Permitted	Permitted	Permitted	Permitted	Permitted	Permitted	Permitted
Letter head	Permitted	Permitted	Permitted	Permitted	Permitted	Permitted	Permitted
Pre-punched	Permitted	Permitted	Permitted	Permitted	Permitted	Permitted	Permitted
Color	Permitted	Permitted	Permitted	Permitted	Permitted	Permitted	Permitted
Heavy paper*1	–	Permitted	Permitted	Permitted	–	–	Permitted
Labels	–	Permitted	–	Permitted	–	–	–
Transparency film	–	Permitted	–	Permitted	–	–	Permitted*2
Tab paper	–	Permitted	–	Permitted	–	–	Permitted

*1 Paper weights of up to 110 lbs. (209 g/m²) can be used. Paper weights of up to 140 lbs. (256 g/m²) can be used with the inserter.

*2 Depending on the type of transparency film used, a double feed may occur. In this case, feed one sheet into the tray at a time.

Print side face up or face down

Paper is loaded with the print side face up or face down depending on the paper type and tray.

Trays 1 to 4

Load the paper with the print side face up.

However, if the paper type is "Letter Head" or "Pre-Printed", load the paper with the print side face down*.

Bypass tray and tray 5

Load the paper with the print side face up.

However, if the paper type is "Letter Head" or "Pre-Printed", load the paper with the print side face down*.

*If "Disabling of Duplex" is enabled in the system settings (administrator), load the paper with the print side face up.

Paper that cannot be used

- Special media for inkjet printers (fine paper, glossy paper, glossy film, etc.)
- Carbon paper or thermal paper
- Pasted paper
- Paper with clips
- Paper with fold marks
- Torn paper
- Oil-feed transparency film
- Thin paper less than 15 lbs. (56 g/m²)
- Paper that is 80 lbs. (210 g/m²) or heavier
- Irregularly shaped paper
- Stapled paper
- Damp paper
- Curled paper
- Paper on which either the print side or the reverse side has been printed on by another printer or multifunction device.
- Paper with a wave-like pattern due to moisture absorption
- Envelopes

Non-recommended paper

- Iron-on transfer paper
- Japanese paper
- Perforated paper



- Various types of plain paper and special media are sold. Some types cannot be used with the machine. Contact your dealer or nearest SHARP Service Department for advice on using these types of paper.
- The image quality and toner fusibility of paper may change due to ambient conditions, operating conditions, and paper characteristics, resulting in image quality inferior to that of SHARP standard paper. Contact your dealer or nearest SHARP Service Department for advice on using these types of paper.
- The use of non-recommended or prohibited paper may result in skewed feeding, misfeeds, poor toner fusing (the toner does not adhere to the paper well and can be rubbed off), or machine failure.
- The use of non-recommended paper may result in misfeeds or poor image quality. Before using non-recommended paper, check if printing can be performed properly.

LOADING PAPER IN A TRAY

Names of the trays

The names of the trays are shown below.

For the number of sheets of paper that can be loaded in each tray, see the following manuals:

- Operation Guide, "Paper Tray Settings" in "7. SYSTEM SETTINGS"
- Start Guide (this manual), "SPECIFICATIONS"

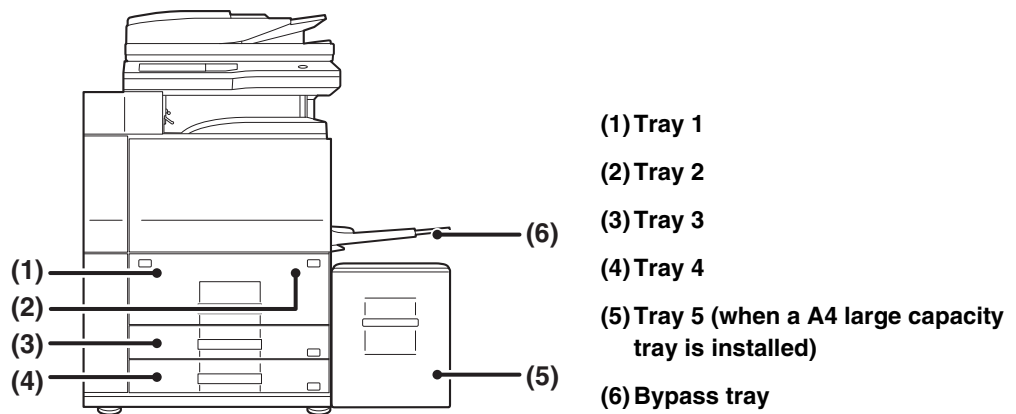

Loading paper in paper tray 1 - tray 2

8-1/2" x 11" or A4 size paper can be loaded in tray 1 and tray 2. If you wish to change the paper size of tray 1 or tray 2, see "CHANGING THE PAPER SIZE IN PAPER TRAY 1 - TRAY 2" in the Operation Guide.

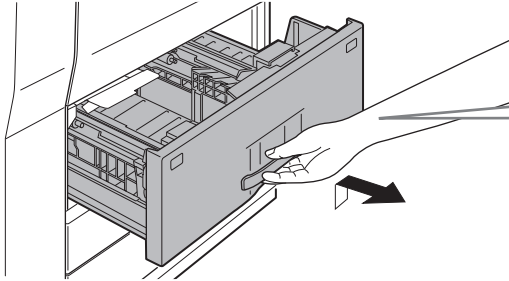

Gently pull out the paper tray.

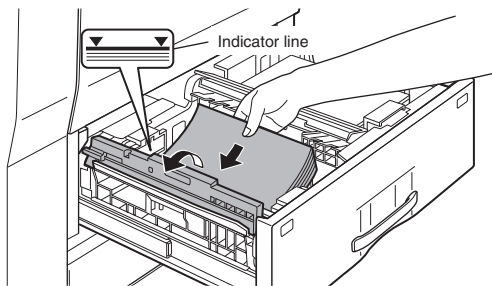

Load paper in the left and right trays.

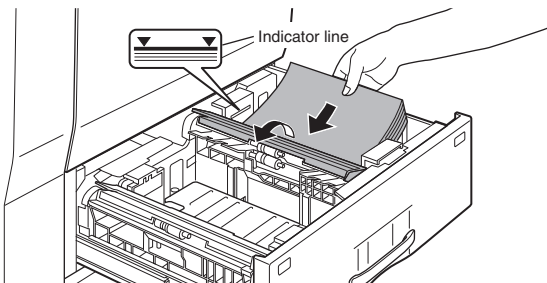

Insert the paper with the print side face up.
Fan the paper well before inserting it.
Otherwise, multiple sheets may feed at once and cause a misfeed.
Insert the paper and then gently push the tray into the machine.

 **Indicator line**
The indicator line indicates the maximum height of the paper that can be loaded in the tray. When loading paper, make sure that the stack is not higher than the indicator line.

To load the paper in tray 3 and tray 4, see "TRAY SETTINGS FOR TRAY 1 TO 4" in the Operation Guide.

Changing the tray settings

When you change the paper in a tray, the tray settings in the system settings must also be changed.

- 1

SYSTEM SETTINGS

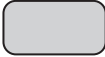

Press the [SYSTEM SETTINGS] key.
- 2

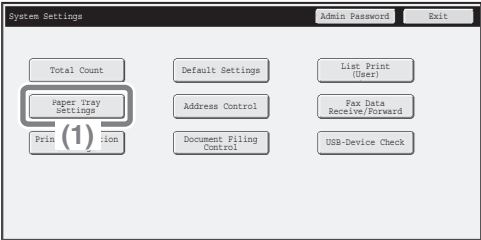

Configure the tray settings in the touch panel.

(1) Touch the [Paper Tray Settings] key.

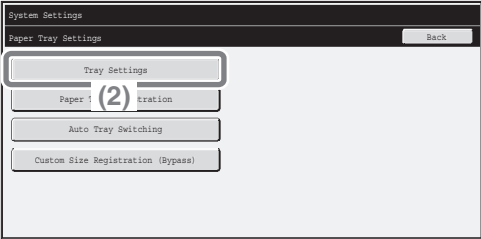

(2) Touch the [Tray Settings] key.

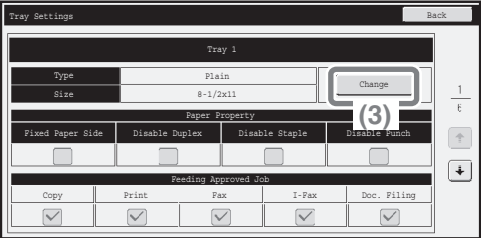

(3) Touch the [Change] key in "Tray 1".

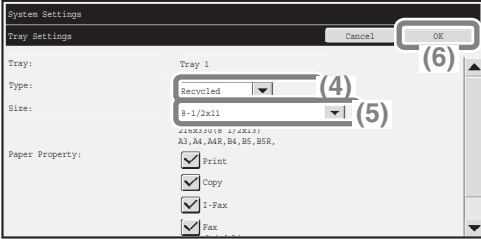

(4) Select [Recycled] from the "Type" select box.

(5) Make sure that [Auto-Inch] is selected in the "Size" select box.

For more information, see "Paper Tray Settings" in "7. SYSTEM SETTINGS" in the Operation Guide.

(6) Touch the [OK] key.

The above steps change the paper settings for tray 1 to 8-1/2" x 11" recycled paper.

Loading paper in other trays

Bypass tray

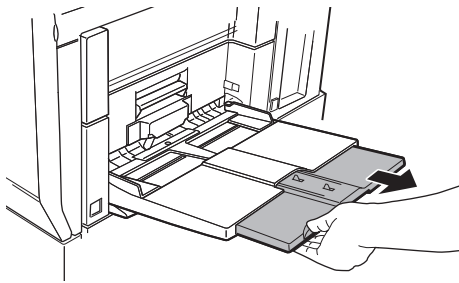
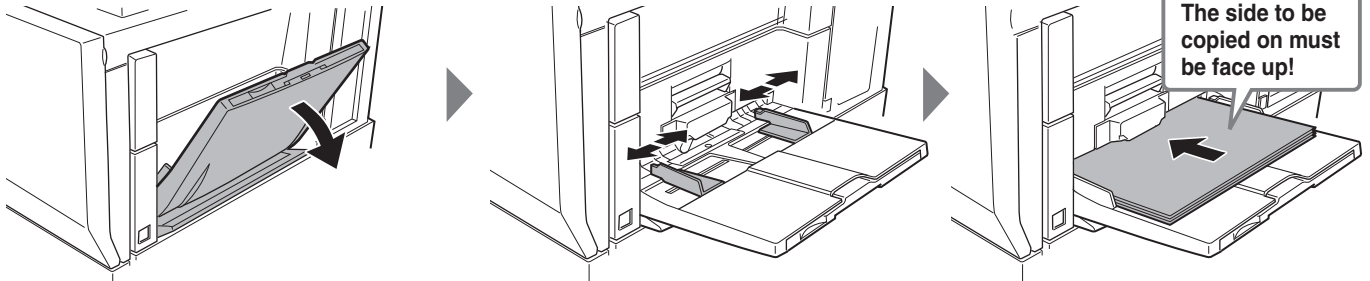

When loading 11" x 17", 8-1/2" x 14", 8-1/2" x 13", 8-1/2" x 11"R, A3, B4, or A4R size paper, pull out the tray extension.
The maximum number of sheets that can be loaded in the bypass tray is approximately 100 for plain paper.

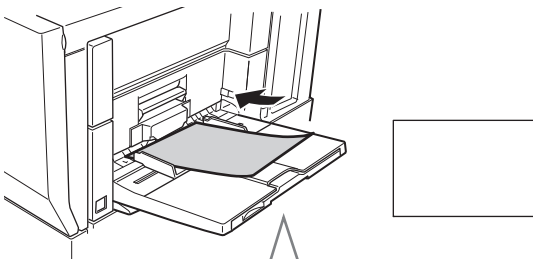

Place paper that is 7-1/4" x 10-1/2" (A5) or smaller in the horizontal orientation.

Special types of paper that cannot be loaded in other trays can be loaded in the bypass tray. For detailed information on the bypass tray, see "LOADING PAPER IN THE BYPASS TRAY" in "1. BEFORE USING THE MACHINE" in the Operation Guide.

A4 large capacity tray

The paper size of tray 5 can only be changed by a service technician.

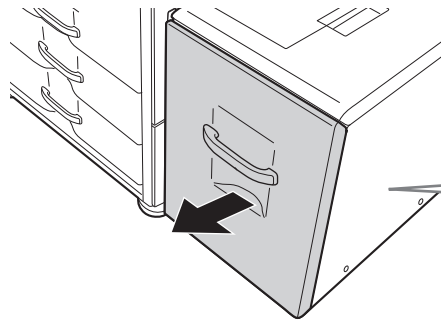

Gently pull out the paper tray.

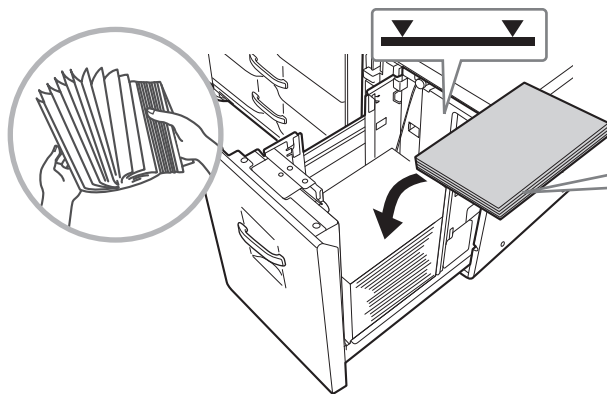

Insert the paper with the print side face up.
Fan the paper well before inserting it.
Otherwise, multiple sheets may feed at once and cause a misfeed.
Insert the paper and then gently push the tray into the machine.

Indicator line
The indicator line indicates the maximum height of the paper that can be loaded in the tray. When loading paper, make sure that the stack is not higher than the indicator line.

Do not load as shown below.



A3 large capacity tray

To change the paper size of tray 5, see "TRAY SETTINGS OF TRAY 5 (A4 LARGE CAPACITY TRAY)" in the Operation Guide.

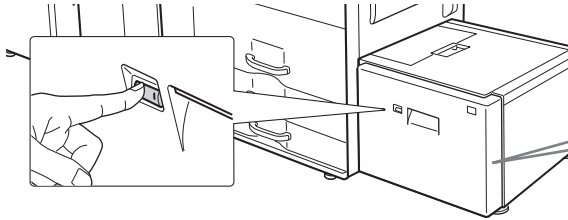

Press the operation button and wait until the operation button indicator turns off.

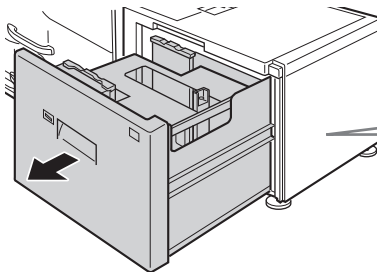

Gently pull out the paper tray.

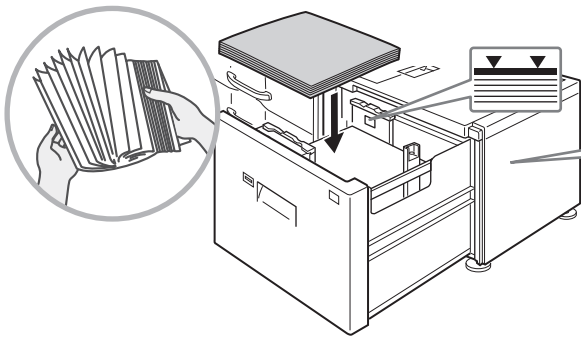

Insert the paper with the print side face up.
Fan the paper well before inserting it. Otherwise, multiple sheets may feed at once and cause a misfeed.
Insert the paper and then gently push the tray into the machine.

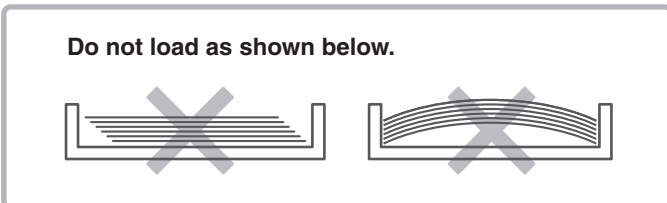

Indicator line
The indicator line indicates the maximum height of the paper that can be loaded in the tray. When loading paper, make sure that the stack is not higher than the indicator line.

BEFORE INSTALLING THE SOFTWARE

This chapter describes the software programs that allow you to use the printer and scanner functions of the machine, the CD-ROMs that contain the software, and the pages where the basic installation procedures can be found. For details on installation procedures, refer to Chapter 1 of the Operation Guide.

CD-ROMS AND SOFTWARE

The software that can be used with the machine is on the CD-ROMs that accompany the machine and the expansion kits. Before installing the software, make sure that your computer and the machine meet the system requirements described in "VERIFYING SYSTEM REQUIREMENTS" (page 28).

SOFTWARE CD-ROM

The printer expansion kit is required for U models.

The "Software CD-ROM" that accompanies the machine contains the printer driver and other software. The "Software CD-ROM" consists of 2 discs.



For users of Mac OS 9.0 to 9.2.2/X10.2.8/X10.3.9

- The CD-ROM does not include software for Mac OS 9.0 to 9.2.2/X10.2.8/X10.3.9. Contact your dealer or nearest authorized service representative if you want software for Mac OS 9.0 to 9.2.2/X10.2.8/X10.3.9.
- The CD-ROM does not include printer driver for PCL5e. Contact your dealer or nearest authorized service representative if you want printer driver for PCL5e.

Disc 1

Software for Windows

• **Printer driver**

These allow the machine to be used as a printer.

- **PCL6 printer driver**

The machine supports the Hewlett-Packard PCL6 printer control languages.

- **PS printer driver**

The PS printer driver supports the PostScript 3 page description language developed by Adobe Systems Incorporated.

- **PPD driver**

The PPD driver enables the machine to use the standard Windows PS printer driver.

☞ WHEN THE MACHINE IS CONNECTED TO A NETWORK (page 32)

☞ WHEN THE MACHINE WILL BE CONNECTED WITH A USB CABLE (page 1-91 in the Operation Guide)

• **Printer Status Monitor (can only be used when the machine is connected to a network)**

This allows you to monitor the status of the machine on your computer screen.

☞ INSTALLING THE PRINTER STATUS MONITOR (page 1-101 in the Operation Guide)

Software for Macintosh

• **PPD file**

This is the printer description file which enables the machine to be used as a PostScript 3 compatible printer. The PS3 expansion kit is required to use the machine in a Macintosh environment.

☞ MAC OS X (page 1-109 in the Operation Guide)

☞ MAC OS 9.0 - 9.2.2 (page 1-115 in the Operation Guide)

- The PS3 expansion kit is required to use the machine as a printer in a Macintosh environment. In addition, the machine must be connected to a network. A USB connection cannot be used.
- The scanner driver and PC-Fax driver cannot be used in a Macintosh environment.

Disc 2

Software for Windows

- **PC-Fax driver**

This enables you to send a file from your computer as a fax using the same procedure as when printing the file. (When the fax option is installed.)

Even if the fax function is not installed, the PC-Fax driver can be updated using the CD-ROM in the Internet fax expansion kit to enable you to send a file from your computer as an Internet fax in the same way as you print a file.

☞ INSTALLING THE PRINTER DRIVER / PC-FAX DRIVER (page 32)

The following software can be used only when the machine is connected to a network.

- **Scanner driver (TWAIN driver)**

This allows you to use the scanner function of the machine from a TWAIN-compliant software application.

☞ INSTALLING THE SCANNER DRIVER (page 1-102 in the Operation Guide)

- **Printer Administration Utility**

This allows the administrator to monitor the machine and configure machine settings from a computer. To install and use the Printer Administration Utility, see the Readme file and the manual in PDF format on the "Software CD-ROM" (Disc 2). The Readme file and manual are in the following folder on the CD-ROM. (Substitute the letter of your CD-ROM drive for "R" in the following path.)

R:\Sadmin\Documents\EnglishA

OTHER CD-ROMS

▶ "PRINTER UTILITIES" CD-ROM that accompanies the PS3 expansion kit (for Windows/Macintosh)

This contains the display fonts that are used with the PS printer driver.

(Install the PS printer driver and Macintosh PPD file from the "Software CD-ROM".)

☞ INSTALLING THE PS DISPLAY FONTS (page 1-104 in the Operation Guide)

▶ "PRINTER UTILITIES" CD-ROM that accompanies the Internet fax expansion kit (for Windows)

This CD-ROM is used to update the PC-Fax driver on the "Software CD-ROM" so that it can be used to send Internet faxes (PC-I-Fax function).

If you wish to use the PC-I-Fax function, first install the PC-Fax driver from the "Software CD-ROM" and then run the installer on this CD-ROM. If the PC-Fax driver is already installed, run only the installer. (There is no need to reinstall the PC-Fax driver.)

☞ INSTALLING THE PRINTER DRIVER / PC-FAX DRIVER (page 32)

▶ "Sharpdesk/Network Scanner Utilities" CD-ROM (for Windows) (MX-M623N/MX-M753N only)

This contains software that helps you get the most out of the images that you scan on the machine. The software includes "Sharpdesk", a desktop document management application that enables integrated management of scanned images and files created using a variety of applications. To use the "Scan to Desktop" scanner function, the "Network Scanner Tool" must be installed from the CD-ROM.

For the system requirements of the software, see the manual (PDF format) in the "Manual" folder or the Readme file on the CD-ROM. For the procedures for installing the software, see the "Sharpdesk Installation Guide".

VERIFYING SYSTEM REQUIREMENTS

SYSTEM REQUIREMENTS

Before installing the software described in this manual, make sure that your computer satisfies the following requirements.

	Windows*1	Macintosh*6
Operating system	Windows 2000 Professional, Windows XP Professional*2, Windows XP Home Edition, Windows 2000 Server, Windows Server 2003*2, Windows Vista*2, Windows Server 2008*2, Windows 7*2*3	Mac OS 9.0 to 9.2.2, Mac OS X v10.2.8, Mac OS X v10.3.9, Mac OS X v10.4.11, Mac OS X v10.5 to 10.5.8, Mac OS X v10.6 to 10.6.1
Computer type	IBM PC/AT compatible computer Equipped with a 10Base-T/100Base-TX/1000Base-T LAN board or equipped standard with a USB 2.0*4/1.1*5 port.	An environment in which any of the operating systems listed above can fully operate (including Macintosh computers with an Intel processor).
Display	1024 x 768 dots resolution and 16-bit color or higher is recommended.	
Other hardware requirements	An environment that allows any of the above operating systems to fully operate.	

*1 The PCL5e printer driver will not run on any of the 64-bit editions of the Windows operating systems, including Windows Server 2008, or Windows 7.

*2 Includes the 64-bit edition.

*3 Printer Administration Utility 4.2 is not compatible with Windows 7.

*4 The machine's USB 2.0 port will transfer data at the speed specified by the USB 2.0 (Hi-Speed) standard only if the Microsoft USB 2.0 driver is preinstalled in the computer, or if the USB 2.0 driver for Windows 2000 Professional/XP/Vista that Microsoft provides through "Windows Update" is installed.

*5 Compatible with models preinstalled with Windows 2000 Professional, Windows XP Professional, Windows XP Home Edition, Windows 2000 Server, Windows Server 2003, Windows Vista, Windows Server 2008 or Windows 7, and which are equipped standard with a USB interface.

*6 Cannot be used when the machine is connected with a USB cable. The PC-Fax driver and scanner driver cannot be used.



• **For users of Mac OS 9.0 to 9.2.2/X10.2.8/X10.3.9**

The CD-ROM does not include software for Mac OS 9.0 to 9.2.2/X10.2.8/X10.3.9
Contact your dealer or nearest authorized service representative if you want software.

• **For users of Windows 2000/XP/Server 2003/Vista/Server 2008/7**

To perform the procedures described in this manual such as installing the software and configuring settings after installation, administrator authority is required.

SOFTWARE REQUIREMENTS

The following requirements must be met to use the software described in this manual.

Operating system environment*1	Software	Required expansion kits	Type of connection*1
Windows	PCL6 printer driver, PCL5e printer driver	Printer expansion kit*2	Network/ USB
	PS printer driver, PPD driver	Printer expansion kit*2 PS3 expansion kit	
	PC-Fax driver*3	Facsimile expansion kit*4	
	Scanner driver	Network scanner expansion kit*5	Network only*6 (cannot be used with a USB connection)
	Printer Status Monitor	Can be used in the standard configuration.	
	Printer Administration Utility		
Macintosh	Macintosh PPD file	Printer expansion kit*2 PS3 expansion kit	

*1 For the types of computers and operating systems that can run the software, see "SYSTEM REQUIREMENTS" (page 28).

*2 The printer expansion kit is the standard equipment for N models.

*3 To use the PC-Fax driver, Internet Explorer 4.0 or later must be installed on your computer.

*4 When the Internet fax expansion kit is installed, the PC-Fax driver can be updated using the "PRINTER UTILITIES" CD-ROM to enable the driver to be used as a PC-I-Fax driver. In this case, the driver can be used without the facsimile expansion kit.

*5 The network scanner expansion kit is the standard equipment for N models.

*6 The scanner driver, Printer Status Monitor, and Printer Administration Utility cannot be used on an IPv6-only network.

CONNECTING THE MACHINE

CONNECTING TO A NETWORK

To connect the machine to a network, connect the LAN cable to the machine's network connector. Use a shielded LAN cable.

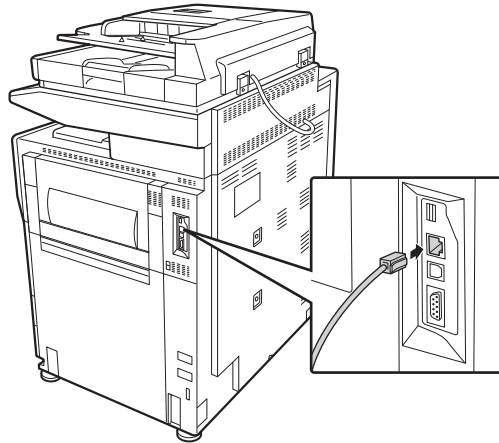

After connecting the machine to a network, be sure to configure the IP address and other network settings before installing the software. (The factory default setting for the IP address is to receive the IP address automatically when the machine is used in a DHCP environment.)

Network settings can be configured using "Network Settings" in the system settings (administrator) on the machine.

- **If the machine is used in a DHCP environment, the IP address of the machine may change. If this happens, printing will not be possible. This problem can be avoided by using a WINS server or by assigning a permanent IP address to the machine.**
- **This manual explains how to set up the software in a Windows network environment.**
- **To use the machine on an IPv6 network, the IPv6 setting must be enabled in "Network Settings" in the system settings (administrator).**

► Checking the IP address of the machine

You can check the IP address of the machine by printing out the "All Custom Setting List" in the system settings. Follow these steps to print out the "All Custom Setting List".

Press the [SYSTEM SETTINGS] key, touch the [List Print (User)] key, and then touch the [Print] key of "All Custom Setting List".

CONNECTING THE MACHINE WITH A USB CABLE (Windows)

The machine can be connected to a computer using a USB cable if the computer is a Windows computer. (The USB interface on the machine cannot be used in a Macintosh environment.)

The machine and computer should be connected while the printer driver is being installed. If a USB cable is connected before the printer driver is installed, the printer driver will not be installed correctly. For the procedure for connecting a USB cable, see "WHEN THE MACHINE WILL BE CONNECTED WITH A USB CABLE" (page 1-91 in the Operation Guide).

SETUP IN A WINDOWS ENVIRONMENT

This section explains how to install the software and configure settings so that the printer and scanner function of the machine can be used with a Windows computer. For more details regarding installation procedures and instructions for installation in Macintosh environments, see Chapter 1 of the Operation Guide.

OPENING THE SOFTWARE SELECTION SCREEN (FOR ALL SOFTWARE)

1 Insert the "Software CD-ROM" into your computer's CD-ROM drive.

- If you are installing the printer driver or printer status monitor, insert the "Software CD-ROM" that shows "Disc 1" on the front of the CD-ROM.
- If you are installing the PC-Fax driver or scanner driver, insert the "Software CD-ROM" that shows "Disc 2" on the front of the CD-ROM.

2 Click the [Start] button (), click [Computer], and then double-click the [CD-ROM] icon ().

- In Windows XP/Server 2003, click the [start] button, click [My Computer], and then double-click the [CD-ROM] icon.
- In Windows 2000, double-click [My Computer] and then double-click the [CD-ROM] icon.

3 Double-click the [Setup] icon ().

In Windows 7, if a message screen appears asking you for confirmation, click [Yes].



In Windows Vista/Server 2008, if a message screen appears asking you for confirmation, click [Allow].

4 The "SOFTWARE LICENSE" window will appear. Make sure that you understand the contents of the license agreement and then click the [Yes] button.



You can show the "SOFTWARE LICENSE" in a different language by selecting the desired language from the language menu. To install the software in the selected language, continue the installation with that language selected.

5 Read the message in the "Welcome" window and then click the [Next] button.

6 The software selection screen appears.

Before installing the software, be sure to click the [Display Readme] button and view the detailed information on the software.

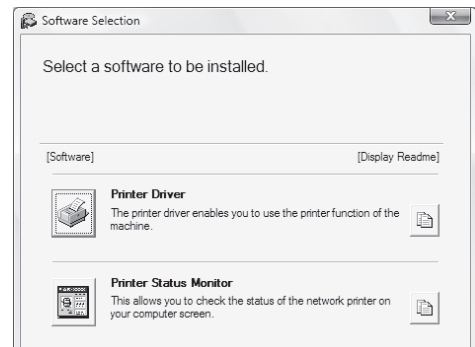

* The above screen appears when using the "Disc 1" CD-ROM.

For the steps that follow, see the appropriate page below for the software that you are installing.

INSTALLING THE PRINTER DRIVER / PC-FAX DRIVER

- **WHEN THE MACHINE IS CONNECTED TO A NETWORK***
 - Standard installation: page 32
 - Installation by specifying the machine's address: page 1-85 in the Operation Guide
 - Printing using the IPP function and the SSL function: page 1-88 in the Operation Guide
- **WHEN THE MACHINE WILL BE CONNECTED WITH A USB CABLE:** page 1-91 in the Operation Guide
- **USING THE MACHINE AS A SHARED PRINTER:** page 1-96 in the Operation Guide

INSTALLING THE PRINTER STATUS MONITOR: page 1-101 in the Operation Guide

INSTALLING THE SCANNER DRIVER: page 1-102 in the Operation Guide

* If the machine is being used on an IPv6 network, see "Installation by specifying the machine's address" (page 1-85 in the Operation Guide).

INSTALLING THE PRINTER DRIVER / PC-FAX DRIVER

To install the printer driver or the PC-Fax driver, follow the appropriate procedure in this section depending on whether the machine is connected to a network or connected by USB cable.

WHEN THE MACHINE WILL BE CONNECTED WITH A USB CABLE (page 1-91 in the Operation Guide)

WHEN THE MACHINE IS CONNECTED TO A NETWORK

This section explains how to install the printer driver and the PC-Fax driver when the machine is connected to a Windows network (TCP/IP network).

Supported operating systems: Windows 2000*/XP*/Server 2003*/Vista*/Server 2008*/7*

* Administrator's rights are required to install the software.

- The PS3 expansion kit is required to use the PS printer driver or the PPD driver.
- To print to the machine over the Internet using the IPP function when the machine is installed in a remote location, or to print using the SSL (encrypted communication) function, see "Printing using the IPP function and the SSL function" (page 1-88 in the Operation Guide) and install the printer driver or the PC-Fax driver.
- **If the machine is connected to an IPv6-only network**
The software cannot be installed by detecting the machine's address from the installer. After installing the software as explained in "Installation by specifying the machine's address" (page 1-85 in the Operation Guide), change the port as explained in "Changing to a Standard TCP/IP Port" (page 1-107 in the Operation Guide).
- The installation procedure in this section is for both the printer driver and the PC-Fax driver, although the explanations are centered on the printer driver.

► Standard installation

When the software selection screen appears in step 6 of "OPENING THE SOFTWARE SELECTION SCREEN (FOR ALL SOFTWARE)" (page 31), perform the steps below.

1 Click the [Printer Driver] button.

To install the PC-Fax driver, click the [PC-Fax Driver] button on the "Disc 2" CD-ROM.



* The above screen appears when using the "Disc 1" CD-ROM.

2 Click the [Standard installation] button.

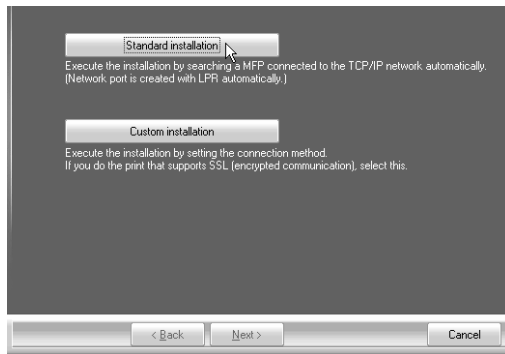

When [Custom installation] is selected, you can change any of the items below. When [Standard installation] is selected, the installation will take place as indicated below.

- Machine connection method: LPR Direct Print (Auto Search)
- Set as default printer: Yes (excluding the PC-Fax driver)
- Printer driver name: Cannot be changed
- PCL printer display fonts: Installed

If you selected [Custom installation], select [LPR Direct Print (Auto Search)] and click the [Next] button. If you selected other than [LPR Direct Print (Auto Search)], see the following pages in the Operation Guide:

- LPR Direct Print (Specify Address): page 1-85
- IPP: page 1-88
- Shared printer: page 1-96
- Connected to this computer: page 1-91

3 Printers connected to the network are detected. Select the machine and click the [Next] button.

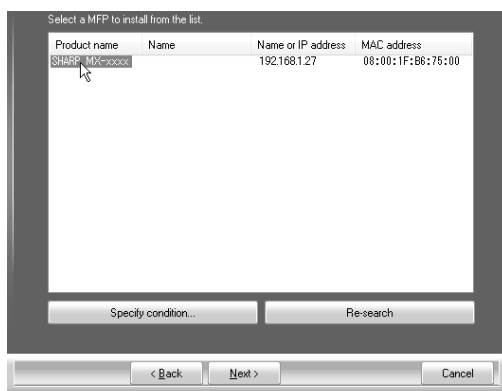

- If the machine is not found, make sure that the machine is powered on and that the machine is connected to the network, and then click the [Re-search] button.
- You can also click the [Specify condition] button and search for the machine by entering the machine's name (host name) or IP address.
 - Checking the IP address of the machine (page 30)

4 A confirmation window appears. Check the contents and then click the [Next] button.

5 When the printer driver selection window appears, select the printer driver to be installed and click the [Next] button.

Click the checkbox of the printer driver to be installed so that a checkmark () appears.

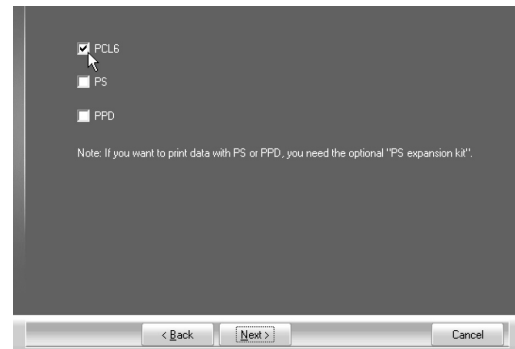

- When the PC-Fax driver is being installed, this screen does not appear. Go to the next step.
- The PS3 expansion kit is required to use the PS printer driver or the PPD driver.
- The [PPD] checkbox only appears if you are using Windows 2000/XP/Server 2003/Vista/Server 2008/7.

6 When you are asked whether or not you want the printer to be your default printer, make a selection and click the [Next] button.

If you are installing multiple drivers, select the printer driver to be used as the default printer.

If you do not wish to set one of the printer drivers as the default printer, select [No].



If you clicked the [Custom installation] button in step 2, the following windows will appear.

- **Printer name window**

If you wish to change the printer name, enter the desired name and click the [Next] button.

- **Window confirming installation of the display fonts**

To install the display fonts for the PCL printer driver, select [Yes] and click the [Next] button.

- When the PC-Fax driver is being installed, this screen does not appear. Go to the next step.
- If you are not installing the PCL printer driver (you are installing the PS printer driver or the PPD driver), select [No] and click the [Next] button.

7 Follow the on-screen instructions.

Read the message in the window that appears and click the [Next] button.

Installation begins.



- **If you are using Windows Vista/Server 2008/7**

If a security warning window appears, be sure to click [Install this driver software anyway].

- **If you are using Windows 2000/XP/Server 2003**

If a warning message regarding the Windows logo test or digital signature appears, be sure to click the [Continue Anyway] or [Yes] button.

8 When the installation completed screen appears, click the [OK] button.

9 Click the [Close] button in the window of step 1.



After the installation, a message prompting you to restart your computer may appear. If this message appears, click the [Yes] button to restart your computer.

This completes the installation.

- After installation, see "CONFIGURING THE PRINTER DRIVER FOR THE OPTIONS INSTALLED ON THE MACHINE" (page 1-98 in the Operation Guide) to configure the printer driver settings.
- If you installed the PS printer driver or the PPD driver, the PS display fonts can be installed from the "PRINTER UTILITIES" CD-ROM that accompanies the PS3 expansion kit. See "INSTALLING THE PS DISPLAY FONTS" (page 1-104 in the Operation Guide).
- If you are using the machine as a shared printer, see "USING THE MACHINE AS A SHARED PRINTER" (page 1-96 in the Operation Guide) to install the printer driver on each of the client computers.

MAINTENANCE

This section explains how to clean the machine and replace the toner cartridges.

REGULAR MAINTENANCE

To ensure that the machine continues to provide top quality performance, periodically clean the machine.

Warning

Do not use a flammable spray to clean the machine. If gas from the spray comes in contact with hot electrical components or the fusing unit inside the machine, fire or electrical shock may result.



- Do not use thinner, benzene, or similar volatile cleaning agents to clean the machine. These may degrade or discolor the housing.
- Use a soft cloth to gently wipe off dirt from the area on the operation panel with a mirror-like finish (shown at right). If you use a stiff cloth or rub hard, the surface may be damaged.

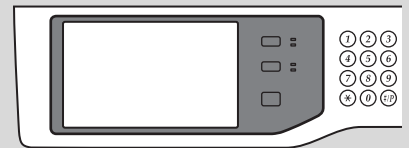

The area with a mirror-like finish is the area that is .

CLEANING THE DOCUMENT GLASS AND AUTOMATIC DOCUMENT FEEDER

If the document glass or document backplate sheet becomes dirty, the dirt will appear in the scanned image. Always keep these parts clean.

Wipe the parts with a clean, soft cloth.

If necessary, moisten the cloth with water or a small amount of neutral detergent. After wiping with the moistened cloth, wipe the parts dry with a clean dry cloth.

Document glass

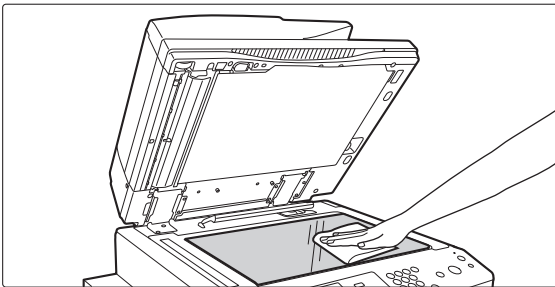

Document backplate sheet

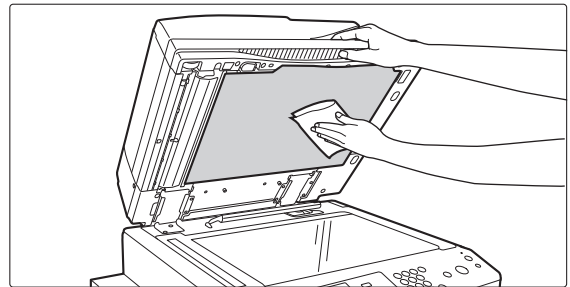

Scanning area

If black or white lines appear in images scanned using the automatic document feeder, clean the scanning area (the thin long glass next to the document glass).

To clean this area, use the glass cleaner that is stored in the automatic document feeder. After using the glass cleaner, be sure to return it to its storage position.

Examples of lines in the image

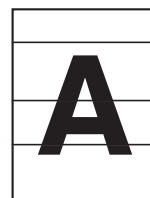

Black lines



White lines

1

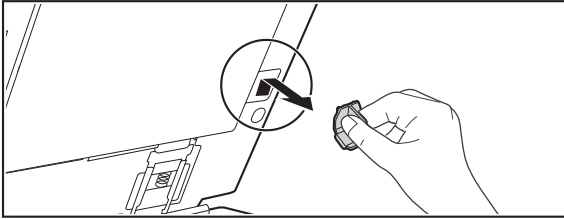

Open the automatic document feeder and remove the glass cleaner.

2

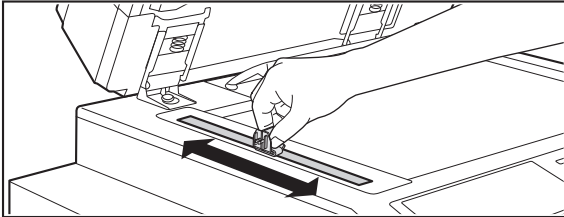

Clean the document scanning area on the document glass with the glass cleaner.
One scanning area is on the document glass and the other is inside the automatic document feeder.

3

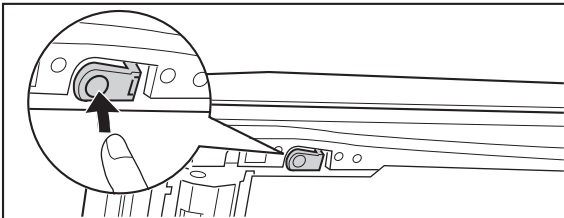

Clean the document scanning area in the automatic document feeder with the glass cleaner.

(1) Open the scanning area cover on the automatic document feeder.

Push in the release switch to release the cover.

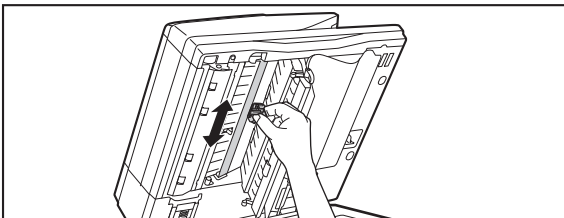

(2) Clean the scanning area in the automatic document feeder.

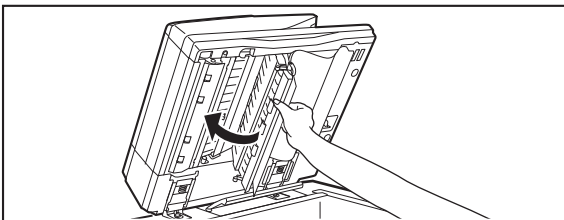

(3) Close the cover.

4

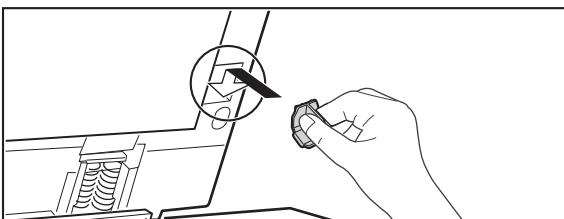

Replace the glass cleaner.

CLEANING THE BYPASS FEED ROLLER

If paper misfeeds frequently occur when feeding or heavy paper through the bypass tray, wipe the surface of the feed roller with a clean soft cloth moistened with water or a neutral detergent.

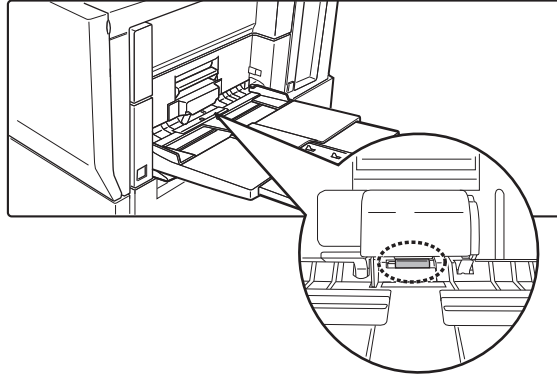

REPLACING THE TONER CARTRIDGES

Be sure to replace the toner cartridge when the message "Change the toner cartridge." appears.

In copy mode



Ready to scan for copy.
(Toner supply is low.)



Ready to scan for copy.
(Change the toner cartridge.)



If you continue to use the machine without replacing the cartridge, the following message will appear when the toner runs out.

When the message appears in the message display, replace the toner cartridge.

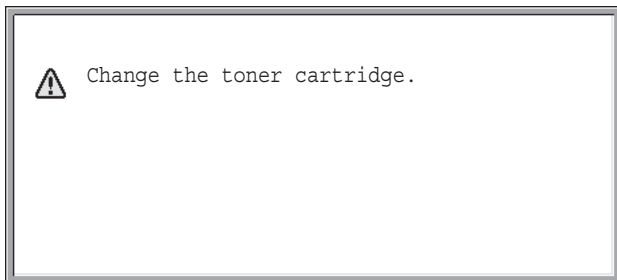

Change the toner cartridge.

1

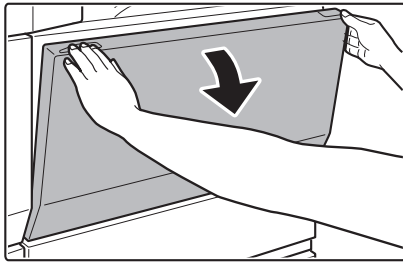

Open the front cover.

2

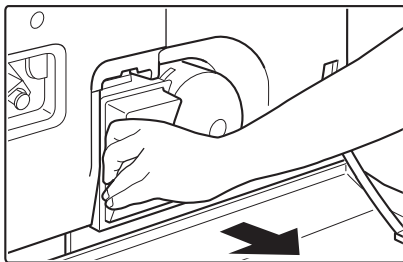

Clean the document scanning area on the document glass with the glass cleaner.

One scanning area is on the document glass and the other is inside the automatic document feeder.

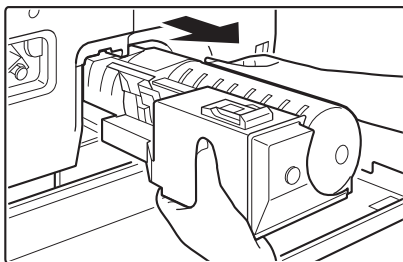

Hold the toner cartridge with both hands as shown in the illustration, and pull it out of the machine.

3

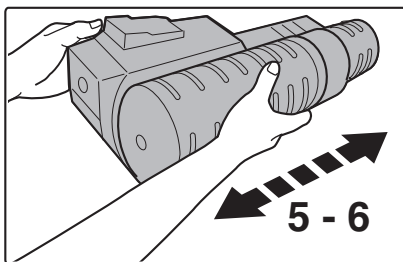

Remove the new toner cartridge from the box and shake it five or six times horizontally.

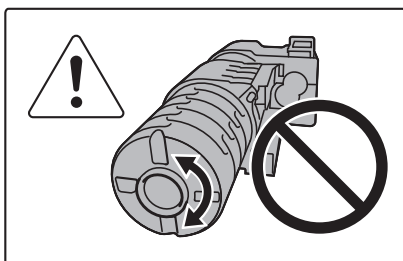

Shake the toner cartridge horizontally.
Do not rotate it as shown at left.



It is important to thoroughly shake the supply cartridge for 10 seconds as shown in the diagram in order to ensure proper operation of toner supply system.

4

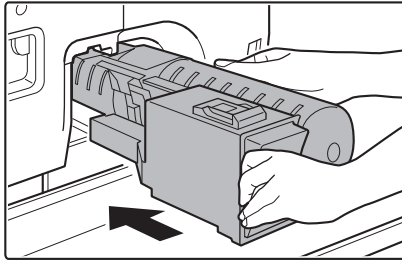

Insert the new toner cartridge.

Align the toner cartridge with the insert hole and push it in as shown.
Do not rotate the cartridge.

5

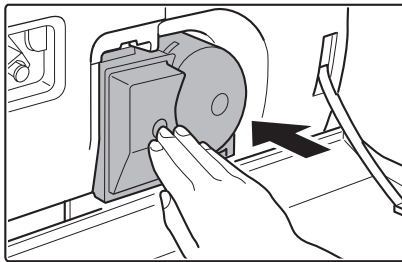

Push the cartridge in until it locks securely in place.

6

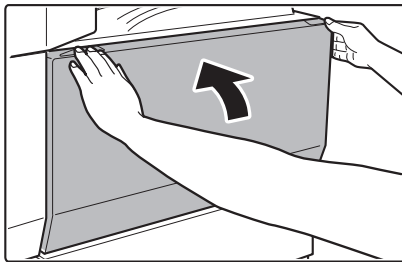

Close the front cover.

⚠ Caution

- Do not throw a toner cartridge into a fire. Toner may fly and cause burns.
- Store toner cartridges out of the reach of small children.
- If a toner cartridge is stored on end, the toner may harden and become unusable. Always store toner cartridges on their side with the top side up.
- If a toner cartridge other than a SHARP-recommended toner cartridge is used, the machine may not attain full quality and performance and there is a risk of damage to the machine. Be sure to use a SHARP-recommended toner cartridge.



- Keep the used toner cartridge in a plastic bag (do not discard it). Your service technician will collect the used toner cartridge.
- To view the approximate amount of toner remaining, continually touch the [COPY] key during printing or when the machine is idle. The percentage of toner remaining will appear in the display while the key is touched. When the percentage falls to "25-0%", obtain a new toner cartridge and keep it ready for replacement.
- Depending on your conditions of use, the color may become faint or the image blurred.

REMOVING MISFEEDS

When a paper misfeed occurs, the message "A misfeed has occurred." will appear in the touch panel and printing and scanning will stop. In this event, touch the [Information] key in the touch panel. When the key is touched, instructions for removing the misfeed will appear. Follow the instructions. When the misfeed is cleared, the message will automatically clear.

The blinking  mark in the image at left indicates the approximate position of the misfeed.

1

Misfeed location

Touch the [Information] key to display the following screen.

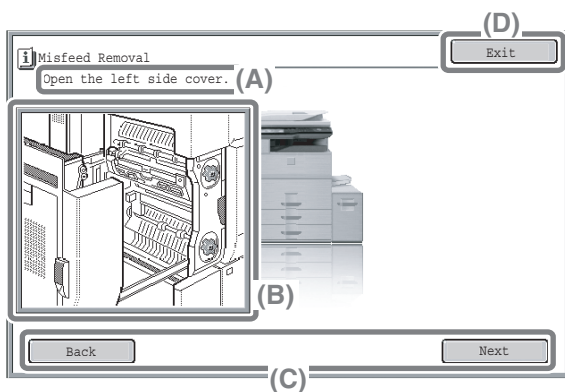

(A) Instructions for removing the misfeed appear here.

(B) Animation showing what to do.

(C) Display the previous screen or the next screen.

(D) This closes the information screen.

The information screen cannot be closed until the misfeed is removed.

- While the message appears, printing and scanning cannot be resumed.
- If the message does not clear even after the misfeed has been removed, the causes below are possible. Check once again.
 - The misfeed was not correctly removed.
 - A torn piece of paper remains in the machine.
 - A cover or unit that was opened or moved to remove the misfeed was not returned to its original position.

For detailed procedures for removing misfeeds, see "REMOVING MISFEEDS" in "8. TROUBLESHOOTING" in the Operation Guide.

SUPPLIES

Standard supplies for this product that can be replaced by the user include paper, toner cartridges, and staple cartridges for the finisher.

Be sure to use only SHARP-specified products for the toner cartridges, finisher staple cartridge, saddle stitch finisher staple cartridge, and transparency film.

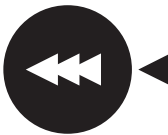
  GENUINE SUPPLIES	For best copying results, be sure to use only Sharp Genuine Supplies which are designed, engineered, and tested to maximize the life and performance of Sharp products. Look for the Genuine Supplies label on the toner package.
---	---

Storage of supplies

Proper storage

1. Store the supplies in a location that is:
 - clean and dry,
 - at a stable temperature,
 - not exposed to direct sunlight.
2. Store paper in the wrapper and lying flat.
3. Paper stored in packages standing up or out of the wrapper may curl or become damp, resulting in paper misfeeds.

Storing toner cartridges

Store a new toner cartridge box horizontally with the top side up. Do not store a toner cartridge standing on end. If stored standing on end, the toner may not distribute well even after shaking the cartridge vigorously, and will remain inside the cartridge without flowing out.

Staple cartridge

The finisher and saddle stitch finisher require the following staple cartridge:

SF-SC11 (for finisher)

Approx. 5000 per cartridge x 3 cartridges

MX-SC10 (for finisher (3 trays))

Approx. 5000 per cartridge x 3 cartridges

AR-SC3 (for saddle stitch finisher only)

Approx. 2000 per cartridge x 3 cartridges

Supply of spare parts and consumables

The supply of spare parts for repair of the machine is guaranteed for at least 7 years following the termination of production. Spare parts are those parts of the machine which may break down within the scope of the ordinary use of the product, whereas those parts which normally exceed the life of the product are not to be considered as spare parts. Consumables too, are available for 7 years following the termination of production.

SPECIFICATIONS

Machine specifications / copier specifications

Name	Digital Multifunctional System MX-M623N/MX-M753N/MX-M623U/MX-M753U	
Type	Desktop	
Photoconductive type	OPC drum	
Printing method	Electrophotographic system (laser)	
Developer system	Dry-type two-component magnetic brush development	
Fusing system	Heat rollers	
Scanning resolution	Document glass	600 x 300 dpi (factory default values), 600 x 400 dpi, 600 x 600 dpi
	Automatic document feeder	600 x 300 dpi (factory default values), 600 x 400 dpi, 600 x 600 dpi
Printing resolution	600 x 600 dpi	
Scanning gradation	10 bits	
Printing gradation	Equivalent to 256 levels	
Original sizes / types	Max. 11" x 17" (A3) / sheets, bound documents	
Copy sizes	Maximum: A3 (11" x 17") Minimum: 5-1/4" x 5-3/4" (A5R)	
Print margins	Leading edge / trailing edge: total 21/64" (8 mm) or less, near edge / far edge: total 21/64" (8 mm) or less	
Warm-up time	30 seconds or less (This may vary depending on the ambient conditions.)	
First-copy time	MX-M623N/MX-M623U: 4.0 seconds or less MX-M753N/MX-M753U: 3.5 seconds or less (This may vary depending on the state of the machine.)	
Copy ratios	Variable: 25% to 400% in increments of 1%, total 376 increments (25% to 200% when the automatic document feeder is used) Fixed presets: 25%, 50%, 64%, 77%, 100%, 121%, 129%, 200% and 400% for inch sizes; 25%, 50%, 70%, 81%, 86%, 100%, 115%, 122%, 141%, 200% and 400% for AB sizes. Two reduction ratios and two enlargement ratios can be stored.	
Continuous copy	999 copies	
Automatic document feeder	See "Automatic document feeder specifications".	
Tray 1	Paper sizes: 8-1/2" x 11", A4 Paper weight: Plain paper (16 lbs. to 28 lbs. (60 g/m ² to 105 g/m ²)) Paper capacity: Plain paper (21 lbs. (80 g/m ²)) 800 sheets Paper types: SHARP-recommended plain paper, recycled paper, and colored paper	
Tray 2	Paper sizes: 8-1/2" x 11", A4, B5 Paper weight: Plain paper (16 lbs. to 28 lbs. (60 g/m ² to 105 g/m ²)) Paper capacity: Plain paper (21 lbs. (80 g/m ²)) 1200 sheets Paper types: SHARP-recommended plain paper, recycled paper, and colored paper	
Tray 3	Paper sizes: 11" x 17", 8-1/2" x 14", 8-1/2" x 13-1/2", 8-1/2" x 13-2/5", 8-1/2" x 13", 8-1/2" x 11", 8-1/2" x 11"R, 7-1/4" x 10-1/2"R, 5-1/2" x 8-1/2"R, A3, B4, A4, A4R, B5, B5R, A5R, 8K, 16K, 16KR (Includes automatic paper size detection function. Entry of paper sizes up to 11-5/82" x 17" (297 mm x 432 mm) is possible.) Paper weight: Plain paper (16 lbs. to 28 lbs. (60 g/m ² to 105 g/m ²)), heavy paper (28 lbs. bond to 110 lbs. index (106 g/m ² to 209 g/m ²)) Paper capacity: Plain paper (21 lbs. (80 g/m ²)) 500 sheets, heavy paper 80 sheets Paper types: SHARP-recommended plain paper, recycled paper, colored paper, heavy paper* ¹ , transparency film* ¹ , labels* ¹ , and tab paper* ¹	

Machine specifications / copier specifications (Continued)

Tray 4	<p>Paper sizes: 11" x 17", 8-1/2" x 14", 8-1/2" x 13-1/2", 8-1/2" x 13-2/5", 8-1/2" x 13", 8-1/2" x 11", 8-1/2" x 11"R, 7-1/4" x 10-1/2"R, A3, B4, A4, A4R, B5, B5R, 8K, 16K, 16KR (Includes automatic paper size detection function.)</p> <p>Paper weight: Plain paper (16 lbs. to 28 lbs. (60 g/m² to 105 g/m²)), heavy paper (28 lbs. bond to 110 lbs. index (106 g/m² to 209 g/m²))</p> <p>Paper capacity: Plain paper (21 lbs. (80 g/m²)) 500 sheets, heavy paper 80 sheets</p> <p>Paper types: SHARP-recommended plain paper, recycled paper, colored paper, and heavy paper*2</p>
Bypass tray	<p>Paper sizes: 11" x 17", 8-1/2" x 14", 8-1/2" x 13-1/2", 8-1/2" x 13-2/5", 8-1/2" x 13", 8-1/2" x 11", 8-1/2" x 11"R, 7-1/4" x 10-1/2"R, 5-1/2" x 8-1/2"R, A3, B4, A4, A4R, B5, B5R, A5R, 8K, 16K, 16KR (Includes automatic paper size detection function. Entry of paper sizes up to 11-5/8" x 17" (297 mm x 432 mm) is possible.)</p> <p>Paper weight: Thin paper (15 lbs. to 16 lbs. (56 g/m² to 59 g/m²)), plain paper (16 lbs. to 28 lbs. (60 g/m² to 105 g/m²)), heavy paper (28 lbs. bond to 110 lbs. index (106 g/m² to 209 g/m²))</p> <p>Paper capacity: Standard paper 100 sheets</p> <p>Paper types: SHARP-recommended plain paper, recycled paper, colored paper, heavy paper*1, thin paper, transparency film*1, labels*1, and tab paper*1</p>
Duplex module	<p>Paper sizes: 11" x 17", 8-1/2" x 14", 8-1/2" x 13-1/2", 8-1/2" x 13-2/5", 8-1/2" x 13", 8-1/2" x 11", 8-1/2" x 11"R, 7-1/4" x 10-1/2"R, 5-1/2" x 8-1/2"R, A3, B4, A4, A4R, B5, B5R, A5R, 8K, 16K, 16KR</p> <p>Paper weight: Plain paper (16 lbs. to 28 lbs. (60 g/m² to 105 g/m²)), heavy paper (28 lbs. bond to 110 lbs. index (106 g/m² to 209 g/m²))</p> <p>Paper types: SHARP-recommended plain paper, recycled paper, colored paper, and heavy paper</p>
Output tray (Center tray)	<p>Output method: Face-down output</p> <p>Output capacity: 250 sheets (using SHARP-recommended 8-1/2" x 11" or A4 paper) (The maximum number of sheets that can be held varies depending on ambient conditions in the installation location, the type of paper, and the storage conditions of the paper.)</p> <p>Tray full sensor: Yes</p>
Interface port	<p>LAN connectivity: 10Base-T / 100Base-TX / 1000Base-T</p> <p>USB connectivity: Type A connector supports USB 2.0*3 Compatibility requirements of USB memory Disk Format: FAT Type B connector supports USB 2.0 (Hi speed)</p>
Required power supply	AC 120 V ±10% 60 Hz
Power consumption	1.8kW
Dimensions	28-42/64" (W) x 26-57/64" (D) x 47-48/64" (H) (728 mm (W) x 683 mm (D) x 1213 mm (H))
Weight	Approx. 419 lbs. (190 kg)
Overall dimensions	40-25/64" (W) x 26-57/64" (D) (1026 mm (W) x 683 mm (D)) (when bypass tray is extended)

*1 The following paper sizes can be used: 8-1/2" x 11", A4, B5, 16K, Custom size (only 8-1/2" x 11", A4 for tab paper)

*2 The following paper sizes can be used: 8-1/2" x 11", A4, B5, 16K

*3 Type A connectors are located on the front of the machine and on the right side of the machine at the back (total of two connectors. Do not use the connectors simultaneously.

To receive power supplied from a type A connector, the total current consumption of the connected device should not exceed 500 mA.

Continuous copying speeds*

Model	MX-M623N/MX-M623U	MX-M753N/MX-M753U
Copy ratio	100% / Reduce / Enlarged	
11" x 17", A3, 8K	34 copies/min.	39 copies/min.
8-1/2" x 14", 8-1/2" x 13-1/2", 8-1/2" x 13-2/5", 8-1/2" x 13", B4	39 copies/min.	45 copies/min.
8-1/2" x 11", A4, B5, 16K	62 copies/min.	75 copies/min.
8-1/2" x 11"R, 7-1/4" x 10-1/2"R, 5-1/2" x 8-1/2"R, A4R, B5R, A5R, 16KR	45 copies/min.	48 copies/min.

* Copy speed during output of the second copy and following copies when performing continuous one-sided copying of the same page (excluding offset output) using plain one-sided paper from a tray other than the bypass tray.

Ambient environment

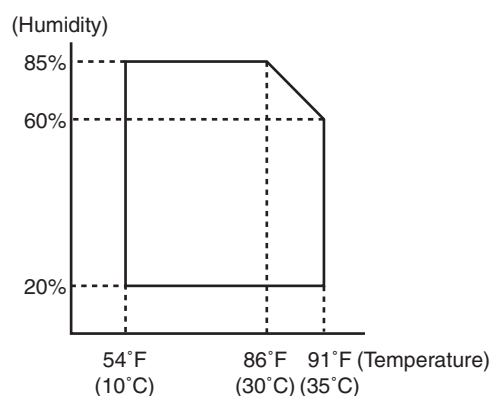

Chemical emission (measured according to RALUZ122: Edition Jun. 2006)

Ozone	1.5 mg/h or less
Dust	4.0 mg/h or less
Styrene	—
Benzene	—
TVOC	10 mg/h or less

SPECIFICATIONS

Acoustic noise emission (measurement according to ISO7779)

		MX-M623N/MX-M623U	MX-M753N/MX-M753U
Sound power level L _{WA}			
Printing mode (continuous printing)		7.0 B	7.1 B
Standby mode		5.2 B	5.2 B
Sound pressure level L _{pA} (actual measurement)			
Printing mode	Bystander positions	56 dB (A)	57 dB (A)
	Operator positions	55 dB (A)	56 dB (A)
Standby mode	Bystander positions	41 dB (A)	41 dB (A)
	Operator positions	35 dB (A)	35 dB (A)

Automatic document feeder specifications

Original sizes	11" x 17" to 5-1/2" x 8-1/2", A3 to A5, long paper (max. width 11-5/8" (297 mm) x max. length 39-23/64"*1 (1000 mm))
Original weight	One-sided 9 lbs. to 34 lbs. (35 g/m ² to 128 g/m ²)*2 Two-sided 13 lbs. to 34 lbs. (50 g/m ² to 128 g/m ²)
Capacity	150 sheets (21 lbs. (80 g/m ²)) Maximum stack height of 49/64" (19.5 mm)

*1 Scanning in mono 2 mode of one side only is possible in fax and scan send modes. However, when the resolution is 600 x 600 dpi in Internet fax mode, the maximum length is 31-31/64" (800 mm). When the resolution is 400 x 400 dpi or 600 x 600 dpi in scan mode, a long original cannot be scanned.

*2 Paper weights from 9 lbs. (35 g/m²) to 13 lbs. (49 g/m²) require the use of slow scan mode.

Contact at:



Name:

Administrator

Information that the administrator of the machine requires is printed on the back of this page.

(Separate this page from the manual and keep it in a safe place. In addition, fill in the name of the administrator and the administrator's contact information in the left hand margin.)

TO THE ADMINISTRATOR OF THE MACHINE

(Separate this page from the manual and keep it in a safe place.)

Factory default passwords

When accessing the system settings, the administrator password is required to log in with administrator rights. The system settings can be configured in the Web pages as well as on the operation panel. To access the system settings using the Web pages, a password is also required.

Factory default administrator password

Factory default setting: admin

Store a new administrator password as soon as the machine is installed. Once the administrator password has been changed, the new password is required to restore the factory default password. Take care to remember the new password.

Factory default passwords (Web pages)

There are two factory default accounts: "Administrator" and "User". A person who logs in as an "Administrator" can configure all settings in the Web pages. In addition, an administrator can restrict access to other settings by enabling "User" accounts.

The factory default passwords are shown below.

	Factory default account	Factory default password
User	users	users
Administrator	admin	admin

Forwarding all transmitted and received data to the administrator (document administration function)

This function is used to forward all data transmitted and received by the machine to a specified destination (Scan to E-mail address, Scan to FTP destination, Scan to Network Folder destination, or Scan to Desktop destination).

This function can be used by the administrator of the machine to archive all transmitted and received data. To configure the document administration settings, click [Application Settings] and then [Document Administration Function] in the Web page menu. (Administrator rights are required.)



- The format, exposure, and resolution settings of transmitted and received data remain in effect when the data is forwarded.
- When forwarding is enabled for data sent in fax mode,
 - The [Direct TX] key does not appear in the touch panel.
 - Quick online transmission and dialing using the speaker cannot be used.

For the users of the fax function

ABOUT THE TELEPHONE CONSUMER PROTECTION ACT OF 1991

The Telephone Consumer Protection Act of 1991 makes it unlawful for any person to use a computer or other electronic device, including FAX machines, to send any message unless such message clearly contains in a margin at the top or bottom of each transmitted page or on the first page of the transmission, the date and time it is sent and an identification of the business or other entity, or other individual sending the message and the telephone number of the sending machine or such business, other entity, or individual.

(The telephone number provided may not be a 900 number or any other number for which charges exceed local or long-distance transmission charges.)

In order to program this information into your FAX machine, you should complete the following steps:
See "Own Name and Destination Set" on page 7-82 of Operation Guide.

Important safety instructions

- If any of your telephone equipment is not operating properly, you should immediately remove it from your telephone line, as it may cause harm to the telephone network.
- The AC power outlet shall be installed near the equipment and shall be easily accessible.
- Never install telephone wiring during a lightning storm.
- Never install telephone jacks in wet locations unless the jack is specifically designed for wet locations.
- Never touch uninsulated telephone wires or terminals unless the telephone line has been disconnected at the network interface.
- Use caution when installing or modifying telephone lines.
- Avoid using a telephone (other than a cordless type) during an electrical storm. There may be a remote risk of electric shock from lightning.
- Do not use a telephone to report a gas leak in the vicinity of the leak.
- Do not install or use the machine near water, or when you are wet. Take care not to spill any liquids on the machine.
- Save these instructions.

TO THE ADMINISTRATOR OF THE MACHINE

FCC Notice to users:

This equipment complies with Part 68 of the FCC rules and the requirements adopted by the ACTA.

On this equipment is a label that contains, among other information, a product identifier in the format US:AAAEQ##TXXXX.

If requested, this number must be provided to the telephone company.

The REN is used to determine the number of devices that may be connected to a telephone line.

Excessive RENs on a telephone line may result in the devices not ringing in response to an incoming call.

In most but not all areas, the sum of RENs should not exceed five (5.0).

To be certain of the number of devices that may be connected to a line, as determined by the total RENs, contact the local telephone company.

For products approved after July 23, 2001, the REN for this product is part of the product identifier that has the format US:AAAEQ##TXXXX.

The digits represented by ## are the REN without a decimal point (e.g., 03 is a REN of 0.3).

For earlier products, the REN is separately shown on the label.

If this equipment causes harm to the telephone network, your telephone company may disconnect your service temporarily. If possible, they will notify you in advance. If advance notice is not practical, you will be notified as soon as possible. You will also be advised of your right to file a complaint with the FCC.

Your telephone company may make changes in its facilities, equipment, operations, or procedures that could affect the operation of your equipment. If this happens, the telephone company will provide advance notice in order for you to make necessary modifications to maintain uninterrupted service. If the equipment is causing harm to the telephone network, your telephone company may ask you to disconnect the equipment until the problem is resolved.

If you have any questions or problems which cannot be solved by reading this manual, please contact.

<p>Sharp Electronics Corporation 1 Sharp Plaza, Mahwah, NJ 07495 Telephone: 1-800-BE-SHARP</p>

A plug and jack used to connect this equipment to the premises wiring and telephone network must comply with the applicable FCC Part 68 rules and requirements adopted by the ACTA.

A compliant telephone cord and modular plug is provided with this product.

It is designed to be connected to a compatible modular jack that is also compliant. See installation instructions for details.

This equipment connects to the telephone network through a standard USOC RJ-11C network interface jack.

If your home has specially wired alarm equipment connected to the telephone line, ensure the installation of this equipment does not disable your alarm equipment.

If you have questions about what will disable alarm equipment, consult your telephone company or a qualified installer.

This equipment may not be used on coin service provided by the telephone company.

Connection to party lines service is subject to state tariffs.

Contact your state's public utility commission, public service commission or corporation commission for more information.

NOTICE for users in the USA

BE SURE TO ASK YOUR AUTHORIZED SHARP DEALER ABOUT THE WARRANTY THAT YOUR SELLING DEALER EXTENDS TO YOU. In order to assure you, the end-user, of warranty protection, Sharp extends a limited warranty to each of its authorized dealers and, in turn, requires each of its authorized dealers to extend its own warranty to you on terms that are no less favorable than those given to the dealer by Sharp. You should be aware, however, that Sharp does not itself extend any warranties, either express or implied, directly to you, the end-user, and no one is authorized to make any representations or warranties on behalf of Sharp. Specifically, SHARP DOES NOT EXTEND TO YOU, THE END-USER, ANY EXPRESS WARRANTY OR ANY IMPLIED WARRANTY OF MERCHANTABILITY, FITNESS FOR USE OR FITNESS FOR ANY PARTICULAR PURPOSE IN CONNECTION WITH THE HARDWARE, SOFTWARE OR FIRMWARE EMBODIED IN, OR USED IN CONJUNCTION WITH THIS PRODUCT. Sharp is not responsible for any damages or loss, either direct, incidental or consequential, which you, the end-user, may experience as a result of your purchase or use of the hardware, software or firmware embodied in or used in conjunction with this Product. Your sole remedy, in the event that you encounter any difficulties with this Product, is against the authorized dealer from which you purchased the Product.

MX-M623N Digital Multifunctional System

MX-M753N Digital Multifunctional System

MX-M623U Digital Multifunctional System

MX-M753U Digital Multifunctional System

In the event that this authorized dealer does not honor its warranty commitments, please contact the General Manager, Business Products Group, Sharp Electronics Corporation, 1 Sharp Plaza, Mahwah, NJ 07495-1163, so that Sharp can try to help assure complete satisfaction of all the warranty rights to which you are entitled from the authorized dealer.

NOTICE FOR USERS IN CANADA

"NOTICE : This product meets the applicable Industry Canada technical specifications."

"NOTICE : The Ringer Equivalence Number is an indication of the maximum number of devices allowed to be connected to a telephone interface. The termination on an interface may consist of any combination of devices subject only to the requirement that the sum of the RENs of all the devices does not exceed five."

The REN of this equipment is indicated on the facsimile expansion kit.

AVIS POUR NOS UTILISATEURS AU CANADA

AVIS : Le présent matériel est conforme aux spécifications techniques applicables d'Industrie Canada.

Remarque : L'indice d'équivalence de la sonnerie (IES) sert à indiquer le nombre maximal de terminaux qui peuvent être raccordés à une interface téléphonique. La terminaison d'une interface peut consister en une combinaison quelconque de dispositifs, à la seule condition que la somme d'indices d'équivalence de la sonnerie de tous les dispositifs n'excède pas 5.

L'indice d'équivalence de la sonnerie (IES) de cet équipement est indiqué sur le kit d'extension télécopieur.

Sharp Electronics of Canada Ltd.
335 Britannia Road East,
Mississauga, Ontario, L4Z 1W9
Canada

Trademark acknowledgments

The following trademarks and registered trademarks are used in conjunction with the machine and its peripheral devices and accessories.

- Microsoft®, Windows®, Windows® 98, Windows® Me, Windows NT® 4.0, Windows® 2000, Windows® XP, Windows Server® 2003, Windows Vista®, Windows Server® 2008, Windows® 7 and Internet Explorer® are registered trademarks or trademarks of Microsoft Corporation in the U.S.A. and other countries.
- PostScript is a registered trademark of Adobe Systems Incorporated.
- Adobe and Flash are registered trademarks or trademarks of Adobe Systems Incorporated in the United States and other countries.
- Adobe, the Adobe logo, Acrobat, the Adobe PDF logo, and Reader are registered trademarks or trademarks of Adobe Systems Incorporated in the United States and other countries.
- Macintosh, Mac OS, AppleTalk, EtherTalk and LaserWriter are trademarks of Apple Inc., registered in the U.S. and other countries.
- Netscape Navigator is a trademark of Netscape Communications Corporation.
- Mozilla® and Firefox® are registered trademarks or trademarks of the Mozilla Foundation in the U.S.A. and other countries.
- PCL is a registered trademark of the Hewlett-Packard Company.
- IBM, PC/AT, and PowerPC are trademarks of International Business Machines Corporation.
- Sharpdesk is a trademark of Sharp Corporation.
- Sharp OSA is a trademark of Sharp Corporation.
- RealVNC is a trademark of RealVNC Limited.
- All other trademarks and copyrights are the property of their respective owners.

Candid and Taffy are trademarks of Monotype Imaging, Inc. registered in the United States Patent and Trademark Office and may be registered in certain jurisdictions. CG Omega, CG Times, Garamond Antiqua, Garamond Halbfett, Garamond Kursiv, Garamond and Halbfett Kursiv are trademarks of Monotype Imaging, Inc. and may be registered in certain jurisdictions. Albertus, Arial, Coronet, Gill Sans, Joanna and Times New Roman are trademarks of The Monotype Corporation registered in the United States Patent and Trademark Office and may be registered in certain jurisdictions. Avant Garde, ITC Bookman, Lubalin Graph, Mona Lisa, Zapf Chancery and Zapf Dingbats are trademarks of International Typeface Corporation registered in the United States Patent and Trademark Office and may be registered in certain jurisdictions. Clarendon, Eurostile, Helvetica, Optima, Palatino, Stempel Garamond, Times and Univers are trademarks of Heidelberger Druckmaschinen AG, which may be registered in certain jurisdictions, exclusively licensed through Linotype Library GmbH, a wholly owned subsidiary of Heidelberger Druckmaschinen AG. Apple Chancery, Chicago, Geneva, Monaco and New York are trademarks of Apple Computer Inc. and may be registered in certain jurisdictions. HGGothicB, HGMinchoL, HGP GothicB and HGPMInchoL are trademarks of Ricoh Company, Ltd. and may be registered in some jurisdictions. Wingdings is a registered trademark of Microsoft Corporation in the United States and other countries. Marigold and Oxford are trademarks of Arthur Baker and may be registered in some jurisdictions. Antique Olive is a trademark of Marcel Olive and may be registered in certain jurisdictions. Hoefler Text is a trademark of Johnathan Hoefler and may be registered in some jurisdictions. ITC is a trademark of International Typeface Corporation registered in the United States Patent and Trademark Office and may be registered in certain jurisdictions. Agfa is a trademark of the Agfa-Gevaert Group and may be registered in certain jurisdictions. Intellifont, MicroType and UFST are trademarks of Monotype Imaging, Inc. registered in the United States Patent and Trademark Office and may be registered in certain jurisdictions. Macintosh and TrueType are trademarks of Apple Computer Inc. registered in the United States Patent and Trademark Office and other countries. PostScript is a trademark of Adobe Systems Incorporated and may be registered in some jurisdictions. HP, PCL, FontSmart and LaserJet are trademarks of Hewlett-Packard Company and may be registered in some jurisdictions. The Type 1 processor resident in Monotype Imaging's UFST product is under license from Electronics For Imaging, Inc. All other trademarks are the property of their respective owners.

SHARP®

SHARP ELECTRONICS CORPORATION

1 Sharp Plaza, Mahwah, New Jersey 07495-1163.

www.sharpusa.com

SHARP ELECTRONICS OF CANADA LTD.

335 Britannia Road East, Mississauga, Ontario, L4Z 1W9

SHARP CORPORATION



PRINTED IN CHINA

CINSE4653DS51

Free Manuals Download Website

<http://myh66.com>

<http://usermanuals.us>

<http://www.somanuals.com>

<http://www.4manuals.cc>

<http://www.manual-lib.com>

<http://www.404manual.com>

<http://www.luxmanual.com>

<http://aubethermostatmanual.com>

Golf course search by state

<http://golfingnear.com>

Email search by domain

<http://emailbydomain.com>

Auto manuals search

<http://auto.somanuals.com>

TV manuals search

<http://tv.somanuals.com>