

# 32480 Digital Video Camera

## Owner's Manual



© 2006 Sakar International, Inc. All rights reserved.  
Windows and the Windows logo are registered trademarks of Microsoft Corporation.  
All other trademarks are the property of their respective companies.

## Table of Contents

Key Features .....	4
What your digital video camera includes:.....	4
Computer System Requirements .....	5
A Quick Look at your Digital Video Camera.....	6
The LCD Display.....	7
Preparing Your Camera for Use .....	8
Installing a Memory Card .....	9
The Camera Modes .....	12
Setup Mode .....	13
Starting your DV camera.....	22
Video Mode.....	23
Other Functions .....	24
Using your DV Camera as a Web Cam .....	28
Video Conferencing .....	30
Installing Digital Images Manager Software.....	32
Transferring Images to your PC .....	39
Maintenance of Your Digital Camera .....	48
Technical Support.....	48
Technical Specifications .....	49

## Introduction

Thank you for purchasing your Digital Video camera. Not only can it shoot video clips and take photos, it also has the built-in functions of a webcam, which you can use for video conferencing. In addition, an SD/MMC card can be inserted into the DV camera to expand its memory.

Your camera includes the patented Active Images® technology, the most powerful way to share your photos that enable you to:

- Create fun, personalized videos
- Select from built-in styles
- Combine selected music with sound track
- Personalize with titles and credits
- Annotate your JPEG photos with sound, text and more
- Generally produce videos created with automatic editing and synchronized transitions and effects.

In short, everything you need to get the most out of your photos.

## Key Features

- 3.1 Megapixel DV camera with choice of 3 image resolutions - 2048 x 1536 Pixels (QXGA), 1280x1024 Pixels (SXGA), 640 x 480 Pixel (VGA). The resolution for Video is 320 x 240 pixel (QVGA).
- 4x digital zoom
- Your DV camera can be used as a Web Cam for Video Conferencing and Instant Messaging.
- 1.5" Color TFT preview screen
- Create your own movies
- Add special effects with Digital Images Software ®Manager
- Record about 177 minutes of video with 1GB SD Card (not included)
- 3 in 1: take digital photos or connect to PC as Web-Cam
- Built in microphone and speaker
- Expansion SD memory slot

## What your digital video camera includes:

- Digital Video Camera
- USB cable

- TV Cable
- Digital Images Software Manager®
- User manual
- Strip

## Computer System Requirements

- Windows 2000 or XP
- Pentium II 300 or higher
- 64MB RAM
- 100MB free hard drive space
- CD-ROM drive
- Available USB port
- 16-bit color display adaptor

## A Quick Look at your Digital Video Camera

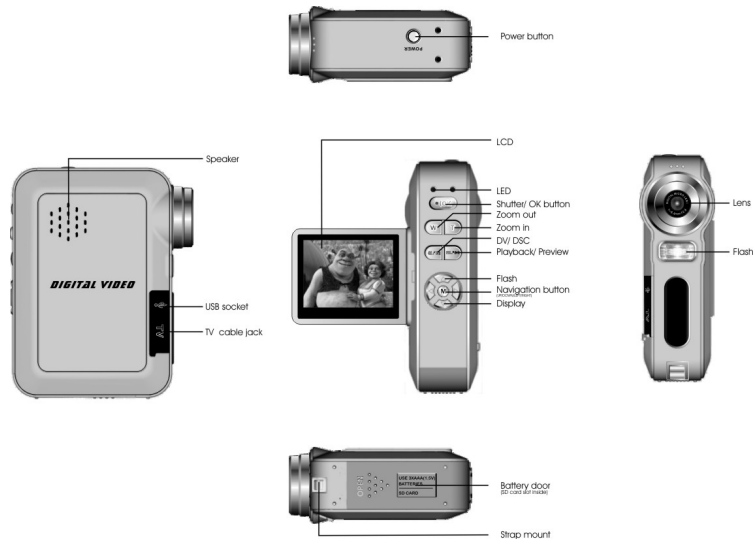

## The LCD Display

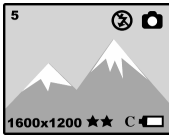

LCD Screen  
Normal Mode

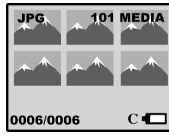

LCD Screen  
Playback Mode

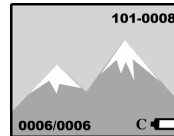

LCD Screen  
Playback Mode

### Explanation of Icons that Appear on the LCD Monitor

#### Battery power level



Full battery power



Medium battery power



Low battery power

#### Photo quality



Standard quality



High quality

#### Flash

<A> Auto

<⚡> Force Flash

<⊕> No Flash

#### Shooting Mode



Video







Single shot

Self-timer

 Self-timer On

Digital Zoom

 4.00X - 4 x Digital Zoom     3.00X - 3 x Digital Zoom     2.00X - 2 x Digital Zoom

 1.00X - 1 x Digital Zoom

## Preparing Your Camera for Use

### Battery Installation

Your DV camera requires three "AAA" batteries. It is recommended that alkaline batteries be used.

1. Slide the battery cover to open the battery compartment.
2. Insert the batteries in accordance with the polarity indicated.
3. Replace the battery cover.



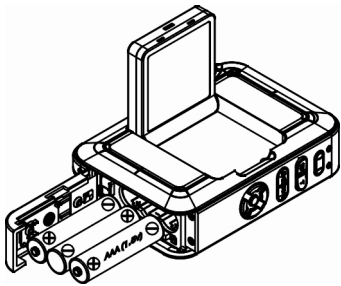

Note: Unless you are using an SD memory card, opening the battery compartment and/or removing the battery will erase the videos and photos currently stored in the camera. Download your videos and photos as often as possible. Data will be lost when the DV camera is turned off or the battery runs low. Do not open the battery door before turning off your DV camera.

## Installing a Memory Card

An SD compatible memory card can be inserted into your DV camera, which will allow an increase in the number of movies, or photos that can be taken before the need arises to transfer them to a computer.

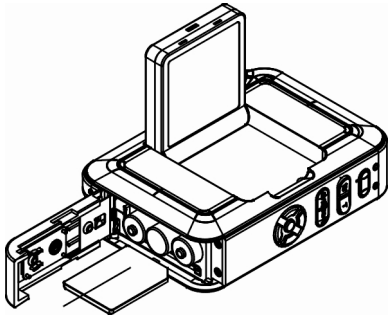

**NOTE:** limited internal memory is provided for test images. Those images will be deleted when camera power is turned off. Please download the images before power off. SD memory card is required for normal use.

Insert the card by pushing it firmly into the slot next to the battery compartment until it clicks into place.

Once the memory card is inserted the following message will appear on the LCD Monitor:

"Copy To Card

Yes No"

Pressing the left/right button to select "YES" will result in all images in the internal memory of the DV camera being copied to a new directory in the memory card.

Pressing the left/right button to select "No" will result in the images remaining in the internal memory of the DV camera. However such images will not be accessible again until the external memory card is removed or images are downloaded to a computer.

Pictures copied to the memory card may be accessed in "Playback mode". In "Playback mode" pictures in the current directory may be viewed. Use the down arrow to view each directory on the external memory card.

The words "Change directory" will appear followed by the next directory of pictures.





Once an external memory card is inserted in the camera, all the images taken will be stored on the external memory card.

**Caution:**

- This product supports SD cards up to 1GB.
- Formatting will delete all data on the SD Memory Card including protected data.
- Do not remove the SD memory Card during formatting as this may damage the card and render it unusable.
- Be sure to format the card with the camera.
- SD memory cards formatted on a PC or device other than the DV camera should not be used.
- All the data in the built-in memory will be lost if no SD Memory Card has been inserted in the DV when you change your batteries.





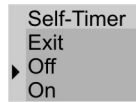

## The Camera Mode

### Flash

1. Press **FLASH**  button. The icon  will keep flashing on the LCD until the flash is fully charged. The flash function is forced on.
2. Repeatedly press **FLASH** to select the icon  shown on the LCD. The automatic flash function is activated.
3. Repeatedly press **FLASH** to select the icon  shown on the LCD, the flash function will be off.

### Self-timer



1. Press the  button.
2. Press the  button.
3. Press  button to select **ON**.
4. Press  to confirm. The icon  will appear on the LCD.
5. Press  to activate the self-timer. The timer will count down for 10 seconds before the photo is taken.



**Note:**

. The DV will return to standby mode if you do not press any buttons within 5 seconds.

## Setup Mode

### Image-setting



**NB.** The default image setting is **Auto**.

1. Press  button.
2. Press  button twice

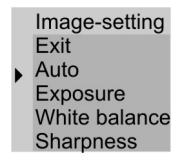
the following menu will appear:





### Exposure



1. Press  button to select **Exposure**.
2. Press  to confirm

the following menu will appear:



3. Press  button to select the desired exposure (-1.5 ~ +1.5)
4. Press  button to confirm.



### **White Balance**

1. Press  button to select **White Balance**.
2. Press  to confirm



the following menu will appear:



:

3. Press  /  button to select the appropriate light setting
4. Press  button to confirm.

### Sharpness

1. Press  button to select **Sharpness**
2. Press  to confirm

the following menu will appear

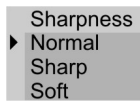

3. Press  button to select desired sharpness.

4. Press  button to confirm.

### Image Size

1. Press  button one time.

2. Press  button three times,  
the following menu will appear





3. Press  button to select the image resolution per your request.



4. Press  to confirm.







### Image Quality

1. Press  button one time.
2. Press  button four times  
the following menu will appear





3. Press  button to select the image quality per your request.
4. Press  to confirm.



#### Note:

-  means standard quality,  means high quality.
- The resolution and quality will appear on the LCD.
- In standby mode, you can press  button to select the image quality, press  button to select the image resolution.

### Auto Off

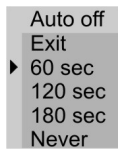
1. Press  button once.
2. Press  button until the auto off menu appears



3. Press  button to select the switch-off time of your choice
4. Press  to confirm.

### Date/Time Setting

1. Press  button once.

2. Press  button six times

the following menu will appear:

```
Date Time
Exit
▶ Date off photo
Date on photo
Set
```







**Note:** The default function is "Date off photo".

3. Press  button to select **Date/Time**.

4. Press  button to select **SET**

the following menu will appear

```
Date Time
2006 01 01
00:00:00
```

1. Press  button to select the digit.
2. Press  /  button to set the digit.
3. Press .
4. Press  /  button to select **Yes**.
5. Press  to confirm.



.the date and time will be printed on the photo taken.

### **Set Frequency**

1. Press  button once
2. Press  button seven times

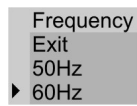

The following menu will appear



3. Press  button to select the frequency.
4. Press  to confirm.



**Note:** **60Hz** is normally used in the United States and Asia. **50Hz** is normally used in Japan and Europe.  
Use of the incorrect frequency can affect the quality of your photos

#### Set TV Mode

1. Press  button once.
2. Press  button eight times

The following menu will appear:





3. Press  button to select the TV Mode.
4. Press  to confirm.

**Note:** .NTSC is normally used in the United States and Japan. PAL is normally used in Asia and Europe.

## Starting your DV camera

Note:

The default setting of your DV camera is normal (single photo) mode

You can press / button to zoom in on a subject up to 4 X.  (digital zoom),

Press and hold the POWER button down for 3 seconds to switch the DV camera on.

The LCD Monitor will light up and the camera will beep to indicate that it is ready for use.

### **Taking Photos**

Focus on the subject using the LCD screen

Hold the camera steady and press the shutter button  to take a photo

(There will be a short delay while the camera saves the photo to memory.)

Note:

The number of photo shots available is displayed in the upper left corner of the LCD in this mode

When the DV camera memory is full, the LCD will display "0" and "Memory Full".

If you attempt to take a photo when the memory is full the camera will beep continuously.

## **Video Mode**

When switched on your DV camera will be in normal (single photo) mode. To change to Video mode:

1. Press the navigation button once and the menu will appear as follows:

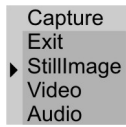

2. Press down button to select Video.
3. Press the shutter button. The icon  will appear on the LCD.
4. Focus on the subject and press the Shutter Button to start shooting.
5. Press the Shutter Button again to stop shooting.

**Note:**

- . Pressing the  button will change your DV camera directly to Video-shooting mode.
- . Movies shot in this mode will be saved in **AVI (Audio Video Interleave)** format.
- . Your camera cannot be switched off while shooting videos.

## Other Functions

In order to carry out the functions described below, your camera must be in **playback** mode





Press  button to select PLAYBACK mode

### Deleting Still Images

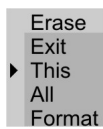

Press  button once and the following menu will appear.



. Use the  /  button to select the desired function ..

Press the  button.

When "All" or "Format" is selected, then "Yes No" will appear on the LCD.

Press  /  button to select "Yes" or "No", then press the navigation button to perform the operation.

Selecting "This" will delete the image displayed on the LCD

Selecting "All" will delete all images in memory.

Selecting "Format" will delete all files including those protected (see below).

### Protect photos

Press  button once

Press  button once and the following menu will appear:



Press the  button to select Lock

Press the  button to confirm



### Rotating Images

**Note:** To rotate photos the same must be displayed in full screen

Press  button once.

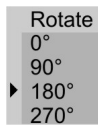
Press  button twice and the following menu will appear:



Press the / button to select amount of rotation shown on LCD (0°, 90°, 180°, 270°).

Press the  button to confirm.





### **Auto Off**

Please refer to Page13.

### **Zoom**

Press / button to Z+ or Z- (Press  button to show the photo in full screen).

### Display Function

- . In **NORMAL** mode, press  button to switch off all of the icons shown on the LCD, press  button twice to turn off the LCD monitor, press  button three times to light on.
- . In **PLAYBACK** mode, you can press  button to show the photo you selected to full screen.

## Using your DV Camera as a Web Cam

Press the  button to set your DV to **Normal** mode.

Connect your camera to your computer using the USB cable.

### Web Cam Express

Now that you have your camera installed you can use it to capture short movies called AVI files that can be saved directly to the PC. The length of time you can record an AVI while the camera is connected to your computer will vary, depending on how much hard drive space you will use to save the file. Please take note that these AVI files take up a lot of hard drive space. This is done through the PhoTags WebCam Express program. This next section will walk you through capturing an AVI file.

1. Make sure that your camera is connected via the USB cable to your PC

2. Double-click the “WebCam Express” icon  that is on your desktop to launch the “PhotoTags WebCam Express” program.

3. Adjust your WebCam to the desired position. The screen will display what the WebCam “sees”.

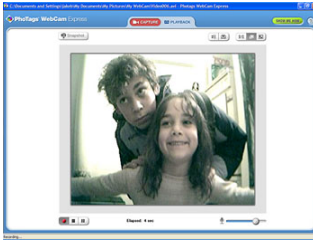

3. To add audio to your video, plug a microphone into your computer.



4. Click the “Capture” button to start recording the video. The recording elapse time will appear under the video.

5. Click the “Pause” button to hold the recording. To continue recording click the “Capture” button again.

6. To finish recording click the “Stop” button. The videos will be automatically saved into a default directory.

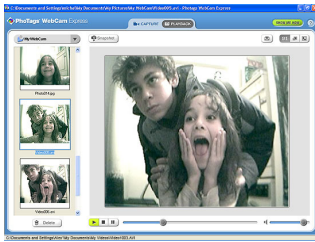

**Note:** *Taking snapshots*- to learn how to capture JPEG snapshots from your WebCam or from your existing AVI movies, go to the “Take Snapshots” section in the Quick Start help.

To learn how to change the user settings, go to the “Set User Preferences” section in the Quick Start help.

- What it does
- Basic instructions from Quick Help

## Video Conferencing

Your camera can be used as a webcam for video conferencing:

1. Connect the camera to your computer with USB cable.
2. Run the video conference software **Microsoft NetMeeting** on your computer.
3. Input IP address in the address bar and dial.
4. Select **[Tool][Video][Send]** and **[Transfer]** options after your call has been received.

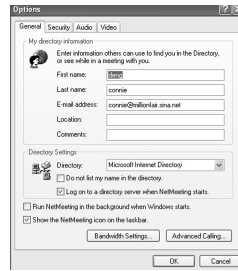
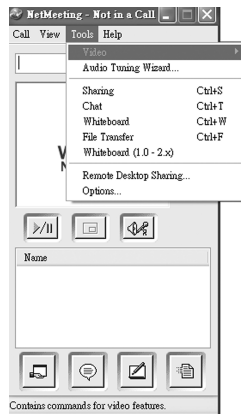

## Installing Digital Images Manager Software

Insert the Software CD that came with your camera into the CD-ROM drive.

Make sure that your camera is NOT connected to the computer.

The Digital Images Manager and camera driver installation screen will appear. You will have to install both Digital Images Manager and the camera driver and restart your computer in order to complete the software installation.



1. Click on "Install Digital Images Manager".





2. Select your camera model from the drop down list and click the "Install" button to install Digital Images Manager.

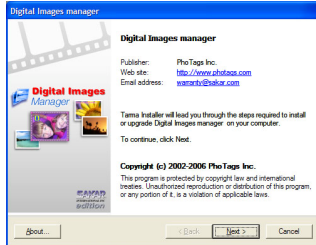

3. On the "Digital Images Manager" screen, click the "Next" button.

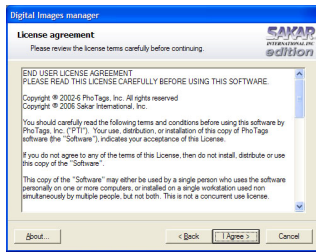

4. Please review the license terms and click the "Agree" button to continue.

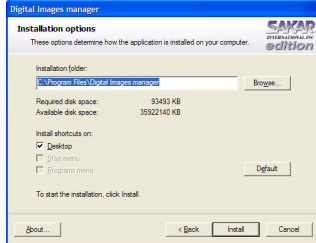

5. Let the "Digital Images Manager" installer create the folder where the program will be installed, and then click "Install".

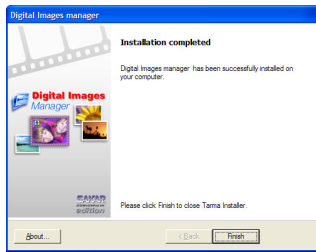

6. Click "Finish" to let the "Digital Images Manager" installer finish the installation program.

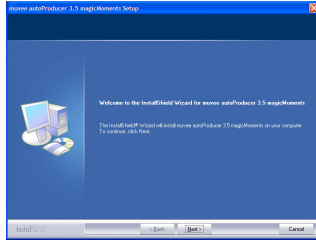

7. Click "Next" to begin installation of muvee AutoProducer.

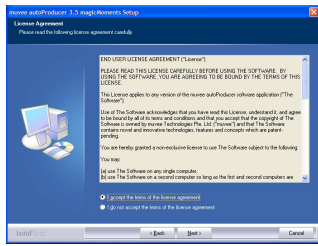

8. Please review the license terms and click the "I accept" button to continue.

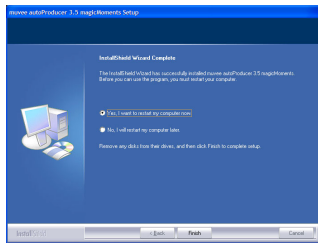

9. Click on "Finish" to complete installation of muvee AutoProducer.



10. Click on "Camera Driver Installation" to install drivers.

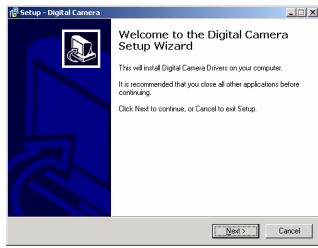

11. Click "Next" to begin installation of drivers.

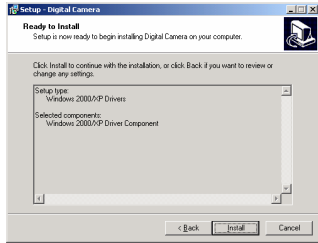

12. Click "Install" to continue installation of drivers.

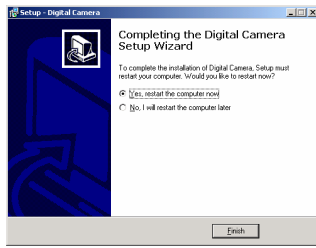

13. Once the program has finished installing please click “Finish” and restart your computer.

Congratulations!! You have successfully installed the “Digital Images Manager” software.

## Transferring Images to your PC

Press the  button to set your DV to **PLAYBACK** mode before downloading photos. The **MSDC** icon will appear on the LCD.

## Transfer Images Using Digital Images Manager:

1. Set your camera to PLAYBACK mode.
2. Connect your camera to your computer using the USB cable provided.
3. Make sure that your camera is connected and is turned ON.
4. The “Camera/Removable Media Auto Detect” window will automatically appear.



5. The number of pictures on the camera or memory card will appear on the window.
6. Click “OK” if you wish to transfer the photos and save them to your computer. The “Digital Images Manager” application you installed will open in the “Get photos” wizard mode and will ask you to select the photos you wish to transfer.



Select your photos and click “Next” to continue.

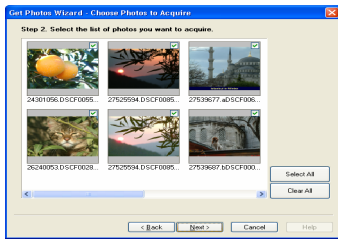

7. Add Active Captions to your pictures. You can add a date, keywords, categories and more. Click “Next” to continue.

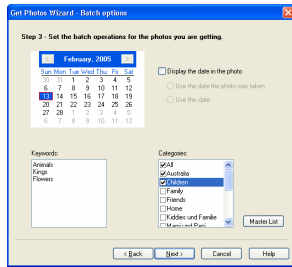

8. On the next screen, select where to place your photos and click the “Finish” button to copy the photos to your computer.

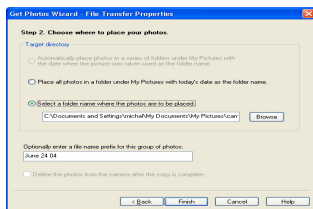

9. All of the pictures you have imported will appear in the “Select Photos” main window.

#### **Manual Photo Download:**

Get photos manually using “Digital Images Manager”

Use the “Digital Images Manager” program to import the photos from your camera.

1. Plug one end of the USB cable into the USB slot on your camera.
2. Plug the other end of the USB cable into a USB port on your computer.

3. Make sure that your camera is connected and turned ON.

Double-click the “Digital Images Manager” icon  on your desktop to launch the “Digital Images Manager” program.



Click on the “Get Photos” button on the Main Menu.

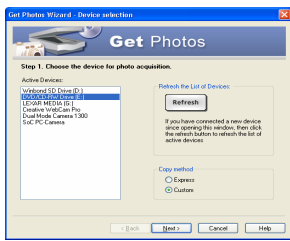

The “Device Selection” mode will appear. Both your camera and the memory card will each appear in the “Active Devices” list as a “Removable Disk”. Toggle between the two devices to select your pictures.

1. **Custom Copy:**

This mode is used to manually select the photos you wish to copy to your computer.

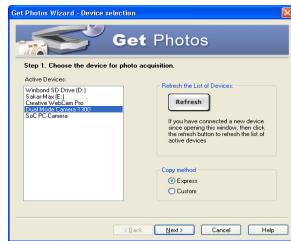

- a. Select "Custom Copy". Click "Next" to continue.

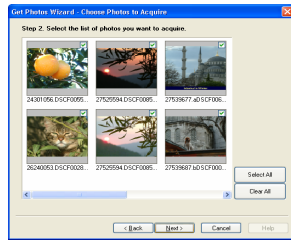

- b. Select your photos and click "Next" to continue.

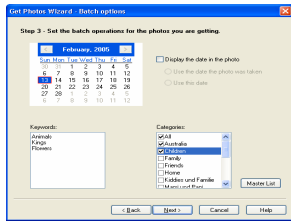

- c. Add Active Captions to your pictures. With this feature, you can add a date, keywords and categories. Click "Next" to continue.

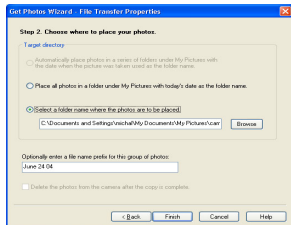

- d. On the next screen, choose where you wish to place your photos on your computer. Click on "Finish" to copy the photos to the location you selected. All of the pictures you imported will appear in the "Select photos" main window.

## **2. Express Copy Method:**

Select this option if you wish to have all the images transferred to the PC without the option of selecting photos. In this mode you will not see a preview of the images transferred. For more information please refer to the Quick Start guide in Digital Images Manager.

### **Transfer Images Directly From Windows**

1. Plug one end of the USB cable into the USB slot on your camera.
2. Plug the other end of the USB cable into a USB port on your computer.
3. Make sure that your camera is connected and is turned ON.
4. Click on the START button in Windows.
5. Click on the MY COMPUTER Icon
6. Your memory card will appear as a REMOVABLE STORAGE DEVICE.

7. Click on the REMOVABLE STORAGE DEVICE to view the images. The images are stored in the subfolder called DCM100.
8. You can now copy and paste the images to any directory you choose.

## Maintenance of Your Digital Camera

Your DV camera is a delicate instrument- please handle it with care.

## Technical Support

For technical support issues please visit our website at [www.sakarhelp.com](http://www.sakarhelp.com). You can find manuals, software and FAQ's at the website. Can't find what you are looking for? Fill out an online ticket and one of our technical support team members will answer questions or call 877-397-8200 or 732-476-5098 to access our technical support information on the phone. For question on warranty information please email [warranty@sakar.com](mailto:warranty@sakar.com)

Q: How do I restart my camera if the camera freezes up?

Open the battery door and remove the batteries for a few minutes then re-install the batteries with the correct polarity facing up. Press the power button to start your camera.



## Technical Specifications

<b>Sensor</b>	●CMOS Sensor
<b>Image Resolution for Digital Camera</b>	●2048 x 1536 pixels (QXGA); 1280 x 1024 pixels (SXGA); 640 x 480 pixels (VGA)
<b>Image Resolution for PC Camera</b>	●640 x 480 pixels (VGA); 352 x 288 pixels (CIF); 320 x 240 pixels (QVGA) ●176 x 144 pixels (QCIF); 160 x 120 pixels (QQVGA)
<b>Image Resolution for Video</b>	●320 x 240 pixels (QVGA)
<b>Memory Device</b>	●Internal SDRAM; External SD/MMC card
<b>Memory Capacity (Internal SDRAM for test)</b>	●About 2(QXGA/SXGA/VGA) ●Short clip: 19 seconds (QVGA)-- (AVI)
<b>Memory Capacity (External 16M SD Card)</b>	<b>OUT DOOR</b> ●Standard Quality: About 30(QXGA), 45 (SXGA), 235(VGA) ●High Quality: About 14(QXGA), 27 (SXGA), 103(VGA)
	<b>SHADE</b> ●Standard Quality: About 38 (QXGA), 68 (SXGA), 313 (VGA) ●High Quality: About 17 (QXGA), 33 (SXGA), 160 (VGA)
<b>Self-timer Photography</b>	●10s
<b>Shutter Speed</b>	●1/6 ~ 1/15000s
<b>Automatic Energy Saving</b>	●60s/120s/180s/Never OFF
<b>Frame Rate (for DV)</b>	●About 9 fps (QVGA)
<b>Power Supply</b>	●3 x AAA batteries/USB 5V
<b>Transmission Interface</b>	●USB Interface Ver. 1.1
<b>Working Temperature</b>	●0°C - 40°C
<b>Computer Requirement</b>	●Win2000/XP ●125MB free hard disk space or above ●32MB or more RAM ●Color Monitor (24 bit or above) ●Available CD-ROM Drive ●Available USB socket

P08DV130H2G0E00000

## Free Manuals Download Website

<http://myh66.com>

<http://usermanuals.us>

<http://www.somanuals.com>

<http://www.4manuals.cc>

<http://www.manual-lib.com>

<http://www.404manual.com>

<http://www.luxmanual.com>

<http://aubethermostatmanual.com>

Golf course search by state

<http://golfingnear.com>

Email search by domain

<http://emailbydomain.com>

Auto manuals search

<http://auto.somanuals.com>

TV manuals search

<http://tv.somanuals.com>