

M3028BT-EPB

User's Manual

Emulation Probe for M16C/Tiny Series

User's Manual

Rev.2.00
Sep. 16, 2006

Renesas Technology
www.renesas.com

Keep safety first in your circuit designs!

1. Renesas Technology Corp. puts the maximum effort into making semiconductor products better and more reliable, but there is always the possibility that trouble may occur with them. Trouble with semiconductors may lead to personal injury, fire or property damage. Remember to give due consideration to safety when making your circuit designs, with appropriate measures such as (i) placement of substitutive, auxiliary circuits, (ii) use of non-flammable material or (iii) prevention against any malfunction or mishap.

Notes regarding these materials

1. These materials are intended as a reference to assist our customers in the selection of the Renesas Technology Corp. product best suited to the customer's application; they do not convey any license under any intellectual property rights, or any other rights, belonging to Renesas Technology Corp. or a third party.
2. Renesas Technology Corp. assumes no responsibility for any damage, or infringement of any third-party's rights, originating in the use of any product data, diagrams, charts, programs, algorithms, or circuit application examples contained in these materials.
3. All information contained in these materials, including product data, diagrams, charts, programs and algorithms represents information on products at the time of publication of these materials, and are subject to change by Renesas Technology Corp. without notice due to product improvements or other reasons. It is therefore recommended that customers contact Renesas Technology Corp. or an authorized Renesas Technology Corp. product distributor for the latest product information before purchasing a product listed herein.
The information described here may contain technical inaccuracies or typographical errors. Renesas Technology Corp. assumes no responsibility for any damage, liability, or other loss rising from these inaccuracies or errors.
Please also pay attention to information published by Renesas Technology Corp. by various means, including the Renesas Technology Corp. Semiconductor home page (<http://www.renesas.com>).
4. When using any or all of the information contained in these materials, including product data, diagrams, charts, programs, and algorithms, please be sure to evaluate all information as a total system before making a final decision on the applicability of the information and products. Renesas Technology Corp. assumes no responsibility for any damage, liability or other loss resulting from the information contained herein.
5. Renesas Technology Corp. semiconductors are not designed or manufactured for use in a device or system that is used under circumstances in which human life is potentially at stake. Please contact Renesas Technology Corp. or an authorized Renesas Technology Corp. product distributor when considering the use of a product contained herein for any specific purposes, such as apparatus or systems for transportation, vehicular, medical, aerospace, nuclear, or undersea repeater use.
6. The prior written approval of Renesas Technology Corp. is necessary to reprint or reproduce in whole or in part these materials.
7. If these products or technologies are subject to the Japanese export control restrictions, they must be exported under a license from the Japanese government and cannot be imported into a country other than the approved destination.
Any diversion or reexport contrary to the export control laws and regulations of Japan and/ or the country of destination is prohibited.
8. Please contact Renesas Technology Corp. for further details on these materials or the products contained therein.

Preface

The M3028BT-EPB is an emulation probe for M16C/Tiny Series MCUs. The M3028BT-EPB is used by connecting to the PC7501 emulator main unit.

This user's manual mainly describes specifications of the M3028BT-EPB emulation probe and how to setup it. For details on the following products, which are used with the M3028BT-EPB, refer to each product's user's manual.

All the components of this product are shown in "1.1 Package Components" (page 13). If there is any question or doubt about this product, contact your local distributor.

The related manuals for using this product are listed below. You can download the latest manuals from the Renesas Tools homepage (<http://www.renesas.com/en/tools>).

Related manuals

Item	Manual
Emulator main unit	PC7501 User's Manual
Integrated development environment	High-performance Embedded Workshop User's Manual
Emulator debugger	M16C R8C PC7501 Emulator Debugger User's Manual
	M3T-PD30F User's Manual
C compiler	C compiler package for the R8C/Tiny, M16C/60, 30, Tiny, 20, and 10 Series C compiler User's Manual
Assembler	C compiler package for the R8C/Tiny, M16C/60, 30, Tiny, 20, and 10 Series Assembler User's Manual

Important

Before using this product, be sure to read this user's manual carefully.

Keep this user's manual, and refer to this when you have questions about this product.

Emulator:

The emulator in this document refers to the following products that are manufactured by Renesas Technology Corp.:

- (1) PC7501 main unit
- (2) Emulation probe
- (3) Package converter board for connecting the user system

The emulator herein does not include the customer's user system and host machine.

Purpose of use of the emulator:

This emulator is a device to support the development of a system that uses the M16C/Tiny Series of Renesas 16-bit single-chip MCUs. It provides support for system development in both software and hardware.

Be sure to use this emulator correctly according to said purpose of use. Please avoid using this emulator for other than its intended purpose of use.

For those who use this emulator:

This emulator can only be used by those who have carefully read the user's manual and know how to use it.

Use of this emulator requires the basic knowledge of electric circuits, logical circuits, and MCUs.

When using the emulator:

- (1) This product is a development supporting unit for use in your program development and evaluation stages. In mass-producing your program you have finished developing, be sure to make a judgment on your own risk that it can be put to practical use by performing integration test, evaluation, or some experiment else.
- (2) In no event shall Renesas Solutions Corp. be liable for any consequence arising from the use of this product.
- (3) Renesas Solutions Corp. strives to renovate or provide a workaround for product malfunction at some charge or without charge. However, this does not necessarily mean that Renesas Solutions Corp. guarantees the renovation or the provision under any circumstances.
- (4) This product has been developed by assuming its use for program development and evaluation in laboratories. Therefore, it does not fall under the application of Electrical Appliance and Material Safety Law and protection against electromagnetic interference when used in Japan.
- (5) Renesas Solutions Corp. cannot predict all possible situations or possible cases of misuse where a potential danger exists. Therefore, the warnings written in this user's manual and the warning labels attached to this emulator do not necessarily cover all of such possible situations or cases. Please be sure to use this emulator correctly and safely on your own responsibility.
- (6) This product is not qualified under UL or other safety standards and IEC or other industry standards. This fact must be taken into account when taking this product from Japan to some other country.
- (7)

Usage restrictions:

This emulator has been developed as a means of supporting system development by users. Therefore, do not use it as a device used for equipment-embedded applications. Also, do not use it for developing the systems or equipment used for the following purposes either:

- (1) Transportation and vehicular
- (2) Medical (equipment where human life is concerned)
- (3) Aerospace
- (4) Nuclear power control
- (5) Undersea repeater

If you are considering the use of this emulator for one of the above purposes, please be sure to consult your local distributor.

About product changes:

We are constantly making efforts to improve the design and performance of this emulator. Therefore, the specification or design of this emulator or its user's manual may be changed without prior notice.

About the rights:

- (1) We assume no responsibility for any damage or infringement on patent rights or any other rights arising from the use of any information, products or circuits presented in this user's manual.
- (2) The information or data in this user's manual does not implicitly or otherwise grant a license for patent rights or any other rights belonging to us or third parties.
- (3) This user's manual and this emulator are copyrighted, with all rights reserved by us. This user's manual may not be copied, duplicated or reproduced, in whole or part, without prior written consent of us.

About diagrams:

The diagrams in this user's manual may not all represent exactly the actual object.

Precautions for Safety

Definitions of Signal Words

In both the user's manual and on the product itself, several icons are used to insure proper handling of this product and also to prevent injuries to you or other persons, or damage to your properties.

This chapter describes the precautions which should be taken in order to use this product safely and properly. Be sure to read this chapter before using this product.



This symbol represents a warning about safety. It is used to arouse caution about a potential danger that will possibly inflict an injury on persons. To avoid a possible injury or death, please be sure to observe the safety message that follows this symbol.



DANGER

DANGER indicates an imminently dangerous situation that will cause death or heavy wound unless it is avoided. However, there are no instances of such danger for the product presented in this user's manual.



WARNING

WARNING indicates a potentially dangerous situation that will cause death or heavy wound unless it is avoided.



CAUTION

CAUTION indicates a potentially dangerous situation that will cause a slight injury or a medium-degree injury unless it is avoided.

CAUTION

CAUTION with no safety warning symbols attached indicates a potentially dangerous situation that will cause property damage unless it is avoided.

IMPORTANT

This is used in operation procedures or explanatory descriptions to convey exceptional conditions or cautions to the user.

In addition to the five above, the following are also used as appropriate.

△ means WARNING or CAUTION.

Example:



CAUTION AGAINST AN ELECTRIC SHOCK

⊘ means PROHIBITION.

Example:



DISASSEMBLY PROHIBITED

● means A FORCIBLE ACTION.

Example:



UNPLUG THE POWER CABLE FROM THE RECEPTACLE.

⚠ WARNING

Warnings for AC Power Supply:



- If the attached AC power cable does not fit the receptacle, do not alter the AC power cable and do not plug it forcibly. Failure to comply may cause electric shock and/or fire.

- Use an AC power cable which complies with the safety standard of the country.

- Do not touch the plug of the AC power cable when your hands are wet. This may cause electric shock.

- This product is connected signal ground with frame ground. If your developing product is transformless (not having isolation transformer of AC power), this may cause electric shock. Also, this may give an unreparable damage to this product and your developing one.

While developing, connect AC power of the product to commercial power through isolation transformer in order to avoid these dangers.

- If other equipment is connected to the same branch circuit, care should be taken not to overload the circuit.



- When installing this equipment, insure that a reliable ground connection is maintained.



- If you smell a strange odor, hear an unusual sound, or see smoke coming from this product, then disconnect power immediately by unplugging the AC power cable from the outlet.

Do not use this as it is because of the danger of electric shock and/or fire. In this case, contact your local distributor.

- Before setting up this emulator and connecting it to other devices, turn off power or remove a power cable to prevent injury or product damage.

Warnings to Be Taken for This Product:



- Do not disassemble or modify this product. Personal injury due to electric shock may occur if this product is disassembled and modified. Disassembling and modifying the product will void your warranty.

- Make sure nothing falls into the cooling fan on the top panel, especially liquids, metal objects, or anything combustible.

Warning for Installation:



- Do not set this product in water or areas of high humidity. Make sure that the product does not get wet. Spilling water or some other liquid into the product may cause unreparable damage.

Warning for Use Environment:



- This equipment is to be used in an environment with a maximum ambient temperature of 35°C. Care should be taken that this temperature is not exceeded.

 **CAUTION****Cautions to Be Taken for Turning On the Power:**

- Turn ON the power of the emulator and user system as simultaneously as possible. Turn OFF the power of the emulator and user system as simultaneously as possible.
- Do not leave either the emulator or user system powered on, because of leakage current the internal circuits may be damaged.
- When turning ON the power again after shutting OFF the power, wait about 10 seconds.

Cautions to Be Taken for Handling This Product:

- Use caution when handling the main unit. Be careful not to apply a mechanical shock.
- Do not touch the connector pins of the emulator main unit and the target MCU connector pins. Static electricity may damage the internal circuits.
- Do not pull this product by the communications interface cable or the cable for connecting to the emulator main unit and emulation probe. The cable may cause a break.
- Do not flex the flexible cable for connecting to the emulator main unit and emulation probe excessively. The cable may cause a break.
- Do not use inch-size screws for this equipment. The screws used in this equipment are all ISO (meter-size) type screws. When replacing screws, use same type screws as equipped before.

Caution to Be Taken for System Malfunctions:

- If the emulator malfunctions because of interference like external noise, do the following to remedy the trouble.
 - (1) Press the RESET switch on the PC7501's front panel.
 - (2) If normal operation is not restored after step (1), shut OFF power to the emulator once and then reactivate it.

Caution to Be Taken for External Trigger Input Voltage:

- Keep an external trigger input voltage of the emulator main unit less than a VCC voltage. Overvoltage may cause damage to the internal circuits.

Contents

	Page
Preface.....	3
Important.....	4
Precautions for Safety	6
Contents.....	9
User Registration	11
Terminology	12
1. Outline.....	13
1.1 Package Components	13
1.2 Other Tool Products Required for Development	14
1.3 System Configuration	15
1.3.1 System Configuration	15
1.3.2 Names and Functions of the PC7501 Upper Panel LEDs	16
1.4 Specifications	18
1.5 Operating Environment.....	19
2. Setup.....	20
2.1 Flowchart of Starting Up the Emulator	20
2.2 Installing the Emulator Debugger	21
2.3 Connecting the Host Machine	22
2.4 Connecting the PC7501	23
2.5 Connecting the Power Supply for the Emulator	24
2.6 Turning ON the Power.....	25
2.6.1 Checking the Connections of the Emulator System.....	25
2.6.2 Turning ON/OFF the Power	25
2.6.3 LED Display When the PC7501 Starts Up Normally.....	26
2.7 Downloading Firmware.....	27
2.7.1 When It is Necessary to Download Firmware	27
2.7.2 Downloading Firmware in Maintenance Mode.....	27
2.8 Self-check.....	28
2.8.1 Self-check Procedure	28
2.8.2 If an Error is Detected in the Self-check.....	29
2.9 Connecting the User System.....	30
2.9.1 Connecting to a 42-pin 0.8mm pitch Foot Pattern	31
2.9.2 Connecting to a 48-pin 0.5mm pitch Foot Pattern	32
2.9.3 Connecting to a 64-pin 0.5mm pitch Foot Pattern	33
2.9.4 Connecting to an 80-pin 0.5mm pitch Foot Pattern	34
2.9.5 Connecting to a 85-pin 0.65mm pitch Foot Pattern	35
2.10 A/D Conversion Bypass Capacitors	36
2.11 Selecting Clock Supply.....	37
2.11.1 Selecting Clock Supply	37
2.11.2 Using an Internal Oscillator Circuit Board	37
2.11.3 Using the Oscillator Circuit on the User System	41
2.11.4 Using the Internal Oscillator Circuit.....	41
3. Usage (Emulator Debugger).....	42
3.1 Starting Up the Emulator Debugger	42
3.1.1 INIT Dialog Box	42
3.1.2 MCU Setting Dialog Box	47
3.1.3 Checking Connections of the Emulator System.....	50
3.2 Program Window	51
3.3 Hardware Breakpoint Setting Window.....	55
3.4 Trace Window.....	60
3.5 RAM Monitor Window.....	64

	Page
4. Hardware Specifications	65
4.1 Target MCU Specifications	65
4.2 Differences between the Actual MCU and Emulator	66
4.3 Connection Diagrams	68
4.4 External Dimensions	69
4.4.1 External Dimensions of the Emulation Probe	69
4.4.2 External Dimensions of the Converter Board M30263T-42SSB	70
4.4.3 External Dimensions of the Converter Board M30260T-48FPD	70
4.4.4 External Dimensions of the Converter Board M30291T-64FPD	71
4.4.5 External Dimensions of the Converter Board M30290T-80FPD	71
4.4.6 External Dimensions of the Converter Board M30280T-85LGF	72
4.5 Notes on Using This Product	73
5. Troubleshooting	78
5.1 Flowchart to Remedy the Troubles	78
5.2 When the Emulator Debugger Does Not Start Up Properly	79
5.3 How to Request for Support	82
6. Maintenance and Guarantee	83
6.1 User Registration	83
6.2 Maintenance	83
6.3 Guarantee	83
6.4 Repair Provisions	83
6.5 How to Make Request for Repair	84

User Registration

When you have purchased the emulator presented in this user's manual, please be sure to register it. As the H/W Tool Customer Registration Sheet is included with this manual, fill it in and FAX it to your local distributor or email the same contents to the following address. If you register it by email, you can use a text format for user registration created when installing the software in the following folder. Your registered information is used for only after-sale services, and not for any other purposes. Without user registration, you will not be able to receive maintenance services such as a notification of field changes or trouble information. So be sure to carry out the user registration.

For more information about user registration, please email to the following address.

Text format for user registration C:\Program Files\Renesas\Hew\Support

For user registration regist_tool@renesas.com

Terminology

Some specific words used in this user's manual are defined as follows:

Emulator system

This means an emulator system built around the PC7501 emulator. The PC7501 emulator system is configured with an emulator main unit, emulation probe, host machine and integrated development environment High-performance Embedded Workshop.

Emulator main unit (Hereafter PC7501)

This means an emulator main unit for M16C Family MCUs.

Emulation probe

This means the emulation probe (this product) for the M16C/Tiny Series MCUs.

Emulator debugger

This means a software tool which starts up in the integrated development environment High-performance Embedded Workshop to control the PC7501 and this product.

Renesas Integrated development environment High-performance Embedded Workshop

This tool provides powerful support for the development of embedded applications for Renesas microcomputers. It has an emulator debugger function allowing for the PC7501 and emulation probe to be controlled from the host machine via an interface. Furthermore, it permits a range of operations from editing a project to building and debugging it to be performed within the same application. What's more, it supports version management.

Firmware

Program that analyzes contents of communication with the emulator debugger and controls the emulator hardware. This program is installed in the flash memory in the emulator main unit. This program is downloadable from the emulator debugger to upgrade the firmware or to support other MCUs.

Host machine

This means a personal computer used to control the emulator main unit and emulation probe.

Software break (S/W break)

A software break is a function to break the program before the system executes an instruction at the specified address. The instruction at the preset address will not be executed.

Hardware break (H/W break)

A hardware break is a function to break the program when the system detects a write/read of data to/from memory or a leading/trailing edge of the signal entered from the external trace cable. The former break function is called address break; and the latter break function is called trigger break. While the instruction at the address where the software break is set is not executed, a hardware break is performed after the specified instruction is executed.

Target MCU

This means the MCU you are going to debug.

User system

This means a user's application system using the microcomputer to be debugged.

User program

This means the program you are going to debug.

Evaluation MCU

This means the MCU mounted on the emulation probe which is operated in the specific mode for tools.

#

In this user's manual, this symbol is used to show active Low. (e.g. RESET#: Reset signal)

1. Outline

This chapter describes the package components, the system configuration and the preparation for using this product for the first time.

1.1 Package Components

The M3028BT-EPB package consists of the following items. When unpacking it, check to see if your M3028BT-EPB contains all of these items.

Table 1.1 Package components

Item	Quantity
M3028BT-EPB emulation probe	1
OSC-3 (20MHz) oscillator circuit board	1
OSC-2 oscillator circuit bare board	1
H/W Tool Customer Registration Sheet (English)	1
H/W Tool Customer Registration Sheet (Japanese)	1
Repair Request Sheet (English)	1
Repair Request Sheet (Japanese)	1
M3028BT-EPB User's Manual (this manual)	1
M3028BT-EPB User's Manual (Japanese)	1
M3028BT-EPB Supplementary Document (English)	1
M3028BT-EPB Supplementary Document (Japanese)	1

- * Please keep the M3028BT-EPB's packing box and cushion material in your place for reuse at a later time when sending your product for repair or other purposes. Always use these packing box and cushion material when transporting this product.
- * If there is any question or doubt about the packaged product, contact your local distributor.

1.2 Other Tool Products Required for Development

To bring forward programs development on the M16C/Tiny Series MCUs, the products listed below are necessary in addition to those contained package above. Get them separately.

Table 1.2 Other tool products required for development

Product		Product name	Notes
Emulator main unit		PC7501	-
Emulator debugger		M16C R8C PC7501 Emulator Debugger	V1.01 Release 00 or later
		M3T-PD30F	V2.20 Release 1 or later
Package converter board	42-pin 0.8mm pitch SSOP (PRSP0042GA-B, previous code: 42P2R-E)	M30263T-42SSB (included with the M3028BT-EPB-1)	Required according to the foot pattern of the user system.
	48-pin 0.5mm pitch LQFP (PLQP0048KB-A, previous code: 48P6Q-A)	M30260T-48FPD (included with the M3028BT-EPB-2)	
	64-pin 0.5mm pitch LQFP (PLQP0064KB-A, previous code: 64P6Q-A)	M30291T-64FPD (included with the M3028BT-EPB-3)	
	80-pin 0.5mm pitch LQFP (PLQP0080KB-A, previous code: 80P6Q-A)	M30290T-80FPD (included with the M3028BT-EPB-4)	
	85-pin 0.65mm pitch TFLGA (PTLG0085JB-A, previous code: 85F0G)	M30280T-85LGF (included with the M3028BT-EPB-5)	

* To purchase these products, contact your local distributor.

1.3 System Configuration

1.3.1 System Configuration

Figure 1.1 shows a configuration of the M3028BT-EPB system.

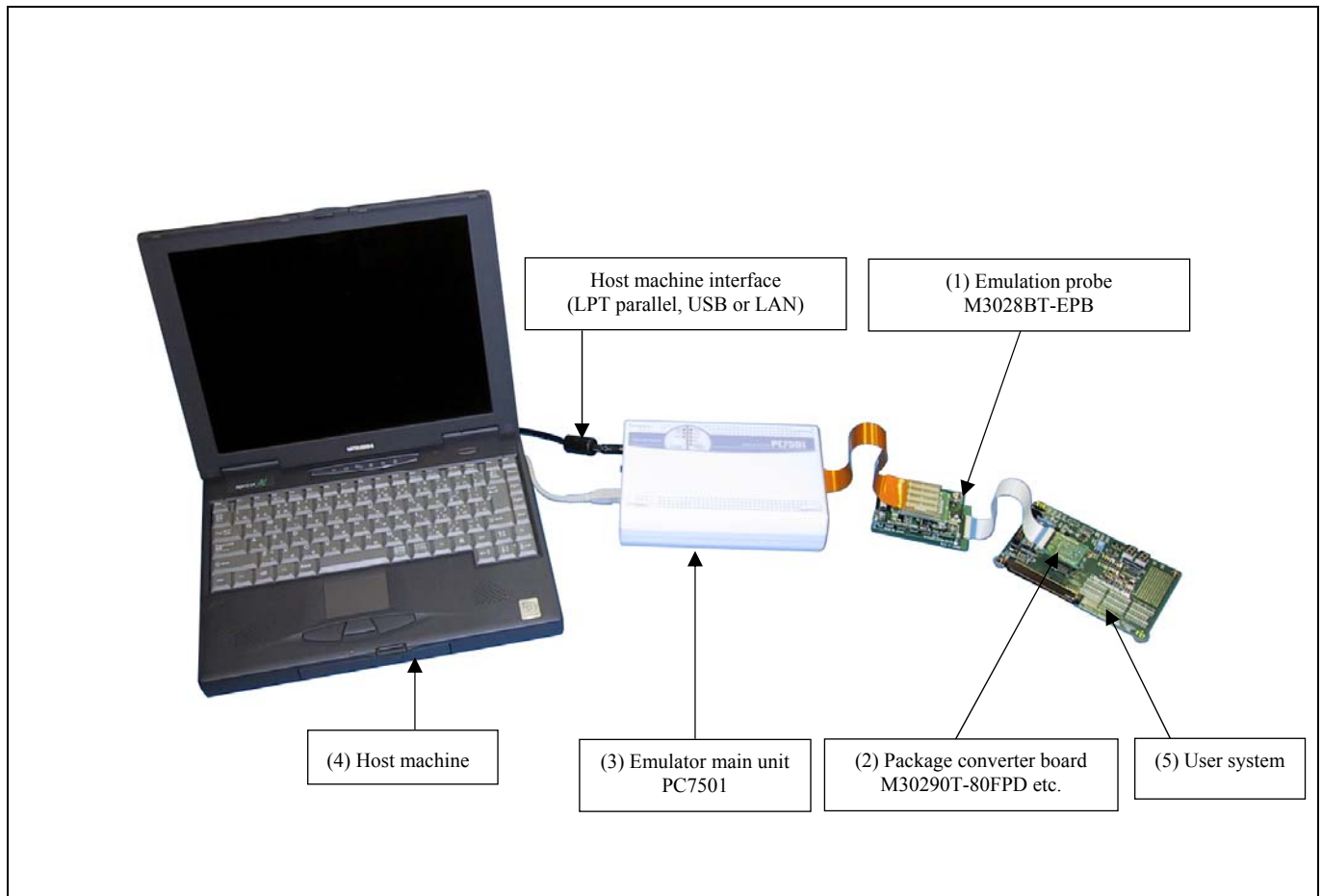

Figure 1.1 System configuration

(1) Emulation probe M3028BT-EPB (this product)

This emulation probe consists of the interface board PCA7501EPBA for the M16C/Tiny Series and MCU board M3028BT-EPBM for the M16C/Tiny Series MCUs. The M3028BT-EPBM with an evaluation MCU is separately available for replacement.

(2) Package converter board M30290T-80FPD etc

This is a converter board for connecting to the MCU foot pattern on the user system. For details, refer to "2.9 Connecting the User System" (page 30).

(3) Emulator main unit PC7501

The emulator main unit for the M16C family to be used with this product.

(4) Host machine

This is a personal computer for controlling the emulator.

(5) User system

This is your application system. This emulator cannot supply the power to the user system. Therefore design your system so that the user system is powered separately.

1.3.2 Names and Functions of the PC7501 Upper Panel LEDs

Figure 1.2 shows the names of the LEDs on the upper panel of the emulator.

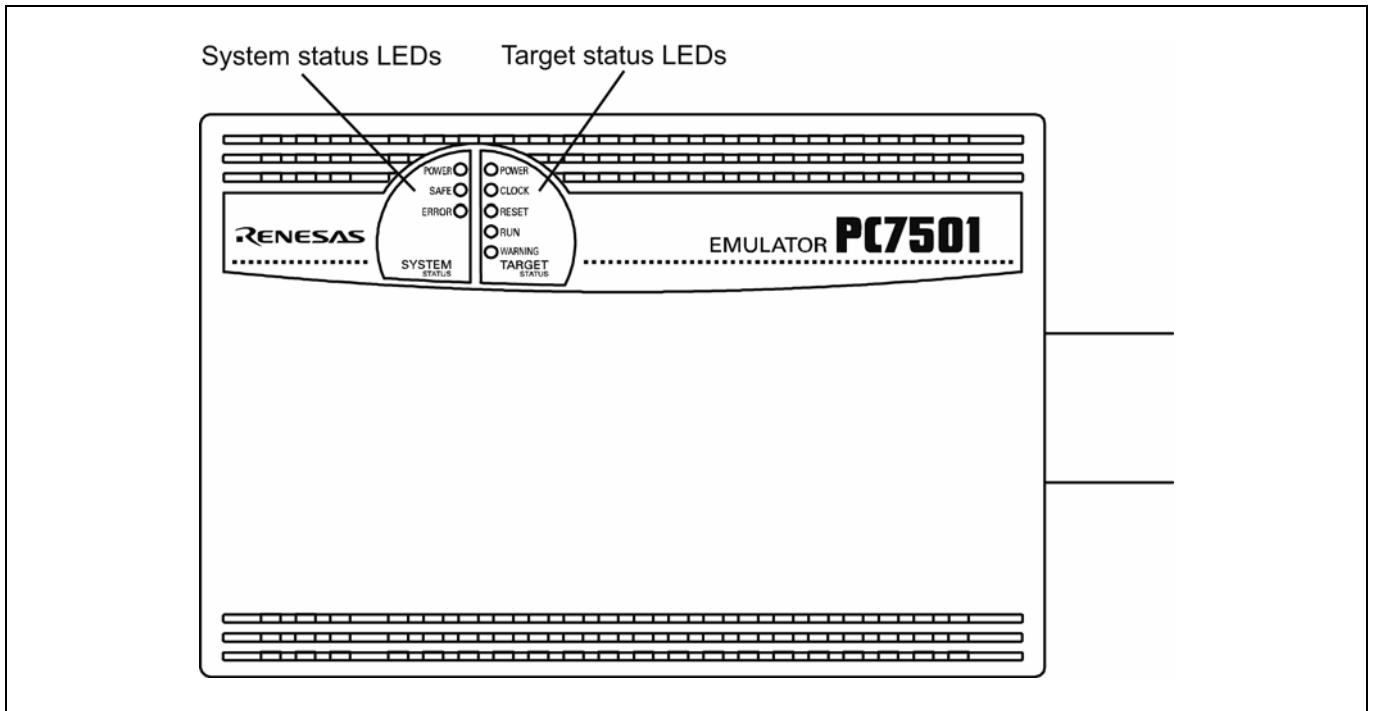

Figure 1.2 Names of the LEDs on the upper panel of the PC7501

(1) System Status LEDs

The system status LEDs indicate the emulator PC7501's power supply, firmware operating status, etc. Table 1.3 lists the definition of each system status LED.

Table 1.3 Definitions of the system status LEDs

Name	Status	Meaning
POWER	ON	Emulator system power supply is turned ON.
	OFF	Emulator system power supply is turned OFF.
SAFE	ON	Emulator system is operating normally.
	Flashing	1. The self-check is being executed. 2. Downloaded firmware is being written into memory. 3. If the ERROR LED is flashing on at the same time or alternately, it indicates that the self-check error occurred.
	OFF	PC7501 system is not operating normally (system status error).
ERROR	ON	PC7501 system is not operating normally (system status error).
	Flashing	1. Firmware is being downloaded. 2. If the SAFE LED is flashing at the same time or alternately, it indicates that the self-check error occurred.
	OFF	PC7501 system is operating normally.

(2) Target Status LEDs

The target status LEDs indicate the target MCU's operating status and target board's power supply. Table 1.4 lists the definition of each target status LED.

Table 1.4 Definitions of the target status LEDs

Name	Status	Meaning
POWER	ON	Power is supplied to the user system.
	OFF	Power is not supplied to the user system.
CLOCK	ON	Target MCU clock is oscillating.
	OFF	Target MCU clock is not oscillating.
RESET	ON	Target MCU is being reset, or reset signal of the user system is held low.
	OFF	Target MCU is not being reset.
RUN	ON	User program is being executed.
	OFF	User program has been halted.
WARNING	ON	Address 00000h or 00001h has been read out.
	OFF	Address 00000h or 00001h has not been read out.

CAUTION

Note on the Target Status POWER LED:

- If your MCU has two or more VCC pins, the LED does not light unless power is supplied to all the pins.

Note on the Target Status CLOCK LED:

- If the LED is not turned on, check the following.
 - (1) After powering on the PC7501 (before starting up the emulator debugger):
Make sure that the oscillator circuit board is properly installed in the PC7501 and it is oscillating normally.
 - (2) After the emulator debugger is started up (after the Init dialog box settings are completed):
Make sure that the oscillator selected in the Init dialog box is oscillating normally.

Note on Accessing Addresses 00000h and 00001h:

- With the M16C/Tiny Series MCUs, when a maskable interrupt is generated, the interrupt data (interrupt number and interrupt request level) stored in addresses 00000h and 00001h are read out. Also, the interrupt request bit is cleared when address 00000h or 00001h is read out. Consequently, when the address 00000h or 00001h readout instruction is executed or when address 00000h or 00001h is read out in the cause of a program runaway, a malfunction occurs in that the interrupt is not executed despite the interrupt request, because the request bit of the highest priority interrupt factor enabled is cleared.
For this malfunction, when the reading out to address 00000h or 00001h is generated excluding the interrupt, the WARNING LED (yellow) on the PC7501 front panel lights up to alarm. When this LED lights, there is a possibility of read access, therefore check the user program.

1.4 Specifications

Tables 1.5 lists the specifications of the M3028BT-EPB.

Table 1.5 M3028BT-EPB specifications (1/2)

Emulator	PC7501
Applicable MCU	M16C/Tiny Series MCUs
Evaluation MCU	M30290FCWP ROM: 128KB + 4KB, RAM: 12KB
Usable MCU mode	Single-chip mode
Max. ROM/RAM capacity	(1) Internal flash ROM: 128KB + 4KB 0F000h--0FFFFh, E0000h--FFFFFFh, for the maximum operating frequency, refer to *1. (2) Internal RAM: 12KB 00400h--033FFh, for the maximum operating frequency, refer to *1.
Maximum operating frequency	Power voltage at 4.2 to 5.5V: 24MHz (PLL oscillation at 24MHz products) Power voltage at 3.0 to 5.5V: 20MHz Power voltage at 2.7 to 5.5V: 10MHz
Clock oscillator	X _{IN} -X _{OUT} : Internal oscillator circuit board Switchable to external oscillator input or internal generator circuit X _{CIN} -X _{COUT} (32.768kHz): Internal oscillator circuit Switchable to external oscillator input
Operating frequency	2.7 to 5.5 V
Power supply to emulator	Supplied from DC power supply of the emulator main unit
Connection to user system (see 2.9 "Connecting the User System" on page 30)	For 42-pin 0.8mm pitch SSOP (PRSP0042GA-B, previous code: 42P2R-E): M30263T-42SSB (included with the M3028BT-EPB-1) For 48-pin 0.5mm pitch LQFP (PLQP0048KB-A, previous code: 48P6Q-A): M30260T-48FPD (included with the M3028BT-EPB-2) For 64-pin 0.5mm pitch LQFP (PLQP0064KB-A, previous code: 64P6Q-A): M30291T-64FPD (included with the M3028BT-EPB-3) For 80-pin 0.5mm pitch LQFP (PLQP0080KB-A, previous code: 80P6Q-A): M30290T-80FPD (included with the M3028BT-EPB-4) For 85-pin 0.65mm pitch TFLGA (PTLG0085JB-A, previous code: 85F0G): M30280T-85LGF (included with the M3028BT-EPB-5)

*1 If "Disable Internal Flash ROM" of the MCU tab in the MCU Setting dialog box is checked, 0 wait access to the MCU internal flash ROM and MCU internal RAM in the MCU is enabled at 10MHz or less.

1.5 Operating Environment

Be sure to use this emulator with the operating environmental of the emulator and host machine listed in Tables 1.6 and 1.7.

Table 1.6 Operating environmental conditions

Item	Description
Operating temperature	5 to 35°C (no dew)
Storage temperature	-10 to 60°C (no dew)

Table 1.7 Operating environment of the host machine

Item	Description
Host machine	IBM PC/AT compatibles
OS	Windows 98SE * Windows Me Windows XP Windows 2000
CPU	Pentium III 600MHz or more recommended
Memory	128MB or more recommended
Pointing device such as mouse	Mouse or any other pointing device usable with the above OS that can be connected to the main body of the host machine.

* Windows is either registered trademarks or trademarks of Microsoft Corporation in the United States and other countries.

2. Setup

This chapter describes the preparation for using this product, the procedure for starting up the emulator and how to change settings.

2.1 Flowchart of Starting Up the Emulator

The procedure for starting up the emulator is shown in Figure 2.1. For details, refer to each section hereafter. And, when the emulator does not start up normally, refer to “5. Troubleshooting” (page 78).

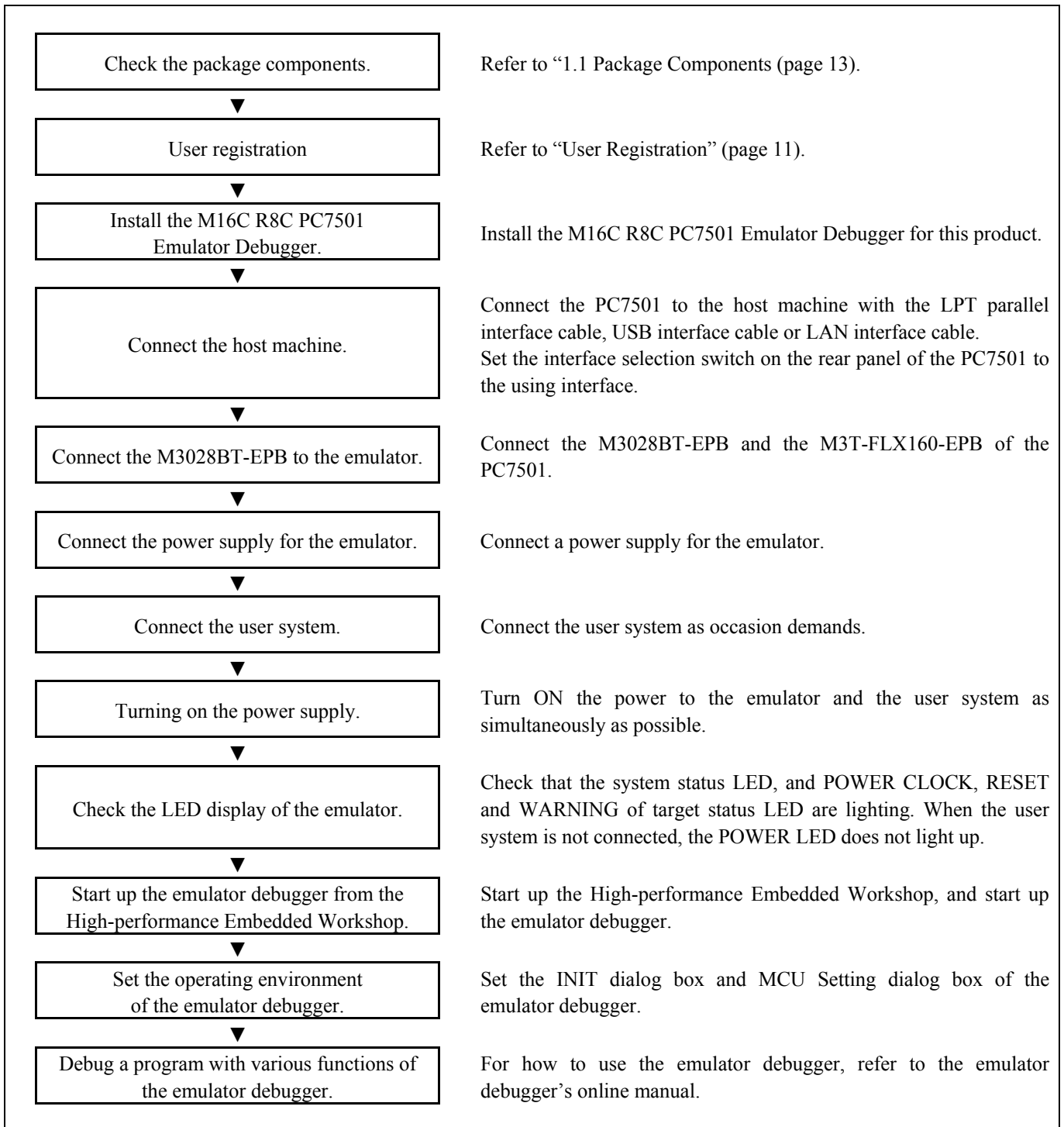

Figure 2.1 Flowchart of starting up the emulator

2.2 Installing the Emulator Debugger

If the OS used in your host machine is Windows XP or 2000, this installation must be executed by a user with administrator rights. Be aware that users without administrator rights cannot complete the installation.

Install the emulator debugger (M16C R8C PC7501 Emulator Debugger) following the procedure described below.

(1) Downloading the emulator debugger

Download the latest M16C R8C PC7501 emulator debugger from the URL below.

http://download.renesas.com/eng/mpumcu/upgrades/in_circuit_emulators/pc7501/index.html

(2) Launching the installer

Start the "setup.exe" program.

(3) Entering the user information

In the "user information" dialog box, enter the user information (contractor, section, contact address, and host machine).

The supplied information will be turned into a format by which technical support will be provided by e-mail.

(4) Completing the installation

A dialog box will be displayed indicating that setup has been completed. It means that the installation you made is completed.

2.3 Connecting the Host Machine

When connecting the emulator PC7501 to a host machine, you can choose your desired interface from LPT parallel interface, USB interface and LAN interface. Use the interface selection switch on the emulator PC7501's rear panel to specify your desired interface. Figure 2.2 shows the outline to connect each interface cable.

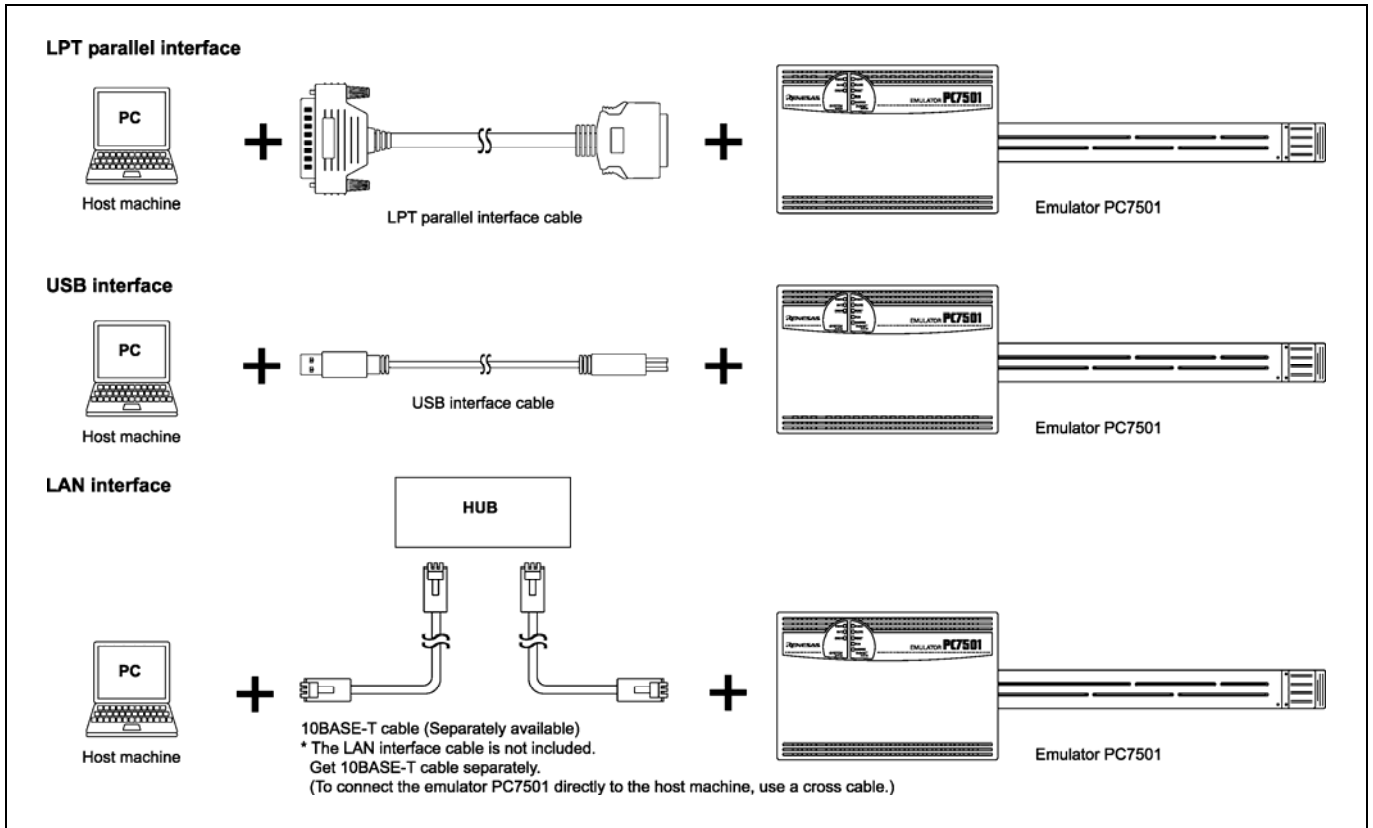

Figure 2.2 Outline for interface cable connections

2.4 Connecting the PC7501

Figure 2.3 shows how to connect the PC7501 and the emulation probe.

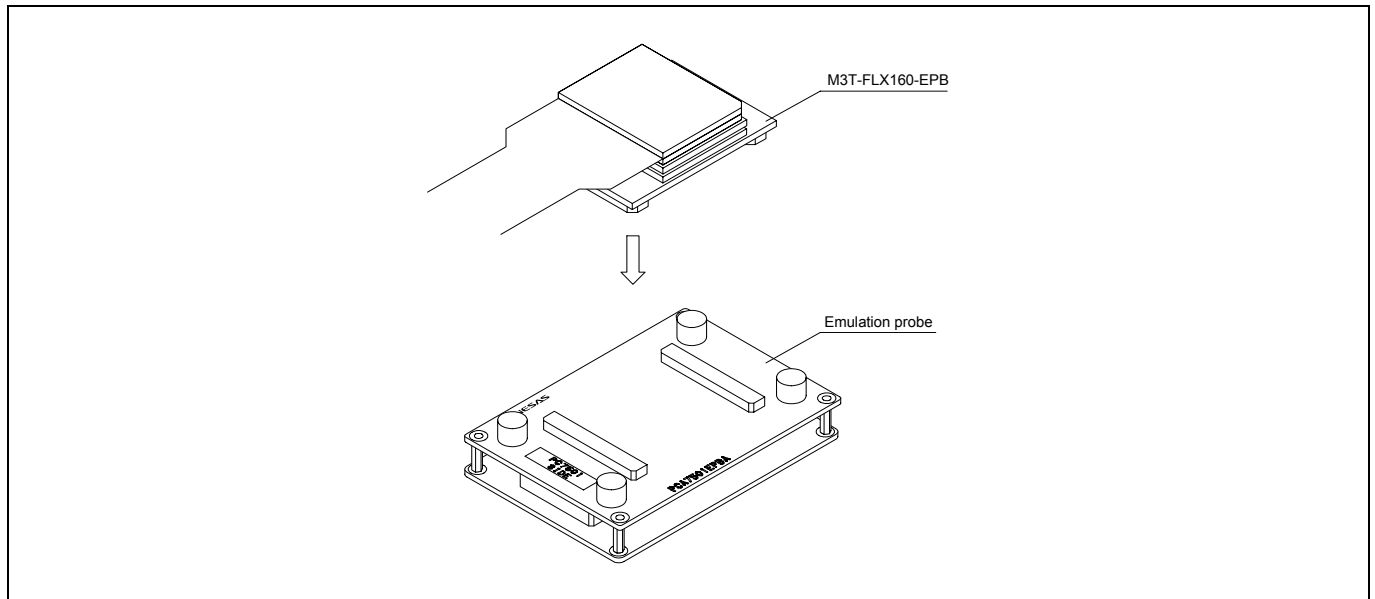

Figure 2.3 Connecting the PC7501 and emulation probe

CAUTION

Notes on Connecting the PC7501:



- When connecting the emulation probe, be sure to hold the both sides of the emulation probe horizontally and insert it directly.
- Always shut OFF power before connecting the emulation probe. Otherwise, internal circuits may be damaged.

IMPORTANT

Note on Connectors of the Converter board:

- The connectors of the emulation probe are guaranteed for only 50 insertion/removal iterations.

2.5 Connecting the Power Supply for the Emulator

The power is supplied from AC adapter to the emulator PC7501. Here following explains how to connect the AC adapter.

- (1) Turn OFF the power to the PC7501.
- (2) Connect the DC cable of AC adapter to the PC7501.
- (3) Connect the AC power cable to the AC adapter.
- (4) Connect the AC power cable to the receptacle.

CAUTION

Notes on AC Adapter:



- Use only the AC adapter included in PC7501 package.
- The included AC adapter is for PC7501. Do not use it for other product.
- Before installing this equipment or connecting it to other equipment, disconnect the AC power cable from its outlet to prevent injury or accident.
- The DC plug on the included AC adapter has the below polarity.



- The included AC adapter has no power supply switch. The AC adapter is always active while connecting the AC power cable. Check if the power is supplied by the LED of AC adapter.

2.6 Turning ON the Power

2.6.1 Checking the Connections of the Emulator System

Before turning the power ON, check the connection of the interface cable with host machine, PC7501, emulation probe, and user system.

2.6.2 Turning ON/OFF the Power

- Turn ON the power of the emulator and user system as simultaneously as possible.
- Turn OFF the power of the emulator and user system as simultaneously as possible.
- Do not leave either the emulator or user system powered on, because of leakage current the internal circuits may be damaged.
- When turning ON the power again after shutting OFF the power, wait for about 10 seconds.

IMPORTANT

Notes on Power Supply:

- Pin VCC is connected in order to monitor user system voltage. For this reason, the emulator cannot supply power to the user system. Therefore, provide the user system with a separate power supply.
- The voltage of the user system should be as follows.
 $2.7\text{ V} \leq \text{VCC} \leq 5.5\text{ V}$
- Do not change the voltage of the user system after turning on the power.

2.6.3 LED Display When the PC7501 Starts Up Normally

Figure 2.4 shows upper panel LED lighting status when the emulator started up properly. Check it when starting up the emulator system.

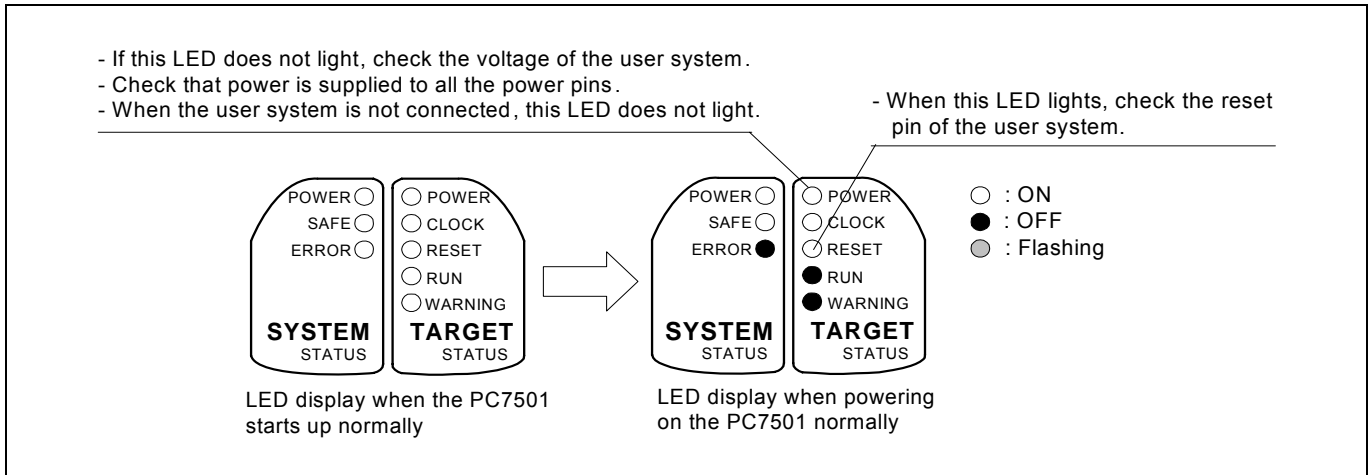

Figure 2.4 LED display of the PC7501 when the power turned on

IMPORTANT

Note on the Target Status POWER LED:

- If your MCU has two or more VCC pins, the LED does not light unless power is supplied to all the pins.

Note on the Target Status CLOCK LED:

- If the LED is not turned on, check the following.
 - (1) After powering on the PC7501 (before starting up the emulator debugger):
 Make sure that the oscillator circuit board is properly installed in the PC7501 and it is oscillating normally.
 - (2) After the emulator debugger is started up (after the Init dialog box settings are completed):
 Make sure that the oscillator selected in the Init dialog box is oscillating normally.

2.7 Downloading Firmware

2.7.1 When It is Necessary to Download Firmware

It is necessary to download the firmware in the cases listed below. Normally, the following are automatically detected when the emulator debugger is started up, and the firmware is downloaded.

- (1) When you use this product for the first time
- (2) When the firmware has been upgraded
- (3) When the emulator debugger has been upgraded
- (4) When you use this product with a PC7501 which was used with other emulation probe before

If downloading firmware is not completed in the cases below, redownload the firmware.

- When the power is unexpectedly shut down during a download from the emulator debugger
- When a communications interface cable is unexpectedly pulled out

2.7.2 Downloading Firmware in Maintenance Mode

Download the firmware in maintenance mode as explained here following. **The user system must not be connected when downloading the firmware.**

- (1) Set the interface select switch on the rear panel of the PC7501 to the LPT side and connect the LPT parallel interface cable to the PC7501 and the host machine.
- (2) Within 2 seconds of activating power to the emulator, press the RESET switch on the PC7501 front panel to switch to maintenance mode.

Switched to maintenance mode, the SAFE SYSTEM STATUS LED begins to flash.

- (3) Start up the emulator debugger. When the Init dialog box setup is complete, the dialog which urges to download the firmware will appear. Download the firmware following messages. Required time for downloading the firmware is about 60 seconds.

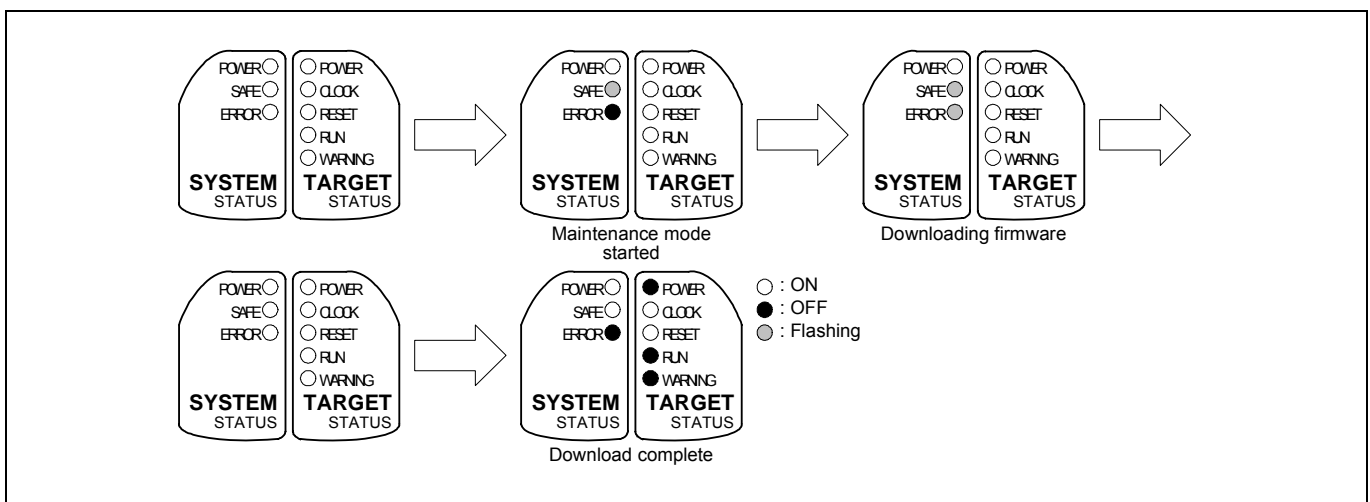

Figure 2.5 Downloading firmware in maintenance mode

IMPORTANT

Note on Downloading Firmware:

- Do not shut OFF power while the firmware is being downloaded. Doing so, the emulator will not start up properly. If power is shut OFF by mistake, redownload the firmware in maintenance mode.

2.8 Self-check

2.8.1 Self-check Procedure

The self-check is a function to check the memory etc. mounted in the emulator. To run the self-check of the emulator, do so as explained here below. While the self-check is in progress, the LEDs will change as shown in Figure 2.6. In case of ERRORS 1 to 4, because the target status LEDs will change depending on errors, check the system status LEDs.

- (1) If the user system is connected, disconnect it.
- (2) Within 2 seconds of activating power to the emulator, press the system reset switch on the emulator front panel to switch the emulator to maintenance mode.
- (3) Check the "SAFE" LED starts flashing and then press the system reset switch again.
- (4) The self-check will start. If the normal result is displayed in about 30 seconds, the self-check terminated normally.

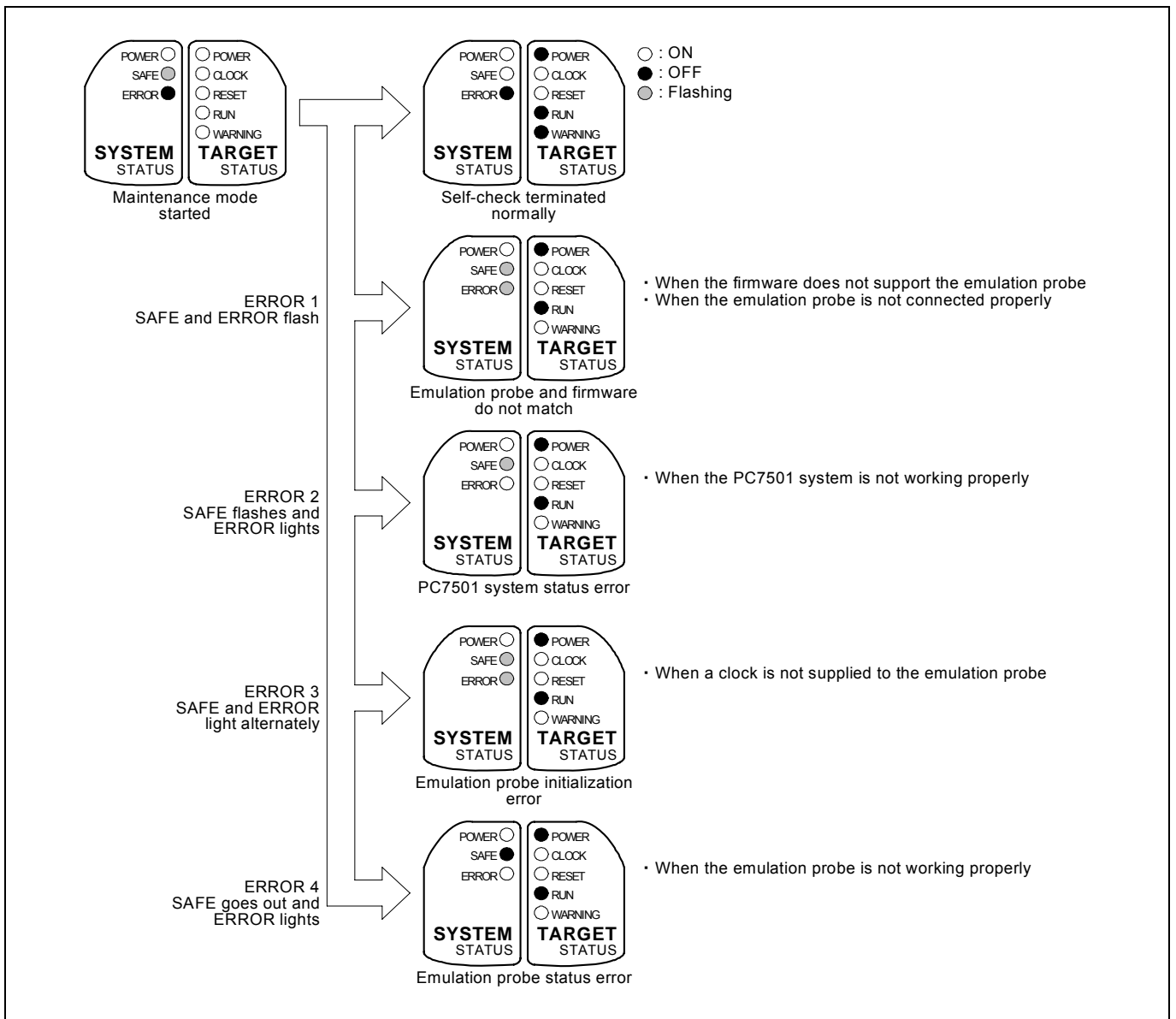

Figure 2.6 Self-check procedure

2.8.2 If an Error is Detected in the Self-check

If the self-check does not result normally (ERROR 1 to ERROR 4 in Figure 2.6), check the following.

- (1) Recheck the connection of the emulation probe and PC7501.
- (2) Redownload the proper firmware.

IMPORTANT

Notes on the Self-check:

- Disconnect the user system before execute the self-check.
- If the self-check does not result normally (excluding user system errors), the emulation probe may be damaged. Then contact your local distributor.

2.9 Connecting the User System

There are eight ways available to connect the emulation probe to user systems as shown in Figure 2.7.

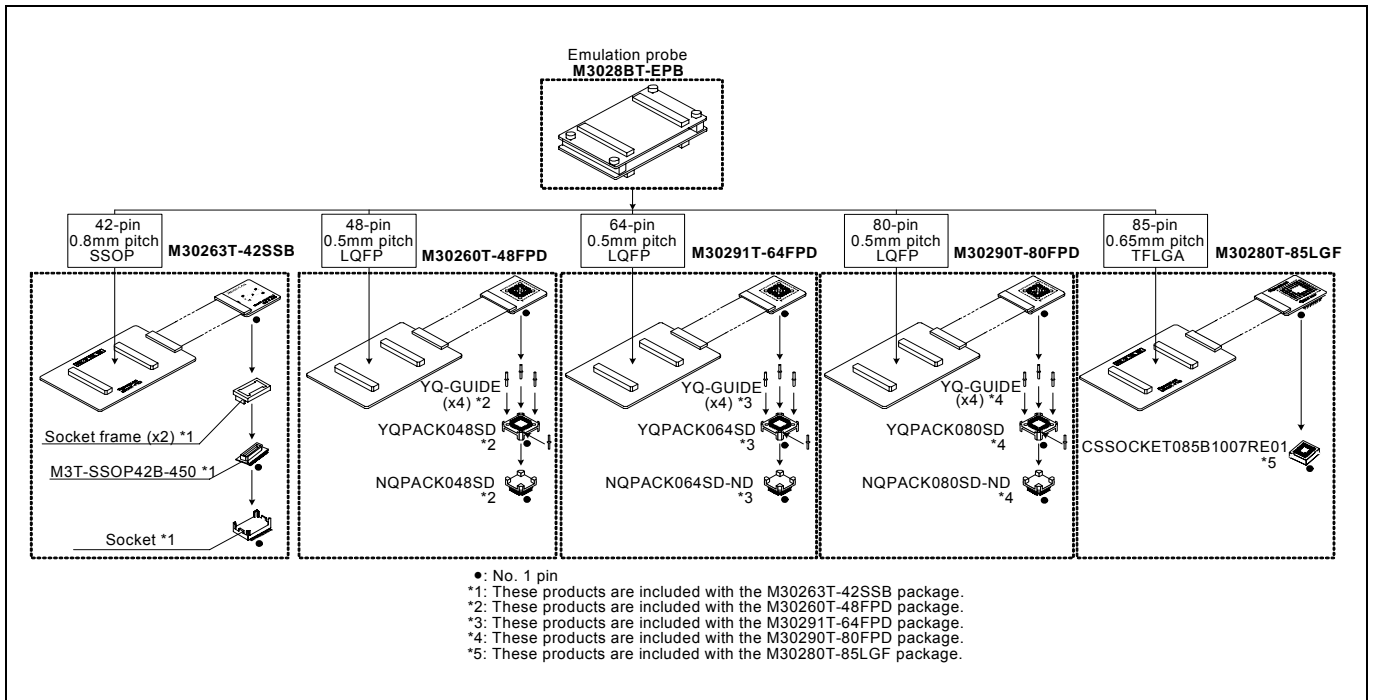

Figure 2.7 Connection of the M3028BT-EPB and user system

⚠ CAUTION

Note on Connecting the User System:



- Take care not to attach the converter board in a wrong direction. It may cause a fatal damage to the emulator and user system.

* NQPACK, YQPACK, YQSOCKET, YQ-GUIDE, HQPACK, TQPACK, TQSOCKET, CSSOCKET and CSPLUG/W are trademarks of Tokyo Eletech Corporation.

2.9.1 Connecting to a 42-pin 0.8mm pitch Foot Pattern

Here following is a procedure of connecting to a 42-pin 0.8mm pitch foot pattern on the user system using the M30263T-42SSB (included with the M3028BT-EPB-1). For details on the M30263T-42SSB, refer to its user's manual.

- (1) Mount the socket main unit included with the M30263T-42SSB to the user system.
- (2) Attach the M3T-SSOP42B-450 included with the M30263T-42SSB and the socket frame to the socket main unit.
- (3) Attach the J1 and J2 of the M30290T-PTCB to the J3 and J4 of the M3028BT-EPB.
- (4) Attach the M30263T-42SSB to the M3T-SSOP42B-450.

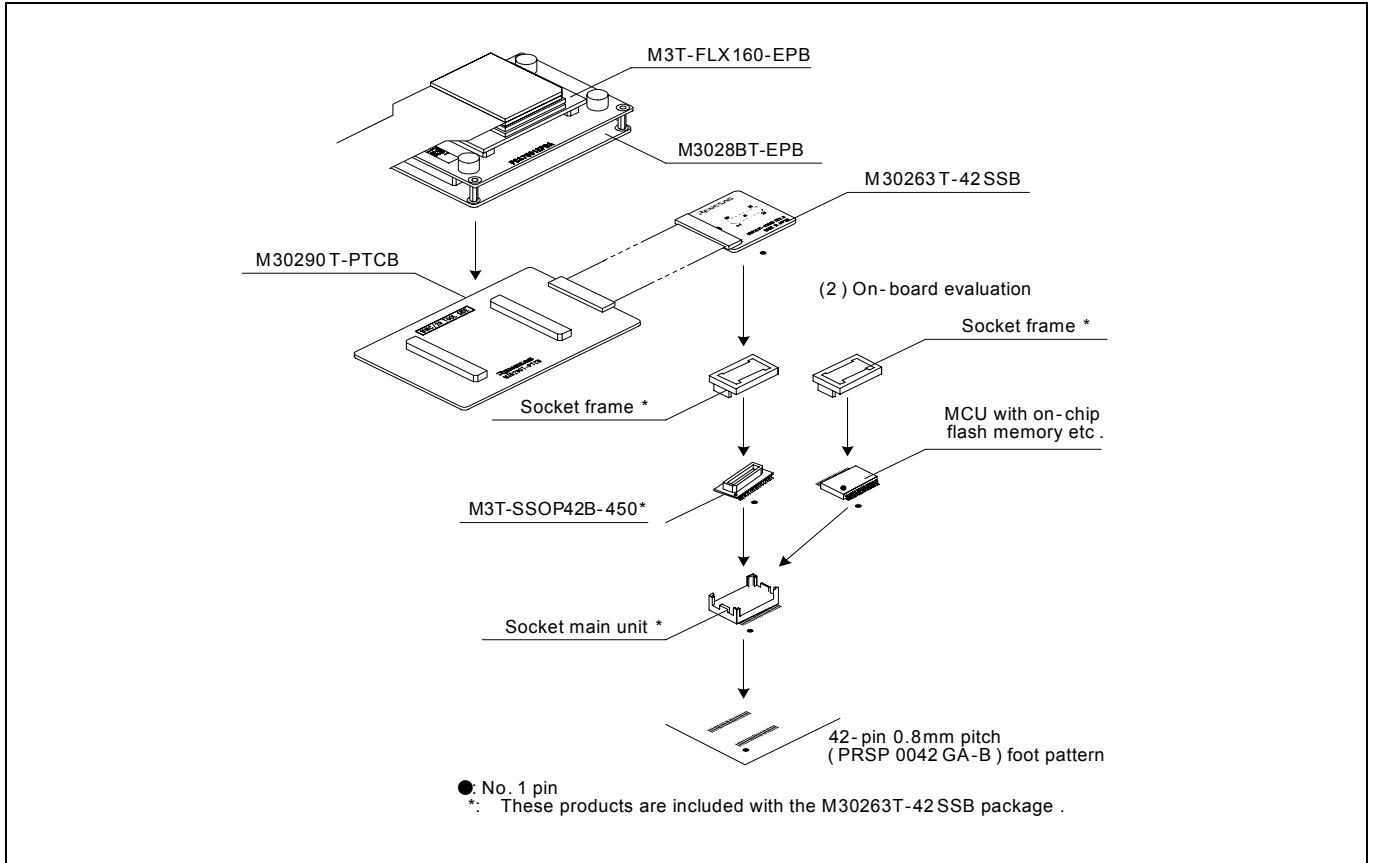

Figure 2.8 Connecting to a 42-pin 0.8mm pitch foot pattern

CAUTION

Note on Connecting the User System:



- Take care not to attach a converter board in a wrong direction. It may cause a fatal damage to the emulator and targets system.

IMPORTANT

Notes on Connectors of the Converter Board:

- The connectors of the M3028BT-EPB and M30290T-PTCB are guaranteed for only 50 insertion/removal iterations.
- The connectors of the M30263T-42SSB and M3T-SSOP42B-450 are guaranteed for only 50 insertion/removal iterations.

2.9.2 Connecting to a 48-pin 0.5mm pitch Foot Pattern

Here following is a procedure of connecting to a 48-pin 0.5mm pitch foot pattern on the user system using the M30260T-48FPD (included with the M3028BT-EPB-2). For details on the M30260T-48FPD, refer to its user's manual.

- (1) Mount the NQPACK048SD included with the M30260T-48FPD to the user system.
- (2) Attach the YQPACK048SD included with the M30260T-48FPD to the NQPACK048SD and secure it with the YQ-GUIDE's.
- (3) Attach the J1 and J2 of the M30290T-PTCB to the J3 and J4 of the M3028BT-EPB.
- (4) Attach the M30260T-48FPD to the YQPACK048SD.

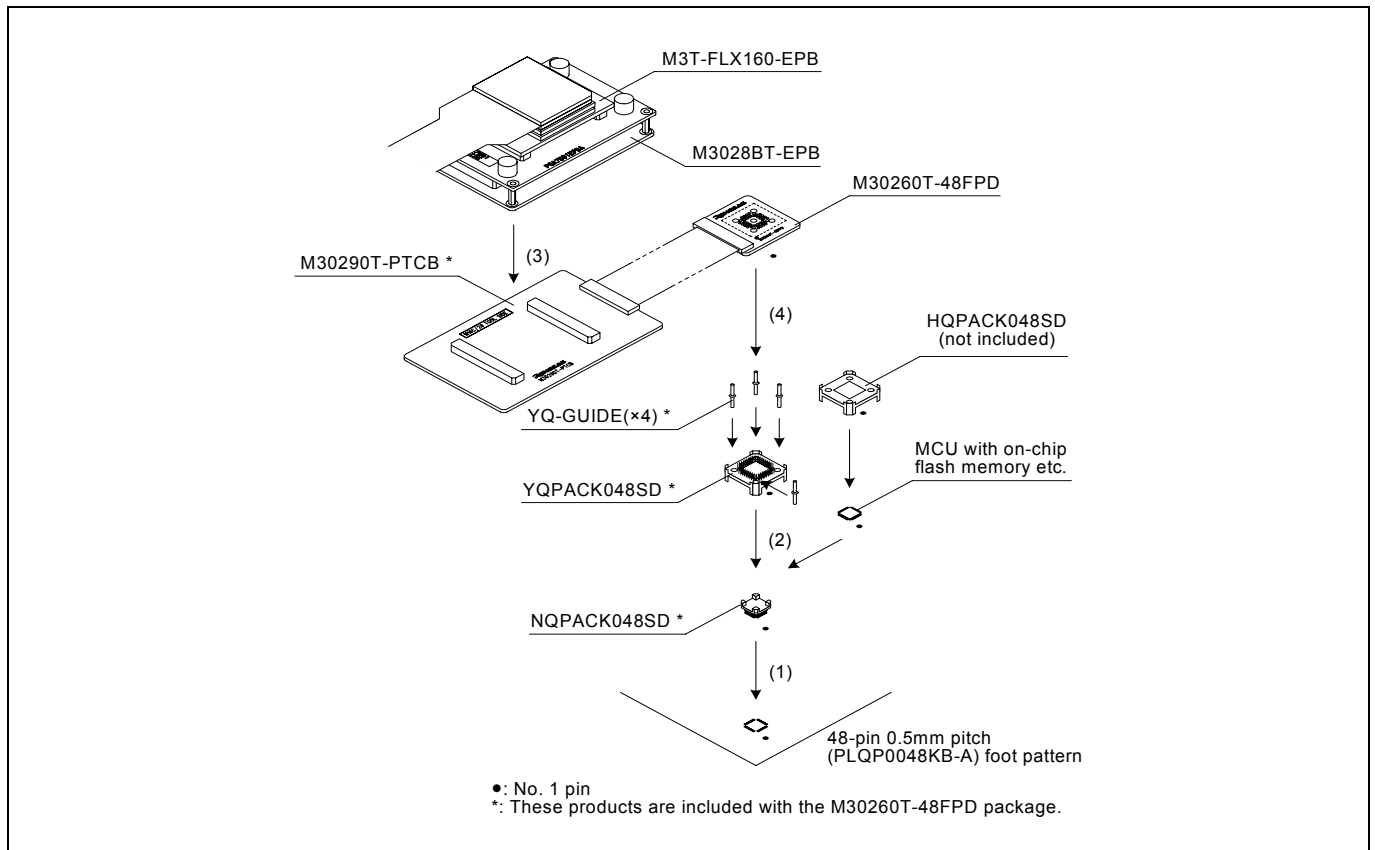

Figure 2.9 Connecting to a 48-pin 0.5mm pitch foot pattern

CAUTION

Note on Connecting the User System:



- Take care not to attach a converter board in a wrong direction. It may cause a fatal damage to the emulator and targets system.

IMPORTANT

Notes on Connectors of the Converter Board:

- The connectors of the M3028BT-EPB and M30290T-PTCB are guaranteed for only 50 insertion/removal iterations.
- The connectors of the M30260T-48FPD and YQPACK048SD are guaranteed for only 100 insertion/removal iterations.

2.9.3 Connecting to a 64-pin 0.5mm pitch Foot Pattern

Here following is a procedure of connecting to a 64-pin 0.5mm pitch foot pattern on the user system using the M30291T-64FPD (included with the M3028BT-EPB-3). For details on the M30291T-64FPD, refer to its user's manual.

- (1) Mount the NQPACK064SD-ND included with the M30291T-64FPD to the user system.
- (2) Attach the YQPACK064SD included with the M30291T-64FPD to the NQPACK064SD-ND and secure it with the YQ-GUIDE's.
- (3) Attach the J1 and J2 of the M30290T-PTCB to the J3 and J4 of the M3028BT-EPB.
- (4) Attach the M30291T-64FPD to the YQPACK064SD.

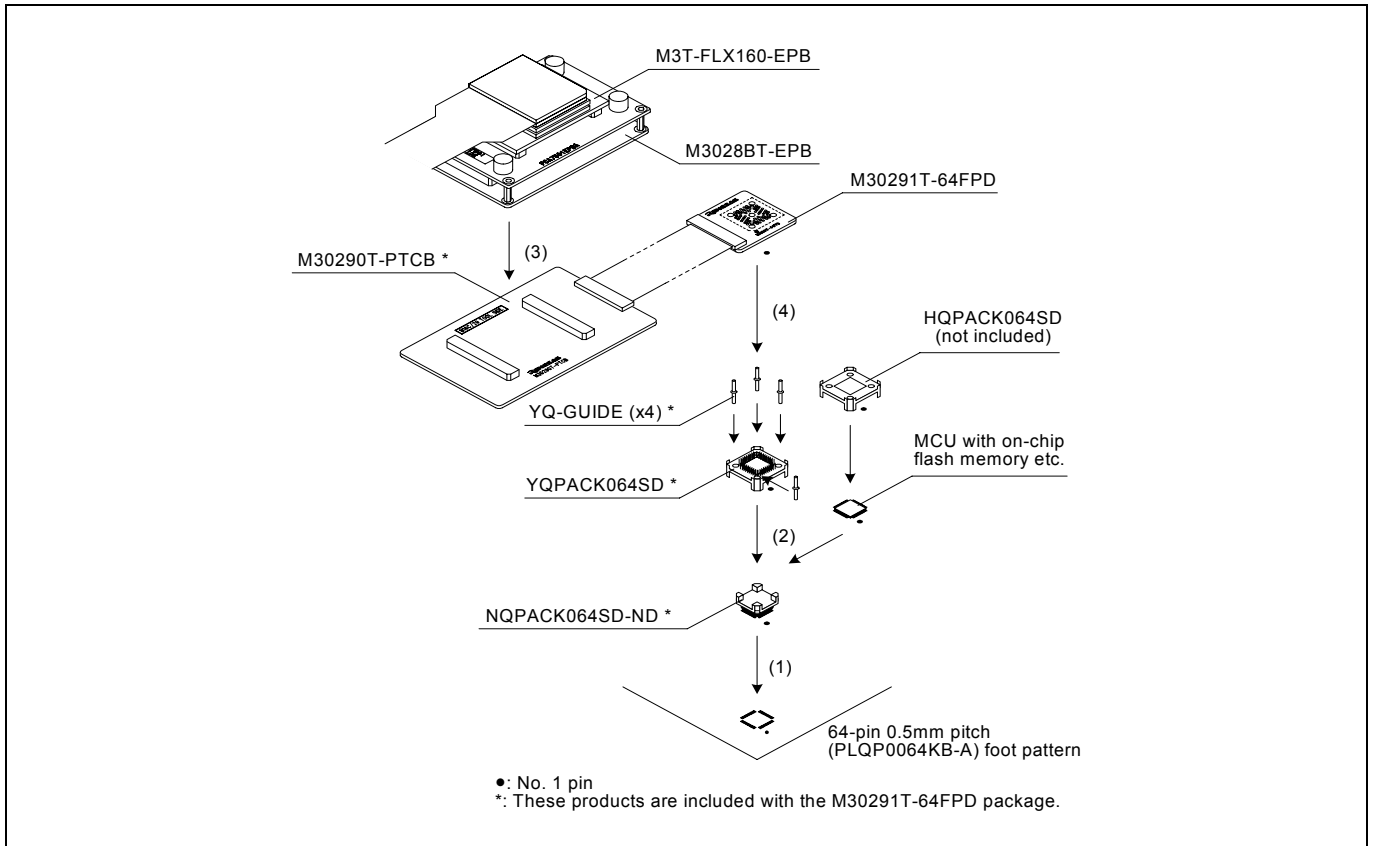

Figure 2.10 Connecting to a 64-pin 0.5mm pitch foot pattern

! CAUTION

Note on Connecting the User System:



- Take care not to attach a converter board in a wrong direction. It may cause a fatal damage to the emulator and targets system.

IMPORTANT

Notes on Connectors of the Converter Board:

- The connectors of the M3028BT-EPB and M30290T-PTCB are guaranteed for only 50 insertion/removal iterations.
- The connectors of the M30291T-64FPD and YQPACK064SD are guaranteed for only 100 insertion/removal iterations.

2.9.4 Connecting to an 80-pin 0.5mm pitch Foot Pattern

Here following is a procedure of connecting to an 80-pin 0.5mm pitch foot pattern on the user system using the M30290T-80FPD (included with the M3028BT-EPB-4). For details on the M30290T-80FPD, refer to its user's manual.

- (1) Mount the NQPACK080SD-ND included with the M30290T-80FPD to the user system.
- (2) Attach the YQPACK080SD included with the M30290T-80FPD to the NQPACK080SD-ND and secure it with the YQ-GUIDE's.
- (3) Attach the J1 and J2 of the M30290T-PTCB to the J3 and J4 of the M3028BT-EPB.
- (4) Attach the M30290T-80FPD to the YQPACK080SD.

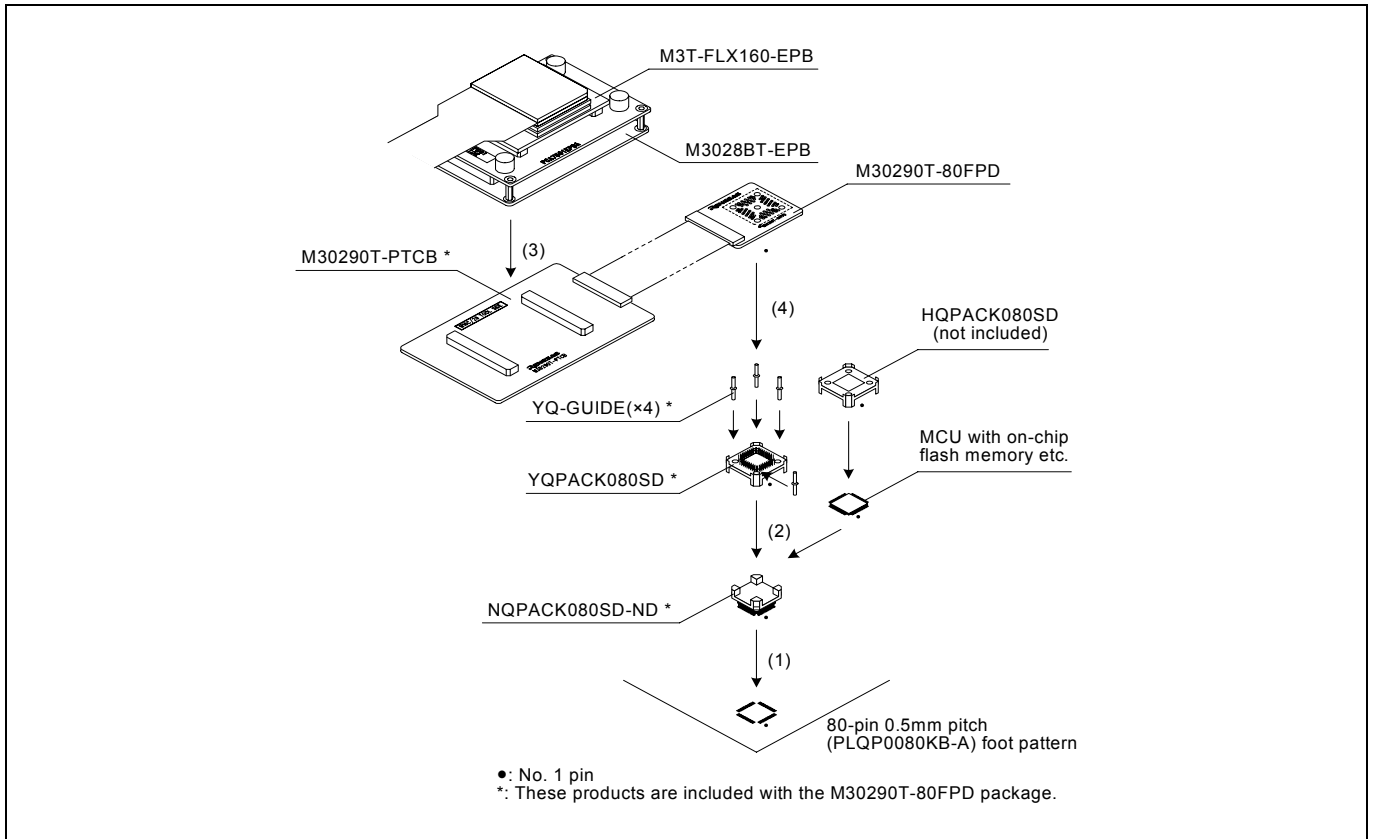

Figure 2.11 Connecting to an 80-pin 0.5mm pitch foot pattern

⚠ CAUTION

Note on Connecting the User System:

- Take care not to attach a converter board in a wrong direction. It may cause a fatal damage to the emulator and targets system.

IMPORTANT

Notes on Connectors of the Converter Board:

- The connectors of the M3028BT-EPB and M30290T-PTCB are guaranteed for only 50 insertion/removal iterations.
- The connectors of the M30290T-80FPD and YQPACK080SD are guaranteed for only 100 insertion/removal iterations.

2.9.5 Connecting to a 85-pin 0.65mm pitch Foot Pattern

Here following is a procedure of connecting to an 85-pin 0.65mm pitch foot pattern on the user system with the M30280T-85LGF (included with the M3028BT-EPB-5), and here following is its procedure. For details on the M30280T-85LGF, refer to its user's manual.

- (1) Attach the CSSOCKET085B1007RE01 included with the M30280T-85LGF to the user system.
- (2) Attach the J1 and J2 of the M30290T-PTCB to the J3 and J4 of the M3028BT-EPB.
- (3) Attach the M30280T-85LGF to the CSSOCKET085B1007RE01.

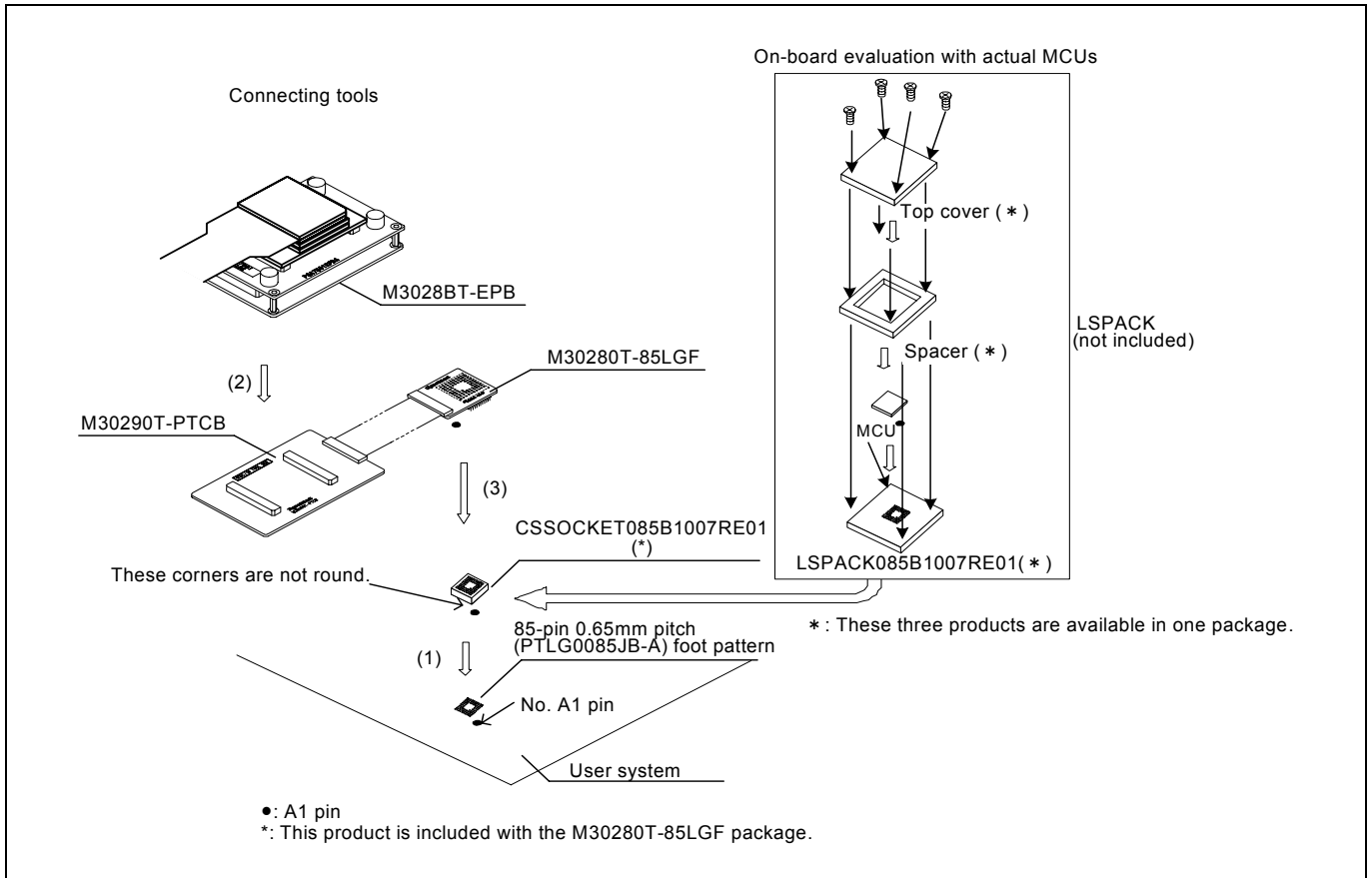

Figure 2.12 Connecting to an 85-pin 0.65mm pitch foot pattern

⚠ CAUTION

Note on Connecting the User System:



- Take care not to attach the converter board in a wrong direction. It may cause a fatal damage to the emulator and user system.

IMPORTANT

Notes on Connectors of the Converter Board:

- The connectors of the M3028BT-EPB and M30290T-PTCB are guaranteed for only 50 insertion/removal iterations.
- The connectors of the M30280T-85LGF and CSSOCKET085B1007RE01 are guaranteed for only 100 insertion/removal iterations.

2.10 A/D Conversion Bypass Capacitors

There is a foot pattern on the M3028BT-EPBM board for mounting bypass capacitors for the A/D conversion circuit near the MCU. Mount suitable bypass capacitors as occasion demands. Figure 2.13 shows where they are installed and the configuration of this product.

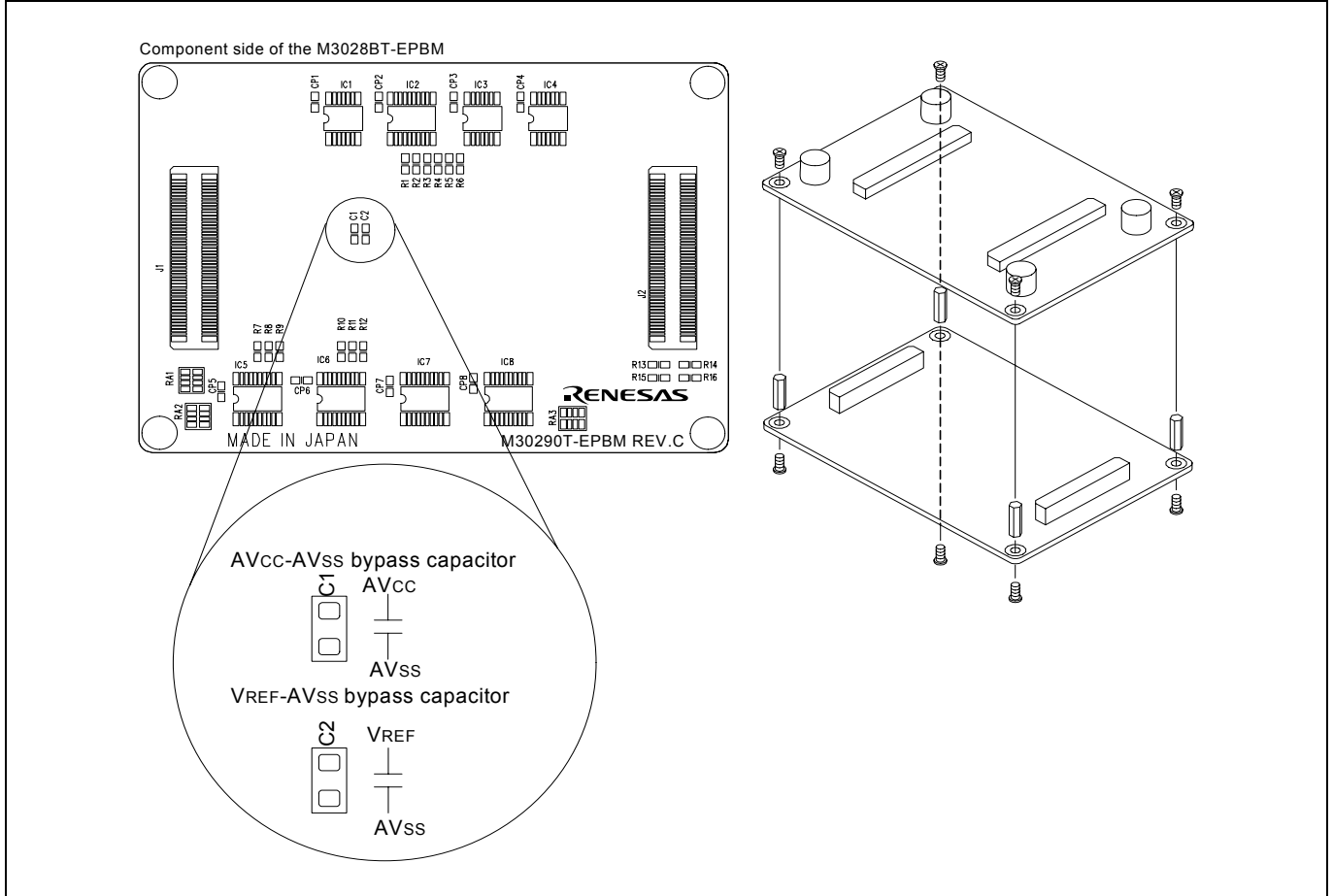

Figure 2.13 Foot pattern for A/D conversion bypass capacitors and the configuration of this product

IMPORTANT

Note on the A/D Converter Function:

- Because a package converter board and other devices are used between the evaluation MCU and the user system, the A/D converter operates differently from that of an actual MCU. Make the final evaluation of the A/D converter with an actual MCU.

2.11 Selecting Clock Supply

2.11.1 Selecting Clock Supply

You can choose a clock supplied to the evaluation MCU by the Emulator tab in the Init dialog box of the emulator debugger. Table 2.1 shows the clocks and their initial settings.

Table 2.1 Clock supply to the MCU and default settings

Clock	Display of emulator debugger	Description	Default setting
Main (X_{IN} - X_{OUT})	Internal	Internal oscillator circuit (OSC-3 or OSC-2)	Yes
	External	Oscillator circuit on the user system	-
	Generated	Internal generator circuit (1.0 to 20.0MHz)	-
Sub (X_{CIN} - X_{COUT})	Internal	Internal oscillator circuit (32.768 kHz)	-
	External	Oscillator circuit on the user system	Yes

IMPORTANT

Notes on Changing the Clock Supply:

- The clock supply can be set by the Init dialog box when starting up the emulator debugger or inputting CLK command on the script window.

2.11.2 Using an Internal Oscillator Circuit Board

(1) Kinds of Oscillator Boards

The PC7501 comes with an oscillator circuit board OSC-3 (30MHz). And an oscillator circuit board OSC-3 (20MHz) and an oscillator circuit bare board OSC-2 are included with this product. If you use an internal oscillator circuit board (20MHz) or OSC-2 as a main clock, choose "Internal" in the emulator debugger after replacing oscillator circuit boards to change a clock supplied to an MCU.

(2) Replacing an Oscillator Circuit Board

1. Remove the four screws of both sides of this product and lift off the upper cover (see Figure 2.14).

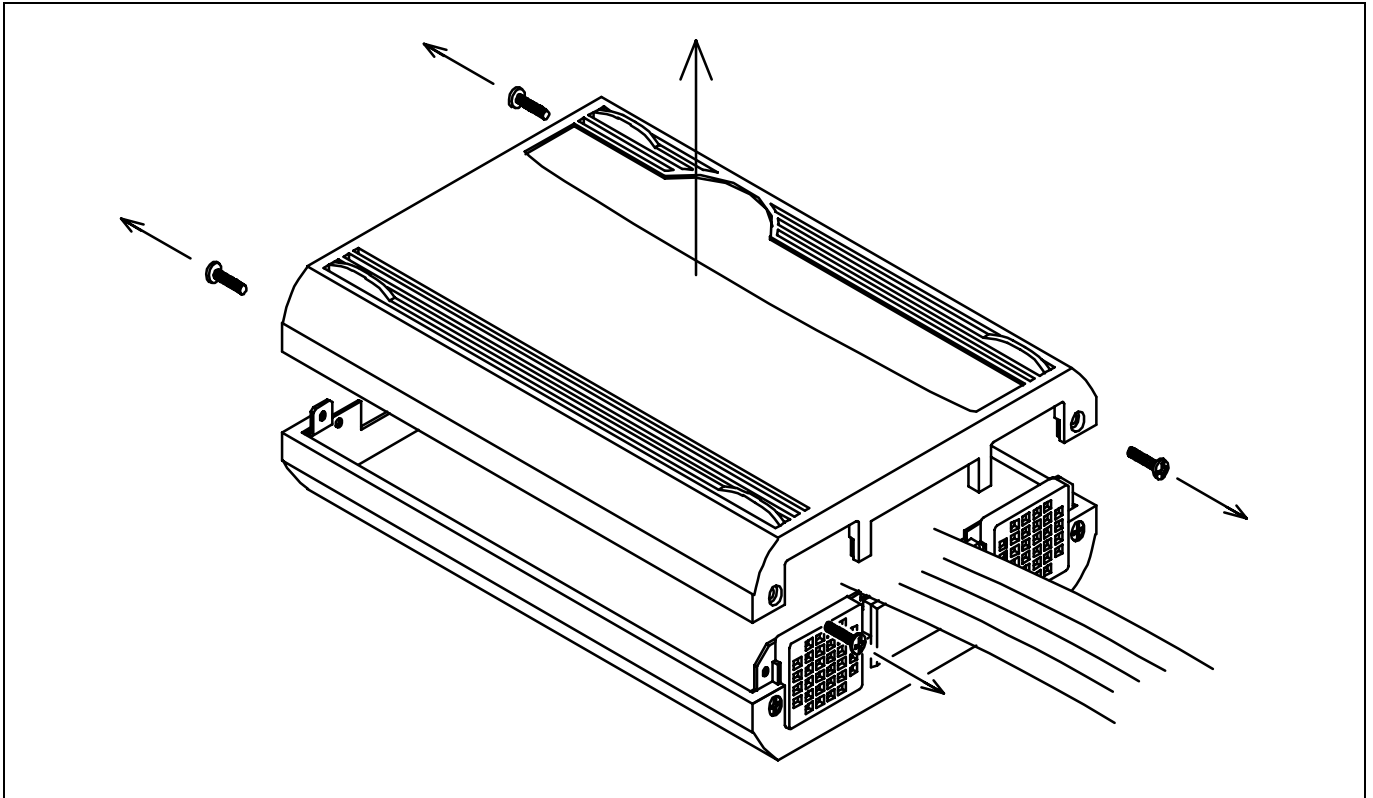

Figure 2.14 Removing the upper cover

2. Unscrew the screw of the oscillator circuit board of the PC7501 and replace it (see Figure 2.15).

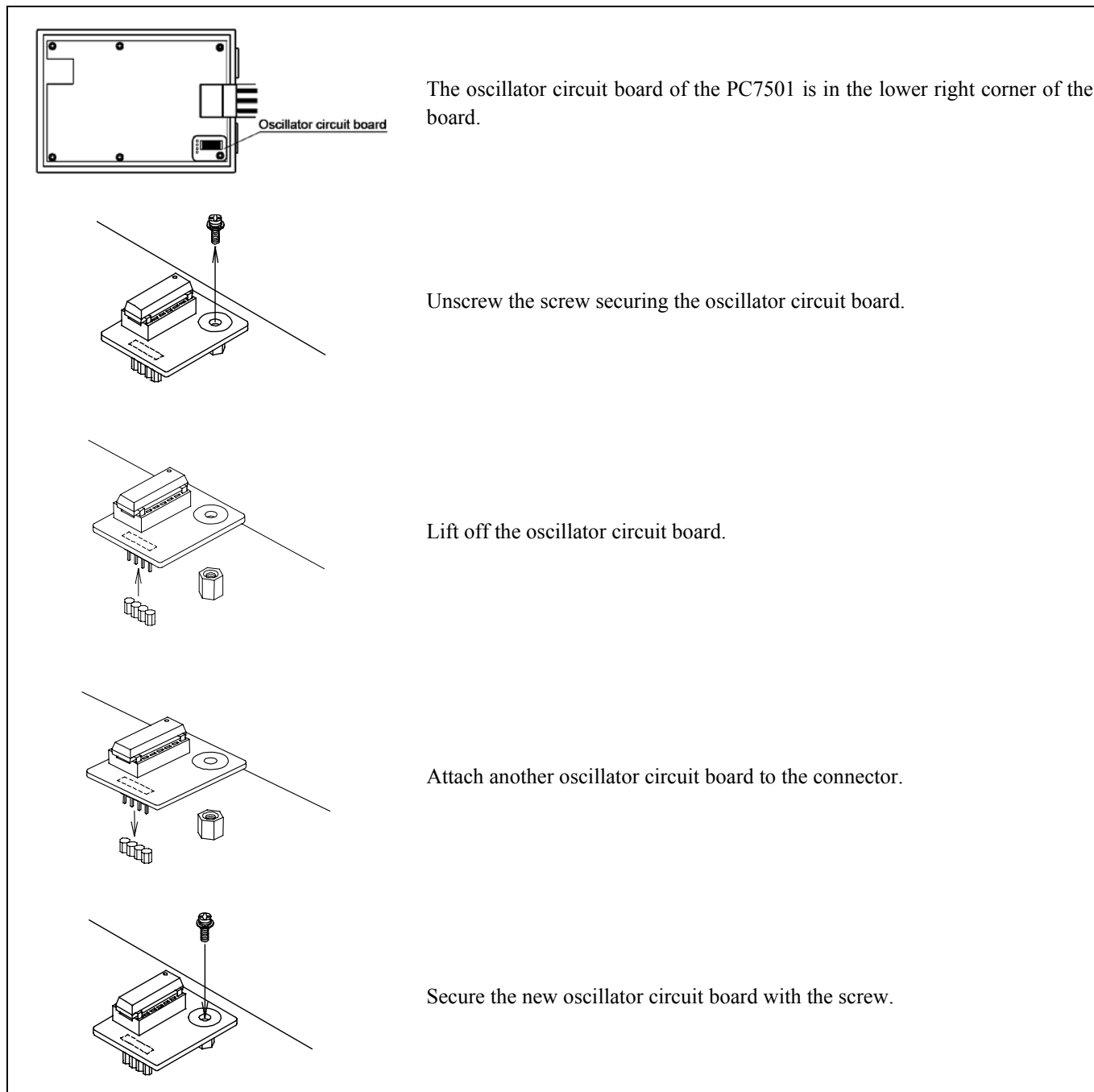

Figure 2.15 Replacing oscillator circuit boards

3. Reinstall the upper cover once removed and secure the four screws of the PC7501.

CAUTION

Note on Removing the Upper Cover:



- Always shut OFF power when removing the upper cover or changing the oscillator circuit board. Otherwise the internal circuit may be damaged.

(3) Using the Oscillator Circuit Bare Board

To use this product at a frequency you like, build a desired oscillator circuit on the included OSC-2 oscillator circuit bare board. Figure 2.16 shows an external view of the OSC-2 oscillator circuit bare board and the connector pin locations. Figure 2.17 shows the circuitry of the oscillator circuit bare board OSC-2. Use the number of oscillator circuits recommended by the oscillator manufacturer.

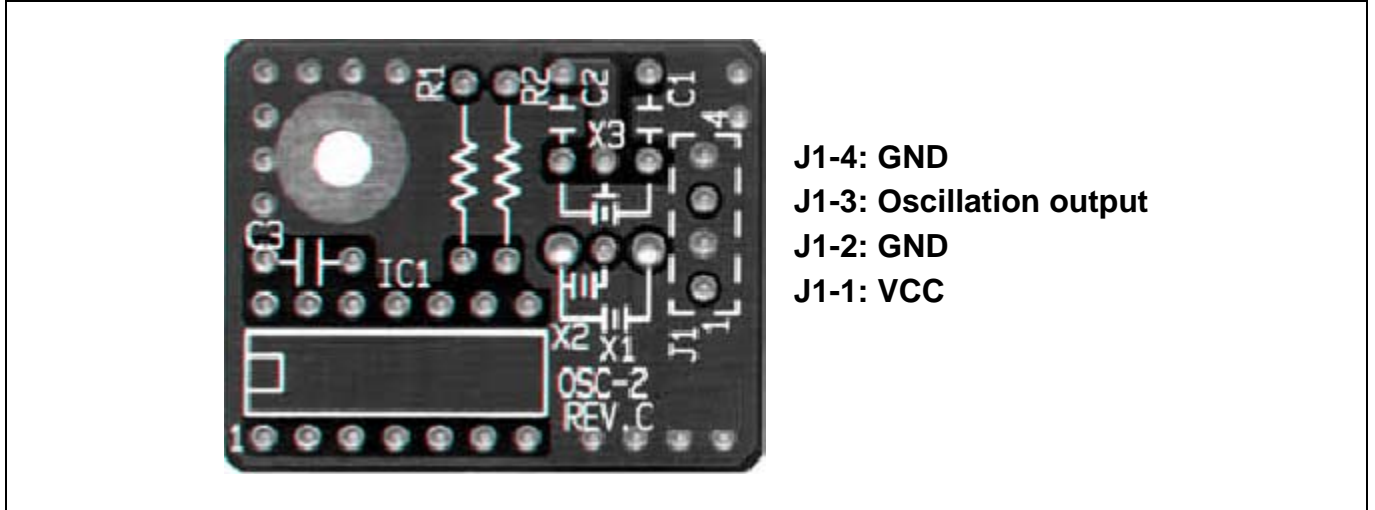

Figure 2.16 External view of the oscillator board OSC-2 (bare board) and connector pin assignments

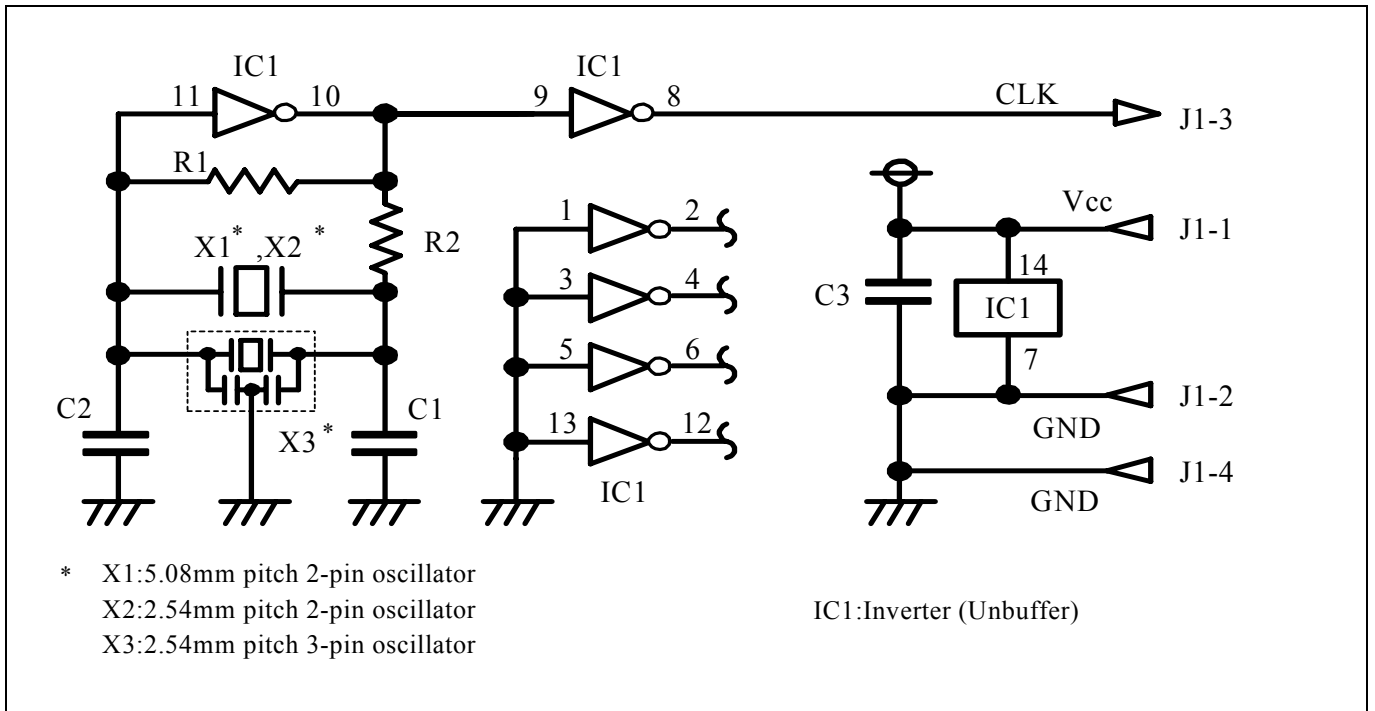

Figure 2.17 Circuit of the oscillator board OSC-2 (bare board)

2.11.3 Using the Oscillator Circuit on the User System

To operate this product with an oscillator circuit of the user system, input the oscillator output at 50% duty (within the operating range of the evaluation MCU) into pin X_{IN} as shown in Figure 2.18. Pin X_{OUT} should be open. Choose "External" in the emulator debugger to use this clock.

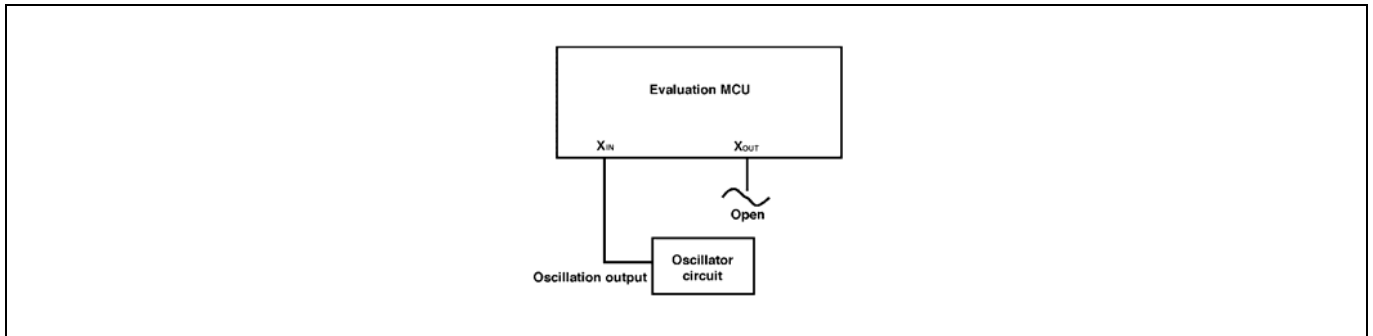

Figure 2.18 External oscillator circuit

In the oscillator circuit shown in Figure 2.19 where a resonator is connected between pins X_{IN} and X_{OUT} , oscillation does not occur because a package converter board is used between the evaluation MCU and the user system. It is same for X_{CIN} and X_{COUT} .

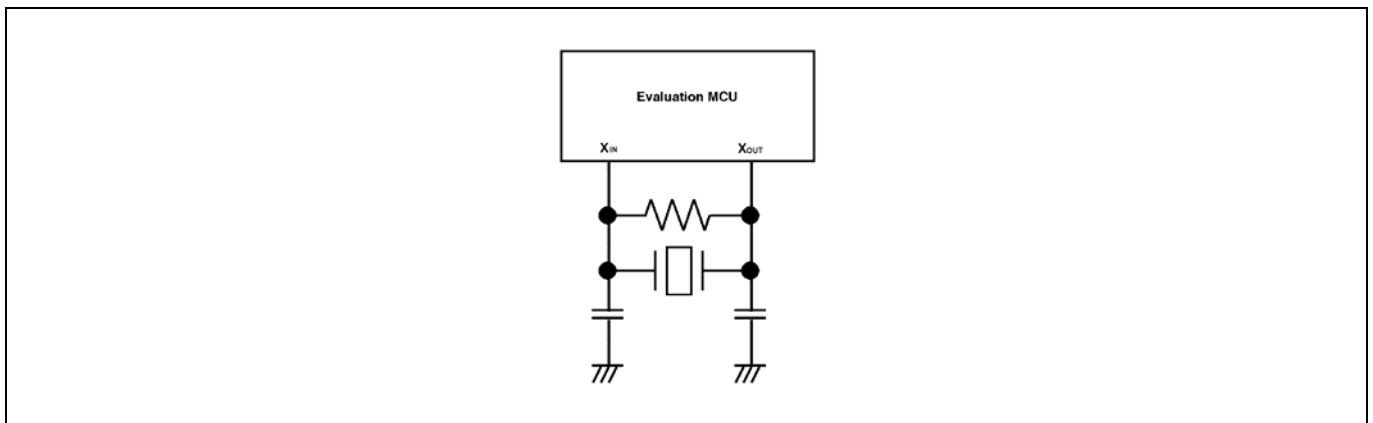

Figure 2.19 Circuit in which oscillation does not occur

2.11.4 Using the Internal Oscillator Circuit

The dedicated circuit in the PC7501 can generate any arbitrary frequency specified by the emulator debugger, and it is supplied as a main clock. It does not depend on either the oscillator circuit board in the PC7501 or the oscillator circuit on the user system. If you want to debug programs without the user system or change a frequency temporarily, you can check its operation before preparing an oscillator. If you want to use the internal oscillator circuit of the PC7501 as a main clock, choose "Generated" in the emulator debugger and specify a frequency you like to use for this clock supplied to an MCU.

Although you can change a frequency between 1.0 and 99.9 MHz by 0.1 MHz for the PC7501, do not specify a value exceeding the maximum input frequency of the X_{IN} of the MCU.

IMPORTANT

Notes on Internal Oscillator Circuit:

- The internal generator circuit is equipped for temporary debugging purposes. Temperature characteristics of frequencies are not guaranteed.
- Be sure to evaluate your system with an oscillator or oscillator module whose frequency is same as that of the internal oscillator circuit (internal clock) for final evaluation purposes.

3. Usage (Emulator Debugger)

This chapter describes how to start up the emulator debugger and how to use the major windows.

3.1 Starting Up the Emulator Debugger

When debugging the completed programs, switch the session. The session can be changed by the drop down list of the tool bar shown below.



You will have as many sessions created as the number of targets you selected when creating a project, so select the session that corresponds to the target to be connected from the drop-down list. To connect to the PC7501 and M16C/Tiny emulation probe, select "SessionM16C_R8C_PC7501_Emulator."

3.1.1 INIT Dialog Box

After specifying the session, an Init dialog box to connect the target is displayed. The Init dialog box is used to set the items that need to be set when the emulator debugger starts up. The contents set in this dialog box remain effective the next time you start the debugger.

When the tab settings of (1) to (4) are completed, click OK button.

(1) MCU tab

1. Specifying the MCU file

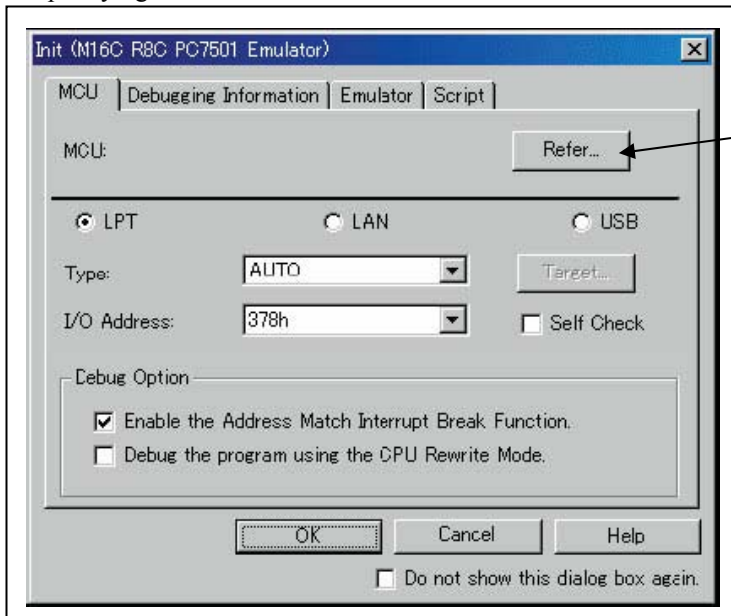

Specifying the MCU file

1. Click the "Refer..." button.
2. A file selection dialog box will be displayed, so select the desired MCU file.

- The MCU file contains the information specific to the target MCU.
- The MCU file you have selected is displayed in the MCU section of the MCU tab.

2. Specifying the communication interface

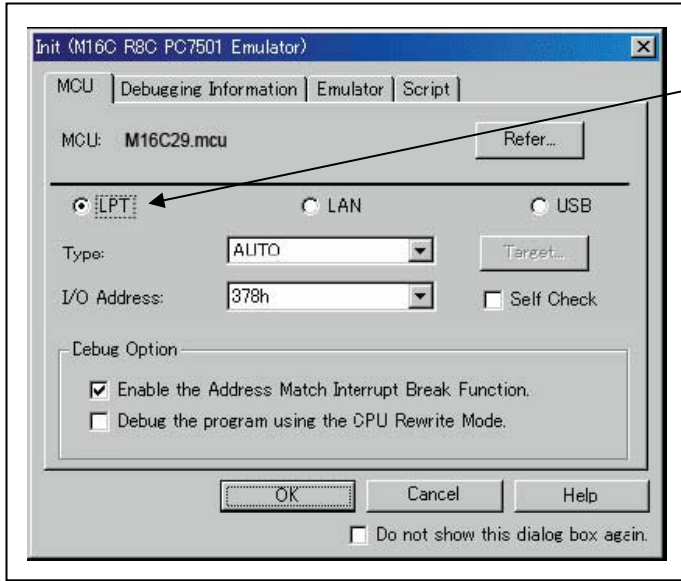

Specifying the communication interface (LPT communication)

- For selecting the LPT communication, click the radio button "LPT" of the MCU tab.
- For the Type area, specify the LPT interface communication mode to be used. **When you use the emulator debugger for the first time, select "AUTO"**.
- Specify the I/O address of the parallel port at the I/O address area.
- For BIOS setup, the following addresses are available.
 - 378h
 - 278h

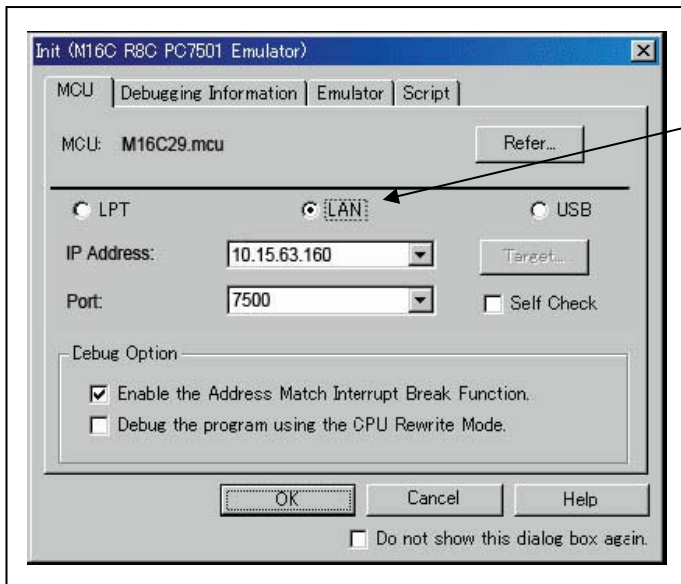

Specifying the communication interface (LAN communication)

- For selecting the LAN communication, click the radio button "LAN" of the MCU tab.
- Specify the IP address of the emulator at the IP address area.
- Specify the IP address by one byte of decimal number separating each four bytes with a period.
- Specify the port number at the Port area.

Note:
When you are using the LAN communication for the first time, connect the emulator through other than LAN communication interface and set the IP address, or use the SETIP utility included with your product to set the IP address.
For details about the SETIP utility, refer to the on-line manual of your emulator debugger.

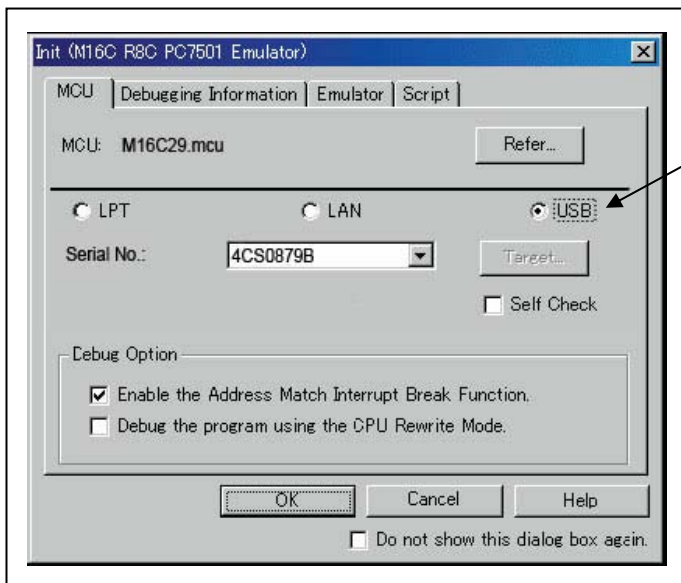

Specifying the communication interface (USB communication)

- For selecting the USB communication, click the radio button "USB" of the MCU tab
- The emulators connected by USB cable are shown at Serial No. area.
- Select the serial No. of the emulator you are going to connect.

Note:
When you are using USB communication for the first time, you must install the USB driver first.
The USB devices are detected when you turn on the power for the emulator, and a wizard for installing the corresponding device driver will automatically be started. Follow the instructions of the wizard to complete installation.

3. Executing the self-check

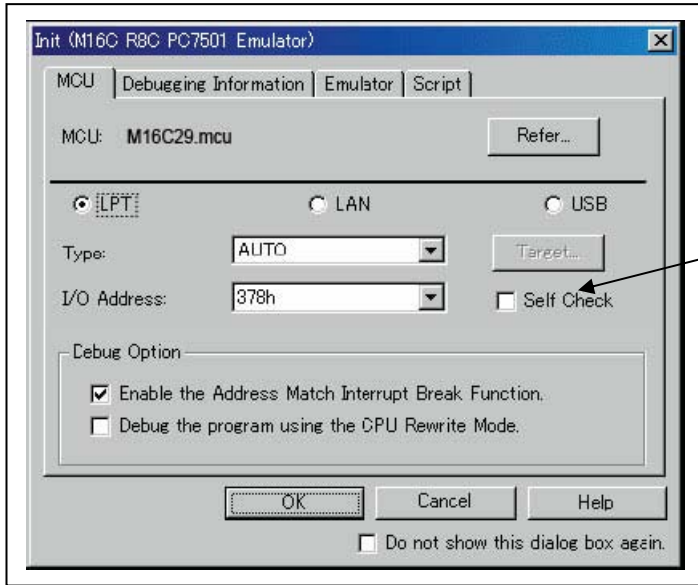

Executing the self-check

Enable this function when you want the emulator to be self-checked at startup. Be sure to select the check box only when you want the emulator to be self-checked at startup.

This function may be enabled in the following cases:

- When you are using the emulator you have just purchased
- When you successfully download the firmware, but fail to start up the emulator
- When you want to confirm whether the emulator is operating normally because, for example, the MCU runs out of control or something is wrong with the trace results

This function can be enabled only when you are starting up the emulator debugger.

4. Using or not using the address match break function

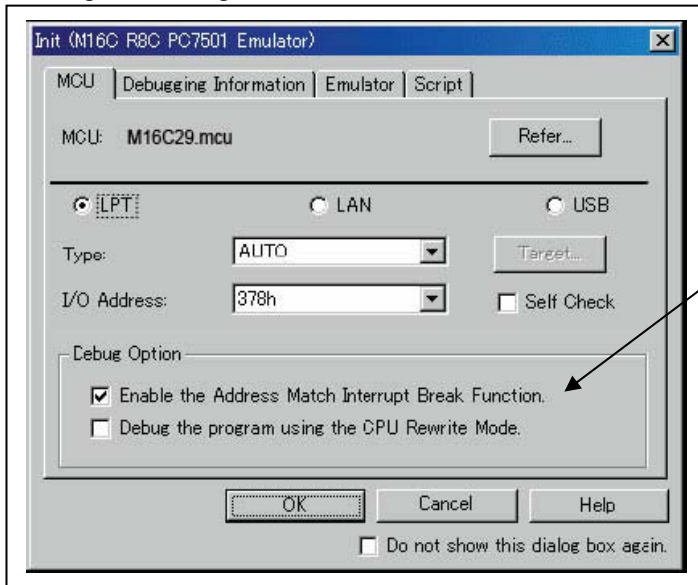

Using or not using the address match break function

Specify whether or not to use the address match break function.

- To use the address match break function (default), select the check box (marked by a check mark when selected). In this case, the address match interrupt is used by the emulator, and cannot be used in the user program.
- When not using the address match break function, deselect the check box (check mark cleared). In this case, the address match interrupt can be used in the user program.

This option can be selected or deselected only when you are starting up the emulator debugger.

5. Using or not using the CPU rewrite mode

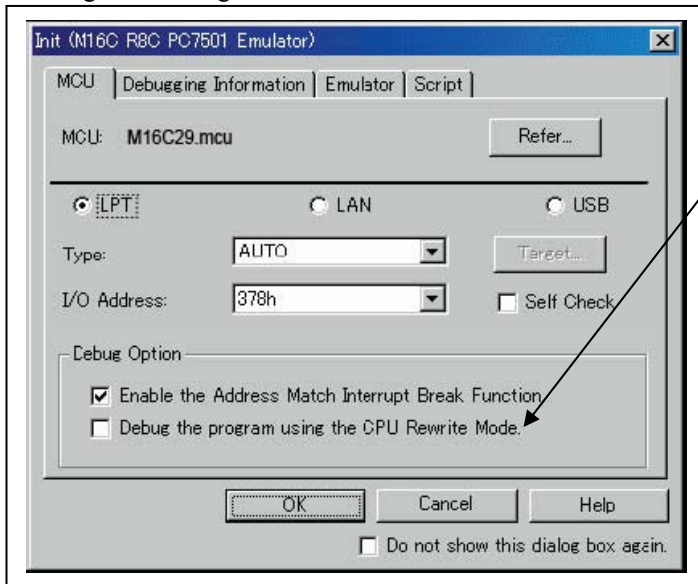

Using or not using the CPU rewrite mode

Specify whether or not to debug in CPU rewrite mode. To debug the user system that uses CPU rewrite mode, select the check box. This option can be selected or deselected only when you are starting up the emulator debugger.

Note:

When debugging in CPU rewrite mode is enabled, the following functions cannot be used while executing the user program:

- Software breakpoint setting in the internal ROM area
- Execution of COME in the internal ROM area

(2) Debugging Information tab

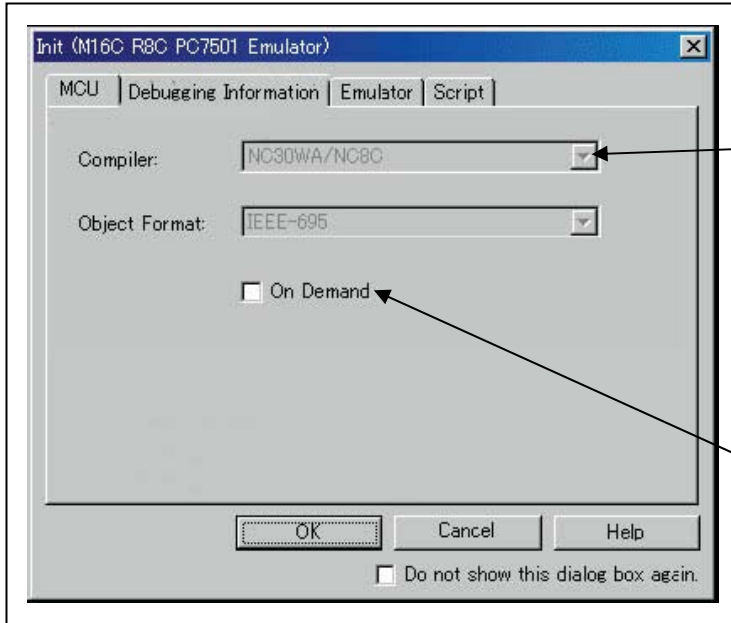

Specifying the compiler used and the object format

Specify the compiler you are using and the format of the object file output by the compiler.

- Compiler
Select the compiler you are using.
(By default, the C compiler from Renesas is selected.)
- Object Format
Select the format of the object file that is output by the compiler you are using.

Specifying the method for storing debug information

There are two methods for storing debug information: on-memory method and an on-demand method. Select method for storing debug information. (By default, the on memory is selected)

When selecting the on demand method, check the "On Demand" check box.

- On Memory
Debugging information is stored in the internal memory of your computer. This method is suitable when the load module (user program) size is small.
- On Demand
Debugging information is stored in a reusable temporary file on the hard disk of your computer.
Because the stored debugging information is reused, the next time you download the same load module it can be downloaded at high speed. This method is suitable when the load module (user program) size is large.

(3) Emulator tab

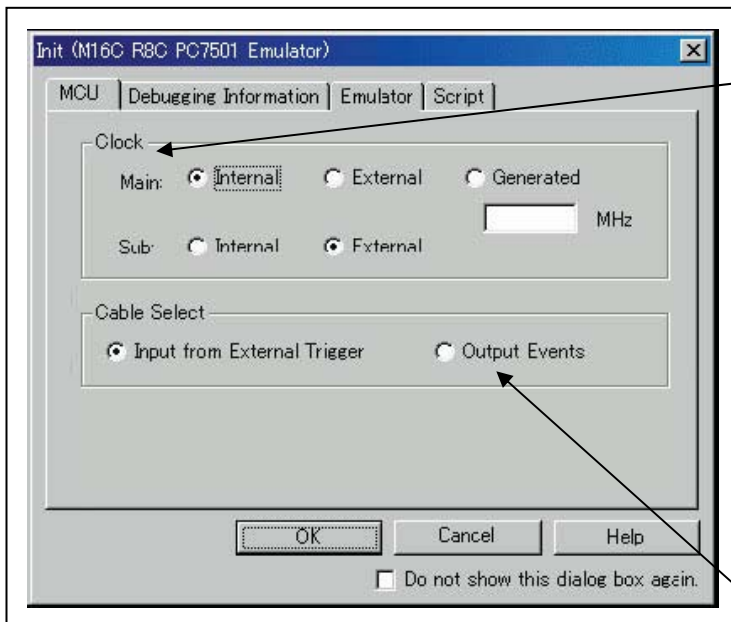

Specifying the target clock

Specify the clock sources supplied to the MCU (main clock and sub clock). Select the appropriate clock sources according to the clock used by your target MCU.

- Internal (default)
EmulatorPC7501's internal clock
- External
User system clock
- Generated
Clock created in PC7501

The option you have specified here remains effective the next time you start up.

Selecting the event output/trigger input cable

Select input/output of the event output/trigger input cable of the PC7501.

- Input from External Trigger (default)
Inputs the external trigger from the cable
- Output Events
Outputs events from the cable

"Input from External Trigger" is set at startup (the previous setting becomes null).

(4) Script tab

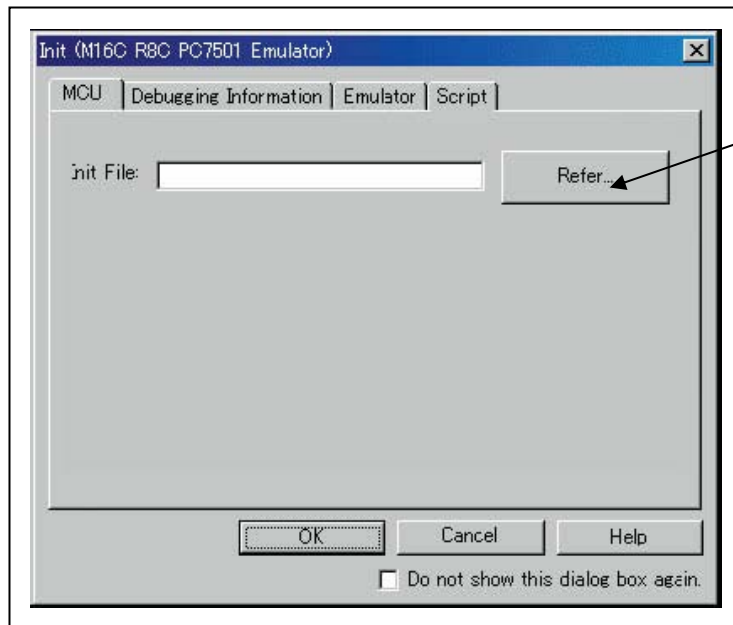
**Automatically executing a script command**

To automatically execute a script command when starting up the debugger, click the “Refer...” button and specify the script file to be executed.

Clicking the “Refer...” button brings up a file selection dialog box. The script file you have selected is displayed in the Init File: section of the dialog box shown here. If you do not want to automatically execute a script command, delete the character string displayed in the Init File: section of the dialog box.

What you specify here is reflected at only startup. If you specify back again in the Init dialog box after startup, whatever you specified has no effect. (Be sure to restart the emulator debugger.)

3.1.2 MCU Setting Dialog Box

MCU setting dialog box sets the information of the user system. It will be displayed after closing the Init dialog box. When the tab settings of (1) to (3) have been finished, click "OK".

(1) MCU tab

1. MCU setting

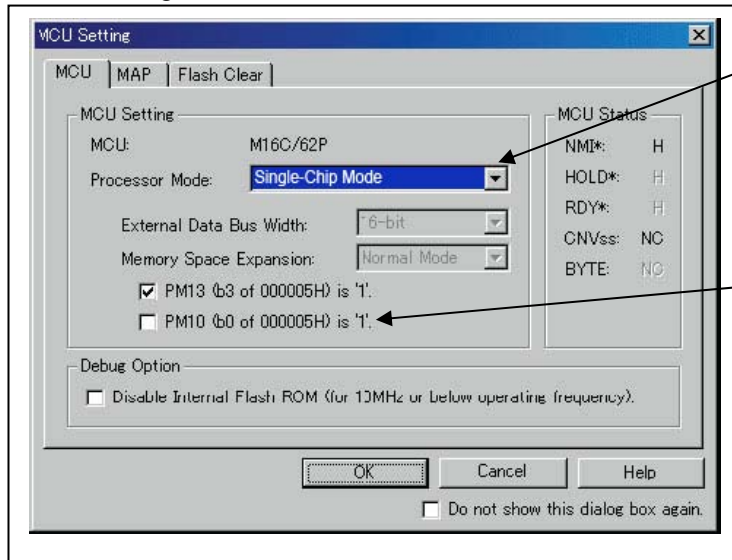

Specifying the processor mode

Select the appropriate processor mode that suits your system. For this product, you can specify only the following processor mode:

- Single-Chip Mode

Specifying the PM10 area (bit 0 of the address 00005h)

Select this option when using the MCU in which the data area access enable bit (PM10) is set to 1.

IMPORTANT

Notes on Selecting a Processor Mode:

- When the user system is connected, the level of pin CNVss of the MCU status should be "L". The MCU status shows the pin level of the user system.

2. Option

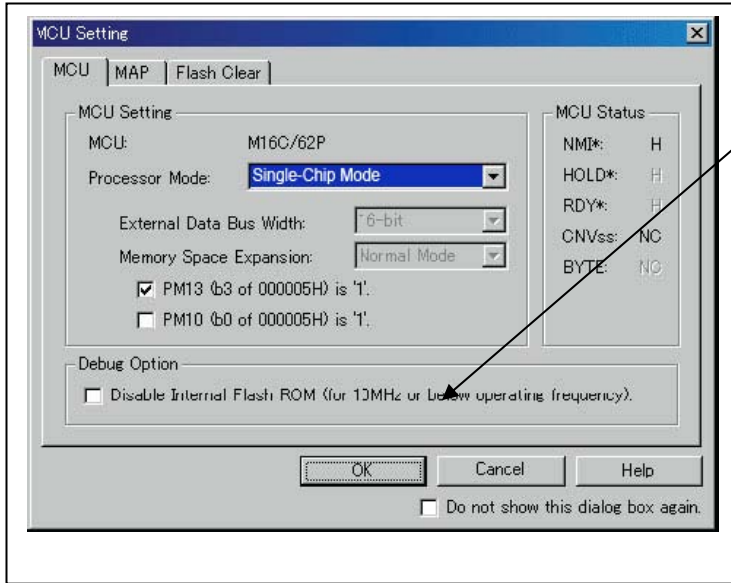

Setting the debug options
Specify whether you want to use the internal flash ROM or the MCU or not.
Check the box when not downloading the program to the internal flash ROM of the MCU. Initially, this option is deselected. If this box is checked, the number of write/erase cycles of the internal flash ROM will be unlimited, and working efficiency (downloading, software break, etc.) will be improved because the program is downloaded in the emulation memory in the PC7501. However, maximum operating frequency is 10MHz.

3. MCU Status

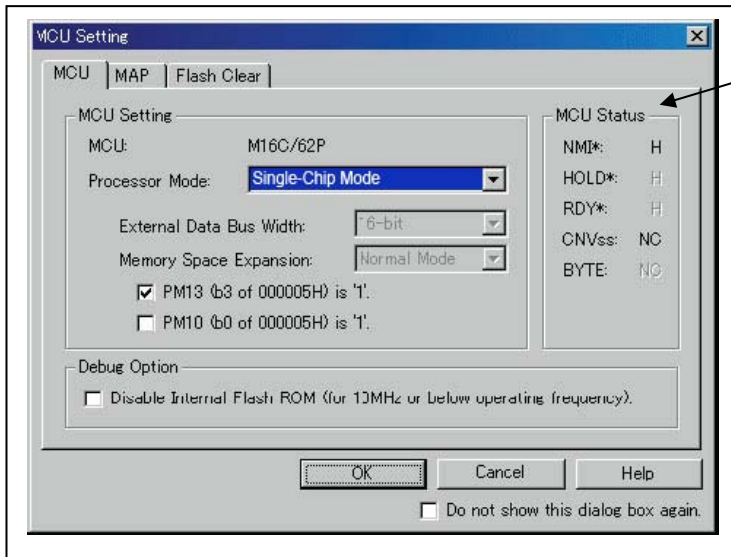

Referring to the MCU Status
It shows the pin status of the user system.
If the status of any pin is marked "NC", it means that the pin status is indeterminate.

(2) MAP tab

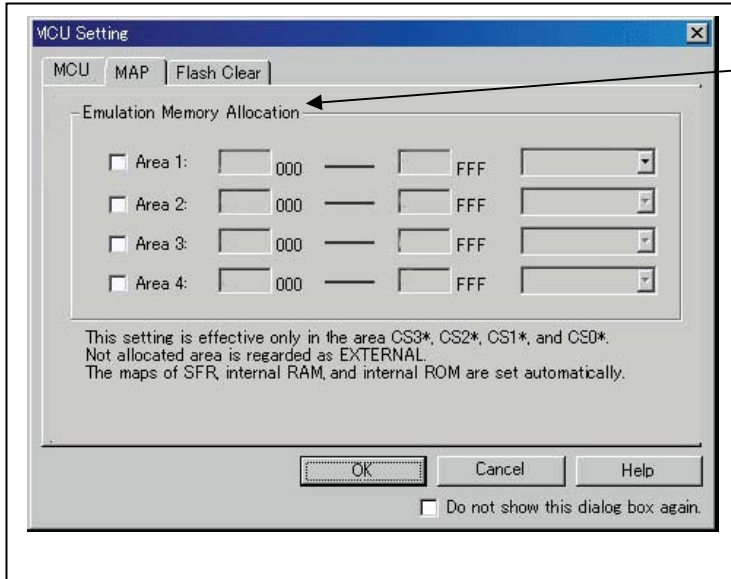

Emulation Memory Allocation as Expansion Area
 With this product, setting of the MAP tab is not required.

(3) Flash Clear tab

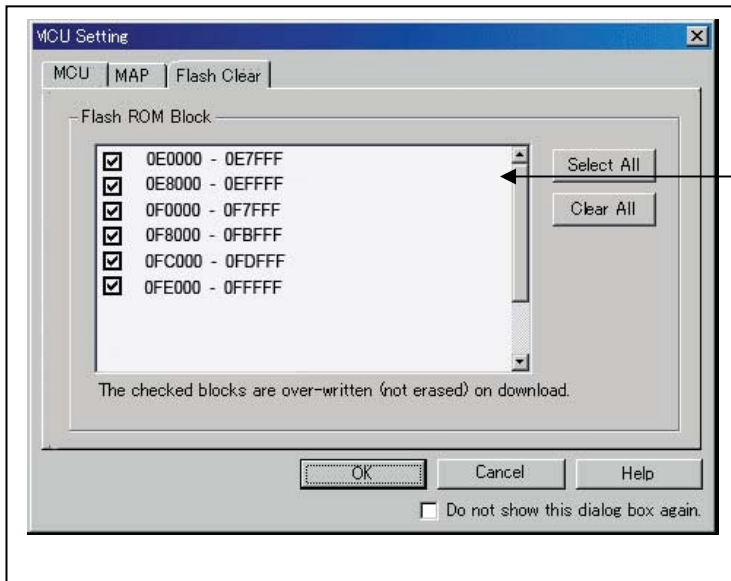

Setting to clear the MCU's internal flash ROM
 Specify whether or not you want the MCU's internal flash ROM to be cleared when downloading the user program or data. (When cleared, the content of the flash ROM is initialized to 0xFF.) The MCU's internal flash ROM is listed in block units.

- Any block which has had its check box selected is not cleared when downloading. The memory content of this block remains intact unless overwritten by downloading.
- Any block which has had its check box deselected is cleared when downloading.
- Click the Select All button, and all blocks will be selected (marked by a check mark, so that none of the blocks is cleared when downloading).
- Click the Clear All button, and all blocks will be deselected (check marks removed, so that all of them are cleared when downloading).

The option you have specified here remains effective the next time you start up.

3.1.3 Checking Connections of the Emulator System

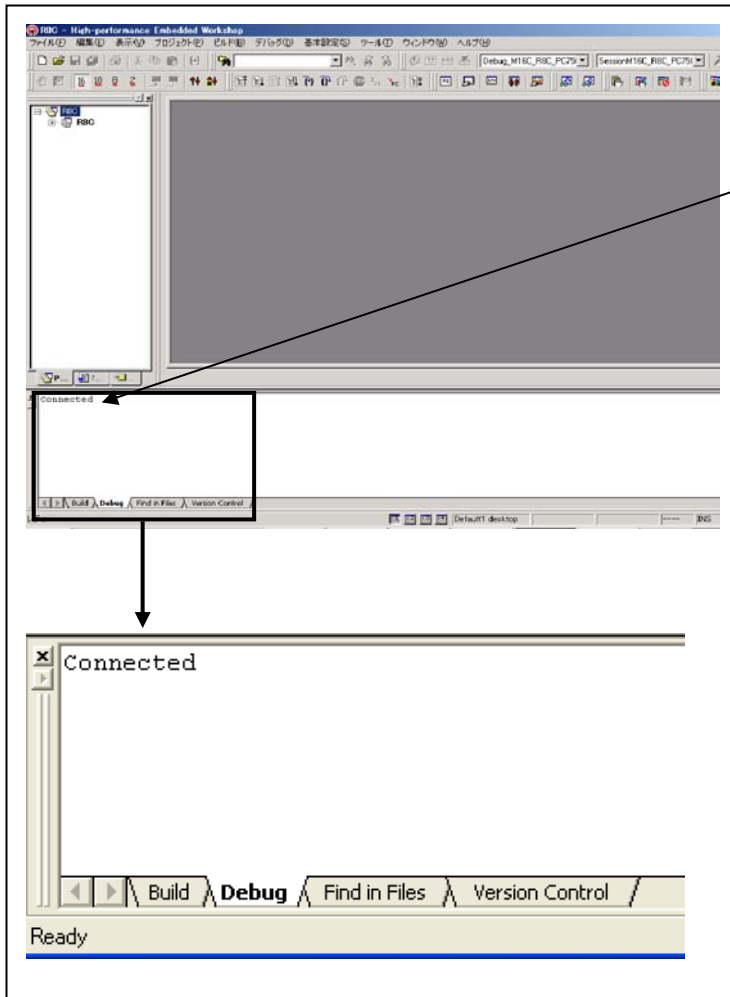

Checking connections of the emulator system

When the emulator debugger is connected correctly to the emulator after you have finished setting up the Init dialog box and the MCU Setting dialog box, you will see a message "Connected" displayed on the "Debug" tab of the Output window.

3.2 Program Window

(1) Downloading the program

1. Downloading from the work space window

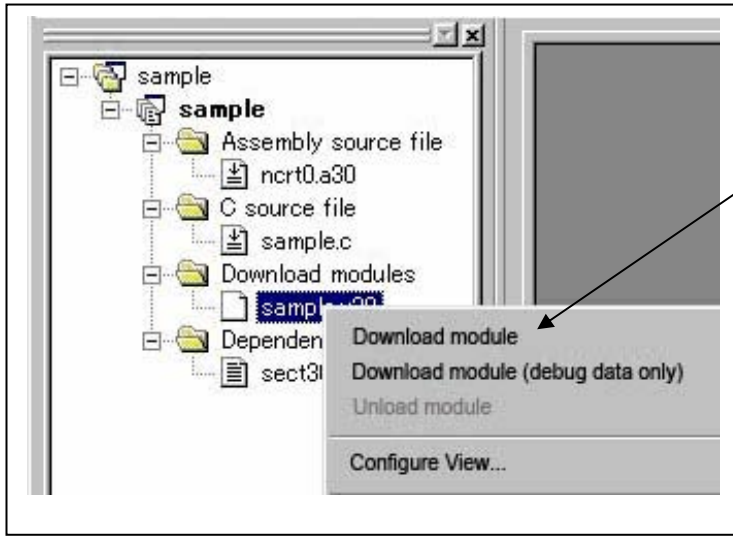

Downloading the program
 Download the object program you want to debug.
 Select Download from "xxx.x30" of "Download module".
 Or you can select "Download module" from the "Debug" menu for the same effect.

2. Showing the source program

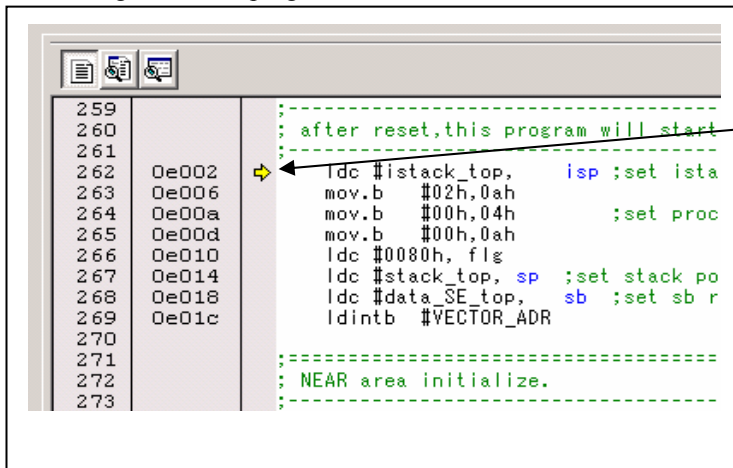

Editor (source) window
 The editor (source) window is a window that always shows the content of the source file corresponding to the current position of the program counter (hereafter, PC).
 The PC position is identified by the yellow background color. Here, you can execute the program up to the cursor position, and set or clear software breakpoints.
 Because the present emulator uses the MCU's internal flash ROM, the initial value for the ROM area data at the time of purchase is "FFh."

(2) Program execution

1 Resetting the user program

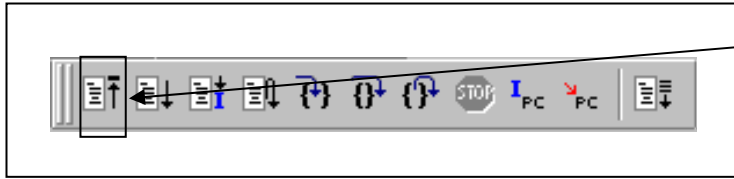

CPU reset
Resets the target MCU.
Or you can select "CPU Reset" from "Debug" menu for the same effect.

2 Executing the user program (Go)

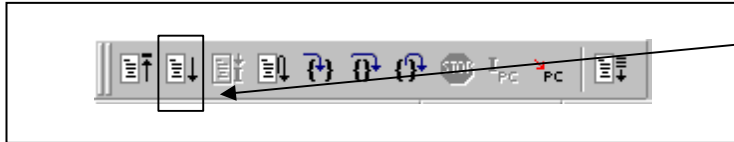

Go
Runs the program beginning with the current PC position.
Or you can select "Go" from "Debug" menu for the same effect.

3 Executing the user program (Go Free)

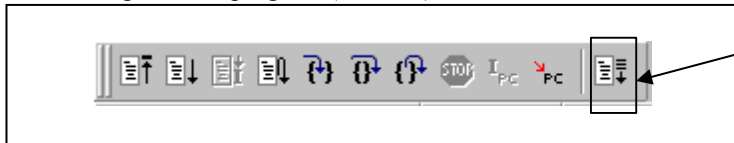

Go Free
Runs the program beginning with the current PC position.
The software and hardware breaks set in it are ignored.

4 Executing the user program (Reset Go)

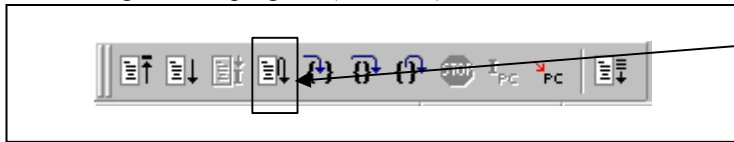

Reset Go
Runs the program after reset.
Or you can select "Reset Go" from "Debug" menu for the same effect.

5 Step execution of the user program

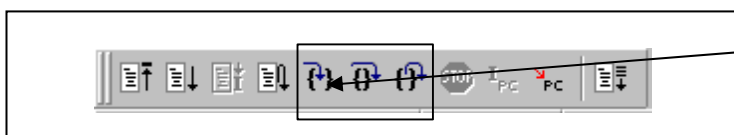

Step In
Single-steps the program executing each statement (including those in functions).

Step Over
Single-steps the program executing each function call as one step.

Step Out
Exits a function and stops at a statement in the program next to the one that called the function.
Or you can select "Step Out" or other corresponding commands from "Debug" menu for the same effect.

6 Stopping the user program

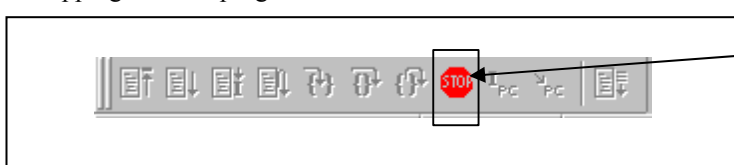

STOP
Stops the program.
Or you can select "Stop" from "Debug" menu for the same effect.

7 Editor (Source) window after you have stopped the user program

```

F0118 6A09          JEQ     F0122H
F011A 75A1          LDE.W  [A1A0],R1
F011C B2            INC.W  A0
F011D B2            INC.W  A0
F011E C923          ADD.W  #2H,R3
F0120 FEF3          JMP.B  F0114H
F0122 F3            RTS
F0123 D902          MOV.W  #0H,R2
F0125 77820F00     CMP.W  #000FH,R2
    
```

Editor (Source) window
The position at which the user program has stopped is marked by a yellow arrow.

(3) Setting breakpoints

1. Screen after breakpoint setup

```

63      N_BZERO .macro TOP_,SECT_
64      mov.b   #00H,R0I
65      f003a   mov.w   #(TOP_ & 0FFFFH),A1
66      f003d   mov.w   #sizeof SECT_,R3
67      f0041   sstr.b
68      .endm
69
70      N_BCOPY .macro FROM_,TO_,SECT_
71      mov.w   #(FROM_ & 0FFFFH),A0
72      f0061   mov.b   #(FROM_ >>16),R1H
73      f0064   mov.w   #TO_,A1
74      f0067   mov.w   #sizeof SECT_,R3
75      f006a   smovf.b
76      f006e   .endm
77
78      BZERO .macro TOP_,SECT_
79      f009d   push.w  #sizeof SECT_ >> 16
80      f00a1   push.w  #sizeof SECT_ & 0ffffh
81      f00a5   pusha   TOP_ >>16
82      f00a9   pusha   TOP_ & 0ffffh
83

```

Breakpoint setup screen

There are three types of breakpoints as described below.

- Address match breakpoint (A)

This breakpoint can be set only when you check "Enable the Address Match Interrupt Break Function." on the MCU tab of the Init dialog box.

A breakpoint can be set or cleared by double-clicking in the address match breakpoint display area in the editor (source) window. (A blue circle is displayed at the setting line)

Up to six breakpoints can be set.

The address match break causes the program to stop before executing the address at which a breakpoint is set.
- Software breakpoint

A software breakpoint can be set or cleared by double-clicking the software breakpoint display area in the editor (source) window (A red circle is displayed at the setting line).

This is rewritten to a break instruction, therefore, because of rewriting flash ROM, program execution starts with a delay of several seconds after setting ROM area.

If the breakpoint you set is a software breakpoint, the program stops before executing the instruction at the set breakpoint.
- Hardware breakpoint

A hardware breakpoint can be set or cleared by right-clicking the breakpoint display area.

If the breakpoint you set is a hardware breakpoint, the program stops after executing the instruction at the set breakpoint (after several cycles).

(4) Executing up to the cursor position (Come command)

1. Specifying the Come command

```

60
61
62 ;-----:
63 ; Initialize Macro declaration
64 ;-----:
64 f0039 N_BZERO .macro TOP_,SECT_
65 f003a     mov.b  #00H, R0L
66 f003d     mov.w  #(TOP_ & 0FFFFH), A1
67 f0041     mov.w  #sizeof SECT_ , R3
68           sstr.b
69           .endm
70
71 N_BCOPY .macro FROM_,TO_,SECT_
72 f0061     mov.w  #(FROM_ & 0FFFFH),A0
73 f0064     mov.b  #(FROM_ >>16),R1H
74 f0067     mov.w  #TO_ ,A1
75 f006a     mov.w  #sizeof SECT_ , R3
76 f006e     smovf.b
77           .endm
    
```

Setup procedure for executing COME command

- (1) Click the line in the program display area at which you want the program to execute.
- (2)  Click the Come button.

2. After the Come command has finished

```

60
61
62 ;-----:
63 ; Initialize Macro declaration
64 ;-----:
64 f0039 N_BZERO .macro TOP_,SECT_
65 f003a     mov.b  #00H, R0L
66 f003d     mov.w  #(TOP_ & 0FFFFH), A1
67 f0041     mov.w  #sizeof SECT_ , R3
68           sstr.b
69           .endm
70
71 N_BCOPY .macro FROM_,TO_,SECT_
72 f0061     mov.w  #(FROM_ & 0FFFFH),A0
73 f0064     mov.b  #(FROM_ >>16),R1H
74 f0067     mov.w  #TO_ ,A1
75 f006a     mov.w  #sizeof SECT_ , R3
76 f006e     smovf.b
77           .endm
    
```

The cursor stops in the position where the come command was executed.
 The statement specified with the come command is not executed.

3.3 Hardware Breakpoint Setting Window

(1) Breakpoint setup dialog box

1. Opening the hardware breakpoint setup dialog box



Hardware Break Point
 Clicking this button opens the hardware breakpoint setup dialog box.

2. Hardware Break Point Setting Window in initial state

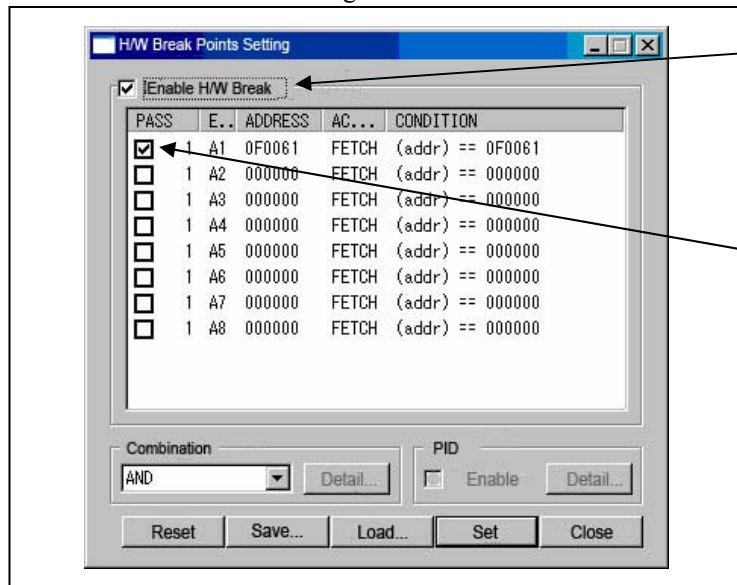

H/W Break Points Setting Window in initial state
 Select the "Enable H/W Break" check box, and this break function will be enabled, allowing you to set hardware breakpoints.

Setting Break Event
 Click the event line at which you want set a break event.

3. Opening the break event setting dialog box

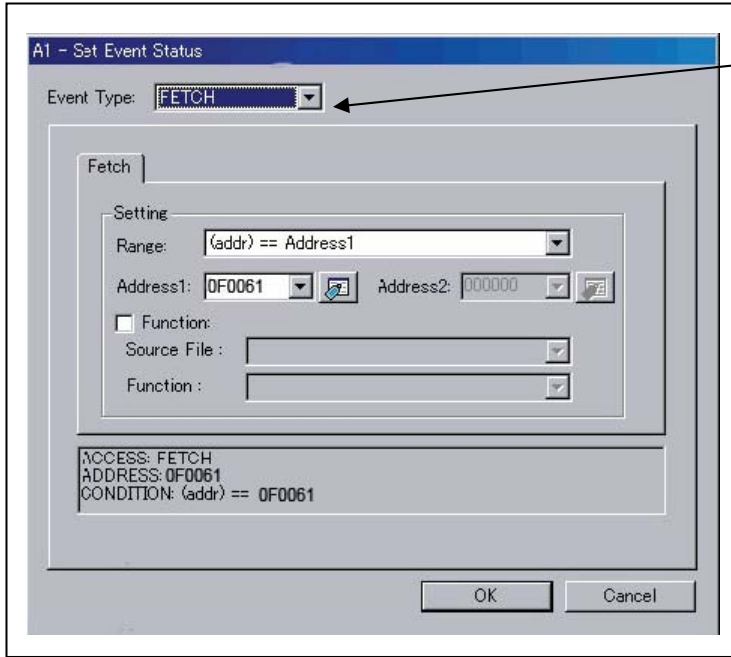

Specifying the event type

Select the event type that you want to set from the drop-down list.

- FETCH
Detects an instruction prefetch.
- DATA ACCESS
Detects a memory access.
- BIT SYMBOL
Detects a bit access.
- INTERRUPT
Detects an interrupt occurrence or interrupt termination.
- TRIGGER
Detects a signal from the external trace signal input cable.

(2) When FETCH is selected

1. Window for setting addresses

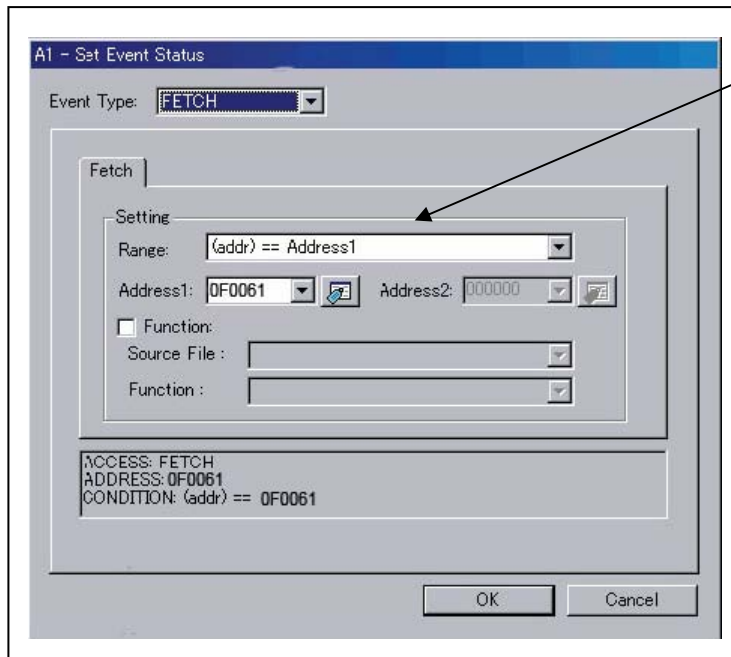

Setting the address

You can set eight conditions, e.g., a specified address, a specified address range, etc. When you have finished setting the address, click OK.

(3) When DATA ACCESS is selected

1. Window for setting the address

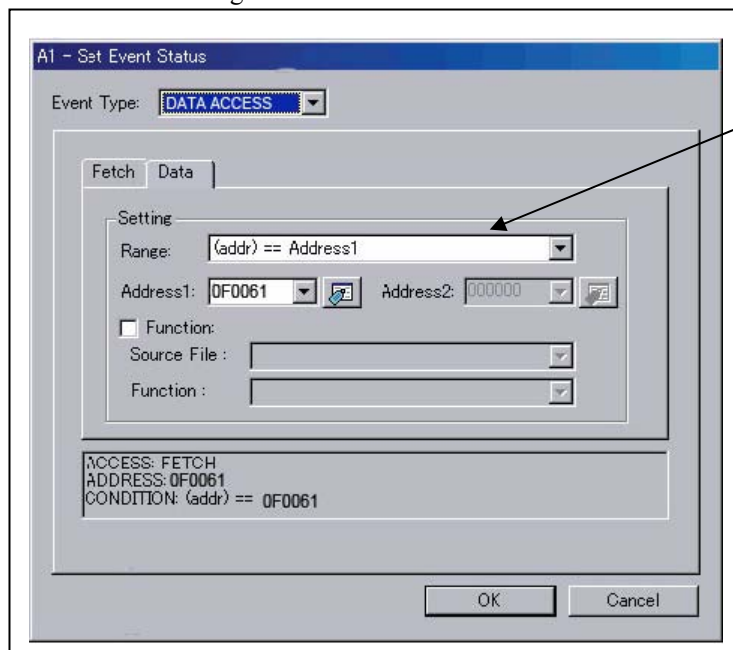
**Setting the address**

You can set eight conditions, e.g., a specified address, a specified address range, etc.

2. Window for setting data

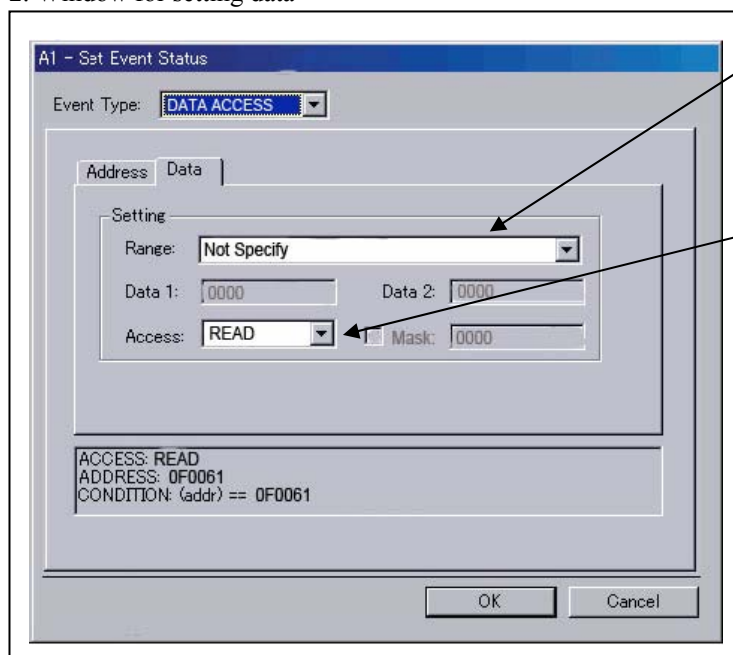
**Setting data**

You can set eight conditions, e.g., a specified data, a specified data range, etc.

Setting the access condition

You can set three conditions, e.g., read, write, and read/write. When you have finished setting the data and access condition, click OK.

3. Example Data Settings

Event setting for even-address word access

STE.W A0,20E8h(A0=5423h)

Cycle	Label	Address	Data	BUS	BHE	BIU	R/W	RWT	CPU
-00023		0020E8	5423 16b	0	DW	W	0	CW	

High-order and low-order data effective

Event setting for odd-address word access

STE.W A0,20E5h(A0=AB79h)

Cycle	Label	Address	Data	BUS	BHE	BIU	R/W	RWT	CPU
-00021		0020E5	79AB 16b	0	DW	W	0	CB	
-00020		0020E6	79AB 16b	1	DW	W	0	CB	

Odd-address high-order data effective

Even-address low-order data effective

Event setting for even-address byte access

STE.B R0L,[A1A0](R0L=E5h,A1=0000h,A0=20E2h)

Cycle	Label	Address	Data	BUS	BHE	BIU	R/W	RWT	CPU
-00022		0020E2	00E5 16b	1	DB	W	0	CB	

Low-order data effective

Event setting for odd-address byte access

STE.B R0L,[A1A0](R0L=E6h,A1=0000h,A0=20E3h)

Cycle	Label	Address	Data	BUS	BHE	BIU	R/W	RWT	CPU
-00022		0020E3	E800 16b	0	DB	W	0	CB	

High-order data effective

Setting a break event

A1

Address 1 : 0020E8

Data 1 : 5423

MASK : FFFF

Access : WRITE

Setting a break event (using 2 events)

A1

A2

Address 1 : 0020E5 Address 1 : 0020E6

Data 1 : 7900 Data 1 : 00AB

MASK : FF00 MASK : 00FF

Access : WRITE Access : WRITE

Set the combinatorial events to AND.

Setting a break event

A1

Address 1 : 0020E2

Data 1 : 00E5

MASK : 00FF

Access : WRITE

Setting a break event

A1

Address 1 : 0020E3

Data 1 : E600

MASK : FF00

Access : WRITE

(4) Setting the combinatorial event condition

1. Window for setting the combinatorial event condition

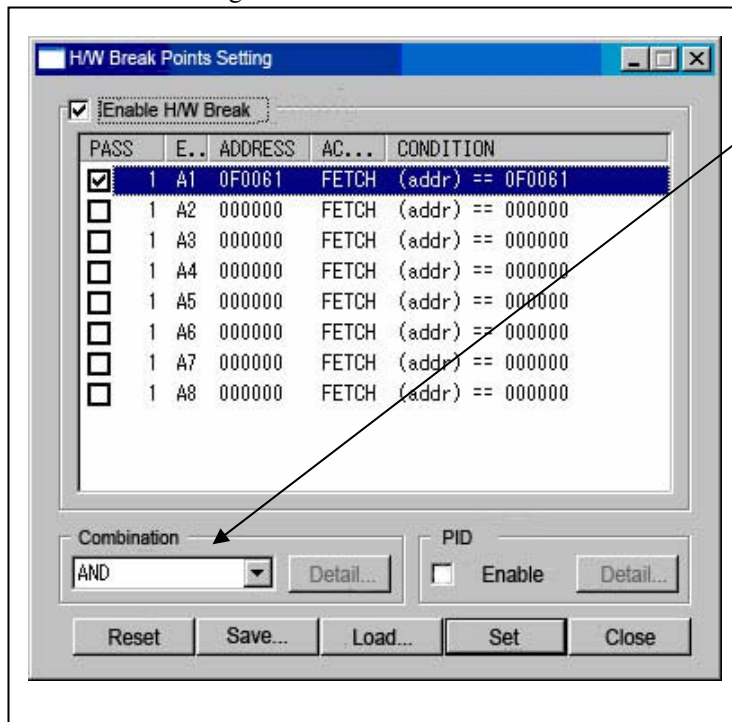
Setting the combinatorial event condition

There are following four conditions that you can choose for the combinatorial events.

- AND

The program breaks when all of the specified events occur.

- AND (Same Time)

The program breaks when the specified events occur at the same time.

- OR

The program breaks when one of the specified events occurs.

- STATE TRANSITION

The program breaks when the state transition diagram goes into the break state.

For each event, a pass count (number of passing) is specifiable (1--255). When "AND (same time)" is specified for Combination, you can not specify the pass count (fixed to one).

When you have finished setting the combinatorial event condition, click the "Set" button.

3.4 Trace Window

The Trace Window is used to display the results of real-time trace measurement.

(1) Trace window

1. Opening the trace window

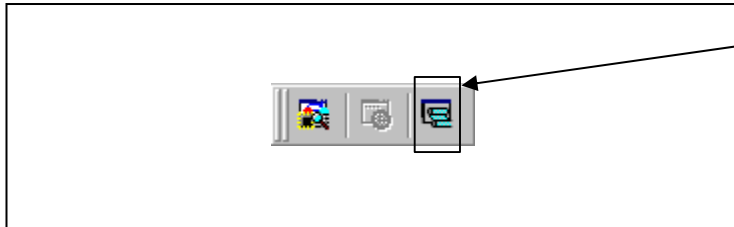

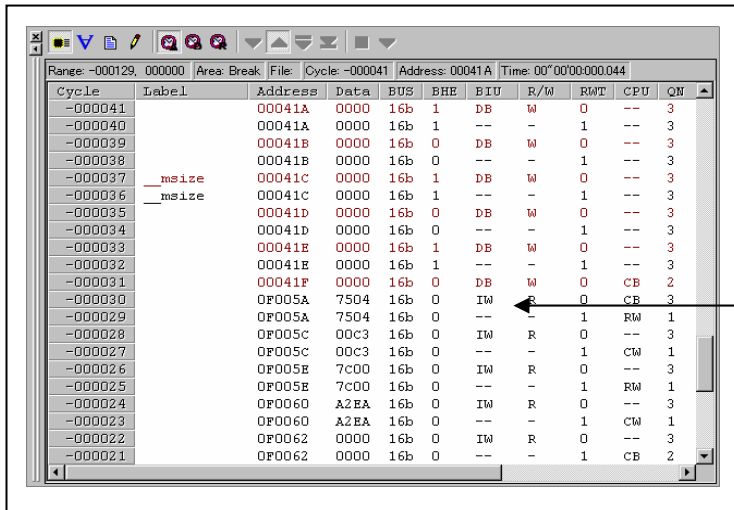

Trace window
 Clicking this button opens the trace window.
 Or you can select "Trace" from "Trace" of "Display" menu for the same effect.

2. Trace window



Trace window
 The trace window is used to show the results of real-time trace measurements. It has the following three display modes:

- Bus mode 

Bus information per cycle can be inspected. The contents are displayed in order of execution paths.
- Disassemble mode 

The execution paths of the executed instructions can be inspected. The contents are displayed in order of execution paths.
- Source mode 

The execution paths of the source program can be inspected. Operating buttons of the tool bar can reference the execution paths.

The trace window shows the measurement result when a real-time trace measurement has finished. The trace window remains blank until the real-time trace measurement in progress finishes.

3. Trace window (bus display)

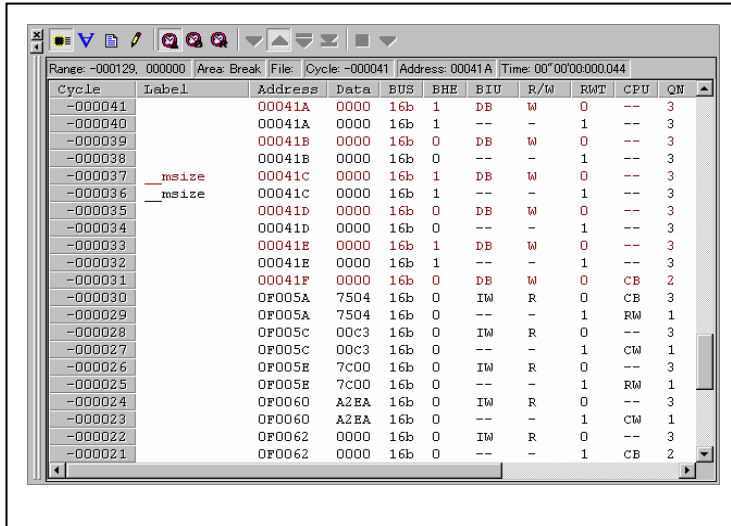

Explanation of the trace window (bus display)

The following explains the displayed contents, from left to right.

- Cycle
Shows trace cycles. Double-click here to bring up a dialog box to change the displayed cycle.
- Label
Shows labels corresponding to address bus information. Double-click here to bring up a dialog box to search for addresses.
- Address
Shows the status of the address bus.
- Data
Shows the status of the data bus.
- BUS
Shows the width of the external data bus. In the present emulator, only "16b" for 16 bits wide bus is displayed.
- BHE
Shows the status (0 or 1) of the BHE (Byte High Enable) signal. If this signal = 0, the odd-address data is valid.
- BIU
Shows the status between the BIU (Bus Interface Unit) and memory or I/O.
Symbol Status
 - Non-active
 - DMA Data access by other than the CPU, e.g., by DMA
 - INT Starts INTACK sequence
 - IB Instruction code read by the CPU (in bytes)
 - DB Data access by the CPU (in bytes)
 - IW Instruction code read by the CPU (in words)
 - DW Data access by the CPU (in words)
- R/W
Shows the status of the data bus.
Displayed as "R" for Read, "W" for Write, and "--" for no access.
- RWT
This is the signal to indicate a valid bus cycle. When valid, RWT = 0. The Address, Data, and the BIU signals are effective when this signal is 0.
- CPU
Shows the status between the CPU and BIU (Bus Interface Unit).
Symbol Status
 - CB Op-code read (in bytes)
 - RB Operand read (in bytes)
 - QC Instruction queue buffer clear
 - CW Op-code read (in words)
 - RW Operand read (in words)
- QN
Shows the byte count stored in the instruction queue buffer. The display range is 0 to 4.
- 76543210
Shows the level of external trace signal input cable EXTIN0 to EXTIN7.
- h' m' s: ms. us
Shows the elapsed time after starting the user program.

4. Trace window (disassemble display)

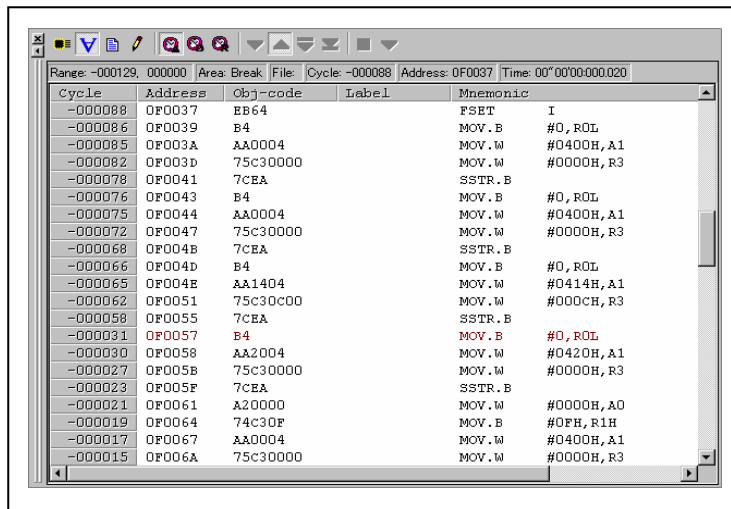

5. Trace window (source display)

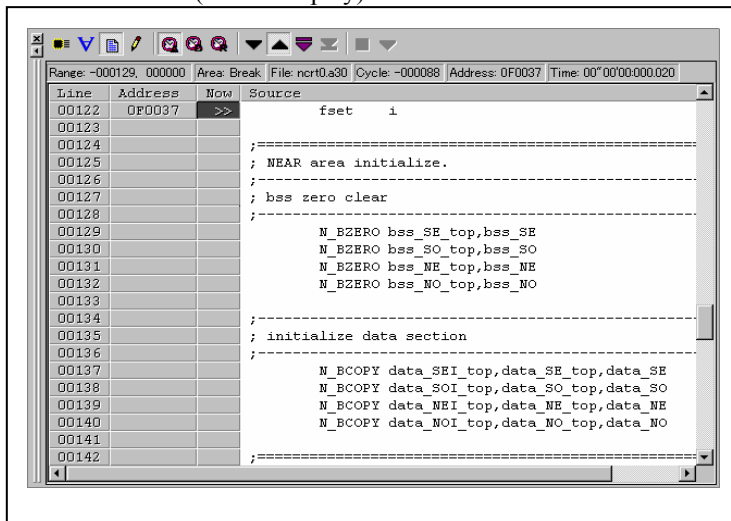

(2) Suspending and resuming trace measurement

1. Suspending trace measurement

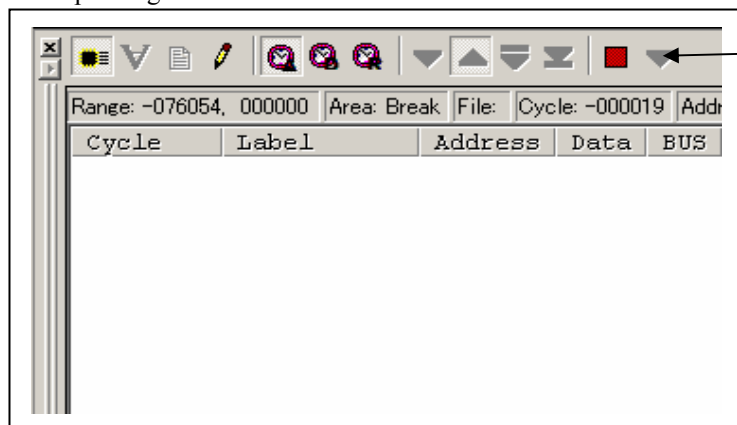

Stop
Click this toolbar button to suspend the trace measurement in progress.

2. Resuming trace measurement

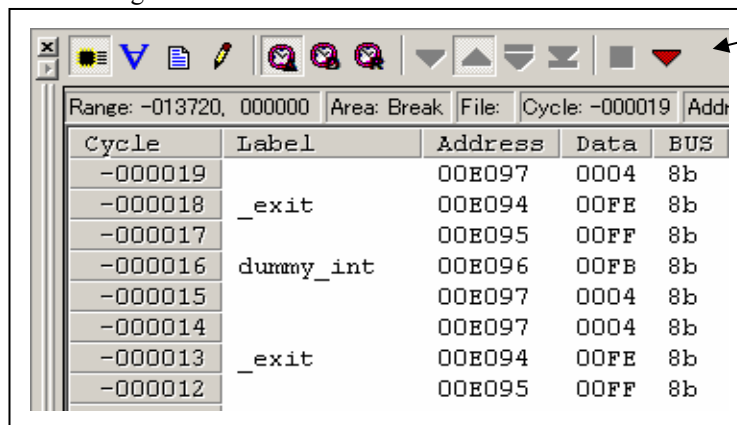

Re-Start
Click this toolbar button to resume the trace measurement in progress.

(3) Trace point setup dialog box

1. Opening the trace point setup dialog box



Trace Point
Clicking this toolbar button opens the trace point setting window.

2. Trace Point Setting Window in initial state

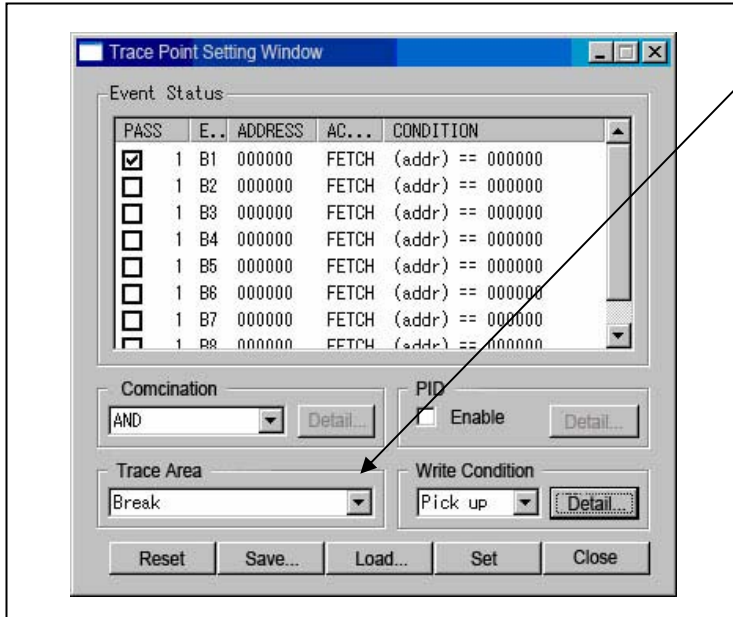

Trace Point Setting Window in initial state

You can set events in the same way as for the hardware breakpoints.

Specifying a trace range

You can specify a trace range for the trace event.

- Break
256K cycles of instruction execution before the user program stopped is recorded.
- Before
256K cycles of instruction execution before a trace point condition was met is recorded.
- About
128K cycles of instruction execution before and after a trace point condition was met is recorded.
- After
256K cycles of instruction execution after a trace point condition was met is recorded.
- Full
256K cycles of instruction execution after a trace began is recorded.

3. Specifying a trace range

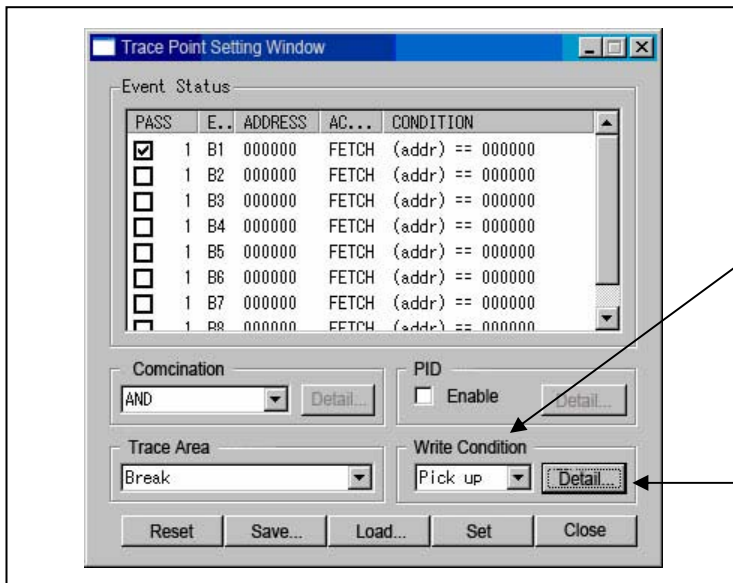

Setting the trace write condition

You can specify a condition for the cycles to be written into the trace memory.

- Total
All cycles are written into memory.
- Pick up
Only the cycles in which the specified condition was met are written into memory.
- Exclude
Only the cycles in which the specified condition was not met are written into memory.

When you have finished setting the trace write condition, click this button. The Realtime-trace Write Condition dialog box shown below will appear.

4. Setting the trace write condition

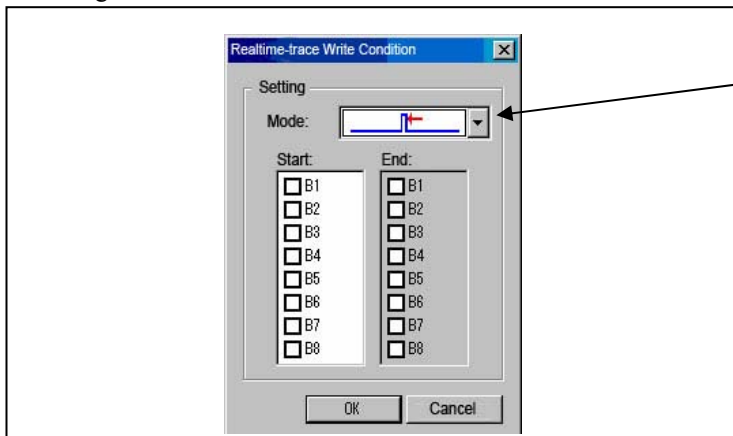

Write mode



Only the cycle in which the specified Start event occurred



A range of cycles from when the specified Start event occurred to when the specified Start event became nonexistent



A range of cycles from when the specified Start event occurred to when the specified End event occurred

3.5 RAM Monitor Window

This function allows you to inspect changes of memory contents without impairing the realtime capability of target program execution. The PC7501 emulator system has 4 Kbytes of RAM monitor area which can be located in any contiguous address location or in 16 separate blocks comprised of 256 bytes each.

(1) RAM monitor window

1. Opening the RAM monitor window



RAM monitor
Clicking this button opens the RAM monitor window.

2. RAM monitor window

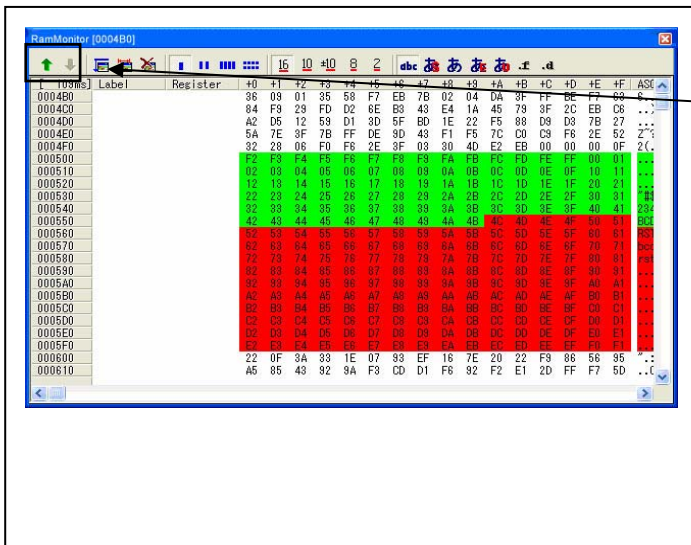

This window shows changes of memory contents while the user program is executed. This is accomplished by using the real-time RAM monitor function, and the memory contents corresponding to the RAM monitor area are displayed in dump form. The memory contents displayed here are updated at given intervals (by default, every 100 ms) during user program execution.

You can change the manner in which the RAM monitor area you have set in the above dialog box is displayed.

- Shows the blocks at the preceding addresses.
- Shows the blocks at the following addresses.

The background colors of the data display and the code display sections change with the access attribute as described below.

- Green Addresses accessed for read
- Red Addresses accessed for write
- White Addresses not accessed

The background colors can be changed as necessary.

3. RAM monitor area setting window in initial state

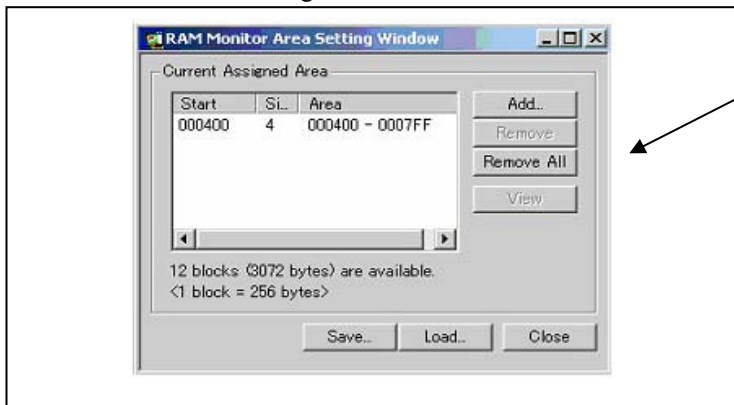

RAM Monitor Area Setting Window in initial state

By default, the monitor area is set to 000400h through 0007FFh. To change it, click the "Add..." or "Remove" button.

It is possible to add, delete and change the RAM monitor area.

You can change the start address, size (number of blocks) of the RAM monitor area by selecting the desired RAM monitor area from the list.

To add a RAM monitor area, click the "Add..." button. The RAM Monitor Area Setting Window will be displayed.

4. RAM monitor area setting dialog box

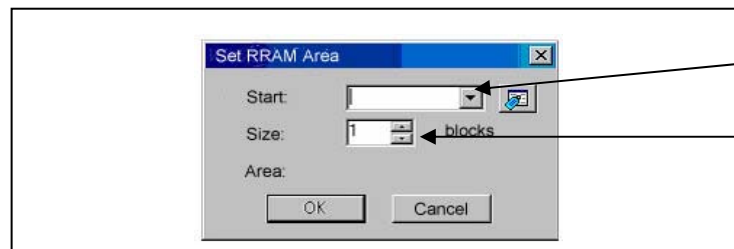

Specifying the start address
You can set the start address of the RAM area to be monitored.

Specifying the size
You can set the size to be monitored by specifying the number of blocks from the start address. One block is 256 bytes in size.

4. Hardware Specifications

This chapter describes specifications of this product.

4.1 Target MCU Specifications

Table 4.1 lists the specifications of target MCUs which can be debugged with this product.

Table 4.1 Specifications of target MCUs for the M3028BT-EPB

Item	Description
Applicable MCU	M16C/Tiny Series MCUs
Evaluation MCU	M30290FCWP ROM: 128KB + 4KB, RAM: 12KB
Usable MCU mode	Single-chip mode
Max. ROM/RAM capacity	(1) Internal flash ROM: 128KB + 4KB 0F000h--0FFFFh, E0000h--FFFFFFh, for the maximum operating frequency, refer to *1. (2) Internal RAM: 12KB 00400h--033FFh, for the maximum operating frequency, refer to *1.
Maximum operating frequency	Power voltage at 4.2 to 5.5V: 24MHz (PLL oscillation at 24MHz products) Power voltage at 3.0 to 5.5V: 20MHz Power voltage at 2.7 to 5.5V: 10MHz

*1 If "Disable Internal Flash ROM" of the MCU tab in the MCU Setting dialog box is checked, 0 wait access to the MCU internal flash ROM and MCU internal RAM in the MCU is enabled at 10MHz or less.

4.2 Differences between the Actual MCU and Emulator

Differences between the actual MCU and emulator are shown below. When debugging the MCU using this product, be careful about the following precautions.

IMPORTANT

Note on Differences between the Actual MCU and Emulator:

- Operations of the emulator system differ from those of actual MCUs as listed below.
 - (1) Reset condition
Set the time for starting up (0.2 VCC to 0.8 VCC) 1 μ s or less.
 - (2) Initial values of internal resource data of an MCU at power-on
Initial values are different. Set them in the user program.
 - (3) Interrupt stack pointer (ISP) after a reset is released
Initial values are different. Set them in the user program.
 - (4) Capacities of the internal memories (ROM and RAM)
The evaluation MCU of this product has RAM of 12KB (00400h--033FFh) and flash ROM of 4KB (0F000h--0FFFFh) and 128KB (E0000h--FFFFFh).
The number of write/erase cycles of the internal flash ROM of the MCU is limited. If you use the emulation memory instead of the internal flash ROM of the evaluation MCU, the number of write/erase cycles will be unlimited. However, the maximum operating frequency is 10 MHz.
 - (5) Oscillator circuit
In the oscillator circuit where an oscillator is connected between pins X_{IN} and X_{OUT}, oscillation does not occur because a package converter board is used between the evaluation MCU and the user system. For notes on when using an oscillator circuit on the user system, refer to "2.11.3 Using the Oscillator Circuit on the User System " (page 41). It is same for pins X_{CIN} and X_{COU}T.
 - (6) Xin input when resetting the MCU
With the target MCUs, an oscillator circuit is initialized during reset execution, and an on-chip oscillator is changed to system clock. Therefore, the emulator system can be operated without a clock to the pin Xin. With an evaluation MCU, when resetting the MCU, it is necessary to input a clock to the pin Xin before the emulator control program changes the on-chip oscillator to the system clock.
 - (7) A/D conversion
The characteristics of the A/D converter differ from those of actual MCU because there are a package converter board and other devices between the evaluation MCU and the user system.
 - (8) Operation after releasing the reset
After releasing the reset, for about up to 350 cycles, a program to control the emulator will be executed. Note that this will have an affect on a user program execution time and tracing result.

Note on RESET# Input:

- A low input to pin RESET# from the user system is accepted only when a user program is being executed (only while the RUN status LED on the PC7501's upper panel is lit).

Note on NMI# Input:

- A low input to pin NMI# from the user system is accepted only when a user program is being executed (only while the RUN status LED on the C7501's upper panel is lit).

IMPORTANT

Note on Voltage Detect Circuit:

- As the power voltage cannot be changed after powering on the user system, the voltage detect circuit (voltage down detect interrupt and hardware reset 2) cannot be used with this product.

Notes on Reset Vector Area:

- Memory in the emulator main unit is always selected as a reset vector area (FFFFCh--FFFFFh) in order to operate the evaluation MCU in the emulator-dedicated mode. Set the contents of the reset vector area in one of the following ways.
 - (1) Download a user program to an area including the reset vector area.
 - (2) Set the reset vector using a memory window of the emulator debugger etc.
- You can change data in the reset vector area only when the user program is stopped.
- Do not access the reset vector area as data. It may not be accessed properly, and the program may not run properly in the next bus cycle.

Notes on Stack Area:

- With this product, a maximum 8 bytes of the user stack is consumed as a work area.
Even if the user stack does not have an enough area, do not use areas which cannot be used as a stack (SFR area, RAM area which stores data, or ROM area) as a work area. Using areas like this is a cause of user program crashes and destabilized emulator control.
- With this product, the interrupt stack pointer (ISP) is set at 00500h and used as a stack area after a reset is released.

Notes on Maskable Interrupts:

- Even if a user program is not being executed (including when run-time debugging is being performed), the evaluation MCU keeps running so as to control the emulation probe. Therefore, timers and other components do not stop running.
If a maskable interrupt is requested when the user program is not being executed (including when run-time debugging is being performed), the maskable interrupt request cannot be accepted, because the emulator disables interrupts. The interrupt request is accepted immediately after the user program execution is started.
- Take note that when the user program is not being executed (including when run-time debugging is being performed), a peripheral I/O interruption is not accepted.

Note on DMA Transfer:

- With this product, the program is stopped with a loop program to a specific address. Therefore, if a DMA request is generated while the program is stopped, DMA transfer is executed. However, make note that DMA transfer while the program is stopped may not be performed correctly. Also note that the below registers have been changed to generate DMA transfer as explained here even when the program is stopped.
 - (1) DMA0 transfer counter: TCR0
 - (2) DMA1 transfer counter: TCR1

Note on Final Evaluation:

- Be sure to evaluate your system with an evaluation MCU. Before starting mask production, evaluate your system and make final confirmation with a CS (Commercial Sample) version MCU.

4.3 Connection Diagrams

Figure 4.1 shows a connection diagram of the M3028BT-EPB. This connection diagram mainly shows the interface section. The circuits not connected to the user system such as the emulator's control system are omitted. The signals not shown in Figure 4.1 connect the evaluation MCU and the user system directly. Table 4.2 shows IC electric characteristics of this product for reference purposes.

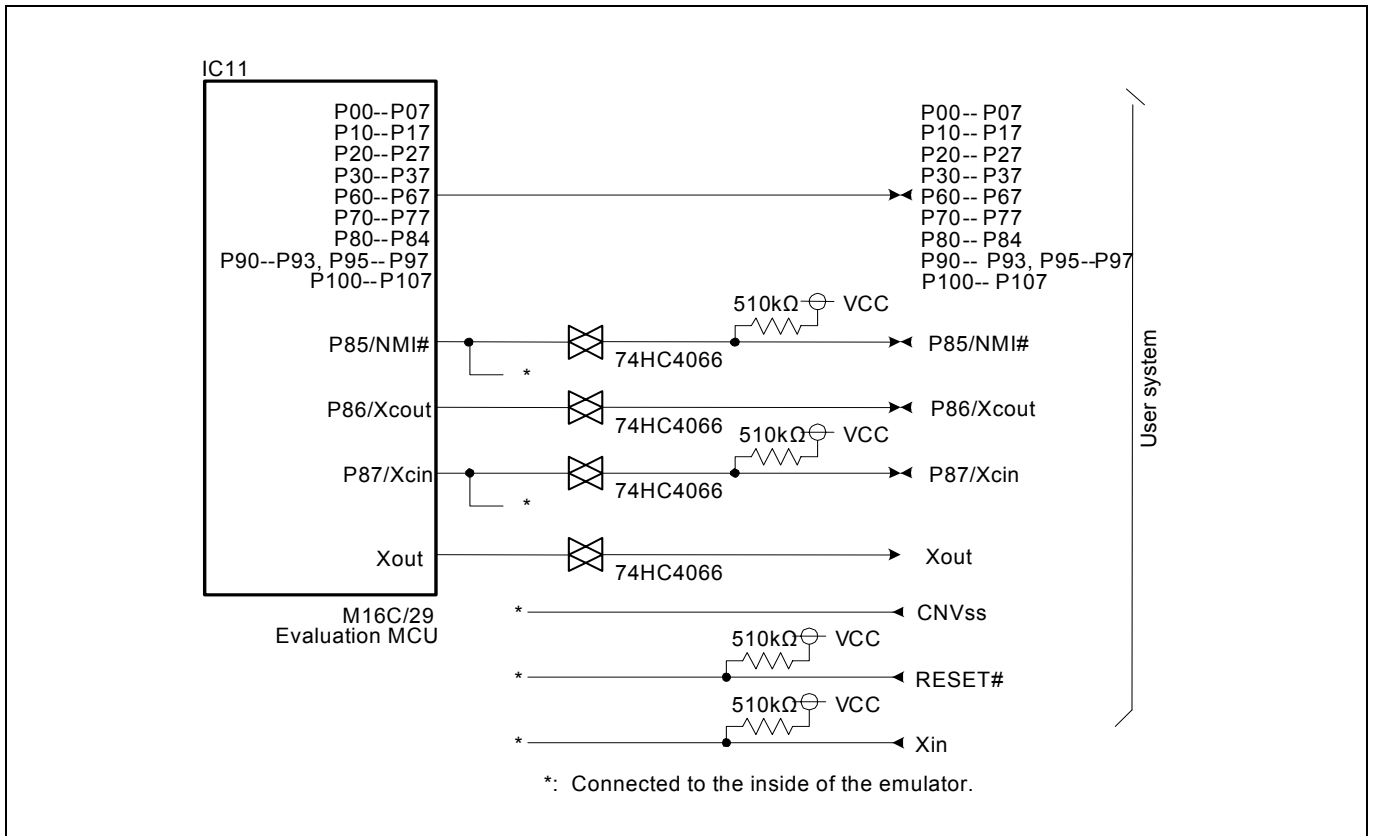

Figure 4.1 Connection diagram (when using M3028BT-EPB)

Table 4.2 Electrical characteristics of the 74HC4066

Symbol	Item	Condition	Standard values			Unit
			Min.	Standard	Max.	
R _{ON}	ON resistor	VCC=4.5V	-	96	200	Ω
ΔR _{ON}	ON resistor difference	VCC=4.5V	-	10	-	
I _{OFF}	Leak current (Off)	VCC=12.0V	-	-	±1	μA
I _{IZ}	Leak current (On, output: open)	VCC=12.0V	-	-	±1	

4.4 External Dimensions

4.4.1 External Dimensions of the Emulation Probe

Figure 4.2 shows external dimensions of the M3028BT-EPB connected with the M30290T-PTCB.

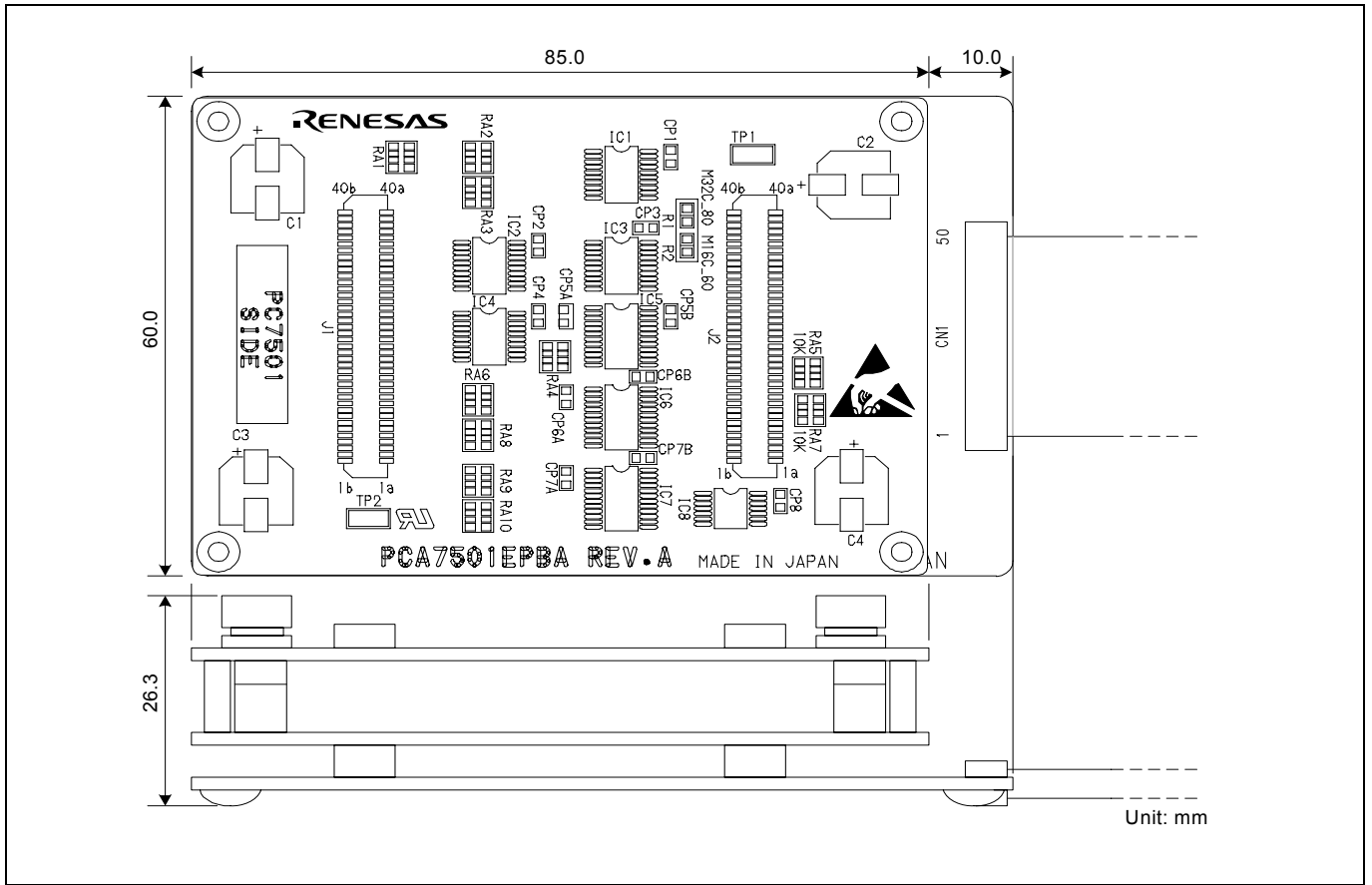

Figure 4.2 External dimensions of the emulation probe

4.4.2 External Dimensions of the Converter Board M30263T-42SSB

Figure 4.3 shows external dimensions and a sample foot pattern of the converter board M30263T-42SSB (included with the M3028BT-EPB-1) for a 42-pin 0.8mm pitch SSOP.

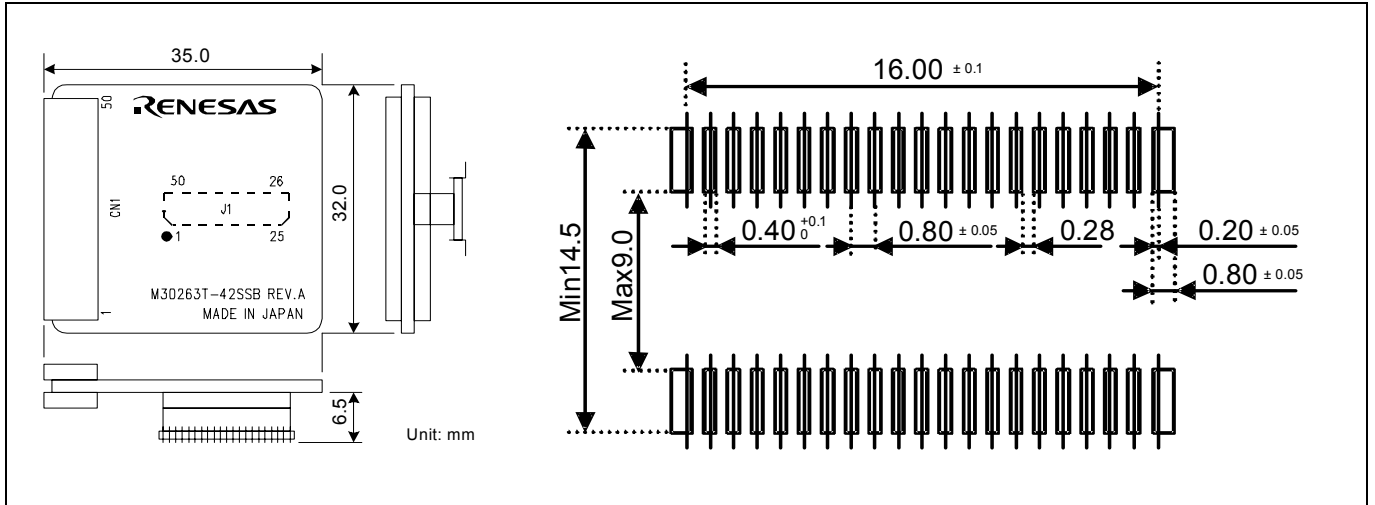

Figure 4.3 External dimensions and a sample foot pattern of the converter board M30263T-42SSB

4.4.3 External Dimensions of the Converter Board M30260T-48FPD

Figure 4.4 shows external dimensions and a sample foot pattern of the converter board M30260T-48FPD (included with the M3028BT-EPB-2) for a 48-pin 0.5mm pitch LQFP.

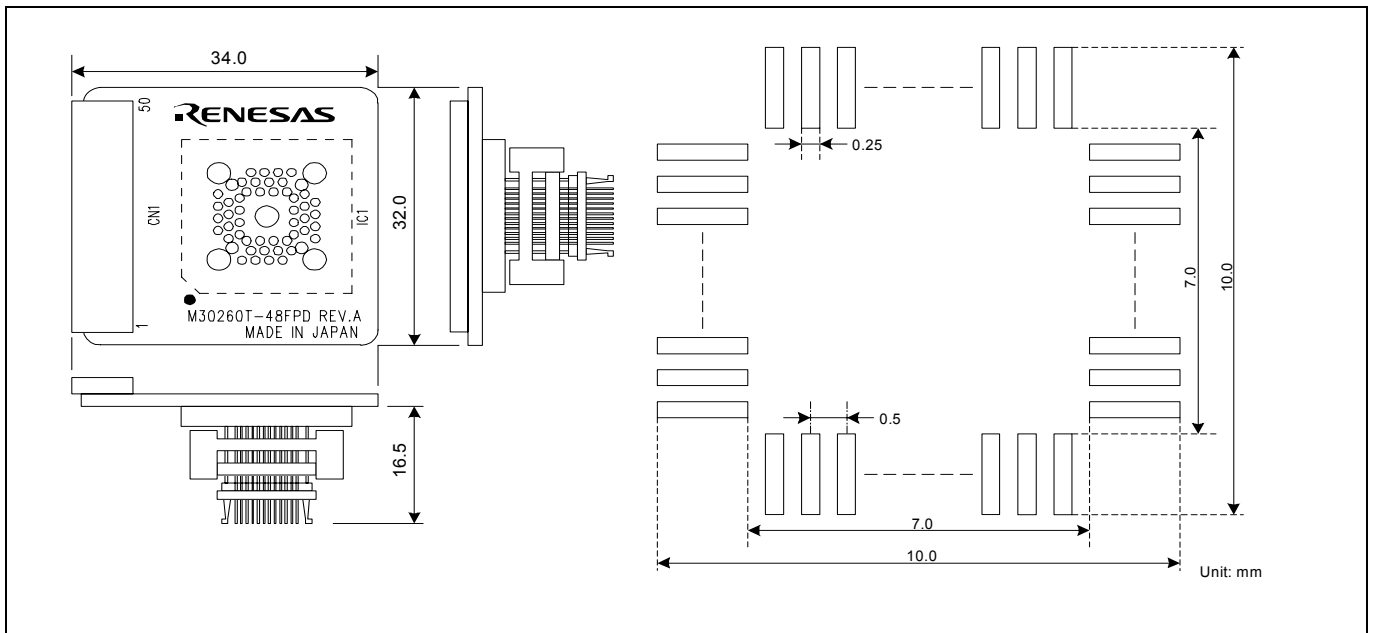

Figure 4.4 External dimensions and a sample foot pattern of the converter board M30260T-48FPD

4.4.4 External Dimensions of the Converter Board M30291T-64FPD

Figure 4.5 shows external dimensions and a sample foot pattern of the converter board M30291T-64FPD (included with the M3028BT-EPB-3) for a 64-pin 0.5mm pitch LQFP.

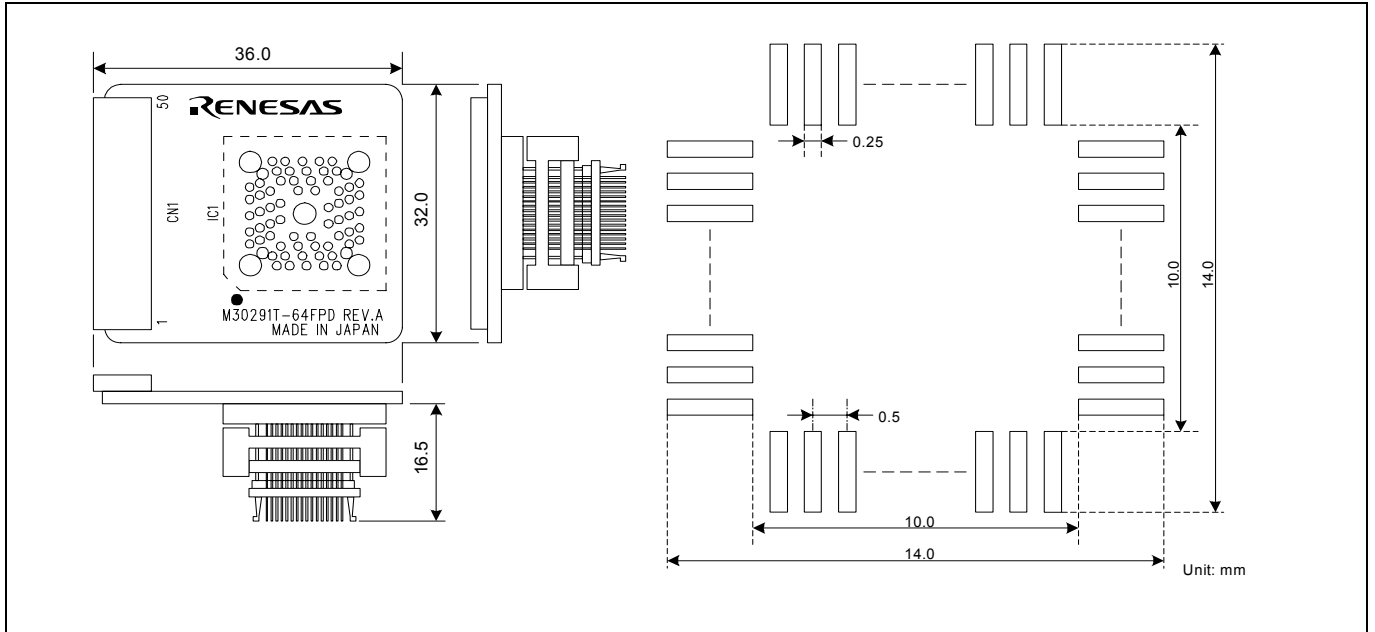

Figure 4.5 External dimensions and a sample foot pattern of the converter board M30291T-64FPD

4.4.5 External Dimensions of the Converter Board M30290T-80FPD

Figure 4.6 shows external dimensions and a sample foot pattern of the converter board M30290T-80FPD (included with the M3028BT-EPB-4) for an 80-pin 0.5mm pitch LQFP.

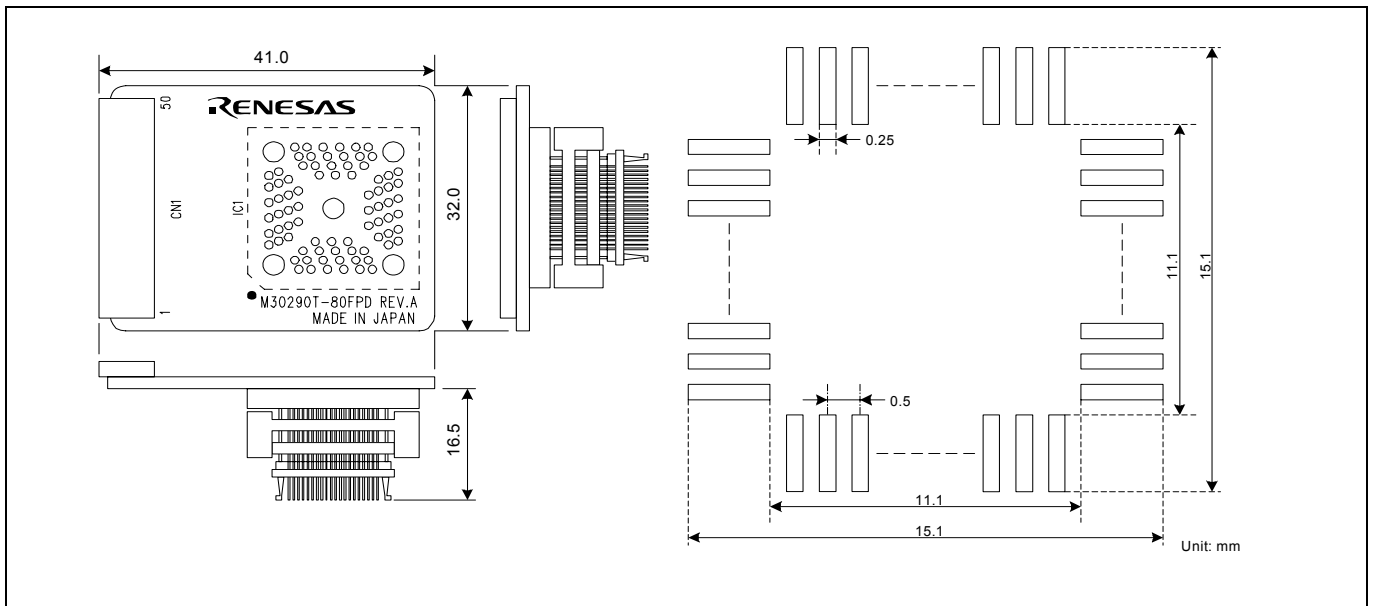

Figure 4.6 External dimensions and a sample foot pattern of the converter board M30290T-80FPD

4.4.6 External Dimensions of the Converter Board M30280T-85LGF

Figure 4.7 shows external dimensions and a sample foot pattern of the converter board M30280T-85LGF (included with the M3028BT-EPB-5) for an 80-pin 0.65mm pitch TFLGA.

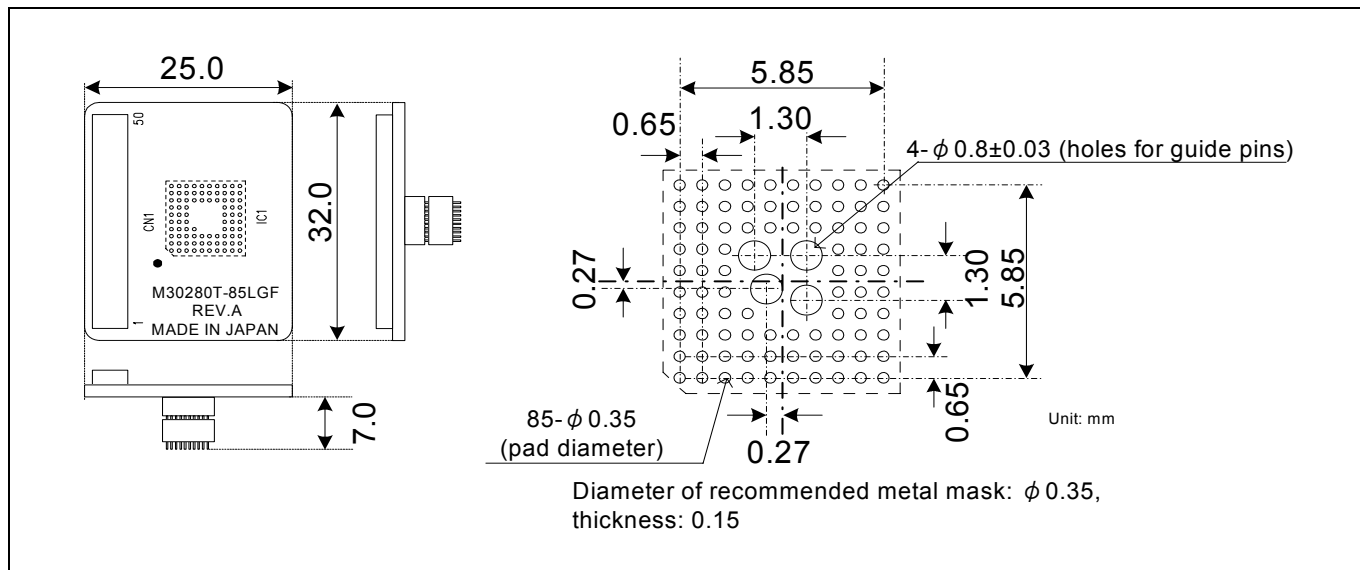

Figure 4.7 External dimensions and a sample foot pattern of the converter board M30280T-85LGF

4.5 Notes on Using This Product

Notes on using this product are listed below. When debugging the MCU using this product, be careful about the following precautions.

IMPORTANT

Note on the Version of the Emulator Debugger:

- Be sure to use this product with one of the following emulator debuggers.
 - (1) M16C R8C PC7501 Emulator debugger V.1.01 Release 00 or later
 - (2) M3T-PD30F V2.20 Release 1 or later.

Notes on Downloading Firmware:

- Before using this product for the first time, it is necessary to download the dedicated firmware (control software built into the PC7501). Please note that, to do this, it is necessary to start up the PC7501 in maintenance mode. For firmware download procedures, see "2.7 Downloading Firmware" (page 27). Once the firmware has been downloaded, the product can be used by simply turning on the power.
- Do not shut off the power while downloading the firmware. If this happens, the product will not start up properly. If power is shut off unexpectedly, redownload the firmware.
- Download the firmware with the user system not connected.

Notes on Self-check:

- If the self-check does not result normally (excluding user system errors), the emulation probe may be damaged. Then contact your local distributor.
- Run the self-check with the user system not connected.

Note on Quitting the Emulator Debugger:

- To restart the emulator debugger after it ends, always shut power to the emulator module off once and then on again.

Note on Display of MCU Status:

- "MCU status" you can refer to in the MCU tab of the MCU Setting dialog box of the emulator debugger shows pin levels of the user system. Make sure that proper pin levels are specified according to the mode you use.
When single-chip mode is used:
CNVss: Low

IMPORTANT

Note on Clock Supply to an MCU:

- A clock supplied to the evaluation MCU is selected by the Emulator tab in the Init dialog box of the emulator debugger.
 - (1) When "Internal" is selected:

A clock generated by the oscillator circuit board in the PC7501 is supplied. It is continually supplied regardless of the status of the user system clock and that of the user program execution.
 - (2) When "External" is selected:

A clock generated by the oscillator in the user system is supplied. It depends on the status of the oscillation (on/off) of the user system.
 - (3) When "Generate" is selected:

A clock generated by the dedicated circuit in the PC7501 is supplied. It is continually supplied regardless of the status of the user system clock and that of the user program execution.

Note on Operating Frequency:

- You can not use this product with a main clock (XIN-XOUT) less than 1MHz. To use it with a main clock less than 1MHz, contact your local distributor.

Note on Timeout Setting:

- At 8MHz or less, when you download, execute or single-step a program at a low operating frequency, a communication timeout error may occur.

Execute the command shown below in the Script Window after starting the emulator debugger.

```
[Command]          _settimeout 300, 300
```

Once this command is executed, it remains effective the next time you start the emulator debugger. Therefore, you do not need to execute this command again. It is set to 30 seconds for downloading, and 30 seconds for other than downloading.

If the error still occurs in this setting, contact your local distributor.

Note on Stop and Wait Modes:

- Do not single step an instruction shifting to stop or wait mode. It may cause communication errors.

Note on the Watchdog Function:

- If the reset circuit of the user system has a watchdog timer, disable it when using the emulator.

Note on Protect Register:

- The protect is not canceled when bit 2 of protect register PRCR (PRC2), which enables writing into the port P9 direction register and the SI/Oi control register, is changed with the below procedure.
 - (1) Step execution of an instruction setting PRC2 to "1"
 - (2) Setting a break point between an instruction setting PRC2 to "1" and a point where the port P9 direction register or the SI/Oi control register is set
 - (3) Setting PRC2 to "1" by the memory window or script window

IMPORTANT

Note on Access Prohibited Area:

- You cannot use internally reserved areas. Write signals to the areas will be ignored, and values read will be undefined.

Note on Breaks:

- The area displaying break points in the program window of the emulator debugger shows the following breaks.
 - (1) Address-match break
This is a debugging function which breaks a program, using the address-match interrupt function of the MCU, immediately before the system executes an instruction at a specified address. The instruction at the preset address will not be executed.
 - (2) Software break
This is a debugging function which generates a BRK interruption by changing an instruction at a specified address to a BRK instruction (00h) to break a program immediately before the system executes an instruction at a specified address. The instruction at the preset address will not be executed.
 - (3) Hardware break
This is a debugging function which breaks a program by setting the detection of an execution of an instruction at a specified address as a break event. The program will break after the instruction at the specified address is executed (after several cycles).

Notes on Software Breaks:

- Software breaks change the instruction at a specified address to a BRK (00h). Therefore, take note that when you reference the result of a trace in bus mode, "00h" is displayed.
- The BRK instruction can be used for the emulator only. You cannot use it in a user program.
- You can neither set nor cancel a software breakpoint in the internal ROM area of an MCU during user program execution, while you can set or cancel it in the internal RAM area of an MCU.

Notes on Address-Match Breaks:

- As the processing speed of setting and canceling address-match breaks is relatively fast, you can save the times of writing into the internal flash ROM of an MCU. Therefore, address-match breaks precede the other breaks when setting breakpoints in the internal flash ROM area of an MCU.
- Address-match breaks can be set at up to six points. The other breaks are set as software breaks.
- Address-match breaks can be set or canceled even when the user program is being executed.

Notes Power Supply to the User System:

- Pin VCC is connected in order to monitor user system voltage. For this reason, the emulator cannot supply power to the user system. Therefore, provide the user system with a separate power supply.
- The voltage of the user system should be as follows.
$$2.7\text{ V} \leq \text{VCC} \leq 5.5\text{ V}$$
- Do not change the voltage of the user system after turning on the power.

IMPORTANT

Notes on Internal Flash ROM of the MCU:

- This product downloads a user program to the flash ROM in an MCU. By checking "Disable the Internal Flash ROM" in the MCU tab of the MCU setting dialog box of the emulator debugger, you can disable the operation of the internal flash ROM of the MCU to use the emulation memory. However, the maximum operating frequency is 10MHz.
- Because the number of write/erase cycles of the internal flash ROM of the MCU is limited, it must be replaced at the end of its service-life.
- If the following errors occur frequently when downloading a program, To purchase products for replacement, contact your local distributor.
 - (1) Flash ROM erase error occurred ERROR (16258)
 - (2) Flash ROM verify error occurred ERROR (16259)

Note on Debugging in CPU Rewrite Mode:

- When debugging in CPU Rewrite Mode, check "Debug the program using CPU Rewrite Mode" in the MCU tab of the Init dialog box of the emulator debugger.

Note on Debugging in CPU Rewrite Mode:

- When you debug M16C/Tiny Series MCUs in CPU rewrite mode, do not change the block 0 area (FF000h--FFFFh) of the flash ROM. Otherwise, the emulator will be uncontrollable.
- If you check "Debug the program using CPU Rewrite Mode" in the MCU tab of the Init dialog box of the emulator debugger, you cannot use the following functions.
 - (1) Setting software breakpoints in an internal ROM area
 - (2) Executing COME in an internal ROM area
- Do not stop the program in the CPU rewrite mode or erase suspend mode. And do not single step the instruction shifting to these modes. The emulator is uncontrollable in these modes.
- The data written in the CPU rewrite mode cannot be referenced during the user program is being executed. To reference data after executing CPU rewrite, stop the program at a point which is not a rewrite control program area and use a memory window etc.
- As the following interrupt vectors are used by the emulator system, the read data is different from expected value.
 - (1) BRK instruction (FFFE4h--FFFE7h)
 - (2) Address match (FFFE8h--FFFEb)
 - (3) Single-step (FFFECh--FFFEFh)
 - (4) DBC (FFFF4h--FFFF7h)

IMPORTANT

Notes on Address-Match Interrupts:

- When you use the address-match interrupt function in a user program, uncheck "Enable the Address Match Interrupt Break Function" in the MCU tab of the Init dialog box of the emulator debugger. Thus, normal software breaks are used for the internal RAM and ROM areas of an MCU.
- Do not set a software break at an address where an address-match interrupt occurs. Otherwise, a user program may be run out of control. Set a software or hardware break in the top address in address-match interrupt processing.
- When you single step an address where an address-match interrupt occurs, the program stops after executing the first instruction after returning from address-match interrupt processing.

Note on Accessing Addresses 00000h and 00001h:

- With the M16C/Tiny Series MCUs, when a maskable interrupt is generated, the interrupt data (interrupt number and interrupt request level) stored in addresses 00000h and 00001h are read out. Also, the interrupt request bit is cleared when address 00000h or 00001h is read out. Consequently, when the address 00000h or 00001h readout instruction is executed or when address 00000h or 00001h is read out in the cause of a program runaway, a malfunction occurs in that the interrupt is not executed despite the interrupt request, because the request bit of the highest priority interrupt factor enabled is cleared.

For this malfunction, when the reading out to address 00000h or 00001h is generated excluding the interrupt, the WARNING LED (yellow) lights up to alarm. When this LED lights, there is a possibility of read access, therefore check the user program.

Note on Debugging Operations after Releasing a Reset from the User System:

- Do not execute debugging operations (such as stopping the user program execution by an address-match, software or hardware break, run-time debugging) after releasing a reset on the user system until an interrupt stack pointer (ISP) is set in the user program.

5. Troubleshooting

This chapter describes how to troubleshoot when this product does not work properly.

5.1 Flowchart to Remedy the Troubles

Figure 5.1 shows the flowchart to remedy the troubles from when power to the emulator is activated until the emulator debugger starts up. Check this while the user system is disconnected. For the latest FAQs visit the Renesas Tools Homepage.

<http://www.renesas.com/en/tools>

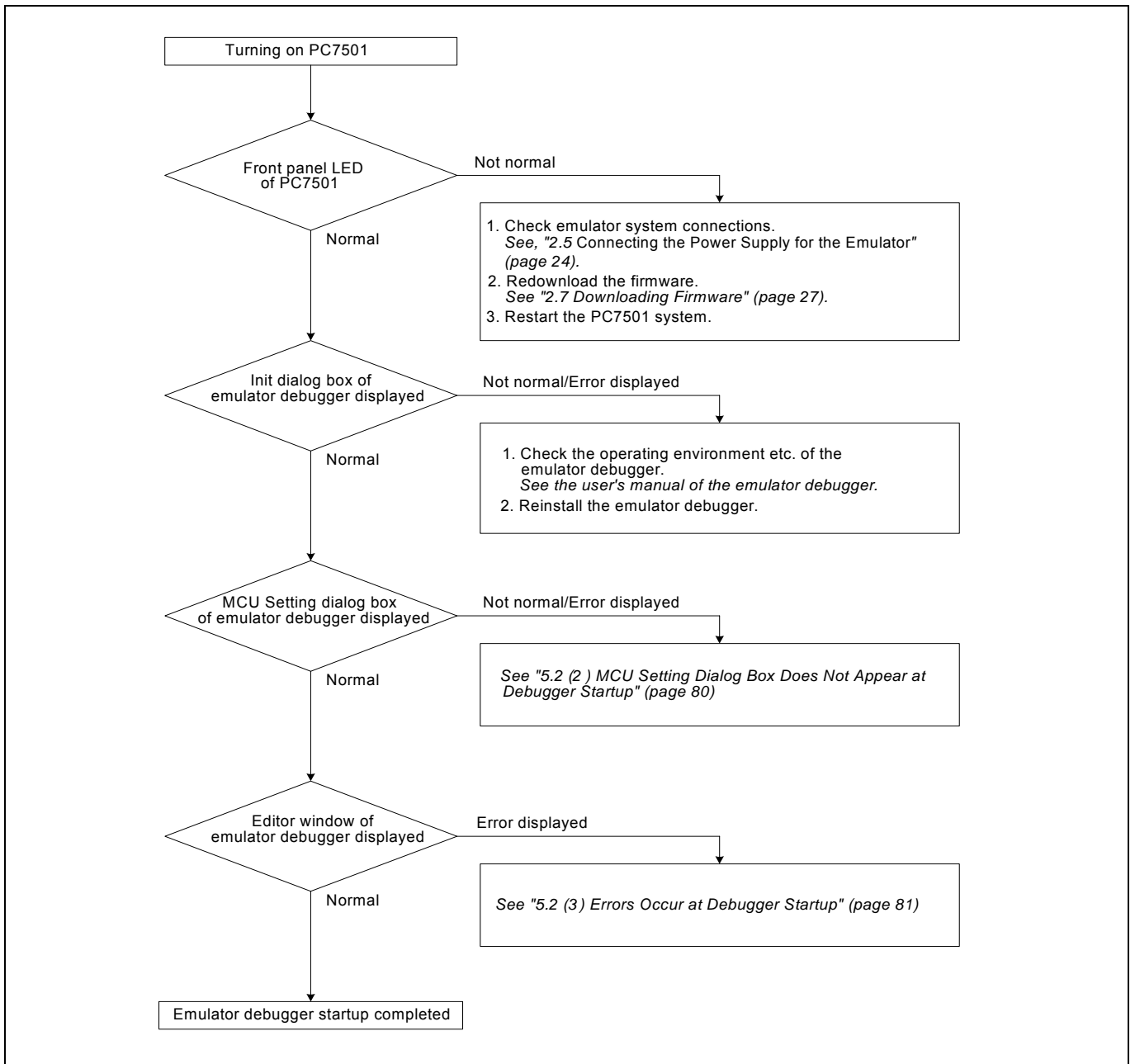

Figure 5.1 Flowchart to remedy the troubles

5.2 When the Emulator Debugger Does Not Start Up Properly

(1) When the LEDs of the PC7501 Do Not Display Normally

Table 5.1 Errors LEDs show and their checkpoints

Error	Connection to the user system	Checkpoint
LEDs do not light up.	-	Check that the power cable is connected. <i>See "2.5 Connecting the Power Supply for the Emulator" (page 24) and the user's manual of the PC7501.</i>
All LEDs remain lit.	-	Recheck the connection between the PC7501 and this product. <i>See "2.4 Connecting the PC7501" (page 23).</i>
The POWER LED of "STATUS OF TARGET" does not light up.	Connected	Check that power (VCC) is properly supplied to the user system and that the user system is properly grounded.
The CLOCK LED of "STATUS OF TARGET" does not light up.	Not connected	(1) Check that both the main and sub clocks of the emulator debugger are not set to "EXT". <i>See the CLK command of the emulator debugger.</i> (2) Check the oscillation circuit in the emulator is oscillating. <i>See "2.11 Selecting Clock Supply" (page 37).</i>
	Connected	(1) When the clock is supplied from an external oscillator, check that the oscillator circuit in the user system is oscillating properly.
The RESET LED of "STATUS OF TARGET" does not go out.	Connected	Check that the reset pin of the user system is pulled up.

(2) MCU Dialog Box Does Not Appear at Debugger Startup

Table 5.2 Checkpoints of errors at debugger startup

Error	Checkpoint
Communication error occurred. Data was not sent to the target.	Check that all emulator debugger settings, interface cable settings and switches on the rear of the PC7501 match. <i>See the user's manuals of the PC7501 and emulator debugger.</i>
User system cannot be properly built.	(1) Download the proper firmware. <i>See "2.7 Downloading Firmware" (page 27).</i> (2) Check that the connection between the PC7501 and this product. <i>See "2.4 Connecting the PC7501" (page 23).</i>
Emulator is not the same version as the firmware in the target.	Download the proper firmware. <i>See "2.7 Downloading Firmware" (page 27).</i>
Target MCU is in the reset state.	Check that the reset pin of the user system has changed from Low to High level.
Target MCU cannot be reset.	(1) Check that pin NMI# is held High. (2) If the reset circuit of the user system has a watchdog timer, disable the timer. (3) Check that power is properly supplied to the user system and that the user system is properly grounded.
Target is in "HOLD" state.	(1) The MCU is either in stop mode or wait mode. Either reset the MCU or cancel the mode with an interrupt. <i>See MCU specifications.</i>
Target clock is stopped.	Check that the oscillator circuit of the user system is oscillating properly.
Target MCU is not receiving power.	Check that power is properly supplied to the user system and that the user system is properly grounded.

(3) Errors Occur at Debugger Startup

Table 5.3 Checkpoints of errors at debugger startup

Error	Checkpoint
Target MCU is uncontrollable.	(1) Check that the NQPACK etc. mounted on the user system is soldered properly. (2) Check that the connector is connected properly to the user system.

5.3 How to Request for Support

After checking the items in "5 Troubleshooting", to request for support, fill in the text file which is downloaded from the following URL, then send the information to your local distributor.

<http://tool-support.renesas.com/eng/toolnews/registration/support.txt>

For prompt response, please specify the following information:

(1) Operating environment

- Operating voltage: _____ [V]
- Operating frequency: _____ [MHz]
- Clock supply to the MCU: Internal oscillator/External oscillator

(2) Condition

- The emulator debugger starts up/does not start up
- The error is detected/not detected in the self-check
- Frequency of errors: always/frequency (_____)

(3) Problem

6. Maintenance and Guarantee

This chapter describes how to maintenance, repair provisions and how to request for repair.

6.1 User Registration

When you purchase our product, be sure register as a user. For user registration, refer to “User registration” (page 11) of this user's manual.

6.2 Maintenance

- (1) If dust or dirt collects on any equipment of your emulation system, wipe it off with a dry soft cloth. Do not use thinner or other solvents because these chemicals can cause the equipment's surface coating to separate.
- (2) When you do not use this product for a long period, for safety purposes, disconnect the power cable from the power supply.

6.3 Guarantee

If your product becomes faulty within one year after its purchase while being used under good conditions by observing "IMPORTANT" and "Precautions for Safety" described in this user's manual, we will repair or replace your faulty product free of charge. Note, however, that if your product's fault is raised by any one of the following causes, we will repair it or replace it with new one with extra-charge:

- Misuse, abuse, or use under extraordinary conditions
- Unauthorized repair, remodeling, maintenance, and so on
- Inadequate user's system or misuse of it
- Fires, earthquakes, and other unexpected disasters

In the above cases, contact your local distributor. If your product is being leased, consult the leasing company or the owner.

6.4 Repair Provisions

(1) Repair with extra-charge

The products elapsed more than one year after purchase can be repaired with extra-charge.

(2) Replacement with extra-charge

If your product's fault falls in any of the following categories, the fault will be corrected by replacing the entire product instead of repair, or you will be advised to purchase new one, depending on the severity of the fault.

- Faulty or broken mechanical portions
- Flaw, separation, or rust in coated or plated portions
- Flaw or cracks in plastic portions
- Faults or breakage caused by improper use or unauthorized repair or modification
- Heavily damaged electric circuits due to overvoltage, overcurrent or shorting of power supply
- Cracks in the printed circuit board or burnt-down patterns
- Wide range of faults that makes replacement less expensive than repair
- Unlocatable or unidentified faults

(3) Expiration of the repair period

When a period of one year elapses after the model was dropped from production, repairing products of the model may become impossible.

(4) Transportation fees at sending your product for repair

Please send your product to us for repair at your expense.

6.5 How to Make Request for Repair

Fill in the Repair Request Sheet included with this product, then send it along with this product for repair to your local distributor. Make sure that information in the Repair Request Sheet is written in as much detail as possible to facilitate repair.

CAUTION

Note on Transporting the Product:

- When sending your product for repair, use the packing box and cushion material supplied with this product when delivered to you and specify handling caution for it to be handled as precision equipment. If packing of your product is not complete, it may be damaged during transportation. When you pack your product in a bag, make sure to use conductive polyvinyl supplied with this product (usually a blue bag). When you use other bags, they may cause a trouble on your product because of static electricity.

Emulation Probe for M16C/Tiny Series
M3028BT-EPB User's Manual

Publication Date: Sep. 16, 2006 Rev.2.00

Published by: Sales Strategic Planning Div.
Renesas Technology Corp.

Edited by: Microcomputer Tool Development Department
Renesas Solutions Corp.

© 2006. Renesas Technology Corp. and Renesas Solutions Corp., All rights reserved. Printed in Japan.

M3028BT-EPB User's Manual

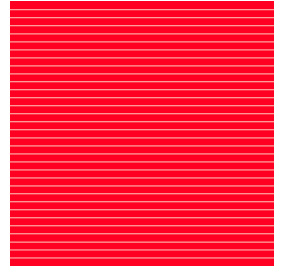

Renesas Technology Corp.

2-6-2, Ote-machi, Chiyoda-ku, Tokyo, 100-0004, Japan

Download from [Www.Somanuals.com](http://www.Somanuals.com). All Manuals Search And Download.

Free Manuals Download Website

<http://myh66.com>

<http://usermanuals.us>

<http://www.somanuals.com>

<http://www.4manuals.cc>

<http://www.manual-lib.com>

<http://www.404manual.com>

<http://www.luxmanual.com>

<http://aubethermostatmanual.com>

Golf course search by state

<http://golfingnear.com>

Email search by domain

<http://emailbydomain.com>

Auto manuals search

<http://auto.somanuals.com>

TV manuals search

<http://tv.somanuals.com>