

# SEARS Owner's Manual



## MICROWAVE OVEN

Model Nos.

565. 69300

565. 69301

565. 69400

565. 69401

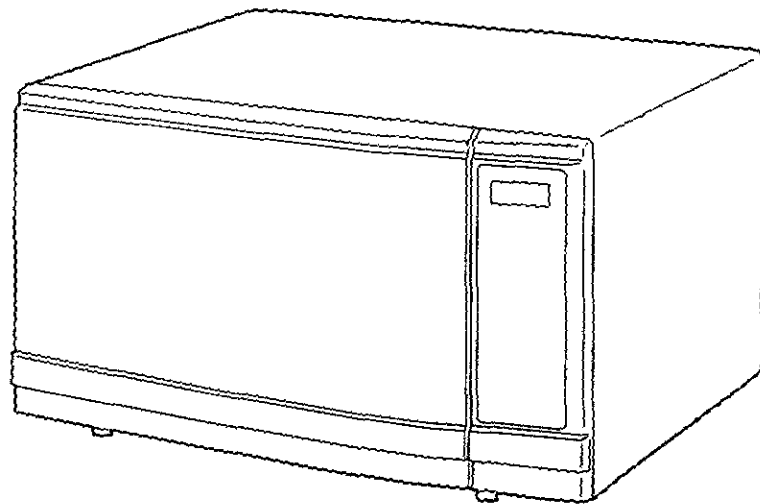

### CAUTION:

Before using this appliance, read this manual and follow all safety rules and Operating Instructions.

(Spanish Owner's Manual can be found on page 29 - 41.)

(El manual del propietario en español se encuentra en las páginas 29 - 41).

### SAVE THESE INSTRUCTIONS

Sears, Roebuck and Co., Hoffman Estates, IL 60179, U.S.A.

SAFETY

ASSEMBLY

OPERATION

COOKING GUIDE

MAINTENANCE

ESPAÑOL

# PRECAUTIONS TO AVOID POSSIBLE EXPOSURE TO EXCESSIVE MICROWAVE ENERGY

- (a) **Do not** attempt to operate this oven with the door open since open-door operation can result in harmful exposure to microwave energy. It is important not to defeat or tamper with the safety interlocks.
- (b) **Do not** place any object between the oven front face and the door or allow soil or cleaner residue to accumulate on sealing surfaces.
- (c) **Do not** operate the oven if it is damaged. It is particularly important that the oven door closes properly and that there is no damage to the:
  - (1) DOOR (bent)
  - (2) HINGES AND LATCHES (broken or loosened)
  - (3) DOOR SEALS AND SEALING SURFACES
- (d) **The oven** should not be adjusted or repaired by anyone except properly qualified service personnel.

## SPECIFICATIONS

<b>Model:</b>	565. 69300/ 565. 69301	565.69400/ 565. 69401
<b>Power Source:</b>	AC 120 V, 60 Hz	AC 120 V, 60 Hz
<b>Power Consumption:</b>	1480W, 12.9 Amps	1480W, 12.9 Amps
<b>Maximum Output:</b>	1000W*	1000W*
<b>Oven Capacity:</b>	1.3 cu. ft.	1.8 cu. ft.
<b>Turntable Diameter:</b>	12- <sup>5</sup> / <sub>8</sub> " (320 mm)	12- <sup>5</sup> / <sub>8</sub> " (320 mm)
<b>Dimensions: (w x h x d)</b>	21- <sup>5</sup> / <sub>8</sub> " x 12- <sup>1</sup> / <sub>2</sub> " x 17- <sup>11</sup> / <sub>16</sub> "	23- <sup>7</sup> / <sub>16</sub> " x 14- <sup>1</sup> / <sub>4</sub> " x 17- <sup>11</sup> / <sub>16</sub> "
<b>Weight: Approx.</b>	38.5 lbs.	42 lbs.

\*According to IEC-705 test procedure  
Specifications subject to change without notice.

## FOR YOUR ASSISTANCE...

To make a request for service, information or replacement of parts, Sears will require the complete **Model number** and **Serial number** of your oven. Copy your Model and Serial numbers.

**Model No.**

\_\_\_\_\_  
(Located on the inner left side of control panel)

**Serial No.**

\_\_\_\_\_  
(Located on the inner left side of control panel)

## TABLE OF CONTENTS

### SAFETY

Proper and safe use of your oven	4
Important Safety Instructions	5
Electrical Grounding Instructions	6
Utensils	6

### ASSEMBLY

Names of Oven Parts and Accessories	8
Turntable Installation	8
Installation	9

### OPERATION

#### Basic Features

Control Panel and Features	10
Setting Clock	11
Child Lock-Out	11
Kitchen Timer	12
Time Cooking	12

#### Special Features

Quick Touch™ Cooking	14
Automatic Defrost by Weight	15
Quick-On Cooking	17

### COOKING GUIDE

Cooking Techniques	18
Quick Touch™ Cooking	19
Appetizers and Rice	21
Meats, Poultry and Fish	22
Eggs	24
Baked Goods and Desserts	25

### MAINTENANCE

Cleaning	26
Sears Service	26
Troubleshooting	27

### ESPAÑOL (Spanish Instructions)

GARANTIA	29
SEGURIDAD	30
ENSAMBLE	33
OPERACION	34

(Consulte la página 29 para encontrar el índice detallado)

## WARRANTY

### KENMORE® MICROWAVE OVEN **FULL ONE YEAR WARRANTY**

For one year from the date of purchase, if this Kenmore® Microwave Oven fails due to a defect in material or workmanship, Sears will repair it, free of charge.

### KENMORE® MAGNETRON **FULL FIVE YEAR WARRANTY**

For five years from the date of purchase, if the magnetron in this Kenmore® Microwave Oven fails due to a defect in material or workmanship, Sears will repair it, free of charge.

The above warranty coverage applies only to microwave ovens which are used for private household purposes.

Warranty service is available by simply **CONTACTING THE NEAREST SEARS STORE OR SERVICE CENTER** in the United States.

This Warranty applies only while this product is in use in the United States.

The Warranty give you specific legal rights, and you may also have other rights which vary from state to state.

**SEARS, ROEBUCK AND CO.,  
D/817 WA,  
HOFFMAN ESTATES, IL. 60179**

For Service Call:  
1 - 800 - 4 - REPAIR  
1 - 800 - 473 - 7247

## SAFETY

### PROPER AND SAFE USE OF YOUR OVEN

---

- The oven must be level.
- **The turntable and turntable roller rest** must be in the oven during cooking. See page 8.
- **Place** the cookware gently on the turntable and handle it carefully to avoid possible breakage.
- **Incorrect use** of browning dish may cause the turntable to break. See page 7.
- **Use** only the specified bag size when using Quick Touch™ Popcorn.
- **The oven** has several built-in safety switches to ensure that the power remains off when the door is open. Do not tamper with these switches.
- **Do not** operate the microwave oven when empty. Operating the oven with no food or food that is extremely low in moisture can cause fire, charring or sparking.
- **Do not** cook bacon directly on the turntable. Excessive local heating of the turntable may cause it to break.
- **Do not** heat baby bottles or baby food in the microwave oven. Uneven heating may occur and could cause physical injury.
- **Do not** heat narrow-necked containers, such as syrup bottles.
- **Do not** attempt to deep-fry in your microwave oven.
- **Do not** do home canning in this microwave oven as it is impossible to be sure all contents of the jar have reached boiling temperature.
- **Do not** use this microwave oven for commercial purposes. This microwave oven is made for household use only.
- To prevent delayed eruptive boiling of hot liquids and beverages or scalding, stir liquid before placing the container in the oven and again halfway through cooking time. Let stand in the oven for a short time and stir again before removing the container.

# IMPORTANT SAFETY INSTRUCTIONS

When using electrical appliances, basic safety precautions should be followed, including the following:

SAFETY



**WARNING** - To reduce the risk of burns, electric shock, fire, injury to persons or exposure to excessive microwave energy:

- **Read** all instructions before use.
  - **Read and follow** the specific "PRECAUTIONS TO AVOID POSSIBLE EXPOSURE TO EXCESSIVE MICROWAVE ENERGY" on page 2.
  - As with most cooking appliances, close supervision is necessary to reduce the risk of a fire in the oven cavity.
- If a fire should start:**
- Keep the oven door closed
  - Turn the oven off, and
  - Disconnect the power cord or shut off power at the fuse or circuit breaker panel.
- Keep in mind the following rules at all times:**
- a) **Do not** overcook foods. Carefully attend the appliance if paper, plastic, or other combustible materials are placed inside the oven to facilitate cooking.
  - b) **Do not** use the cavity for storage purposes. Do not store combustible items such as bread, cookies, paper products, etc. inside the oven. If lightning strikes the power line, the oven may turn on by itself.
  - c) Remove wire twist-ties and metal handles from paper or plastic containers/bags before placing them in the oven.
- **This oven** must be grounded. Connect only to properly grounded outlet. See page 6.
  - **Some products** such as whole eggs, water with oil or fat, sealed containers and closed glass jars may explode and therefore should not be heated in this oven.
  - **Install or locate** this oven only in accordance with the provided installation instructions.
  - Use this appliance only for its intended use as described in this manual. Do not use corrosive chemicals or vapors in this appliance. This oven is specifically designed to heat or cook food. It is not designed for industrial or laboratory use.
  - As with any appliance, close supervision is necessary when used by children.
  - **Do not** operate this oven if it has a damaged cord or plug, if it is not working properly or if it has been damaged or dropped.
  - **This appliance** should be serviced only by qualified service technicians. Contact the nearest authorized service facility for examination, repair or adjustment.
  - **Do not** cover or block any vents on the oven.
  - **Do not** store or use this appliance outdoors.
  - **Do not** use this oven near water, near a kitchen sink, in a wet basement or near a swimming pool, and the like.
  - **Do not** immerse cord or plug in water.
  - **Keep** cord away from heated surfaces.
  - **Do not** let cord hang over edge of table or counter.
  - **When cleaning** surfaces of door and oven that comes together on closing the door, use only mild, nonabrasive soaps or detergents applied with a sponge or soft cloth. See page 26.

## SAVE THESE INSTRUCTIONS

## ELECTRICAL GROUNDING INSTRUCTIONS

---



### DANGER

#### Electric Shock Hazard

- Touching some of the internal components can cause serious personal injury or death. Do not disassemble this appliance.



### WARNING

#### Electric Shock Hazard

- Improper use of the grounding plug can result in electric shock. Do not plug into an outlet until appliance is properly installed and grounded.

This appliance must be grounded. If there is an electrical short circuit, grounding reduces the risk of electric shock by providing an escape wire for the electric current. This appliance is equipped with a cord that has a grounding wire with a grounding plug. The plug must be plugged into an outlet that is properly installed and grounded.

Consult a qualified electrician if the grounding instructions are not completely understood as to whether the appliance is properly grounded.

A short power supply cord is provided to reduce the risk of becoming entangled in or tripping over a longer cord.

#### Properly polarized and grounded outlet

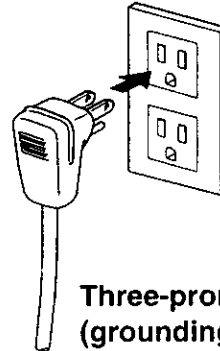

Three-pronged (grounding) plug

Longer cord sets or extension cords may be used with following precautions:

- The marked electrical rating of the cord set or extension cord should be equal to or higher than the electrical rating of the appliance.
- The extension cord must be a grounding type 3-wire cord.
- A longer cord should be arranged so that it will not drape over the countertop or tabletop where it can be pulled on by children or tripped over accidentally.

The electrical power cord must be kept dry and must not be pinched or crushed in any way.

## UTENSILS

---



### CAUTION

#### Personal Injury Hazard

- Tightly-closed utensils could explode. Closed containers are opened and plastic pouches pierced before cooking.

See following page for further instructions "Materials you can use in microwave oven or to be avoided in microwave oven."

#### Utensil Test:

1. Fill a microwave-safe container with 1 cup of cold water (250 mL) along with the utensil in question.
2. Cook on **maximum** power (P100) for 1 minute.
3. Carefully feel the utensil.

If the empty utensil is warm,  
Do not use them for Microwave Cooking.  
**Do not exceed 1 minute testing time.**

#### CAUTION:

1. Do not use plastic containers for testing.
2. Some containers and dishware may be warm (or hot) in only one area. Do not use a container that becomes warm anywhere.

## Materials you can use in microwave oven

Utensils	Remarks
Aluminum foil	Shielding only. Small smooth pieces can be used to cover thin parts of meat or poultry to prevent overcooking. <b>Arcing can occur if foil is too close to oven walls.</b> The foil should be at least 1 inch (2.5 cm) away from oven walls.
Browning dish	Follow manufacturer's instructions. The bottom of browning dish must be at least $\frac{3}{16}$ inch (5 mm) above the turntable. Incorrect usage may cause the turntable to break.
Dinnerware	Microwave-safe only. Follow manufacturer's instructions. Do not use cracked or chipped dishes.
Glass jars	Always remove lid. Use only to heat food until just warm. Most glass jars are not heat resistant and may break.
Glassware	Heat-resistant oven glassware only. Make sure there is no metallic trim. Do not use cracked or chipped dishes.
Oven cooking bags	Follow manufacturer's instructions. Do not close with metal tie. Make slits to allow steam to escape.
Paper plates and cups	Use for short-term cooking/warming only. Do not leave oven unattended while cooking.
Paper towels	Use to cover food for reheating and absorbing fat. Use with supervision for a short-term cooking only.
Parchment paper	Use as a cover to prevent spattering or a wrap for steaming.
Plastic	Microwave-safe only. Follow the manufacturer's instructions. Should be labeled "Microwave Safe" Some plastic containers soften as the food inside gets hot.
Plastic wrap	Microwave-safe only. Use to cover food during cooking to retain moisture. Do not allow plastic wrap to touch food. "Boiling bags" and tightly closed plastic bags should be slit, pierced or vented as directed by package.
Thermometers	Microwave-safe only (meat and candy thermometers).
Wax paper	Use as a cover to prevent spattering and to retain moisture.

## Materials to be avoided in microwave oven

Utensils	Remarks
Aluminum tray	May cause arcing. Transfer food into microwave-safe dish.
Food carton with metal handle	May cause arcing. Transfer food into microwave-safe dish.
Metal or metal-trimmed utensils	Metal shields the food from microwave energy. Metal trim may cause arcing.
Metal twist ties	May cause arcing and could cause a fire in the oven.
Paper bags	May cause a fire in the oven.
Plastic foam cups	Plastic foam may melt or contaminate the liquid inside when exposed to high temperature.
Wood	Wood will dry out when used in the microwave oven and may split or crack.

# ASSEMBLY

## NAMES OF OVEN PARTS AND ACCESSORIES

Remove the oven and all materials from the carton.

Your oven comes with the following accessories:

Turntable/ Turntable roller rest/ Owner's Manual

### Super EvenWave® System

The microwaves reach the embossments on the interior walls and then bounce in every direction. As a result, microwave energy will be reflected from many angles to cook and defrost more evenly and results in improved performance.

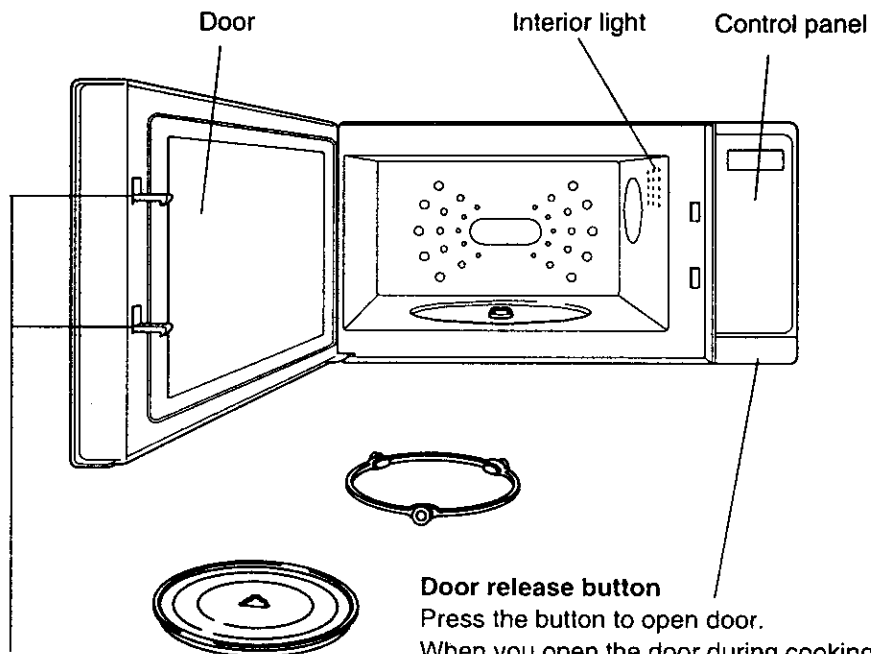
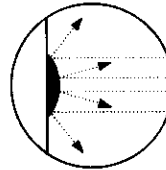

#### Safety interlock system

Shuts off oven power if door is opened during operation.

#### Door release button

Press the button to open door. When you open the door during cooking process, the cooking stops but the program will not be cancelled. Touch START to resume cooking.

## TURNTABLE INSTALLATION

- Place the roller rest on the cavity bottom.
- Turntable hub should be securely locked in the receptacle. **Never place the turntable upside down.**
- The turntable rotation should never be restricted.
- Place the turntable on top of the roller rest as shown in the diagram.
- Both turntable and roller rest must always be used during cooking.
- All food and containers of food are always placed on this turntable for cooking.
- This turntable rotates clockwise or counterclockwise; this is normal.

**CAUTION:** The inside of the oven and turntable get very hot, so do not touch them immediately after use.

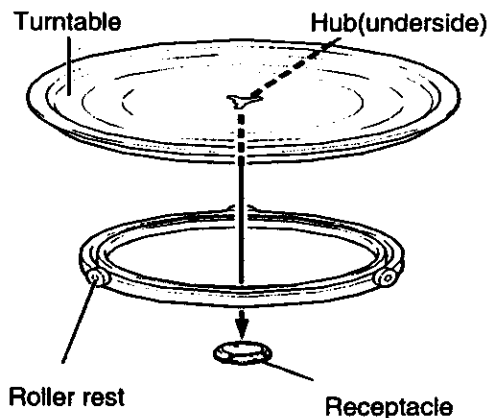



## INSTALLATION

Remove all packing material and accessories.

Examine the oven for any damage such as dents or broken door.

Do not install if oven is damaged.

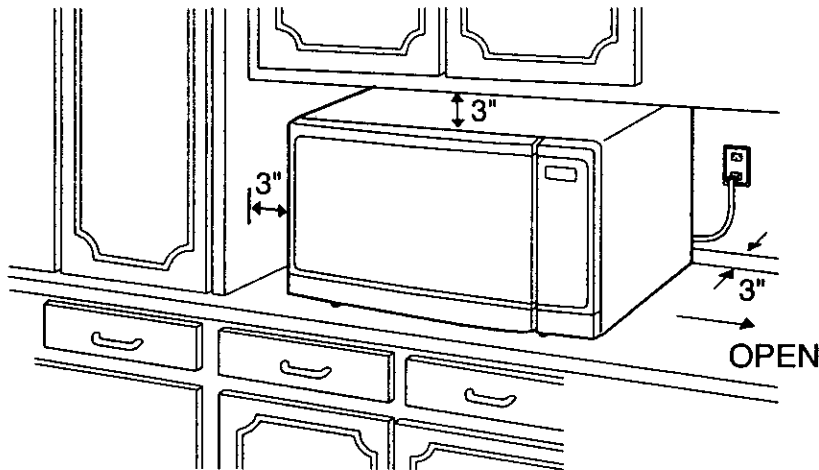

ASSEMBLY

1. Select a level surface that provides enough open space for the intake and/or outlet vents.

A minimum clearance of 3 inches (7.5 cm) is required between the oven and any adjacent wall. One side must be open.

- Leave a minimum clearance of 3 inches (7.5 cm) above the oven.
- Do not remove the legs from the bottom of the oven.
- Blocking the intake and/or outlet openings can damage the oven.
- Do not install oven over a range, cooktop or other heat-producing appliance.

2. Plug your oven into a standard 120-volt / 60-Hz household outlet.  
Be sure the electrical circuit is at least 15 amperes and that your microwave oven is the only appliance on the circuit.

### 27 inch Built-in Kit

Your oven can be built into a cabinet by using an optional built-in kit. Contact the store where you purchased your oven.

- The oven requires an opening of 25" (w) x 17" (h) x 21" (d) for installation.

**NOTE:** This unit is not designed for 50 Hz or any circuit other than a 120-volt/ 60-Hz AC circuit. This oven is designed for countertop or built-in installation.

Model No.	Built-in Kit Stock No.
565. 69300	20-69920
565. 69301	20-69921
565. 69400	20-69910
565. 69401	20-69911

- When using the built-in kit, a minimum clearance of 2 feet is required between the oven and heat-producing appliance. For example, next to or above a conventional gas or electric range or above conventional wall oven. Leave a minimum clearance of 2 feet around the oven. If installed near or over a heat source, the oven could be damaged and the warranty would be void.

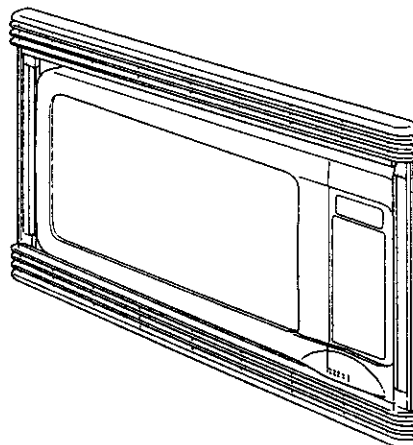

# OPERATION

## CONTROL PANEL AND FEATURES

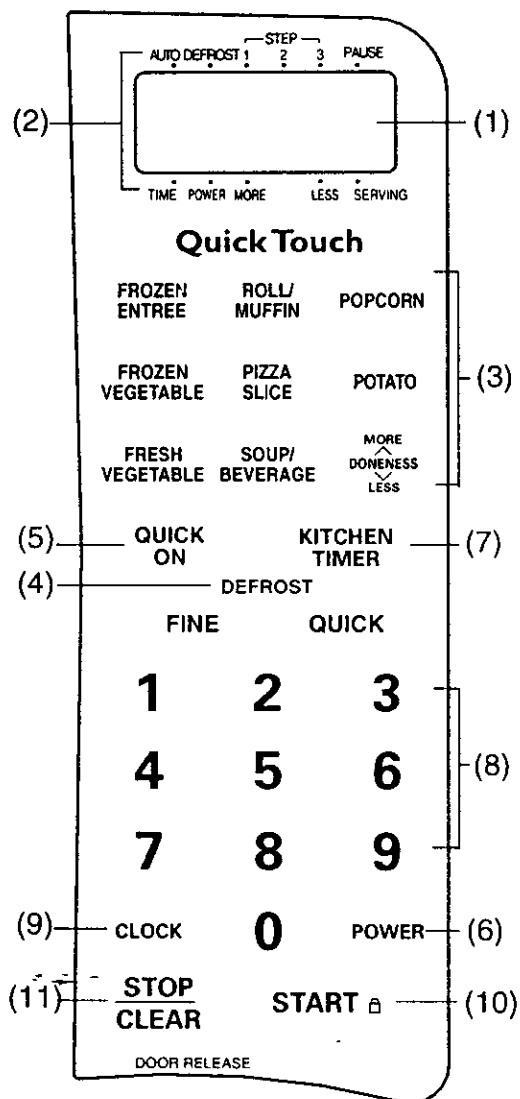

- (1) **Display Window**  
Counts down cooking time in seconds. Shows clock time when oven is not in use.
- (2) **Indicators**  
**STEP1/ STEP2/ STEP3:**  
Cooking stage indicators  
**AUTO/ DEFROST/ PAUSE:**  
Cooking mode indicators  
**TIME/ POWER/ SERVING/ LB/ oz.:**  
Lights or flashes to enter cooking time, power setting, food weight or number of servings.  
**MORE/LESS:**  
Lights to indicate MORE/LESS adjustment has been entered.
- (3) **Quick Touch™ keypads** (page 14)  
FROZEN ENTREE  
ROLL/MUFFIN  
POPCORN  
FROZEN VEGETABLE  
PIZZA SLICE  
POTATO  
FRESH VEGETABLE  
SOUP/BEVERAGE  
**MORE/LESS**  
Used to adjust cooking time for Quick Touch™ keypad.
- Auto keypads**
- (4) **Auto Defrost by Weight** (page 15)  
FINE DEFROST: Provides thorough defrosting results.  
QUICK DEFROST: Provides faster defrosting when complete defrosting is less crucial. This defrost option is excellent for thawing items such as frozen ground meat for use in spaghetti sauce or for taco meat.
- (5) **QUICK ON** (page 17)
- (6) **POWER** (page 13)
- (7) **KITCHEN TIMER** (page 12)
- (8) **Number keys**
- (9) **CLOCK** (page 11)
- (10) **START**
- (11) **STOP/CLEAR**  
Clears all previous setting if pressed before cooking starts. During cooking: touch once to stop oven; twice to stop and clear all entries.

### Beep Sound

A beep sounds when a keypad is pressed, to confirm your key entry.

## SETTING CLOCK

To set the correct time of day, follow the steps as below.

**Example:** To set 3:15:

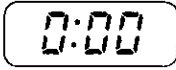
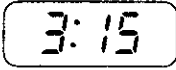
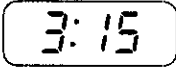
Step	Procedure	Keypad	Display
1	Touch <b>CLOCK</b> .	<b>CLOCK</b>	
2	Touch <b>3, 1, 5</b> to enter time of day.	<b>3 1 5</b>	
3	Touch <b>CLOCK</b> . The clock starts counting.	<b>CLOCK</b>	

- Note:**
- If the clock (or display) shows any abnormality, unplug the oven from the AC outlet. Plug it in again and then reset the clock.
  - When your oven is plugged in for the first time or when power resumes after a power interruption, the numbers in the display reset to 0:00.
  - This is a 12 hour clock.
  - You can use the oven without setting clock.

## CHILD LOCK-OUT

The oven has a safety feature which prevents use by children. The feature locks the operation of the oven until cancelled.

**To set:**

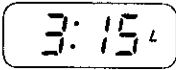
Step	Procedure	Keypad	Display
1	Touch <b>START</b> and hold for 4 seconds. L appears in the display.	<b>START</b> 	

- Note:**
- If any key is touched except **STOP/CLEAR, START, KITCHEN TIMER, CLOCK, E** appears and a beep sounds. To correct, touch **STOP/CLEAR**. Clock reappears in the display.

**To cancel:**

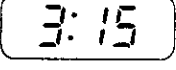
Step	Procedure	Keypad	Display
1	Touch <b>START</b> and hold for 4 seconds. L disappears from the display.	<b>START</b> 	



**Demo mode setting:** Touch **STOP/CLEAR** and hold for 4 seconds. L appears in the display. Microwave energy will not be produced during demo mode.

To cancel Demo mode, touch **STOP/CLEAR** and hold for 4 seconds. L disappears from the display.

## KITCHEN TIMER

You can use the Kitchen Timer function independently, even while a cooking program is going on in the oven.

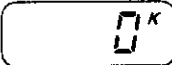
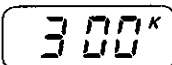
**Example:** To set timer for 3 minutes:

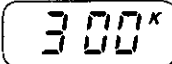
Step	Procedure	Keypad	Display
1	Touch <b>KITCHEN TIMER</b> .	<b>KITCHEN TIMER</b>	
2	Touch <b>3, 0</b> and <b>0</b> to set 3 minutes. (up to 99 minutes 99 seconds)	<b>3 0 0</b>	
3	Touch <b>START</b> . The timer starts counting and beeps sound for 7 seconds at the end.	<b>START</b> 	

- Note:**
- To check remaining timer time during cooking, touch **KITCHEN TIMER**. The remaining time appears in the display for 5 seconds.
  - To clear a timer setting, touch **STOP/CLEAR** while the display shows remaining timer time.
  - The indicator **K** flashes when the display shows a cooking time.
  - The indicator **K** lights when the display shows a timer time.
  - To stop beeps of Kitchen Timer, touch **KITCHEN TIMER**.
  - Kitchen Timer will not beep if the oven beeps at the same time to indicate another oven operation (the end of a cooking, for example).
  - If you do not enter a timer time for 10 seconds after step 1, the setting is cleared with a beep.
  - If a cooking completes while you are setting the Kitchen Timer, all settings are cleared. Restart from step 1.
  - If no key is touched for 5 seconds after the last key entry at step 2 above, the timer automatically starts.

## TIME COOKING

This basic microwave cooking method allows you to cook food for a desired time. In addition to the **P100** (maximum) power level, you can select different microwave power from 11 levels, **P 0** to **P100** (0-100% of total power level).

**Manual Defrosting** (Without using Auto Defrost feature):

Use power level **P 30**. To speed up the defrosting of dense foods over 1 lb (450 g), you may start on **P100 for 2 minutes**, then reduce to the level **P 30**.

**Delay Start Cooking:**

Use power level **P 0** for the first stage of multistage cooking. You can delay cooking start time by up to 99 minutes 99 seconds.

**Multistage Cooking**

You can program up to 3 stages of cooking in sequence. Each stage can be programmed with a different power and time setting. To program 2-stage or 3-stage cooking, repeat the Time Cooking steps 1 to 3 and touch **START**. The oven automatically proceeds to the end of cooking.

- When you cook on **P100** power for 1-stage, you must enter **POWER, 1** and **0**.  
You can not skip step 2, 3 when setting multistage cooking.

**Example:** To cook at power level P 80 for 40 seconds:

Step	Procedure	Keypad	Display																								
1	Enter 40 seconds by touching 4 and 0.	4 0																									
2	Touch <b>POWER</b> . Display prompt you to enter power level.	<b>POWER</b>																									
3	Touch <b>8</b> to enter power level P 80. <table border="1" style="margin: 5px auto;"> <thead> <tr> <th>Power level</th> <th>Press</th> </tr> </thead> <tbody> <tr><td>P100 (100%)</td><td>1,0</td></tr> <tr><td>P 90 (90%)</td><td>9</td></tr> <tr><td>P 80 (80%)</td><td>8</td></tr> <tr><td>P 70 (70%)</td><td>7</td></tr> <tr><td>P 60 (60%)</td><td>6</td></tr> <tr><td>P 50 (50%)</td><td>5</td></tr> <tr><td>P 40 (40%)</td><td>4</td></tr> <tr><td>P 30 (30%)</td><td>3</td></tr> <tr><td>P 20 (20%)</td><td>2</td></tr> <tr><td>P 10 (10%)</td><td>1</td></tr> <tr><td>P 0 (0%)</td><td>0</td></tr> </tbody> </table>	Power level	Press	P100 (100%)	1,0	P 90 (90%)	9	P 80 (80%)	8	P 70 (70%)	7	P 60 (60%)	6	P 50 (50%)	5	P 40 (40%)	4	P 30 (30%)	3	P 20 (20%)	2	P 10 (10%)	1	P 0 (0%)	0	8	
Power level	Press																										
P100 (100%)	1,0																										
P 90 (90%)	9																										
P 80 (80%)	8																										
P 70 (70%)	7																										
P 60 (60%)	6																										
P 50 (50%)	5																										
P 40 (40%)	4																										
P 30 (30%)	3																										
P 20 (20%)	2																										
P 10 (10%)	1																										
P 0 (0%)	0																										
4	Touch <b>START</b> .	<b>START</b>																									

**OPERATION**

- Note:**
- Cooking time can be set up to 99 minutes 99 seconds.
  - When you cook on **P100** power, skip step 2 and 3.
  - Foods with high moisture content should be cooked on **P100** power.
  - To check the power level during cooking, touch **POWER**.
  - Power level can also be entered by touching **POWER** keypad repeatedly until your desired power level appears in the display.



**POWER LEVEL SETTING GUIDE**

<b>P100</b> • Cooking poultry, vegetables, and most casseroles. Boiling water. • Preheating a browning dish.	<b>P 50</b> • Cooking custards and pasta. • Cooking rump roast, ham, veal, lamb.
<b>P 90</b> • Reheating rice and pasta.	<b>P 40</b> • Cooking less tender cuts of meat in liquid or slow-cooking dishes. • Completing the cooking cycle of less tender roasts.
<b>P 80</b> • Reheating precooked or prepared food quickly. • Cooking fish.	<b>P 30</b> • Completing the cooking cycle of casseroles, stews, sauces. • Manual defrosting.
<b>P 70</b> • Cooking cheese dishes.	<b>P 20</b> • Softening chocolate. • clarifying butter. • Heating breads, rolls, pancakes, tacos, tortillas, French toast.
<b>P 60</b> • Cooking scrambled eggs. • Baking cakes.	<b>P 10</b> • Softening cream cheese, butter. • Keeping casseroles warm.

## QUICK TOUCH™ COOKING

Quick Touch™ Cooking menu allow you to reheat or cook food automatically. Simply touch the appropriate keypad 1 - 3 times to select desired menu and touch **START**.

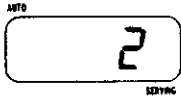
**Example:** To reheat 2 servings of soup:

Step	Procedure	Keypad	Display
1	Touch <b>SOUP/ BEVERAGE</b> twice to enter the number of serving.	<b>SOUP/ BEVERAGE</b>	
2	Touch <b>START</b> . The time counts down in the display.	<b>START</b> 	

### Quick Touch™ Cooking Serving sizes:

Touch menu pad	Press keypad		
	once	twice	3 times
<b>FROZEN ENTREE</b>	6 oz.	9 oz.	20 oz.
<b>ROLL/MUFFIN</b>	1 serving (4 oz.)	2 servings (8 oz.)	3 servings (12 oz.)
<b>POPCORN</b>	3.5 oz.	3.0 oz.	1.75 oz.
<b>FROZEN VEGETABLE</b>	5 oz.	10 oz.	16 oz.
<b>PIZZA SLICE</b>	1 slice (3 oz.)	2 slices (6 oz.)	3 slices (9 oz.)
<b>POTATO</b>	1 potato (6 oz.)	2 potatoes (12 oz.)	3 potatoes (18 oz.)
<b>FRESH VEGETABLE</b>	4 oz.	8 oz.	12 oz.
<b>SOUP/BEVERAGE</b>	1 serving (8 oz.)	2 servings (16 oz.)	3 servings (24 oz.)

### MORE/LESS KEY



Proper food doneness varies with each individual. After a few Quick Touch™ Cooking trials, you will learn which setting produces the best results for you. By using this pad, you can adjust cooking time for a longer or shorter time.

Touch **MORE/LESS** keypad before touching **START**.

- Touch keypad once: **MORE** cooking (longer cooking time: 8 - 25%)
- Touch keypad twice: **LESS** cooking (shorter cooking time: 8 - 25%)
- The oven automatically sets to medium doneness if no selection is made and/or by touching keypad three times.

**Note:** Time depends on each food.



## AUTOMATIC DEFROST BY WEIGHT

The best defrosting time and power levels are automatically determined depending on the food weight you enter. The feature provides two options:

**FINE DEFROST:** Use for thorough defrosting of frozen foods, when it is important to have the center section defrosted as well as the outside. Examples for recommended use are: whole chicken, roasts and steak.

**QUICK DEFROST:** Use to assist separation of frozen pieces of chicken or fish that need preparation prior to cooking. Also, this defrost option is excellent for thawing items such as frozen ground meat for use in spaghetti sauce or for taco meat.

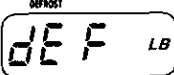
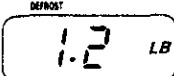
**Example:** To thoroughly defrost 1.2 lb of chicken pieces:

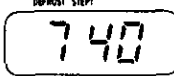
Step	Procedure	Keypad	Display																				
1	Touch <b>FINE DEFROST</b> .	<b>FINE</b>																					
2	Enter the weight of food. Weight must be programmed in pounds and tenth of a pound. <b>Conversion Chart</b> Convert oz. into tenths of a lb. e.g. 1 lb. 4 oz., program, 1.2 lbs.	<b>1 2</b>																					
	<table border="1"> <thead> <tr> <th>Ounces</th> <th>Tenths of a Pound</th> </tr> </thead> <tbody> <tr><td>1 - 2</td><td>0.1</td></tr> <tr><td>3 - 4</td><td>0.2</td></tr> <tr><td>5</td><td>0.3</td></tr> <tr><td>6 - 7</td><td>0.4</td></tr> <tr><td>8</td><td>0.5</td></tr> <tr><td>9 - 10</td><td>0.6</td></tr> <tr><td>11 - 12</td><td>0.7</td></tr> <tr><td>13</td><td>0.8</td></tr> <tr><td>14 - 15</td><td>0.9</td></tr> </tbody> </table>	Ounces	Tenths of a Pound	1 - 2	0.1	3 - 4	0.2	5	0.3	6 - 7	0.4	8	0.5	9 - 10	0.6	11 - 12	0.7	13	0.8	14 - 15	0.9		
Ounces	Tenths of a Pound																						
1 - 2	0.1																						
3 - 4	0.2																						
5	0.3																						
6 - 7	0.4																						
8	0.5																						
9 - 10	0.6																						
11 - 12	0.7																						
13	0.8																						
14 - 15	0.9																						
3	Touch <b>START</b> . Total defrost time appears in the display.	<b>START</b> 																					

OPERATION

### Defrosting Techniques:

- Remove food from wrapper to prevent holding steam and juice and place in a microwave-safe baking dish or a roasting rack to catch drippings.
- Cover thin parts with aluminum foil to prevent overdefrosting.
- Because some food should be still icy in center, it is necessary to have standing time after defrosting food in the oven to complete defrosting. Leave your food for a while out of oven. The denser the food such as roasts, the longer standing time is required.

**Note:** • Weight can be entered up to 5.9 lbs. If weight is entered more than 5.9 lbs and press **START**, a beep sounds to alert you to enter correct weight.

- The oven selects 1lb if a weight is not entered.
- **Beep tone sounds 5 seconds during the defrosting cycle to signal that food should be rearranged to improve defrosting performance.** Open the door and rearrange the food. The oven continues the defrosting cycle to the end if you do not open the door.
- Food can be defrosted in a styrofoam package.

## DEFROSTING CHART

It is necessary to have standing time after defrosting food in the oven to complete defrosting. The denser the food such as roasts, the longer standing time is required. Following are standing time for each food for your reference.



Item	During Defrosting	Standing time
<b>Beef</b>		
Ground beef	Turn over. Remove defrosted portion.	5 - 10 min.
Liver	Drain liquid. Separate pieces.	10 - 15 min.
Roasts	Turn over. Cover ends with foil.	20 - 40 min.
Sirloin steak	Turn over.	5 - 10 min.
Rib or T-bone	Turn over.	10 - 20 min.
Flank steak	Turn over.	5 - 10 min.
Stewing meat	Break apart.	5 - 10 min.
<b>Pork</b>		
Ground pork	Turn over. Remove defrosted portion.	5 - 10 min.
Bacon	Defrost in original wrapper. Turn over.	3 - 5 min.
Chops	Separate and turn over.	5 - 10 min.
Ribs	Turn over.	10 - 20 min.
Roasts	Turn over. Cover ends with foil.	20 - 40 min.
<b>Lamb</b>		
Ground lamb	Turn over. Remove defrosted portion.	5 - 10 min.
Chops	Separate. Turn over.	5 - 10 min.
Ribs	Turn over.	10 - 20 min.
Roasts	Turn over. Cover end with foil.	20 - 40 min.
<b>Poultry</b>		
Chicken, whole	Turn over. Cover ends with foil. Rinse under cold water after defrosting.	15 - 30 min.
Pteees	Separate. Turn over.	10 - 15 min.
Cornish hens	Turn over. Cover ends with foil. Rinse under cold water after defrosting.	15 - 30 min.
<b>Fish and Seafood</b>		
Crabmeat, Shrimp	Break apart.	5 - 10 min.
Fish fillets	Turn over. Rearrange. Rinse under cold water to separate after defrosting.	5 - 10 min.
Fish whole	Turn over. Cover head and tail with foil.	5 - 10 min.
Steaks	Turn over.	5 - 10 min.
Scallops	Break apart. Remove defrosted seafood.	5 - 10 min.



## QUICK-ON COOKING (P100 POWER)

A time-saving feature, this simplified control lets you quickly set and start microwave cooking without the need to touch **START**.

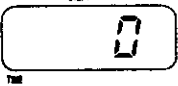
**Example:** To set Quick-On cooking for 2 minutes:

Step	Procedure	Keypad	Display						
1	Touch <b>QUICK ON</b> .	<b>QUICK ON</b>							
2	Touch 2. The display shows time counting down.	<b>2</b>							
	<table border="1"> <thead> <tr> <th>Touch</th> <th>Cooking time</th> </tr> </thead> <tbody> <tr> <td>0</td> <td>30 seconds</td> </tr> <tr> <td>1 - 9</td> <td>1 - 9 minutes</td> </tr> </tbody> </table>	Touch	Cooking time	0	30 seconds	1 - 9	1 - 9 minutes		
Touch	Cooking time								
0	30 seconds								
1 - 9	1 - 9 minutes								

**Note:** This feature only cook at highest power level (P100).

### QUICK-ON REHEATING AND COOKING CHART

Reheating	Amount	Time	Special Notes
<b>Meat</b>			
Chili, stews	2 cups (500 g)	3 - 4 min.	Place in microwave-safe dish. Cover. Stir halfway through cooking time.
Hamburgers, meat loaf slices	1 serving 2 servings	1/2 - 1 min. 1 - 2 min.	Place on microwave-safe plate. Cover with paper towel. Turn over once.
<b>Poultry</b>			
Chicken pieces	2 4	1 - 2 min. 2 - 3 min.	Heat on microwave-safe plate. Cover with wax paper. If fried, cover with paper towel.
Chicken, turkey, sliced	3 - 5 oz. (85 - 140 g)	1 - 2 min.	Heat on microwave-safe plate. Cover with wax paper.
<b>Seafood</b>			
Shrimp, crab, or scallops in sauce, frozen	6 1/2 oz. (185 g)	3 - 5 min.	Pierce pouch and place on microwave-safe plate. Flex pouch to mix halfway through cooking time.
<b>Cooked rice, pasta</b>	1 cup (250 mL) 2 cups (500 mL)	1 - 2 min. 2 - 3 min.	Heat in microwave-safe casserole, covered with plastic wrap.
<b>Canned vegetable</b>	8 oz. (230 g) 15 oz. (425 g)	1 - 2 min. 2 - 3 min.	Use microwave-safe casserole, covered. Stir once.
Cooking	Amount	Time	Special Notes
<b>Mashed potatoes instant</b>	4 servings	3 - 5 min.	Follow package directions. Reduce liquid by 1 tbsp (15 mL).
<b>Pudding and pie filling mix</b>	3 1/4 oz. (90 g)	4 - 6 min.	Follow package directions. Stir once.
<b>Cereals</b>			
Cream of wheat (regular)	1/4 cup (50 mL)	1 - 2 min.	Add 3/4 cup (175 mL) of water. Cook uncovered. Stir once. Let stand for 1 minute.

OPERATION

# COOKING GUIDE

## COOKING TECHNIQUES

Advantages of microwave cooking are speed and efficiency. For warming, heating, and defrosting, nothing compares. There are a few tips that will make microwaving easier and more enjoyable.

### Microwave Cooking Principles

Because microwave cooking requires only one-quarter to one-third the time of conventional cooking, the same cooking principles become even more important.

### Quantity

The more food being cooked, the longer you will have to cook it. As a general rule, when doubling a recipe, increase the cooking time by about 50 percent. When cutting a recipe in half, reduce the time by about 40 percent.

### Density

Dense foods, such as potatoes, roasts and carrots, absorb microwave energy less quickly than porous foods such as ground beef or mashed potatoes. Therefore, denser foods take longer to cook.

### Shape and Size

Small pieces cook faster than large ones. For even cooking, it is important to have all the pieces the same size. Evenly shaped pieces, round or doughnut shaped, microwave best. When cooking items of varying thickness, arrange the thick portion near the outer edge of the dish.

### Moisture, Sugar and Fat

Food high in moisture, sugar or fat cook faster than foods that are low in these substances. Add a minimum of liquid to moist foods. An excess amount of water slows cooking.

### Starting Temperature

Frozen or refrigerated foods take longer to microwave than food at room temperature.

### Delicate Ingredients

Some foods require special attention when cooked in the microwave oven. Delicate foods such as eggs, cheese, mayonnaise, etc. cook so quickly, they should be watched carefully.

### Microwave Cooking Techniques

**Arranging:** Arrange foods in a circular pattern, when possible.

**Piercing:** Pierce the membrane of foods such as eggs, oysters, snails, sausages, livers, clams and whole vegetables, so they do not burst.

**Covering:** Covering speeds heating and prevents spattering.

**Stirring:** To help food cook more quickly and evenly.

**Turning Over:** To help larger foods such as roasts or whole chickens cook more evenly.

**Reheating:** Place food that is denser/larger/thicker to the outer edge and the smaller/thinner or more porous food to the center.

**Shielding:** To prevent overcooking, thin or bony areas can be protected with small strips of aluminum foil.

**Standing Time:** Foods continue cooking even after removal from the oven. Standing time is necessary to allow foods to complete cooking.

### Converting Recipes

Microwave recipes will likely call for less liquid and cooking time.

### Safety Food Temperatures

For your safety, following temperature is recommended to avoid potential food poisoning problems.

160°F (71°C): Meat, Fish, Eggs

165°F (74°C): Reheating foods

170°F (77°C): Poultry (White Meat)

180°F (82°C): Poultry (Dark Meat)

## QUICK TOUCH™ COOKING

### COOKING/REHEATING TIPS

#### FROZEN ENTREE

- Follow package directions for removing or venting cover, piercing pouch, replacing foil, covering with plastic wrap, etc.
- Frozen foods with special packaging to "crisp" foods such as pizza, french fries and pocket-type sandwiches should be cooked according to manufacturer's directions.
- Place a microwave-safe plate underneath if the package contains a cheese sauce in the product (macaroni and cheese, for example) that could spill over during heating.

#### ROLL/MUFFIN

- Place on a paper plate or paper towel.
- Roll/Muffin must be room or refrigeration temperature.
- If frozen, defrost 30 - 40 seconds per serving at power level P 30 using Manual defrosting.

#### POPCORN

- Bag should be at room temperature.
- Do not use this feature if popcorn bag size is not 3.5 oz, 3.0 oz or 1.75 oz.

#### FROZEN VEGETABLE

- Follow package directions for adding water, piercing pouch, cooking in dish, venting package, etc.

#### Frozen Vegetables in a pouch :

Remove frozen vegetables from package and place them in a microwave-safe casserole or dish.

#### PIZZA SLICE

- Place on a paper plate.
- Pizza must be room or refrigerated temperature.

#### POTATO

- Pierce with fork.  
Place on a paper towel.  
Let stand 3 - 5 minutes after cooking.
- Arrange in a circular pattern with heavier ends pointing toward the outer edge of the turntable.
- Potatoes must be room temperature.
- Do not place potato in the center of oven when cooking.

#### FRESH VEGETABLE

- Place in a bowl or dish.  
Add 1 tablespoon water per serving.  
Cover.
- Weight shown is for washed, prepared vegetables.

#### SOUP/BEVERAGE

- Liquid must be room or refrigeration temperature.
- When cooking canned soups, remove from can.  
Add milk or water as directed on can.  
Place in a microwave-safe dish.  
Cover.

COOKING GUIDE

### Quick Touch™ Cooking/Reheating Guide

Item/ Amount	Press keypad	Special Notes
Lasagna Macaroni and Cheese	<b>FROZEN ENTREE</b>	Follow package directions.
Popcorn 3.5 oz (100 g) 3.0 oz (85 g) 1.75 oz (50 g)	<b>POPCORN</b>	<b>CAUTION:</b> 1)After popping, open bag carefully. Popcorn and steam are extremely hot. 2)Do not reheat unpopped kernels or reuse bag. Overcooking can result in an oven fire. 3)Never use a brown paper bag for popping corn.

## QUICK TOUCH™ COOKING (CONT.)

### Quick Touch™ Cooking/Reheating Guide

Item/ Amount	Press keypad	Special Notes
Broccoli, Brussels sprouts, Carrots, Corn, Cauliflower, Green beans, Peas, Spinach, or a mixture of these. 5, 10, 16 oz	<b>FROZEN VEGETABLE</b>	Follow package directions for adding water, piercing pouch, cooking in a dish, venting package, etc.
Cooked pizza 1 - 3 slices (3 - 9 oz)	<b>PIZZA SLICE</b>	Place on paper towel or paper plate or leave in uncovered cardboard box, points toward center. <b>CAUTION:</b> Be careful when eating pizza. The pizza surface and sauce can be very hot.
Potatoes, white, baking, 1 - 3 potatoes	<b>POTATO</b>	Pierce skin. Place on a paper towel.
Artichokes, Beans, Broccoli, Brussels sprouts, Cabbage, Carrots, Corn, Cauliflower, Eggplant, Mushrooms, Onion, Okra, Peas, Spinach, Squash, Zucchini, or a mixture of these. 4, 8, 12 oz	<b>FRESH VEGETABLE</b>	Wash. Prepare and cut into slices, cubes, wedges, or julienne strips. Place in a bowl or dish. Add 1 tablespoon water per serving. Cover.
Coffee/Tea (8 - 24 oz) 1 - 3 cups	<b>SOUP/ BEVERAGE</b>	No cover. Stir after reheating.
Soup (8 - 24 oz) 1 - 3 servings	<b>SOUP/ BEVERAGE</b>	Cover. Stir after reheating.
Milk (8 - 24 oz) 1 - 3 cups	<b>SOUP/ BEVERAGE</b>	No cover. Stir after reheating. For hot chocolate, etc.
Hamburger buns, hot dog rolls (4 - 12oz) 1 - 3 servings	<b>ROLL/MUFFIN</b>	Place on paper plate or wrap in paper towel.
Doughnuts, sweet rolls, muffins (4 - 12oz) 1 - 3 servings	<b>ROLL/MUFFIN</b>	Place on paper plate or towel.

## TIME COOKING - APPETIZERS AND RICE

### CONVERTING RECIPES

Most hot appetizers adapt well to microwave cooking, the exception being those wrapped in pastry. Pastry requires the hot environment of the conventional oven to become crisp.

- Toppings for canapés can be made ahead and then placed on bread or crackers just before heating. This guarantees crispness.

- Cover appetizers or dips only when called for by a recipe. Use casserole lids, wax paper, plastic wrap, or paper towel.
- Appetizers and dips that contain cheese, mayonnaise and other delicate ingredients are usually heated on power level P 10. A higher setting might cause separation or drying.

### Reheating Guide - Convenience Appetizers

Item	Power	Cooking Time	Special Notes
Meat spread 4 oz (115 g)	P 80	1 - 1½ min.	Transfer to small microwave-safe bowl.
Cocktail franks 4 servings	P 70	½ - 1½ min.	Place on paper towel. Cover with wax paper.
Dips, cream ½ cup (125 mL)	P 10	2 - 3 min.	Cover with wax paper.
Egg rolls 12 (6 oz - 170 g)	P 70	1 - 2 min.	Place on paper towel or paper plate.
Mini Tacos 4 - 6 (6 oz - 170 g)	P 50	1 - 2 min.	Place on paper towel or paper plate.

**COOKING GUIDE**

### Cooking Guide - Rice

1 cup (250 mL) rice (Use 3-quart (3 L) microwave-safe casserole. Heat water 4 to 7 min. to boil. Add rice, salt and butter or margarine. Cover tightly. Let stand for 5 minutes.)

Item	Water	Power	Cooking Time
Long grain	1¾ cups (425 mL)	P 30	20 - 25 min.
Short grain	1½ cups (375 mL)	P 30	22 - 27 min.

## TIME COOKING - MEATS, POULTRY AND FISH

### PREPARATION

- Use a microwave-safe dish, etc.
- Defrost Frozen foods completely.
- Wash poultry and fish in cool water.
- Arrange small items in a single layer in dish, avoid overlapping edges of food.
- Place thick sections toward edge of the dish.
- Use a rack in the dish to elevate meat out of the juices.
- Use spices, seasonings as desired.
- Add salt after cooking if necessary.
- Aluminum foils can be used to cover thin parts of meat or poultry wings and legs to prevent overcooking.
- Foils should be applied toward the end of cooking time.
- Place meat fat side down.

### COOKING

- Use wax paper or plastic wrap to stop splattering.
- Turn over or rearrange meat, poultry and fish halfway through cooking time.

### CHECKING DONENESS

**Beef:** The color inside meat indicates doneness. Rare roast should be red inside. Medium is pink and gray indicates well done.

**Pork:** Cooked pork meat should be gray with clear juice.

**Poultry:** Juices should be clear yellow when cooked. Legs should move freely.

**Fish and Seafood:** Should be opaque in color and flake easily.

To check internal temperature of various meats and poultry, use a microwave or conventional meat thermometer after removing meat from the oven. Insert the thermometer avoiding bone or fat. Lower temperatures are found in the center of the roast or in the muscle close to a large bone. **Never use a conventional meat thermometer in the microwave oven.**

Return undercooked food to oven for a short period of time at the recommended power level. Let stand as recommended in chart. Cover roasts and whole poultry during stand time.

Food	Power	Cooking Time	Stand Time	Special Notes	
<b>Beef</b> 4 oz (115 g) each Hamburgers, refrigerated	2	P100	2 - 4 min.	Cook in a shallow dish. Cover loosely with wax paper. Turn over halfway through cooking.	
	4	P100	4 - 6 min.		
	Hamburgers, frozen	2	P100		4 - 6 min.
		4	P100		7 - 9 min.
Roasts, tender 1 lb (450 g)	P 50	10 - 13 min.	10 - 15 min.	Cover with wax paper. Shield halfway through cooking and turn roast over if necessary. Stand tented with foil.	

Food	Power	Cooking Time	Stand Time	Special Notes
<b>Beef</b> Meat loaf, 1 1/2 lb (680 g)	P 50	15 - 20 min.	5 min.	Arrange in loaf dish. Cover with wax paper.
<b>Pork</b> Chops, loin 1/2 inch (1 cm) thick, 7 oz (200 g) each				Place in a shallow dish. Cover loosely with wax paper. Turn over halfway through cooking .
1	P100	3 - 5 min.	2 min.	
2	P100	6 - 8 min.	3 min.	
4	P100	9 - 11 min.	3 min.	
Pork roast, 1 lb (450 g)	P 50	12 - 15 min.	10 - 15 min.	Cover with wax paper. Shield halfway through cooking and turn roast over if necessary. *Approx. temp. after stand 170°F to 175°F (77°C to 79°C )
Ham, slice 1 inch (2.5 cm) thick, 1 lb (450 g)	P100	7 - 9 min.	5 min.	Cover with wax paper. Turn over halfway through cooking.
Sausage links, Wieners, fresh 1-2oz(30-55g) each				Score or pierce before cooking. Cover with wax paper. Turn over once.
2	P100	1/2 - 2 min.	1 min.	
4	P100	1 - 3 min.	1 min.	
Bacon, slices				Cook on bacon rack or line bottom of dish. Place bacon on paper towel. Cover loosely with another paper towel. Do not turn over bacon.
2	P100	1 1/2 - 2 min.	1 min.	
4	P100	2 1/2 - 4 min.	1 min.	
<b>Lamb</b> Chops, shoulder 1/2-inch-(1 cm) thick				Cover loosely with wax paper.
1	P100	2 - 4 min.	2 min.	
2	P100	4 - 6 min.	5 min.	
<b>Poultry</b> Chickens, whole, up to 4 lb (1.8 kg) 1 lb (450 g) Cornish hens 1 lb (450 g)				Place breast-side down on a roasting rack in a dish. Cover with plastic wrap or wax paper. Turn over halfway through cooking. Stand tented with foil. When cooked, internal temperature should be 180°F (82°C) and juices should run clear.
	P100	6 - 9 min.	10 min.	
	P100	5 - 8 min.	10 min.	

\*Check with conventional thermometer.

Food	Power	Cooking Time	Stand Time	Special Notes
<b>Poultry</b> Chicken pieces, up to 2 lb (900 g) 1 lb (450 g)	P100	5 - 8 min.	5 min.	Arrange skin-side up in a baking dish halfway through cooking, meatier portions toward edge of dish. Cover with plastic wrap or lid.
<b>Fish and Seafood</b> Fish fillets, $\frac{3}{4}$ lb (340 g) Fish steaks 2, 6 oz (170 g) each Scallops 1 lb (450 g) Shrimp, medium size, shelled and cleaned, 1 lb (450 g) Whole fish, stuffed or unstuffed, $1\frac{1}{2}$ to $1\frac{3}{4}$ lb (680 - 800 g)	P100 P 50 P 70 P 70 P100	4 - 6 min. 6 - 9 min. 4 - 7 min. 4 - 7 min. 7 - 10 min.	3 min. 5 min. 3 min. 3 min. 5 min.	Arrange in a single layer in dish. Cover with wax paper. Rearrange or stir shrimp or scallops halfway through cooking.

## TIME COOKING - EGGS

### SCRAMBLED EGGS

Break eggs into a microwave-safe glass measure.

Add 1 tablespoon milk and 1 teaspoon butter for each egg. Beat with a fork.

Cook at **Power Level P 60** according to time in the chart. Stir at least once during cooking time.

Stir after cooking, and let stand for 1 minute.

Eggs	Cooking Time
1	$\frac{3}{4}$ - $1\frac{1}{2}$ min.
2	$1\frac{1}{2}$ - $2\frac{1}{2}$ min.
3	$2\frac{1}{4}$ - 4 min.
4	$3\frac{1}{4}$ - 5 min.

### POACHED EGGS

Use 6-ounce (170 mL) microwave-safe custard cup with  $\frac{1}{4}$  cup (50 mL) water for 1 to 3 eggs.

Use 1-quart (1 L) microwave-safe dish with 1 cup (250 mL) water for 4 eggs.

Heat at **P100 POWER** to bring water to a boil with  $\frac{1}{8}$  teaspoon salt and up to  $\frac{1}{4}$  teaspoon vinegar. Break egg carefully into hot water.

Pierce egg several times lightly with toothpick.

Cover with wax paper.

Cook at **Power Level P 50** according to time in the chart. Let stand, covered, 1 minute before serving.

Eggs	Cooking Time
1	$\frac{3}{4}$ - $1\frac{1}{2}$ min.
2	$1\frac{1}{2}$ - 3 min.
3	2 - $3\frac{1}{2}$ min.
4	3 - 5 min.



## TIME COOKING - BAKED GOODS AND DESSERTS

### Converting Recipes

When adapting quick bread recipes, you will find it necessary to reduce the amount of leavening (baking powder or soda) by about one-quarter the normal amount. A bitter aftertaste is apparent if too much leavening is used in biscuits or muffins. Since food rises higher in the microwave oven, you will not see a loss in volume from the reduction of soda or baking powder.

If a recipe contains buttermilk or sour cream, do not change the amount of soda, since it serves to counteract the sour taste and does not act only as a leavening agent.

When using a mix where leavening cannot be reduced, allow the dough to stand about 10 minutes before cooking in order for some of the gas to be lost.

Breads and rolls should be reheated only until they are warm to the touch. Overheating or overcooking makes bread tough and rubbery.

### Cooking/Reheating Guide

Item	Power	Cooking Time	Special Notes
French bread, Frozen: 1 lb (450 g) Room temp.: 1 lb (450 g)	P 80 P 80	1 - 2 min. 20 - 30 sec.	Place on paper plate or towel.
Whole coffee cake, Frozen: 10 - 13 oz (280 - 370 g) Room temp.: 10 - 13 oz (280 - 370 g)	P 80 P 80	1 - 2 min. 1/2 - 1 min.	Place on paper plate or towel. Let stand for 5 - 10 minutes before serving.
Butter cake 2 1/4 cups (550 mL) batter 1st stage 2nd stage	P 50 P100	5 - 7 min. 1 - 2 min.	Place on inverted pie plate.
Brownies 2 cups (500 mL) batter	P 50	8 - 11 min.	Cover with wax paper. Place on inverted pie plate.
Muffins, 1/4 cup (50 mL) batter each 2 6	P 70 P 70	1 - 1 1/2 min. 3 - 4 min.	

COOKING GUIDE

# MAINTENANCE

## CLEANING

Wipe the oven inside and outside with a soft cloth and a mild detergent solution. Then rinse and wipe dry. Never use cleaning powders or rough pads. Excessive oil splatters on the inside top will be difficult to remove if left for many days. Wipe splatters with a wet paper towel, especially after cooking chicken or bacon.

### REMOVABLE PARTS

Wash in warm (not hot) water with a mild detergent and a soft cloth. Rinse them well and dry with a soft cloth. Never use cleaning powders, steel wool or rough pads.

- The turntable may be cleaned at the sink. Be careful not to chip or scratch the edges as this may cause the turntable to break during use.

- The turntable roller rest should be cleaned regularly.

### SPECIAL CARE

For best performance and safety, the inner door panel and the oven front frame should be free of food or grease buildup. Wipe them often with a mild detergent. Then rinse and wipe dry. Never use cleaning powders or rough pads.

After cleaning the control panel, touch STOP/CLEAR to clear any entries that might have been entered accidentally while cleaning the panel.



### CAUTION -

#### Product Damage Hazard

Uncleaned cavity cover (located in the right side wall of the oven cavity) will cause fire, burn or sparking. Clean your oven with wet towel.

## SEARS SERVICE

### “WE SERVICE WHAT WE SELL”

“We Service What We Sell” is our assurance to you that you can depend on Sears for service because Sears Service is nationwide.

Your Sears Kenmore® Microwave Oven has added value when you consider that Sears has a service unit near you, staffed by Sears Trained Technicians-professional technicians specifically trained on Sears Kenmore® Microwave Ovens, having the parts, tools and equipment to insure that we meet our pledge to you-“We Service What We Sell!”

### TO FURTHER ADD TO THE VALUE OF YOUR MICROWAVE OVEN, BUY A SEARS MAINTENANCE AGREEMENT.

Sears Kenmore® Microwave Ovens are designed, manufactured, and tested for years of dependable operation. Yet, any modern appliance may require service from time to time. A Sears Maintenance Agreement is more than an extension of the Warranty.

It provides complete protection from unexpected repair bills and undue

inconvenience. It assures you of maximum efficiency from your Microwave Oven.

Here's a comparative warranty and Maintenance Agreement chart showing you the benefits of a Sears Microwave Oven Maintenance Agreement.

Years of Ownership Coverage	1 st Yr.	2 nd Yr. thru 5 th Yr.
Replacement of defective parts other than magnetron	W	MA
Replacement of magnetron	W	W
Annual preventive maintenance check at your request	MA	MA

W - WARRANTY

MA - MAINTENANCE AGREEMENT

Contact your Sears salesperson or local Sears Service Center today and purchase a Sears Maintenance Agreement.

## TROUBLESHOOTING

Check your problem by using the chart below and try the solutions for each problem. If the microwave oven still does not work properly, contact the nearest authorized service center.

TROUBLE	CAUSE	REMEDY
When the oven is plugged into a wall outlet for the first time, it does not work properly.	<ul style="list-style-type: none"> <li>The microcomputer used in the oven control may temporarily become scrambled and fail to function as programmed.</li> </ul>	<ul style="list-style-type: none"> <li>Unplug the oven from the wall outlet and then plug it back in.</li> </ul>
Light reflection around the outer case.	<ul style="list-style-type: none"> <li>This light is from the oven light located outside the oven cavity.</li> </ul>	-
Noise coming from the turntable when the oven is turned on.	<ul style="list-style-type: none"> <li>Noise occurs when the turntable roller rest and cavity bottom are dirty.</li> </ul>	<ul style="list-style-type: none"> <li>Clean the turntable roller rest cavity bottom.</li> </ul>
How are the boil-overs avoided.	<ul style="list-style-type: none"> <li>Small utensil is used.</li> </ul>	<ul style="list-style-type: none"> <li>Use a larger utensil than usual for cooking.</li> </ul>
Noise coming from the oven when reducing power.	<ul style="list-style-type: none"> <li>When cooking with a power other than P100, the oven cycle to obtain the lower power level. The clicking noise can be heard when the oven cycles. This is normal.</li> </ul>	-
Oven will not start.	<ul style="list-style-type: none"> <li>Electrical cord for oven is not plugged in.</li> <li>Door is open.</li> <li>Wrong operation is set.</li> </ul>	<ul style="list-style-type: none"> <li>Plug into the outlet.</li> <li>Close the door and try again.</li> <li>Check instructions, (pages 11-17)</li> </ul>
E (error) appears in the display window.	<ul style="list-style-type: none"> <li>Wrong operation is set.</li> </ul>	<ul style="list-style-type: none"> <li>Touch STOP/CLEAR.</li> </ul>
Arcing or sparking.	<ul style="list-style-type: none"> <li>Materials to be avoided in microwave oven are used.</li> <li>The oven is operated when empty.</li> <li>Food refuse remains in the cavity or inside the cavity is uncleaned.</li> </ul>	<ul style="list-style-type: none"> <li>Use microwave-safe cookware only. (page 7)</li> <li>Do not operate with oven empty.</li> <li>Clean cavity with wet towel.</li> </ul>
Unevenly cooked foods.	<ul style="list-style-type: none"> <li>Materials to be avoided in microwave oven are used.</li> <li>Food is not defrosted completely.</li> <li>Cooking time/Cooking power level is not suitable.</li> <li>Food is not turned or stirred.</li> </ul>	<ul style="list-style-type: none"> <li>Use microwave-safe cookware only. (page 7)</li> <li>Completely defrost food.</li> <li>Use correct time/cooking power level.</li> <li>Turn or stir food.</li> </ul>

**MAINTENANCE**

TROUBLE	CAUSE	REMEDY
Overcooked foods.	<ul style="list-style-type: none"> <li>• Cooking time/Cooking power level is not suitable.</li> </ul>	<ul style="list-style-type: none"> <li>• Use correct cooking time/ cooking power level.</li> </ul>
Undercooked foods.	<ul style="list-style-type: none"> <li>• Materials to be avoided in microwave oven are used.</li> <li>• Food is not defrosted completely.</li> <li>• Oven ventilation ports are restricted.</li> <li>• Cooking time/Cooking power level is not suitable.</li> </ul>	<ul style="list-style-type: none"> <li>• Use microwave-safe cookware only. (page 7)</li> <li>• Completely defrost food.</li> <li>• Check to see that oven ventilation ports are not restricted.</li> <li>• Use correct time/cooking power level.</li> </ul>
Improper defrosting.	<ul style="list-style-type: none"> <li>• Materials to be avoided in microwave oven are used.</li> <li>• Cooking time/Cooking power level is not suitable.</li> <li>• Food is not turned or stirred.</li> </ul>	<ul style="list-style-type: none"> <li>• Use microwave-safe cookware only. (page 7)</li> <li>• Use correct time/cooking power level.</li> <li>• Turn or stir food.</li> </ul>
Oven light will not glow.	<ul style="list-style-type: none"> <li>• The light bulb has burned out.</li> <li>• START has not been touched.</li> </ul>	<ul style="list-style-type: none"> <li>• Contact your nearest Sears Service Center. See Back cover for phone numbers.</li> <li>• Touch START.</li> </ul>
Eggs sometimes pop.	<ul style="list-style-type: none"> <li>• The egg yolk may pop because of steam build-up inside the membrane.</li> </ul>	<ul style="list-style-type: none"> <li>• Pierce the membrane with a toothpick before cooking it.</li> </ul>
Steam coming out of the air exhaust vent.	<ul style="list-style-type: none"> <li>• Steam is produced during cooking. The microwave oven has been made to vent this steam.</li> </ul>	



**For in-home major brand repair service:**

Call 24 hours a day, 7 days a week

**1-800-4-MY-HOME<sup>SM</sup> (1-800-469-4663)**

**Para pedir servicio de reparación a domicilio - 1-800-676-5811**

In Canada for all your service and parts needs call

Au Canada pour tout le service ou les pièces - **1-800-665-4455**

**For the repair or replacement parts you need:**

Call 7 am - 7 pm, 7 days a week

**1-800-366-PART (1-800-366-7278)**

**Para ordenar piezas con entrega a domicilio - 1-800-659-7084**

**For the location of a Sears Parts and Service Center in your area:**

Call 24 hours a day, 7 days a week

**1-800-488-1222**

**For information on purchasing a Sears Maintenance Agreement  
or to inquire about an existing Agreement:**

Call 9 am - 5 pm, Monday - Saturday

**1-800-827-6655**



**The Service Side of Sears<sup>SM</sup>**

## Free Manuals Download Website

<http://myh66.com>

<http://usermanuals.us>

<http://www.somanuals.com>

<http://www.4manuals.cc>

<http://www.manual-lib.com>

<http://www.404manual.com>

<http://www.luxmanual.com>

<http://aubethermostatmanual.com>

Golf course search by state

<http://golfingnear.com>

Email search by domain

<http://emailbydomain.com>

Auto manuals search

<http://auto.somanuals.com>

TV manuals search

<http://tv.somanuals.com>