

P5KPL-VM

The ASUS logo is positioned in the top right corner of the page. It consists of the word "ASUS" in a bold, black, sans-serif font, with a registered trademark symbol (®) to its upper right.

Motherboard

E3286

First Edition

July 2007

Copyright © 2007 ASUSTeK COMPUTER INC. All Rights Reserved.

No part of this manual, including the products and software described in it, may be reproduced, transmitted, transcribed, stored in a retrieval system, or translated into any language in any form or by any means, except documentation kept by the purchaser for backup purposes, without the express written permission of ASUSTeK COMPUTER INC. ("ASUS").

Product warranty or service will not be extended if: (1) the product is repaired, modified or altered, unless such repair, modification or alteration is authorized in writing by ASUS; or (2) the serial number of the product is defaced or missing.

ASUS PROVIDES THIS MANUAL "AS IS" WITHOUT WARRANTY OF ANY KIND, EITHER EXPRESS OR IMPLIED, INCLUDING BUT NOT LIMITED TO THE IMPLIED WARRANTIES OR CONDITIONS OF MERCHANTABILITY OR FITNESS FOR A PARTICULAR PURPOSE. IN NO EVENT SHALL ASUS, ITS DIRECTORS, OFFICERS, EMPLOYEES OR AGENTS BE LIABLE FOR ANY INDIRECT, SPECIAL, INCIDENTAL, OR CONSEQUENTIAL DAMAGES (INCLUDING DAMAGES FOR LOSS OF PROFITS, LOSS OF BUSINESS, LOSS OF USE OR DATA, INTERRUPTION OF BUSINESS AND THE LIKE), EVEN IF ASUS HAS BEEN ADVISED OF THE POSSIBILITY OF SUCH DAMAGES ARISING FROM ANY DEFECT OR ERROR IN THIS MANUAL OR PRODUCT.

SPECIFICATIONS AND INFORMATION CONTAINED IN THIS MANUAL ARE FURNISHED FOR INFORMATIONAL USE ONLY, AND ARE SUBJECT TO CHANGE AT ANY TIME WITHOUT NOTICE, AND SHOULD NOT BE CONSTRUED AS A COMMITMENT BY ASUS. ASUS ASSUMES NO RESPONSIBILITY OR LIABILITY FOR ANY ERRORS OR INACCURACIES THAT MAY APPEAR IN THIS MANUAL, INCLUDING THE PRODUCTS AND SOFTWARE DESCRIBED IN IT.

Products and corporate names appearing in this manual may or may not be registered trademarks or copyrights of their respective companies, and are used only for identification or explanation and to the owners' benefit, without intent to infringe.

Contents

Notices.....	vi
Safety information	vii
P5KPL-VM specifications summary.....	x
Chapter 1: Product introduction	
1.1 Welcome!	1-2
1.2 Package contents	1-2
1.3 Special features	1-2
1.3.1 Product highlights	1-2
1.3.2 ASUS Special features	1-4
1.4 Before you proceed	1-5
1.5 Motherboard overview	1-6
1.5.1 Placement direction	1-6
1.5.2 Screw holes	1-6
1.5.3 Motherboard layout.....	1-7
1.5.4 Layout contents.....	1-8
1.6 Central Processing Unit (CPU)	1-9
1.6.1 Installing the CPU	1-10
1.6.2 Installing the CPU heatsink and fan.....	1-12
1.6.3 Uninstalling the CPU heatsink and fan	1-14
1.7 System memory	1-16
1.7.1 Overview	1-16
1.7.2 Memory configurations.....	1-17
1.7.3 Installing a DIMM	1-21
1.7.4 Removing a DIMM	1-21
1.8 Expansion slots	1-22
1.8.1 Installing an expansion card	1-22
1.8.2 Configuring an expansion card	1-22
1.8.3 Interrupt assignments	1-23
1.8.4 PCI slots.....	1-24
1.8.5 PCI Express x1 slot.....	1-24
1.8.6 PCI Express x16 slot.....	1-24
1.9 Jumpers	1-25
1.10 Connectors	1-27
1.10.1 Rear panel connectors.....	1-27
1.10.2 Internal connectors	1-29

Contents

Chapter 2: BIOS setup

2.1	Managing and updating your BIOS	2-2
2.1.1	Creating a bootable floppy disk	2-2
2.1.2	ASUS EZ Flash 2 utility	2-3
2.1.3	AFUDOS utility	2-4
2.1.4	ASUS CrashFree BIOS 3 utility	2-6
2.1.5	ASUS Update utility	2-8
2.2	BIOS setup program	2-11
2.2.1	BIOS menu screen	2-12
2.2.2	Menu bar	2-12
2.2.3	Navigation keys	2-12
2.2.4	Menu items	2-13
2.2.5	Sub-menu items	2-13
2.2.6	Configuration fields	2-13
2.2.7	Pop-up window	2-13
2.2.8	Scroll bar	2-13
2.2.9	General help	2-13
2.3	Main menu	2-14
2.3.1	System Time	2-14
2.3.2	System Date	2-14
2.3.3	Legacy Diskette A	2-14
2.3.4	Primary, Third, and Fourth IDE Master/Slave	2-15
2.3.5	IDE Configuration	2-16
2.3.6	System Information	2-17
2.4	Advanced menu	2-18
2.4.1	Jumperfree Configuration	2-18
2.4.2	USB Configuration	2-19
2.4.3	CPU Configuration	2-21
2.4.4	Chipset	2-23
2.4.5	Onboard Devices Configuration	2-25
2.4.6	PCI PnP	2-26
2.5	Power menu	2-27
2.5.1	Suspend Mode	2-27
2.5.2	ACPI 2.0 Support	2-27
2.5.3	ACPI APIC Support	2-27

Contents

2.5.4	APM Configuration	2-28
2.5.5	Hardware Monitor	2-29
2.6	Boot menu	2-30
2.6.1	Boot Device Priority	2-30
2.6.2	Boot Settings Configuration	2-31
2.6.3	Security	2-32
2.7	Tools menu	2-34
2.7.1	ASUS EZ Flash 2.....	2-34
2.8	Exit menu	2-35

Chapter 3: Software support

3.1	Installing an operating system	3-2
3.2	Support CD information	3-2
3.2.1	Running the support CD	3-2
3.2.2	Drivers menu.....	3-3
3.2.3	Utilities menu	3-4
3.2.4	ASUS Contact information.....	3-5

Appendix: CPU features

A.1	Intel® EM64T.....	A-2
A.2	Enhanced Intel SpeedStep® Technology (EIST).....	A-2
A.2.1	System requirements	A-2
A.2.2	Using the EIST	A-3
A.3	Intel® Hyper-Threading Technology	A-4
	Using the Hyper-Threading Technology	A-4

Notices

Federal Communications Commission Statement

This device complies with Part 15 of the FCC Rules. Operation is subject to the following two conditions:

- This device may not cause harmful interference, and
- This device must accept any interference received including interference that may cause undesired operation.

This equipment has been tested and found to comply with the limits for a Class B digital device, pursuant to Part 15 of the FCC Rules. These limits are designed to provide reasonable protection against harmful interference in a residential installation. This equipment generates, uses and can radiate radio frequency energy and, if not installed and used in accordance with manufacturer's instructions, may cause harmful interference to radio communications. However, there is no guarantee that interference will not occur in a particular installation. If this equipment does cause harmful interference to radio or television reception, which can be determined by turning the equipment off and on, the user is encouraged to try to correct the interference by one or more of the following measures:

- Reorient or relocate the receiving antenna.
- Increase the separation between the equipment and receiver.
- Connect the equipment to an outlet on a circuit different from that to which the receiver is connected.
- Consult the dealer or an experienced radio/TV technician for help.



The use of shielded cables for connection of the monitor to the graphics card is required to assure compliance with FCC regulations. Changes or modifications to this unit not expressly approved by the party responsible for compliance could void the user's authority to operate this equipment.

Canadian Department of Communications Statement

This digital apparatus does not exceed the Class B limits for radio noise emissions from digital apparatus set out in the Radio Interference Regulations of the Canadian Department of Communications.

This class B digital apparatus complies with Canadian ICES-003.

Safety information

Electrical safety

- To prevent electrical shock hazard, disconnect the power cable from the electrical outlet before relocating the system.
- When adding or removing devices to or from the system, ensure that the power cables for the devices are unplugged before the signal cables are connected. If possible, disconnect all power cables from the existing system before you add a device.
- Before connecting or removing signal cables from the motherboard, ensure that all power cables are unplugged.
- Seek professional assistance before using an adapter or extension cord. These devices could interrupt the grounding circuit.
- Make sure that your power supply is set to the correct voltage in your area. If you are not sure about the voltage of the electrical outlet you are using, contact your local power company.
- If the power supply is broken, do not try to fix it by yourself. Contact a qualified service technician or your retailer.

Operation safety

- Before installing the motherboard and adding devices on it, carefully read all the manuals that came with the package.
- Before using the product, make sure all cables are correctly connected and the power cables are not damaged. If you detect any damage, contact your dealer immediately.
- To avoid short circuits, keep paper clips, screws, and staples away from connectors, slots, sockets and circuitry.
- Avoid dust, humidity, and temperature extremes. Do not place the product in any area where it may become wet.
- Place the product on a stable surface.
- If you encounter technical problems with the product, contact a qualified service technician or your retailer.

About this guide

This user guide contains the information you need when installing and configuring the motherboard.

How this guide is organized

This manual contains the following parts:

- **Chapter 1: Product introduction**
This chapter describes the features of the motherboard and the new technology it supports. It also lists the hardware setup procedures that you have to perform when installing system components. It includes description of the jumpers and connectors on the motherboard.
- **Chapter 2: BIOS setup**
This chapter tells how to change system settings through the BIOS Setup menus. Detailed descriptions of the BIOS parameters are also provided.
- **Chapter 3: Software support**
This chapter describes the contents of the support CD that comes with the motherboard package.
- **Appendix: CPU features**
This Appendix describes the CPU features that the motherboard supports.

Where to find more information

Refer to the following sources for additional information and for product and software updates.

1. **ASUS websites**
The ASUS website provides updated information on ASUS hardware and software products. Refer to the ASUS contact information.
2. **Optional documentation**
Your product package may include optional documentation, such as warranty flyers, that may have been added by your dealer. These documents are not part of the standard package.

Conventions used in this guide

To make sure that you perform certain tasks properly, take note of the following symbols used throughout this manual.



DANGER/WARNING: Information to prevent injury to yourself when trying to complete a task.



CAUTION: Information to prevent damage to the components when trying to complete a task.



IMPORTANT: Instructions that you **MUST** follow to complete a task.



NOTE: Tips and additional information to help you complete a task.

Typography

Bold text

Indicates a menu or an item to select.

Italics

Used to emphasize a word or a phrase.

<Key>

Keys enclosed in the less-than and greater-than sign means that you must press the enclosed key.

Example: <Enter> means that you must press the Enter or Return key.

<Key1>+<Key2>+<Key3>

If you must press two or more keys simultaneously, the key names are linked with a plus sign (+).

Example: <Ctrl>+<Alt>+<D>

Command

Means that you must type the command exactly as shown, then supply the required item or value enclosed in brackets.

Example: At the DOS prompt, type the command line:

```
afudos /i [filename]
```

```
afudos /iP5KPLVM.ROM
```

P5KPL-VM specifications summary

CPU	LGA775 socket for Intel® Core™2 Quad/ Core™2 Extreme / Core™2 Duo / Pentium® D / Pentium® 4 / Celeron® D Processors Compatible with Intel® 05B/05A/06 processors Supports Intel® next generation 45nm CPU Intel® Hyper-Threading Technology ready (Refer to www.asus.com for Intel CPU support list)
Chipset	Northbridge: Intel® G31 Southbridge: Intel® ICH7
Front Side Bus	1333 (overclocking) / 1066 / 800 MHz
Memory	Dual channel memory architecture 2 x 240-pin DIMM sockets supports unbuffered non-ECC 4GB 800/667 MHz DDR2 memory modules
Expansion Slots	1 x PCI Express x16 slot 1 x PCI Express x1 slot 2 x PCI slots
VGA	Integrated Intel® Graphics Media Accelerator 3100 (Intel® GMA 3100) supports <ul style="list-style-type: none"> - High Definition Video Processing - Maximum resolution of 2048 x 1536 bpp(@75Hz) - Maximum shared memory of 256MB
Storage	Southbridge Intel® ICH7 supports: <ul style="list-style-type: none"> - 1 x UltraDMA 100/66/33 hard disk drives - 4 x SATA 3 Gb/s ports
LAN	PCIE Gigabit LAN controller
Audio	Realtek® ALC 662 6-channel High Definition Audio CODEC Supports Jack-detect, S/PDIF out interface, Anti Pop Function Compatible with Vista Premium OS
USB	Max. 8 x USB2.0 ports (4 ports at mid-board, 4 ports at back panel)
ASUS Features	ASUS CrashFree BIOS 3 ASUS Q-Fan ASUS EZ Flash 2 ASUS MyLogo 2
Rear panel	1 x PS/2 keyboard port 1 x PS/2 mouse port 1 x Parallel port 1 x VGA port 1 x COM 1 x LAN (RJ-45) port 4 x USB 2.0 ports 6-channel audio I/O port

(continued on the next page)

P5KPL-VM specifications summary

Internal connectors	2 x USB 2.0 connectors supports additional 4 USB 2.0 ports 1 x Floppy disk drive connector 1 x IDE connector for two devices 4 x Serial ATA connectors 1 x Internal Speaker connector 1 x CPU fan connector 1 x Chassis fan connector 1 x Power fan connector 1 x S/PDIF Out connector 1 x Chassis intrusion connector 1 x Front panel audio connector 1 x CD audio in connector 1 x 24-pin EPS 12 V power connector 1 x 4-pin ATX 12 V power connector System panel connector
BIOS features	8 Mb Flash ROM, AMI BIOS, PnP, DMI2.0, WfM2.0, SM BIOS 2.5
Manageability	WOL, PXE, RPL, WOR, PME, ACPI 3.0
Support CD contents	Drivers ASUS PC Probe II ASUS Update utility Anti-virus software
Accessories	1 x Serial ATA cable 1 x Serial ATA power cable 1 x UltraDMA 100/66/33 cable 1 x Floppy disk drive cable I/O shield User manual
Form factor	MicroATX form factor: 9.6 in x 8 in (24.5 cm x 20.3 cm)

*Specifications are subject to change without notice.

This chapter describes the motherboard features and the new technologies it supports.

1 Product introduction

1.1 Welcome!

Thank you for buying an ASUS® P5KPL-VM motherboard!

The motherboard delivers a host of new features and latest technologies, making it another standout in the long line of ASUS quality motherboards!

Before you start installing the motherboard, and hardware devices on it, check the items in your package with the list below.

1.2 Package contents

Check your motherboard package for the following items.

Motherboard	ASUS P5KPL-VM
Cables	1 x Ultra DMA 100/66/33 cable 1 x SATA cable 1 x SATA power cable 1 x Floppy disk drive cable
Accessories	I/O shield
Application CD	ASUS motherboard support CD
Documentation	User guide



If any of the above items is damaged or missing, contact your retailer.

1.3 Special features

1.3.1 Product highlights

Green ASUS



This motherboard and its packaging comply with the European Union's Restriction on the use of Hazardous Substances (RoHS). This is in line with the ASUS vision of creating environment-friendly and recyclable products/packaging to safeguard consumers' health while minimizing the impact on the environment.

LGA775 Intel® Quad-core Processor Ready



This motherboard supports the latest powerful and energy efficient processors from Intel. Intel® Quad-core is based on the Intel Core Microarchitecture process technology that allows users to step up to new levels of gaming experience and multi-tasking performance.

Combined with 1333 (overclocking) / 1066 / 800 of front side bus (FSB), this motherboard guarantees enhanced user experience in the digital home and office.

Intel® Core™2 Processor Ready



This motherboard supports the latest Intel® Core™2 processor in the LGA775 package. With the new Intel® Core™ microarchitecture technology and 1333 (overclocking) / 1066 / 800 MHz FSB, the Intel® Core™2 processor is designed to provide powerful and energy efficient performance.

Intel® G31 chipset



The Intel® G31 Express Chipset boosts your gaming and multimedia experience with integrated graphic engine Intel® Graphics Media Accelerator 3100. It supports 1066 / 800 MHz front side bus (FSB), and delivers breakthrough advances in 3D and 2D graphics, and video capabilities. This integrated chipset contains one 16-lane PCI Express port intended for an external PCI Express graphics card and provides the interface for processor in the 775-land package, dual channel DDR2 at speeds up to 800 MHz.

DDR2 memory support



The motherboard supports DDR2 memory that features data transfer rates of 667/800 MHz to meet the higher bandwidth requirements of the latest 3D graphics, multimedia, and Internet applications. The dual-channel DDR2 architecture doubles the bandwidth of your system memory to boost system performance, eliminating bottlenecks with peak bandwidths of up to 12.8 GB/s. Without restriction to the memory size across the two channels, the motherboard allows you to install DIMMs with different memory size and enjoy dual-channel feature at the same time. See page 1-16 for details.

Serial ATA 3 Gb/s technology



This motherboard supports the next-generation hard drives based on the Serial ATA (SATA) 3Gb/s storage specification, delivering enhanced scalability and doubling the bus bandwidth for high-speed data retrieval and saves. Easily backup photos, videos and other entertainment contents to external devices. See page 1-31 for details.

High Definition Audio



Enjoy high-end sound quality on your PC! The onboard 6-channel HD audio (High Definition Audio, previously codenamed Azalia) CODEC enables high-quality 192KHz/24-bit audio output, jack-detect feature.

1.3.2 ASUS Special features

ASUS Q-Fan technology



The ASUS Q-Fan technology smartly adjusts the fan speeds according to the system loading to ensure quiet, cool, and efficient operation.

See page 2-29 for details.

ASUS MyLogo2™



This feature allows you to convert your favorite photo into a 256-color boot logo for a more colorful and vivid image on your screen. See page 2-31 for details.

ASUS EZ Flash 2



EZ Flash 2 is a user-friendly BIOS update utility. Simply press the predefined hotkey to launch the utility and update the BIOS without entering the OS. Update your BIOS easily without preparing a bootable diskette or using an OS-based flash utility. See page 2-3 for details.

ASUS CrashFree BIOS 3



The ASUS CrashFree BIOS 3 allows users to restore corrupted BIOS data from a USB flash disk containing the BIOS file. See page 2-6 for details.

1.4 Before you proceed

Take note of the following precautions before you install motherboard components or change any motherboard settings.



- Unplug the power cord from the wall socket before touching any component.
- Use a grounded wrist strap or touch a safely grounded object or a metal object, such as the power supply case, before handling components to avoid damaging them due to static electricity.
- Hold components by the edges to avoid touching the ICs on them.
- Whenever you uninstall any component, place it on a grounded antistatic pad or in the bag that came with the component.
- Before you install or remove any component, ensure that the ATX power supply is switched off or the power cord is detached from the power supply. Failure to do so may cause severe damage to the motherboard, peripherals, and/or components.

Onboard LED

The motherboard comes with a standby power LED that lights up to indicate that the system is ON, in sleep mode, or in soft-off mode. This is a reminder that you should shut down the system and unplug the power cable before removing or plugging in any motherboard component. The illustration below shows the location of the onboard LED.

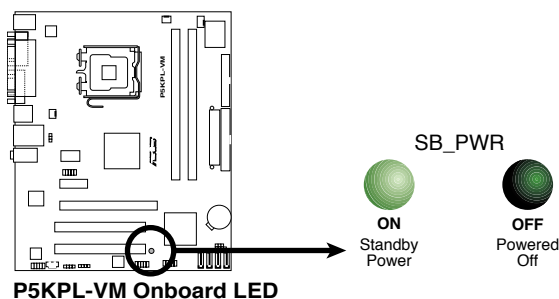

1.5 Motherboard overview

Before you install the motherboard, study the configuration of your chassis to ensure that the motherboard fits into it.



Make sure to unplug the power cord before installing or removing the motherboard. Failure to do so can cause you physical injury and damage motherboard components.

1.5.1 Placement direction

When installing the motherboard, make sure that you place it into the chassis in the correct orientation. The edge with external ports goes to the rear part of the chassis as indicated in the image below.

1.5.2 Screw holes

Place six (6) screws into the holes indicated by circles to secure the motherboard to the chassis.



Do not overtighten the screws! Doing so can damage the motherboard.

Place this side towards the rear of the chassis

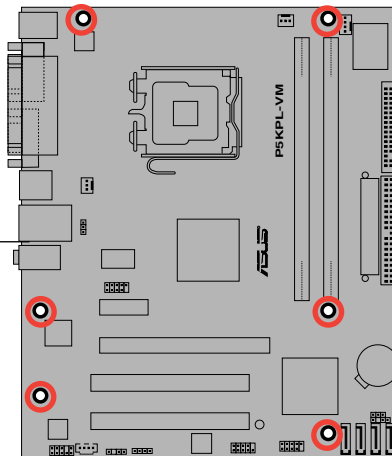

1.5.3 Motherboard layout

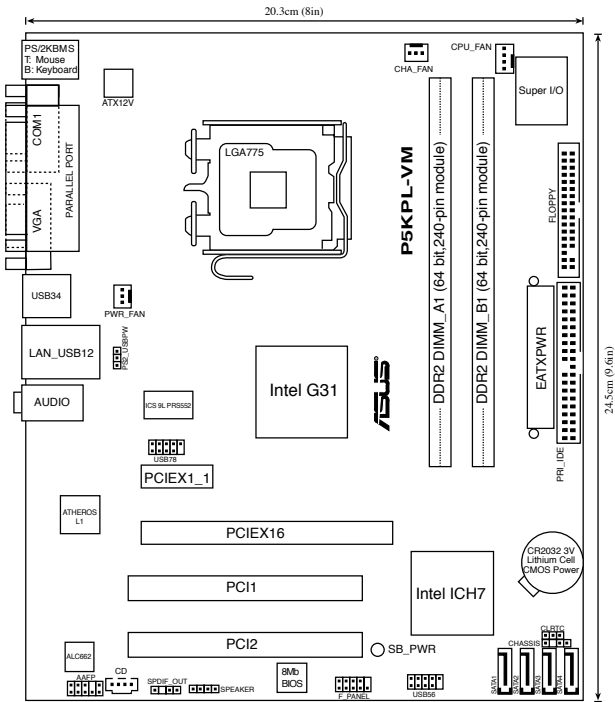

Refer to section 1.10 Connectors for more information about rear panel connectors and internal connectors.

1.5.4 Layout contents

Slots	Page
1. DDR2 DIMM slots	1-16
2. PCI slots	1-24
3. PCI Express x1 slot	1-24
4. PCI Express x16 slot	1-24

Jumper	Page
1. Clear RTC RAM (3-pin CLRRTC)	1-25
2. USB device wake-up (3-pin PS2_USBPW)	1-26

Rear panel connectors	Page
1. PS/2 mouse port (green)	1-27
2. Parallel port	1-27
3. LAN (RJ-45) port	1-27
4. Line In port (light blue)	1-27
5. Line Out port (lime)	1-27
6. Microphone port (pink)	1-27
7. USB 2.0 ports 1 and 2	1-28
8. USB 2.0 ports 3 and 4	1-28
9. VGA port	1-28
10. Serial port	1-28
11. PS/2 keyboard port (purple)	1-28

Internal connectors	Page
1. Floppy disk drive connector (34-1 pin FLOPPY)	1-29
2. Digital Audio connector (4-1 pin SPDIF_OUT)	1-29
3. IDE connector (40-1 pin PRI_IDE)	1-30
4. ICH7 Serial ATA connectors (7-pin SATA1, SATA2, SATA3, SATA4)	1-31
5. Speaker connector (4 pin SPEAKER)	1-31
6. USB connectors (10-1 pin USB56, USB78)	1-32
7. Optical drive audio connector (4-pin CD)	1-32
8. CPU, chassis and power fan connectors (4-pin CPU_FAN, 3-pin CHA_FAN, 3-pin PWR_FAN)	1-33
9. Chassis intrusion connector (4-1 pin CHASSIS)	1-34
10. Front panel audio connector (10-1 pin AAFP)	1-34
11. ATX power connectors (24-pin EATXPWR, 4-pin ATX 12V)	1-35
12. System panel connector (10-1 pin F_PANEL)	1-36

1.6 Central Processing Unit (CPU)

The motherboard comes with a surface mount LGA775 socket designed for the Intel® Core™2 Quad/ Core™2 Extreme/Core™2 Duo/Pentium® D/Pentium® 4 and Celeron® D processors.



-
- Make sure the AC power is off before you install the CPU.
 - If installing a dual-core CPU, connect the chassis fan cable to the chassis fan connector to ensure system stability.
-



-
- Upon purchase of the motherboard, make sure that the PnP cap is on the socket and the socket contacts are not bent. Contact your retailer immediately if the PnP cap is missing, or if you see any damage to the PnP cap/socket contacts/motherboard components. ASUS will shoulder the cost of repair only if the damage is shipment/transit-related.
 - Keep the cap after installing the motherboard. ASUS will process Return Merchandise Authorization (RMA) requests only if the motherboard comes with the cap on the LGA775 socket.
 - The product warranty does not cover damage to the socket contacts resulting from incorrect CPU installation/removal, or misplacement/loss/incorrect removal of the PnP cap.
-

1.6.1 Installing the CPU

To install a CPU:

1. Locate the CPU socket on the motherboard.

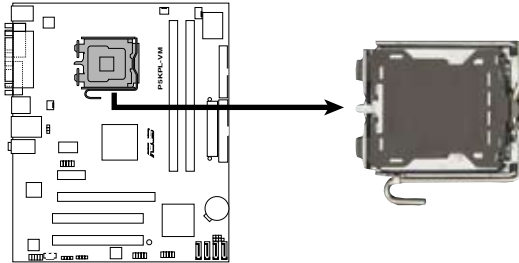

P5KPL-VM CPU Socket 775



Before installing the CPU, make sure that the cam box is facing towards you and the load lever is on your left.

2. Press the load lever with your thumb (A), then move it to the left (B) until it is released from the retention tab.

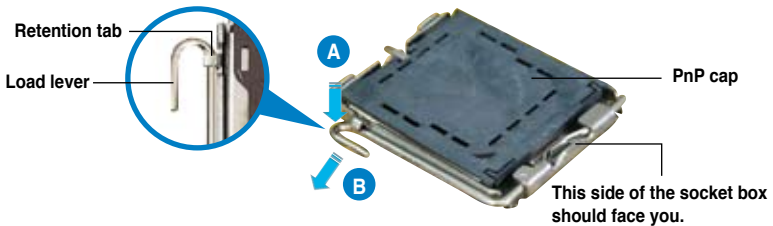

To prevent damage to the socket pins, do not remove the PnP cap unless you are installing a CPU.

3. Lift the load lever in the direction of the arrow to a 135° angle.

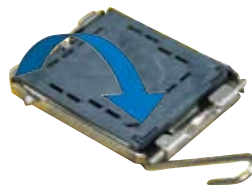

- Lift the load plate with your thumb and forefinger to a 100° angle (A), then push the PnP cap from the load plate window to remove (B).

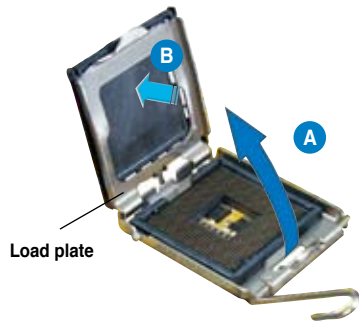

- Position the CPU over the socket, making sure that the gold triangle is on the bottom-left corner of the socket then fit the socket alignment key into the CPU notch.

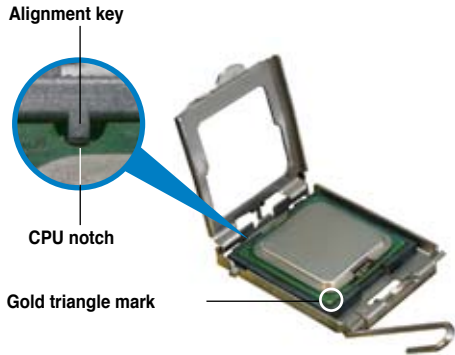

The CPU fits in only one correct orientation. DO NOT force the CPU into the socket to prevent bending the connectors on the socket and damaging the CPU!

- Close the load plate (A), then push the load lever (B) until it snaps into the retention tab.
- If installing a dual-core CPU, connect the chassis fan cable to the chassis fan connector to ensure system stability.

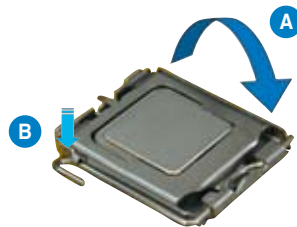

The motherboard supports Intel® LGA775 processors with Hyper-Threading Technology. Refer to the Appendix for more information on these CPU features.

1.6.2 Installing the CPU heatsink and fan

The Intel® LGA775 processor requires a specially designed heatsink and fan assembly to ensure optimum thermal condition and performance.



- When you buy a boxed Intel® processor, the package includes the CPU fan and heatsink assembly. If you buy a CPU separately, make sure that you use only Intel®-certified multi-directional heatsink and fan.
- Your Intel® LGA775 heatsink and fan assembly comes in a push-pin design and requires no tool to install.
- If you purchased a separate CPU heatsink and fan assembly, make sure that you have properly applied Thermal Interface Material to the CPU heatsink or CPU before you install the heatsink and fan assembly.



Make sure that you have installed the motherboard to the chassis before you install the CPU fan and heatsink assembly.

To install the CPU heatsink and fan:

1. Place the heatsink on top of the installed CPU, making sure that the four fasteners match the holes on the motherboard.



Orient the heatsink and fan assembly such that the CPU fan cable is closest to the CPU fan connector.



Motherboard hole

Fastener

Narrow end of the groove



Make sure to orient each fastener with the narrow end of the groove pointing outward. (The photo shows the groove shaded for emphasis.)

2. Push down two fasteners at a time in a diagonal sequence to secure the heatsink and fan assembly in place.

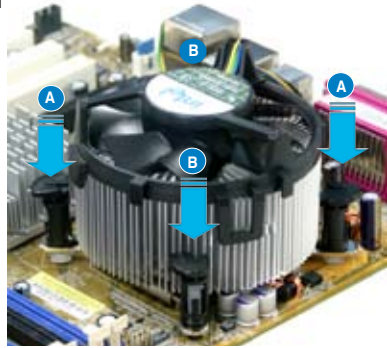
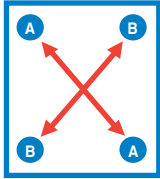

3. Connect the CPU fan cable to the connector on the motherboard labeled CPU_FAN.

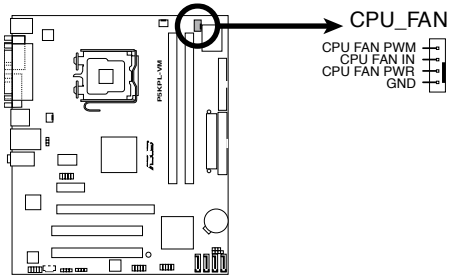

P5KPL-VM CPU Fan Connector



Do not forget to connect the CPU fan connector! Hardware monitoring errors can occur if you fail to plug this connector.

1.6.3 Uninstalling the CPU heatsink and fan

To uninstall the CPU heatsink and fan:

1. Disconnect the CPU fan cable from the connector on the motherboard.
2. Rotate each fastener counterclockwise.

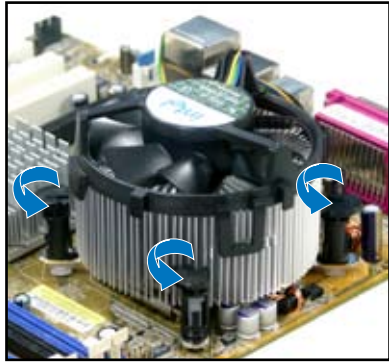

3. Pull up two fasteners at a time in a diagonal sequence to disengage the heatsink and fan assembly from the motherboard.

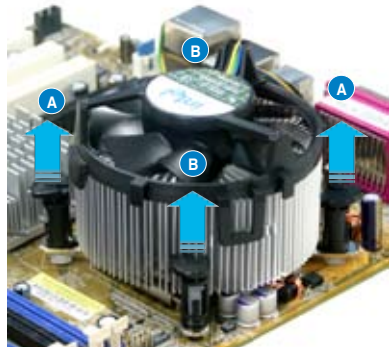
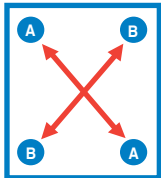

4. Carefully remove the heatsink and fan assembly from the motherboard.



5. Rotate each fastener clockwise to ensure correct orientation when reinstalling.

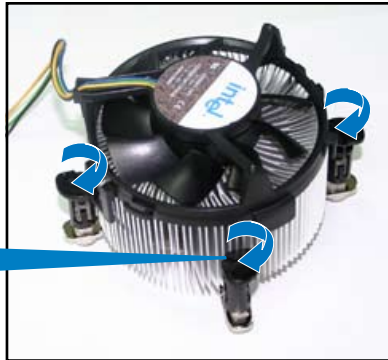

Narrow end of the groove



The narrow end of the groove should point outward after resetting. (The photo shows the groove shaded for emphasis.)

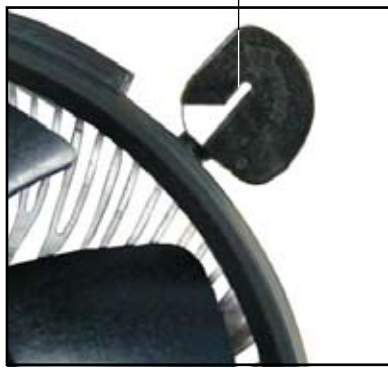

Refer to the documentation in the boxed or stand-alone CPU fan package for detailed information on CPU fan installation.

1.7 System memory

1.7.1 Overview

The motherboard comes with two Double Data Rate 2 (DDR2) Dual Inline Memory Modules (DIMM) sockets.

A DDR2 module has the same physical dimensions as a DDR DIMM but has a 240-pin footprint compared to the 184-pin DDR DIMM. DDR2 DIMMs are notched differently to prevent installation on a DDR DIMM socket.

The figure illustrates the location of the DDR2 DIMM sockets:

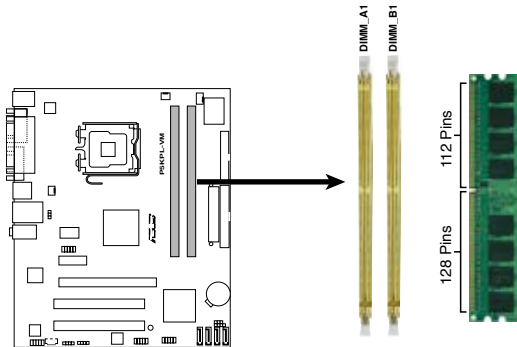

P5KPL-VM 240-pin DDR2 DIMM Sockets

Channel	Sockets
Channel A	DIMM_A1
Channel B	DIMM_B1



Install a memory module in DIMM_A1 slot to support the Intel® Quiet System Technology and for optimum performance.

1.7.2 Memory configurations

You may install 256 MB, 512 MB, 1 GB and 2 GB unbuffered non-ECC DDR2 DIMMs into the DIMM sockets.



- You may install varying memory sizes in Channel A and Channel B. The system maps the total size of the lower-sized channel for the dual-channel configuration. Any excess memory from the higher-sized channel is then mapped for single-channel operation.
- Always install DIMMs with the same CAS latency. For optimum compatibility, it is recommended that you obtain memory modules from the same vendor.
- If you install two 2GB memory modules, the system may only recognize less than 3GB because the address space is reserved for other critical functions. This limitation appears on Windows® XP 32-bit operation system which does not support Physical Address Extension (PAE).
- If you install Windows® XP 32-bit operation system, a total memory of less than 3GB is recommended.
- This motherboard does not support memory modules made up of 128 Mb chips or double sided x16 memory modules.



Notes on memory limitations

- Due to chipset limitation, this motherboard can only support up to 4 GB on the operating systems listed below. You may install a maximum of 2 GB DIMMs on each slot, but only DDR2-800 and DDR2-667 2 GB density modules are available for this configuration.

32-bit	64-bit
Windows® XP	Windows® XP x64 Edition
Windows® 2003 Server	Windows® 2003 Server x64 Edition
Windows® Vista	Windows® XP x64 Edition

- Some old-version DDR2-800 DIMMs may not match Intel® On-Die-Termination (ODT) requirement and will automatically downgrade to run at DDR-667. If this happens, contact your memory vendor to check to ODT value.

Qualified Vendors Lists (QVL)

DDR2 667

Size	Vendor	Model	Brand	Side(s)	Part No.	DIMM support	
						A	B
256MB	Kingston	KVR667D2N5/256	Elpida	SS	E2508AB-6E-E	•	•
256MB	Kingston	KVR667D2N5/256	Kingston	SS	D3216TLSAKL3U	•	•
256MB	Kingston	KVR667D2N5/256	Infineon	SS	HYB18T256800AF3SW65 33154	•	•
512MB	Kingston	KVR667D2N5/512	Kingston	SS	D6408TE8WL-27	•	•
512MB	Kingston	KVR667D2N5/512	Elpida	SS	E5108AGBG-6E-E	•	•
1G	Kingston	KVR667D2N5/1G	Kingston	DS	D6408TE8WL-3	•	•
1G	Kingston	KVR667D2N5/1G	Kingston	DS	D6408TEBGL3U	•	•
1G	Kingston	KVR667D2N5/1G	Elpida	DS	E5108AGBG-6E-E	•	•
512MB	Samsung	KR M378T6553CZ0-CE6	Samsung	SS	K4T51083QC	•	•
512MB	Samsung	KR M378T6453FZ0-CE6	Samsung	DS	K4T56083QF-ZCE6	•	•
512MB	Samsung	M378T6553CZ3-CE6	Samsung	SS	K4T51083QC-ZCE6	•	•
1G	Samsung	M378T2953CZ3-CE6	Samsung	DS	K4T51083QC-ZCE6	•	•
1G	Samsung	KR M378T2953CZ0-CE6	Samsung	DS	K4T51083QC-ZCE6	•	•
256MB	Qimonda	HYS64T32000HU-3S-A	Qimonda	SS	HYB18T512160AF-3SSSS17310	•	•
512MB	Qimonda	HYS64T32000HU-3S-A	Qimonda	SS	HYB18T512800AF-3SSSS27416	•	•
512MB	Qimonda	HYS64T64000HU-3S-A	Qimonda	SS	HYB18T512800AF3SFSS05346	•	•
1G	Qimonda	HYS64T128020HU-3S-A	Qimonda	DS	HYB18T512800AF3SSSS28104	•	•
512MB	Corsair	VS512MB667D2	Corsair	SS	64M8CFEGPS0900647	•	•
512MB	Corsair	VS512MB667D2	Corsair	DS	MII0052532M8CEC	•	•
1G	Corsair	VS1GB667D2	Corsair	DS	MID095D62864M8CEC	•	•
1G	Corsair	XMS2-5400	Corsair	DS	Heat-Sink Package	•	•
256MB	HY	HYMP532U64CP6-Y5 AB	Hynix	SS	HY5PS121621CFP-Y5	•	•
512MB	HY	HYMP564U64AP8-Y4 AA	Hynix	SS	HY5PS12821AFP-Y4	•	•
512MB	HY	HYMP564U64AP8-Y5 AA	Hynix	SS	HY5PS12821AFP-Y5	•	•
1G	HY	HYMP512U64AP8-Y5 AB	Hynix	DS	HY5PS12821AFP-Y5	•	•
1G	HY	HYMP512U64CP8-Y5 AB	Hynix	DS	HY5PS12521CFP-Y5	•	•
512MB	Kingmax	KLCC28F-A8EB5	Elpida	SS	E5108AE-6E-E	•	•
512MB	Kingmax	KLCC28F-A8KB5	Kingmax	SS	KKEA88B4LAUG-29DX	•	•
1G	Kingmax	KLCD48F-A8KB5	Kingmax	DS	KKEA88B4LAUG-29DX	•	•
512MB	Apacer	78.91092.420	Elpida	SS	E5108AE-6E-E	•	•
512MB	Apacer	AU512E667C5KBGC	Apacer	SS	AM4B5708MJS7E0627B	•	•
512MB	Apacer	AU512E667C5KBGC	Apacer	SS	AM4B5708GQJJS7E06332F	•	•
1G	Apacer	AU01GE667C5KBGC	Apacer	DS	AM4B5708GQJJS7E0636B	•	•
1G	Apacer	78.01092.420	Elpida	DS	E5108AE-6E-E	•	•
1G	Apacer	AU01GE667C5KBGC	Apacer	DS	AM4B5708MJS7E0627B	•	•
512MB	ADATA	M20EL5G3H3160B1C0Z	Elpida	SS	E5108AE-6E-E	•	•
512MB	ADATA	M20AD5G3H31661C52	ADATA	SS	AD29608A8A-3EG20648	•	•
512MB	ADATA	M20AD5G3H31661C52	ADATA	SS	AD29608A8A-3EG20718	•	•
1G	ADATA	M20AD5G3I41761C52	ADATA	DS	AD29608A8A-3EG20645	•	•
512MB	VDATA	M2GVD5G3H31A41C52	VDATA	SS	VD29608A8A-3EC20615	•	•
512MB	VDATA	M2YVD5G3H31P41C52	VDATA	SS	VD29608A8A-3EG20627	•	•
512MB	VDATA	M2GVD5G3H1661C52	VDATA	SS	VD29608A8A-3EG20637	•	•
1G	VDATA	M2GVD5G3I41P61C52	VDATA	DS	VD29608A8A-3EG20627	•	•
1G	VDATA	M2GVD5G3I41C41C52	VDATA	DS	VD29608A8A-3EC20620	•	•
1G	VDATA	M2GVD5G3I41761C52	VDATA	DS	VD29608A8A-3EG20641	•	•
512MB	PSC	AL6E8E63B-6E1K	PSC	SS	A3R12E3GEF637BLC5N	•	•

DDR 667

Size	Vendor	Model	Brand	Side(s)	Part No.	DIMM support	
						A	B
1G	PSC	AL7E8E63B-6E1K	PSC	DS	A3R12E3GEF637BLC5N	.	.
256MB	Nanya	NT256T64UH4A1FY-3C	Nanya	SS	NT5TU32M16AG-3C	.	.
512MB	Nanya	NT512T64U88A1BY-3C	Nanya	SS	NT5TU64M8AE-3C	.	.
512MB	MDT	MDT 512MB	MDT	SS	18D51280D-30648	.	.
1G	MDT	MDT 1024MB	MDT	DS	18D51200D-30646	.	.
1G	MDT	MDT 1024MB	MDT	DS	18D51280D-30646E	.	.
1G	PQI	DDR2-667U 1G	Hynix	DS	HY5PS12821BFP-E3 A	.	.
512MB	AENEON	AET660UD00-30DA98Z	AENEON	SS	AET93F30DA 0552	.	.
512MB	AENEON	AET660UD00-30DB97X	AENEON	SS	AET93R300B 0634	.	.
1G	AENEON	AET760UD00-30DA98Z	AENEON	1G	AET93F30DA8EE47414G 0540	.	.
512MB	AENEON	AET660UD00-30DA98Z	AENEON	SS	AET93F300A 0606	.	.
1G	AENEON	AET760UD00-30DA98Z	AENEON	DS	AET93F30DA 0604	.	.
1G	AENEON	AET760UD00-30DB97X	AENEON	DS	AET93R300B 0639	.	.
512MB	TAKEMS	TMS51B264C081-665QI	takeMS	SS	MS18T51280-3	.	.
512MB	TAKEMS	TMS51B264C081-665AP	takeMS	SS	MS18T51280-3S0627D	.	.
1G	TAKEMS	TMS1GB264C081-665QI	takeMS	DS	MS18T51280-3	.	.
1G	TAKEMS	TMS1GB264C081-665AE	takeMS	DS	MS18T51280-3SEA07100	.	.
1G	TAKEMS	TMS1GB264C081-665AP	takeMS	DS	MS18T51280-3SP0717A	.	.
512MB	VERITECH	GTP512HLTMA45EG	VERITECH	SS	VTD264M8PC6G01A164129621	.	.
1G	VERITECH	GTP01GHLTMA55EG	VERITECH	DS	VTD264M8PC6G01A164129621	.	.
512MB	GEIL	GX21GB5300DC	GEIT	SS	Heat-Sink Package	.	.
512MB	TEAM	TVDD512M667C5	TEAM	SS	T2D648MT-6	.	.
1G	TEAM	TVDD1.02M667C4	TEAM	DS	T2D648PT-6	.	.
512MB	Century	CENTURY 512MB	Nanya	SS	NT5TU64M8AE-3C	.	.
512MB	Century	CENTURY 512MB	Hynix	SS	HY5PS12821AFP-Y5	.	.
1G	Century	CENTURY 1G	Hynix	DS	HY5PS12821AFP-Y5	.	.
1G	Century	CENTURY 1G	Nanya	DS	NT5TU64M8AE-3C	.	.
512MB	KINGBOX	512MB 667MHz	KINGBOX	SS	EPD264082200-4	.	.
1G	KINGBOX	DDRII 1G 667MHz	KINGBOX	DS	EPD264082200-4	.	.

DDR2 800

Size	Vendor	Model	Brand	Side(s)	Part No.	DIMM support	
						A	B
512MB	Kingston	KVR800D2N5/512	Samsung	SS	K4T51083QC-ZCE7	.	.
512MB	Kingston	KVR800D2N5/512	Promos	SS	V59C1512804QBFB25S0054707PEBPA	.	.
1G	Kingston	KVR800D2N5/1G	Samsung	DS	K4T51083QC-ZCE7	.	.
1G	Kingston	KHX6400D2LL/1G	Kingston	DS	Heat-Sink Package	.	.
1G	Kingston	KVR800D2N5/1G	Nanya	DS	NT5TU64M8BE-25C62321800CP	.	.
1G	Kingston	KHX6400D2LLK2/1GN	Kingston	DS	Heat-Sink Package	.	.
2G	Kingston	KHX6400D2K2/2G	Kingston	DS	Heat-Sink Package	.	.
512MB	Samsung	KR M378T6553CZ3-CE7	Samsung	SS	K4T51083QC-ZCE7	.	.
1G	Samsung	KR M378T2953CZ3-CE7	Samsung	DS	K4T51083QC-ZCE7	.	.
256MB	Qimonda	HYS64T32001HU-2.5-A	Qimonda	SS	HYB18T256800AF25SSS49313	.	.
512MB	Qimonda	HYS64T64020HU-2.5-A	Qimonda	DS	HYB18T256800AF25SSS25063	.	.
1G	Corsair	CM2X1024-6400	Corsair	DS	Heat-Sink Package	.	.
1G	Corsair	XMS2-6400	Corsair	DS	Heat-Sink Package	.	.
1G	Corsair	XMS2-6400	Corsair	DS	Heat-Sink Package	.	.

DDR2 800

Size	Vendor	Model	Brand	Side(s)	Part No.	DIMM support	
						A	B
512MB	HY	HYMP564U64AP8-S6 AA	Hynix	SS	HY5PS12821AFP-S6	•	•
512MB	HY	HYMP564U64BP8-S5 AB	Hynix	SS	HY5PS12821BFP-S5	•	•
512MB	HY	HYMP564U64CP8-S5 AB	Hynix	SS	HY5PS12821CFP-S5	•	•
1G	HY	HYMP512U64AP8-S6 AA	Hynix	DS	HY5PS12821AFP-S6	•	•
1G	HY	HYMP512U64BP8-S5 AB	Hynix	DS	HY5PS12821BFP-S5	•	•
1G	HY	HYMP512U64CP8-S5 AB	Hynix	DS	HY5PS12821CFPS5	•	•
2G	Apacer	AHU02GE800C5N1C	Apacer	DS	Heat-Sink Package	•	
512MB	ADATA	M20AD6G3H31601E58	ADATA	SS	AD29608A8A-25EG80720	•	•
512MB	VDATA	M2GVD6G3H31601E53	VDATA	SS	VD29608A8A-25EG30648	•	•
1G	VDATA	M2GVD6G3I41701E53	VDATA	DS	VD29608A8A-25EG30647	•	•
512MB	PSC	AL6E8E63B-8E1K	PSC	SS	A3R12E3HEF641B9A05	•	•
1G	PSC	AL7E8E63B-8E1K	PSC	DS	A3R12E3HEF641B9A05	•	•
512MB	AENEON	AET660UD00-25DB98X	AENEON	SS	AET93F25DB 0621	•	•
1G	AENEON	AET760UD00-25DB97X	AENEON	DS	AET93R25DB 0640	•	•
512MB	SIS	SLY264M8-JGE-3	SIS	SS	DDR1I6408-8E 7212	•	•
1G	SIS	SLY264M8-JGE-3	SIS	DS	DDR1I6408-8E 7301	•	•
512MB	TAKEMS	TMS51B264C081-805EP	takeMS	SS	MS18T51280-2.5P0710	•	•
1G	TAKEMS	TMS1GB264C081-805AE	takeMS	DS	MS18T51280-25FEA0709A		
1G	TAKEMS	TMS1GB264C081-805EP	takeMS	DS	MS18T51280-2.5P0716	•	•
512MB	VERITECH	GTU512HLTX4EG	Veritech	SS	VTD264M8PC4G03A169045648	•	•
1G	VERITECH	GTU01GHLTX4EG	Veritech	DS	VTD264M8PC4G03A169045648	•	•
1G	UMAX	1GB_DDR2_PC6400	UMAX	DS	U2S12D30TP-8E	•	•



Visit the ASUS website (www.asus.com) for the latest QVL.

Side(s): **SS** - Single-sided **DS** - Double-sided

DIMM support:

- A** - Supports one module inserted into any slot as Single-channel memory configuration.
- B** - Supports one pair of modules inserted into the yellow slots as one pair of Dual-channel memory configuration.

1.7.3 Installing a DIMM



Unplug the power supply before adding or removing DIMMs or other system components. Failure to do so can cause severe damage to both the motherboard and the components.

To install a DIMM:

1. Unlock a DIMM socket by pressing the retaining clips outward.
2. Align a DIMM on the socket such that the notch on the DIMM matches the break on the socket.
3. Firmly insert the DIMM into the socket until the retaining clips snap back in place and the DIMM is properly seated.

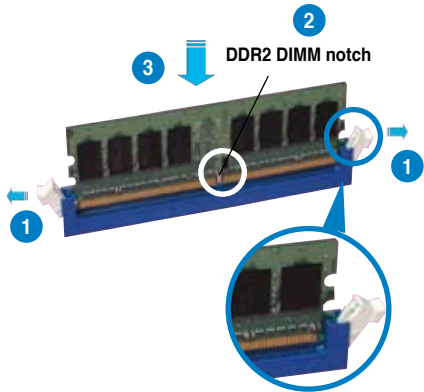

Unlocked retaining clip



- A DDR2 DIMM is keyed with a notch so that it fits in only one direction. Do not force a DIMM into a socket to avoid damaging the DIMM.
- The DDR2 DIMM sockets do not support DDR DIMMs. Do not install DDR DIMMs to the DDR2 DIMM sockets.

1.7.4 Removing a DIMM

To remove a DIMM:

1. Simultaneously press the retaining clips outward to unlock the DIMM.



Support the DIMM lightly with your fingers when pressing the retaining clips. The DIMM might get damaged when it flips out with extra force.

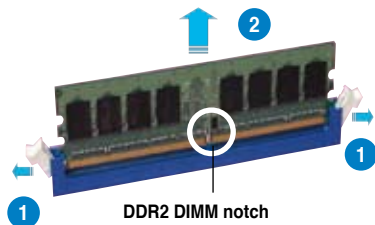

2. Remove the DIMM from the socket.

1.8 Expansion slots

In the future, you may need to install expansion cards. The following sub-sections describe the slots and the expansion cards that they support.



Make sure to unplug the power cord before adding or removing expansion cards. Failure to do so may cause you physical injury and damage motherboard components.

1.8.1 Installing an expansion card

To install an expansion card:

1. Before installing the expansion card, read the documentation that came with it and make the necessary hardware settings for the card.
2. Remove the system unit cover (if your motherboard is already installed in a chassis).
3. Remove the bracket opposite the slot that you intend to use. Keep the screw for later use.
4. Align the card connector with the slot and press firmly until the card is completely seated on the slot.
5. Secure the card to the chassis with the screw you removed earlier.
6. Replace the system cover.

1.8.2 Configuring an expansion card

After installing the expansion card, configure it by adjusting the software settings.

1. Turn on the system and change the necessary BIOS settings, if any. See Chapter 2 for information on BIOS setup.
2. Assign an IRQ to the card. Refer to the tables on the next page.
3. Install the software drivers for the expansion card.



When using PCI cards on shared slots, ensure that the drivers support “Share IRQ” or that the cards do not need IRQ assignments. Otherwise, conflicts will arise between the two PCI groups, making the system unstable and the card inoperable. Refer to the table on the next page for details.

1.8.3 Interrupt assignments

Standard interrupt assignments

IRQ	Priority	Standard Function
0	1	System Timer
1	2	Keyboard Controller
2	—	Re-direct to IRQ#9
3	10	Communications Port (COM1)
4	11	IRQ holder for PCI steering*
5	12	Standard Floppy Disk Controller
6	13	Printer Port (LPT1)
7	3	System CMOS/Real Time Clock
8	4	IRQ holder for PCI steering*
9	5	IRQ holder for PCI steering*
10	6	IRQ holder for PCI steering*
11	7	PS/2 Compatible Mouse Port
12	8	Numeric Data Processor
13	9	Primary IDE Channel

* These IRQs are usually available for PCI devices.

IRQ assignments for this motherboard

	A	B	C	D	E	F	G	H
PCI1	—	—	—	shared	—	—	—	—
PCI2	shared	—	—	—	—	—	—	—
PCIEX16_1	shared	—	—	—	—	—	—	—
PCIEX1_1	shared	—	—	—	—	—	—	—
Onboard USB controller 1	—	—	—	—	—	—	—	shared
Onboard USB controller 2	—	—	—	shared	—	—	—	—
Onboard USB controller 3	—	—	shared	—	—	—	—	—
Onboard USB controller 4	shared	—	—	—	—	—	—	—
Onboard USB 2.0 controller	—	—	—	—	—	—	—	shared
Onboard HD audio	shared	—	—	—	—	—	—	—
Onboard LAN	—	Used	—	—	—	—	—	—

1.8.4 PCI slots

The PCI slots support cards such as a LAN card, SCSI card, USB card, and other cards that comply with PCI specifications. The figure shows a LAN card installed on a PCI slot.

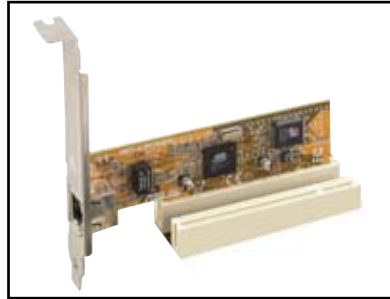

1.8.5 PCI Express x1 slot

This motherboard supports PCI Express x1 network cards, SCSI cards and other cards that comply with the PCI Express specifications. The following figure shows a network card installed on the PCI Express x1 slot.



1.8.6 PCI Express x16 slot

This motherboard supports PCI Express x16 graphic cards that comply with the PCI Express specifications. The figure shows a graphics card installed on the PCI Express x16 slot.

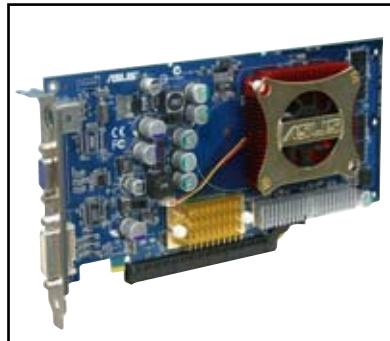

1.9 Jumpers

1. Clear RTC RAM (CLRRTC)

This jumper allows you to clear the Real Time Clock (RTC) RAM in CMOS. You can clear the CMOS memory of date, time, and system setup parameters by erasing the CMOS RTC RAM data. The onboard button cell battery powers the RAM data in CMOS, which include system setup information such as system words.

To erase the RTC RAM:

1. Turn OFF the computer and unplug the power cord.
2. Remove the onboard battery.
3. Move the jumper cap from pins 1-2 (default) to pins 2-3. Keep the cap on pins 2-3 for about 5~10 seconds, then move the cap back to pins 1-2.
4. Reinstall the battery.
5. Plug the power cord and turn ON the computer.
6. Hold down the key during the boot process and enter BIOS setup to re-enter data.



Except when clearing the RTC RAM, never remove the cap on CLRRTC jumper default position. Removing the cap will cause system boot failure!

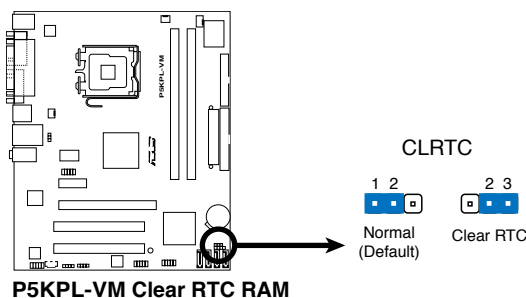

- You do not need to clear the RTC when the system hangs due to overclocking. For system failure due to overclocking, use the C.P.R. (CPU Parameter Recall) feature. Shut down and reboot the system so the BIOS can automatically reset parameter settings to default values.
- Due to the chipset limitation, AC power off is required prior using C.P.R. function. You must turn off and on the power supply or unplug and plug the power cord before reboot the system.

2. USB device wake-up (3-pin PS2_USBPW)

This jumper allows you to enable or disable the keyboard wake-up feature. Set this jumper to pins 2-3 (+5VSB) to wake up the computer when you press a key on the keyboard (the default is the Space Bar). This feature requires an ATX power supply that can supply at least 500 mA on the +5VSB lead, and a corresponding setting in the BIOS.

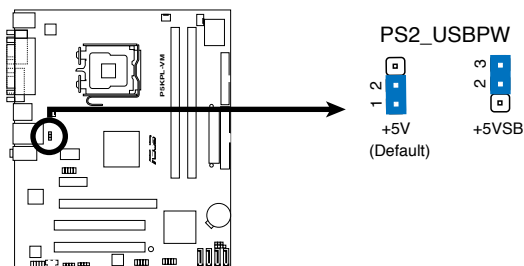

P5KPL-VM USB Device Wake Up



- The USB device wake-up feature requires a power supply that can provide 500mA on the +5VSB lead for each USB port; otherwise, the system would not power up.
- The total current consumed must NOT exceed the power supply capability (+5VSB) whether under normal condition or in sleep mode.

1.10 Connectors

1.10.1 Rear panel connectors

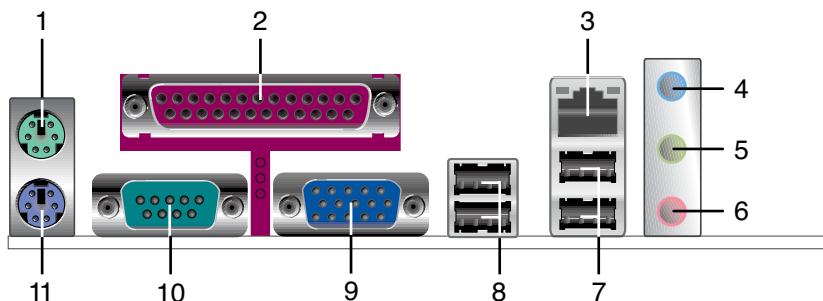

1. **PS/2 mouse port (green).** This port is for a PS/2 mouse.
2. **Parallel port.** This 25-pin port connects a parallel printer, a scanner, or other devices.
3. **LAN (RJ-45) port.** Supported by L1 PCIE Gigabit LAN controller, this port allows Gigabit connection to a Local Area Network (LAN) through a network hub. Refer to the table below for the LAN port LED indications.

LAN port LED indications

Activity/Link		Speed LED	
Status	Description	Status	Description
OFF	No link	OFF	10 Mbps connection
YELLOW	Linked	ORANGE	100 Mbps connection
BLINKING	Data activity	GREEN	1 Gbps connection

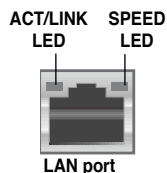

4. **Line In port (light blue).** This port connects the tape, CD, DVD player, or other audio sources.
5. **Line Out port (lime).** This port connects a headphone or a speaker. In 4-channel and 6-channel configuration, the function of this port becomes Front Speaker Out.
6. **Microphone port (pink).** This port connects a microphone.



Refer to the audio configuration table below for the function of the audio ports in 2, 4, or 6-channel configuration.

Audio 2, 4, or 6-channel configuration

Port	Headset 2-speaker	4-speaker	6-speaker
Light Blue	Line In	Surround Out	Surround Out
Lime green	Line Out	Front Speaker Out	Front Speaker Out
Pink	Mic In	Mic	Center/Bass

- 7. USB 2.0 ports 1 and 2.** These two 4-pin Universal Serial Bus (USB) ports are available for connecting USB 2.0 devices.
- 8. USB 2.0 ports 3 and 4.** These two 4-pin Universal Serial Bus (USB) ports are available for connecting USB 2.0 devices.
- 9. Video Graphics Adapter port.** This 15-pin port is for a VGA monitor or other VGA-compatible devices.
- 10. Serial port.** This 9-pin COM1 port is for pointing devices or other serial devices.
- 11. PS/2 keyboard port (purple).** This port is for a PS/2 keyboard.

1.10.2 Internal connectors

1. Floppy disk drive connector (34-1 pin FLOPPY)

This connector is for the provided floppy disk drive (FDD) signal cable. Insert one end of the cable to this connector, then connect the other end to the signal connector at the back of the floppy disk drive.



Pin 5 on the connector is removed to prevent incorrect cable connection when using a FDD cable with a covered Pin 5.

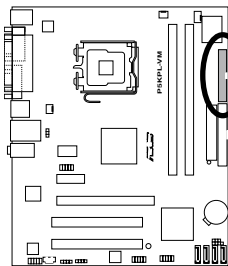

FLOPPY

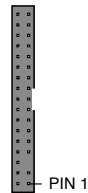

PIN 1

NOTE: Orient the red markings on the floppy ribbon cable to PIN 1.

P5KPL-VM Floppy Disk Drive Connector

2. Digital Audio connector (4-1 pin SPDIF_OUT)

This connector is for the S/PDIF audio module to allow digital sound output. Connect one end of the S/PDIF audio cable to this connector and the other end to the S/PDIF module.

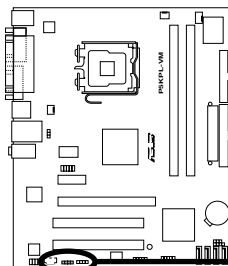

+5V
SPDIFOUT
GND
SPDIF_OUT

P5KPL-VM Digital Audio Connector



The S/PDIF out module is purchased separately.

3. IDE connector (40-1 pin PRI_IDE)

The onboard IDE connector is for the Ultra DMA 100/66/33 signal cable. There are three connectors on each Ultra DMA 100/66/33 signal cable: blue, black, and gray. Connect the blue connector to the motherboard's IDE connector, then select one of the following modes to configure your device.

	Drive jumper setting	Mode of device(s)	Cable connector
Single device	Cable-Select or Master	-	Black
Two devices	Cable-Select	Master	Black
		Slave	Gray
	Master	Master	Black or gray
	Slave	Slave	



- Pin 20 on the IDE connector is removed to match the covered hole on the Ultra DMA cable connector. This prevents incorrect insertion when you connect the IDE cable.
- Use the 80-conductor IDE cable for Ultra DMA 100/66/33 IDE devices.



If any device jumper is set as "Cable-Select," make sure all other device jumpers have the same setting.

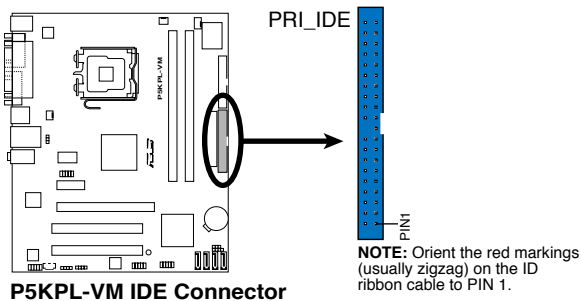

4. ICH7 Serial ATA connectors (7-pin SATA1, SATA2, SATA3, SATA4)

These connectors are for the Serial ATA signal cables for Serial ATA hard disk drives.

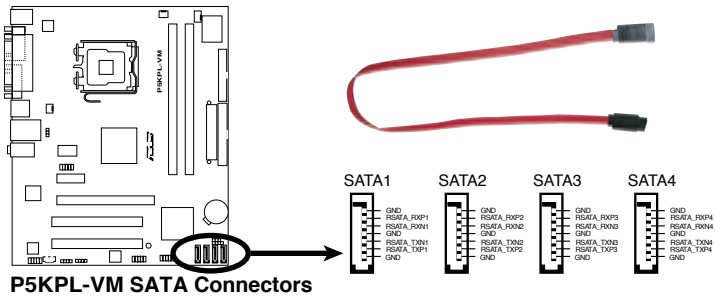

Connect the right-angle side of SATA signal cable to SATA device. Or you may connect the right-angle side of SATA cable to the onboard SATA port to avoid mechanical conflict with huge graphics cards.

right angle side

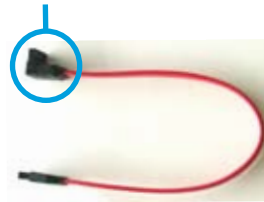

5. Speaker connector (4-pin SPEAKER)

This 4-pin connector is for the chassis-mounted system warning speaker. The speaker allows you to hear system beeps and warnings.

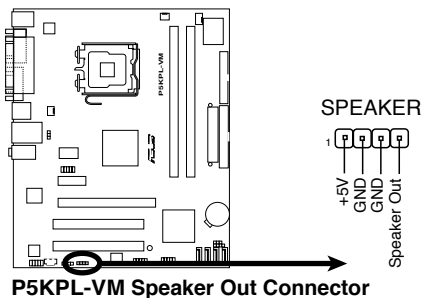

6. USB connectors (10-1 pin USB56, USB78)

These connectors are for USB 2.0 ports. Connect the USB module cable to any of these connectors, then install the module to a slot opening at the back of the system chassis. These USB connectors comply with USB 2.0 specification that supports up to 480 Mbps connection speed.

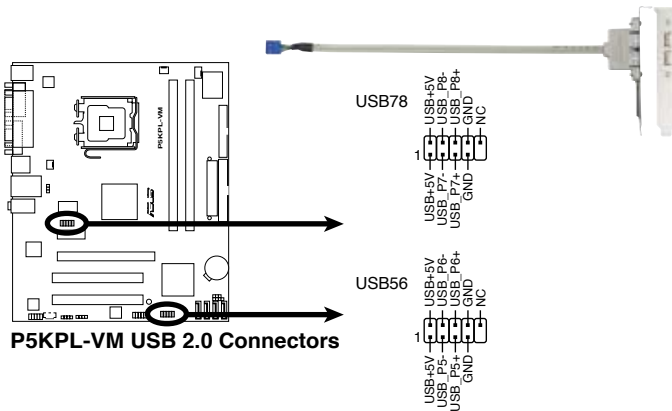

Never connect a 1394 cable to the USB connectors. Doing so will damage the motherboard!



The USB module is purchased separately.

7. Optical drive audio connector (4-pin CD)

These connectors allow you to receive stereo audio input from sound sources such as a CD-ROM, TV tuner, or MPEG card.

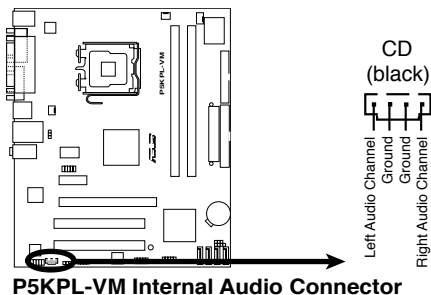

8. CPU, chassis and power fan connectors (4-pin CPU_FAN, 3-pin CHA_FAN, 3-pin PWR_FAN)

The fan connectors support cooling fans of 350 mA ~ 2000 mA (24 W max.) or a total of 1 A ~ 7 A (84 W max.) at +12V. Connect the fan cables to the fan connectors on the motherboard, making sure that the black wire of each cable matches the ground pin of the connector.



Do not forget to connect the fan cables to the fan connectors. Insufficient air flow inside the system may damage the motherboard components. These are not jumpers! Do not place jumper caps on the fan connectors!

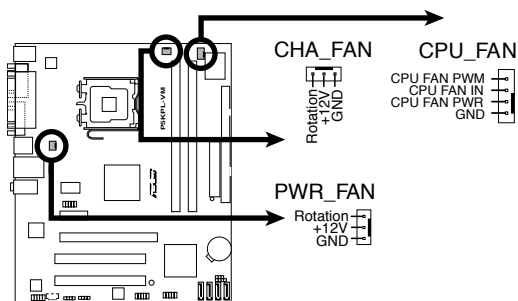

P5KPL-VM Fan Connectors



Only the CPU-FAN connector support the ASUS Advanced Q-Fan feature.

9. Chassis intrusion connector (4-1 pin CHASSIS)

This connector is for a chassis-mounted intrusion detection sensor or switch. Connect one end of the chassis intrusion sensor or switch cable to this connector. The chassis intrusion sensor or switch sends a high-level signal to this connector when a chassis component is removed or replaced. The signal is then generated as a chassis intrusion event.

By default, the pin labeled “Chassis Signal” and “Ground” are shorted with a jumper cap. Remove the jumper caps only when you intend to use the chassis intrusion detection feature.

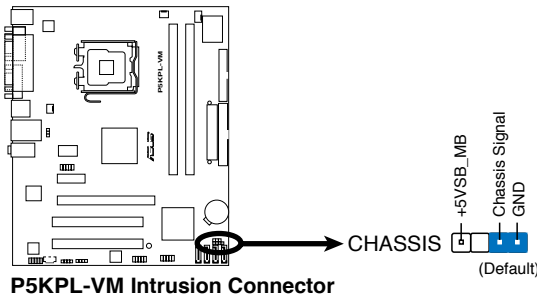

10. Front panel audio connector (10-1 pin AAFP)

This connector is for a chassis-mounted front panel audio I/O module that supports either HD Audio or legacy AC'97 audio standard.

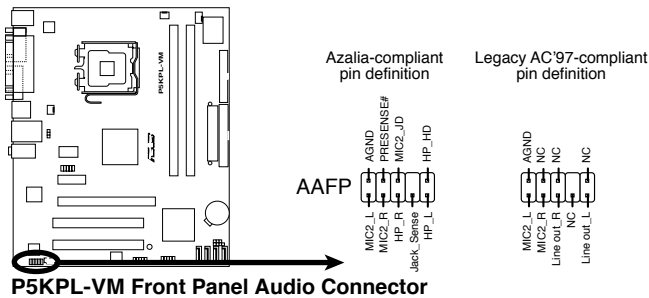

- We recommend that you connect a high-definition front panel audio module to this connector to avail of the motherboard's high-definition audio capability.
- By default, this connector is set to HD Audio. If you want to connect a High Definition front panel audio module to this connector, set the **Front Panel Support Type** item in the BIOS to [HD Audio]. See section “2.4.4 Chipset” for details.

12. System panel connector (10-1 pin F_PANEL)

This connector supports several chassis-mounted functions.

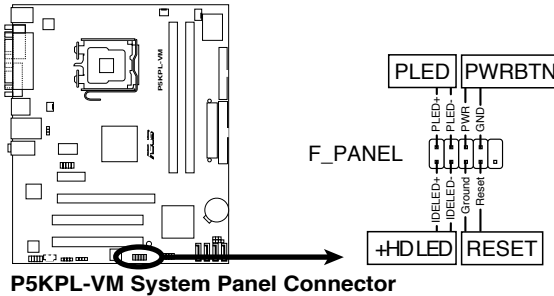

- **System power LED (2-pin PWRLED)**

This 2-pin connector is for the system power LED. Connect the chassis power LED cable to this connector. The system power LED lights up when you turn on the system power, and blinks when the system is in sleep mode.

- **Hard disk drive activity LED (2-pin +HDLED)**

This 2-pin connector is for the HDD Activity LED. Connect the HDD Activity LED cable to this connector. The IDE LED lights up or flashes when data is read from or written to the HDD.

- **ATX power button/soft-off button (2-pin PWRBTN)**

This connector is for the system power button. Pressing the power button turns the system on or puts the system in sleep or soft-off mode depending on the BIOS settings. Pressing the power switch for more than four seconds while the system is ON turns the system OFF.

- **Reset button (2-pin RESET)**

This 2-pin connector is for the chassis-mounted reset button for system reboot without turning off the system power.

This chapter tells how to change the system settings through the BIOS Setup menus. Detailed descriptions of the BIOS parameters are also provided.

BIOS setup **2**

2.1 Managing and updating your BIOS

The following utilities allow you to manage and update the motherboard Basic Input/Output System (BIOS) setup.

1. **ASUS EZ Flash 2** (Updates the BIOS in DOS mode using a floppy disk or USB flash disk.)
2. **ASUS AFUDOS** (Updates the BIOS in DOS mode using a bootable floppy disk.)
3. **ASUS CrashFree BIOS 3** (Updates the BIOS using a bootable floppy disk, USB flash disk or the motherboard support CD when the BIOS file fails or gets corrupted.)
4. **ASUS Update** (Updates the BIOS in Windows® environment.)

Refer to the corresponding sections for details on these utilities.



Save a copy of the original motherboard BIOS file to a bootable floppy disk or a USB flash disk in case you need to restore the BIOS in the future. Copy the original motherboard BIOS using the ASUS Update or AFUDOS utilities.

2.1.1 Creating a bootable floppy disk

1. Do either one of the following to create a bootable floppy disk.
 - DOS environment*
 - a. Insert a 1.44MB floppy disk into the drive.
 - b. At the DOS prompt, type `format a: /s` then press <Enter>.
 - Windows® XP environment*
 - a. Insert a 1.44 MB floppy disk to the floppy disk drive.
 - b. Click **Start** from the Windows® desktop, then select **My Computer**.
 - c. Select the 3 1/2 Floppy Drive icon.
 - d. Click **File** from the menu, then select **Format**. A **Format 3 1/2 Floppy Disk** window appears.
 - e. Select **Create an MS-DOS startup disk** from the format options field, then click **Start**.

Windows® 2003 environment

To create a set of boot disks for Windows® 2003:

- a. Insert a formatted, high density 1.44 MB floppy disk into the drive.
- b. Insert the Windows® 2003 CD to the optical drive.
- c. Click **Start**, then select **Run**.
- d. From the Open field, type
`D:\bootdisk\makeboot a:`
assuming that D: is your optical drive.
- e. Press <Enter>, then follow screen instructions to continue.

Windows® Vista environment

- a. Insert a formatted, high density 1.44 MB floppy disk to the floppy disk drive.
 - b. Click  from the Windows® desktop, then select **Computer**.
 - c. Right-click **Floppy Disk Drive** then click **Format** to display the **Format 3 1/2 Floppy** dialog box.
 - d. Select the **Create an MS-DOS startup disk** check box.
 - e. Click **Start**.
2. Copy the original or the latest motherboard BIOS file to the bootable floppy disk.

2.1.2 ASUS EZ Flash 2 utility

The ASUS EZ Flash 2 feature allows you to update the BIOS without having to go through the long process of booting from a floppy disk and using a DOS-based utility. The EZ Flash 2 utility is built-in the BIOS chip so it is accessible by pressing <Alt> + <F2> during the Power-On Self Tests (POST).

To update the BIOS using EZ Flash 2:

1. Visit the ASUS website (www.asus.com) to download the latest BIOS file for the motherboard.
2. Save the BIOS file to a floppy disk or a USB flash disk, then restart the system.
3. You can launch the EZ Flash 2 by two methods.
 - (1) Insert the floppy disk / USB flash disk that contains the BIOS file to the floppy disk drive or the USB port.

Press <Alt> + <F2> during POST to display the following.

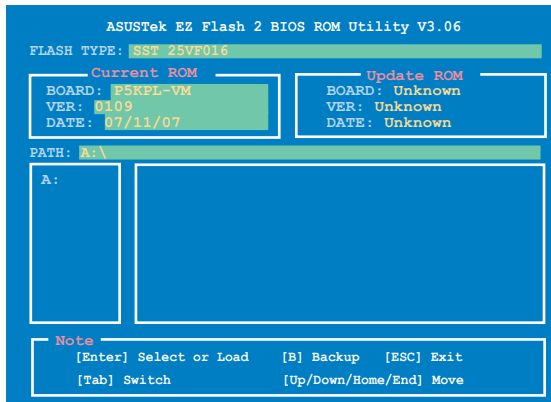

- (2) Enter BIOS setup program. Go to the **Tools** menu then select **EZ Flash2** and press <Enter>.

You can switch between drives by pressing <Tab> before the correct file is found. Then press <Enter>.

- When the correct BIOS file is found, EZ Flash 2 performs the BIOS update process and automatically reboots the system when done.



- This function can support devices such as USB flash disk, or floppy disk with **FAT 32/16** format and single partition only.
- DO NOT shut down or reset the system while updating the BIOS to prevent system boot failure!

2.1.3 AFUDOS utility

The AFUDOS utility allows you to update the BIOS file in DOS environment using a bootable floppy disk with the updated BIOS file. This utility also allows you to copy the current BIOS file that you can use as backup when the BIOS fails or gets corrupted during the updating process.

Copying the current BIOS

To copy the current BIOS file using the AFUDOS utility:



- Make sure that the floppy disk is not write-protected and has at least 1024KB free space to save the file.
- The succeeding BIOS screens are for reference only. The actual BIOS screen displays may not be same as shown.

- Copy the AFUDOS utility (afudos.exe) from the motherboard support CD to the bootable floppy disk you created earlier.
- Boot the system in DOS mode, then at the prompt type:

```
afudos /o[filename]
```

where the [filename] is any user-assigned filename not more than eight alphanumeric characters for the main filename and three alphanumeric characters for the extension name.

```
A:\>afudos /oOLDBIOS1.rom
```

Main filename Extension name

- Press <Enter>. The utility copies the current BIOS file to the floppy disk.

```
A:\>afudos /oOLDBIOS1.rom
AMI Firmware Update Utility - Version 1.19(ASUS V2.07(03.11.24BB))
Copyright (C) 2002 American Megatrends, Inc. All rights reserved.
Reading flash ..... done
Write to file..... ok
A:\>
```

The utility returns to the DOS prompt after copying the current BIOS file.

Updating the BIOS file

To update the BIOS file using the AFUDOS utility:

1. Visit the ASUS website (www.asus.com) and download the latest BIOS file for the motherboard. Save the BIOS file to a bootable floppy disk.



Write the BIOS filename on a piece of paper. You need to type the exact BIOS filename at the DOS prompt.

2. Copy the AFUDOS utility (afudos.exe) from the motherboard support CD to the bootable floppy disk you created earlier.
3. Boot the system in DOS mode, then at the prompt type:

```
afudos /i[filename]
```

where [filename] is the latest or the original BIOS file on the bootable floppy disk.

```
A:\>afudos /iP5KPLVM.ROM
```

4. The utility verifies the file and starts updating the BIOS.

```
A:\>afudos /iP5KPLVM.ROM
AMI Firmware Update Utility - Version 1.19(ASUS V2.07(03.11.24BB))
Copyright (C) 2002 American Megatrends, Inc. All rights reserved.

WARNING!! Do not turn off power during flash BIOS
Reading file ..... done
Reading flash ..... done

Advance Check .....
Erasing flash ..... done
```



Do not shut down or reset the system while updating the BIOS to prevent system boot failure!

5. The utility returns to the DOS prompt after the BIOS update process is completed. Reboot the system from the hard disk drive.

```
A:\>afudos /iP5KPLVM.ROM
AMI Firmware Update Utility - Version 1.19(ASUS V2.07(03.11.24BB))
Copyright (C) 2002 American Megatrends, Inc. All rights reserved.

WARNING!! Do not turn off power during flash BIOS
Reading file ..... done
Reading flash ..... done

Advance Check .....
Erasing flash ..... done
Writing flash ..... done
Verifying flash .... done

Please restart your computer

A:\>
```

2.1.4 ASUS CrashFree BIOS 3 utility

The ASUS CrashFree BIOS 3 is an auto recovery tool that allows you to restore the BIOS file when it fails or gets corrupted during the updating process. You can update a corrupted BIOS file using the motherboard support CD, the floppy disk or the USB flash disk that contains the updated BIOS file.



- Prepare the motherboard support CD, the floppy disk or the USB flash disk containing the updated motherboard BIOS before using this utility.
- Make sure that you rename the original or updated BIOS file in the floppy disk or the USB flash disk to **P5KPLVM.ROM**.

Recovering the BIOS from a floppy disk

To recover the BIOS from a floppy disk:

1. Turn on the system.
2. Insert the floppy disk with the original or updated BIOS file to the floppy disk drive.
3. The utility displays the following message and automatically checks the floppy disk for the original or updated BIOS file.

```
Bad BIOS checksum. Starting BIOS recovery...  
Checking for floppy...
```

When found, the utility reads the BIOS file and starts flashing the corrupted BIOS file.

```
Bad BIOS checksum. Starting BIOS recovery...  
Checking for floppy...  
Floppy found!  
Reading file "P5KPLVM.ROM". Completed.  
Start flashing...
```



DO NOT shut down or reset the system while updating the BIOS! Doing so can cause system boot failure!

4. Restart the system after the utility completes the updating process.



Install memory module in DIMM_A1 or DIMM_B1 slots.

Recovering the BIOS from the support CD

To recover the BIOS from the support CD:

1. Remove any floppy disk from the floppy disk drive, then turn on the system.
2. Insert the support CD to the optical drive.
3. The utility displays the following message and automatically checks the floppy disk for the original or updated BIOS file.

```
Bad BIOS checksum. Starting BIOS recovery...
Checking for floppy...
```

When no floppy disk is found, the utility automatically checks the optical drive for the original or updated BIOS file. The utility then updates the corrupted BIOS file.

```
Bad BIOS checksum. Starting BIOS recovery...
Checking for floppy...
Floppy not found!
Checking for CD-ROM...
CD-ROM found!
Reading file "P5KPLVM.ROM". Completed.
Start flashing...
```

4. Restart the system after the utility completes the updating process.



The recovered BIOS may not be the latest BIOS version for this motherboard. Visit the ASUS website (www.asus.com) to download the latest BIOS file.

Recovering the BIOS from the USB flash disk

To recover the BIOS from the USB flash disk:

1. Insert the USB flash disk that contains BIOS file to the USB port.
2. Turn on the system.
3. The utility will automatically checks the devices for the BIOS file. When found, the utility reads the BIOS file and starts flashing the corrupted BIOS file.
4. Restart the system after the utility completes the updating process.



- Only the USB flash disk with FAT 32/16 format and single partition can support ASUS CrashFree BIOS 3. The device size should be smaller than 8GB.
 - DO NOT shut down or reset the system while updating the BIOS! Doing so can cause system boot failure!
-

2.1.5 ASUS Update utility

The ASUS Update is a utility that allows you to manage, save, and update the motherboard BIOS in Windows® environment. The ASUS Update utility allows you to:

- Save the current BIOS file
- Download the latest BIOS file from the Internet
- Update the BIOS from an updated BIOS file
- Update the BIOS directly from the Internet, and
- View the BIOS version information.

This utility is available in the support CD that comes with the motherboard package.



ASUS Update requires an Internet connection either through a network or an Internet Service Provider (ISP).

Installing ASUS Update

To install ASUS Update:

1. Place the support CD in the optical drive. The **Drivers** menu appears.
2. Click the **Utilities** tab, then click **Install ASUS Update**. See page 2-3 for the **Utilities** screen menu.
3. The ASUS Update utility is copied to your system.



Quit all Windows® applications before you update the BIOS using this utility.

- From the FTP site, select the BIOS version that you wish to download. Click **Next**.
- Follow the screen instructions to complete the update process.



The ASUS Update utility is capable of updating itself through the Internet. Always update the utility to avail all its features.



Updating the BIOS through a BIOS file

To update the BIOS through a BIOS file:

- Launch the ASUS Update utility from the Windows® desktop by clicking **Start > Programs > ASUS > ASUSUpdate > ASUSUpdate**. The ASUS Update main window appears.
- Select **Update BIOS from a file** option from the drop-down menu, then click **Next**.



- Locate the BIOS file from the **Open** window, then click **Open**.
- Follow the screen instructions to complete the update process.

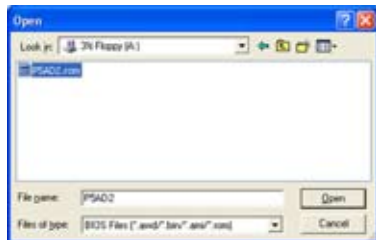

2.2 BIOS setup program

This motherboard supports a programmable firmware chip that you can update using the provided utility described in section “2.1 Managing and updating your BIOS.”

Use the BIOS Setup program when you are installing a motherboard, reconfiguring your system, or prompted to “Run Setup.” This section explains how to configure your system using this utility.

Even if you are not prompted to use the Setup program, you can change the configuration of your computer in the future. For example, you can enable the security password feature or change the power management settings. This requires you to reconfigure your system using the BIOS Setup program so that the computer can recognize these changes and record them in the CMOS RAM of the SPI chip.

The firmware chip on the motherboard stores the Setup utility. When you start up the computer, the system provides you with the opportunity to run this program. Press during the Power-On Self-Test (POST) to enter the Setup utility; otherwise, POST continues with its test routines.

If you wish to enter Setup after POST, reboot the system by doing any of the following procedures:

- Restart using the OS standard shut-down procedure.
- Press <Ctrl>+<Alt>+ simultaneously.
- Press the reset button on the system chassis.
- Press the power button to turn the system off then back on.



Using the **power button**, **reset button**, or the **<Ctrl>+<Alt>+** keys to force reset from a running operating system can cause damage to your data or system. We recommend to always shut-down the system properly from the operating system.

The Setup program is designed to make it as easy to use as possible. Being a menu-driven program, it lets you scroll through the various sub-menus and make your selections from the available options using the navigation keys.



- The default BIOS settings for this motherboard apply for most conditions to ensure optimum performance. If the system becomes unstable after changing any BIOS settings, load the default settings to ensure system compatibility and stability. Select the **Load Setup Defaults** item under the Exit Menu. See section “2.8 Exit Menu.”
 - The BIOS setup screens shown in this section are for reference purposes only, and may not exactly match what you see on your screen.
 - Visit the ASUS website (www.asus.com) to download the latest BIOS file for this motherboard.
-

2.2.1 BIOS menu screen

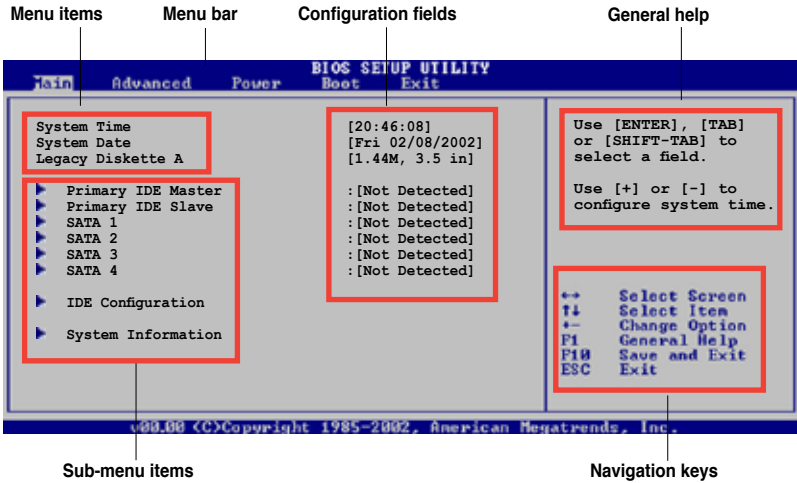

2.2.2 Menu bar

The menu bar on top of the screen has the following main items:

- Main** For changing the basic system configuration
- Advanced** For changing the advanced system settings
- Power** For changing the advanced power management (APM) configuration
- Boot** For changing the system boot configuration
- Exit** For selecting the exit options and loading default settings

To select an item on the menu bar, press the right or left arrow key on the keyboard until the desired item is highlighted.

2.2.3 Navigation keys

At the bottom right corner of a menu screen are the navigation keys for that particular menu. Use the navigation keys to select items in the menu and change the settings.



Some of the navigation keys differ from one screen to another.

2.2.4 Menu items

The highlighted item on the menu bar displays the specific items for that menu. For example, selecting Main shows the Main menu items.

The other items (Advanced, Power, Boot, Tool, and Exit) on the menu bar have their respective menu items.

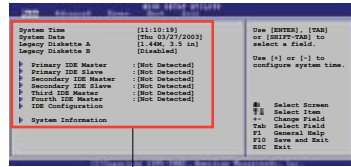

Main menu items

2.2.5 Sub-menu items

A solid triangle before each item on any menu screen means that the item has a sub-menu. To display the sub-menu, select the item and press <Enter>.

2.2.6 Configuration fields

These fields show the values for the menu items. If an item is user-configurable, you can change the value of the field opposite the item. You cannot select an item that is not user-configurable.

A configurable field is enclosed in brackets, and is highlighted when selected. To change the value of a field, select it then press <Enter> to display a list of options. Refer to "2.2.7 Pop-up window."

2.2.7 Pop-up window

Select a menu item then press <Enter> to display a pop-up window with the configuration options for that item.

2.2.8 Scroll bar

A scroll bar appears on the right side of a menu screen when there are items that do not fit on the screen. Press the Up/Down arrow keys or <Page Up> /<Page Down> keys to display the other items on the screen.

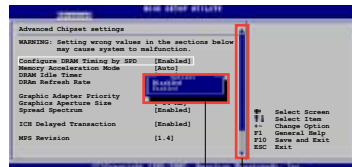

Pop-up window

Scroll bar

2.2.9 General help

At the top right corner of the menu screen is a brief description of the selected item.

2.3 Main menu

When you enter the BIOS Setup program, the Main menu screen appears, giving you an overview of the basic system information.



Refer to section "2.2.1 BIOS menu screen" for information on the menu screen items and how to navigate through them.



2.3.1 System Time [xx:xx:xx]

Allows you to set the system time.

2.3.2 System Date [Day xx/xx/xxxx]

Allows you to set the system date.

2.3.3 Legacy Diskette A [1.44M, 3.5 in.]

Sets the type of floppy drive installed. Configuration options: [Disabled] [360K, 5.25 in.] [1.2M, 5.25 in.] [720K, 3.5 in.] [1.44M, 3.5 in.] [2.88M, 3.5 in.]

2.3.4 Primary, Third and Fourth IDE Master/Slave

While entering Setup, the BIOS automatically detects the presence of IDE devices. There is a separate sub-menu for each IDE device. Select a device item then press <Enter> to display the IDE device information.

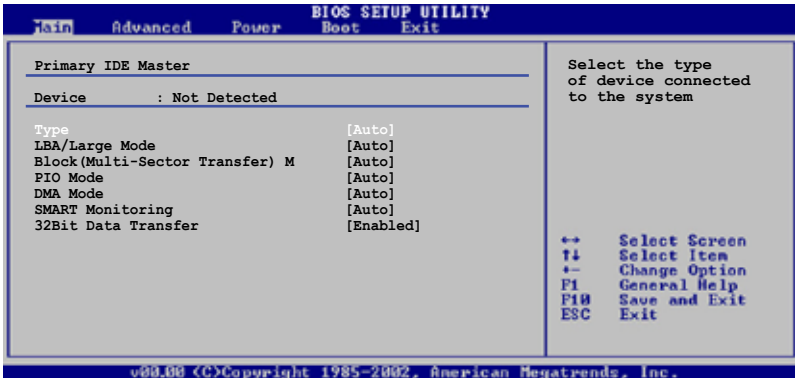

The BIOS automatically detects the values opposite the dimmed items (Device, Vendor, Size, LBA Mode, Block Mode, PIO Mode, Async DMA, Ultra DMA, and SMART monitoring). These values are not user-configurable. These items show N/A if no IDE device is installed in the system.

Type [Auto]

Selects the type of IDE drive. Setting to Auto allows automatic selection of the appropriate IDE device type. Select CDROM if you are specifically configuring a CD-ROM drive. Select ARMD (ATAPI Removable Media Device) if your device is either a ZIP, LS-120, or MO drive. Configuration options: [Not Installed] [Auto] [CDROM] [ARMD]

LBA/Large Mode [Auto]

Enables or disables the LBA mode. Setting to Auto enables the LBA mode if the device supports this mode, and if the device was not previously formatted with LBA mode disabled. Configuration options: [Disabled] [Auto]

Block (Multi-sector Transfer) M [Auto]

Enables or disables data multi-sectors transfers. When set to Auto, the data transfer from and to the device occurs multiple sectors at a time if the device supports multi-sector transfer feature. When set to [Disabled], the data transfer from and to the device occurs one sector at a time. Configuration options: [Disabled] [Auto]

PIO Mode [Auto]

Selects the PIO mode.

Configuration options: [Auto] [0] [1] [2] [3] [4]

DMA Mode [Auto]

Selects the DMA mode. Configuration options: [Auto]

SMART Monitoring [Auto]

Sets the Smart Monitoring, Analysis, and Reporting Technology.

Configuration options: [Auto] [Disabled] [Enabled]

32Bit Data Transfer [Enabled]

Enables or disables 32-bit data transfer.

Configuration options: [Disabled] [Enabled]

2.3.5 IDE Configuration

The items in this menu allow you to set or change the configurations for the IDE devices installed in the system. Select an item then press <Enter> if you wish to configure the item.

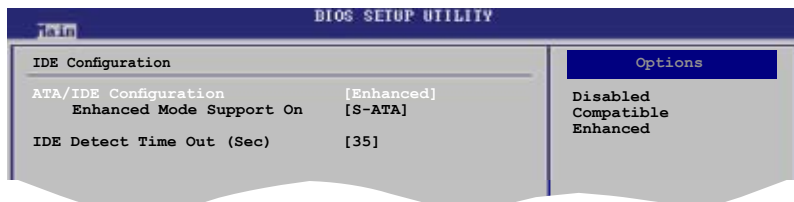

ATA/IDE Configuration [Enhanced]

Configuration options: [Disabled] [Compatible] [Enhanced]

Enhanced Mode Support On [S-ATA]

Configuration options: [S-ATA+P-ATA] [S-ATA] [P-ATA]

IDE Detect Time Out [35]

Selects the time out value for detecting ATA/ATAPI devices.

Configuration options: [0] [5] [10] [15] [20] [25] [30] [35]

2.3.6 System Information

This menu gives you an overview of the general system specifications. The BIOS automatically detects the items in this menu.

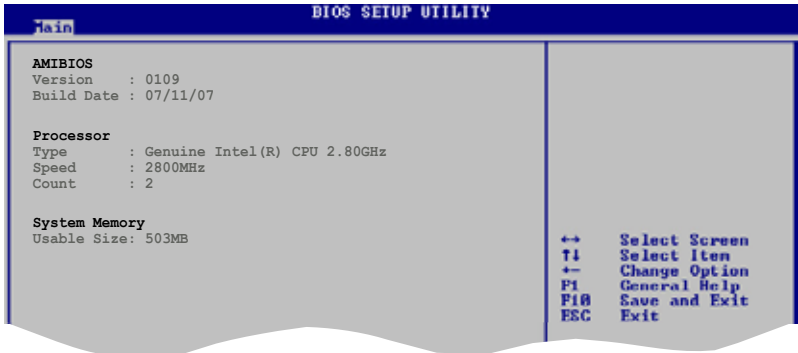

AMI BIOS

Displays the auto-detected BIOS information.

Processor

Displays the auto-detected CPU specification.

System Memory

Displays the auto-detected system memory.

2.4 Advanced menu

The Advanced menu items allow you to change the settings for the CPU and other system devices.



Take caution when changing the settings of the Advanced menu items. Incorrect field values can cause the system to malfunction.



2.4.1 JumperFree Configuration

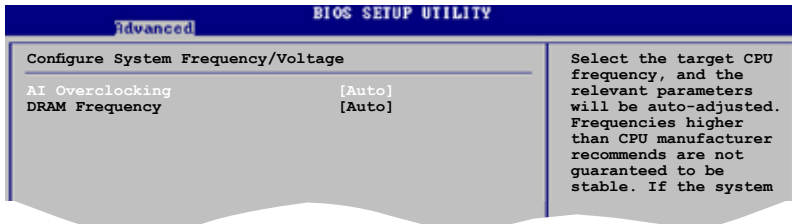

AI Overclocking [Auto]

Allows selection of CPU overclocking options to achieve desired CPU internal frequency. Select either one of the preset overclocking configuration options:

Manual - allows you to individually set overclocking parameters.

Auto - loads the optimal settings for the system.

Overclock Profile - loads overclocking profiles with optimal parameters for stability when overclocking.



The following item appears only when you set the AI Overclocking item to [Manual].

CPU Frequency [XXX]

Displays the frequency sent by the clock generator to the system bus and PCI bus. The value of this item is auto-detected by the BIOS. Use the <+> and <-> keys to adjust the CPU frequency. You can also type the desired CPU frequency using the numeric keypad. The values range from 133 to 400. Refer to the table below for the correct Front Side Bus and CPU External Frequency settings.

FSB/CPU External Frequency Synchronization

Front Side Bus	CPU External Frequency
FSB 1066	266 MHz
FSB 800	200 MHz
FSB 533	133 MHz

PCI Express Frequency [Auto]

Allows you to select PCI express frequency. Configuration options: [Auto] [90] [91] [92] [93] [94] [95] [96] [97] [98] [99] [100] [101] [102] [103] [104]

DRAM Frequency [Auto]

Allows you to set the DDR2 operating frequency.

Configuration options: [Auto] [533MHz] [667MHz] [800 MHz] [1067 MHz]



Selecting a very high DRAM frequency may cause the system to become unstable! If this happens, revert to the default setting.

2.4.2 USB Configuration

The items in this menu allows you to change the USB-related features. Select an item then press <Enter> to display the configuration options.

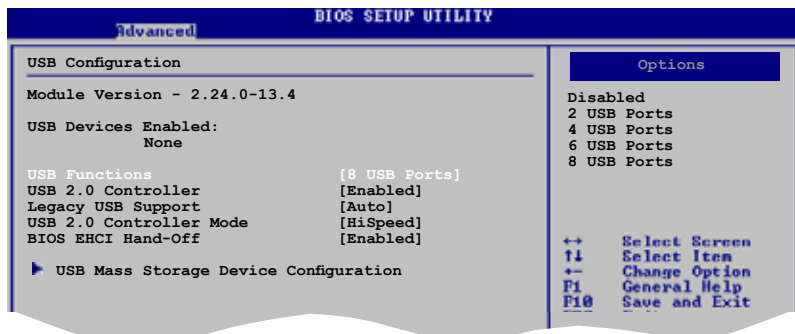

The Module Version and USB Devices Enabled items show the auto-detected values. If no USB device is detected, the item shows None.

USB Functions [8 USB Ports]

Allows you to disable or select the different values of the USB functions.

Configuration options: [Disabled] [2 USB Ports] [4 USB Ports] [6 USB Ports] [8 USB Ports]

USB 2.0 Controller [Enabled]

Allows you to enable or disable USB 2.0 controller. Configuration options:

[Enabled] [Disabled]

Legacy USB Support [Auto]

Allows you to enable or disable support for USB devices on legacy operating systems (OS). Setting to Auto allows the system to detect the presence of USB devices at startup. If detected, the USB controller legacy mode is enabled. If no USB device is detected, the legacy USB support is disabled.

Configuration options: [Disabled] [Enabled] [Auto]

USB 2.0 Controller Mode [HiSpeed]

Allows you to configure the USB 2.0 controller in HiSpeed (480 Mbps) or Full Speed (12 Mbps). Configuration options: [FullSpeed] [HiSpeed]

BIOS EHCI Hand-Off [Enabled]

Allows you to enable support for operating systems without an EHCI hand-off feature. Configuration options: [Disabled] [Enabled]

USB Mass Storage Device Configuration

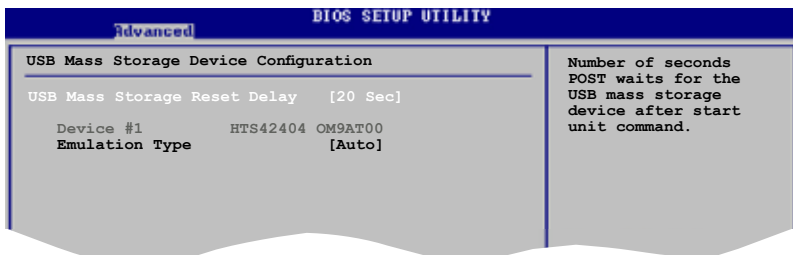

USB Mass Storage Reset Delay [20 Sec]

Sets the number of seconds POST waits for the USB mass storage device after start unit command. Configuration options: [10 Sec] [20 Sec] [30 Sec] [40 Sec]

Emulation Type [Auto]

Selects the Emulation type. When set to Auto, USB devices less than 530MB will be emulated as Floppy and remaining as hard drive. Forced FDD option can be used to force a HDD formatted drive to boost as FDD drive to boot as FDD. Configuration options: [Auto] [Floppy] [Forced FDD] [Hard Disk] [CDROM]

2.4.3 CPU Configuration

The items in this menu show the CPU-related information that the BIOS automatically detects.

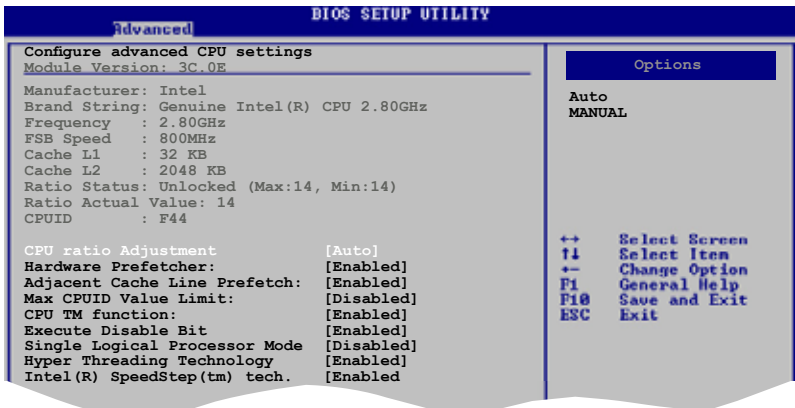

CPU ratio adjustment [Auto]

Allows you to select the CPU ratio adjustment mode. Select [Manual] to set Ratio CMOS Setting. Configuration options: [Auto] [Manual]

Ratio CMOS Setting [14]

Sets the ratio between the CPU Core Clock and the Front Side Bus frequency. The default value of this item is auto-detected by BIOS. Use the <+> - <-> keys to adjust the BIOS.

Hardware Prefetcher [Enabled]

Enables or disables the Hardware Prefetcher feature. Configuration options: [Disabled] [Enabled]

Adjacent Cache Line Prefetch [Enabled]

Enables or disables the Adjacent Cache Line Prefetch feature. Configuration options: [Disabled] [Enabled]

Max CPUID Value Limit [Disabled]

Enable this item to boot legacy operating systems that cannot support CPUs with extended CPUID functions. Configuration options: [Disabled] [Enabled]

CPU TM function [Enabled]

Allows you to enable or disable the CPU internal thermal control function. In TM mode, the CPU power consumption is reduced. Configuration options: [Disabled] [Enabled]

Execute Disable Bit [Enabled]

Allows you to Enable/disable Execute Disable Function.
Configuration options: [Disabled] [Enabled]

Single Logical Processor Mode [Disabled]

Allows you to enable or disable the Single Logical Processor Mode. When enabled, only CORE0, logical processor 0 remains active.
Configuration options: [Disabled] [Enabled]



The following item appears only when you installed an Intel® Pentium® 4 or later CPU that supports the Enhanced Intel SpeedStep® Technology (EIST).

Hyper Threading Technology [Enabled]

Allows you to enable or disable the processor Hyper-Threading Technology.
Configuration options: [Disabled] [Enabled]

Intel® SpeedStep Technology [Enabled]

Allows you to use the Enhanced Intel® SpeedStep® Technology. When set to [Enabled], you can adjust the system power settings in the operating system to use the EIST feature. Set this item to [Disabled] if you do not want to use the EIST.
Configuration options: [Enabled] [Disabled]

2.4.4 Chipset

The Chipset menu allows you to change the advanced chipset settings. Select an item then press <Enter> to display the sub-menu.

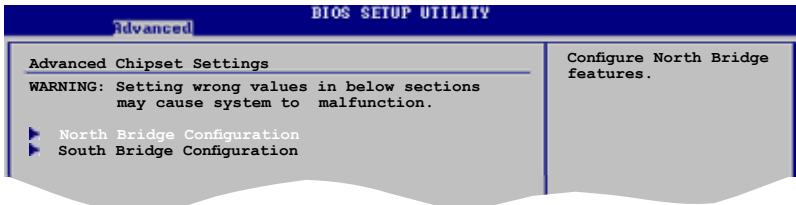

North Bridge Configuration

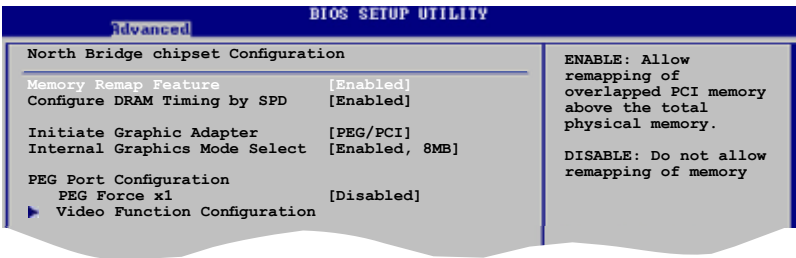

Memory Remap Feature [Enabled]

Allows you to enable or disable the remapping of overlapped PCI memory above the total physical memory. Configuration options: [Enabled] [Disabled]

Configure DRAM Timing by SPD [Enabled]

Allows you to enable or disable configuring DRAM Timing by SPD. Configuration options: [Enabled] [Disabled]

Initiate Graphic Adapter [PEG/PCI]

Allows you to select the graphics controller as the primary boot device. Configuration options: [IGD] [PCI/IGD] [PCI/PEG] [PEG/IGD] [PEG/PCI]

Internal Graphics Mode Select [Enabled, 8MB]

Allows you to select the amount of system memory used by the Internal graphics device. Configuration options: [Disabled] [Enabled, 1MB] [Enabled, 8MB]

PEG Port Configuration

PEG Force x1 [Disabled]

Allows you to enable or disable the PEG Force x 1. Configuration options: [Enabled] [Disabled]

Video Function Configuration

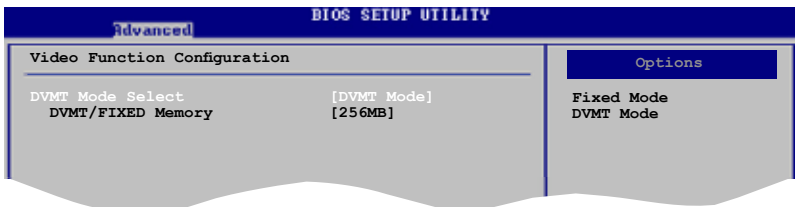

DVMT Mode Select [DVMT Mode]

Allows you to select the DVMT Mode. Configuration options: [Fixed Mode] [DVMT Mode]

DVMT/FIXED Memory [256MB]

Allows you to select the amount of the DVMT/FIXED Memory. Configuration options: [128MB] [256MB]

South Bridge Configuration

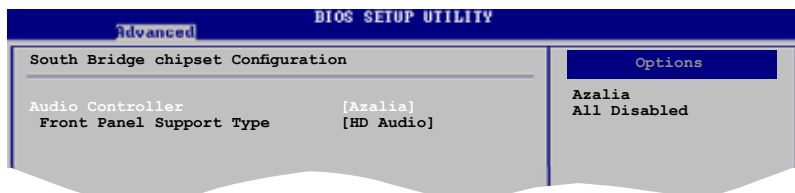

HD Audio Controller [Azalia]

Allows you to set the audio controller. Configuration options: [Azalia] [All Disabled]

Front Panel Support Type [HD Audio]

Allows you to select the front panel support type. If High Definition Audio Front Panel used, please set HD Audio mode. Configuration options: [AC97] [HD Audio]

2.4.5 Onboard Devices Configuration

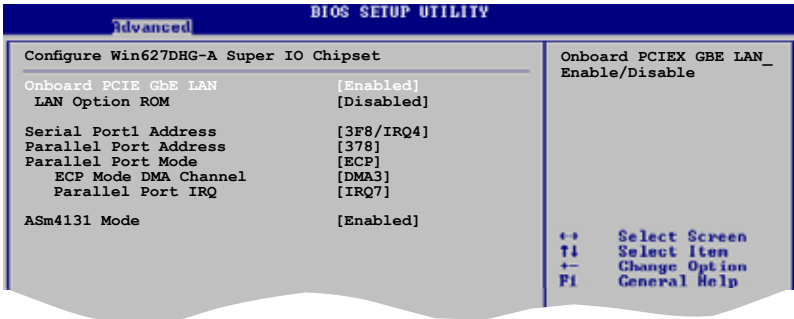

Onboard PCIE GbE LAN [Enabled]

Allows you to enable or disable the onboard LAN controller.

Configuration options: [Enabled] [Disabled]

LAN Option ROM [Disabled]

Allows you to enable or disable the boot ROM in the onboard LAN controller.

This item appears only when the Onboard LAN item is set to Enabled.

Configuration options: [Disabled] [Enabled]

Serial Port1 Address [3F8/IRQ4]

Allows you to select the Serial Port1 base address.

Configuration options: [Disabled] [3F8/IRQ4] [2F8/IRQ3] [3E8/IRQ4] [2E8/IRQ3]

Parallel Port Address [378]

Allows you to select the Parallel Port base addresses.

Configuration options: [Disabled] [378] [278] [3BC]

Parallel Port Mode [ECP]

Allows you to select the Parallel Port mode.

Configuration options: [Normal] [Bi-Directional] [EPP] [ECP]

ECP Mode DMA Channel [DMA3]

Appears only when the Parallel Port Mode is set to [ECP]. This item allows you to set the Parallel Port ECP DMA.

Configuration options: [DMA0] [DMA1] [DMA3]

Parallel Port IRQ [IRQ7]

Allows you to select parallel port IRQ. Configuration options: [IRQ5] [IRQ7]

ASM4131 Mode [Enable]

Allows you to enable or disable ASM4131 mode. Configuration options: [Disable] [Enable]

2.4.6 PCI PnP

The PCI PnP menu items allow you to change the advanced settings for PCI/PnP devices. The menu includes setting IRQ and DMA channel resources for either PCI/PnP or legacy ISA devices, and setting the memory size block for legacy ISA devices.



Take caution when changing the settings of the PCI PnP menu items. Incorrect field values can cause the system to malfunction.

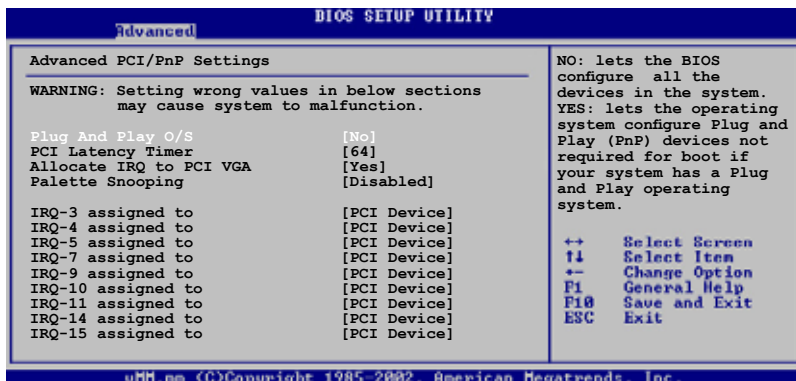

Plug and Play O/S [No]

When set to [No], BIOS configures all the devices in the system. When set to [Yes] and if you install a Plug and Play operating system, the operating system configures the Plug and Play devices not required for boot.

Configuration options: [No] [Yes]

PCI Latency Timer [64]

Allows you to select the value in units of PCI clocks for the PCI device latency timer register. Configuration options: [32] [64] [96] [128] [160] [192] [224] [248]

Allocate IRQ to PCI VGA [Yes]

When set to [Yes], BIOS assigns an IRQ to PCI VGA card if the card requests for an IRQ. When set to [No], BIOS does not assign an IRQ to the PCI VGA card even if requested. Configuration options: [Yes] [No]

Palette Snooping [Disabled]

When set to [Enabled], the palette snooping feature informs the PCI devices that an ISA graphics device is installed in the system so that the latter can function correctly. Configuration options: [Disabled] [Enabled]

IRQ-xx assigned to [PCI Device]

When set to [PCI Device], the specific IRQ is free for use of PCI/PnP devices. When set to [Reserved], the IRQ is reserved for legacy ISA devices. Configuration options: [PCI Device] [Reserved]

2.5 Power menu

The Power menu items allow you to change the settings for the Advanced Power Management (APM). Select an item then press <Enter> to display the configuration options.

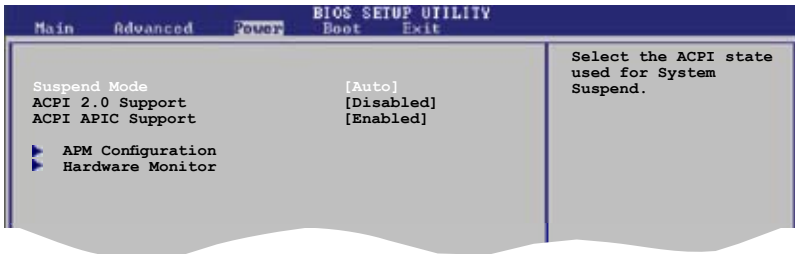

2.5.1 Suspend Mode [Auto]

Allows you to select the Advanced Configuration and Power Interface (ACPI) state to be used for system suspend.

Configuration options: [S1 (POS) Only] [S3 Only] [Auto]

2.5.2 ACPI 2.0 Support [Disabled]

Allows you to add more tables for Advanced Configuration and Power Interface (ACPI) 2.0 specifications.

Configuration options: [Disabled] [Enabled]

2.5.3 ACPI APIC Support [Enabled]

Allows you to enable or disable the Advanced Configuration and Power Interface (ACPI) support in the Application-Specific Integrated Circuit (ASIC). When set to Enabled, the ACPI APIC table pointer is included in the RSDT pointer list.

Configuration options: [Disabled] [Enabled]

2.5.4 APM Configuration

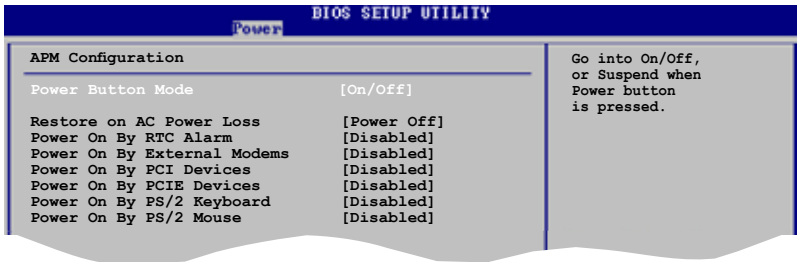

Power Button Mode [On/Off]

Allows you to set the power button mode. Configuration options: [On/Off] [Suspend]

Restore on AC Power Loss [Power Off]

When set to Power Off, the system goes into off state after an AC power loss. When set to Power On, the system goes on after an AC power loss. When set to Last State, the system goes into either off or on state, whatever the system state was before the AC power loss. Configuration options: [Power Off] [Power On] [Last State]

Power On By RTC Alarm [Disabled]

Allows you to enable or disable RTC to generate a wake event. When this item is set to Enabled, the items RTC Alarm Date, RTC Alarm Hour, RTC Alarm Minute, and RTC Alarm Second appear with set values. Configuration options: [Disabled] [Enabled]

Power On By External Modems [Disabled]

This allows either settings of [Enabled] or [Disabled] for powering up the computer when the external modem receives a call while the computer is in Soft-off mode. Configuration options: [Disabled] [Enabled]



The computer cannot receive or transmit data until the computer and applications are fully running. Thus, connection cannot be made on the first try. Turning an external modem off and then back on while the computer is off causes an initialization string that turns the system power on.

Power On By PCI Devices [Disabled]

When set to [Enabled], this parameter allows you to turn on the system through a PCI LAN or modem card. This feature requires an ATX power supply that provides at least 1A on the +5VSB lead. Configuration options: [Disabled] [Enabled]

Power On By PCI Express Devices [Disabled]

When set to [Enabled], this parameter allows you to turn on the system through a PCI Express card. This feature requires an ATX power supply that provides at least 1A on the +5VSB lead. Configuration options: [Disabled] [Enabled]

Power On By PS/2 Keyboard [Disabled]

Allows you to use specific keys on the keyboard to turn on the system. This feature requires an ATX power supply that provides at least 1A on the +5VSB lead. Configuration options: [Disabled] [Space Bar] [Ctrl-Esc] [Power Key]

Power On By PS/2 Mouse [Disabled]

When set to [Enabled], this parameter allows you to use the PS/2 mouse to turn on the system. This feature requires an ATX power supply that provides at least 1A on the +5VSB lead. Configuration options: [Disabled] [Enabled]

2.5.5 Hardware Monitor

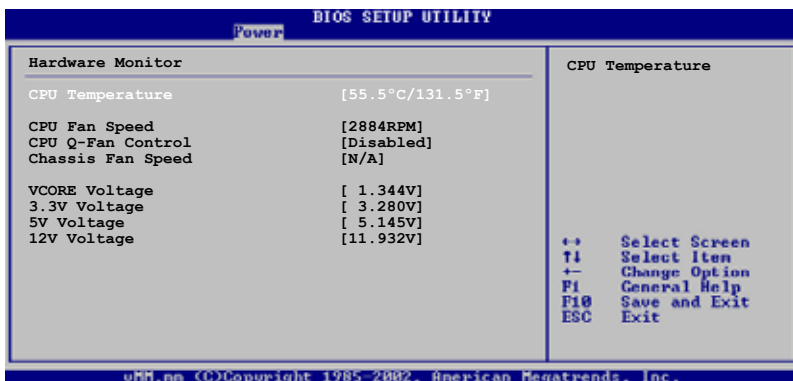

CPU Temperature [xxx°C/xxx°F]

The onboard hardware monitor automatically detects and displays the CPU temperatures. Select Ignored if you do not wish to display the detected temperatures.

CPU Fan Speed (RPM) [xxxxRPM] or [N/A] or [Ignored]

The onboard hardware monitor automatically detects and displays the CPU fan speed in rotations per minute (RPM). If the fan is not connected to the motherboard, the field shows N/A. Select Ignored if you do not wish to display the detected speed.

CPU Q-Fan Control [Disabled]

Allows you to enable or disable the Q-Fan control. Configuration options: [Disabled] [Enabled]

Chassis Fan Speed [xxxxRPM] or [N/A] or [Ignored]

The onboard hardware monitor automatically detects and displays the chassis fan speed in rotations per minute (RPM). If the fan is not connected to the chassis, the specific field shows N/A. Select Ignored if you do not wish to display the detected speed.

VCORE Voltage, 3.3V Voltage, 5V Voltage, 12V Voltage

The onboard hardware monitor automatically detects the voltage output through the onboard voltage regulators.

2.6 Boot menu

The Boot menu items allow you to change the system boot options. Select an item then press <Enter> to display the sub-menu.

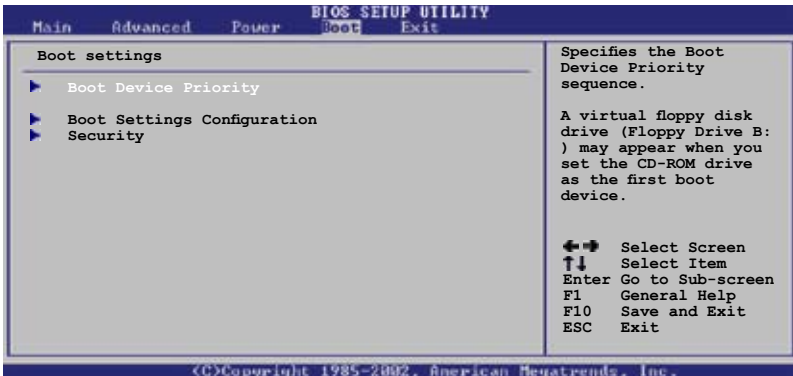

2.6.1 Boot Device Priority

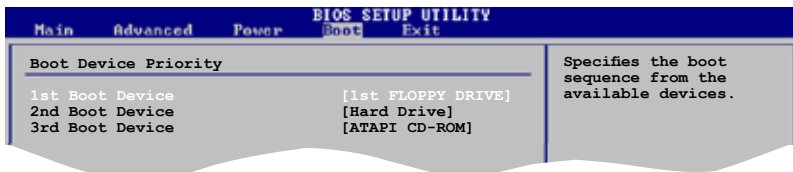

1st ~ xxth Boot Device [1st Floppy Drive]

These items specify the boot device priority sequence from the available devices. The number of device items that appears on the screen depends on the number of devices installed in the system. Configuration options: [xxxx Drive] [Disabled]

2.6.2 Boot Settings Configuration

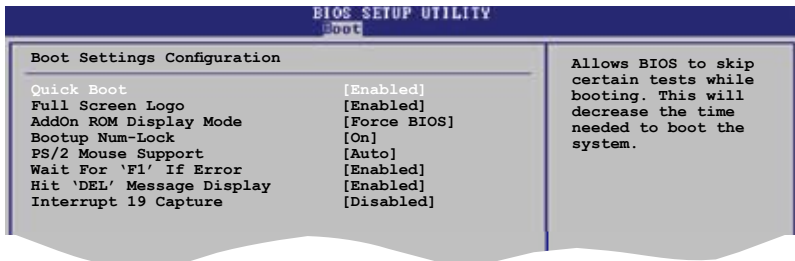

Quick Boot [Enabled]

Enabling this item allows the BIOS to skip some power on self tests (POST) while booting to decrease the time needed to boot the system. When set to [Disabled], BIOS performs all the POST items. Configuration options: [Disabled] [Enabled]

Full Screen Logo [Enabled]

This allows you to enable or disable the full screen logo display feature. Configuration options: [Disabled] [Enabled]



Set this item to [Enabled] to use the ASUS MyLogo2™ feature.

Add On ROM Display Mode [Force BIOS]

Sets the display mode for option ROM. Configuration options: [Force BIOS] [Keep Current]

Bootup Num-Lock [On]

Allows you to select the power-on state for the NumLock. Configuration options: [Off] [On]

PS/2 Mouse Support [Auto]

Allows you to enable or disable support for PS/2 mouse. Configuration options: [Disabled] [Enabled] [Auto]

Wait for 'F1' If Error [Enabled]

When set to Enabled, the system waits for the F1 key to be pressed when error occurs. Configuration options: [Disabled] [Enabled]

Hit 'DEL' Message Display [Enabled]

When set to Enabled, the system displays the message "Press DEL to run Setup" during POST. Configuration options: [Disabled] [Enabled]

Interrupt 19 Capture [Disabled]

When set to [Enabled], this function allows the option ROMs to trap Interrupt 19. Configuration options: [Disabled] [Enabled]

2.6.3 Security

The Security menu items allow you to change the system security settings. Select an item then press <Enter> to display the configuration options.

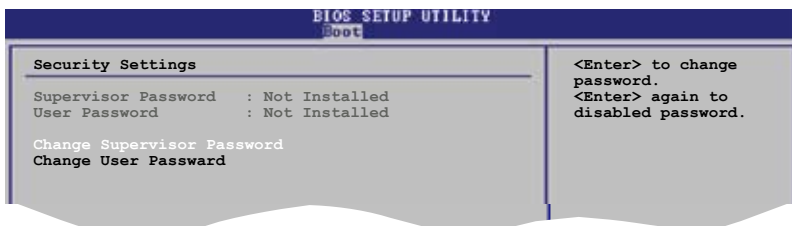

Change Supervisor Password

Select this item to set or change the supervisor password. The Supervisor Password item on top of the screen shows the default Not Installed. After you set a password, this item shows Installed.

To set a Supervisor Password:

1. Select the Change Supervisor Password item and press <Enter>.
2. From the password box, type a password composed of at least six letters and/or numbers, then press <Enter>.
3. Confirm the password when prompted.

The message "Password Installed" appears after you successfully set your password.

To change the supervisor password, follow the same steps as in setting a user password.

To clear the supervisor password, select the Change Supervisor Password then press <Enter>. The message "Password Uninstalled" appears.



If you forget your BIOS password, you can clear it by erasing the CMOS Real Time Clock (RTC) RAM. See section "1.9 Jumpers" for information on how to erase the RTC RAM.

After you have set a supervisor password, the other items appear to allow you to change other security settings.

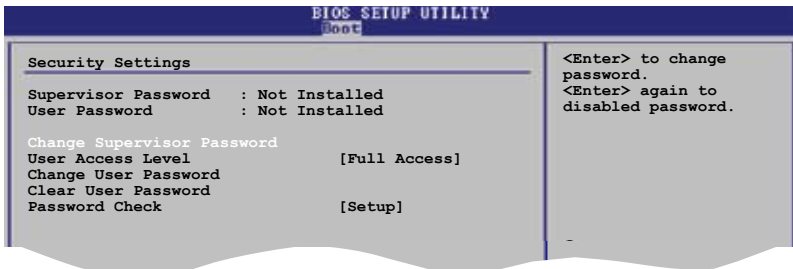

User Access Level [Full Access]

This item allows you to select the access restriction to the Setup items. Configuration options: [No Access] [View Only] [Limited] [Full Access]

No Access prevents user access to the Setup utility.

View Only allows access but does not allow change to any field.

Limited allows changes only to selected fields, such as Date and Time.

Full Access allows viewing and changing all the fields in the Setup utility.

Change User Password

Select this item to set or change the user password. The User Password item on top of the screen shows the default Not Installed. After you set a password, this item shows Installed.

To set a User Password:

1. Select the Change User Password item and press <Enter>.
2. On the password box that appears, type a password composed of at least six letters and/or numbers, then press <Enter>.
3. Confirm the password when prompted.

The message "Password Installed" appears after you set your password successfully.

To change the user password, follow the same steps as in setting a user password.

Clear User Password

Select this item to clear the user password.

Password Check [Setup]

When set to [Setup], BIOS checks for user password when accessing the Setup utility. When set to [Always], BIOS checks for user password both when accessing Setup and booting the system. Configuration options: [Setup] [Always]

2.7 Tools menu

The Tools menu items allow you to launch special functions. Select an item then press <Enter> to display the sub-menu.

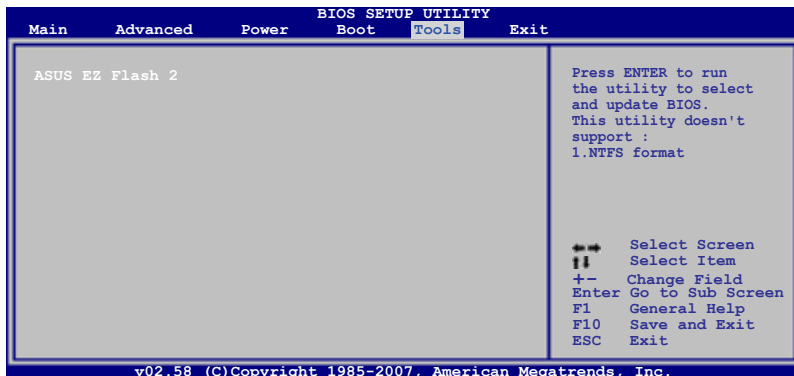

2.7.1 ASUS EZ Flash 2

Allows you to run ASUS EZ Flash 2. When you press <Enter>, a confirmation message appears. Use the left/right arrow key to select between [Yes] or [No], then press <Enter> to confirm your choice. See page 2-3, section 2.1.2 for details.

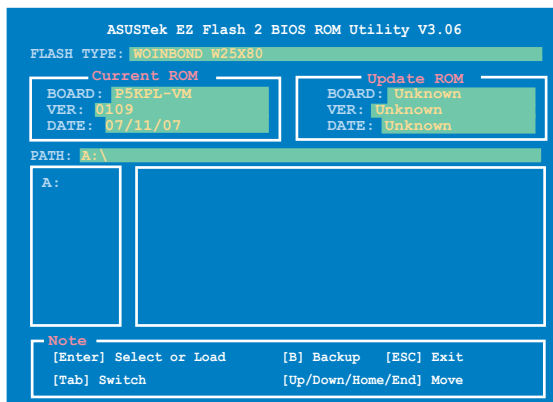

- This function can not support IDE CD-ROM, IDE DVD-ROM, or External SATA devices.
- This function only supports FAT 32/16 format.

2.8 Exit menu

The Exit menu items allow you to load the optimal or failsafe default values for the BIOS items, and save or discard your changes to the BIOS items.

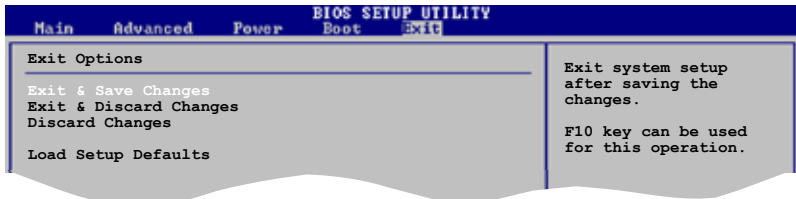

Pressing <Esc> does not immediately exit this menu. Select one of the options from this menu or <F10> from the legend bar to exit.

Exit & Save Changes

Once you are finished making your selections, choose this option from the Exit menu to ensure the values you selected are saved to the CMOS RAM. An onboard backup battery sustains the CMOS RAM so it stays on even when the PC is turned off. When you select this option, a confirmation window appears. Select **OK** to save changes and exit.



If you attempt to exit the Setup program without saving your changes, the program prompts you with a message asking if you want to save your changes before exiting. Press <Enter> to save the changes while exiting.

Exit & Discard Changes

Select this option only if you do not want to save the changes that you made to the Setup program. If you made changes to fields other than System Date, System Time, and Password, the BIOS asks for a confirmation before exiting.

Discard Changes

This option allows you to discard the selections you made and restore the previously saved values. After selecting this option, a confirmation appears. Select **OK** to discard any changes and load the previously saved values.

Load Setup Defaults

This option allows you to load the default values for each of the parameters on the Setup menus. When you select this option or if you press <F5>, a confirmation window appears. Select **OK** to load default values. Select **Exit & Save Changes** or make other changes before saving the values to the non-volatile RAM.

This chapter describes the contents of the support CD that comes with the motherboard package.

3 Software support

3.1 Installing an operating system

This motherboard supports Windows® 2000/2000 Server/2003 Server/32-bit XP/32-bit Vista/64-bit 2003 Server/64-bit XP/64-bit Vista operating systems (OS). Always install the latest OS version and corresponding updates to maximize the features of your hardware.



- Motherboard settings and hardware options vary. Use the setup procedures presented in this chapter for reference only. Refer to your OS documentation for detailed information.
- Make sure that you install Windows® 2003 Service Pack 4 or the Windows® XP Service Pack2 or later versions before installing the drivers for better compatibility and system stability.

3.2 Support CD information

The support CD that came with the motherboard package contains the drivers, software applications, and utilities that you can install to avail all motherboard features.



The contents of the support CD are subject to change at any time without notice. Visit the ASUS website(www.asus.com) for updates.

3.2.1 Running the support CD

Place the support CD to the optical drive. The CD automatically displays the Drivers menu if Autorun is enabled in your computer.



Click an icon to display support CD/motherboard information

Click an item to install



If Autorun is NOT enabled in your computer, browse the contents of the support CD to locate the file **ASSETUP.EXE** from the **BIN** folder. Double-click the **ASSETUP.EXE** to run the CD.

3.2.2 Drivers menu

The drivers menu shows the available device drivers if the system detects installed devices. Install the necessary drivers to activate the devices.

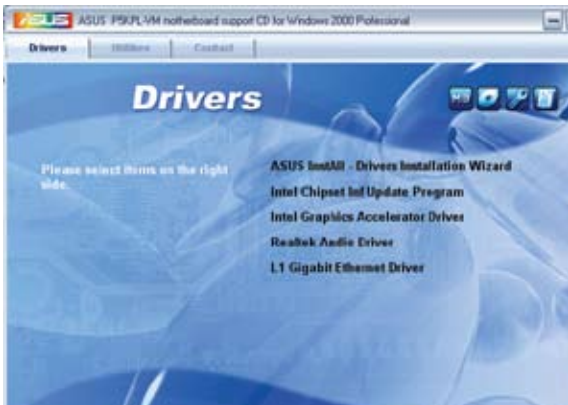

ASUS InstAll-Drivers Installation Wizard

Installs the ASUS InstAll-Drivers Installation Wizard.

Intel Chipset Inf Update Program

Installs the Intel® chipset Inf update program.

Intel Graphics Accelerator Driver

Installs the Intel Graphics Accelerator driver.

Realtek Audio Driver

Installs the Realtek audio driver and application.

L1 Gigabit Ethernet Driver

Installs the L1 Gigabit Ethernet driver and application.

3.2.3 Utilities menu

The Utilities menu shows the applications and other software that the motherboard supports.



ASUS InstAll-Installation Wizard for Utilities

Installs all of the utilities through the Installation Wizard.

ASUS Update

The ASUS Update utility allows you to update the motherboard BIOS in a Windows® environment. This utility requires an Internet connection either through a network or an Internet Service Provider (ISP).

ASUS PC Probe II

This smart utility monitors the fan speed, CPU temperature, and system voltages, and alerts you of any detected problems. This utility helps you keep your computer in healthy operating condition.

3.2.4 ASUS Contact information

Click the Contact tab to display the ASUS contact information. You can also find this information on the inside front cover of this user guide.

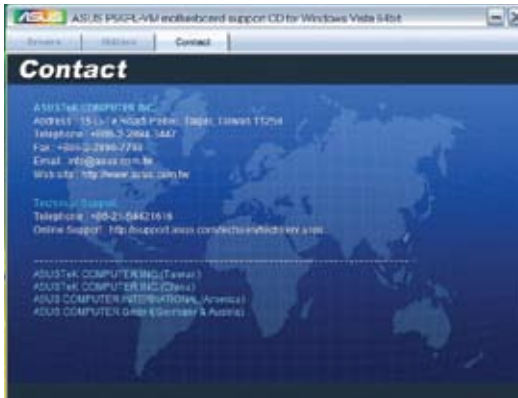

The Appendix describes the CPU features and technologies that the motherboard supports.

Appendix **CPU features**

A.1 Intel® EM64T



- The motherboard is fully compatible with Intel® Pentium® 4 LGA775 processors running on 32-bit operating systems.
 - The motherboard comes with a BIOS file that supports EM64T. You can download the latest BIOS file from the ASUS website (www.asus.com/support/download/) if you need to update the BIOS file. See Chapter 2 for details.
 - Visit www.intel.com for more information on the EM64T feature.
 - Visit www.microsoft.com for more information on Windows® 64-bit OS.
-

Using the Intel® EM64T feature

To use the Intel® EM64T feature:

1. Install an Intel® Pentium® 4 CPU that supports the Intel® EM64T.
2. Install a 64-bit operating system (Windows® XP Professional x64 Edition or Windows® Server 2003 x64 Edition).
3. Install the 64-bit drivers for the motherboard components and devices from the support CD.
4. Install the 64-bit drivers for expansion cards or add-on devices, if any.



Refer to the expansion card or add-on device(s) documentation, or visit the related website, to verify if the card/device supports a 64-bit system.

A.2 Enhanced Intel SpeedStep® Technology (EIST)



- The motherboard comes with a BIOS file that supports EIST. You can download the latest BIOS file from the ASUS website (www.asus.com/support/download/) if you need to update the BIOS. See Chapter 2 for details.
 - Visit www.intel.com for more information on the EIST feature.
-

A.2.1 System requirements

Before using EIST, check your system if it meets the following requirements:

- Intel® Pentium® 4 processor with EIST support
- BIOS file with EIST support
- Operating system with EIST support (Windows® XP SP2/Windows® Server 2003 SP1/Linux 2.6 kernel or later versions)

A.2.2 Using the EIST

To use the EIST feature:

1. Turn on the computer, then enter the BIOS Setup.
2. Go to the Advanced Menu, highlight CPU Configuration, then press <Enter>.
3. Set the **Intel(R) SpeedStep Technology** item to [Automatic], then press <Enter>.
4. Press <F10> to save your changes and exit the BIOS setup.
5. After the computer restarts, right click on a blank space on the desktop, then select Properties from the pop-up menu.
6. When the Display Properties window appears, click the **Screen Saver** tab.
7. Click the Power button on the Monitor power section to open the Power Options Properties window.

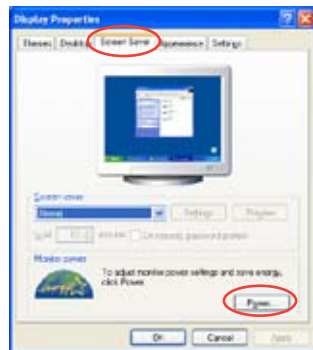

8. On the Power schemes section, click , then select any option except Home/Office Desktop or Always On.
9. Click Apply, then click OK.
10. Close the Display Properties window. After you adjust the power scheme, the CPU internal frequency slightly decreases when the CPU loading is low.

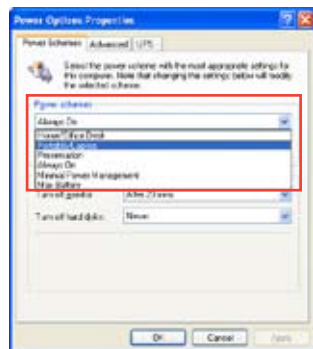

The screen displays and procedures may vary depending on the operating system.

A.3 Intel® Hyper-Threading Technology



-
- The motherboard supports Intel® Pentium® 4 LGA775 processors with Hyper-Threading Technology.
 - Hyper-Threading Technology is supported under Windows® XP/2003 Server and Linux 2.4.x (kernel) and later versions only. Under Linux, use the Hyper-Threading compiler to compile the code. If you are using any other operating systems, disable the Hyper-Threading Technology item in the BIOS to ensure system stability and performance.
 - Installing Windows® XP Service Pack 1 or later version is recommended.
 - Make sure to enable the Hyper-Threading Technology item in BIOS before installing a supported operating system.
 - For more information on Hyper-Threading Technology, visit www.intel.com/info/hyperthreading.
-

Using the Hyper-Threading Technology

To use the Hyper-Threading Technology:

1. Install an Intel® Pentium® 4 CPU that supports Hyper-Threading Technology.
2. Power up the system and enter the BIOS Setup. Under the Advanced Menu, make sure that the item Hyper-Threading Technology is set to Enabled.
The BIOS item appears only if you installed a CPU that supports Hyper-Threading Technology.
3. Restart the computer.

Free Manuals Download Website

<http://myh66.com>

<http://usermanuals.us>

<http://www.somanuals.com>

<http://www.4manuals.cc>

<http://www.manual-lib.com>

<http://www.404manual.com>

<http://www.luxmanual.com>

<http://aubethermostatmanual.com>

Golf course search by state

<http://golfingnear.com>

Email search by domain

<http://emailbydomain.com>

Auto manuals search

<http://auto.somanuals.com>

TV manuals search

<http://tv.somanuals.com>