



# FS3102 Hardware Installation Guide

Version 1.0

**European Headquarters**

Plasmon Data Limited,  
Whiting Way,  
Melbourn,  
Hertfordshire ,  
SG8 6EN,  
U.K.

Tel: +44 (0) 1763 262963  
Fax: +44 (0) 1763 264444

**For more information:**

[www.raidtec.com](http://www.raidtec.com)  
support@plasmon.co.uk

**Raidtec**  
SOLUTIONS

Plasmon and Raidtec are registered trademarks of Plasmon Plc. Copyright 2005

## Table of Contents

<b>1</b>	<b>Preface</b>	<b>5</b>
<b>1.1</b>	<b>Introduction</b>	<b>5</b>
<b>1.2</b>	<b>Disclaimer</b>	<b>5</b>
<b>1.3</b>	<b>Trademarks</b>	<b>5</b>
<b>1.4</b>	<b>Modifications</b>	<b>5</b>
<b>1.5</b>	<b>FCC Radio Frequency Interference Statement</b>	<b>6</b>
<b>1.6</b>	<b>FCC Booklet Information</b>	<b>6</b>
<b>1.7</b>	<b>Shielded Cables</b>	<b>6</b>
<b>1.8</b>	<b>Compliance</b>	<b>6</b>
1.8.1	CANADA:	6
1.8.2	EUROPE:	6
<b>2</b>	<b>FS3102 System Overview</b>	<b>7</b>
<b>3</b>	<b>General Precautions and Electrical Considerations</b>	<b>8</b>
<b>3.1</b>	<b>Cleaning Instructions</b>	<b>9</b>
<b>4</b>	<b>Safety and Emissions</b>	<b>10</b>
<b>4.1</b>	<b>Safety</b>	<b>10</b>
<b>4.2</b>	<b>FC Lasers.</b>	<b>10</b>
<b>4.3</b>	<b>Emissions</b>	<b>10</b>
<b>4.4</b>	<b>Immunity</b>	<b>10</b>
<b>4.5</b>	<b>Safe Handling</b>	<b>10</b>
<b>5</b>	<b>Familiarising yourself with the system</b>	<b>11</b>
<b>5.1</b>	<b>Unpacking</b>	<b>11</b>
<b>5.2</b>	<b>What's in the box</b>	<b>12</b>
<b>5.3</b>	<b>System Views</b>	<b>13</b>
5.3.1	System Front View	13
5.3.2	System LED Indicators	13
5.3.3	System Back View	14
5.3.4	Controller Indicators	14
<b>6</b>	<b>Installing the FS3102 system</b>	<b>16</b>
<b>6.1</b>	<b>Installing Disk Drives</b>	<b>16</b>
<b>6.2</b>	<b>Installing SFPs (Optical transceivers)</b>	<b>16</b>
6.2.1	SFP Removal	17
6.2.2	SFP Replacement	17
<b>6.3</b>	<b>Installing a Host Bus Adaptor (HBA)</b>	<b>17</b>
<b>6.4</b>	<b>Cabling the Host and the FS3102</b>	<b>18</b>
6.4.1	Single Port/Host DAS Configuration	18
6.4.2	Dual Port, Single Host SAN configuration.	18
6.4.3	Dual Port, Multi Host DAS Configuration.	19
<b>7</b>	<b>Configuring the FS3102</b>	<b>20</b>
<b>8</b>	<b>Battery Backup Unit (BBU)</b>	<b>21</b>
<b>8.1</b>	<b>Data Hold Time</b>	<b>21</b>
<b>8.2</b>	<b>Maximum Memory Current</b>	<b>21</b>

<b>8.3</b>	<b>Battery Pack Replacement Policy</b>	<b>21</b>
<b>8.4</b>	<b>BBU Indicators</b>	<b>21</b>
<b>9</b>	<b>Field Replaceable Units (FRUs)</b>	<b>22</b>
<b>10</b>	<b>Plasmon Technical Support.</b>	<b>23</b>
<b>Appendix A - Alerts</b>		<b>24</b>
<b>Failure Events</b>		<b>24</b>
<b>Alert Messages</b>		<b>26</b>
Notifications		26
Warnings		26
<b>Appendix B - RAID Features</b>		<b>28</b>
<b>RAID Levels</b>		<b>28</b>
<b>Logical Volumes</b>		<b>28</b>
<b>RAID Creation</b>		<b>28</b>
<b>RAID Expansion</b>		<b>28</b>
Expansion By Row		28
Expansion By Column		28
<b>RAID Verify</b>		<b>29</b>
<b>Stripe Size</b>		<b>29</b>
<b>Stripe Unit Size</b>		<b>29</b>
<b>Caching</b>		<b>29</b>
Read Cached Data		29
Streaming Read Data		29
Write Cached Data		29
<b>Auto Rebuild</b>		<b>30</b>
Disabled		30
Priority		30
Background		30
<b>Appendix C - System Specifications</b>		<b>31</b>
<b>Electrical Characteristics</b>		<b>31</b>
Voltage Rating		31
Current Consumption		31
Power Consumption		31
<b>Environmental Conditions</b>		<b>31</b>
Temperature		31
Relative Humidity		31
Altitude		31
Shock		31
Vibration		31
Air Flow		32
<b>Mechanical Specifications</b>		<b>32</b>
Weight		32
Dimensions		32
<b>Appendix D - Supported Disk Drives</b>		<b>33</b>
<b>Supported Drive List</b>		<b>33</b>
<b>Appendix E - Ethernet Interface References</b>		<b>34</b>
<b>Supported Interfaces</b>		<b>34</b>
<b>Supported Protocols</b>		<b>34</b>
HTTP (Web)		34
SMTP (Email)		34
SNMP Traps		34

<b>Default IP Address</b>	<b>34</b>
Restoring Default IP Address	34

# 1 Preface

## 1.1 Introduction

This document has been produced to outline the steps required to install a Raidtec FS3102 Raid system. The document also includes some of the features available and includes the systems specifications. Refer to the FS3102 Management User Guide for detailed instructions on installing the Raidtec Manager™ software.

## 1.2 Disclaimer

The information in this document is subject to change without notice and should not be construed as a commitment by Plasmon Data Ltd. or its agents. Plasmon Data Ltd. assumes no responsibility for any errors that may appear in this document except in so far as alterations may be made subsequent to receiving written indication of the information concerned.

The product description in this document is intended solely for use in operation, installation and maintenance of the Plasmon Data Ltd. *Plasmon Raidtec FS3102* Subsystem. Use of this document for all other purposes, without prior written approval from Plasmon Data Ltd. is prohibited.

Copyright © 2005  
Plasmon Data Limited  
Whiting Way, Melbourn  
Nr. Royston Hertfordshire  
United Kingdom SG8 6EN

All rights reserved. No part of this document may be reproduced, photocopied, stored on a retrieval system, or transmitted without express permission of Plasmon Data Ltd.

## 1.3 Trademarks

*FS3102* is a trademark of Plasmon Data Ltd. All other names, brands, products and services are trademarks or registered trademarks of their respective companies.

## 1.4 Modifications

Changes or modifications not expressly approved by Plasmon Data Ltd. could void the user's warranty.

## 1.5 FCC Radio Frequency Interference Statement

This equipment generates, uses, and can radiate radio frequency energy. If not installed and used in strict accordance with the manufacturer's instructions, it may cause interference to radio and television reception. The limits are designed to provide reasonable protection against interference in a residential installation. However, there is no guarantee that interference will not occur in a particular installation.

**NOTE:** *This equipment has been tested and found to comply with the limits for a Class A computing device in accordance with the specifications in Subpart B of Part 15 of FCC rules.*

If this equipment does cause interference to radio or television reception, the user is encouraged to try one or more of the following corrective measures:

Reorient the receiving antenna.

Relocate the computer with respect to the receiver.

Move the computer away from the receiver.

Plug the computer into a different outlet so that computer and receiver are on different branch circuits.

Consult the dealer or an experienced radio/television technician for additional suggestions.

## 1.6 FCC Booklet Information

The following booklet, prepared by the Federal Communications Commission, may also be helpful in resolving interference issues:

*How to Identify and Resolve Radio/TV Interference Problems.*

This booklet is available from the U.S. Government Printing Office, Washington, DC 20401, Stock No. 004-000-00345-4.

## 1.7 Shielded Cables

Shielded Interference Cable(s) must be used according to FCC 15.838d.

## 1.8 Compliance

### 1.8.1 CANADA:

This digital apparatus does not exceed the Class A limits for noise emissions from digital apparatus set out in the Radio Interference Regulations of the Canadian Department of Communications.

Le présent appareil numérique n'émet pas de bruits radioélectriques dépassant les limites applicables aux appareils numériques de la class A prescrites dans le Règlement sur le brouillage radioélectrique édicté par le ministère des Communications du Canada.

### 1.8.2 EUROPE:



This device complies with EU EMC Directive 89/336/EEC and was assessed to the requirements of the following:  
EN 55022-1994+A1, A2 CISPR 22 Class A.  
EN 50082-1-1997 (EN 61000-4-2,3,4,5,6,11).



This product was designed, developed, and manufactured under an NQA registered I.S. EN ISO 9001-2000 quality system.

## 2 FS3102 System Overview

The Raidtec FS3102 2Gb FC-SATA RAID system includes the following pieces:

- 2Gb FC-SATA RAID controller that supports up to 16 SATA disk drives (only 12 are used in this product), two 2Gb FC target interfaces using SFPs and a 1 Gb Ethernet port for connectivity (management software and email alerts)
  - 256 MB of cache memory (1 GB optional)
- Battery Backup Unit (BBU) for maintaining power to the cache memory during power failures (optional)
- 2U 12 bay enclosure with two redundant PSU modules, three redundant fan modules and a backplane
- SATA disk drives in shuttles
  - Capacities supported are 250 GB, 400 GB and 500 GB
- Raidtec Manager Management Software for managing the RAID system
  - Java Application that runs on a host system

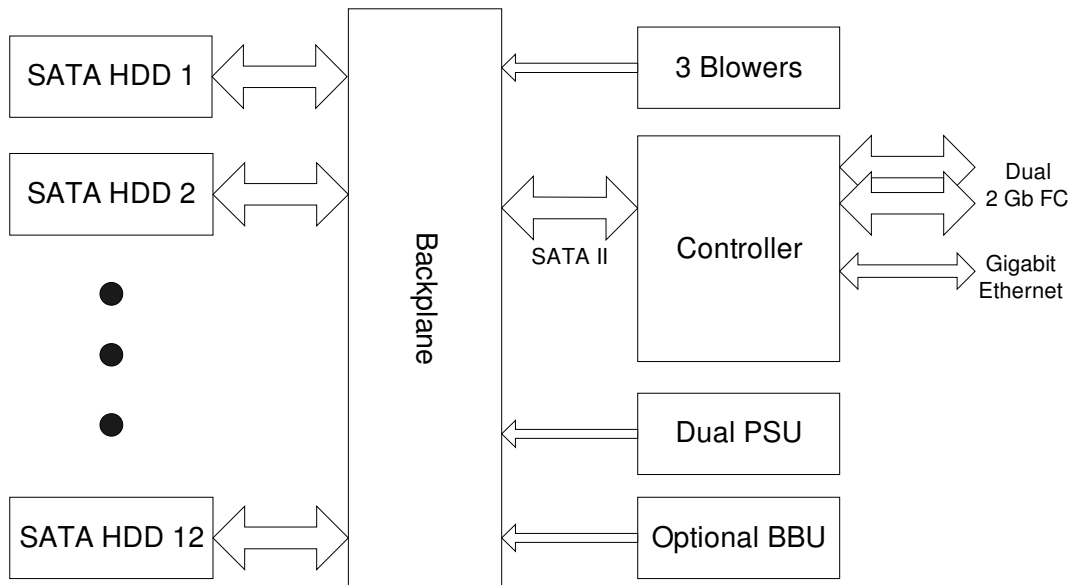

**Figure 2-1: Raidtec FS3102 Block Diagram**

## 3 General Precautions and Electrical Considerations

**Read** all these instructions before setting up and using your system!

**Follow** all warnings and instructions noted on the computer and in the operating instructions.

**Save** these instructions for future reference.

**Use** of a non-interruptible power supply is strongly recommended.

**Do not** set up or use this device near water. Electrical shock and damage may occur if water shorts out high voltage parts.

**Do not** block the enclosure vents or place this device in a built-in installation unless proper ventilation is provided. Blocking enclosure vent could cause installed components to overheat and operate unreliably.

**Avoid** setting the device on a bed, sofa, carpet, pillow or other soft surfaces that can cover the enclosure vents.

**Never** set the device on a radiator, heat register, or other heat source.

**Never** insert foreign objects into the enclosure slots. Fire, electrical shock, and/or damage may occur if such objects short out high voltage parts.

**Operate** the device using the correct type of AC power source, as specified on the label (typically, 115V/60Hz in the US and Canada; 230V/50Hz in the UK and Europe).

**Plug** the power cord into a properly grounded electrical outlet to prevent electrical shock.

**Do not** use adapter plugs or remove the grounding prong.

**Replace** any obsolete outlet. If you use an extension cord with the system, use a 3-wire extension cord and make sure that the extension cord's ampere rating is sufficient to handle the load of all the equipment plugged into it.

**Use** an approved surge suppresser to protect the equipment from erratic electricity supply.

**Install** new or replace failed disk drives with drives that are listed on the Plasmon approved drive list **ONLY**.

**Check** that the total load of all devices attached to one cord or one outlet **never exceeds** 15 amperes. The wattage rating for most devices is listed on the label for the product.

**Do not** set any object on the power cord. Situate the power cord away from traffic areas so it will not be stepped on or tripped over.

**Prevent** static electricity from permanently damaging your electronic components. Observe the proper Electro Static Discharge (ESD) measures when handling components such as drives.

**Do not** attempt to service this device yourself except as explained in the manual.

**The maximum** operating ambient temperature is 40° Celsius.

**The rear** of the unit should have at least 300mm clearance from any other objects for ventilation.

**The power supply cord** provides the safety earth connection. The power supply cord should be connected to an outlet that is grounded in accordance with the National Electric Code (NEC).

**Contact service personnel for assistance if:**

- A power cable or plug is frayed or damaged.



- The device is exposed to rain or water, or liquid has been spilled into it.
- The device is dropped or the enclosure is damaged.
- The device does not operate normally when the operating instructions are followed.

**CAUTION**

**RISK OF EXPLOSION IF THE NVRAM BATTERY IS REPLACED BY AN INCORRECT TYPE.**

**DISPOSE OF USED BATTERIES ACCORDING TO THE INSTRUCTIONS**

### **3.1 Cleaning Instructions**

Turn off the equipment and unplug it from the electrical outlet before cleaning.

Use a damp cloth for cleaning. Never apply liquid or aerosol cleaners directly to computing devices.

If the device gets wet, unplug all system power cables and contact Plasmon Data Ltd. Technical Support for assistance.

## 4 Safety and Emissions

### 4.1 Safety

The Raidtec FS3102 is certified to the following standards.

UL60950-1, CSA 22.2 No 60950-1-03, EN 60950, IEC 60950-1:2001

### 4.2 FC Lasers.

**Warning:**

Lasers can cause permanent eye damage, which may result in permanent blindness, and therefore must be treated with respect and used with caution. This product uses lasers, which are classified as Class 1, which have a very low output power and are considered to be non-hazardous.

The Laser used in this product is Class 1 compliant and conforms to IEC 60825-1.

### 4.3 Emissions

The Raidtec FS3102 is certified to the following standards.

EN 55022 Class A, FCC Class A CFR47 Part 15

### 4.4 Immunity

The Raidtec FS3102 is certified to the following standards.

EN 55024, EN 6100-3-2, EN 6100-3-3

### 4.5 Safe Handling

The product is conditioned for safe handling in regards to sharp edges and corners. Anti-static precautions should be observed when handling the RAID controller or the disk drives.

# 5 Familiarising yourself with the system

The following section outlines the different parts of the FS3102 system.

## 5.1 Unpacking

Be careful when unpacking the system from its packaging and get assistance when lifting the chassis out of the main box. Check all the items against the delivery dockets to ensure that all of the parts are present.



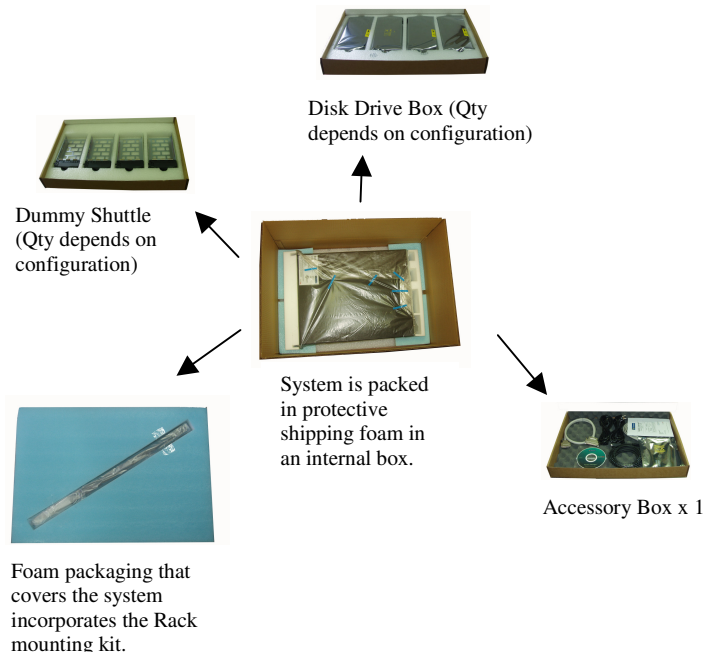





It is shipped in a packing carton, as depicted in Figure 5-1.



**Figure 5-1**

## 5.2 What's in the box

Table 5-1 outlines the standard kit supplied with a Raidtec FS3102.

	
<b>FS3102 Enclosure x 1</b>	
	
<b>Drive Shuttle (Up to 12 depending on capacity)</b>	<b>Dummy Drive Shuttle (used to fill empty drive bays)</b>
	
<b>Fibre Optic Cable (5m) x 2</b>	<b>PSU Cable x 2 (Country Specific)</b>
	
<b>Ethernet Cable x 1</b>	<b>Raidtec Manager CD</b>
	
<b>Rack Mounting Brackets (x 2) &amp; Screws (Optional) (Refer to Rack Mount Procedure for installation)</b>	<b>SFP (Optical Transceivers) x 2 (Pre-installed in Controller)</b>

**Table 5-1**

## 5.3 System Views

The FS3102 system is a 2U 12 bay enclosure with two redundant PSU modules, three redundant fan modules and a backplane.

### 5.3.1 System Front View



Figure 5-2

### 5.3.2 System LED Indicators

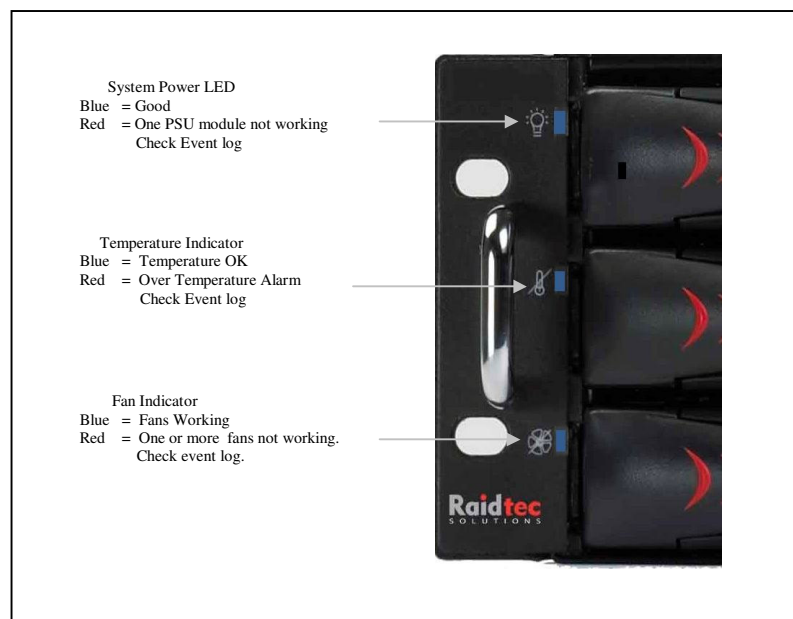

Figure 5-3 – System Indicator LEDs

#### 5.3.2.1 Disk Drive Numbering

The disk drives are numbered in the following sequence (as you are looking at the front of the system);

Bay 1	Bay 2	Bay 3	Bay 4
Bay 5	Bay 6	Bay 7	Bay 8
Bay 9	Bay 10	Bay 11	Bay 12

### 5.3.3 System Back View

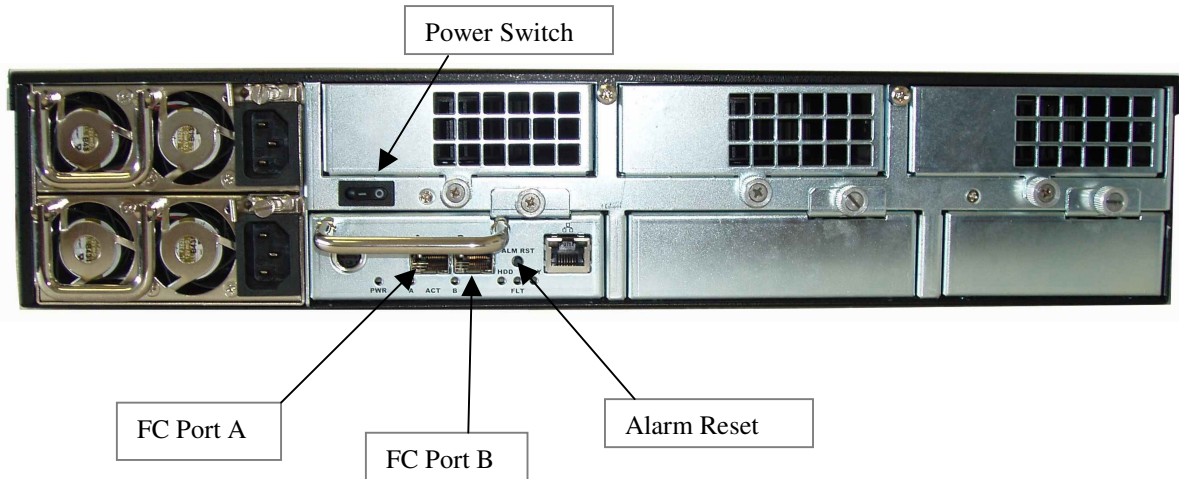

Figure 5-4 – System Back View

#### 5.3.3.1 PSU Module and Fan Module Numbering

PSU 1	Fan 1	Fan 2	Fan 3
PSU 2			

### 5.3.4 Controller Indicators

Figure 5-5 describes what each activity light indicates. Refer to Table 5-2 for a detailed explanation of each indicator.

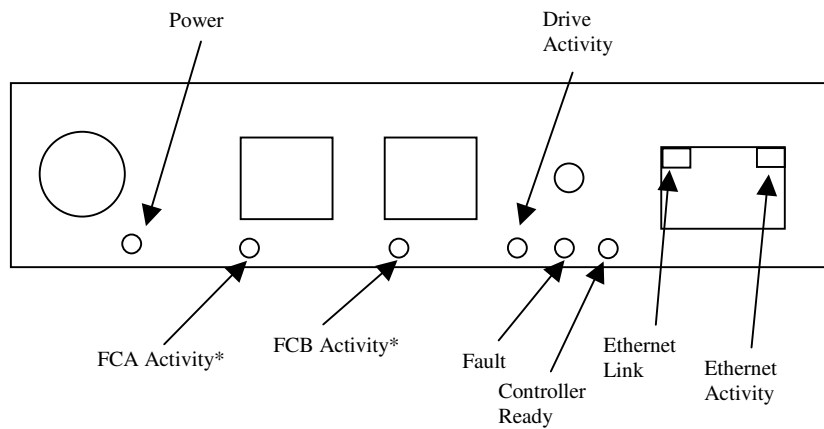

\*Note: Even though a cable may be connected, the indicator activity LED's will only illuminate when there is activity on that channel.

Figure 5-5 – Controller Activity Indicators

<b>INDICATOR</b>	<b>COLOUR</b>	<b>DESCRIPTION</b>
Power	Green	Solid when power is available to the controller
FC A Activity	Green/Red	Flashes green when there is activity on FC Port A Solid red when FC Port A is down or unconnected
FC B Activity	Green/Red	Flashes when there is activity on FC Port B Solid red when FC Port B is down or unconnected
Drive Activity	Green	Flashes when there is activity on any drive
Fault	Red	Solid if a fault is detected that activates the alarm
Controller Ready	Green	Solid when the controller is ready
Ethernet Link	Green (1000BaseT) Orange (100BaseT)	Solid when connected to a functioning 1000BaseT or 100BaseT network. Off when not connected or connected to a 10Base T network.
Ethernet Activity	Green	Flashes when there is activity on the network

**Table 5-2**

## 6 Installing the FS3102 system

### 6.1 Installing Disk Drives

Note: Disk drives do not have to be installed in any particular sequence when setting up the FS3102.

Slide the lock release button to the right to release the drive tray handle, (see Figure 6-1). Using the drive tray handle, insert the drive tray into the system with the disk facing up (see Figure 6-2). Push the drive tray all the way in to the system and close the drive tray handle to engage the connector.

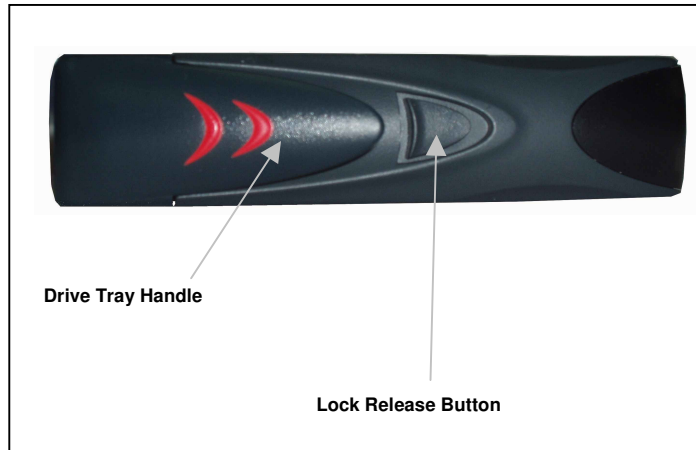

Figure 6-1

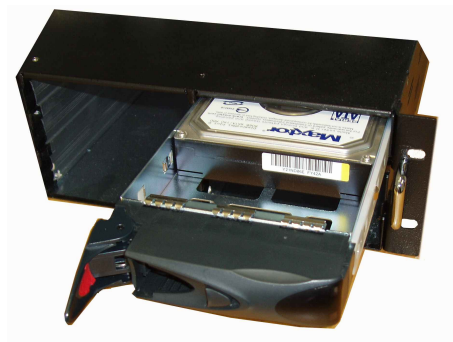

Figure 6-2 Drive Inserted half way in to System

Note: The drive handle mechanism is the same for both drive and dummy shuttles.

### 6.2 Installing SFPs (Optical transceivers)

The SFPs (Figure 6-3) are fitted to the Fibre Channel controller ports at the factory prior to shipping.



Figure 6-3 – SFP



In the event that the SFPs need to be changed, carry out the following procedure's while referring to Figure 6-4

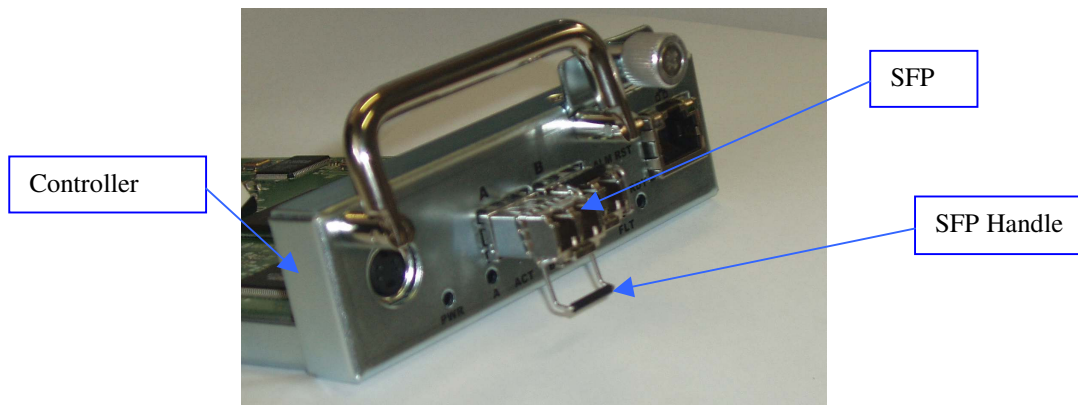

Figure 6-4

### 6.2.1 SFP Removal

1. Remove the SFP from the controller by lowering the SFP handle to the down position.
2. Gripping the handle, slide the SFP out from the controller fully.

### 6.2.2 SFP Replacement

1. With the SFP handle in the lowered position, align the SFP to the controller port and insert fully until you feel the connector engaging.
2. Turn the handle up until it clicks to the home position (ref: Figure 6-5)

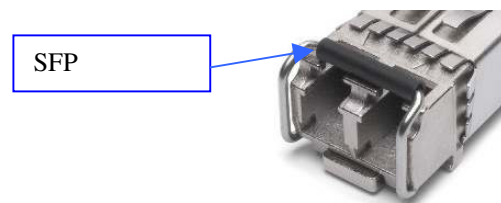

Figure 6-5

## 6.3 Installing a Host Bus Adaptor (HBA)

Install the prescribed host bus adaptor in the host computer using the documented procedure supplied by the host computer manufacturer.

## 6.4 Cabling the Host and the FS3102

The FS3102 has three typical configurations as follows;

Note: For descriptive reasons the Raidtec Manager is shown installed on the Host system. The Raidtec Manager software will most likely be installed on the system administrators PC.

### 6.4.1 Single Port/Host DAS Configuration

Note: The Ethernet cable is used by the management software, Raidtec Manager, to communicate with the FS3102.

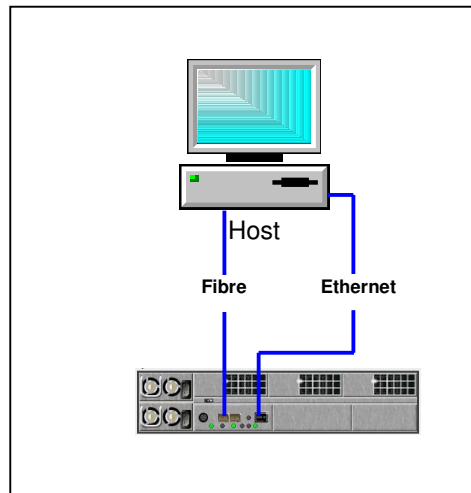

### 6.4.2 Dual Port, Single Host SAN configuration.

Note: The Ethernet cable is used by the management software, Raidtec Manager, to communicate with the FS3102.

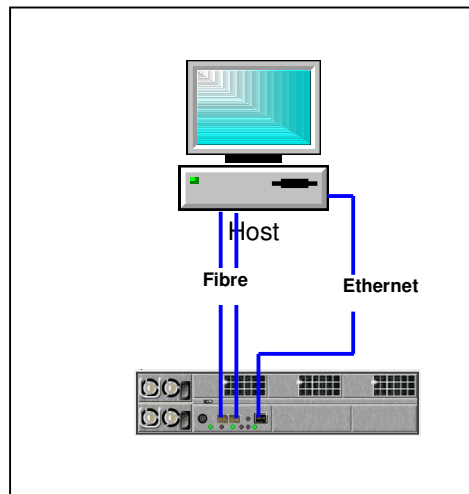

### 6.4.3 Dual Port, Multi Host DAS Configuration.

Note: The Ethernet cable is used by the management software, Raidtec Manager, to communicate with the FS3102. In this configuration, the computer running Raidtec Manager does not have to be part of the SAN.

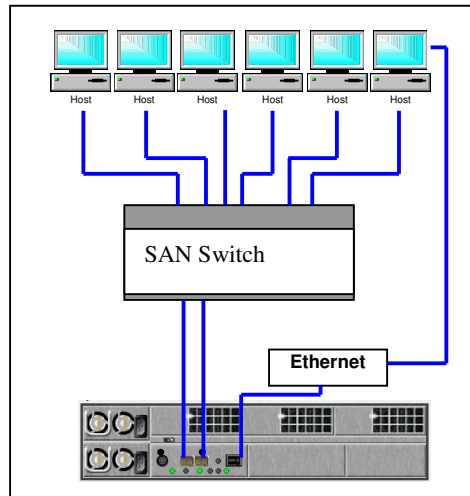

Note: For optimum performance, ensure that the HBA and SFPs used are 2Gb.

## 7 Configuring the FS3102

Raidtec Manager needs to be installed on an administrators PC.

Refer to the FS3102 Raid Manager User Guide for configuring the RAID storage using Raidtec Manager .

## 8 Battery Backup Unit (BBU)

The Battery Backup Unit (BBU) is an optional subsystem that provides security against data loss during power failures. Power is provided to cache memory only so that when the system restarts, write cached data may be written to the disk. The system detects when the power is failing and puts the cache memory into self-refresh mode. When the system restarts, the cache memory is scanned for valid cache data. The write cache is rebuilt and retained until the disks are ready to accept data.

### 8.1 Data Hold Time

The exact time the BBU will maintain the data in the cache memory is dependent on the specific cache memory installed, the condition of the battery, the amount of charge in the battery and the temperature of the BBU. The BBU is designed to supply current to the cache memory for a minimum of 72 hours at 25°C ambient when fully charged.

### 8.2 Maximum Memory Current

The BBU is designed with 4200mAh capacity batteries. The batteries are organized in 2 packs of 6 batteries, 1 pack per controller. Each pack includes a smart battery function, using a gas gauge device to control the battery critical information.

The maximum current that can be supplied for self refresh operations and still meet the 72 hour specification at end of battery life is 133mA per controller.

### 8.3 Battery Pack Replacement Policy

The battery pack replacement policy is based on the available remaining capacity. The firmware will check the available capacity and send an alert to notify the administrator to change the battery pack if remaining capacity falls below 80% of the design capacity.

Under normal operation, a battery pack should last 2 to 3 years before it needs to be replaced.

### 8.4 BBU Indicators

# INSERT BBU PICTURE

The back of the BBU has 2 sets of LEDs, one set for each battery pack.

INDICATOR	COLOUR	DESCRIPTION
Charge/Full	Green/Yellow	Solid green when the battery pack is fully charged Solid yellow when the battery pack is charging
Replace	Red	Solid red when the battery pack needs replacing

## 9 Field Replaceable Units (FRUs)

The following table of components shows the field customer replaceable units (FRUs) in the system.

FRU NAME	DESCRIPTION	NUMBER IN SYSTEM	ONLINE REPLACEABLE	CUSTOMER REPLACEABLE
Controller	RAID controller	1	No	Yes
SFP	Fibre Channel Transceiver	2	Yes	Yes
PSU	Power supply module	2	Yes	Yes
Disk	Disk Drive	12 (maximum)	Yes	Yes
Fan	Cooling fan	3	Yes	Yes
BBU (optional)	Battery Backup Unit	1	Yes	Yes
Battery Pack (optional)	BBU Battery Pack	1	Yes	Yes

Please refer to Technical Support for advice on replacing any parts other than the disks on a FS3102.

# 10 Plasmon Technical Support.

If you have any questions, problems, or suggestions, you can reach Plasmon Technical Support in any of the following ways:

Plasmon Tech Support

Plasmon (Europe)	
By E-mail.	support@plasmon.co.uk
By telephone.	+44 (0)1763 262963
By FAX.	+44 (0)1763 264407

# Appendix A - Alerts

## Failure Events

The following table summarizes the operation of the system in the presence of various failures.

Email refers to an email notification sent by the controller over the Ethernet interface to an assigned email address, SNMP refers to an SNMP trap sent by the controller over the Ethernet interface to a designated SNMP recipient and Event log refers to an event logged in the Alert Log in the Raidtec Manager Management Software.

FAILURE CLASS	FAILURE TYPE	EFFECT ON DATA	EFFECT ON AVAILABILITY	EFFECT ON PERFORMANCE	USER NOTIFICATION
Power (BBU Not present)	Total Loss	Data may be lost if write cache is enabled	System unavailable	N/A	Event log
Power (BBU Not present)	Transient Loss	Data may be lost if write cache is enabled	System unavailable during power loss. Controller takes 7 seconds to reboot and 60 seconds for the system to become available.	N/A	Event log
Power (BBU Present)	Total Loss	No effect provided outage is shorter than BBU hold time	System unavailable	N/A	Event log
Power (BBU Present)	Transient Loss	No effect	System unavailable during power loss. Controller takes 7 seconds to reboot and 60 seconds for the system to become available.	N/A	Event log
Disk (RAID Level 1, 5 or 10)	Drive removed or drive failure	No effect. RAID volume degraded.	Loss of high availability. System will become unavailable on second failure.	Performance may drop	Event log, Email and SNMP
Disk (RAID Level 0)	Drive removed or drive failure	RAID is inaccessible	RAID unavailable	N/A	Event log, Email and SNMP
Disk (RAID Level 1, 5 or 10)	Advanced drive failure notice	No effect	No effect	Performance will drop if spare is available to rebuild the failing drive to	Event log, Email and SNMP
Disk (RAID Level 0)	Advanced drive failure notice	No effect	No effect	None	Event log, Email and SNMP
Disk (RAID Level 1, 5 or 10)	Medium Error	No effect	Stripe will be rebuilt on alternate sectors.	Performance may drop	Disk statistics updated in controller If threshold met, Event log, Email and SNMP



<b>FAILURE CLASS</b>	<b>FAILURE TYPE</b>	<b>EFFECT ON DATA</b>	<b>EFFECT ON AVAILABILITY</b>	<b>EFFECT ON PERFORMANCE</b>	<b>USER NOTIFICATION</b>
Disk (RAID Level 0)	Medium Error	Data loss	None except for the data loss	None	Disk statistics updated in controller If threshold met, Event log, Email and SNMP
Link	FC link total failure	No effect	System unavailable unless alternate SCSI path is used in cluster configuration.	N/A	Event log, Email and SNMP
Link	FC link transient parity errors	No effect	System remains available	Performance will drop as command timeouts, bus resets and retries occur	Event log, Email and SNMP
Backplane (RAID Level 1, 5 or 10)	SATA link failure	No effect RAID volume degraded	Loss of high availability, system may become unavailable on second failure	Performance may drop.	Event log, Email and SNMP
Backplane (RAID Level 0)	SATA link failure	RAID is inaccessible	RAID unavailable	N/A	Event log, Email and SNMP
Backplane (RAID Level 1, 5 or 10)	SATA link degraded	No effect	No effect	Performance may drop.	Disk statistics updated in controller If threshold met, Event log, Email and SNMP
Backplane (RAID Level 0)	SATA link degraded	No effect	No effect	Performance may drop.	Disk statistics updated in controller If threshold met, Event log, Email and SNMP
Enclosure	Fan Failure	No effect	System availability at risk until fan replaced	No effect	Event log, Email and SNMP
Enclosure	PSU module failure	No effect	System availability at risk until PSU module replaced	No effect	Event log, Email and SNMP
BBU	BBU failure	No effect	User data at risk from transient power failure if write caching is enabled.	No effect	Event log, Email and SNMP
Controller	Hardware failure	User data loss is possible	System unavailable	N/A	Event log
Controller	Software failure, controller reboot	No effect User data is maintained in cache during controller reboot	System unavailable during controller reboot. Controller takes 7 seconds to reboot and 60 seconds for the system to become available.	Performance may drop if command timeouts occur.	Event log, Email and SNMP

## Alert Messages

The following Notifications and Warnings are sent by the controller.

### Notifications

Normal operation of power supply in slot <number> restored  
Normal operation of fan in slot <number> restored  
The temperature in the system is now within the acceptable range  
Creating RAID '<name>', useable capacity: <capacity> GB  
RAID '<name>' is now accessible  
Initialising RAID '<name>'  
Initialisation of RAID '<name>' deferred for a higher priority RAID  
RAID '<name>' initialisation complete  
Deleting RAID '<name>'  
Expanding RAID '<name>' by adding rows  
Expanding RAID '<name>' by adding <number of columns> column(s)  
Initialising expansion space on RAID '<name>'  
RAID '<name>' expand complete  
Rebuilding RAID '<name>'  
Rebuild of RAID '<name>' deferred for a higher priority RAID  
RAID '<name>' rebuild complete  
Disk in bay <number> is no longer part of RAID '<name>'  
Verifying RAID '<name>'  
Verification of RAID '<name>' deferred for a higher priority RAID  
RAID '<name>' verification complete  
Logical volume '<name>' created  
Logical volume '<name>' deleted  
Logical volume '<name>' capacity expanded to <capacity>  
Logical volume '<name>' ID:LUN changed to <SCSI ID>:<LUN>  
Logical volume '<name>' changed to '<new name>'  
Starting Firmware <version> (<build time and date>) reboot <reboot count>  
Network up at IP address <IP address>, netmask <netmask>  
Password has changed  
Fibre Channel Port <port> is up at <speed> Gb in <fibre channel mode> mode

### Warnings

Disk in bay <number> is missing  
Disk in bay <number> has excessive errors  
Disk in bay <number> is running out of reallocation blocks  
Disk in bay <number> has run out of reallocation blocks  
Disk in bay <number> has failed  
Power Supply Module in slot <number> is not working properly  
Fan in slot <number> is not working properly  
The temperature in the system has exceeded <threshold value> threshold  
The temperature in the system has dropped below 10C/50F  
RAID '<name>' initialisation failed to complete  
RAID '<name>' verify failed to complete  
RAID '<name>' expand failed to complete  
RAID '<name>' rebuild failed to complete  
RAID '<name>' is degraded due to disk failures  
RAID '<name>' is inaccessible due to disk failures  
RAID '<name>' has no suitable spare available  
Cannot start scheduled verify on RAID '<name>'  
Controller hardware error  
Firmware download checksum failed, the binary may be corrupted  
Firmware ID does not match, the binary is not for this product

An attempt to write flash memory failed  
The serial number on this system is incorrect  
NVRAM checksum invalid, restoring default settings  
NVRAM battery is exhausted and needs replacement  
Fibre Channel Port <port> link error  
Fibre Channel Port <port> is down

# Appendix B - RAID Features

## RAID Levels

The controller supports RAID levels 0, 1, 5 and 10.

NOTE: RAID level 1 and RAID level 10 are functionally equivalent. RAID level 1 is used when the RAID is built with 2 drives, RAID level 10 when more than 2 drives are used.

## Logical Volumes

The controller supports up to 1024 independent logical volumes. Each logical volume will be identified by a LUN. The controller only supports a single node name.

## RAID Creation

RAIDs and logical volumes are created and managed using the Raidtec Manager management software. When a RAID level 5 is created, the parity in the volume must be initialized. The RAID controller will read every stripe, calculate parity and write the parity. This can take several hours depending on the capacity of the disks. The RAID is made available from when it is created, but full performance is not achieved until the RAID is fully initialized.

NOTE: 2 GB of each disk is reserved for reallocated blocks by the controller. Therefore the capacity formed will be slightly less than the nominal capacity available from the drives.

NOTE: Usable drive capacities are fixed to allow drives to be used from different manufacturers. The result is that some capacity may be lost due to the difference in actual capacities between different manufacturers even though the nominal capacity is the same.

NOTE: If the disks that are being used to form the RAID have different capacities, the RAID will be created using the smallest disk capacity of the different disks. Additional capacity on larger disks will be lost.

## RAID Expansion

The Raidtec FS3102 system supports online expansion of the RAID. This expansion is accomplished in two possible ways, by row or by column. The controller decides what the best way of expanding the RAID is. The user does not have the ability to choose the expansion method.

### Expansion By Row

The RAID will be expanded by row if possible. To expand by row, the number of disks that are being added to the RAID must be the same number that are in the RAID that is being expanded. The RAID will be expanded by adding an additional row of disks to the RAID. The number of columns in the RAID will remain the same. If the original RAID was level 5, the controller will have to initialize parity for the new row.

NOTE: If the disks that are being used to form the additional row have different capacities, the row will be expanded using the smallest disk capacity of the disks being added. Additional capacity on larger disks will be lost. The capacity of the disks in the new row can be different from the first row of disks.

### Expansion By Column

If there are insufficient disks to form an entire new row, the RAID will be expanded by adding columns to the stripe. This involves adding extra disks to each row (this will be a single row unless the RAID has already been expanded by adding an additional row). When this is done, a re-striping operation is necessary. The system reads each stripe in turn and writes it to an expanded stripe. This is a time consuming operation.

NOTE: Expansion by column will expand the RAID using the same disk capacity that was used in the existing columns. If the disks that are being used to expand the RAID have smaller capacities than the columns already in the RAID, the expansion will not be allowed. If the disks that are being used to expand the RAID have larger capacities than the columns already in the RAID, the additional capacity on the larger disks will be lost.

## **RAID Verify**

A RAID level 5 may be checked for valid parity by initiating a verify operation. The system reads each stripe and checks for valid parity. At the end of the verify process the system sends an Alert if any stripes were found with invalid parity.

## **Stripe Size**

Each RAID can consist of up to a maximum of 12 disks.

## **Stripe Unit Size**

The stripe unit size is set by the profile. See the Raidtec Manager specification for more details.

## **Caching**

The Raidtec FS3102 comes with 256 MB of cache memory as standard. The system supports up to 1 GB as an option. The cache memory is used for both read and write data. There are three kinds of caching implemented by the system firmware.

### **Read Cached Data**

The system records the number of read and write commands that occur in the same physical stripe. When the number of commands exceeds a preset threshold, the system will allocate storage space to cache this data. This increases performance because subsequent read operations can be serviced from memory instead of reading from the disk.

### **Streaming Read Data**

The system records the starting block and block size of each SCSI command received. When the start block of a new command matches the last block of a previous command the system detects that there is a stream of commands in progress and prefetches data up to 16 times the size of the original command. This increases performance by lowering the latency of subsequent commands in the stream.

### **Write Cached Data**

When write caching is enabled, good status is returned immediately, before the data is written to disk. This increases performance in two ways. Firstly it lowers command latency to the host. Secondly, by coalescing contiguous write data into larger segments before it is written to disk, seeks are reduced and bandwidths increased.

NOTE: If write caching is enabled, data may be lost if power is removed prior to the data being written to the disks. If write caching is enabled, a UPS or/and a BBU should be used in the system.

## **Auto Rebuild**

The Raidtec FS3102 has 3 rebuild options if a RAID becomes degraded. These are disabled, priority and background. These options can be set from Raidtec Manager. Background is the default setting. The RAID can still be accessed during a rebuild, but performance will be reduced.

If a verify is scheduled when a rebuild is in progress, the verify will not take place.

### **Disabled**

If Auto Rebuild is set to Disabled, the RAID will not rebuild unless the administrator manually selects Rebuild in Raidtec Manager. If a RAID becomes degraded, an alert will still be generated even if Auto Rebuild is set to disabled.

### **Priority**

If Auto Rebuild is set to Priority, the RAID will rebuild as quickly as possible while still allowing reading and writing to occur. Read and write performance may be substantially reduced from normal operation.

### **Background**

If Auto Rebuild is set to Background, the RAID will rebuild, but priority will be given to normal read and write operations. If there is a high level of read and write activity, the rebuild may take a long time.

# Appendix C - System Specifications

## Electrical Characteristics

### Voltage Rating

90 VAC to 264 VAC  
Single phase, 47 Hz to 63 Hz  
Power supplies are autoranging

### Current Consumption

115 VAC – 8 A maximum  
230 VAC – 5 A maximum

### Power Consumption

350 W maximum (fully populated enclosure)

## Environmental Conditions

### Temperature

- 10°C to 40°C (50°F to 104°F) – operating
- -30°C to 60°C (-22°F to 140°F) – non-operating

### Relative Humidity

- Non-condensing, 10% to 90% - operating and non-operating

### Altitude

- 0 to 3050 m (10,000 ft) – operating
- 0 to 12200m (40,000 ft) – non-operating

### Shock

- 5g, 11 msec half sine - operating
- 20 g, 11 msec half sine - non-operating

### Vibration

- 0.2 g, 5-500-5 Hz swept sine - operating
- 1 g, 5-500-5 Hz swept sine - non-operating

## **Air Flow**

Front to back

Cooling must be provided to ensure internal temperature is maintained below 55°C. The unit should be kept in a dust-filtered environment to ensure long life for the cooling fans.

## **Mechanical Specifications**

### **Weight**

All 12 disks installed (without packaging): 25 kg (55 lbs) maximum

### **Dimensions**

The Raidtec FS3102 is a 2U high, standard rackmount width product.

Height: 88 mm (3.5 in)

Width: 443 mm (17.5 in) – not including mounting brackets

Depth: 551 mm (21.7 in) – enclosure only, does not include anything that protrudes out from the front or back of the enclosure.



# Appendix D - Supported Disk Drives

## Supported Drive List

The controller is pre-configured with a list of supported disk drive types. Only supported disk drive types can be used in the system.

The following capacities, manufacturers and models are currently supported. Other disk drives may be supported in the future.

<b>CAPACITY</b>	<b>MANUFACTURER</b>	<b>MODEL</b>
250 GB	Seagate	ST3250832AS
250 GB	Maxtor	7Y250M0
250 GB	Maxtor	7L250S0
250 GB	Hitachi	HDS722525KLSA80
400 GB	Seagate	ST3400832AS
400 GB	Hitachi	HDS724040KLSA80
500 GB	Hitachi	HDS725050KLA360

If a disk drive that is not supported is put in the system, the disk cannot be used as part of a RAID or for assigning as a local or global spare.

# Appendix E - Ethernet Interface References

## Supported Interfaces

The Ethernet interface supports 10, 100 and 1000 base T full duplex connections. Connection speed is determined automatically.

## Supported Protocols

### HTTP (Web)

HTTP is used by the Raidtec Manager Management Software to remotely monitor and manage the system. The version of the protocol supported is HTTP 1.0.

Please refer to the FS3102 Installation and User Guide.

### SMTP (Email)

SMTP is used to send email alerts. Alerts are described in Appendix A. SMTP alert notification can be enabled from Raidtec Manager.

### SNMP Traps

SNMP traps can be used to send alerts. A single trap type is used for all events. This trap contains a variable binding which contains the alert as described in Appendix A. SNMP traps can be enabled from Raidtec Manager. See the Raidtec Manager specification for details.

## Default IP Address

If no IP address has been previously assigned and DHCP is not enabled, the Raidtec FS3102 system will use 169.254.XXX.YYY as the default IP address, where XXX.YYY is derived from the serial number of the controller. The IP address may be changed through the serial port or by using Raidtec Manager after connecting to the system by manually selecting the default IP address and setting the NetMask to 255.255.0.0.

To connect to the system using the default IP address, it may be necessary to reconfigure the network adaptor on the computer that has Raidtec Manager installed to access the default IP address and NetMask. After changing the IP address, the Raidtec FS3102 system should be power cycled to reset the IP address. Raidtec Manager should also be closed and restarted to search for the IP address of the system.

## Restoring Default IP Address

To restore the Raidtec FS3102 controller back the default IP address, press and hold the reset button on the controller while powering the system up. This restores the default IP address and netmask, enables DHCP and resets the password back to 'admin'.

---

**A**

Alerts ..... 24  
Auto Rebuild ..... 30

---

**B**

Battery Backup Unit ..... 21

---

**C**

Cabling ..... 18  
Caching ..... 29  
Compliance ..... 6  
Configuring the FS3102 ..... 20  
Controller Indicators ..... 14

---

**D**

Disk Drive .....13, 22  
Dual Port..... 19

---

**E**

Environmental Conditions .... 31  
Expansion .....28, 29

---

**F**

FC Lasers ..... 10  
FCC ..... 6  
FS3102 System Overview ..... 7

---

**G**

General Precautions and  
Electrical Considerations .... 8

---

**H**

Host Bus Adaptor (HBA) ..... 17

---

**I**

Installing ..... 16  
Installing the SFP's ..... 16

---

**L**

Led Indicators ..... 13

---

**M**

Mechanical Specifications .... 32  
Modifications ..... 5

---

**N**

Notifications ..... 26

---

**P**

PSU Module ..... 14

---

**R**

RAID ..7, 10, 22, 24, 25, 26, 28,  
29, 30, 33  
RAIDserver-TFX ..... 1  
Raidtec Manager™ ..... 20

---

**S**

Safety and Emissions ..... 10  
Single Port/Host DAS ..... 18  
Specifications ..... 31  
Stripe Size ..... 29  
Supported Drive List ..... 33

---

**T**

Technical Support ..... 23  
Trademarks ..... 5

---

**U**

Unpacking ..... 11

---

**V**

Views ..... 13

---

**W**

Warnings ..... 26

## Free Manuals Download Website

<http://myh66.com>

<http://usermanuals.us>

<http://www.somanuals.com>

<http://www.4manuals.cc>

<http://www.manual-lib.com>

<http://www.404manual.com>

<http://www.luxmanual.com>

<http://aubethermostatmanual.com>

Golf course search by state

<http://golfingnear.com>

Email search by domain

<http://emailbydomain.com>

Auto manuals search

<http://auto.somanuals.com>

TV manuals search

<http://tv.somanuals.com>